

R&S® SMB100B

RF Signal Generator

User Manual



1178371102
Version 06

ROHDE & SCHWARZ
Make ideas real



This document describes the R&S®SMB100B, stock no. 1422.1000.02 and its options:

- R&S®SMBB-B1/-B1H
- R&S®SMBB-B3
- R&S®SMBB-B5
- R&S®SMBB-B32
- R&S®SMBB-B86
- R&S®SMBB-B101/-B103/-B106
- R&S®SMBB-K22/-K23/-K24/-K27
- R&S®SMBB-K31
- R&S®SMBB-K704
- R&S®SMBB-K720

This manual describes firmware version FW 4.70.006.xx and later of the R&S®SMB100B.

© 2020 Rohde & Schwarz GmbH & Co. KG

Mühlhofstr. 15, 81671 München, Germany

Phone: +49 89 41 29 - 0

Email: info@rohde-schwarz.com

Internet: www.rohde-schwarz.com

Subject to change – data without tolerance limits is not binding.

R&S® is a registered trademark of Rohde & Schwarz GmbH & Co. KG.

Trade names are trademarks of the owners.

1178.3711.02 | Version 06 | R&S®SMB100B

Throughout this manual, products from Rohde & Schwarz are indicated without the ® symbol, e.g. R&S®SMB100B is indicated as R&S SMB100B, R&S®VISA as R&S VISA. Linux® is abbreviated as Linux.

Contents

1	Preface	15
1.1	Key Features	15
1.2	About this Manual	15
1.3	Documentation Overview	16
1.3.1	Getting Started Manual.....	17
1.3.2	User Manuals and Help.....	17
1.3.3	Service Manual.....	17
1.3.4	Instrument Security Procedures.....	17
1.3.5	Basic Safety Instructions.....	17
1.3.6	Data Sheets and Brochures.....	17
1.3.7	Release Notes and Open Source Acknowledgment (OSA).....	18
1.3.8	Application Notes, Application Cards, White Papers, etc.....	18
2	Safety and Regulatory Information	19
2.1	Safety Instructions	19
2.2	Labels on R&S SMB100B	21
2.3	Korea Certification Class B	22
3	Getting Started	23
3.1	Preparing for Use	23
3.1.1	Lifting and Carrying.....	23
3.1.2	Unpacking and Checking.....	23
3.1.3	Choosing the Operating Site.....	23
3.1.4	Setting Up the R&S SMB100B.....	24
3.1.4.1	Placing the R&S SMB100B on a Bench Top.....	24
3.1.4.2	Mounting the R&S SMB100B in a Rack.....	25
3.1.5	Important Aspects for Test Setup.....	26
3.1.6	Connecting to Power.....	26
3.1.7	Connecting to LAN.....	27
3.1.8	Connecting USB Devices.....	27
3.1.9	Connecting to RF.....	28
3.1.10	Connecting to Ref In/Ref Out.....	28
3.1.11	Switching On or Off.....	30

3.2 Instrument Tour.....	31
3.2.1 Front Panel Tour.....	31
3.2.1.1 Touchscreen.....	32
3.2.1.2 Utility Keys.....	32
3.2.1.3 On/Standby.....	33
3.2.1.4 Function Keys.....	33
3.2.1.5 Keypad.....	33
3.2.1.6 Navigation Controls.....	34
3.2.1.7 Display Keys.....	35
3.2.1.8 USB Connector.....	35
3.2.1.9 RF 50 Ω.....	35
3.2.2 Rear Panel Tour.....	35
3.2.2.1 Connectors.....	36
3.3 Trying Out the Instrument.....	38
3.3.1 Generating an Unmodulated Carrier.....	38
3.3.2 Generating an RF Frequency Sweep Signal.....	41
3.3.3 Saving and Recalling Settings.....	43
3.4 Instrument Control.....	45
3.4.1 Possible Ways to Operate the Instrument.....	46
3.4.2 Means of Manual Interaction.....	46
3.4.3 Understanding the Display Information.....	47
3.4.3.1 Status Bar.....	48
3.4.3.2 Tile Diagram.....	48
3.4.3.3 Taskbar.....	48
3.4.3.4 Additional Display Characteristics.....	49
3.4.4 Accessing the Functionality.....	50
3.4.5 Entering Data.....	51
3.4.5.1 Entering Numeric Parameters.....	52
3.4.5.2 Entering Alphanumeric Parameters.....	52
3.4.5.3 Undo and Redo Actions.....	52
3.4.6 Getting Information and Help.....	52
3.4.7 Remote Control.....	54
3.4.8 Remote Operation over VNC.....	55

4	RF Signal Configuration.....	56
4.1	Activating RF Signal Output.....	57
4.2	How to Set the Frequency and Level.....	57
4.3	RF Frequency Settings.....	59
4.4	RF Level Settings.....	61
4.5	RF Phase Settings.....	65
5	Analog Modulations.....	67
5.1	Required Options.....	67
5.2	Modulation Types and Signal Sources.....	67
5.3	Activating Analog Modulations.....	69
5.4	Modulation Settings.....	69
5.4.1	Pulse Modulation.....	70
5.4.2	FM, PhiM and AM Modulation Settings.....	71
5.4.3	Stereo Modulation.....	77
5.4.3.1	General Settings.....	78
5.4.3.2	Pilot Tone.....	80
5.4.3.3	ARI.....	81
5.4.3.4	RDS.....	83
5.4.4	Pulse Generator.....	85
5.4.4.1	Pulse Generator > General Settings.....	86
5.4.4.2	Pulse Generator > Pulse Train Settings.....	88
5.4.4.3	Import/Export List Files.....	91
5.4.5	Pulse Graph.....	94
5.4.6	Pulse External / Trigger Settings.....	95
5.4.7	FM, PhiM and AM Modulation Sources.....	96
5.4.7.1	Source > LF Generator Settings.....	96
5.4.7.2	Source > External Settings.....	100
5.4.7.3	Source > Noise Generator Settings.....	101
5.4.8	LF Signal Output Settings.....	102
5.4.9	Overview.....	104
5.5	How to Generate an Amplitude Modulated Signal.....	106
5.6	How to Generate a Pulse Modulated Signal.....	106
5.7	How to Generate a Pulse Train Modulated Signal.....	107

6	List and Sweep Mode.....	109
6.1	Signal Generation and Triggering in the Sweep and List Modes.....	111
6.2	About Sweep Mode.....	118
6.2.1	Correlating Parameters in Sweep Mode.....	119
6.2.2	Sweep Signal Shapes.....	121
6.3	About List Mode.....	122
6.4	Significant Parameters and Functions.....	123
6.5	Sweep Mode Settings.....	125
6.5.1	General Sweep Settings.....	125
6.5.2	Frequency Range Settings.....	131
6.5.3	Level Range Settings.....	133
6.6	List Mode Settings.....	135
6.6.1	General Settings.....	136
6.6.2	List Mode Data Settings.....	138
6.6.3	Import/Export Settings.....	139
6.7	List Editor.....	142
6.8	How to Generate a Signal in List or Sweep Mode.....	145
7	Improving Level Performance.....	148
7.1	Attenuator.....	148
7.1.1	Attenuator Settings.....	149
7.1.2	Reverse Power Protection.....	150
7.2	Automatic Level Control (ALC).....	150
7.2.1	ALC Settings.....	152
7.3	User Correction.....	153
7.3.1	User Correction Settings.....	156
7.3.2	List Editor.....	157
7.3.3	Fill with Sensor.....	161
7.3.4	Import/Export List Files.....	162
7.4	Using Power Sensors.....	165
7.4.1	Connecting R&S NRP Power Sensors to the R&S SMB100B.....	165
7.4.2	NRP Sensor Mapping.....	166
7.4.3	NRP Power Viewer.....	168
7.4.3.1	About.....	168

7.4.3.2	NRP Power Viewer Settings.....	170
7.5	How to Calibrate the Power Level with an R&S NRP Power Sensor.....	176
8	Reference Oscillator.....	180
8.1	Required Options.....	180
8.2	Reference Frequency Settings.....	180
8.3	Reference Output Settings.....	184
8.4	Adjustment Settings.....	185
8.5	Using the Reference Frequency for Instruments Synchronization.....	185
9	File and Data Management.....	189
9.1	About the File System.....	189
9.2	Restoring the (Default) Instrument Configuration.....	192
9.2.1	Preset, Set to Default and Factory Preset Settings.....	194
9.2.2	How to Identify Parameters Which Are Not in a Preset State.....	195
9.2.3	How to Recall User Settings Automatically after Preset.....	195
9.2.4	Reference.....	196
9.3	Protecting Data.....	197
9.4	Saving and Recalling Instrument Settings.....	197
9.4.1	Save/Recall Settings.....	198
9.4.2	How to Save and Recall Instrument Settings.....	201
9.5	Accessing Files with User Data.....	202
9.5.1	File Select Settings.....	202
9.6	Exporting Remote Command Lists.....	204
9.7	Loading, Importing and Exporting Lists.....	205
9.8	Using the File Manager.....	205
9.8.1	File Manager Settings.....	206
9.8.2	Map Network Share Settings.....	207
9.8.3	How to Display All Saved Files.....	209
9.8.4	How to Map a Network Folder.....	209
9.9	How to Transfer Files from and to the Instrument.....	212
9.9.1	Removing File System Protection.....	212
9.9.2	Accessing the File System of the R&S SMB100B via ftp.....	214
9.9.3	Accessing the R&S SMB100B File System via SMB (Samba).....	215
9.9.4	Using a USB Storage Device for File Transfer.....	217

9.9.5	Using a File Server for Test Files Exchange.....	217
9.10	Creating Screenshots of Current Settings.....	218
9.10.1	Hardcopy Settings.....	218
9.10.2	How to Save a Hardcopy of the Display.....	222
10	General Instrument Functions.....	224
10.1	Customizing the User Interface.....	224
10.1.1	Display and Keyboard Settings.....	225
10.1.2	Display Update Settings.....	226
10.1.3	Defining the RF Signal State On Power On	227
10.1.4	How to Set the Initial Instrument Settings.....	228
10.1.4.1	Setting the Keyboard Language.....	228
10.1.4.2	Setting the Screen Saver.....	228
10.2	Organizing Frequently Used Settings as Favorites.....	229
10.2.1	User Menu Settings.....	230
10.2.2	How To Use the User Menu for Fast Adjustments.....	231
10.2.3	Define User Key Actions Settings.....	233
10.2.4	How to Assign Actions to the [★ (User)] Key.....	235
10.3	Managing Licenses and License Keys.....	236
10.3.1	Manage License Keys Settings.....	236
10.3.2	How to Move a Portable License.....	239
10.4	Using the Security Settings.....	240
10.4.1	Protection Level Settings.....	241
10.4.2	Setting Security Parameters.....	242
10.4.2.1	Update Policy Security Settings.....	243
10.4.2.2	Disk & Memory Security Settings.....	244
10.4.2.3	Manual Operation Security Settings.....	245
10.4.3	Configuring LAN Services.....	248
10.4.4	Password Management.....	250
10.4.5	How to Prevent Unauthorized Access.....	252
10.5	Undoing or Restoring Actions.....	254
10.6	Shutting Down and Rebooting the Instrument.....	256
11	Network Operation and Remote Control.....	257
11.1	Overview of Remote Access Modes.....	257

11.2 Remote Control Interfaces and Protocols.....	259
11.2.1 LAN Interface.....	260
11.2.1.1 VISA Resource Strings.....	260
11.2.1.2 HiSLIP Protocol.....	262
11.2.1.3 VXI-11 Protocol.....	262
11.2.1.4 Socket Communication.....	262
11.2.2 USB Interface.....	263
11.2.2.1 USB Resource String.....	263
11.2.3 GPIB Interface (IEC/IEEE Bus Interface).....	263
11.2.4 LXI Browser Interface.....	264
11.3 Remote Control Programs and Libraries.....	264
11.3.1 VISA Library.....	265
11.3.2 Possible Setups and Access Functions.....	265
11.4 Remote Access Settings.....	267
11.4.1 Network Settings.....	268
11.4.2 VISA Resource Strings.....	271
11.4.3 GPIB Address Settings.....	272
11.4.4 RS232 Settings.....	273
11.4.5 Instrument Emulations Settings.....	274
11.4.6 Remote Connections Settings.....	275
11.4.6.1 Active Connections.....	275
11.4.6.2 Closed Connections.....	276
11.4.7 QR Code.....	277
11.5 LXI Settings.....	278
11.5.1 LXI Status Settings.....	278
11.5.2 LXI Browser Settings.....	280
11.5.2.1 LAN Configuration.....	281
11.6 Connecting the Instrument to the Network (LAN).....	285
11.6.1 How To Enable Access via LAN.....	286
11.6.2 How To Activate LAN Services.....	286
11.6.3 How To Connect to LAN.....	286
11.6.4 How to Assign the IP Address.....	286
11.6.5 How to Use Computer Names (Hostnames).....	287

11.7	Controlling the R&S SMB100B Remotely.....	288
11.7.1	How to Find the VISA Resource String.....	289
11.7.2	How to Change the GPIB Instrument Address.....	289
11.7.3	Establishing a Remote Control Connection over the LXI Browser Interface.....	290
11.7.4	Establishing a Remote Control Connection over LAN Using VXI-11 Protocol.....	290
11.7.5	Establishing a Remote Control Connection over LAN Using Socket Communication	296
11.7.6	Setting Up a Remote Control Connection over GPIB.....	297
11.7.7	Setting Up a Remote Control Connection over USB.....	298
11.7.8	How to Trace Messages with the LXI Web Browser Interface.....	299
11.7.9	How to Return to Manual Operation.....	299
11.8	Automating Tasks with Remote Command Scripts.....	300
11.8.1	Show SCPI Command.....	303
11.8.2	Displaying an SCPI List.....	303
11.8.3	SCPI Recording Export Settings.....	304
11.8.4	How to Record / Create SCPI Lists.....	305
11.8.5	How to Convert and Save SCPI Lists.....	308
11.8.6	How to Find Out the SCPI Commands for GUI Functions.....	309
11.9	Operating the R&S SMB100B Remotely via VNC.....	310
11.9.1	How To Enable the VNC Service.....	310
11.9.2	How To Set Up a Remote Operation from a Desktop System.....	311
11.9.2.1	Using a Web Browser.....	311
11.9.2.2	Using a VNC Client Software.....	311
11.9.3	How To Set Up a Remote Operation from a Smart Device.....	313
11.9.3.1	Using a VNC App.....	314
11.9.3.2	Using a Web Browser with HTML5.....	314
11.9.3.3	Special Mode QR Code	315
11.10	References.....	316
11.10.1	LXI Functionality.....	316
11.10.2	Code Generator Templates.....	316
11.10.3	Remote Control States	318
12	Remote Control Commands.....	320
12.1	Conventions Used in SCPI Command Descriptions.....	320

12.2	Programming Examples.....	321
12.3	Common Commands.....	321
12.4	Preset Commands.....	326
12.5	MMEMory Subsystem.....	327
12.5.1	File Naming Conventions.....	328
12.5.2	Accessing Files in the Default or in a Specified Directory.....	329
12.5.3	Programming Examples.....	330
12.5.4	Remote Control Commands.....	332
12.6	CALibration Subsystem.....	337
12.7	DIAGnostic Subsystem.....	340
12.8	DISPlay Subsystem.....	343
12.9	FORMat Subsystem.....	348
12.10	HCOPy Subsystem.....	349
12.10.1	Hard Copy Settings.....	350
12.10.2	Automatic Naming.....	352
12.11	KBOard Subsystem.....	354
12.12	OUTPut Subsystem.....	355
12.13	SENSE, READ, INITiate and SLISt Subsystems.....	358
12.14	SOURce Subsystem.....	370
12.14.1	Analog Modulation Subsystems.....	371
12.14.1.1	SOURce:MODulation Subsystem.....	371
12.14.1.2	SOURce:AM Subsystem.....	372
12.14.1.3	SOURce:FM Subsystem.....	376
12.14.1.4	SOURce:PM Subsystem.....	381
12.14.1.5	SOURce:PULM Subsystem.....	386
12.14.1.6	SOURce:STEReo Subsystem.....	397
12.14.2	SOURce:CORRection Subsystem.....	404
12.14.2.1	Correction Settings.....	407
12.14.2.2	Correction Data Exchange.....	410
12.14.3	SOURce:FREQuency Subsystem.....	412
12.14.4	SOURce:INPut Subsystem.....	418
12.14.5	SOURce:LFOutput Subsystem.....	419
12.14.5.1	LF Generator Settings.....	421

12.14.5.2	LF Sweep Settings.....	429
12.14.6	SOURce:LIST Subsystem.....	432
12.14.6.1	List Mode Settings.....	435
12.14.6.2	List Mode File Operation.....	440
12.14.6.3	List Mode Data Exchange.....	443
12.14.7	SOURce:NOISe Subsystem.....	445
12.14.7.1	Noise Generator.....	446
12.14.8	SOURce:PGEN Subsystem.....	447
12.14.9	SOURce:PHASe Subsystem.....	449
12.14.10	SOURce:POWer Subsystem.....	449
12.14.11	SOURce:ROSCillator Subsystem.....	458
12.14.12	SOURce:SWEEp Subsystem.....	463
12.15	SYSTem Subsystem.....	475
12.16	STATus Subsystem.....	500
12.17	TEST Subsystem.....	503
12.18	TRIGger Subsystem.....	504
12.19	UNIT Subsystem.....	508
12.20	Direct Commands for the Stereo/RDS Coder Option R&S SMBB-B5.....	508
12.20.1	Programming Examples.....	509
12.20.2	Remote-Control Commands.....	511
13	Troubleshooting and Error Messages.....	530
13.1	Error Messages.....	530
13.1.1	Volatile Messages.....	530
13.1.2	Permanent Messages.....	530
13.2	SCPI-Error Messages.....	531
13.3	Device-Specific Error Messages.....	531
13.4	Querying Error Messages.....	532
13.5	Resolving Network Connection Failures.....	534
13.6	Measuring USB cable quality.....	535
13.7	Requesting Instrument Configuration and Specifications.....	535
13.7.1	Hardware Configuration Settings.....	536
13.7.2	Versions/Options Settings.....	537
13.7.3	How to Query Instrument Configuration.....	539

13.7.4	How to Request the Data Sheet.....	540
13.8	Collecting Information for Technical Support.....	540
13.9	Contacting Customer Support.....	542
14	Transporting.....	543
15	Maintenance, Storage and Disposal.....	544
15.1	Cleaning.....	544
15.2	Storage.....	544
15.3	Performing Maintenance Tasks.....	544
15.3.1	Date and Time.....	544
15.3.1.1	Data and Time Settings.....	545
15.3.1.2	How To Set Data and Time.....	546
15.3.2	Check Front Panel.....	547
15.3.2.1	Check Front Panel Settings.....	547
15.3.2.2	How to Test the Front Panel.....	547
15.3.3	Internal Adjustments.....	549
15.3.3.1	Internal Adjustments Settings.....	550
15.3.3.2	How to Use the Internal Adjustments.....	551
15.3.4	FPGA/uC Update Settings.....	552
15.4	Disposal.....	554
	Annex.....	555
A	Reference Information for Remote Control.....	555
A.1	Additional Basics on Remote Control.....	555
A.1.1	Messages.....	555
A.1.2	LAN Interface Messages.....	556
A.1.3	SCPI Command Structure.....	556
A.1.3.1	Syntax for Common Commands.....	557
A.1.3.2	Syntax for Device-Specific Commands.....	557
A.1.3.3	SCPI Parameters.....	559
A.1.3.4	Overview of Syntax Elements.....	561
A.1.3.5	Structure of a Command Line.....	563
A.1.3.6	Responses to Queries.....	563
A.1.4	Command Sequence and Synchronization.....	564

A.1.4.1	Preventing Overlapping Execution.....	564
A.1.4.2	Examples to Command Sequence and Synchronization.....	566
A.1.5	Status Reporting System.....	567
A.1.5.1	Hierarchy of the Status Registers.....	568
A.1.5.2	Structure of a SCPI Status Register.....	569
A.1.5.3	Status Byte (STB) and Service Request Enable Register (SRE).....	571
A.1.5.4	Event Status Register (ESR) and Event Status Enable Register (ESE).....	572
A.1.5.5	Questionable Status Register (STATus:QUEStionable).....	573
A.1.5.6	Operation Status Register (STATus:OPERation).....	573
A.1.5.7	Application of the Status Reporting System.....	573
A.1.5.8	Reset Values of the Status Reporting System.....	575
A.1.6	General Programming Recommendations.....	576
A.2	Telnet program examples.....	576
A.3	Extensions for User Files.....	581
B	Hardware Interfaces.....	583
B.1	GPIB-Bus Interface.....	583
	Glossary: List of the Often Used Terms and Abbreviations.....	585
	List of Commands.....	589
	Index.....	600

1 Preface

The R&S SMB100B is a new high-performance signal generator developed to meet demanding customer requirements. Offering excellent signal characteristic and straightforward and intuitive operation, the signal generator makes signal generation fast and easy.

1.1 Key Features

Outstanding key features of the R&S SMB100B are:

- SCPI macro recorder and code generator for generating executable remote control code from manual operating steps (for MATLAB®, CVI, etc.)
- Frequency range from 8 kHz to up to 6 GHz
- Excellent SSB phase noise of -134 dBc (meas.) at 1 GHz, 20 kHz offset
- Low wideband noise. For frequencies between 15 MHz and 6 GHz and 30 MHz offset, < 153 dBc (typ.)
- Ultra high output power of 34 dBm (meas.) for 1 GHz
- Compact rack with a height of 2 U and a ¾ 19" width
- Pulse train generation
- 5" Graphical User Interface with touchscreen

For more information, see data sheet.

1.2 About this Manual

This user manual describes general instrument functions, the manual operation of the instrument and remote control.

The main focus of this manual is on the signal generation capabilities of the instrument and the tasks required to achieve them. The following topics are included:

- **Welcome to the R&S SMB100B**
Introduction to and getting familiar with the instrument, including introduction to the signal generation principles.
- **Getting Started**
Information that you have received as a printed book together with your instrument
- **Configuration of the RF Signal**
Descriptions of the individual operation modes, including configuration settings and task descriptions
- **File and Data Management**
Description of general functions to handle data files and work with the file system of the instrument
- **System and General Instrument Configuration**
Description of the general instrument settings and functions

- **Network and Remote Control Operation**
Information on setting up the instrument in a network and operating it remotely.
- **Remote Commands**
Remote commands required to configure and perform measurements in a remote environment, sorted by tasks.
Remote commands required to set up the environment and to perform common tasks on the instrument, sorted by tasks.
Programming examples demonstrate the use of many commands and can usually be executed directly for test purposes.
- **Maintenance**
Information on tasks required to maintain the operability of the instrument
- **Troubleshooting and Error Messages**
Hints and tips on how to handle errors
- **Appendix**
Extensive reference information on remote control, hardware interfaces, etc.
- **Glossary**
List of often used terms and abbreviations
- **List of Commands**
Alphabetical list of all remote commands described in the manual
- **Index**

Contents and scope

This help system describes the full functionality of an R&S SMB100B. Depending on your model and the installed options, some of the functions may not be available on your instrument.

Notes on screenshots

When describing the functions of the product, we use sample screenshots. These screenshots are meant to illustrate as much as possible of the provided functions and possible interdependencies between parameters. The shown values may not represent realistic usage scenarios.

The screenshots usually show a fully equipped product, that is: with all options installed. Thus, some functions shown in the screenshots may not be available in your particular product configuration.

1.3 Documentation Overview

This section provides an overview of the R&S SMB100B user documentation. Unless specified otherwise, you find the documents on the R&S SMB100B product page at:

www.rohde-schwarz.com/manual/smb100b

1.3.1 Getting Started Manual

Introduces the R&S SMB100B and describes how to set up and start working with the product. Includes basic operations, typical measurement examples, and general information, e.g. safety instructions, etc. A printed version is delivered with the instrument.

1.3.2 User Manuals and Help

Contains the description of all instrument modes and functions. It also provides an introduction to remote control, a complete description of the remote control commands with programming examples, and information on maintenance, instrument interfaces and error messages. Includes the contents of the getting started manual.

The contents of the user manuals are available as help in the R&S SMB100B. The help offers quick, context-sensitive access to the complete information.

All user manuals are also available for download or for immediate display on the Internet.

1.3.3 Service Manual

Describes the performance test for checking the rated specifications, module replacement and repair, firmware update, troubleshooting and fault elimination, and contains mechanical drawings and spare part lists.

The service manual is available for registered users on the global Rohde & Schwarz information system (GLORIS, <https://gloris.rohde-schwarz.com>).

1.3.4 Instrument Security Procedures

Deals with security issues when working with the R&S SMB100B in secure areas. It is available for download on the Internet.

1.3.5 Basic Safety Instructions

Contains safety instructions, operating conditions and further important information. The printed document is delivered with the instrument.

1.3.6 Data Sheets and Brochures

The data sheet contains the technical specifications of the R&S SMB100B. It also lists the options and their order numbers and optional accessories.

The brochure provides an overview of the instrument and deals with the specific characteristics.

See www.rohde-schwarz.com/brochure-datasheet/smb100b

1.3.7 Release Notes and Open Source Acknowledgment (OSA)

The release notes list new features, improvements and known issues of the current firmware version, and describe the firmware installation.

The open source acknowledgment document provides verbatim license texts of the used open source software.

See www.rohde-schwarz.com/firmware/smb100b

1.3.8 Application Notes, Application Cards, White Papers, etc.

These documents deal with special applications or background information on particular topics.

See www.rohde-schwarz.com/application/smb100b

2 Safety and Regulatory Information

The product documentation helps you use the product safely and efficiently. Follow the instructions provided here and in the [Chapter 2.1, "Safety Instructions"](#), on page 19.

Intended use

The product is intended for the development, production and verification of electronic components and devices in industrial, administrative, and laboratory environments. Use the product only for its designated purpose. Observe the operating conditions and performance limits stated in the data sheet.

Where do I find safety information?

Safety information is part of the product documentation. It warns you of potential dangers and gives instructions on how to prevent personal injury or damage caused by dangerous situations. Safety information is provided as follows:

- In [Chapter 2.1, "Safety Instructions"](#), on page 19. The same information is provided in many languages as printed "Safety Instructions". The printed "Safety Instructions" are delivered with the product.
- Throughout the documentation, safety instructions are provided when you need to take care during setup or operation.

2.1 Safety Instructions

Products from the Rohde & Schwarz group of companies are manufactured according to the highest technical standards. To use the products safely, follow the instructions provided here and in the product documentation. Keep the product documentation nearby and offer it to other users.

Use the product only for its intended use and within its performance limits. Intended use and limits are described in the product documentation such as the data sheet, manuals and the printed safety instructions. If you are unsure about the appropriate use, contact Rohde & Schwarz customer service.

Using the product requires specialists or specially trained personnel. These users also need sound knowledge of at least one of the languages in which the user interfaces and the product documentation are available.

If any part of the product is damaged or broken, stop using the product. Never open the casing of the product. Only service personnel authorized by Rohde & Schwarz are allowed to repair the product. Contact Rohde & Schwarz customer service at <http://www.customersupport.rohde-schwarz.com>.

Lifting and carrying the product

The maximum weight of the product is provided in the data sheet. To move the product safely, you can use lifting or transporting equipment such as lift trucks and forklifts. Follow the instructions provided by the equipment manufacturer.

Choosing the operating site

Only use the product indoors. The product casing is not waterproof. Water that enters can electrically connect the casing with live parts, which can lead to electric shock, serious personal injury or death if you touch the casing. If Rohde & Schwarz provides a carrying bag designed for your product, you can use the product outdoors.

Unless otherwise specified, you can operate the product up to an altitude of 2000 m above sea level. The product is suitable for pollution degree 2 environments where nonconductive contamination can occur. For more information on environmental conditions such as ambient temperature and humidity, see the data sheet.

Setting up the product

Always place the product on a stable, flat and level surface with the bottom of the product facing down. If the product is designed for different positions, secure the product so that it cannot fall over.

If the product has foldable feet, always fold the feet completely in or out to ensure stability. The feet can collapse if they are not folded out completely or if the product is moved without lifting it. The foldable feet are designed to carry the weight of the product, but not an extra load.

If stacking is possible, keep in mind that a stack of products can fall over and cause injury.

If you mount products in a rack, ensure that the rack has sufficient load capacity and stability. Observe the specifications of the rack manufacturer. Always install the products from the bottom shelf to the top shelf so that the rack stands securely. Secure the product so that it cannot fall off the rack.

Connecting to power

The product is an overvoltage category II product and has to be connected to a fixed installation used to supply energy-consuming equipment such as household appliances and similar loads. Be aware that electrically powered products have risks, such as electric shock, fire, personal injury or even death.

Take the following measures for your safety:

- Before switching on the product, ensure that the voltage and frequency indicated on the product match the available power source. If the power adapter does not adjust automatically, set the correct value and check the rating of the fuse.
- If a product has an exchangeable fuse, its type and characteristics are indicated next to the fuse holder. Before changing the fuse, switch off the instrument and disconnect it from the power source. How to change the fuse is described in the product documentation.
- Only use the power cable delivered with the product. It complies with country-specific safety requirements. Only insert the plug into an outlet with protective conductor terminal.
- Only use intact cables and route them carefully so that they cannot be damaged. Check the power cables regularly to ensure that they are undamaged. Also ensure that nobody can trip over loose cables.





- If the product needs an external power supply, use the power supply that is delivered with the product or that is recommended in the product documentation or a power supply that conforms to the country-specific regulations.
- Only connect the product to a power source with a fuse protection of maximum 20 A.
- Ensure that you can disconnect the product from the power source at any time. Pull the power plug to disconnect the product. The power plug must be easily accessible. If the product is integrated into a system that does not meet these requirements, provide an easily accessible circuit breaker at the system level.

Cleaning the product

Use a dry, lint-free cloth to clean the product. When cleaning, keep in mind that the casing is not waterproof. Do not use liquid cleaning agents.

Meaning of safety labels

Safety labels on the product warn against potential hazards.

	<p>Potential hazard</p> <p>Read the product documentation to avoid personal injury or product damage.</p>
	<p>Electrical hazard</p> <p>Indicates live parts. Risk of electric shock, fire, personal injury or even death.</p>
	<p>Hot surface</p> <p>Do not touch. Risk of skin burns. Risk of fire.</p>
	<p>Protective conductor terminal</p> <p>Connect this terminal to a grounded external conductor or to protective ground. This protects you against electric shock should an electric problem occur.</p>

2.2 Labels on R&S SMB100B

Labels on the casing inform about:

- Personal safety, see ["Connecting to power"](#) on page 20.
- Product and environment safety, see [Table 2-1](#).
- Identification of the product, see the serial number on the [rear panel](#).

Table 2-1: Labels regarding R&S SMB100B and environment safety

	<p>Labeling in line with EN 50419 for disposal of electrical and electronic equipment after the product has come to the end of its service life. For more information, see Chapter 15.4, "Disposal", on page 554.</p>
---	---

2.3 Korea Certification Class B



이 기기는 가정용(B급) 전자파 적합기기로서 주로 가정에서 사용하는 것을 목적으로 하며, 모든 지역에서 사용할 수 있습니다.

3 Getting Started

3.1 Preparing for Use

This chapter describes the basic steps to be taken when setting up the product for the first time.

3.1.1 Lifting and Carrying

See also ["Lifting and carrying the product"](#) on page 19.

- ▶ Use the carrying handle at the side for lifting and carrying the R&S SMB100B.

For mounting the R&S SMB100B in a rack, see [Chapter 3.1.4.2, "Mounting the R&S SMB100B in a Rack"](#), on page 25.

3.1.2 Unpacking and Checking

1. Unpack the R&S SMB100B carefully.
2. Retain the original packing material. Use it to protect the control elements and connectors when transporting or shipping the R&S SMB100B later.
See also [Chapter 14, "Transporting"](#), on page 543.
3. Using the delivery notes, check the equipment for completeness.
4. Check the equipment for damage.

If the delivery is incomplete or equipment is damaged, contact Rohde & Schwarz.

3.1.3 Choosing the Operating Site

Specific operating conditions ensure accurate measurements and avoid damage to the product and connected devices. For information on environmental conditions such as ambient temperature and humidity, see the data sheet.

See also ["Choosing the operating site"](#) on page 20.

Electromagnetic compatibility classes

The electromagnetic compatibility (EMC) class indicates where you can operate the product. The EMC class of the product is given in the data sheet under "General data".

- Class B equipment is suitable for use in:
 - Residential environments

- Environments that are directly connected to a low-voltage supply network that supplies residential buildings
- Class A equipment is intended for use in industrial environments. It can cause radio disturbances in residential environments due to possible conducted and radiated disturbances. It is therefore not suitable for class B environments. If class A equipment causes radio disturbances, take appropriate measures to eliminate them.

3.1.4 Setting Up the R&S SMB100B

See also:

- ["Setting up the product"](#) on page 20.
- ["Intended use"](#) on page 19.

3.1.4.1 Placing the R&S SMB100B on a Bench Top

To place the product on a bench top

1. Place the product on a stable, flat and level surface. Ensure that the surface can support the weight of the product. For information on the weight, see the data sheet.
2. **CAUTION!** Foldable feet can collapse. See ["Setting up the product"](#) on page 20. Always fold the feet completely in or out. With folded-out feet, do not place anything on top or underneath the product.
3. **WARNING!** A stack of products can fall over and cause injury. Never stack more than three products on top of each other. Instead, mount them in a rack.

Stack as follows:

- It is best if all products have the same dimensions (width and length).
- The overall load on the lowest product must not exceed 500 N.
- With smaller products on top of the lowest product, the overall load on the lowest product must not exceed 250 N.

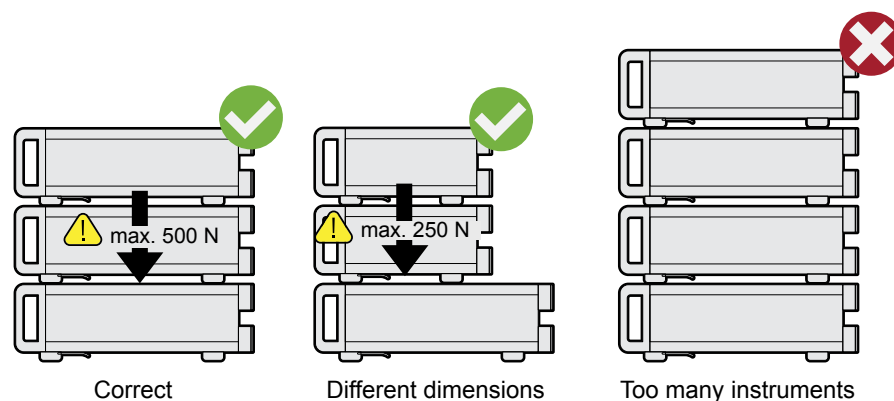

4. **NOTICE!** Overheating can damage the product.

Prevent overheating as follows:

- Keep a minimum distance of 10 cm between the fan openings of the product and any object in the vicinity.
- Do not place the product next to heat-generating equipment such as radiators or other products.

3.1.4.2 Mounting the R&S SMB100B in a Rack

To prepare the rack

1. Observe the requirements and instructions in "[Setting up the product](#)" on page 20.
2. **NOTICE!** Insufficient airflow can cause overheating and damage the product. Design and implement an efficient ventilation concept for the rack.

To mount the R&S SMB100B in a rack

1. Use an adapter kit that fits the dimensions of the R&S SMB100B to prepare the instrument for rack mounting. For information on the dimensions, see data sheet.
 - a) Order the rack adapter kit designed for the R&S SMB100B. For the order number, see data sheet.
 - b) Mount the adapter kit. Follow the assembly instructions provided with the adapter kit.
2. Lift the R&S SMB100B to shelf height.
3. Grab the handles and push the R&S SMB100B onto the shelf until the rack brackets fit closely to the rack.
4. Tighten all screws at the rack brackets with a tightening torque of 1.2 Nm to secure the R&S SMB100B at the rack.

To unmount the R&S SMB100B from a rack

1. Loosen the screws at the rack brackets.
2. Bring the lifting equipment to shelf height.
3. Remove the R&S SMB100B from the rack.
4. If placing the R&S SMB100B on a bench top again, unmount the adapter kit from the R&S SMB100B. Follow the instructions provided with the adapter kit.

3.1.5 Important Aspects for Test Setup

Cable selection and electromagnetic interference (EMI)

Electromagnetic interference (EMI) can affect the measurement results.

To suppress electromagnetic radiation during operation:

- Use high-quality shielded cables, especially for the following connector types:
 - BNC
Double-shielded BNC cables.
 - USB
Double-shielded USB cables.
How to: [Chapter 3.1.8, "Connecting USB Devices"](#), on page 27.
See also [Chapter 13.6, "Measuring USB cable quality"](#), on page 535.
 - LAN
At least CAT6 STP cables.
How to: [Chapter 3.1.7, "Connecting to LAN"](#), on page 27
- Always terminate open cable ends.
- Ensure that connected external devices comply with EMC regulations.

Signal input and output levels

Information on signal levels is provided in the data sheet. Keep the signal levels within the specified ranges to avoid damage to the R&S SMB100B and connected devices.

Preventing electrostatic discharge (ESD)

Electrostatic discharge is most likely to occur when you connect or disconnect a DUT.

- ▶ **NOTICE!** Risk of electrostatic discharge. Electrostatic discharge can damage the electronic components of the product and the device under test (DUT).
Ground yourself to prevent electrostatic discharge damage:
 - a) Use a wrist strap and cord to connect yourself to ground.
 - b) Use a conductive floor mat and heel strap combination.

3.1.6 Connecting to Power

For safety information, see ["Connecting to power"](#) on page 20.

1. Plug the AC power cable into the AC power connector on the rear panel of the instrument. Only use the AC power cable delivered with the R&S SMB100B.
2. Plug the AC power cable into a power outlet with ground contact.
The required ratings are listed next to the AC power connector and in the data sheet.

3.1.7 Connecting to LAN

You can operate the R&S SMB100B via LAN (local area network) or you can operate it locally. This section describes how to connect the instrument to a LAN to operate or control the instrument remotely via a PC in a LAN.

The connector is located on the [rear panel](#).

- ▶ Connect the LAN socket via an RJ-45 cable to the LAN.

By default, the R&S SMB100B is configured to use DHCP (dynamic host configuration protocol) and no static IP address is configured.

If switched on and connected to the LAN, the R&S SMB100B displays the address information on the screen.

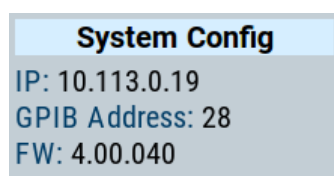

Figure 3-1: IP address indication on the screen (example)

See [Chapter 11.6, "Connecting the Instrument to the Network \(LAN\)"](#), on page 285

3.1.8 Connecting USB Devices

USB connectors are located on the [front panel](#) and [rear panel](#). You can connect or disconnect all USB devices from the R&S SMB100B during operation.

To connect USB storage devices

USB storage devices, such as memory sticks, allow easy data transfer from/to the R&S SMB100B. You can also use them for firmware updates.

- ▶ Connect the USB storage device to any of the USB connectors.

To connect USB devices with external power supply

1. **NOTICE!** Connected devices with external power supply can feed back current into the 5 V power supply of the USB interface and thus damage the R&S SMB100B.

Ensure that there is no connection between the positive pole of the power supply and the +5 V power pin of the USB interface (VBUS).

2. Connect the USB storage device to any of the USB connectors.

To connect a keyboard

- ▶ Connect the keyboard to any of the USB connectors.

When connected, the R&S SMB100B detects the keyboard automatically. A detected keyboard has the default layout English – US.

To connect a mouse

- ▶ Connect the mouse to any of the USB connectors.

When connected, the R&S SMB100B detects the mouse automatically.

To connect power sensors

You can connect power sensors of the R&S NRP families to any of the USB connectors.

See [Chapter 7.4, "Using Power Sensors"](#), on page 165.

3.1.9 Connecting to RF

The connector is located on the [front panel](#).

To prepare for connecting to "RF"

1. If the R&S SMB100B is switched on, deactivate the RF output, before connecting an RF cable to the RF connector.
In the home screen, select the block "Level" > "RF ON > Off".
2. Use a high-quality RF cable that matches the RF connector type.
See ["Cable selection and electromagnetic interference \(EMI\)"](#) on page 26.

To connect to non-screwable connectors (BNC)

- ▶ To connect the RF cable with the "RF" connector, proceed as follows:
 - a) Carefully align the connector of the cable and the "RF" connector along a common axis.
 - b) Mate the connectors along the common axis until the male pin of the connector of the cable engages with the female socket of the "RF" connector.

Preventing RF output switch-off

- ▶ **NOTICE!** If you set a too high output level, the reverse power can exceed a limit forcing the R&S SMB100B to switch off the RF output.
Set an RF output level that is not higher than the maximum permissible RF power as given in the data sheet.

3.1.10 Connecting to Ref In/Ref Out

The connector is located on the [rear panel](#).

To connect to "Ref In"/"Ref Out" (reference < 1 GHz)

For connection, the R&S SMB100B provides BNC connectors.

- ▶ Follow the instructions in ["To connect to non-screwable connectors \(BNC\)"](#) on page 28.

To connect to Ref In/Ref Out (reference = 1 GHz)

For connection, the R&S SMB100B provides SMA connectors.

1. Use a high-quality cable that matches the connector type.
See ["Cable selection and electromagnetic interference \(EMI\)"](#) on page 26.
2. **NOTICE!** Risk of instrument damage and connector damage. Excessive tightening can damage the cables and the connectors. However, if you do not tighten the connectors enough, the measurement results can be inaccurate.

To connect the cable with the connector, proceed as follows:

- a) Carefully align the connector of the cable and the connector along a common axis.
- b) Mate the connectors along the common axis until the male pin of the inner connector engages with the female socket of the outer connector.
- c) Turn the nut of the outer connector until the connectors are firmly coupled.
- d) Torque the nut to the specified limit using a calibrated torque wrench. Hold the opposite connector part stationary with a spanner.

For torque limits of the most relevant connector types, see [Table 3-1](#).

3. Torque the nut to the specified limit using a calibrated torque wrench. Hold the opposite connector part stationary with a spanner.

For more information, see chapter "Handling" of the application note [1MA99](#).

Table 3-1: Connector types and torque limits

Type	Torque limit		Nut opening	
	lb-Inch	Nm	Inch	mm
N	13.3	1.5	3/4	20
SMA	5	0.56	5/16	8
3.5 mm	8	0.9	5/16	8
2.92 mm	8	0.9	5/16	8
2.4 mm	8	0.9	5/16	8
1.85 mm	8	0.9	5/16	8
1.0 mm	3	0.34	0.236	6

3.1.11 Switching On or Off

The following table provides an overview of power states, LEDs and power switch positions.

Table 3-2: Overview of power states

State	LED	Position of power switch
Off	● gray	[0]
Standby	● yellow ● orange	[1]
Ready	● yellow	[1]

To switch on the R&S SMB100B

The R&S SMB100B is off but connected to power. See [Chapter 3.1.6, "Connecting to Power"](#), on page 26.

1. Set the switch on the power supply to position [1].
The switch is located on the [rear panel](#).
The LED of the [On/Standby] key is orange.
2. Wait until the oven-controlled oscillator (OCXO) warms up. For the warm-up time, see data sheet.
3. Press the [On/Standby] key.
Key and LED are located on the [front panel](#).
The LED changes to green. The R&S SMB100B boots.

When starting for the first time, the R&S SMB100B starts with the default settings. When restarting the instrument, the settings depend on the instrument configuration before shut-down.

See [Chapter 9.4, "Saving and Recalling Instrument Settings"](#), on page 197.

When the instrument is switched on, it automatically monitors main functions. You can query erroneous functions. In addition to automatic monitoring, you can perform maintenance tasks.

See:

- [Chapter 13.4, "Querying Error Messages"](#), on page 532
- [Chapter 15.3, "Performing Maintenance Tasks"](#), on page 544

To shut down the product

The product is in the ready state.

- ▶ Press the On/Standby key.
The operating system shuts down. The LED changes to orange.

In the standby state, the power switch circuits and the OCXO are active. To deactivate them, disconnect the instrument from the power supply.

To disconnect from power

The R&S SMB100B is in the standby state.

1. **NOTICE!** Risk of data loss. If you disconnect the product from power when it is in the ready state, you can lose settings and data. Shut it down first.
Set the toggle switch on the power supply to position [0].
The LED of the [On/Standby] key is switched off.
2. Disconnect the R&S SMB100B from the power source.

3.2 Instrument Tour

The following topics help you get familiar with the instrument and perform the first steps:

- [Front Panel Tour](#)
- [Rear Panel Tour](#)

This section explains the control elements and the connectors of the R&S SMB100B with the aid of the front and rear views. For specifications of the interfaces, refer to the data sheet.

The meanings of the labels on the R&S SMB100B are described in [Chapter 2.2, "Labels on R&S SMB100B"](#), on page 21.

3.2.1 Front Panel Tour

This section provides an overview of the control elements at the front panel of the R&S SMB100B. Most of the connectors are at the rear panel and are described in [Chapter 3.2.2, "Rear Panel Tour"](#), on page 35.



Figure 3-2: Front panel view

- 1 = Utility keys
- 2 = [On/Standby]
- 3 = Touchscreen

- 4 = Function keys
- 5 = Keypad
- 6 = Navigation controls
- 7 = Display keys
- 8 = USB connector
- 9 = RF output connector

3.2.1.1 Touchscreen

The screen at the front panel is the graphical user interface. It shows the settings dialogs and parameters, and the current configuration at a glance, see [Chapter 3.4.3, "Understanding the Display Information"](#), on page 47.

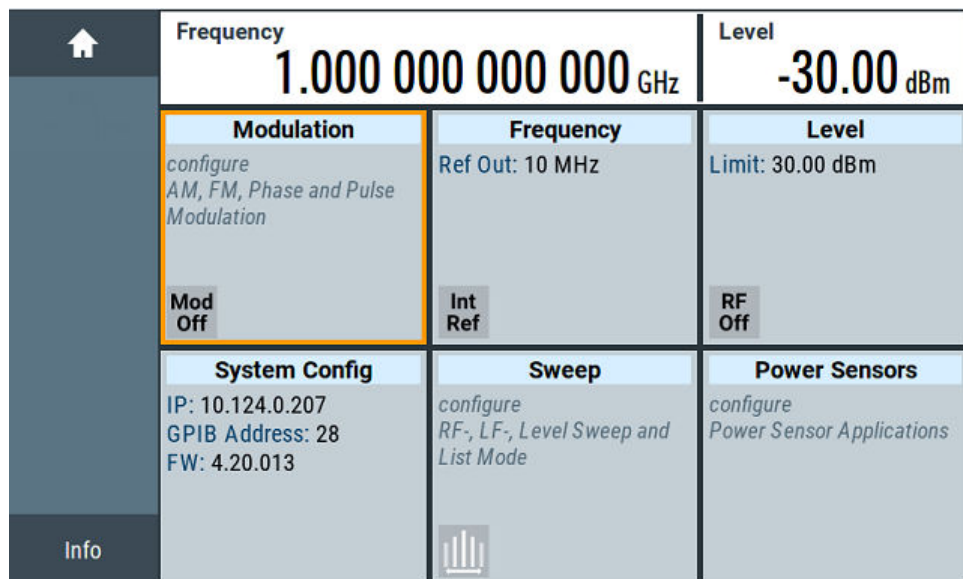

Figure 3-3: Touchscreen

The touch-sensitive panel provides an alternative means of user interaction for quick and easy handling of the instrument, see [Chapter 3.4.2, "Means of Manual Interaction"](#), on page 46.

See also:

- [Chapter 3.4, "Instrument Control"](#), on page 45, for operating the touchscreen.
- [Chapter 15.1, "Cleaning"](#), on page 544, for instructions on cleaning the screen.

3.2.1.2 Utility Keys

The utility keys set the R&S SMB100B to a defined state, and provide access to basic settings and information on assistance.

Table 3-3: Utility keys

Utility Key	Assigned functions
[Preset]	Sets the instrument to a defined state
[Local]	Switches from remote control to local (manual) control
[Setup]	Accesses the general instrument settings
[Help]	Displays context-sensitive help text

3.2.1.3 On/Standby

The [On/Standby] key switches the instrument from the standby to the ready state or vice versa.

The LED above the [On/Standby] key indicates the instrument state, see [Chapter 3.1.11, "Switching On or Off"](#), on page 30.

3.2.1.4 Function Keys

Function keys provide access to the most common generator settings and functions. You can find a detailed description of the corresponding functions in the user manual.

Table 3-4: Function keys

Function key	Assigned functions
[Freq]	Activates frequency entry.
[Level]	Activates level entry.
[Mod on/off]	Switches the modulation on and off.
[RF on/off]	Switches the RF output on and off.

3.2.1.5 Keypad

The keypad enables you to enter alphanumeric parameters, including the corresponding units. It contains the following keys:

Table 3-5: Keys on the keypad

Type of key	Description
Alphanumeric keys	Enter numbers and (special) characters in edit dialog boxes.
Decimal point	Inserts a decimal point "." at the cursor position.
Sign key	Changes the sign of a numeric parameter. In the case of an alphanumeric parameter, inserts a "-" at the cursor position.
Unit keys (G/n dB μ V, M/ μ μ V, k/m mV and x1 dB(m))	These keys add the selected unit to the entered numeric value and complete the entry. In the case of level entries (e.g. in dB) or dimensionless values, all units have the value "1" as multiplying factor. Thus, they have the same function as an [Enter] key.

3.2.1.6 Navigation Controls

The navigation controls include a rotary knob, navigation keys, and the display keys. They allow you to navigate within the display or within dialog boxes.

Rotary Knob

The rotary knob has several functions:

- Increments (clockwise direction) or decrements (counterclockwise direction) the instrument parameter at a defined step size in the case of a numeric entry.
- Moves the selection, e.g. to a function block in the block diagram
- Shifts the selection bar within focused areas (e.g. lists).
- Acts like the [Enter] key, when it is pressed.
- Opens a context-sensitive menu, when it is pressed and held.

Editing Keys

Editing keys enable you to confirm an entry, delete individual characters, or exit the current operation.

Table 3-6: Editing keys

Type of key	Description
[Esc] key	<p>Closes all kinds of dialog boxes, if the edit mode is not active. Quits the edit mode, if the edit mode is active. In dialog boxes that contain a "Cancel" button it activates that button.</p> <p>For "Edit" dialog boxes the following mechanism is used:</p> <ul style="list-style-type: none"> • If data entry has been started, it retains the original value and closes the dialog box. • If data entry has not been started or has been completed, it closes the dialog box.
[Enter] key	<p>Has the same effect as pressing the rotary knob</p> <ul style="list-style-type: none"> • Concludes the entry of dimensionless entries. The new value is accepted. • With other entries, this key can be used instead of the default unit key. • In a dialog box, selects the default or focused element. • Calls the next dialog level. • Confirms and closes open input windows.
[Backspace] key	Deletes the character to the left of the cursor in editing mode.

Navigation Keys

As an alternative to the rotary knob or the touchscreen, you can use the navigation keys to navigate through dialog boxes, diagrams, or tables.

Table 3-7: Navigation keys

Type of key	Description
[Up/Down] Key	The [Up] and the [Down] key does the following: <ul style="list-style-type: none"> • In a numeric edit dialog box, increase or decrease the instrument parameter. • In a list, scroll forward and backward through the list entries. • In a table, move the selection bar vertically. • In windows or dialog boxes with vertical scrollbar, move the scrollbar.
[Left/Right] Key	The [Left] and the [Right] key does the following: <ul style="list-style-type: none"> • In an alphanumeric edit dialog box, move the cursor. • In a list, scroll forward and backward through the list entries. • In a table, move the selection bar horizontally. • In windows or dialog boxes with horizontal scrollbar, move the scrollbar.

3.2.1.7 Display Keys

The display keys arrange different windows on the display.

Table 3-8: Display keys

Display key	Assigned functions
[Home]	Returns to the initial feature screen.
[Next window]	Toggles between the entry fields in the taskbar.
[On/Off]	<ul style="list-style-type: none"> • Switches highlighted elements or a function block on and off. • Switches between two or more settings, e.g. items of selection lists. At the end of a list, the cursor is set on the first entry again.
[Undo]	Reverts the last operation.
[★ (User)]	Adds a parameter to the user menu for quick access.

3.2.1.8 USB Connector

Female USB type A connector, to connect devices like a keyboard, a mouse, a memory stick, or the R&S NRP-Z3/Z4 cable for the R&S NRP power sensors.

How to: [Chapter 3.1.8, "Connecting USB Devices"](#), on page 27

3.2.1.9 RF 50 Ω

Output of the RF signal (N female connector).

How to: [Chapter 3.1.9, "Connecting to RF"](#), on page 28

3.2.2 Rear Panel Tour

This section provides an overview of the connectors at the rear panel of the instrument. For technical data of the connectors, refer to the data sheet.

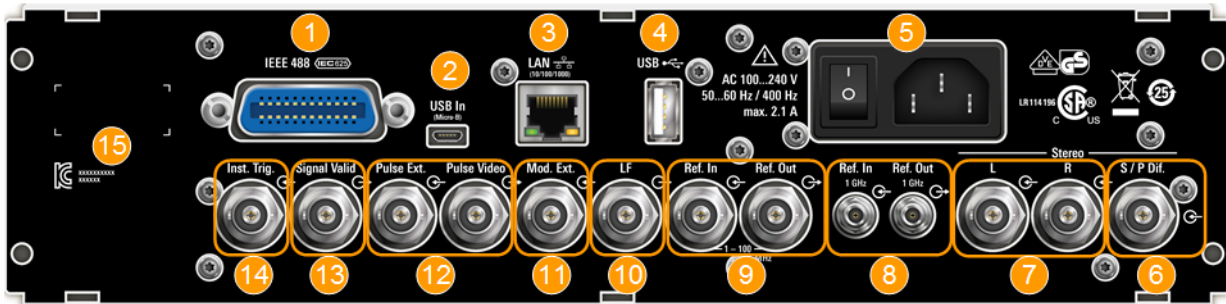

Figure 3-4: Rear panel view R&S SMB100B RF Signal Generator

- 1 = IEC 625/IEEE 488 connector
- 2 = USB In connector (type micro-B)
- 3 = LAN connector
- 4 = USB connector (type A)
- 5 = AC power supply connection and main power switch
- 6 = S/P Dif digital stereo signal input connector (BNC)
- 7 = Stereo L/R analog stereo modulation signal input connectors (BNC)
- 8 = Ref In 1GHz and Ref Out 1GHz connectors (SMA)
- 9 = Ref In and Ref Out connectors (BNC)
- 10 = LF output connector (BNC)
- 11 = Mod. Ext. input connector (BNC)
- 12 = Pulse Video and Pulse Ext. connectors (BNC)
- 13 = Signal Valid output connector (BNC)
- 14 = Inst Trig input connector (BNC)
- 15 = Serial number (six digits in the string 1400.1000.02-<serial number>-<checksum>)

3.2.2.1 Connectors

IEC 625/IEEE 488

Option: R&S SMBB-B86

General purpose interface bus (GPIB) interface for remote control of the instrument. The interface is in compliance with the standards IEC 625, IEEE 488 and SCPI.

Use this interface to connect a computer for remote control of the R&S SMB100B. To set up the connection, use high-quality shielded cables. See ["Cable selection and electromagnetic interference \(EMI\)"](#) on page 26.

See also [Chapter B.1, "GPIB-Bus Interface"](#), on page 583 and [Chapter 11, "Network Operation and Remote Control"](#), on page 257.

USB/USB In

- Female USB type A connector, to connect devices like a keyboard, a mouse, a memory stick, or the R&S NRP-Z3/Z4 cable for the R&S NRP power sensors
- Option: R&S SMBB-B86
Female USB In connector (USB type B), for example for remote control.

How to: [Chapter 3.1.8, "Connecting USB Devices"](#), on page 27

LAN

RJ-45 connector to connect the R&S SMB100B to a LAN for remote control, remote operation, and data transfer.

How to: [Chapter 3.1.7, "Connecting to LAN"](#), on page 27

AC power supply connector and switch

Mains power switch for performing the following tasks:

- Connecting the internal power supply to the power source
- Disconnecting the internal power supply from the power source

How to: [Chapter 3.1.6, "Connecting to Power"](#), on page 26.

S/P Dif

Option: R&S SMBB-B5

Input for digital stereo signals.

See also [Chapter 5.4.3, "Stereo Modulation"](#), on page 77.

Stereo L/R

Option: R&S SMBB-B5

Inputs for analog stereo modulation signals. External modulation sources or the internal LF generator can be used.

See also [Chapter 5.4.3, "Stereo Modulation"](#), on page 77.

Ref In/Ref Out

Input/output for external reference signal.

BNC connectors for reference signals from 1 MHz to 100 MHz.

SMA connectors for 1 GHz reference signals.

How to: [Chapter 3.1.10, "Connecting to Ref In/Ref Out"](#), on page 28

Mod. Ext.

Input for an external analog modulation signal.

Pulse Video

Output of the internal pulse generator signal or the looped through pulse signal from Pulse Ext. connector (video signal).

See [Chapter 5.4.1, "Pulse Modulation"](#), on page 70.

Pulse Ext.

Input for an external pulse modulation signal or an external trigger/gate signal for the pulse generator.

Signal Valid

Output signal that marks the valid signal times (valid level and frequency) for all analog modulations.

Inst Trig

BNC connector for input of external trigger signals. The signals trigger sweeps and list mode.

See [Chapter 6.1, "Signal Generation and Triggering in the Sweep and List Modes"](#), on page 111.

3.3 Trying Out the Instrument

This chapter introduces the first steps with the R&S SMB100B. It shows how to operate and configure the instrument using simple examples. The complete description of the functionality and its usage is given in the R&S SMB100B user manual. Basic instrument operation is described in [Chapter 3.4, "Instrument Control"](#), on page 45.

Prerequisites

The instrument is set up, connected to the power supply, and started up as described in [Chapter 3.1, "Preparing for Use"](#), on page 23.

The first signal generation tasks explain how to generate an unmodulated signal, to configure the RF signal output, and how you can vary the RF frequency and level in sweep mode.

The instrument is manually operated via the touchscreen. Try out the following:

- [Generating an Unmodulated Carrier](#)..... 38
- [Generating an RF Frequency Sweep Signal](#)..... 41
- [Saving and Recalling Settings](#)..... 43

3.3.1 Generating an Unmodulated Carrier

We start to generate a simple unmodulated signal. In this example, the R&S SMB100B can be in its minimal configuration.

1. On the R&S SMB100B front panel, press the [Preset] key to set a defined initial instrument state.
2. Set the frequency:
 - a) In the "Status Bar", tap the "Frequency" field.
 - b) On the on-screen keypad, enter "6" and press the "GHz" key.

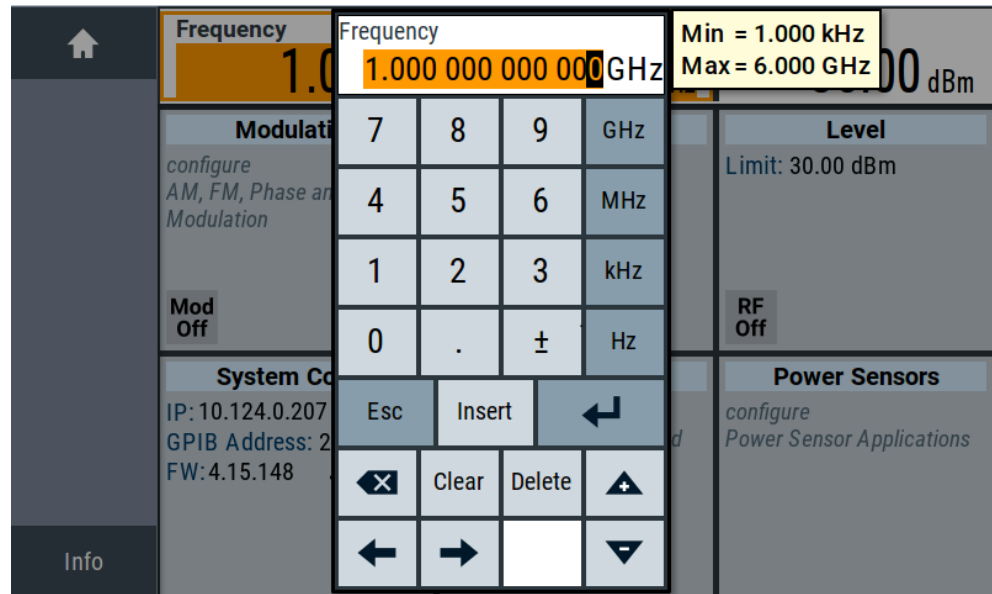

The on-screen key pad closes and the frequency value is displayed.

3. To set the signal level, tap the "Level" field and enter the level in the same way.
4. To activate RF signal output, select "Level" > "RF On" in the tile diagram.

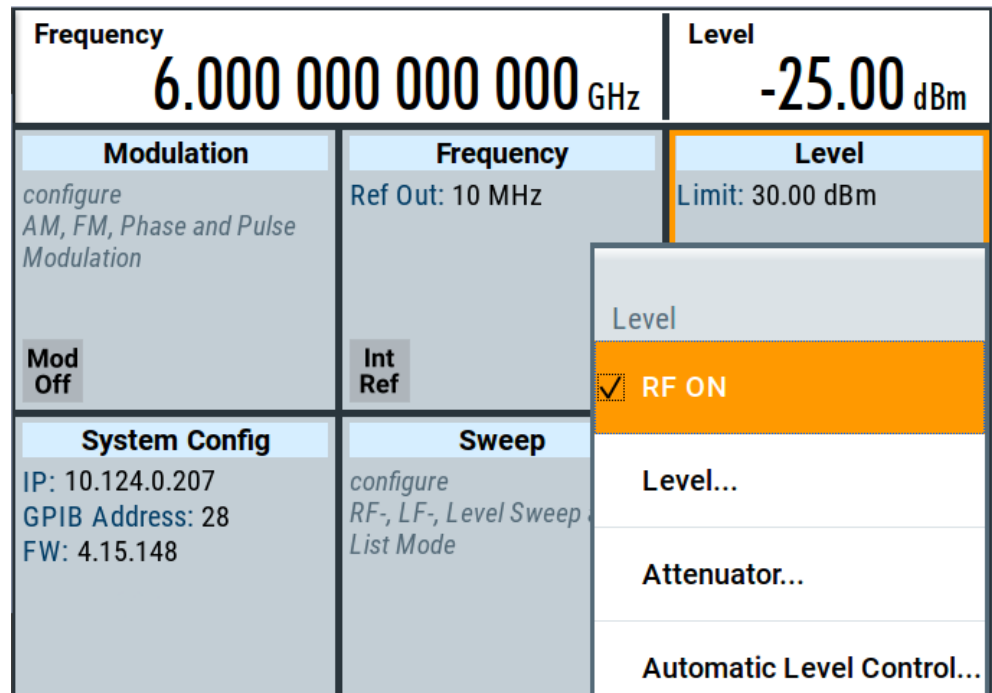

The blue colored "RF On" icon indicates that the RF output is activated.

The R&S SMB100B provides the 6 GHz signal at the RF connector at the front panel.

Frequency 6.000 000 000 000 GHz		Level -25.00 dBm
Modulation <i>configure</i> AM, FM, Phase and Pulse Modulation Mod Off	Frequency Ref Out: 10 MHz Int Ref	Level Limit: 30.00 dBm RF On
System Config IP: 10.124.0.207 GPIB Address: 28 FW: 4.15.148	Sweep <i>configure</i> RF-, LF-, Level Sweep and List Mode 	Power Sensors <i>configure</i> Power Sensor Applications

Figure 3-5: Generating an unmodulated signal

Alternative ways to access the instrument functions

To fulfill the same task, you can also use the front panel keys or the setting parameters provided in the frequency and level dialogs.

Try out the settings dialogs

1. In the "Frequency" tile, select "Frequency...".
 - a) In the "RF Frequency" tab, tap the "Frequency" field.
 - b) Set the frequency via the on-screen keypad.
2. Access the "RF Level" dialog via the "Level" tile.
 - a) In the "RF Level" tab, select "Amplitude".
 - b) Set the amplitude (level) via the on-screen keypad.
3. Select "RF State > On" to activate the RF signal generation.

See [Chapter 4, "RF Signal Configuration"](#), on page 56.

Try out the front panel keys

- ▶ Use the [Freq], [Level], and [RF on/off] key on the front panel.



Connect RF of the R&S SMB100B to a signal analyzer, for example R&S®FSW, to display the generated signal.

For the required settings of the signal analyzer, refer to its user manual or its online help.

3.3.2 Generating an RF Frequency Sweep Signal

The "Sweep" operating mode allows you to generate an RF signal with periodically varying frequencies or amplitudes.

This example deals with an RF signal with varying frequency and constant level. To configure the sweep, you need to determine a defined start and end frequency with constant time intervals between the frequency steps.

The sweep function does not require specific options.

1. On the front panel, press the [Preset] key to set a defined initial instrument state.
2. Set the signal output level, if required, e.g. set "Level > -25 dBm".
3. In the tile diagram, select "Sweep" > "Frequency Sweep".
4. In the "General" tab:

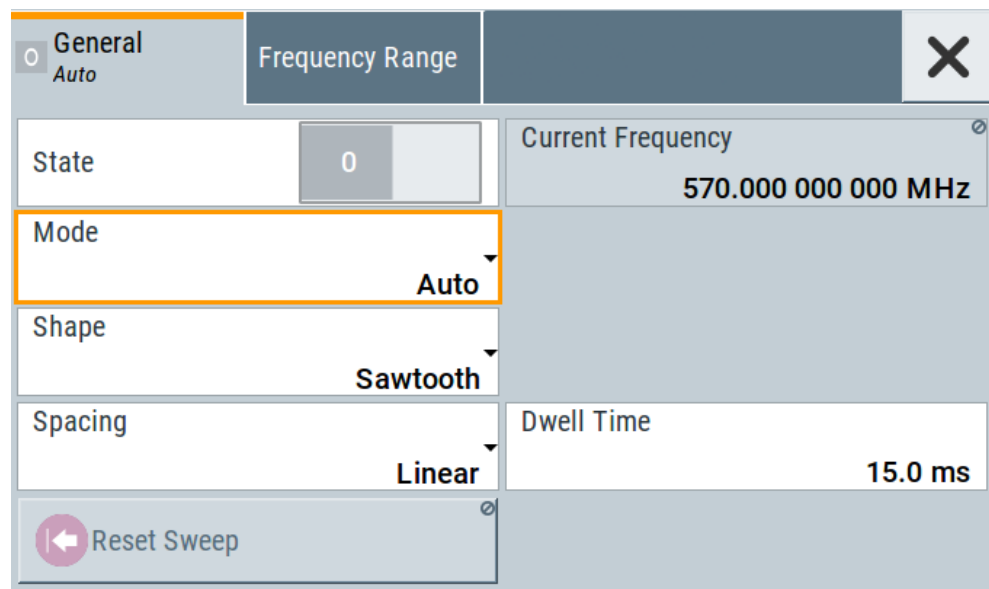

- a) Select "Mode > Auto" to run the sweep continuously.
 - b) Select "Shape > Sawtooth" to set the waveform shape of the sweep signal.
 - c) Select "Spacing > Linear", to determine the calculation method for the frequency shift of a step.
 - d) Set "Dwell Time > 15.0 ms", to determine the time interval of the sweep steps.
5. Select the "Frequency Range" tab.

General <i>Single</i>	Frequency Range	Output	Edit Marker	✕
Start Frequency	100.000 000 000 MHz	Stop Frequency	500.000 000 000 MHz	
Center Frequency	300.000 000 000 MHz	Span	400.000 000 000 MHz	
Spacing	Linear	Step Linear	1.000 000 000 MHz	

- a) Set "Start Freq > 200 MHz" and "Stop Freq > 600 MHz" to determine the frequency sweep range.
 - b) Set the step width "Step Lin > 10.0 MHz" to determine the width for a frequency step.
6. In the "General" tab, activate the frequency sweep with "State > On".
 7. Close the sweep dialog.
(Alternatively, tap the "Home" button to minimize the dialog. The R&S SMB100B indicates the "Sweep" dialog as active dialog in the task bar.)
 8. To activate the RF signal output, select "Level" > "RF On".

Home	Frequency	Level	
	520.000 000 000 MHz	-25.00 dBm	
Frequency Sweep	Modulation <i>configure</i> AM, FM, Phase and Pulse Modulation Mod Off	Frequency Ref Out: 10 MHz Int Ref	Level Limit: 30.00 dBm RF On
Info	System Config IP: 10.124.0.207 GPIB Address: 28 FW: 4.15.148	Sweep Freq Sweep: Mode - Auto Start: 200.0 MHz Stop: 600.0 MHz	Power Sensors <i>configure</i> Power Sensor Applications

Figure 3-6: Generating a frequency sweep signal

The frequency field in the status bar indicates the continuously changing frequency, i.e. the running sweep.

3.3.3 Saving and Recalling Settings

To restore the results of our measurements later, we save the instrument settings in a file.

To save the instrument settings in a file

We assume, a test configuration as described in [Chapter 3.3.2, "Generating an RF Frequency Sweep Signal"](#), on page 41.

1. Press the [Setup] key on the front panel.
2. In the "Setup" menu, select "Settings > Save/Recall".
3. In the "Save/Recall" dialog, select "Operation Mode > Save".

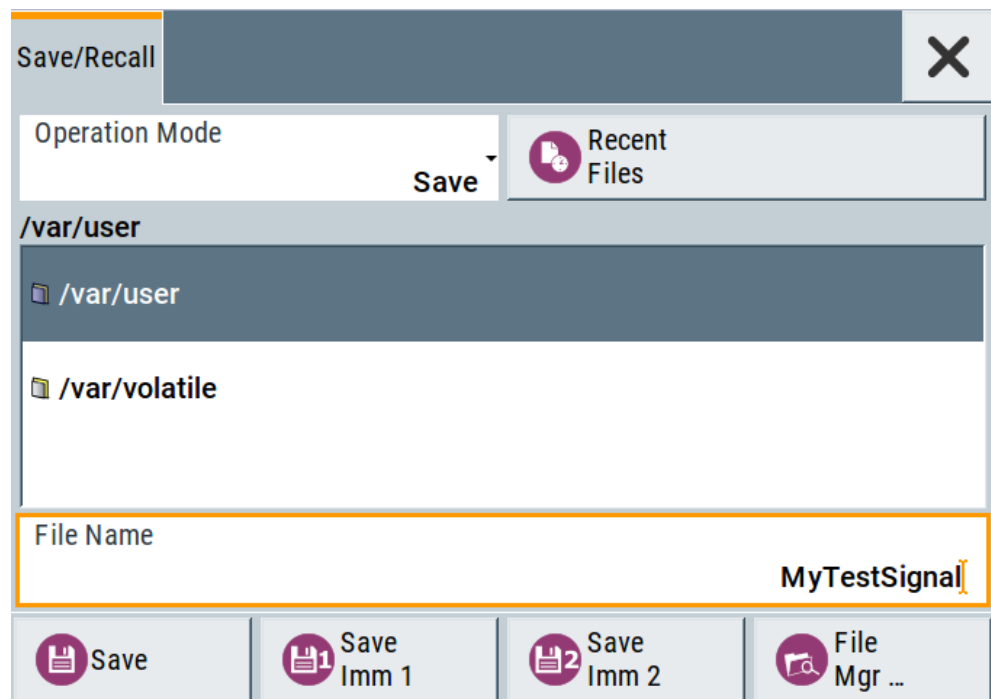

4. Tap the "Filename", use the on-screen keyboard, and enter *MyTestSignal*.
5. Tap the "Save" button.

The file `MyTestSignal.savrc1.txt` is stored in the default directory `/var/user/`.

To load saved instrument settings

You can restore the settings to the instrument at any time using the settings file.

1. Press the [Preset] button to restore the default instrument settings so you can check that the stored user settings are restored afterwards.
2. Press the [Setup] key on the front panel.
3. In the "Setup" menu, select "Settings > Save/Recall".

- In the "Save/Recall" dialog, select "Operation Mode > Recall".
Navigate to the directory the file is saved in and select the `MyTestSignal` file.

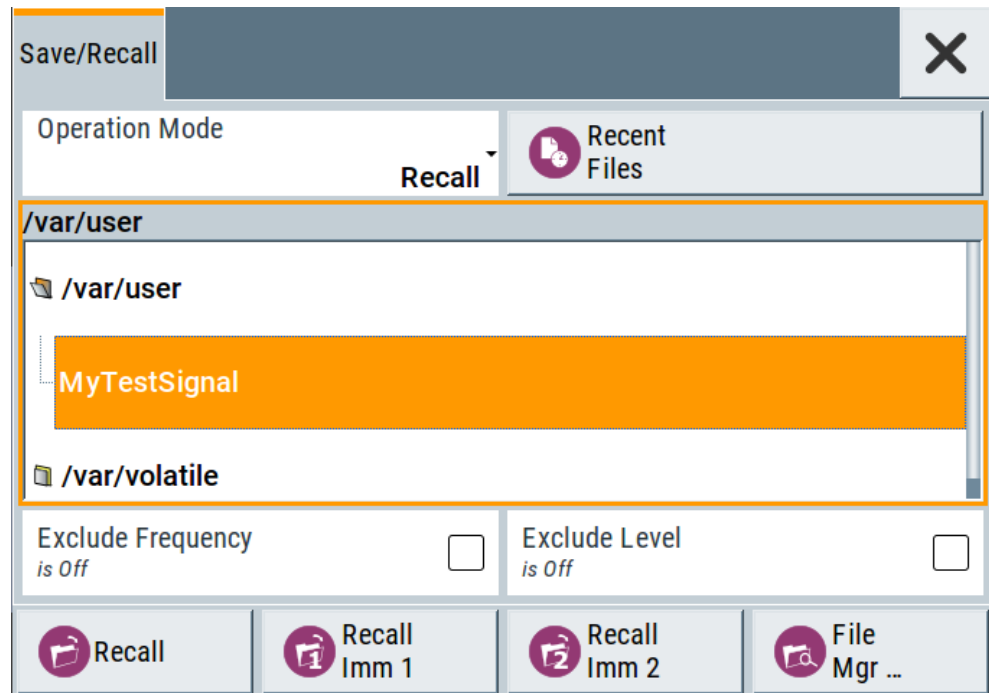

- Tap the "Recall" button.

All instrument settings are restored and the display resembles [Chapter 3.3.2, "Generating an RF Frequency Sweep Signal"](#), on page 41, which shows the instrument display right before the settings were saved.



How to display all parameters with values different to their preset values

When you load a file to your instrument, you do not have enough information on the changed settings. In such case, it is useful to visualize all parameters that have been changed from their default state.

Try out the following:

- Touch and hold a spot in the tile diagram for at least 1 second to access the context-sensitive menu.
- Select "Mark All Parameters Changed from Preset".

 **Mark All Parameters Changed from Preset**

 **Start SCPI Recording**



 **Undo**

 **Redo**

 **Help**

 **Key Emulation**

- All changed parameters are highlighted.

 Frequency Sweep	Frequency 580.000 000 000 MHz		Level -25.00 dBm
	Modulation <i>configure</i> AM, FM, Phase and Pulse Modulation Mod Off	Frequency Ref Out: 10 MHz Int Ref	Level Limit: 30.00 dBm RF On
Info	System Config IP: 10.124.0.207 GPIB Address: 28 FW: 4.15.148	Sweep Freq Sweep: Mode - Auto Start: 200.0 MHz Stop: 600.0 MHz 	Power Sensors <i>configure</i> Power Sensor Applications

See also [Chapter 9, "File and Data Management"](#), on page 189.

3.4 Instrument Control

This chapter provides an overview on how to work with the R&S SMB100B.

It covers the following topics:

• Possible Ways to Operate the Instrument.....	46
• Means of Manual Interaction.....	46
• Understanding the Display Information.....	47
• Accessing the Functionality.....	50
• Entering Data.....	51
• Getting Information and Help.....	52
• Remote Control.....	54
• Remote Operation over VNC.....	55

3.4.1 Possible Ways to Operate the Instrument

There are three ways to operate the R&S SMB100B:

- Manual operation:
Use the touchscreen, hard keys and rotary knob, or an optional mouse and/or keyboard.
The description under [Chapter 3.4, "Instrument Control"](#), on page 45 shows how to operate the instrument manually.
- Remote control:
Create programs to automatize repeating settings, tests and measurements. The instrument is connected to a computer running the program.
This way of operation is described in [Chapter 11, "Network Operation and Remote Control"](#), on page 257.
- Remote operation from a computer:
Remote monitoring and control of the instrument from a connected computer is based on the common cross-platform technology VNC (Virtual Network Computing). On the remote computer, any standard web browser (supporting Java) or a dedicated VNC client (like Ultr@VNC) can be used. See also [Chapter 3.4.8, "Remote Operation over VNC"](#), on page 55.

3.4.2 Means of Manual Interaction

For the manual interaction with the R&S SMB100B, you have several methods that you can use as an alternative to perform a task:

- Touchscreen:
Touchscreen operation is the most direct way to interact. Almost all control elements and actions on the screen are based on the standard operating system concept. You can tap any user interface element to set parameters in dialog boxes, enter data, scroll within a dialog etc., as if you work with a mouse pointer.
Tapping the screen works like clicking mouse buttons:
 - Touch quickly = click: Selects a parameter or provokes an action.
 - Touch and hold = right-click: Opens a context-sensitive menu.
 - Touch and swipe = drag: Scrolls through the contents of a display element larger than the screen, e.g. a list or a table.
- Function keys and rotary knob:
The front panel provides nearly all functions and controls to operate the instrument in the classic way, without touchscreen.

- Optional mouse and/or keyboard:
These devices work like known from PCs. The navigation keys on the front panel correspond to the keys on the keyboard.

This manual describes the manual interaction with the instrument via the touchscreen. It mentions the alternative methods using the keys on the instrument or the on-screen keypads if it deviates from the standard operating procedures. The usage of the touchscreen and navigation keys is described in [Chapter 3.4.4, "Accessing the Functionality"](#), on page 50.

Throughout the manual, the term "select" refers to any of the described methods, i.e. using a finger on the touchscreen, a mouse pointer in the display, or a key on the instrument or on a keyboard.

3.4.3 Understanding the Display Information

The home screen of the R&S SMB100B displays all main settings and generator states, divided into three main operation areas.

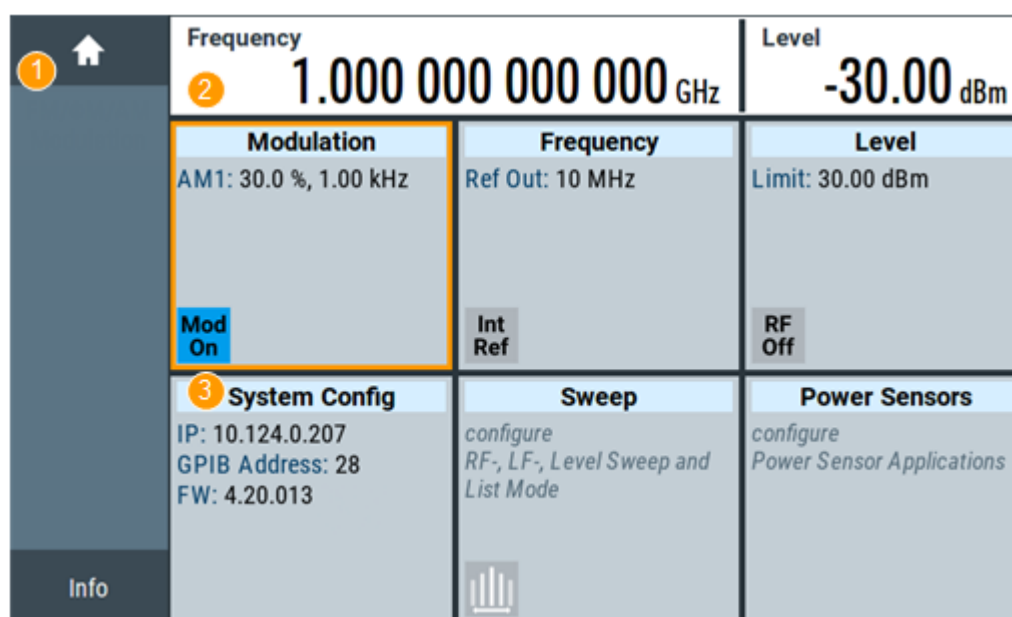

Figure 3-7: Home screen

- 1 = Taskbar/softkey bar with "Home" and "Info" key
 2 = Status bar
 3 = Tile diagram

- [Status Bar](#)..... 48
- [Tile Diagram](#)..... 48
- [Taskbar](#)..... 48
- [Additional Display Characteristics](#)..... 49

3.4.3.1 Status Bar

The status bar at the top of the screen indicates the RF frequency and the level of the output signal provided to the DUT. You can set both parameters directly here.

3.4.3.2 Tile Diagram

The tile diagram is the main entry to the settings of the R&S SMB100B.

Tile	Access to:
"Modulation"	<ul style="list-style-type: none"> Analog and stereo¹⁾, and pulse¹⁾ modulation settings Built in LF generator
"System Config"	<ul style="list-style-type: none"> "Save/Recall": settings for saving and loading instrument configurations "Remote access": Network and emulation settings. "Setup": general system configuration
"Sweep"	<ul style="list-style-type: none"> Frequency and level sweeps List mode
"Frequency"	<ul style="list-style-type: none"> RF frequency and phase Reference frequency
"Level"	<ul style="list-style-type: none"> RF level Attenuator Automatic level control User correction
"Power sensors"	<ul style="list-style-type: none"> Power sensors
¹⁾ requires additional options	

3.4.3.3 Taskbar

The "Taskbar" shows a home and an info button, and assigns a labeled button whenever you open a dialog. If more dialogs are open than the taskbar can display, touch and swipe the taskbar to scroll up and down.

The buttons shown in the following example represent the variants.

Table 3-9: Example of buttons in the taskbar

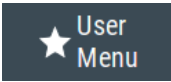
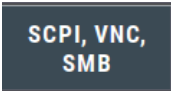
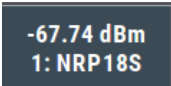
	"Home" button Returns to the home screen.
	"User Menu" Lists parameters that can be defined for quick access.
	Shows the current remote access connections when the instrument is remotely controlled. Tip: An indicator in the "System Config" tile shows the current remote control status.
	R&S NRP power sensors Shows a connected external power sensor. The button displays the current readings when the sensor is active.

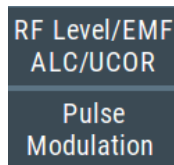

Active dialogs

Indicates the dialog name of each active dialog in a separate button.



"Info" key

Provides access to status and error messages.

Note: The warning symbol signifies a permanent error message.

3.4.3.4 Additional Display Characteristics

The following section provides a short insight on the indication of the screen in general, and significant elements that you see under specific operating modes, in dialogs or settings.

- **Appearance of active elements**
 - *Active* elements like On/Off switches, state buttons have a **blue** background.
 - *Selected* elements are framed or highlighted **orange**.
 - *Inactive* elements are **gray**.
- **On-Screen keypads**

As additional means of interacting with the instrument without having to connect an external keyboard, either a numerical or alphanumerical on-screen keypad appears when you activate an entry field (see [Chapter 3.4.5, "Entering Data"](#), on page 51).
- **Info line**

The "Info line" shows brief status information and error messages. It appears when an event generates a message.
- **Key parameters indicated in tab labels**

Most dialogs are divided into tabs with logically grouped parameters. The tab label expresses the content and can also contain status indicators or the set value of a key parameter.
- **Scroll bar handle**

An arrow icon that appears when you touch a scroll bar helps you to scroll in a dialog or list.

If no scrollbar handle appears, you can touch and swipe an element to scroll up and down.
- **Context-sensitive menus**

Within the entire screen display, including single parameters, you can access context-sensitive menus that provide some additional functions.

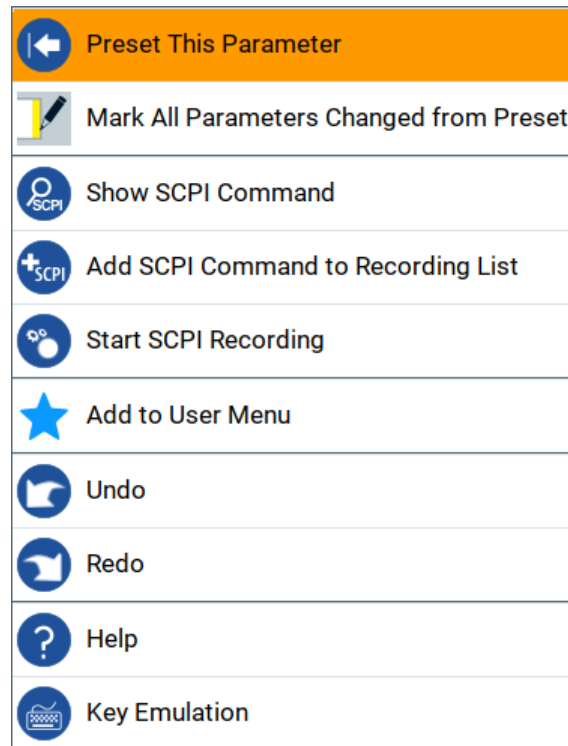

3.4.4 Accessing the Functionality

All functionalities are provided in dialog boxes as known from computer programs. You can control the instrument intuitively with the touchscreen. This section provides an overview of the accessing methods.

The instrument's functions and settings can be accessed by selecting one of the following elements:

- System and function keys on the front panel of the instrument
- Taskbar/softkeys on the touchscreen
- Context-sensitive menus for specific elements on the touchscreen, or with the rotary knob (press and hold).
- Elements on the status bar in the touchscreen
- Displayed setting on the touchscreen, that means block diagram and all settings available in dialogs.

To open a dialog box

- ▶ Perform one of the following actions:
 - Tap the required tile, and then the menu entry.
 - Tap the minimized view (button) on the taskbar.

Some of the utility keys access a dedicated dialog, too.

To minimize a dialog box

1. To return to the home screen, tap the "Home" button.
2. To switch to another dialog, press the [Next Window] button.

To close a dialog box

To close a dialog box, you have the same controls as you know from computers or devices with touchscreen.

- ▶ Perform one of the following actions:
 - Tap the "Close" icon in the upper right corner.
 - Press the [Esc] key on the front panel.
 - Drag and drop a minimized dialog from the taskbar to the tile diagram.

To select an option in a dialog box

- ▶ Tap the required option.

3.4.5 Entering Data

Some parameters have their own key on the front panel.

For data input in dialog boxes, the instrument provides on-screen keypads for entering numeric and alphanumeric values. Thus, you can always set the parameters via the touchscreen, the front panel, or an external keyboard.

Correcting an entry

1. Using the arrow keys, move the cursor to the right of the entry you want to delete.
2. Press the [Backspace] key.
3. Deletes the entry to the left of the cursor.
4. Enter your correction.

Completing the entry

- ▶ Press the [Enter] key or the rotary knob.

Aborting the entry

- ▶ Press the [Esc] key.
The dialog box closes without changing the settings.

3.4.5.1 Entering Numeric Parameters

To enter values with the on-screen keypad

For numeric settings, the instrument displays the numeric keypad. The units specified correspond to the units of the parameter.

1. Enter the numeric value.
2. Tap the unit button to complete the entry.
The unit is added to the entry.
3. If the parameter does not require a unit, confirm the entered value by pressing "Enter".

To enter values by using the front panel controls

1. Change the currently used parameter value by using the rotary knob or the [Up/Down] keys.
2. If the parameter does not require a unit, confirm the entered value by pressing the [Enter] key or any of the unit keys.
The instrument highlights the editing line to confirm the entry.

If you edit numeric data in tables, the entry field must be in edit mode: Press [Enter], or the rotary knob to activate the edit mode.

3.4.5.2 Entering Alphanumeric Parameters

If a field requires alphanumeric input, you can use the on-screen keyboard to enter letters and (special) characters.

3.4.5.3 Undo and Redo Actions

Accessed via the context-sensitive menus, "Undo" allows you to restore one or more actions on the instrument. Depending on the available memory, the "Undo" steps can restore all actions.

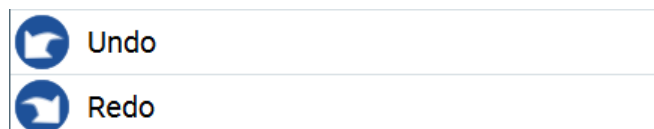

"Redo" restores a previously undone action.

3.4.6 Getting Information and Help

In some dialog boxes, graphics are included to explain the way a setting works.

For further information, you can use the following sources:

- Tooltips give the value range of the parameter.
- The context help provides functional description on a setting.
- The general help explains a dialog box, provides instructions, and general information.

To display context help

- ▶ To access a help topic, perform one of the following:
 - a) Tap and hold the parameter for which you need information and tap "Help" in the context menu.
 - b) Tap the parameter and press the [Help] key.

The "Help" dialog opens. You can browse the help for further information.

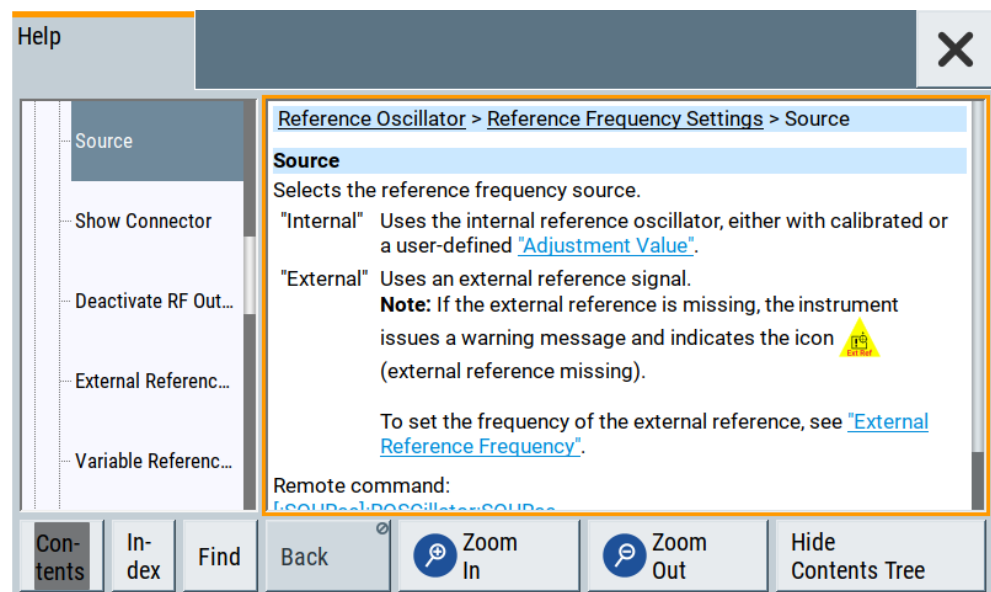

Contents of the help dialog box

The help dialog box covers two main areas:

- "Contents" - contains a table of help contents
- "Topic" - contains a specific help topic

The help system also provides an "Index" and a "Find" area, and "Zoom" functions that are accessed via the corresponding buttons.

To open general help

- ▶ Press the yellow [Help] key on the front panel.

If a dialog box is opened, the help topic for the current tab is shown. Otherwise the "Contents" page appears.

Navigating in the table of contents and in the help topics

1. To move through the displayed contents entries, tap on an entry and scroll or use a connected mouse or the [Up/Down] keys.
Entries with a plus sign contain further entries.
2. To display a help topic, tap on the topic name or double-click the topic name or press the [Enter] key.
3. To follow a cross-reference, tap on the link text.
4. To return to the previous page, select "Back".
This function scrolls back all steps you have performed before.
5. Use the "scroll bars" to shift the visible section of content shown.
6. To maximize the "Topics" area, tap the "Hide Contents Tree" button to hide the contents tree.

Using the index

1. Select the "Index" button.
2. Enter the first characters of the topic you are interested in.
The entries starting with these characters are displayed.
3. Tap on the index entry.
The corresponding help topic is displayed.

3.4.7 Remote Control

In addition to working with the R&S SMB100B interactively, located directly at the instrument, it is also possible to operate and control it from a remote PC.

The R&S SMB100B supports various methods for remote control:

- Connecting the instrument to a LAN (see [Chapter 3.1.7, "Connecting to LAN"](#), on page 27)
- Using the LXI browser interface in a LAN
- Connecting a PC via the IEC-bus (IEEE 488) interface
- Remote control via the USB interface



For remote control over LAN or USB, you can use the R&S VISA (Virtual Instrument Software Architecture) library provided for download at the Rohde & Schwarz website <http://www.rohde-schwarz.com/rsvisa>.

How to configure the remote control interfaces is described in [Chapter 11, "Network Operation and Remote Control"](#), on page 257.

3.4.8 Remote Operation over VNC

The VNC is an application which can be used to access and control the instrument from a remote computer through a LAN connection. While the instrument is in operation, the instrument screen contents are displayed on the remote computer, and VNC provides access to all applications, files, and network resources of the instrument. Thus, remote operation of the instrument is possible.



Instrument control from a remote computer

To access the basic utility functions of the R&S SMB100B, perform a right mouse click the block diagram and select "Key Emulation".

A key panel to the right of the block diagram gives access to the utility functions provided by the front panel keys.

The VNC is an add-on program, included in operating system Linux/Unix, and available as a free-of-charge download on the internet.

For more information, refer to [Chapter 11.9, "Operating the R&S SMB100B Remotely via VNC"](#), on page 310.

4 RF Signal Configuration

The R&S SMB100B signal generator generates RF signals with outstanding spectral purity within the frequency range from 8 kHz up to 6 GHz and with adjustable signal level over a wide range.

In addition to these real-time CW signals, you can generate RF signals from predefined lists and sweep signals that vary according to the frequency or amplitude curves.

You can also apply versatile analog modulation types with definable characteristics.

The variably adjustable output level due to the built-in attenuator, allows you to vary the RF signal level over the full level range. There are different methods to improve signal performance and to optimize the signal quality for the particular application, or to increase the accuracy and reliability of the generated RF signal.

The R&S SMB100B supports R&S NRP power sensors, e.g. to monitor the output level of the generator or to determine the level correction values for user correction lists.

Signal modes and characteristics

The R&S SMB100B generates unmodulated or analog modulated RF signals. You can output the signal in fixed mode or as a signal having periodically varying frequencies or amplitudes.

Signal modes for RF signal generation:

- Unmodulated signal
Generates an unmodulated continuous wave (CW) of constant frequency and amplitude.
For information on the signal frequency and level settings and an example on how to configure a simple CW signal, see:
 - [Chapter 4.3, "RF Frequency Settings"](#), on page 59
 - [Chapter 4.4, "RF Level Settings"](#), on page 61
 - [Chapter 3.3.1, "Generating an Unmodulated Carrier"](#), on page 38
- Analog modulated signal
Modulates the signal with an analog signal and generates amplitude, phase, frequency and pulse modulation.
See [Chapter 5, "Analog Modulations"](#), on page 67.

The R&S SMB100B allows you to provide the RF signal with constant or varying frequencies and/or amplitudes at the output:

- Constant frequency and level (CW/Fixed mode)
The RF output signal has the set frequency and level.
- Varying frequency and/or level
 - Sweep mode
An RF or LF frequency and RF level sweep signal, processed continuously, step-by-step or individually and with selectable trigger modes. You can only run one sweep at a time.
 - List mode

The RF signal is based on a list of predefined frequency and level values pairs and step widths.

See [Chapter 6, "List and Sweep Mode"](#), on page 109.

4.1 Activating RF Signal Output

Per default, the RF output signal is deactivated.

To activate the RF output

1. Configure the RF signal as required.
Set, for example, the frequency and level values.
2. Activate the RF output in one of the following ways:
 - a) Select "Level > RF ON > On"
 - b) Press the [RF on/off] key at the front panel.
3. In the "Level" tile, observe the color of the "RF On" icon.
The blue color indicates that the RF output is activated.

RF State/RF ON	57
RF output impedance	57

RF State/RF ON

Activates or deactivates the RF output.

Acts as the [RF on/off] key.

Remote command:

`:OUTPut<hw>[:STATe]` on page 356

RF output impedance

You can query the impedance of the RF output.

Remote command:

`:OUTPut<hw>:IMPedance?` on page 356

4.2 How to Set the Frequency and Level

The simplest form of the RF signal is a continuous wave (CW) of constant frequency and amplitude. The RF signal is defined by its frequency, level and phase.

- ▶ Use one of the following:
 - "Status Bar > Frequency and Level"
 - "Frequency panel > Frequency"
 - "Level panel > Level"
 - "Frequency panel > Frequency > Phase"

- On the front panel, press the [Freq] or the [Level] key.

Current frequency and level values are indicated in the "Status bar" so that you can see them at a glance. Values displayed in the status bar and in the "Frequency/Level" dialogs can deviate from each other.

See ["RF frequency and level display with a downstream instrument"](#) on page 58.

RF frequency and level display with a downstream instrument

If your test setup includes a downstream instrument, you can enter the parameter of the downstream instrument in the frequency or level settings dialog of the R&S SMB100B. Examples of downstream instruments are mixers, frequency multipliers, amplifiers or attenuators and of their corresponding major parameters offset, multiplier, amplitude. The R&S SMB100B generates the signal without the downstream parameters, but considers all additional parameters concerning the frequency and level.

Example parameters that affect the frequency and level:

- Frequency offset
- Multiplication factor
- User correction

Any of these cases are indicated by a dedicated icon, displayed in the "Frequency" or "Level" tile, depending on the affected parameter.

[Figure 4-1](#) illustrates the calculation of the "Frequency" and "Level" values, displayed in the status bar.

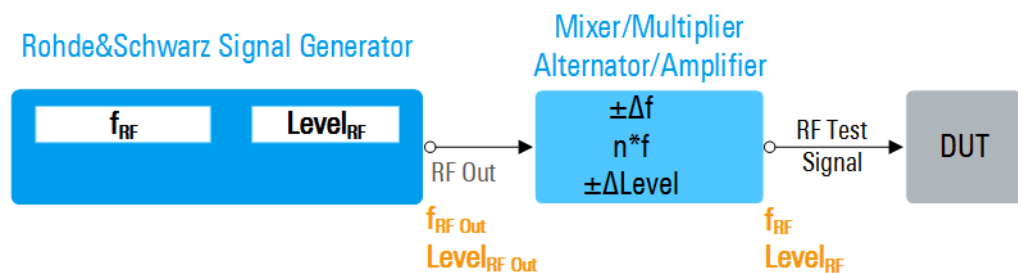

Figure 4-1: Frequency and Level display vs frequency and level at the RF output

f_{RF} , $Level_{RF}$	= Frequency and level ("Status bar > Frequency and Level") at the output of the downstream instrument, see also Calculation of f_{RF} and $Level_{RF}$
$f_{RF\ Out}$, $Level_{RF\ Out}$	= Frequency and level at the output connector [RF] ("RF > RF Frequency > Frequency" and "RF > RF Level > Amplitude")
$n*f$	= Multiplication factor ("RF > RF Frequency > Multiplier")
Δf	= Frequency offset ("RF > RF Frequency > Offset")
$\Delta Level$	= Power offset ("RF > RF Level > Offset")

Calculation of f_{RF} and $Level_{RF}$

- $f_{RF} = n * f_{RF\ Out} + \Delta f$
- $Level_{RF} = Level_{RF\ Out} + \Delta Level$

4.3 RF Frequency Settings

Access:

1. Select "Frequency" > "RF Frequency".

RF Frequency		Phase	✕
Frequency			
3.000 000 000 000 GHz			
Offset		Multiplier	
10.000 000 000 MHz		2.000	
User Variation			
Variation Active		Variation Step	
<input type="checkbox"/>		1.000 000 000 MHz	

2. Observe the information on the home screen, "Frequency" tile.

Frequency	
Offset: 10.000 MHz	
Multiplier: 2.000	
Ref Out: 10 MHz	
Δ Phase: 180.00 deg	
Int Ref	Freq Offs

The "Frequency" tile indicates the reference frequency, current frequency offset and multiplier values, and phase offset value.

In the "RF Frequency" dialog, you can configure:

- RF frequency, incl. an offset or multiplication factor of a downstream instrument
- The step size for varying the frequency with the rotary knob.

The remote commands required to define the settings are described in [Chapter 12.14.3, "SOURCE:FREQUENCY Subsystem"](#), on page 412.

Settings

Frequency.....	60
Offset.....	60
Multiplier.....	60
User Variation.....	61
L Variation Active.....	61
L Variation Step.....	61

Frequency

Sets the RF frequency.

This frequency is output at the RF connector. It does not consider an [Offset](#) or multiplication factor ([Multiplier](#)).

See "[RF frequency and level display with a downstream instrument](#)" on page 58.

Note: Suppressed values in the status bar

For security concerns or certain operating modes, you can hide the frequency and level display in the status bar.

- *********

The display has been disabled for security reasons.

See:

- [Annotation Frequency](#)
- [Annotation Amplitude](#)

- 

The display is disabled when list mode is running, see [Chapter 6, "List and Sweep Mode"](#), on page 109.

Remote command:

[\[:SOURce<hw>\]:FREQuency\[:CW|FIXed\]](#) on page 414

Offset

Sets the frequency offset.

This value represents the frequency shift of a downstream instrument, like for example a mixer.

The "Frequency" value displayed in the status bar is the resulting frequency, as it is at the output of the downstream instrument. The frequency at the R&S SMB100B RF output is not changed.

See "[RF frequency and level display with a downstream instrument](#)" on page 58.

Remote command:

[\[:SOURce<hw>\]:FREQuency:OFFSet](#) on page 415

Multiplier

Sets the multiplication factor for the RF frequency.

This value represents the multiplication factor of a downstream instrument, as for example a multiplier. You can also assign a negative multiplication factor, for example -1.0 to support frequency converters working in the reverse frequency position.

The "Frequency" value displayed in the status bar is the resulting frequency, as it is at the output of the downstream instrument. The frequency at the R&S SMB100B RF output is not changed.

See "[RF frequency and level display with a downstream instrument](#)" on page 58.

Remote command:

[\[:SOURce<hw>\]:FREQuency:MULTiplier](#) on page 415

User Variation

Defines and activates a user-defined step width for varying the RF frequency or RF level with the rotary knob.

If disabled, the step width varies in steps of one unit at the cursor position.

Variation Active ← User Variation

Activates the set user-defined step width.

Remote command:

[:SOURce<hw>] :FREQuency:STEP:MODE on page 417

[:SOURce<hw>] :POWer:STEP:MODE on page 455

Variation Step ← User Variation

Sets the user-defined step width.

Remote command:

[:SOURce<hw>] :FREQuency:STEP [:INCRe ment] on page 418

[:SOURce<hw>] :POWer:STEP [:INCRe ment] on page 455

4.4 RF Level Settings

Access:

1. Select "Level" > "RF Level".

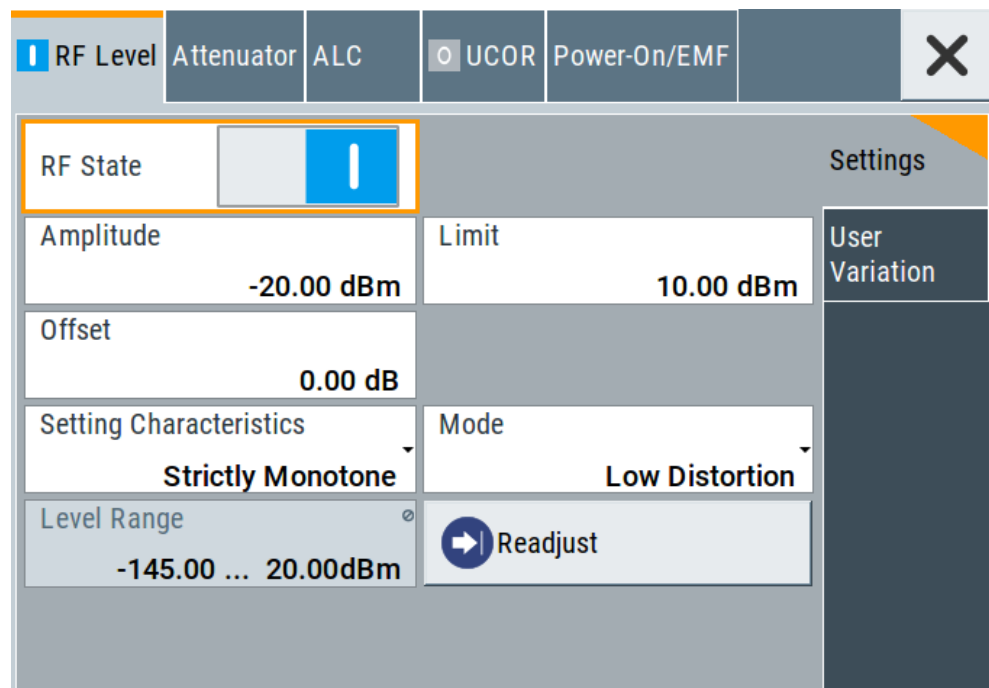

In the "RF Level" dialog, you can configure the offset-free level, the level limit, and the step width for varying the level with the rotary knob.

2. Select "User Variation" to set the step width to be used when setting the RF level using the rotary knob.

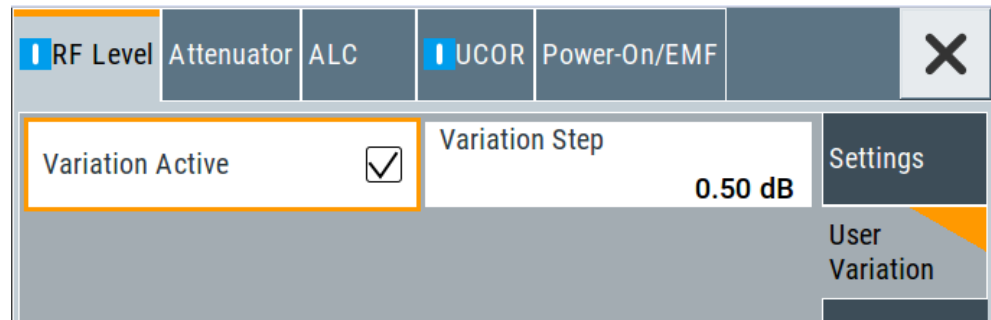

3. Observe the information on the home screen, "Level" tile.



The "Level" tile indicates the level limit, the user correction status and current correction value, current setting characteristics incl. mode.

The remote commands required to define the settings are described in [Chapter 12.14.10, "SOURCE:POWER Subsystem"](#), on page 449.

Settings

RF State/RF ON.....	62
Amplitude.....	63
Limit	63
Offset	63
Setting Characteristics	64
Mode	64
Level Range	64
Readjust.....	65
User Variation.....	65
└ Variation Active.....	65
└ Variation Step.....	65

RF State/RF ON

Activates or deactivates the RF output.

Acts as the [RF on/off] key.

Remote command:

:OUTPut<hw> [: STATE] on page 356

Amplitude

Sets the level of the RF signal.

The value is offset-free and corresponds to the level at the RF connector.

See ["RF frequency and level display with a downstream instrument"](#) on page 58.

Note: Suppressed values in the status bar

For security concerns or certain operating modes, you can hide the frequency and level display in the status bar.

- *********

The display has been disabled for security reasons.

See:

- [Annotation Frequency](#)
- [Annotation Amplitude](#)

- 

The display is disabled when list mode is running, see [Chapter 6, "List and Sweep Mode"](#), on page 109.

Remote command:

`[:SOURce<hw>] :POWER:POWER` on page 454

Note: The SCPI command `[:SOURce<hw>] :POWER [:LEVel] [:IMMediate] [:AMPLitude]` sets the level of the "Level" display.

This means, the level containing offset.

Limit

Sets an upper limit for the RF output power.

You can use this value to protect your DUT from damage due to high input power. If you enter an RF level above this value, the instrument limits the output power to this specified value, and generates the warning message:

"Pep value greater than the defined limit." However, the level indication in the status bar is not affected.

The setting is not affected by an instrument preset ([Preset] key or *RST) and the "Save/Recall" function. It is reset only by factory preset.

Remote command:

`[:SOURce<hw>] :POWER:LIMit [:AMPLitude]` on page 452

Offset

Sets a level offset.

This value represents the level shift of a downstream instrument, like, for example, an attenuator or an amplifier.

The "Level" value displayed in the status bar is the resulting level, as it is at the output of the downstream instrument. The level at the R&S SMB100B RF output is not changed.

See ["RF frequency and level display with a downstream instrument"](#) on page 58.

Remote command:

`[:SOURce<hw>] :POWER [:LEVel] [:IMMediate] :OFFSet` on page 456

Setting Characteristics

Selects additional quality characteristics to optimize the behavior of the RF signal level for the specific application.

- "Auto" Sets the RF output level automatically according to the selected mode.
In this mode, the instrument provides the highest dynamic range and fastest setting times, as specified in the data sheet.
The RF signal is shortly blanked when the step attenuator is switching.
- "Uninterrupted" Suppresses blanking at level transitions. Frequency transitions can lead to an RF level blanking due to hardware specific switching points.
This mode reduces the dynamic range of the instrument. The step attenuator is fixed.
- "Strictly Monotone" Executes signal level changes monotonically increasing or decreasing.
The setting makes sure that increasing the level value exclusively results in an increased output level, and vice versa.
All electronic switches, which might affect the monotonicity are fixed.
The operation mode is useful for applications using level searching algorithms which rely on a strictly monotonous behavior.
- "Constant-VSWR" Suppresses output impedance variations at the RF output connector, due to changed level settings.
- "User" Indicates that a setting has been modified in the expert mode. The expert mode is a protected function, that requires protection level 2 password.

Remote command:

`[:SOURce<hw>] :POWer:LBEHaviour` on page 452

Mode

Allows you to optimize the RF output signal for applications, where improved harmonic distortion or improved wideband noise is required.

- "Normal" Generates an RF output signal with high signal to noise ratio as well as low distortion, according to the data sheet.
- "Low Noise" Optimizes the signal to noise ratio.
- "Low Distortion" Reduces distortion (harmonics) of the RF signal to a minimum.

Remote command:

`[:SOURce<hw>] :POWer:LMODe` on page 453

Level Range

Shows the interruption-free range of the level that you can use in the currently selected mode.

Remote command:

[:SOURce<hw>] :POWer:RANGe:LOWer? on page 457

[:SOURce<hw>] :POWer:RANGe:UPPer? on page 457

Readjust

Recalculates and adjusts the internal switch positions of the RF chain according to the current level.

Remote command:

[:SOURce<hw>] :POWer:ALC:SONCe on page 451

User Variation

Defines and activates a user-defined step width for varying the RF frequency or RF level with the rotary knob.

If disabled, the step width varies in steps of one unit at the cursor position.

Variation Active ← User Variation

Activates the set user-defined step width.

Remote command:

[:SOURce<hw>] :FREQuency:STEP:MODE on page 417

[:SOURce<hw>] :POWer:STEP:MODE on page 455

Variation Step ← User Variation

Sets the user-defined step width.

Remote command:

[:SOURce<hw>] :FREQuency:STEP [:INCReMENT] on page 418

[:SOURce<hw>] :POWer:STEP [:INCReMENT] on page 455

4.5 RF Phase Settings

The phase in sinusoidal signals defines the initial angle at its origin.

Access:

1. Select "Frequency" > "Phase".

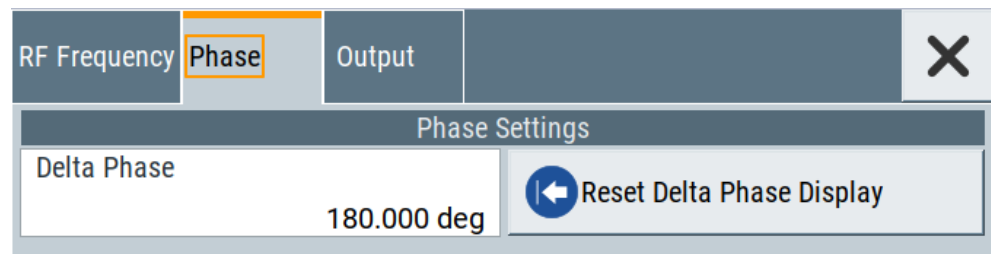

In the "Phase" tab, you can determine the delta phase value and reset the phase to this reference.

2. Observe the information on the home screen, "Frequency" tile.

The "Frequency" tile indicates used reference frequency, current frequency offset and multiplier values, and the delta phase value.

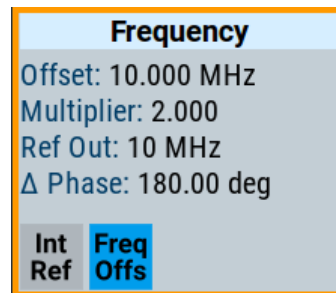

The remote commands required to define the settings are described in [Chapter 12.14.9, "SOURce:PHASe Subsystem"](#), on page 449.

Settings

Delta Phase	66
Reset Delta Phase Display	66

Delta Phase

Sets the phase of the RF signal.

The current phase of the signal is used as the reference.

Remote command:

[:SOURce<hw>] : PHASe on page 449

Reset Delta Phase Display

Adopts the selected "Delta Phase" value as the current value, and resets delta phase to 0 degrees.

Remote command:

[:SOURce<hw>] : PHASe:REFerence on page 449

5 Analog Modulations

The R&S SMB100B supports AM (amplitude modulation), FM (frequency modulation), Φ M (phase modulation (PhiM)), and also PULM (pulse modulation). It generates low frequency signals (LF) as sine, triangle, trapezoidal or square (pulse) waveform, that can be output and further processed by a downstream instrument.

Option: R&S SMBB-B5, Stereo/RDS-Coder enables generation of stereo-modulated RF signals.

5.1 Required Options

R&S SMB100B base unit equipped with the following options:

- Option frequency (R&S SMBB-B10x)
- Option Stereo/RDS-Coder (R&S SMBB-B5)
- Option pulse modulator (R&S SMBB-K22)
- Option pulse generator (R&S SMBB-K23)
(supports generation of single and double pulse signals)
- Option multi-function generator (R&S SMBB-K24)
- Option pulse train generator (R&S SMBB-K27)
(requires R&S SMBB-K23)
- Option AM/FM/PhiM (R&S SMBB-K720)

For more information, see data sheet.

5.2 Modulation Types and Signal Sources

Radio transmitters do not transmit an audio signal directly. Instead, they modulate the audio signal onto a continuous wave (CW) carrier with much higher frequency.

A CW carrier has a sinusoidal waveform with constant amplitude and constant frequency. Modulating a signal onto the carrier means varying a property of the carrier according to the modulating signal. The three basic modulation types FM, AM and PhiM for example, vary one property of the carrier proportional to the instantaneous amplitude of the modulating signal.

Signal sources

If fully equipped, the R&S SMB100B modulates signals from the following sources:

- **Internal modulation source**
 - *Two LF generators*
Each of the LF generators provides a modulation signal with sine, pulse, triangle or trapezoid shape.
 - *Noise generator*

The noise generator supplies white noise with selectable bandwidth and distribution.

- *High-performance pulse generator*
Generates single and double pulse, or pulse train signals.

- **External modulation source**

- Amplitude, frequency or phase modulation signals are input at the Mod. Ext. connector.
- Pulse modulation signals, at the Pulse Ext. connector.
- Stereo modulation signals, at the Stereo L/R and S/P Dif connector.

Signal output

You can perform AM, FM and PhiM with the signal of any of the provided sources. Moreover, you can combine two modulation signals and generate a two-tone signal. Regardless of the signal source, the generated signal can be output for further processing in a downstream instrument.

Current configuration is indicated in the "Analog Modulations > Overview" dialog; the output signal routing can be changed, too.

Input and output connectors

Direction	Modulation	Connector	Required option
Output	Pulse modulation from internal signal Loop through of pulse signal from Pulse Ext.	Pulse Video	R&S SMBB-K22/-K23
	All analog modulations Marks the valid level and frequency	Signal Valid	
	LF generator	LF	
Input	AM, FM, PhiM	Mod. Ext. **)	R&S SMBB-K720
	Stereo modulation from external source	Stereo L/R	R&S SMBB-B5
	Pulse modulation from external source*) Or External trigger or gate signal*)	Pulse Ext.**)	R&S SMBB-K22

- *) External trigger signal and external signal for the pulse modulation cannot be used simultaneously, because these signals are expected at the same connector Pulse Ext.. Signal polarity and impedance are the same for both signals.
- **) The external modulation signal must have a voltage of $U_S = 1\text{ V}$ ($U_{EFF} = 0.707\text{ V}$) to achieve the displayed modulation depth and range.
Note that the input voltage does not exceed 1 V, otherwise modulation distortions can occur.

For more information, see data sheet.

Interactions and characteristics

- FM and PhiM modulations exclude each other and cannot be performed simultaneously.
- In sweep mode, LF frequency sweep is possible.
- The settings of the modulation signal affect all analog modulations that use an internal modulation source.
- You can feed an external LF signal in each of the two paths.

For more information, see data sheet.

5.3 Activating Analog Modulations

- ▶ Use one of the following:
 - Select "Modulation > Amplitude Modulation/Frequency Modulation/Phase Modulation > State > ON".
 - Select "Modulation > MOD ON".
 - Press the [Mod on/off] key.

[Mod on/off]

Activate one or more analog modulations and press the [Mod on/off] key to toggle the state of them all.

Pressing the key again restores the status that was active before the last switch-off.

Remote command:

`[:SOURce<hw>] :MODulation [:ALL] [:STATe]` on page 371

5.4 Modulation Settings

Access:

- ▶ Select "Modulation" > "Modulation Sources".

The "Modulation" dialog contains all functions and settings to configure the analog modulations, the LF signal sources for performing a modulation, and the LF signal output.

The remote commands required to define these settings are described in:

- [Chapter 12.14.1.2, "SOURce:AM Subsystem"](#), on page 372
- [Chapter 12.14.1.3, "SOURce:FM Subsystem"](#), on page 376
- [Chapter 12.14.1.4, "SOURce:PM Subsystem"](#), on page 381
- [Chapter 12.14.1.5, "SOURce:PULM Subsystem"](#), on page 386
- [Chapter 12.14.1.6, "SOURce:STEReo Subsystem"](#), on page 397
- [Chapter 12.14.5, "SOURce:LFOutput Subsystem"](#), on page 419

5.4.1 Pulse Modulation

Option: see [Chapter 5.1, "Required Options"](#), on page 67.

Access:

- ▶ Select "Modulation" > "Pulse Modulation".

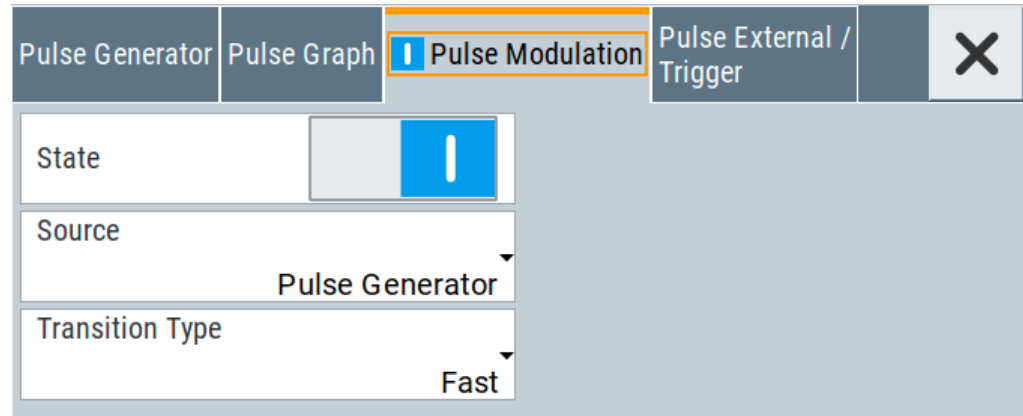

The "Pulse Modulation" dialog contains all parameters required to configure the pulse modulator and the pulse generator. It also displays the pulse signal graphically.

For an overview of the supported signals sources and related connectors, see [Chapter 5.2, "Modulation Types and Signal Sources"](#), on page 67.

The remote commands required to define these settings are described in [Chapter 12.14.1.5, "SOURce:PULM Subsystem"](#), on page 386.

Settings:

State	70
Source	70
Transition Type	71

State

Activates pulse modulation and triggers the following automatic settings:

- Pulse generator is activated.
The signal is output at the Pulse Video connector.
To deactivate the signal output, set "Pulse Generator" > [Pulse Output State](#) > "Off".

Remote command:

[\[:SOURce<hw>\]:PULM:STATe](#) on page 390

Source

Selects between the internal "Pulse Generator" or an "External" pulse signal for the modulation.

"Pulse Generator"

Selects the internal generator.

See [Pulse Generator](#).

"External"

Modulation source is fed to the input connector.

See "[Signal sources](#)" on page 67.

Remote command:

[:SOURce<hw>] :PULM:SOURce on page 390

Transition Type

Selects between "Fast" or "Smoothed" slew rate (slope).

"Fast"

Enables fast transitions with shortest rise and fall times.

"Smoothed"

Flattens the slew rate, resulting in longer rise / fall times. Use this mode if you are working with devices that are sensitive to steep slopes.

Remote command:

[:SOURce<hw>] :PULM:TTYPe on page 390

5.4.2 FM, PhiM and AM Modulation Settings

Option: R&S SMBB-K720

Access:

- ▶ Select "Modulation" > "Amplitude Modulation/Frequency Modulation/Phase Modulation".

Sources		<input checked="" type="checkbox"/> FM	<input type="checkbox"/> ΦM	<input checked="" type="checkbox"/> AM	<input type="checkbox"/> Output	Overview	✕
Path 1				Path 2			
State	<input checked="" type="checkbox"/>			State	<input checked="" type="checkbox"/>		
Source	LF Generator 1			Source	External 1		
Deviation	1.000 00 kHz			Deviation	1.000 00 kHz		
Deviation Mode	Fixed Ratio			Ratio Path 2 / Path 1	100.00 %		
Mode	High Bandwidth						

The "FM", "ΦM" and "AM" tabs contain the parameters per modulation type.

Source

State.....	72
Source.....	72
FM settings.....	73
L Deviation.....	73
L Deviation Mode.....	73
L Total Deviation.....	73
L Ratio Path2/Path1.....	73
L Mode.....	74
PhiM settings.....	74
L Deviation.....	74
L Deviation Mode.....	74
L Total Deviation.....	75
L Ratio Path2/Path1.....	75
L Mode.....	75
AM settings.....	75
L Depth.....	75
L Sensitivity.....	76
L Deviation Mode.....	76
L Total Depth.....	76
L Ratio Path2/Path1.....	76

State

Activates a modulation.

Note: Some modulations exclude each other and cannot be performed simultaneously. For more information, see data sheet.

Remote command:

[:SOURce<hw>] :AM<ch> :STATe on page 374

[:SOURce<hw>] :FM<ch> :STATe on page 378

[:SOURce<hw>] :PM<ch> :STATe on page 383

Source

Selects the LF signal source.

You can vary the signal sources for each of the modulations.

"LF Generator 1/2"

Selects one or both of the internally generated LF signals.

See [Chapter 5.4.7.1, "Source > LF Generator Settings"](#), on page 96.

"External"

Selects an externally supplied LF signal.

"Noise Generator"

Selects the internally generated noise signal.

See [Chapter 5.4.7.3, "Source > Noise Generator Settings"](#), on page 101.

Remote command:

[:SOURce<hw>] :AM<ch> :SOURce on page 374

[:SOURce<hw>] :FM<ch> :SOURce on page 379

[:SOURce<hw>] :PM<ch> :SOURce on page 383

FM settings

The following settings are dedicated to FM.

Deviation ← FM settings

Sets the frequency modulation deviation in Hz.

The maximal deviation depends on the RF frequency and the selected modulation mode (see data sheet).

Maximal possible deviation is selected automatically, if one of the following applies:

- The selected deviation is too high for the particular frequency
- The selected frequency is outside of the range where deviation is possible.

A warning message indicates this situation, too.

Remote command:

[:SOURce<hw>] :FM<ch> [:DEViation] on page 379

Deviation Mode ← FM settings

Enables you to couple the LF signal of both paths and determines the mode for fixing the total deviation.

The total deviation is the sum of both paths. When the sum is exceeded, the R&S SMB100B reports a settings conflict, but does not change the settings.

"Uncoupled" Enables you to adjust the deviation for each path independently.

"Fixed Total" Couples the deviation of both paths in per Hz. If you change the deviation of any path, the R&S SMB100B automatically adjusts the value of the other path. The sum always results in the set [Total Deviation](#).

"Fixed Ratio" Couples the deviation ratio of both paths. If you change the deviation of any path, the R&S SMB100B adjusts the value of the other path.

Remote command:

[:SOURce<hw>] :FM:DEViation:MODE on page 380

Total Deviation ← FM settings

Sets the sum of the signal deviation for path 1 and path 2 in Hz when using combined sources in [Deviation Mode > Fixed Total](#).

[Deviation](#) of both paths always sum up to the value of the total deviation.

Behavior when changing any depth settings:

- Changing the total deviation adjusts the deviation of both paths proportionally.
- Changing the deviation of one path adjusts the deviation of the other path. The sum always results in the set total deviation.

Remote command:

[:SOURce<hw>] :FM:DEViation:SUM on page 380

Ratio Path2/Path1 ← FM settings

Sets the deviation ratio (path2 to path1) in percent.

Example:

If the deviation in path1 is 10 kHz and the ratio is 50%, the deviation in path 2 is automatically set to 5 kHz.

Remote command:

`[:SOURce<hw>] :FM:RATio` on page 380

Mode ← FM settings

Selects the mode of the frequency modulation.

"High Bandwidth"

The maximum range for modulation bandwidth is available.

"Low Noise"

Phase modulation with phase noise and spurious characteristics close to CW mode. The range for modulation bandwidth and FM deviation is reduced (see data sheet).

Remote command:

`[:SOURce<hw>] :FM:MODE` on page 381

PhiM settings

The following settings are dedicated to PhiM.

Deviation ← PhiM settings

Sets the phase modulation deviation in radians or degrees.

The maximal deviation depends on the RF frequency and the selected modulation mode (see data sheet).

Maximal possible deviation is selected automatically, if one of the following applies:

- The selected deviation is too high for the particular frequency
- The selected frequency is outside of the range where deviation is possible.

A warning message indicates this situation, too.

Remote command:

`[:SOURce] :PM<ch> [:DEViation]` on page 385

Deviation Mode ← PhiM settings

Enables you to couple the LF signal of both paths and determines the mode for fixing the total deviation.

The deviation sum 2 rad at a maximum. When the sum is exceeded, the R&S SMB100B adjusts the settings automatically.

"Uncoupled" Enables you to adjust the deviation for each path independently.

"Fixed Total" Couples the deviation of both paths. If you change the deviation of any path, the R&S SMB100B automatically adjusts the value of the other path. The sum always results in the set **Total Deviation**.

"Fixed Ratio" Couples the deviation ratio of both paths. If you change the deviation of any path, the R&S SMB100B adjusts the value of the other path.

Remote command:

`[:SOURce<hw>] :PM:DEViation:MODE` on page 384

Total Deviation ← PhiM settings

In **Deviation Mode = Fixed Total**, sets the sum of the signal deviation for path 1 and path 2.

Deviation of both paths always sum up to the value of the total deviation.

Behavior when changing any depth settings:

- Changing the total deviation adjusts the deviations of both paths proportionally.
- Changing the deviation of one path adjusts the deviation of the other path. The sum always results in the set total deviation.

Remote command:

`[:SOURce<hw>] :PM:DEVIation:SUM` on page 385

Ratio Path2/Path1 ← PhiM settings

Sets the deviation ratio (path2 to path1) in per cent.

Example:

If the deviation in path1 is 10 rad and the ratio is 50%, the deviation in path 2 is automatically set to 5 rad.

Remote command:

`[:SOURce<hw>] :PM:RATio` on page 385

Mode ← PhiM settings

Selects the mode of the phase modulation.

"High Bandwidth"

The maximum range for modulation bandwidth and PhiM deviation is available.

However, phase noise increases at low frequencies, and the range of PhiM deviation is limited. This mode is suitable if you process high frequencies.

"High Deviation"

The maximum range for PhiM deviation is available.

Phase noise is improved for low frequencies compared to the default mode. The range for modulation frequency is limited (see data sheet). This mode is suitable for low modulation frequencies and/or high PhiM deviation.

"Low Noise"

Frequency modulation with phase noise and spurious characteristics close to CW mode. The range for modulation bandwidth and FM deviation is reduced (see data sheet).

Remote command:

`[:SOURce<hw>] :PM:MODE` on page 384

AM settings

The following settings are dedicated to AM.

Depth ← AM settings

Determines the depth of the modulation signal in percent.

The depth is limited by the maximum peak envelope power (PEP).

Remote command:

`[:SOURce<hw>] :AM<ch> [:DEPTH]` on page 375

Sensitivity ← **AM settings**

Sets the input sensitivity of the external modulation signal.

Remote command:

`[:SOURce<hw>] :AM<ch>:SENSitivity` on page 376

Deviation Mode ← **AM settings**

Enables you to couple the LF signal of both paths and determines the mode for fixing the total deviation.

The deviation sum of both paths is 100% in total. When the sum is exceeded, the R&S SMB100B reports a settings conflict, but does not change the settings.

- | | |
|---------------|--|
| "Uncoupled" | Enables you to adjust the deviation depth for each path independently. |
| "Fixed Total" | Couples the deviation depth of both paths in per cent. If you change the depth of any path, the R&S SMB100B automatically adjusts the value of the other path. The sum always results in the set Total Depth . |
| "Fixed Ratio" | Couples the deviation ratio of both paths. If you change the depth of any path, the R&S SMB100B adjusts the value of the other path. |

Remote command:

`[:SOURce<hw>] :AM:DEVIation:MODE` on page 375

Total Depth ← **AM settings**

Sets the sum of the signal [Depth](#) for path 1 and path 2 in per cent when using combined sources and [Deviation Mode > Fixed Total](#).

Using external LF signals, the R&S SMB100B indicates the [Sensitivity](#) per Volts for the input signal.

Provided both signal paths are turned on, the depth of both paths always sum up to the value of the total depth.

Behavior when changing any depth settings:

- Changing the total depth adjusts the depths of both paths proportionally.
- Changing the depth of one path adjusts the depth of the other path. The sum always results in the set total depth.

Remote command:

`[:SOURce<hw>] :AM:DEPTH:SUM` on page 375

Ratio Path2/Path1 ← **AM settings**

Sets the deviation ratio of the signal depth for path 2 to path 1 in per cent when using combined sources.

Using external LF signals, the R&S SMB100B indicates the [Sensitivity](#) per Volts for the input signal.

Remote command:

`[:SOURce<hw>] :AM:RATio` on page 376

5.4.3 Stereo Modulation

Option: see [Chapter 5.1, "Required Options"](#), on page 67.

Access:

- ▶ Select "Modulation" > "Stereo Modulation".

Option R&S SMBB-B5, Stereo/RDS Coder enables generation of stereo-modulated RF signals according to the standard. Beside the MPX (FM stereo multiplex) signal, also the radio traffic service ARI (Automotive Radio Information) and Radio Data System (RDS) are supported by the option.

Select an internal or external signal source. The analog [Stereo L/R] connections and the digital [S/P Dif] connection supply the signal of an external source. The LF generator acts as internal signal source.

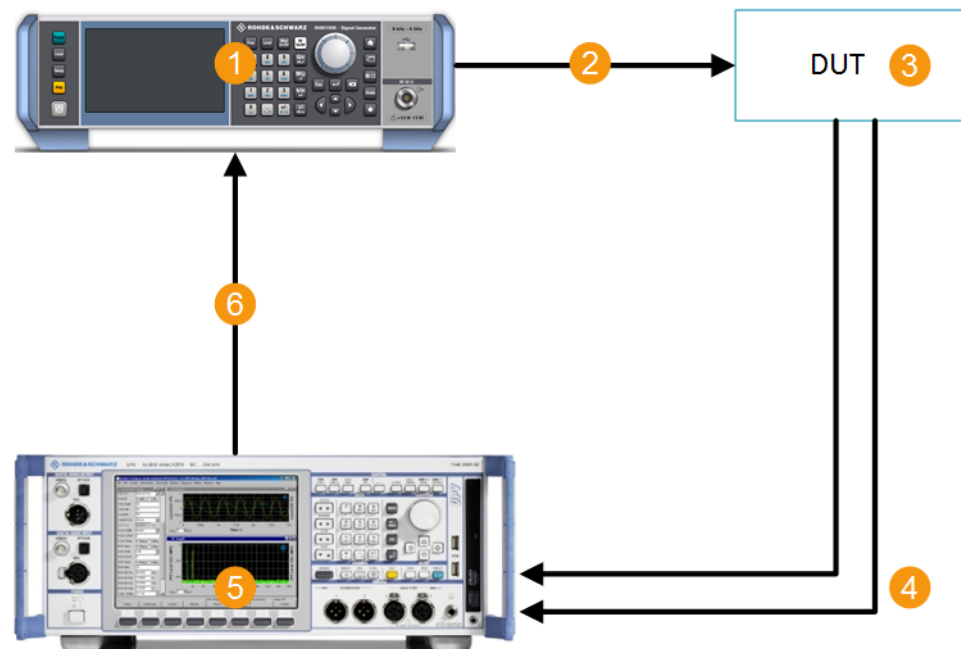

Figure 5-1: Example setup

- 1 = R&S SMB100B with Stereo/RDS Coder R&S SMBB-B5
- 2 = RF modulated test signal including ARI and RDS
- 3 = FM stereo tuner
- 4 = Analog audio signals
- 5 = Signal generation and analysis, for example with R&S®UPV Audio Analyzer
- 6 = Analog or digital audio signals

- [General Settings](#)..... 78
- [Pilot Tone](#)..... 80
- [ARI](#)..... 81
- [RDS](#)..... 83

5.4.3.1 General Settings

Access:

- ▶ Select "Modulation" > "Stereo Modulation".

The "General" tab contains the settings for creating a stereo modulation signal.

General	Pilot Tone	ARI	RDS		✕
State	<input checked="" type="checkbox"/>				
FM Deviation	40.000 kHz		Mode	Mono Left	
Audio Source	LF Gen		LF Gen Frequency	LFGen Shape	
			1.000 00 kHz	Pulse	
Preemphasis	50 µs				

Settings

State.....	78
FM Deviation.....	78
Mode.....	79
Audio Source.....	79
LF Gen Frequency	79
LF Gen Shape	79
External R/L Impedance	79
Preemphasis	80
Max Modulation Frequency	80

State

Activates stereo modulation.

Remote command:

[:SOURce] :STEReo:STATe on page 398

FM Deviation

Sets the MPX (FM stereo multiplex) deviation.

Remote command:

[:SOURce] :STEReo[:DEVIation] on page 398

Mode

Selects the mode for the audio signal.

- "Mono Left" A mono signal containing the left channel is generated/fed in.
- "Mono Right" A mono signal containing the right channel is generated/fed in.
- "Stereo R = L" A stereo signal with right and left channel is generated/fed in. The channels have the same frequency and phase.
- "Stereo R = -L" The signal on the left external audio input is used for both channels. The right channel is inverted.
- "Stereo R != L" (External source only)
A stereo signal containing different, independent right and left channels is fed in.

Remote command:

[\[:SOURCE\]:STEReo:AUDio:MODE](#) on page 399

Audio Source

Selects the source for the audio signal.

- "Off" No audio signal is provided, ARI and RDS signal can be generated separately.
- "Ext L,R" The external audio stereo signal is feed in via the analog [L] and [R] inputs.
- "Ext S/P Diff" The external audio signal is feed in via the digital [S/P Dif] input.
- "LF Gen" The audio stereo signal is generated by the internal LF1 generator.

Remote command:

[\[:SOURCE\]:STEReo:SOURce](#) on page 399

LF Gen Frequency

If "Audio Source = LF Gen", sets the frequency of the LF generator signal.

This setting affects all analog modulations which use the LF1 generator as the internal modulation source.

Remote command:

[\[:SOURCE\]:LFOutput<ch>:FREQuency](#) on page 422

LF Gen Shape

If "Audio Source = LF Gen", selects the shape of the LF generator signal.

This setting affects all analog modulations which use the LF1 generator as the internal modulation source.

Remote command:

[\[:SOURCE<hw>\]:LFOutput<ch>:SHAPE](#) on page 426

External R/L Impedance

(External analog audio signal input only)

Selects the input impedance for the external analog audio signal inputs [L] and [R].

Remote command:

[\[:SOURCE\]:STEReo:EXTernal:IMPedance](#) on page 400

Preemphasis

Activates and sets the preemphasis used for signal generation.

Preemphasis increases the high-frequency portions of the signal in the level before the FM modulator is reached.

Remote command:

[\[:SOURce\]:STEReo:AUDio:PREemphasis:STATe](#) on page 401

[\[:SOURce\]:STEReo:AUDio:PREemphasis](#) on page 400

Max Modulation Frequency

Sets the maximum modulation frequency.

This parameter is valid/required only when preemphasis has been activated and an external modulation source is used.

For sinewave signals with full modulation, preemphasis can lead to an internal overload of the modulator. The MMF parameter reduces the internal full modulation, so that sinewave signals with nominal voltage can be transmitted with low distortion, even with active preemphasis up to the set frequency. This procedure reduces the S/N ratio at the set MMF, based on the level increase of the preemphasis.

The default value of this parameter works for normal modulation signals, such as voice or music, because the amplitude of the high-frequency portions of these signals normally decreases substantially.

Remote command:

[\[:SOURce\]:STEReo:MMF](#) on page 400

5.4.3.2 Pilot Tone

Access:

- ▶ Select "Modulation" > "Stereo Modulation > Pilot Tone".

General	Pilot Tone	ARI	RDS	
✕				
Pilot State		<input checked="" type="checkbox"/>		
Pilot Deviation		6.750 kHz		
Pilot Phase		0.0 deg		

The pilot tone supports the transmission of a signal to the receiver through adding a constant single-frequency signal. The signal receiver accepts the incoming signal only after the pilot tone is confirmed.

Settings

Pilot State	81
Pilot Deviation	81
Pilot Phase	81

Pilot State

Activates the pilot tone generation.

Remote command:

`[:SOURce] :STEReo:PILot:STATe` on page 401

Pilot Deviation

Sets the deviation of the pilot tone.

Remote command:

`[:SOURce] :STEReo:PILot[:DEViation]` on page 401

Pilot Phase

Sets the phase of the pilot tone in relation to the 38 kHz carrier signal of the receiver. For a correct demodulation, the pilot tone must be in phase with the 38 kHz carrier.

Remote command:

`[:SOURce] :STEReo:PILot:PHASe` on page 401

5.4.3.3 ARI

Access:

- ▶ Select "Modulation" > "Stereo Modulation > ARI".

General	Pilot Tone	ARI	RDS
✕			
ARI State		<input checked="" type="checkbox"/>	
ARI Deviation		3.500 kHz	
ARI Identification		BK+DK	
ARI BK		B	

ARI (Automotive Radio Information) indicates the presence of traffic information in FM radio broadcasts.

Settings

ARI State	82
ARI Deviation	82
ARI Identification	82
ARI BK	82

ARI State

Activates the ARI signal generation. ARI signals can be generated simultaneously with MPX (FM stereo multiplex) and RDS signals.

Remote command:

[\[:SOURCE\]:STEReo:ARI:STATe](#) on page 402

ARI Deviation

Sets the frequency deviation of the ARI subcarrier signal.

Remote command:

[\[:SOURCE\]:STEReo:ARI\[:DEVIation\]](#) on page 402

ARI Identification

Selects the generated identifiers of the ARI signal.

DK and BK are abbreviations of the German words Durchsagekennung and Bereichskennung.

"Off"	Only the 57 kHz subcarrier is generated. It marks the stations which broadcast traffic programs and enables the receiver to recognize the frequency as being ARI-capable.
"DK"	The message identification is generated in addition (low-frequency 30% AM). It signalizes that a traffic message is broadcasted.
"BK"	The area identification is generated in addition (60% AM). This code is used to identify the geographical region covered by the radio station. The specific code is selected below.
"DK+BK"	The area and message identification are generated in addition to the subcarrier.

Remote command:

[\[:SOURCE\]:STEReo:ARI:TYPE:STATe](#) on page 402

[\[:SOURCE\]:STEReo:ARI:TYPE](#) on page 402

ARI BK

Selects the specific area identification (BK) code of the ARI signal. The six letters (six different frequencies) identify a specific region in each country.

Remote command:

[\[:SOURCE\]:STEReo:ARI:BK\[:CODE\]](#) on page 403

5.4.3.4 RDS

Access:

- ▶ Select "Modulation" > "Stereo Modulation > RDS".

The screenshot shows a settings window with tabs for 'General', 'Pilot Tone', 'ARI', and 'RDS'. The 'RDS' tab is active. Below the tabs, there are several settings: 'RDS State' is a toggle switch currently turned on; 'RDS Deviation' is a text field containing '2.000 kHz'; 'RDS Data Set' is a dropdown menu currently showing 'DS2'; 'Program Service Name' and 'Program Identification' are text input fields, both currently empty; 'Traffic Program' and 'Traffic Announcement' are toggle switches, both currently turned on.

The RDS (Radio Data System) is configured in the RDS settings section. RDS is a communication protocol standard from the European Broadcasting Union for sending digital information embedded in conventional FM radio broadcasts. The RDS system standardizes several types of transmitted information, including time, track/artist info and station identification.

Settings

RDS State	83
RDS Deviation	83
RDS Data Set	84
Program Service Name	84
Program Identification	84
Traffic Program	84
Traffic Announcement	85

RDS State

Activates the RDS signal generation. RDS signals can be generated simultaneously with MPX (FM stereo multiplex) and ARI signals.

Remote command:

[:SOURce] :STEReo:RDS:STATe on page 403

RDS Deviation

Sets the deviation of the RDS subcarrier.

Remote command:

[\[:SOURce\]:STEReo:RDS\[:DEVIation\]](#) on page 403

RDS Data Set

Selects the data set used in the RDS signal. Five data sets are provided on the instrument. The values of the data sets can be defined via remote control (command `SOURce:STEReo:DIRect`).

Each of these data sets contains predefined values for:

- PI (program identification, identifies the broadcast station)
- PS or scrolling PS (program service name, represents the station identity name)
- TP (traffic program, mark stations with regular traffic programs)
- TA (traffic announcement, marks the start of a traffic program)
- PTY (program type, predefined genres of broadcasting programs, e.g. news)
- PTYN (program type name)
- DI (decoder information)
- MS (music/speech)
- CT (clock time, used for synchronization)

The following values are empty:

- RT (radio text, two text blocks with 64 symbols each)
- AF (alternative frequencies, maximum of five lists with 25 frequencies each, enables the receiver to retune to a different frequency providing the same station when the first signal becomes too weak)
- TMC (traffic message channel)
- EON (enhanced other networks, eight PS with five EON AF lists each, enables the receiver to tune into these stations automatically if traffic programs are broadcasted)

The program identification and the program service name of the selected data set are indicated in the menu.

Remote command:

[\[:SOURce\]:STEReo:RDS:DATaset](#) on page 404

Program Service Name

Indicates the RDS program service name.

Remote command:

[\[:SOURce\]:STEReo:DIRect](#) on page 398

Program Identification

Indicates the RDS program identification.

Remote command:

[\[:SOURce\]:STEReo:DIRect](#) on page 398

Traffic Program

Activates the RDS traffic program (TP function). The receiver can recognize a frequency as being capable of traffic information only if the TP function is active.

Remote command:

[\[:SOURce\]:STEReo:RDS:TRAFfic:PROGram\[:STATe\]](#) on page 404

Traffic Announcement

Activates the RDS traffic announcement (TA function). If activated, the receiver switches from the current status, e.g. playing a CD, to the receive mode and enables the broadcast of a traffic announcement. The TP state has to be on.

Remote command:

`[:SOURCE] :STEReo:RDS:TRAFfic:ANNouncement [:STATE]` on page 404

5.4.4 Pulse Generator

Option: see [Chapter 5.1, "Required Options"](#), on page 67.

Access:

- ▶ Select "Modulation" > "Pulse Modulation > Pulse Generator".

Pulse Generator		Pulse Graph	Pulse Modulation	Pulse External / Trigger	Close
Pulse Mode	Double	Trigger Mode	Auto	General	
Pulse Period	10.000 µs	Pulse Width	2.000 µs		
Double Pulse Delay	3.000 µs	Double Pulse Width	3.000 µs		
Pulse Output State	<input checked="" type="checkbox"/>	Pulse Output Polarity	Normal		
Show Connector ...					

The "Pulse Generator" tab contains the settings for creating the pulse modulation signal internally.

- [Pulse Generator > General Settings](#)..... 86
- [Pulse Generator > Pulse Train Settings](#)..... 88
- [Import/Export List Files](#)..... 91

5.4.4.1 Pulse Generator > General Settings

Access:

- ▶ Select "Modulation" > "Pulse Modulation > Pulse Generator".

Settings

Pulse Mode.....	86
Trigger Mode.....	86
Pulse Period.....	87
Pulse Width.....	87
Double Pulse Width.....	87
Pulse Delay.....	87
Double Pulse Delay.....	87
Pulse Output State.....	87
Show Connector.....	87
Pulse Output Polarity.....	87
Execute Single Trigger.....	87

Pulse Mode

Sets the operating mode of the pulse generator. Depending on the selection, the instrument displays the associated parameters.

"Single"	Generates a single pulse in one pulse period.
"Double"	Generates two pulses in one pulse period.
"Train"	Option: R&S SMBB-K27 Generates a user-defined pulse train. See Chapter 5.4.4.2, "Pulse Generator > Pulse Train Settings" , on page 88.

Remote command:

[:SOURce<hw>] :PULM:MODE on page 387

Trigger Mode

Selects between continuous triggering or triggering initiated by a trigger event from an external signal.

See also ["Input and output connectors"](#) on page 68.

"Auto"	Generates the internal modulation signal continuously.
"Single"	The pulse generator is triggered by an internal trigger event, initiated with Execute Single Trigger . The pulse signal is generated once.
"Ext Single"	Generates a single pulse signal, triggered by an external signal.
"Ext Triggered"	Generates the pulse signal each time an external trigger event occurs.
"Ext Gated"	Generates the signal triggered by an external gate signal.

Remote command:

[:SOURce<hw>] :PULM:TRIGger:MODE on page 388

Pulse Period

Sets the repetition rate of the generated pulse signal.

Remote command:

[\[:SOURce<hw>\]:PULM:PERiod](#) on page 388

Pulse Width

Sets the pulse duration of the generated pulse signal.

Note: The pulse width must be at least 20 ns less than the set pulse period.

Remote command:

[\[:SOURce<hw>\]:PULM:WIDTH](#) on page 389

Double Pulse Width

Sets the width of the second pulse.

Remote command:

[\[:SOURce<hw>\]:PULM:DOUBLE:WIDTH](#) on page 389

Pulse Delay

Sets the pulse delay. The pulse delay determines the time that elapses after a trigger event before pulse modulation starts. The pulse delay is not effective for double pulse generation.

Remote command:

[\[:SOURce<hw>\]:PULM:DELay](#) on page 389

Double Pulse Delay

Sets the delay from the start of the first pulse to the start of the second pulse.

Remote command:

[\[:SOURce<hw>\]:PULM:DOUBLE:DELay](#) on page 389

Pulse Output State

Activates the output of the pulse modulation signal.

Remote command:

[\[:SOURce<hw>\]:PGENerator:OUTPut\[:STATe\]](#) on page 448

**Show Connector**

Accesses a dialog that displays the physical location of the selected connector on the front/rear panel of the instrument.

Pulse Output Polarity

Sets the polarity of the pulse output signal.

Remote command:

[\[:SOURce<hw>\]:PGENerator:OUTPut:POLarity](#) on page 448

Execute Single Trigger

If "Trigger Mode = Single", initiates a single pulse sequence manually.

Remote command:

[\[:SOURce\]:PULM\[:INTernal\]\[:TRAIIn\]:TRIGger:IMMediate](#) on page 388

5.4.4.2 Pulse Generator > Pulse Train Settings

Option: see [Chapter 5.1, "Required Options"](#), on page 67.

Access:

1. Select "Modulation" > "Pulse Modulation > Pulse Generator" > **"Pulse Mode = Train"**.

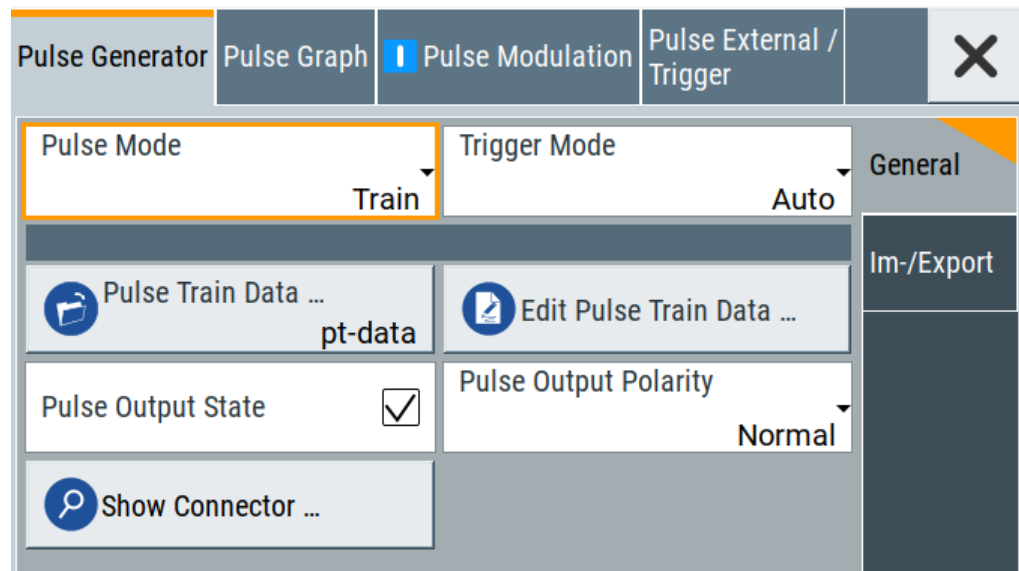

2. Select "Pulse Train Data".
3. Select an existing file or select "New" to create one.
4. Define the filename.
Select "Edit Pulse Train Data", if the file is empty or to control and change the values.
5. In the "Edit Pulse Train Data" dialog, enter the pulse on/off times and pulse repetition values.
6. Select "Save".

A pulse train is a sequence of pulses with user-defined repetition, and pulse on and off times. Once defined, pulse train settings can be saved in a file. The filename is user-definable; the file extension (*.pulstrn) is assigned automatically. When a file is selected, the filename is indicated.

Possible ways to configure a pulse train

You can configure a pulse train in the following ways:

- **Internally**
 - Use the built-in editor table editor, see in the "Pulse Generator > Pulse Train" dialog.

Once defined, pulse train settings can be saved in a file. For example, to exchange configuration between instruments or to modify the file content with an external program and reload them again.

The filename is user-definable; the file extension is `*.pulstrn`.

- Using the corresponding remote-control commands.
Note that you have to create a pulse train file first.
- **Externally**
Create a pulse train sequence as a CSV file with Microsoft Excel, with a Notepad or a similar tool, save it with the predefined extension. Transfer the file to and load it into the instrument.

Pulse train ASCII file format

Files describing pulse trains are simple files in text or comma-separated value (CSV) file format. The filename is user-definable; the file extension is `*.csv` or `*.txt`.

The file contains a list of pulse definition values, one row per pulse; a new line indicator separates the pulses. Pulses are defined with their pulse on time, pulse off time given in us and number of repetitions.

Example: Pulse train file content (*.txt file)

```
0.0001,0.0005,2
0.00025,0.0005,1
0.0001,0.0003,3
```

For file handling, use the standard functions in the "File Manager", see [Chapter 9.8, "Using the File Manager"](#), on page 205.

Settings

Pulse Train Data	89
Edit Pulse Train Data	90
Data handling keys	90
L Go To	90
L Edit	90
L Save As/Save	90
Fill	90

Pulse Train Data

Accesses the standard "File Select" function of the instrument. The provided navigation possibilities in the dialog are self-explanatory.

Pulse train files are files with predefined file extension `*.pulstrn`. When a file is selected, the dialog indicates the filename.

You can create the file internally in the table editor or externally.

- To select an existing file, select "Select List > navigate to the file *.pulstrn > Select"
- Use the general editor function to create internally new file or to edit an existing one.
- Use the standard file manager function to load externally created files to the instrument.

Remote command:

[:SOURce<hw>] :PULM:TRAI:n:CATalog? on page 392

[:SOURce<hw>] :PULM:TRAI:n:SElect on page 394

[:SOURce<hw>] :PULM:TRAI:n:DElete on page 393

Edit Pulse Train Data

Accesses the build-in table editor to define a new pulse train file or edit an existing one.

"On-Time, μ s/Off-Time, μ s"

Sets the pulse on and pulse off time.

"Count"

Sets the number of repetitions of an "On-/ Off-Time" value pair.

Pulses with "Count = 0" are ignored.

Use this method to skip value pairs temporarily, without deleting them from the table.

Remote command:

[:SOURce<hw>] :PULM:TRAI:n:ONTime on page 393

[:SOURce<hw>] :PULM:TRAI:n:OFFTime on page 393

[:SOURce<hw>] :PULM:TRAI:n:REPetition on page 393

[:SOURce<hw>] :PULM:TRAI:n:DElete on page 393

Data handling keys

Standard functions for file and data handling.



Note: Save a list only after filling both columns (frequency and level), otherwise the entries are lost.

Go To ← Data handling keys

Selects a row for editing.

Edit ← Data handling keys

Enables you to insert, or delete a row or ranges within a list, and provides access to a dialog for automatic filling.

See " Fill... " on page 90.

Save As/Save ← Data handling keys

Saves the list in a file with user-defined name and predefined file extension. To save a copy or create a file, use the "Save as" function.

Fill...

Provides parameters for filling a table automatically with user-defined values.

From 0	Range 4
Column To Fill Frequency /Hz	
Start Value 2.000 000 000 000 GHz	End Value 2.600 000 000 000 GHz
Increment Value 200.000 000 000 MHz	
<input checked="" type="checkbox"/> Fill	

To fill the table, select "Fill".

Note: Once you enter a value or fill a column, the editor automatically adds preset values in the other columns. This functionality protects against data loss, otherwise incomplete rows will be lost when saving. You can simply override these values.

"From / Range"

Defines the start line and number of lines to be filled.

"Column To Fill"

Selects, if the column is filled up with frequencies in Hz, levels in dBm or dwell times in s.

"Start Value / End Value"

Sets the start value for frequency, level or dwell time. The end value is read only and depends on the increment value and the range.

"Increment Value"

Determines the step size.

"Fill"

Fills the column specified in "Column To fill".

5.4.4.3 Import/Export List Files

Access:

- Select one of the following:
 - "Sweep" > "List mode".
 - "Level" > "User Correction".
 - "Modulation > Pulse Modulation > Pulse Generator > Pulse Mode = Train".

2. Select "Import/Export".

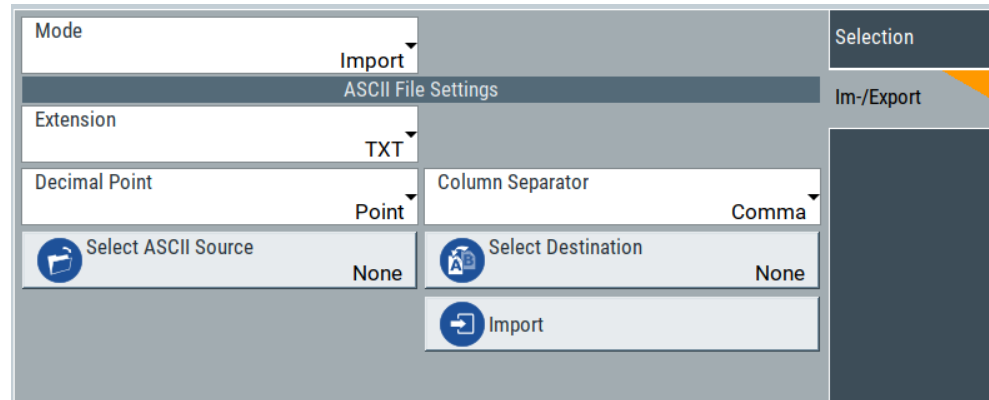

Figure 5-2: Im-/Export dialog (example with UCOR settings)

The "Import/Export" dialog contains all functions and settings to import externally created list data or to export it accordingly. You can process and store a list in the formats `*.txt` (ASCII), or `*.csv` (plain text with identical sequence of fields). The table separators and the decimal floating point numbers are customizable.

Settings

Mode	92
ASCII File Settings.....	92
Select (ASCII) Source/Select (ASCII) Destination.....	93
Select Source/Select ASCII Destination.....	93
Import / Export.....	93

Mode

Selects import or export of a data list file. The provided parameters vary according to the selected mode.

Remote command:

`[:SOURCE<hw>] :LIST:DEXChange:MODE` on page 445

`[:SOURCE<hw>] :CORRection:DEXChange:MODE` on page 412

`[:SOURCE<hw>] :PULM:TRAIIn:DEXChange:MODE` on page 395

ASCII File Settings

Defines the format and the separators of the associated data file.

"Extension" Selects `*.csv` or `*.txt` format.

"Decimal Point" Sets "Point" (dot) or "Comma" as the decimal separator used in the ASCII data with floating-point numerals.

"Column Separator" Sets the separator between the columns in an ASCII table.
Available are: "Tab", "Semicolon", "Comma" or "Space".

Remote command:

`[:SOURCE<hw>] :LIST:DEXChange:AFIle:EXTension` on page 444

`[:SOURCE<hw>] :LIST:DEXChange:AFIle:SEParator:DECimal` on page 444

[\[:SOURCE<hw>\]:LIST:DEXChange:AFILe:SEParator:COLumn](#) on page 444

[\[:SOURCE<hw>\]:CORRection:DEXChange:AFILe:EXTension](#) on page 410

[\[:SOURCE<hw>\]:CORRection:DEXChange:AFILe:SEParator:DECimal](#)

on page 411

[\[:SOURCE<hw>\]:CORRection:DEXChange:AFILe:SEParator:COLumn](#)

on page 411

[\[:SOURCE<hw>\]:PULM:TRAIIn:DEXChange:AFILe:EXTension](#) on page 395

[\[:SOURCE<hw>\]:PULM:TRAIIn:DEXChange:AFILe:SEParator:DECimal](#)

on page 395

[\[:SOURCE<hw>\]:PULM:TRAIIn:DEXChange:AFILe:SEParator:COLumn](#)

on page 395

Select (ASCII) Source/Select (ASCII) Destination

In "Mode > Import", access the file select dialog that provides standard file handling functions.

Where:

- "Select ASCII Source": defines the file to be loaded (imported)
- "Select ASCII Destination": selects the filename under that the loaded file is saved

Remote command:

[\[:SOURCE<hw>\]:LIST:DEXChange:AFILe:CATalog?](#) on page 443

[\[:SOURCE<hw>\]:LIST:DEXChange:AFILe:SElect](#) on page 444

[\[:SOURCE<hw>\]:CORRection:DEXChange:AFILe:CATalog?](#) on page 410

[\[:SOURCE<hw>\]:CORRection:DEXChange:AFILe:SElect](#) on page 411

[\[:SOURCE<hw>\]:PULM:TRAIIn:DEXChange:AFILe:CATalog?](#) on page 396

[\[:SOURCE<hw>\]:PULM:TRAIIn:DEXChange:AFILe:SElect](#) on page 396

Select Source/Select ASCII Destination

In "Mode > Export", access the file select dialog that provides standard file handling functions.

Where:

- "Select Source": selects the file to be exported
- "Select ASCII Destination": defines the filename and the file path for the exported file

Remote command:

[\[:SOURCE<hw>\]:LIST:DEXChange:SElect](#) on page 445

[\[:SOURCE<hw>\]:CORRection:DEXChange:SElect](#) on page 412

[\[:SOURCE<hw>\]:PULM:TRAIIn:DEXChange:SElect](#) on page 396

Import / Export

Imports or exports the selected data list file, depending on the current mode.

Remote command:

[\[:SOURCE<hw>\]:LIST:DEXChange:EXECute](#) on page 443

[\[:SOURCE<hw>\]:CORRection:DEXChange:EXECute](#) on page 411

[\[:SOURCE<hw>\]:PULM:TRAIIn:DEXChange:EXECute](#) on page 396

5.4.5 Pulse Graph

Option: see [Chapter 5.1, "Required Options"](#), on page 67.

Access:

- ▶ Select "Modulation" > "Pulse Modulation > Pulse Graph".

The pulse graph is the graphical representation of the current pulse signal.

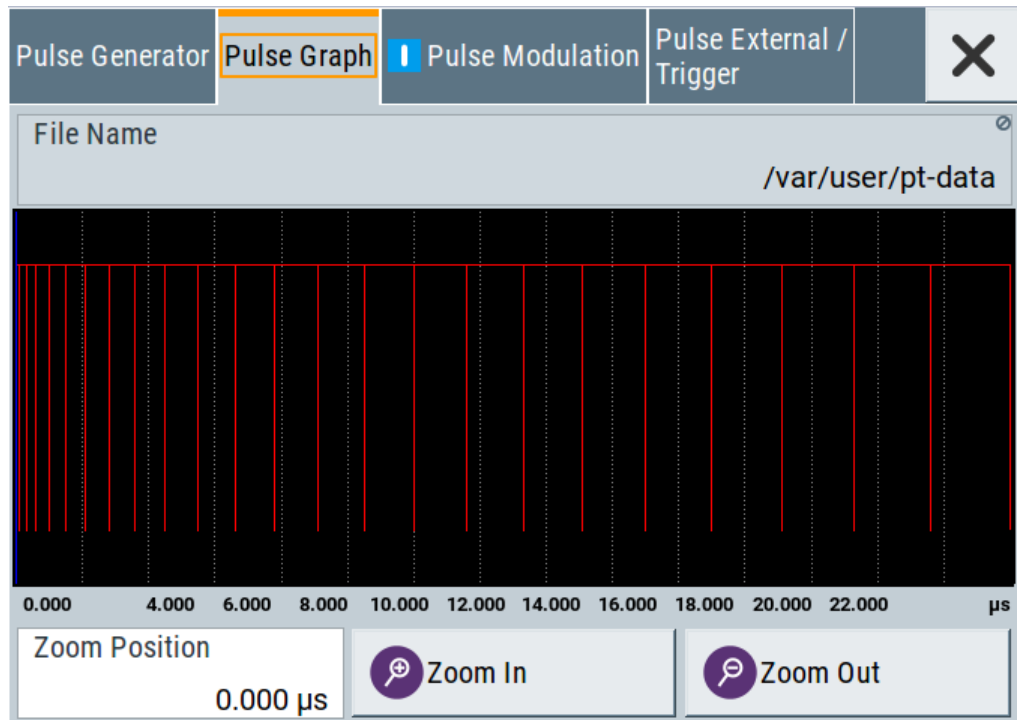

The height of the bars corresponds to the selected amplitude of the pulse signal.

File Name

Indicates the name of the pulse train data file.

To create or select a file, see ["Pulse Train Data"](#) on page 89.

Remote command:

`[:SOURCE<hw>] :PULM:TRAI:n:SElect` on page 394

Zooming

You can zoom into the diagram to visualize the graph in more detail:

- "Zoom Position": Sets the focus on the time axis where to enlarge the graph.
- "Zoom In": Enlarges the graph at the selected position.
- "Zoom Out" for the reverse operation.

5.4.6 Pulse External / Trigger Settings

Access:

- ▶ Select "Modulation" > "Pulse Modulation > Pulse External / Trigger".

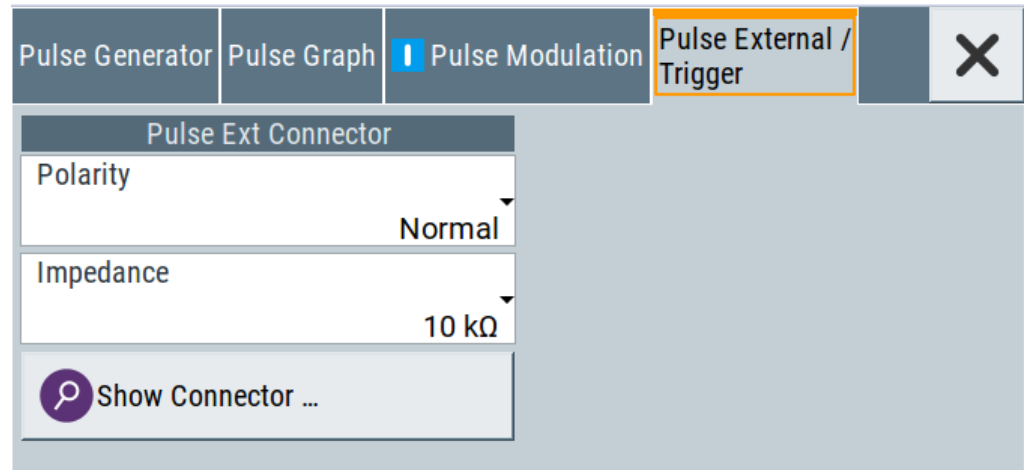

The dialog specifies some characteristics of the Pulse Ext. connector. This connector is common for the pulse generator and the pulse modulator. For an overview, see ["Input and output connectors"](#) on page 68.

Settings

Polarity	95
Impedance	95
Show Connector	95

Polarity

Sets the polarity of the active slope of a pulse input signal, that is the external pulse modulation signal.

Remote command:

`[:SOURce<hw>] :PULM:POLarity` on page 391

Impedance

Sets the input impedance.

Remote command:

`[:SOURce<hw>] :PULM:IMPedance` on page 391



Show Connector

Accesses a dialog that displays the physical location of the selected connector on the front/rear panel of the instrument.

5.4.7 FM, PhiM and AM Modulation Sources

Access:

- ▶ Select "Modulation > Modulation Sources".

In the "Sources" tab, you can configure an LF modulation signal for performing analog modulations. It includes the setting parameters of the internal LF-and multi-function generators, the noise generator, and an external signal source.

- [Source > LF Generator Settings](#)..... 96
- [Source > External Settings](#)..... 100
- [Source > Noise Generator Settings](#)..... 101

5.4.7.1 Source > LF Generator Settings

Access:

- ▶ Select "Modulation" > "Modulation Sources > LF Generator".

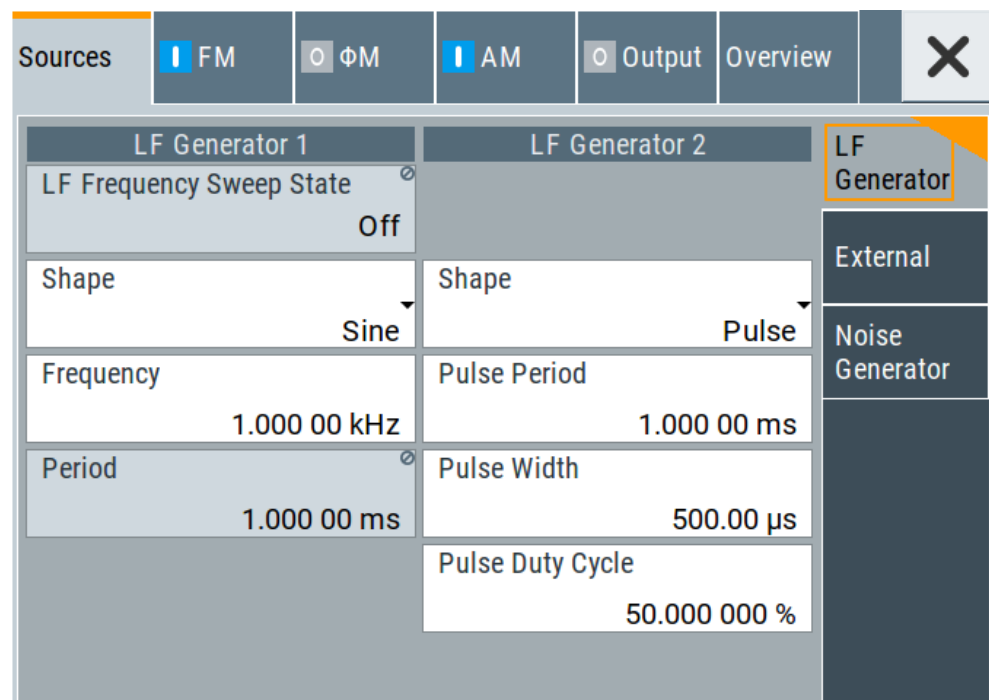

The internal LF signal can be the modulation signal source for any of the analog modulations. The LF signal applies to all modulations which use the internal modulation signal. Therefore, any modification of the LF signal immediately affects all currently active modulations.

Settings

State (LF frequency sweep).....	97
Shape.....	97
Frequency.....	99
Period.....	99
Pulse Width.....	99
Pulse Duty Cycle.....	99
Triangle Rise.....	99
Trapezoid Rise / Fall.....	100
Trapezoid High.....	100

State (LF frequency sweep)

Status of the LF frequency sweep signal.

You find this parameter in two dialogs:

- "LF Frequency Sweep" turns on/off the signal generation.
See [Sweep Mode Settings](#) for access.
- "Analog Modulation Sources" displays the current state (read-only). If it is turned on, this dialog provides the varying sweep frequency, see [Current Frequency](#).

Note: Active RF frequency, RF level or RF combined sweep modes deactivate the LF sweep or List mode and vice versa.

Remote command:

`[:SOURce<hw>] :LFOutput:FREQUENCY:MODE` on page 423

Shape

Selects the waveform shape of the LF signal.

The "Triangle" and "Trapezoid" waveforms require option R&S SMBB-K24.

"Sine"

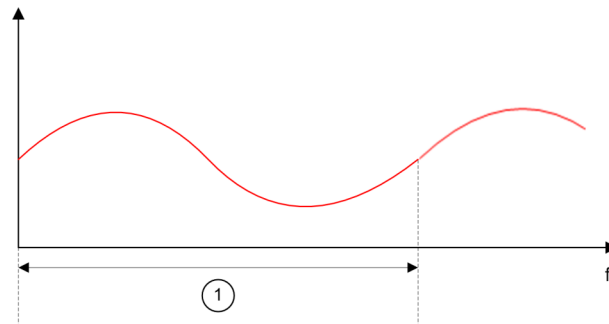

1 = Period

"Square"

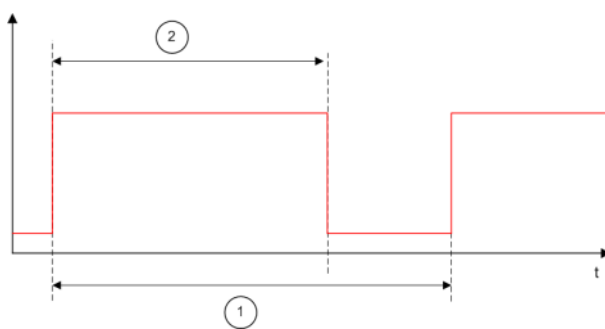

1 = Period
2 = Width

"Pulse"

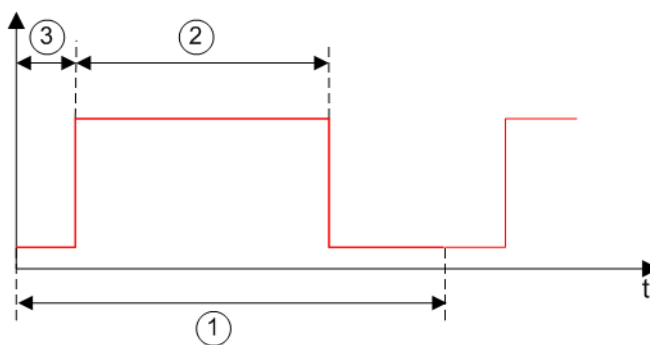

1 = Pulse period
2 = Pulse width
3 = Delay

"Triangle"

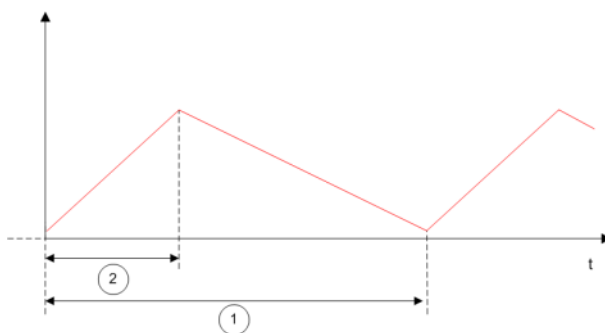

1 = Triangle period
2 = Triangle rise

"Trapezoid"

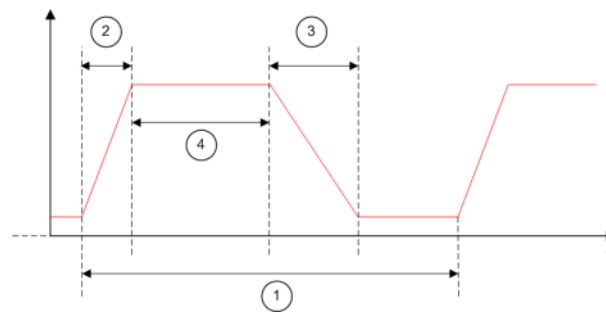

- 1 = Trapezoid period
- 2 = Trapezoid rise
- 3 = Trapezoid fall
- 4 = Trapezoid high

Remote command:

[\[:SOURce<hw>\]:LFOutput<ch>:SHAPE](#) on page 426

Frequency

Sets the frequency of the LF generator for sine signals.

Set the signal shape with the parameter [Shape](#).

Remote command:

[\[:SOURce\]:LFOutput<ch>:FREQUENCY](#) on page 422

Period

Sets the repetition rate of the generated LF signal for triangle, trapezoid or pulse shapes, see [Shape](#).

The period of sine signals is calculated from the selected [Frequency](#)

Remote command:

[\[:SOURce<hw>\]:LFOutput<ch>:SHAPE:TRAPeZe:PERiod](#) on page 428

[\[:SOURce<hw>\]:LFOutput<ch>:SHAPE:TRIangle:PERiod](#) on page 428

[\[:SOURce<hw>\]:LFOutput<ch>:SHAPE:PULSe:PERiod](#) on page 427

Pulse Width

Sets the pulse duration of the generated pulse signal.

Remote command:

[\[:SOURce<hw>\]:LFOutput<ch>:SHAPE:PULSe:WIDTh](#) on page 427

Pulse Duty Cycle

Sets the ratio between the pulse duration and the pulse period in percent.

Remote command:

[\[:SOURce<hw>\]:LFOutput<ch>:SHAPE:PULSe:DCYCLe](#) on page 426

Triangle Rise

Sets the time required for the triangle signal to change from low level to high level.

Remote command:

[\[:SOURce<hw>\]:LFOutput<ch>:SHAPE:TRIangle:RISE](#) on page 428

Trapezoid Rise / Fall

Sets the time required for the trapezoid signal to change from low level to high level, and vice versa.

Remote command:

[:SOURce<hw>] :LFOutput<ch>:SHAPE:TRAPeZe:RISE on page 428

[:SOURce<hw>] :LFOutput<ch>:SHAPE:TRAPeZe:FALL on page 427

Trapezoid High

Sets how long the trapezoid signal is at high level.

Remote command:

[:SOURce<hw>] :LFOutput<ch>:SHAPE:TRAPeZe:HIGH on page 427

5.4.7.2 Source > External Settings

Access:

- ▶ Select "Modulation" > "Modulation Sources > External".

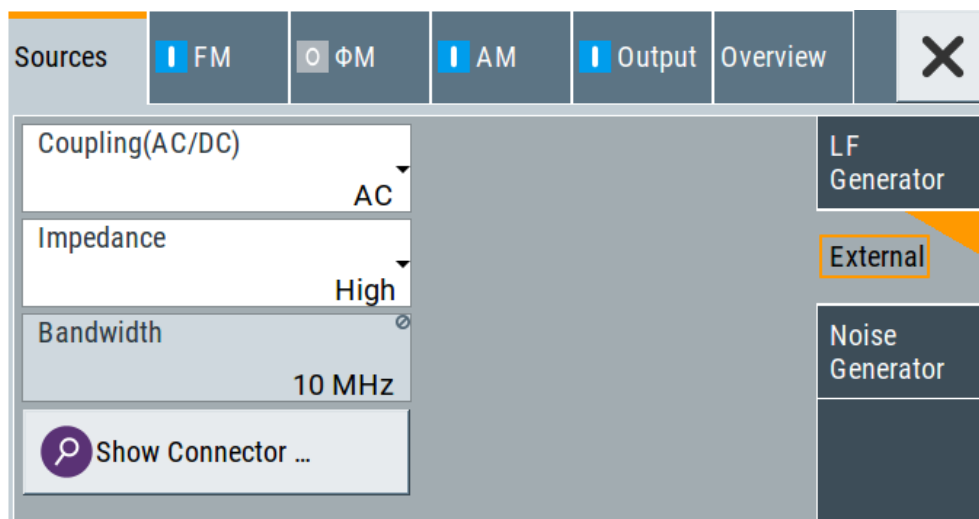

The "External" settings section contains all parameters required to configure the signal of an externally supplied LF signal.

Settings

Coupling (AC/DC)	100
Impedance	101
Bandwidth	101
Show Connector	101

Coupling (AC/DC)

Selects the coupling mode (AC or DC) for the external signal.

"AC" Disconnects the DC voltage component and uses only the AC component of the modulation signal.

"DC" Uses the modulation signal with both components, AC and DC.

Remote command:

[\[:SOURce<hw>\]:INPut:MODext:COUPling](#) on page 418

Impedance

Sets the impedance for the externally supplied signal.

Remote command:

[\[:SOURce<hw>\]:INPut:MODext:IMPedance<ch>](#) on page 419

Bandwidth

Displays the maximum bandwidth of the external LF signal.

Remote command:

[\[:SOURce\]:LFOutput<ch>:BANDwidth?](#) on page 422



Show Connector

Accesses a dialog that displays the physical location of the selected connector on the front/rear panel of the instrument.

5.4.7.3 Source > Noise Generator Settings

Access:

- ▶ Select "Modulation" > "Modulation Sources > Noise Generator".

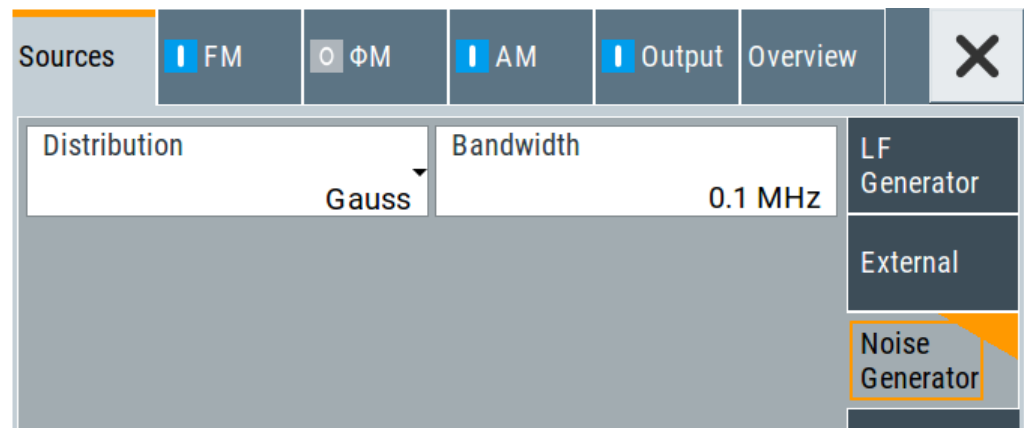

The "Noise Generator" settings contain all parameters to configure the signal of the internal noise generator.

Settings

Distribution	101
Bandwidth	102

Distribution

Selects the distribution of the noise power density.

"Gauss" Generates the noise power according to a Gaussian distribution.

"Equal" Generates an evenly distributed noise.

Remote command:

[\[:SOURce<hw>\]:NOISe:DISTRibution](#) on page 446

Bandwidth

Sets the noise bandwidth as distinct value.

You can set the bandwidth between 100 kHz and 10 MHz in 100 KHz steps.

Remote command:

[\[:SOURce<hw>\]:NOISe:BANDwidth|BWIDth](#) on page 446

[\[:SOURce<hw>\]:NOISe:BWIDth:STATe](#) on page 446

5.4.8 LF Signal Output Settings

Access:

- ▶ Select "Modulation" > "LF Output".

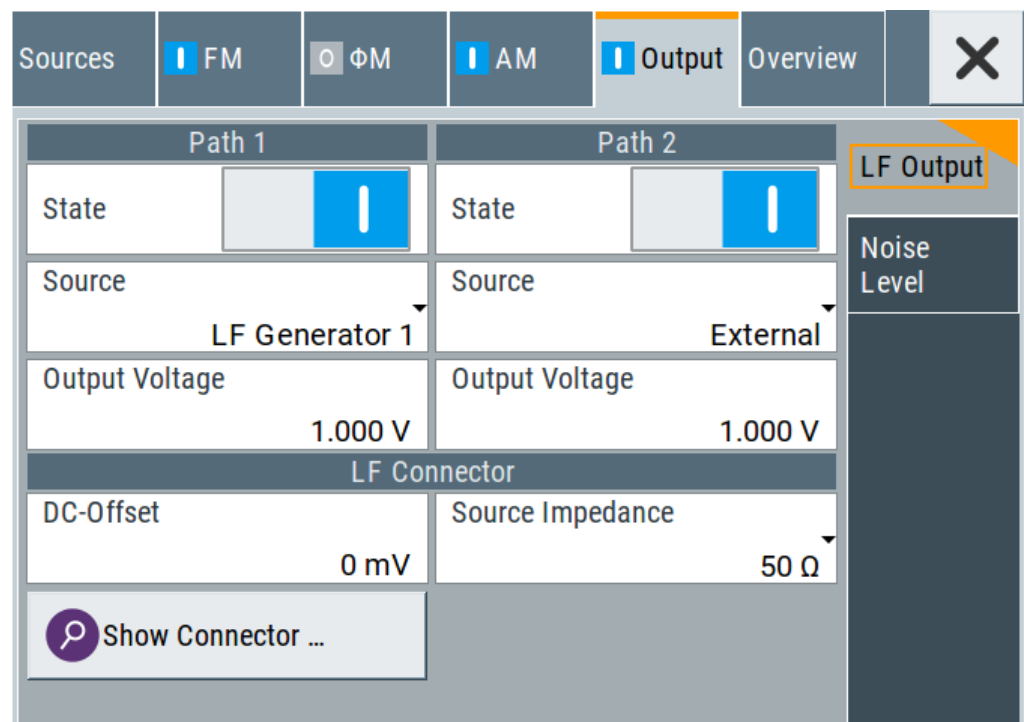

In the "LF Output" tab, you can configure the signal at the LF outputs, determine the output voltage or add a DC offset. Activate both paths to output the sum signal of the two sources.

Settings:

State	103
Source	103
Show Connector	103

Output Voltage.....	103
DC-Offset.....	103
Source Impedance.....	103
Load Impedance.....	104
Noise Level.....	104
L Noise Density.....	104
L Noise Level.....	104

State

Activates the output of the LF signal.

Remote command:

[\[:SOURce\]:LFOutput<ch>\[:STATe\]](#) on page 424

Source

Select the sources for the signal output at the LF connector. If you activate path 1 *and* 2, those sources are added.

Use the "Show Connector" function to find out where this connector is located.

"LF Generator 1/2"

Selects one of internally generated LF signals.

"AM"

Option: R&S SMBB-K720

Selects the AM signal.

"FM/PhiM"

Option: R&S SMBB-K720

Selects the signal also used by the frequency or phase modulations.

"Noise Generator"

Selects the internally generated noise signal.

"External"

Selects an externally supplied LF signal.

Remote command:

[\[:SOURce\]:LFOutput<ch>:SOURce](#) on page 425

**Show Connector**

Accesses a dialog that displays the physical location of the selected connector on the front/rear panel of the instrument.

Output Voltage

Sets the voltage (peak) of the selected LF output source.

Remote command:

[\[:SOURce\]:LFOutput<ch>:INTernal:VOLTage](#) on page 424

DC-Offset

Adds a DC offset to the LF output signal.

Remote command:

[\[:SOURce\]:LFOutput:OFFSet](#) on page 425

Source Impedance

Selects the output impedance of the LF generator.

"50 Ω"

Selects an output impedance of 50 Ω.

"600 Ω"

Selects an output impedance of 600 Ω.

Remote command:

[\[:SOURce\]:LFOutput:SIMPedance](#) on page 425

Load Impedance

Sets the specification of the load impedance interconnected to the LF generator output.

This parameter is available in case of activated R&S SMB100A or R&S SML0x emulations only, see "Remote Access Settings" > "Instrument Emulations" > "Language" on page 274.

These signal generators come with an LF generator source impedance of 10 Ohm which is not available with the R&S SMB100B.

The set LF generator load impedance enables the R&S SMB100B to emulate the 10 Ohm LF generator source impedance of these generators by a corresponding increase of the open circuit LF generator output voltage.

The load impedance setting is not affected by an instrument preset ([Preset] key or *RST), restart or the "Save/Recall" function. It is reset to the default value of 1 MOhm by a factory preset only.

Remote command:

n.a.

Noise Level

Access:

- Select "Modulation" > "Output > Noise Level".

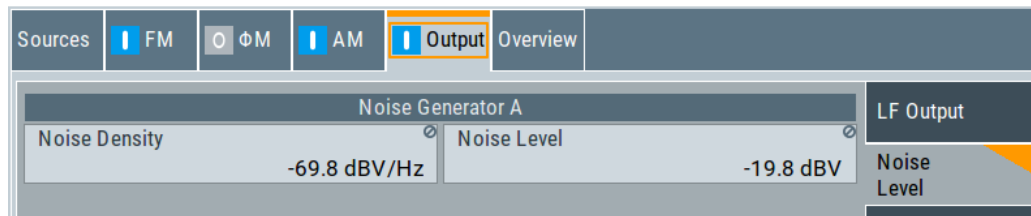

Noise Density ← Noise Level

Indicates the level of the noise signal for a bandwidth of 1 Hz (relative).

Remote command:

[\[:SOURce<hw>\]:NOISe:LEVel:RELative?](#) on page 446

Noise Level ← Noise Level

Indicates the level of the noise signal per Hz within the total bandwidth (absolute).

Remote command:

[\[:SOURce<hw>\]:NOISe:LEVel\[:ABSolute\]?](#) on page 447

5.4.9 Overview

Option: AM and FM/PM require R&S SMBB-K720

Access:

- ▶ Select "Modulation" > "Modulation Sources > Overview".

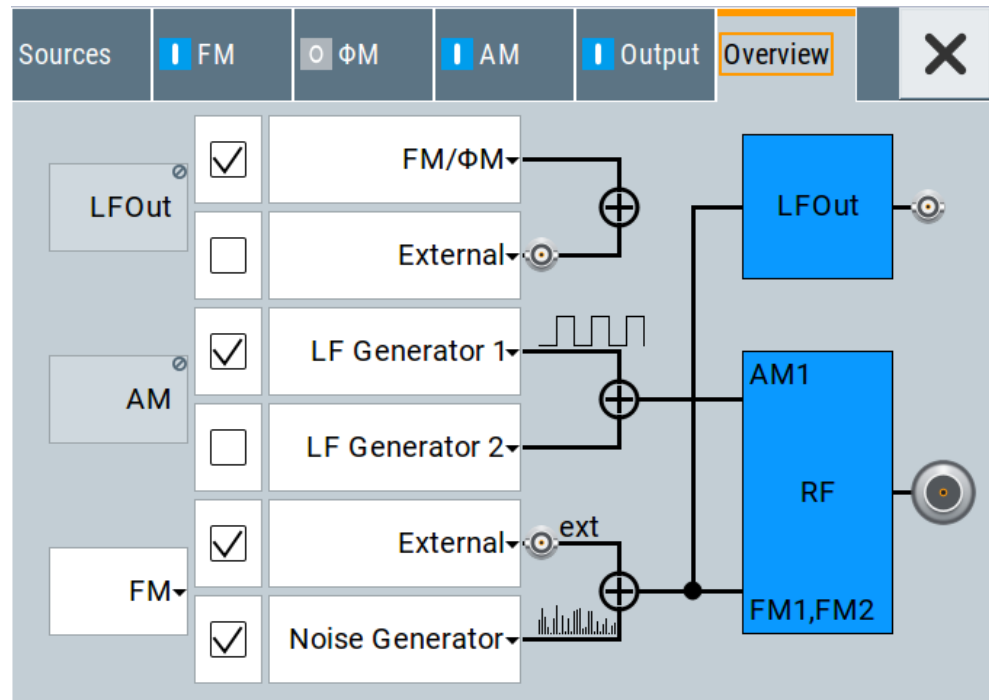

- Blue color = Active output signal (AM and FM)
- Gray color = Inactive output signal (LF Out)
- Miniature graph = Indicates an active source
- Connectors = Indicate a connector (e.g. external signal) is involved in the path of the signal

The "Overview" tab is an interactive diagram that indicates the active modulations and the signal being output.

Here you can:

- Select the output signal ("LF Out") in one or two paths; the setting acts as the parameter "LF Output Source"
- Select the source for each modulation and modulation path; the setting acts as the parameter "Source"
- Activate modulation in one or two paths; the setting acts as the parameter "State"
To generate a two-tone signal composed form the two paths of the same modulation type, activate both paths.
- The "FM" box allows switching to "PhiM", but those modulations are mutually exclusive.

LFOut

Label for the LF output settings in the overview.

Remote command:

n.a.

AM

Label for the amplitude modulation settings in the overview.

Remote command:

n.a.

FM/PhiM

Selects the modulation signal to be assigned to the output. You can assign the frequency or phase modulated signal.

Remote command:

n.a.

5.5 How to Generate an Amplitude Modulated Signal

The following examples use the internal LF generator.

To set the frequency and level of the RF signal

1. Press [Preset] to start from a defined state.
2. In the status bar, set "Frequency = 2 GHz".
3. Set "Level = -20 dBm".

To configure the modulation signal (LF generator)

1. Select "Modulation" > "Modulation Source".
2. In the "Sources" tab, select "Shape > Sine".
3. Set "Frequency = 20 kHz".

The period is calculated automatically and indicates "Period = 50.00 µs".

To configure the amplitude modulation settings

1. In "Modulation" dialog, select the "AM" tab.
2. Set "Source = LF Generator1"
3. Set "Depth = 30%"
4. Select "State = I" to activate the modulation.
5. Set "Level > RF ON" to enable signal output.

5.6 How to Generate a Pulse Modulated Signal

The following example uses the internal pulse generator.

To set the frequency and level of the RF signal

1. Press [Preset].
2. In the status bar, set "Frequency = 4 GHz".
3. Set "Level = -25 dBm".

To configure the pulse generator

1. Select "Modulation" > "Pulse Generator".
2. Select "Pulse Mode = Double".
3. Set "Pulse Period = 10 us".
4. Set "Pulse Width = 2 us".
5. Set "Double Pulse Width = 1.2 us".
6. Set "Double Pulse Delay = 4.5 us".
7. Activate "Pulse Output State".
8. Set "Trigger Mode = Auto".

In the "Pulse Graph" tab, you can view the generated pulse signal graphically.

To enable pulse modulation

1. Select the "Pulse Modulation" tab.
2. Set "State = I" to activate pulse modulation.
3. Set "Level > RF ON" to enable signal output.

5.7 How to Generate a Pulse Train Modulated Signal

The following example uses the internal pulse generator.

To set the frequency and level of the RF signal

1. Press [Preset].
2. In the status bar, set "Frequency = 6 GHz".
3. Set "Level = -25 dBm".

To configure the pulse generator

1. Select "Modulation" > "Pulse Generator".
2. Select "Pulse Mode = Train".
3. Select "Pulse Train Data".
Accesses the standard function for file handling.

4. Select an existing file or select "New" to create one.
5. Define the filename.
Select "Edit Pulse Train Data", if the file is empty or to control and change the values.
6. In the "Edit Pulse Train Data" dialog, enter the pulse on/off times and pulse repetition values.
For example:
 - "On-Time = 500 us", "OFF-Time = 2 ms", "Count = 2"
 - "On-Time = 100 us", "OFF-Time = 2.5 ms", "Count = 1"
 - "On-Time = 10 us", "OFF-Time = 50 us", "Count = 10"
7. "Save" the file and close the dialog.
The instrument returns to the /var/user/ where it has saved the file.
8. Select the file in the directory.
9. Confirm with "Select".
10. In the "Pulse Generator" dialog, select "Pulse Output State = On".
11. Set "Trigger Mode = Auto".

In the "Pulse Graph" tab, you can view the generated pulse signal graphically.

To enable pulse train modulation

1. Select the "Pulse Modulation" tab.
2. Set "State = I".
3. Set "Level > RF ON" to enable signal output.

6 List and Sweep Mode

The operating modes "List" and "Sweep" allow you to generate an RF signal having periodically varying frequencies or amplitudes.

A signal generated with varying parameters scans a certain range of varying values of a parameter, with defined start and end points, and can be repeated cyclically.

The R&S SMB100B supports two basic methods:

- **Sweep** mode

The instrument generates an RF signal which varies its frequency or level values in discrete steps between the start and end values. The values change according to a specific shape like sawtooth or triangle. The spacing is linear or logarithmic.

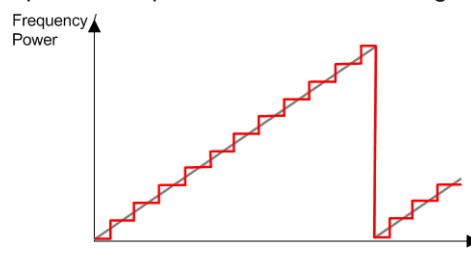

Figure 6-1: Schematic representation of a signal generated in sweep mode

The main application field of the "Sweep" mode is to determine the frequency response of a DUT.

- **List** mode

The instrument generates a varying output signal, based on a previously saved list with frequency, amplitude and step width values. While in sweep mode the frequency **or** the level values change, in list mode you can vary **both parameters simultaneously**. The frequency and level values do not need to have ascending or descending order, they can vary arbitrarily.

You can use a global dwell time, which means that the time interval is constant for all steps of the list, or different dwell times for each value pair.

[Figure 6-2](#) represents the frequency and power value pairs, in this case with the dwell time set the same for all steps (global dwell time).

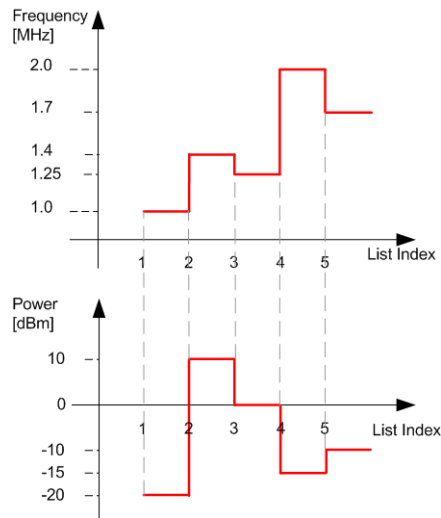

Figure 6-2: Schematic representation of a signal generated in list mode (global dwell time)

The list mode is especially useful in high-speed measurements with fast changing frequency and level settings.



Note that the shown diagrams represent the behaviour in theory. In real signal generation, the instruments usually have a blank time when the frequency or level changes.

Interactions and characteristics of list and sweep mode

- Activating the list mode automatically deactivates all RF and LF sweeps and vice versa.
- In list processing mode, the frequency and level display in the status bar is disabled.



- The sweep modes only work with a *global* dwell time, that means the time intervals are constant during signal generation.
- If you want to hold a running sweep at a specific frequency or level value, enter the value in the status bar. The sweep stops immediately.
- We recommend that you switch off the display update for optimum sweep performance, especially with short dwell times
See [Chapter 10.1.2, "Display Update Settings"](#), on page 226.

6.1 Signal Generation and Triggering in the Sweep and List Modes

In both operating modes "List" and "Sweep", triggering and signal generation follow the same principle. The instrument generates the signal continuously (that means triggered automatically) or in individual steps (controlled manually by an internal or external trigger signal).

The instrument expects the trigger signal at the Inst Trig connector.



If the dwell time in sweep or list mode is too short or external trigger signals come too fast, the signal generation delays. As the delay increases, the R&S SMB100B signals an overrun, or even stops sweep or list mode signal generation, if the delay gets too long.

The instrument displays corresponding error messages.

The figures in this section give an overview on the signal generation in the sweep and list modes and the appropriate triggering. The figures show the signal state after activating the mode and the generation of the signal when a trigger event occurs. For each mode, the relevant parameters and settings are briefly explained.

Each "Sweep" and "List" mode dialog provides also a "Reset" function that sets the signal to the initial value or the beginning of the list. Depending on the selected trigger mode, the signal generation proceeds accordingly.



The naming of the selection parameters in manual control (GUI) sometimes deviates from the naming in the remote-control commands. In addition, the value names of the selection parameters used in the signal generator partly differ from the SCPI syntax. The instrument accepts all value names.

The correlation between the manual control and the corresponding remote control commands, including the SCPI conform syntax are explained for each mode (see the cross-reference tables).

See also the following programming examples on the sweep and list modes in remote control:

- [Example "Setup an RF frequency or power sweep"](#) on page 464
- [Example "Setup an LF sweep"](#) on page 419
- [Example "Create an RF list and activate the list mode"](#) on page 432

Signal Generation and Triggering in the Sweep and List Modes

Auto mode (Sweep/List)

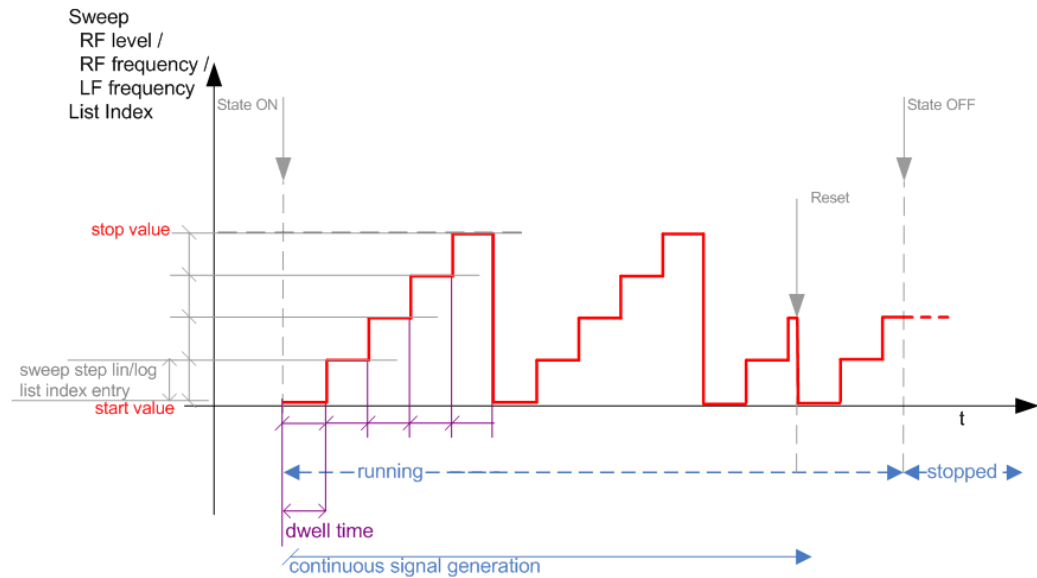

Figure 6-3: Auto mode (Sweep/List)

- The instrument generates the signal continuously.
- Trigger mode "Auto" is prerequisite (default). It causes the continuous generation of the sweep signal.
- Starts signal generation immediately with "State = On".
- Switches automatically to the next step when the **Dwell time** has elapsed.
- Stops signal generation with "State = Off".

Table 6-1: Cross-reference between manual and remote control in Auto mode (Sweep/List)

Manual control mode: "Auto"	Remote commands Rohde & Schwarz proprietary and [SCPI conform] value name
RF frequency sweep	:TRIGger<hw>:FSweep:SOURce AUTO [IMMediate] :SOURce<hw>:SWEep:FREQuency:MODE AUTO
RF level sweep	:TRIGger<hw>:PSweep:SOURce AUTO [IMMediate] :SOURce<hw>:SWEep:POWer:MODE AUTO
LF frequency sweep	:TRIGger<hw>:LFFSweep:SOURce AUTO [IMMediate] :SOURce<hw>:LFOutput<ch>:SWEep:FREQuency:MODE AUTO
List	:SOURce<hw>:LIST:MODE AUTO :SOURce<hw>:LIST:TRIGger:SOURce AUTO

Single / Extern Single mode (Sweep/List)

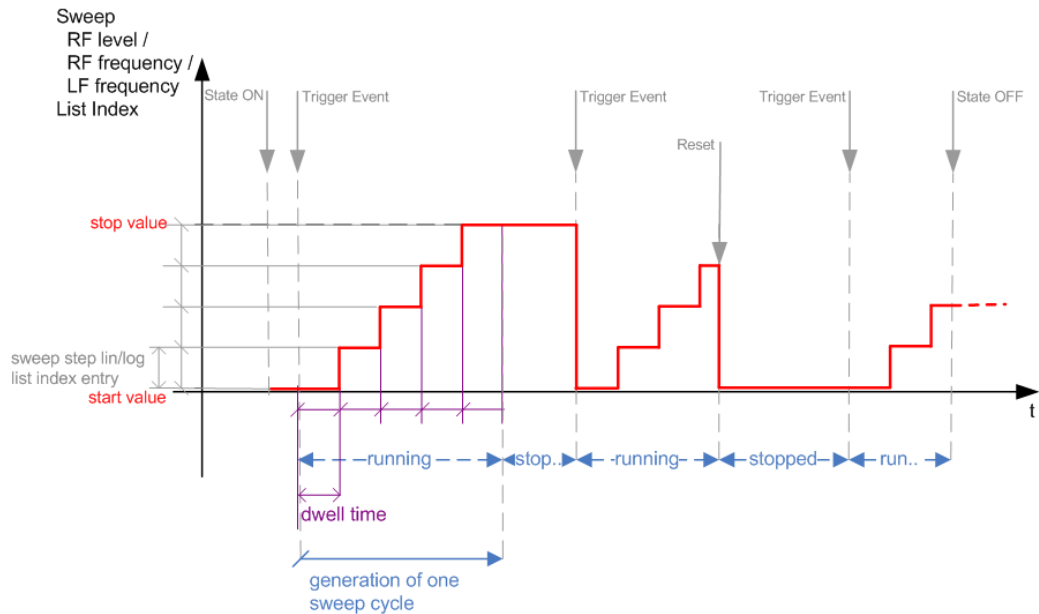

Figure 6-4: Single / Extern Single mode (sweep / list)



In single mode, you can specify, that the signal returns to the start value when a sweep cycle has been completed.

See ["The Retrace function"](#) on page 118 for details.

- The instrument generates a single sweep cycle.
- Trigger mode "Manual". A trigger event initiates one sweep from the start value to the end value.
- "State = On" sets the signal to the start value: the sweep start frequency, the sweep start power or the frequency-power value pair of the selected index in the list.
- Starts signal generation with a trigger event.
- Switches automatically to the next step when the [Dwell time](#) has elapsed.
- Stops signal generation at the set end value and waits for the subsequent trigger event.
- Trigger sources:
 - The "Execute Single Sweep" function.
 - The corresponding remote control command.
 - An externally applied trigger signal.
- "State = Off" stops the signal generation in sweep or list mode.

Signal Generation and Triggering in the Sweep and List Modes

Table 6-2: Cross-reference between manual and remote control in Single / Extern Single modes (Sweep/List)

Manual control mode: "Single / Extern Single"	Remote commands Rohde & Schwarz proprietary and [SCPI conform] value name
RF frequency sweep	:TRIGger<hw>:FSWEEP:SOURce SINGLE [BUS] "Single" or :TRIGger<hw>:FSWEEP:SOURce EXTERNAL [EXTERNAL] "Extern Single" :SOURce<hw>:SWEep:FREQuency:MODE AUTO
RF level sweep	:TRIGger<hw>:PSWEEP:SOURce SINGLE [BUS] for "Single" or :TRIGger<hw>:PSWEEP:SOURce EXTERNAL [EXTERNAL] for "Extern Single" :SOURce<hw>:SWEep:POWer:MODE AUTO
LF frequency sweep	:TRIGger<hw>:LFFSWEEP:SOURce SINGLE [BUS] "Single" or :TRIGger<hw>:LFFSWEEP:SOURce EXTERNAL [EXTERNAL] "Extern Single" :SOURce<hw>:LFOuTput<ch>:SWEep:FREQuency:MODE AUTO
List	:SOURce<hw>:LIST:TRIGger:SOURce SINGLE "Single" or :SOURce<hw>:LIST:TRIGger:SOURce EXTERNAL "Extern Single" :SOURce<hw>:LIST:MODE AUTO

Step / Extern Step mode (Sweep/List)

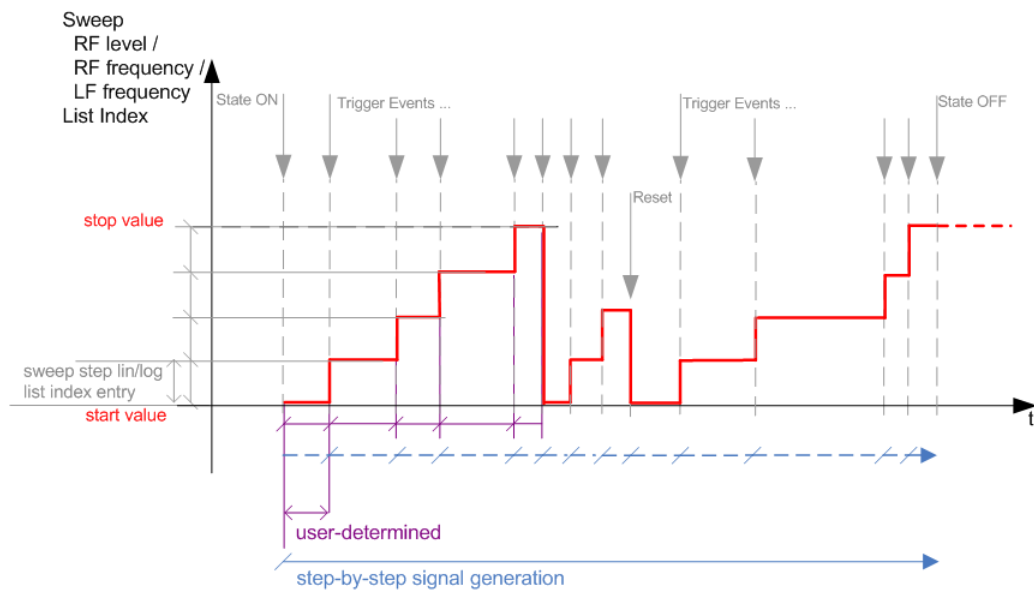

Figure 6-5: Step / Extern Step mode (sweep / list)

- The instrument generates the signal step-by-step.
- Starts signal generation with "State = On".
- Switches to the next step with a manual action.
If the end value is reached, signal generation starts again from the beginning.
- Stops signal generation with "State = Off".

Signal Generation and Triggering in the Sweep and List Modes

- Trigger sources:
 - The rotary knob at the front panel.
 - The [Arrow] keys at the front panel.
 - The corresponding remote control commands.
 - An externally applied trigger signal.

To step through the sweep frequencies or levels:

- In manual mode:
 - Set the **Current Frequency** or **Current Level** values
 - Use the [Up] and [Down] keys or the rotary knob
- In remote control mode:
 - Use the commands `[:SOURce<hw>] :FREQuency:MANual` or `[:SOURce<hw>] :POWer:MANual` with the UP or DOWN parameter



Steps that would exceed the sweep range are ignored.

Table 6-3: Cross-reference between manual and remote control in Step / Extern Step modes (Sweep/List)

Manual control mode: "Step / Extern Step"	Remote commands Rohde & Schwarz proprietary and [SCPI conform] value name
RF frequency sweep	:TRIGger<hw>:FSweep:SOURce SINGLE [BUS] "Step" or :TRIGger<hw>:FSweep:SOURce EXTernal [EXTernal] for "Extern Step" :SOURce<hw>:SWEep:FREQuency:MODE STEP
RF level sweep	:TRIGger<hw>:PSweep:SOURce SINGLE [BUS] "Step" or :TRIGger<hw>:PSweep:SOURce EXTernal [EXTenal] "Extern Step" :SOURce<hw>:SWEep:POWer:MODE STEP
LF frequency sweep	:TRIGger<hw>:LFFSweep:SOURce SINGLE [BUS] "Step" or :TRIGger<hw>:LFFSweep:SOURce EXTernal [EXTenal] "Extern Step" :SOURce<hw>:LFOutput<ch>:SWEep:FREQuency:MODE STEP
List	:SOURce<hw>:LIST:TRIGger:SOURce SINGLE "Step" or :SOURce<hw>:LIST:TRIGger:SOURce EXTernal "Extern Step" :SOURce<hw>:LIST:MODE STEP

Extern Start/Stop mode (sweep)

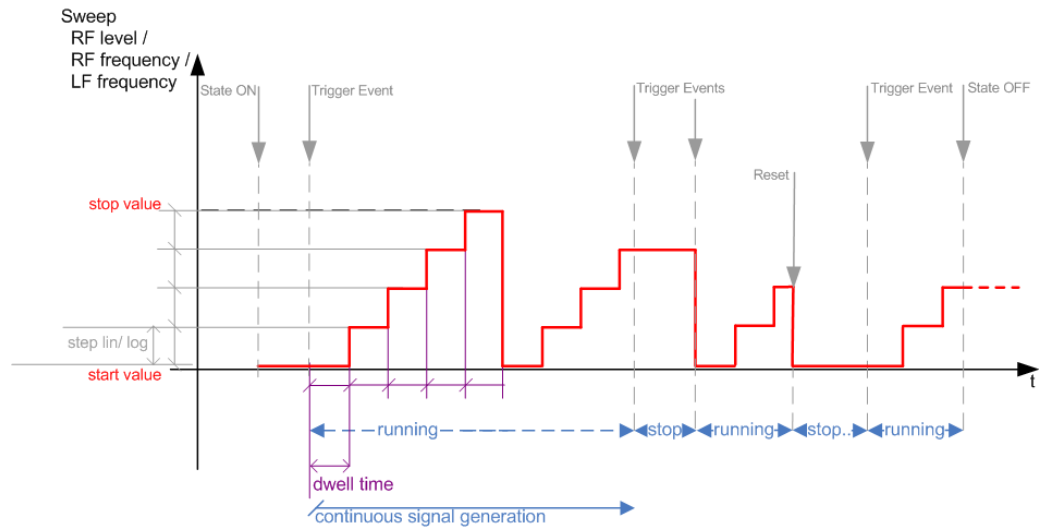

Figure 6-6: Extern Start/Stop mode (sweep)

- The instrument generates the signal continuously.
- Trigger mode "Auto" and "Sweep > State = On" are prerequisite.
- State "On" sets the signal to the start value, that is one of the following:
 - Sweep start frequency
 - Sweep start power
 - Frequency-power value pair of the selected index in the list
- Starts signal generation with a trigger event.
- Switches automatically to the next sweep step when the **Dwell time** has elapsed. If the end value is reached, signal generation continues with the next sweep cycle.
- Stops signal generation with the next external trigger event.
- Starts the signal generation again with the next trigger event, beginning at the start value.
- "State = Off" stops the signal generation in sweep or list mode.
- Trigger source: An externally applied trigger signal.

Table 6-4: Cross-reference between manual and remote control in Extern Start/Stop modes (sweep)

Manual control mode: "Extern Start/Stop"	Remote commands Rohde & Schwarz proprietary and [SCPI conform] value name
RF frequency sweep	:TRIGger<hw>:FSweep:SOURce EAUTO [-] :SOURce<hw>:SWEep:FREQuency:MODE AUTO
RF level sweep	:TRIGger<hw>:PSWep:SOURce EAUTO [-] :SOURce<hw>:SWEep:POWer:MODE AUTO
LF frequency sweep	:TRIGger<hw>:LFFSweep:SOURce EAUTO [-] :SOURce<hw>:LFOutput<ch>:SWEep:FREQuency:MODE AUTO

Manual mode (Sweep/List)



The **manual** mode only applies to remote control. It is not visible in the graphical user interface of the instrument and is described here for completeness.

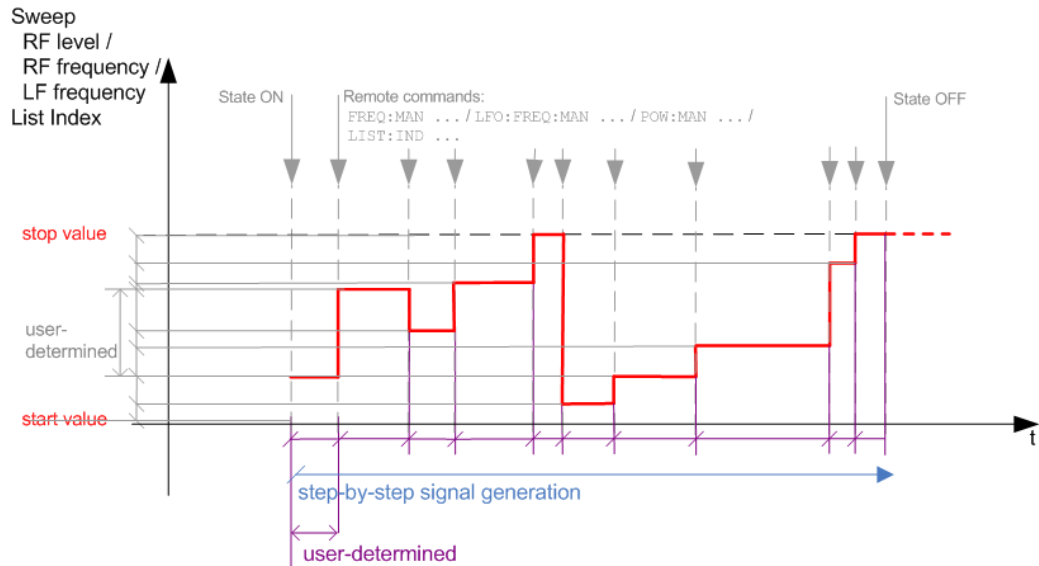

Figure 6-7: Manual mode in remote control (sweep / list)

- The instrument generates the signal in steps.
- Starts signal generation with "State = On".
- Switches to the next step with a user defined setting via remote control. You can arbitrarily select a value within the range of the start and stop values by setting the frequency, power or index using the corresponding remote control command. There is no ascending or descending order.
- Stops signal generation with "State = Off".

Table 6-5: Remote control commands in manual mode (Sweep/List)

Remote control mode:	Remote commands
Manual	Rohde & Schwarz proprietary and [SCPI conform] value name
RF frequency sweep	:SOURce<hw>:FREQUency:MANUal <Manual>
RF level sweep	:SOURce<hw>:POWER:MANUal <Manual>
LF frequency sweep	:SOURce<hw>:LFOUtpuT:FREQUency:MANUal <Manual>
List	:SOURce<hw>:LIST:INDex <Index>

The Retrace function

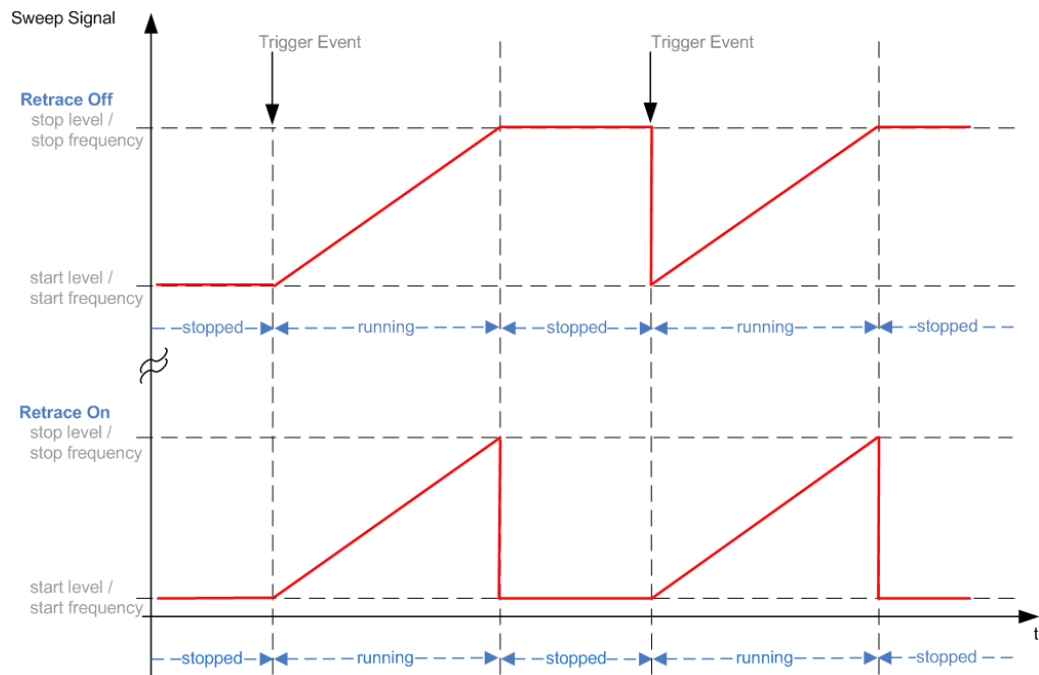

Retrace is a function especially designed for "Single" sweep modes, when the sweep signal follows a sawtooth shape. Working in this mode, the instrument performs a single sweep cycle when a trigger event occurs. The signal generation stops at the set end point (stop frequency or stop level), and waits for the next trigger event.

In this state, the upper value of the signal remains at the output until the next cycle starts. In particular, if you generate a level sweep signal, the high amplitude of the signal is output for a certain time. To protect the DUT from overload, the retrace function immediately resets the signal value to the start value at the end of a sweep cycle. It returns to the start level or start frequency until the next trigger is applied.

You can use the "Retrace" function if "Sweep > Mode = Single/External Single" and "Shape = Sawtooth", see:

- "Shape" on page 128
- "Mode" on page 127

6.2 About Sweep Mode

In sweep mode, the signal generator scans the sweep range gradually from one point to another, using a defined step size and following a triangle or sawtooth shape. This mode also enables you to change direction, that means, it is possible to step backwards.

See [Chapter 6.2.2, "Sweep Signal Shapes"](#), on page 121.

Configuration and operation of sweep mode signals

- The R&S SMB100B generates a sweep signal by varying the following parameters: either the *RF frequency*, the *RF level* or both, the *RF frequency* and the *RF level* in combined RF sweep mode, or the *LF frequency*.
- In all sweep modes, you can perform a complete sweep cycle once, repeat the cycle continuously or step through it gradually.
- The instrument generates the sweep signal according to the sweep settings.
- The "Reset Sweep" function, provided in the sweep settings dialogs enables you to reset the sweep to its initial value and restart it.



Impact of changing the sweep mode during performance

If you change the sweep mode during the execution, the signal generator stops the sweep and starts with the next trigger event at the initial value.

Combined RF frequency / level sweep processing mode

The combined RF sweep functionality processes the signal similar to the Live list mode. The R&S SMB100B sets the frequency and level values simultaneously in the hardware. The difference to the list mode is that the values are not taken from a previously created list, but are calculated using the selected frequency and level ranges, the dwell time and the number of steps.

6.2.1 Correlating Parameters in Sweep Mode

A sweep signal is a periodic signal that changes its frequency or level, or both, from a starting value to an ending value in a defined time.

The R&S SMB100B provides various possibilities to configure a sweep signal. For example, you can determine the sweep range by the start and end values, or based on the start value and span. In any case, related parameters are adjusted accordingly.

The formulas below show how the sweep parameters correlate and the corresponding calculation basis, by the frequency and offset settings. Apart from "Center Frequency", "Span" and "Step_lin", the values apply accordingly to the level settings.

Table 6-6: Variables that are used in the following formulas

Variable	Description
Sweep range	Defined frequency or level value range
f_{CENTer}	Defined center frequency
f_{SPAN}	Defined extend of the sweep range
f_{OFFSet}	Frequency offset
f_{START}	Start frequency of the sweep range
f_{STOP}	End frequency of the sweep range
f_1	Current sweep frequency

Variable	Description
f_2	Next, subsequent sweep frequency
step_lin	Step size in linear scaling
step_log	Step size in logarithmic scaling
POINts	Number of steps within the sweep range

Sweep range

The sweep range is defined by a start and an end value. How the remaining parameters correlate is shown below.

Offset = 0

Sweep Range = f_{START} to f_{STOP}

$$f_{\text{CENTer}} = (f_{\text{START}} + f_{\text{STOP}})/2$$

$$f_{\text{SPAN}} = (f_{\text{STOP}} - f_{\text{START}})$$

Where:

$$f_{\text{START}} = f_{\text{CENTer}} - (f_{\text{SPAN}}/2)$$

$$f_{\text{STOP}} = f_{\text{CENTer}} + (f_{\text{SPAN}}/2)$$

Offset≠0

A defined offset also affects the sweep range and the center frequency. Therefore, the set frequencies are only absolute values, if the Offset = 0. Offset ≠ 0 shifts the frequencies with the offset value:

Sweep Range = $f_{\text{START}} + f_{\text{OFFSet}}$ to $f_{\text{STOP}} + f_{\text{OFFSet}}$

$$f_{\text{CENTer}} = f_{\text{CENTer}} + f_{\text{OFFSet}}$$

$$f_{\text{SPAN}} = f_{\text{SPAN}} + f_{\text{OFFSet}}$$

The value range of the instrument is calculated as follows:

$$RF_{\text{min}} + f_{\text{OFFSet}} \text{ to } RF_{\text{max}} + f_{\text{OFFSet}}$$



It is possible to set $f_{\text{START}} > f_{\text{STOP}}$ and $f_{\text{START}} < f_{\text{STOP}}$, so that even a negative value is permitted for the "Span".

If you change the start and/or stop frequency, the span and center frequency change accordingly, and vice versa.

Sweep steps

In the following, you see how the sweep steps are calculated depending on the defined spacing mode. The formulas show a frequency sweep, but apply to the level settings in the same way.

The step size is added to the current value, to get the subsequent sweep step.

With **linear** scaling, the next frequency is calculated according to:

$$f_2 = f_1 + \text{step_lin}$$

In the **logarithmic** scaling, the step size is determined in per cent, as a constant fraction of the current frequency.

Successive frequencies are calculated as follows:

- For $f_{\text{START}} < f_{\text{STOP}}$
 $f_2 = f_1 * (1 + \text{step_log}/100)$
 If $f_2 > f_{\text{STOP}}$, then $f_2 = f_{\text{STOP}}$
- For $f_{\text{START}} > f_{\text{STOP}}$
 $f_2 = f_1 / (1 + \text{step_log}/100)$
 If $f_2 < f_{\text{STOP}}$, then $f_2 = f_{\text{STOP}}$

With "Shape = Triangle", the frequency values on the slope from f_{STOP} to f_{START} are the same as on the slope from f_{START} to f_{STOP} .

If you specify the number of steps within the sweep range, the step size is adjusted according to the following correlation:

- For **linear** sweeps and $f_{\text{START}} < f_{\text{STOP}}$
 $\text{POINTS}_{\text{frequency}} = ((f_{\text{START}} - f_{\text{STOP}})/\text{step_lin}) + 1 = (f_{\text{SPAN}}/\text{step_lin}) + 1$
- For **logarithmic** sweeps and $f_{\text{START}} < f_{\text{STOP}}$
 $\text{POINTS}_{\text{frequency}} = ((\log f_{\text{STOP}} - \log f_{\text{START}})/\log \text{step_log}) + 1$

If step_log changes, the value of POINTs is adjusted. The f_{START} and f_{STOP} values are retained.

6.2.2 Sweep Signal Shapes

The R&S SMB100B supports the following sweep shapes:

- Sawtooth
 The sweep sequence resembles a sawtooth. One sweep runs from start to stop frequency, or level value respectively. Each subsequent sweep starts again at the start value.

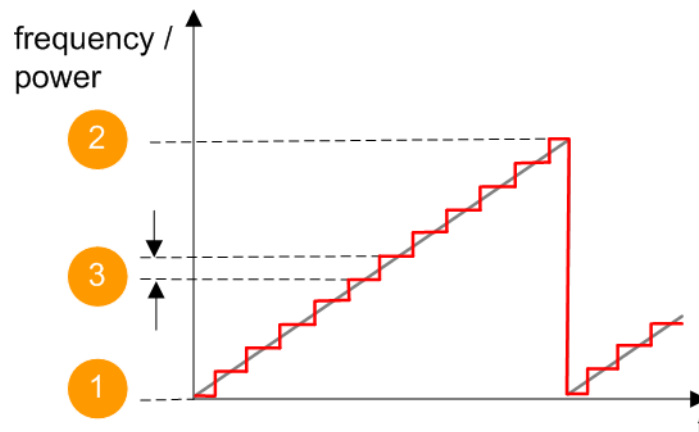

Figure 6-8: Sweep signal sawtooth shape

1 = Start value
2 = Stop value
3 = Step size

- Triangle
The sweep sequence resembles a triangle. One sweep runs from start to stop value frequency and back. Each subsequent sweep starts at the start value.

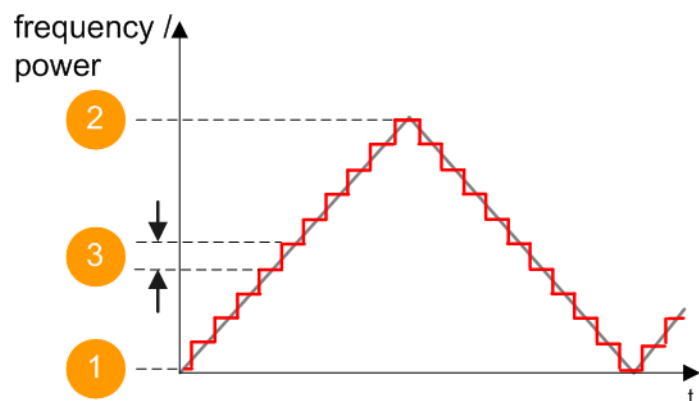

Figure 6-9: Sweep signal triangle shape

1 = Start value
2 = Stop value
3 = Step size

The current frequency or level of an RF frequency, level or LF frequency sweep is determined by the shape (e.g. sawtooth or triangle) and the spacing (linear or logarithmic), and the step size.

6.3 About List Mode

The list mode is used to generate the RF signal based on a set of predefined frequency and amplitude value pairs, with individual step times. You can define the values

arbitrarily, in any order and varying step sizes, within the entire configurable value range of the instrument.

Configuration and operation of list mode signals

The parameters configuring the RF signal are defined in a list (table) and stored in a file.

Creating and handling lists

List files can be created in the following ways:

- **Internally**

Use the build-in table editor with columns for the frequency-level values pairs and the dwell time.

Define the values manually (row by row) or automatically, based on value range and step size.

(See [Chapter 6.7, "List Editor"](#), on page 142)

Lists are saved as files with user-definable filename and the predefined file extension *.lsw. To load a saved file, use the "File Manager".

(See [Chapter 9.8, "Using the File Manager"](#), on page 205)

- Lists can be exported, too. For example, to exchange configuration between instruments or to modify the file content with an external program and reload them again.

- **Externally**

Create a list file as a CSV file with Microsoft Excel, with a Notepad or a similar tool and save it with the predefined extension. Transfer the file to and load it into the instrument.

Dwell time mode

You can choose whether you want to use different dwell times or a fixed value for all steps in the list mode:

- "From List"

This mode uses the values from the data table.

See [Edit List Mode Data](#)

- "Global"

This mode processes the list with a fixed time interval you can set with [Global Dwell Time](#).

List processing mode

See:

- ["Live list processing mode"](#) on page 125

6.4 Significant Parameters and Functions

This section provides some basic parameters, settings and functions that affect the operating modes CW, list and sweep, that means at all frequency and level transitions of the RF signal.

Dwell time

Dwell time is the length of time that elapses from the beginning until the end of a step in list or sweep mode.

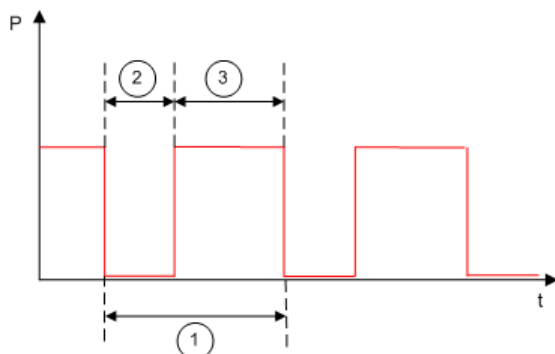

Figure 6-10: Dwell Time vs. settling time

- 1 = "Dwell Time" (as set with the parameter)
- 2 = Settling time
- 3 = Dwell time (effective)

However, the time the instrument requires for the signal to settle reduces the set dwell time:

$$t_{\text{dwell(effective)}} = t_{\text{dwell}} - t_{\text{settling}}$$



If the dwell time in sweep or list mode is too short or external trigger signals come too fast, the signal generation delays. As the delay increases, the R&S SMB100B signals an overrun, or even stops sweep or list mode signal generation, if the delay gets too long.

The instrument displays corresponding error messages.

Hardware adjustments

The first time a list (new or modified) is processed, the instrument automatically calculates the necessary hardware settings. It can be performed during list processing, but delays the first cycle, especially with short dwell times.

With long dwell times, you can perform this calculation while the list is being processed; the entered dwell times are observed. With short dwell times, calculation of the hardware settings increases the dwell time for the initial processing cycle; the entered value is only observed from the second processing cycle onwards. In this case, a message indicates that there is a deviation between the current and set dwell times. After the first cycle, you do not need to perform additional calculations. The current dwell times do not deviate from the set dwell times.

Blanking

The instrument applies *blanking*, which temporarily turns off the RF signal when the frequency or level changes, until the signal has settled to a stable state.

Temporary blanking applies to all operating modes.

Live list processing mode

The R&S SMB100B generates the signal directly from the value pairs in the database, and adjusts the hardware settings accordingly. The current instrument state and thus any change during the signal generation directly affects the RF signal. The temporary memory is not used.

You can conveniently modify parameters like modulation settings during run-time. Learning list mode data is not required. Impacts like temperature drift are also considered immediately.

This mode is optimized for **maximum signal quality**, and is useful if dwell times higher than 2 ms are sufficient.

6.5 Sweep Mode Settings

This section lists the settings of **all** available sweep modes.

Access:

1. Select "Sweep" > "RF Frequency Sweep"
2. Select "Sweep" > "RF Level Sweep"
3. Select "Sweep" > "RF Combined Sweep"
4. Select "Sweep" > "LF Frequency Sweep"

The remote commands required to define these settings are described in:

- [Chapter 12.14.12, "SOURce:SWEep Subsystem"](#), on page 463
- [Chapter 12.14.3, "SOURce:FREQuency Subsystem"](#), on page 412
- [Chapter 12.14.10, "SOURce:POWEr Subsystem"](#), on page 449
- [Chapter 12.14.5, "SOURce:LFOuTput Subsystem"](#), on page 419

Settings

- [General Sweep Settings](#)..... 125
- [Frequency Range Settings](#)..... 131
- [Level Range Settings](#)..... 133

6.5.1 General Sweep Settings

Access:

- ▶ Select for example "Sweep" > "RF Frequency Sweep".

Table 6-7: General settings dialog: Examples of RF Frequency and RF Combined Sweep dialogs

> "RF Frequency Sweep"	> "RF Combined Sweep"

Settings

State (RF frequency sweep).....	126
State (RF level sweep).....	126
State (RF frequency / level sweep).....	127
State (LF frequency sweep).....	127
Current Frequency.....	127
Current Level.....	127
Mode.....	127
Retrace.....	128
Shape.....	128
Spacing.....	130
Dwell Time	130
Trigger Slope.....	130
Show Connector.....	131
Reset Sweep	131
Execute Single Sweep	131

State (RF frequency sweep)

Activates RF frequency sweep signal generation.

Note: Active RF frequency, RF level or RF combined sweep modes deactivate the LF sweep or List mode and vice versa.

Remote command:

[:SOURce<hw>] :FREQuency:MODE on page 413

State (RF level sweep)

Activates RF level sweep signal generation.

Note: Active RF frequency, RF level or RF combined sweep modes deactivate the LF sweep or List mode and vice versa.

Remote command:

[:SOURce<hw>] :POWer:MODE on page 454

State (RF frequency / level sweep)

Activates the RF frequency / level sweep signal generation.

Note: Active RF frequency, RF level or RF combined sweep modes deactivate the LF sweep or List mode and vice versa.

Remote command:

[:SOURce<hw>] :FREQuency:MODE on page 413

[:SOURce<hw>] :POWer:MODE on page 454

State (LF frequency sweep)

Status of the LF frequency sweep signal.

You find this parameter in two dialogs:

- "LF Frequency Sweep" turns on/off the signal generation. See [Sweep Mode Settings](#) for access.
- "Analog Modulation Sources" displays the current state (read-only). If it is turned on, this dialog provides the varying sweep frequency, see [Current Frequency](#).

Note: Active RF frequency, RF level or RF combined sweep modes deactivate the LF sweep or List mode and vice versa.

Remote command:

[:SOURce<hw>] :LFOutput:FREQuency:MODE on page 423

Current Frequency

Displays the current frequency sweep value for all sweep [Modes](#), except of [Mode > Step](#). In this mode, you can enter the next frequency setting manually.

Remote command:

[:SOURce<hw>] :FREQuency:MANual on page 415

[:SOURce<hw>] :LFOutput:FREQuency:MANual on page 423

Current Level

Displays the current level sweep value for all sweep [Modes](#), except of [Mode > Step](#). In this mode, you can enter the next level setting manually.

Remote command:

[:SOURce<hw>] :POWer:MANual on page 453

Mode

Selects the sweep mode.

See [Chapter 6.1, "Signal Generation and Triggering in the Sweep and List Modes"](#), on page 111.

"Auto" Generates a continuously repeating sweep signal directly after activating the sweep mode.
The sweep steps are performed automatically, controlled by the dwell time.

"Single / Extern Single" Generates a single sweep cycle after a trigger event.
The sweep steps within the cycle are performed automatically, controlled by the dwell time. If one cycle is completed, the instrument waits for the next trigger event.

"Step / Extern Step"

Generates the sweep signal step-by-step, manually triggered.

"Extern Start/Stop"

Generates a continuously repeating sweep signal that is started, stopped, and restarted by subsequent external trigger events.

The sweep steps are performed automatically, controlled by the dwell time.

Remote command:

RF frequency sweep:

[\[:SOURce<hw>\]:SWEep\[:FREQuency\]:MODE](#) on page 468

[:TRIGger<hw>:FSWEEP:SOURce](#) on page 505

RF level sweep:

[\[:SOURce<hw>\]:SWEep:POWer:MODE](#) on page 467

[:TRIGger<hw>:PSWEEP:SOURce](#) on page 505

RF combined sweep:

[\[:SOURce<hw>\]:SWEep:COMBined:MODE](#) on page 474

[:TRIGger<hw>:FPSWEEP:SOURce](#) on page 506

LF frequency sweep:

[\[:SOURce<hw>\]:LFOutput:SWEep\[:FREQuency\]:MODE](#) on page 430

[:TRIGger<hw>:LFFSWEEP:SOURce](#) on page 505

Retrace

For "Shape = Sawtooth" and "Mode = Single/External Single", enables changing the signal to the start value while it is waiting for the next trigger event. It returns to the start level or start frequency until the next trigger is applied.

Remote command:

RF frequency sweep:

[\[:SOURce<hw>\]:SWEep\[:FREQuency\]:RETRace](#) on page 470

RF level sweep:

[\[:SOURce<hw>\]:SWEep:POWer:RETRace](#) on page 470

RF combined sweep:

[\[:SOURce<hw>\]:SWEep:COMBined:RETRace](#) on page 474

LF frequency sweep:

[\[:SOURce<hw>\]:LFOutput:SWEep\[:FREQuency\]:RETRace](#) on page 430

Shape

Selects the waveform shape of the sweep signal.

"Sawtooth"

The sweep runs from start to stop frequency. The subsequent sweep starts at the start value, i.e. the shape of the sweep sequence resembles a sawtooth.

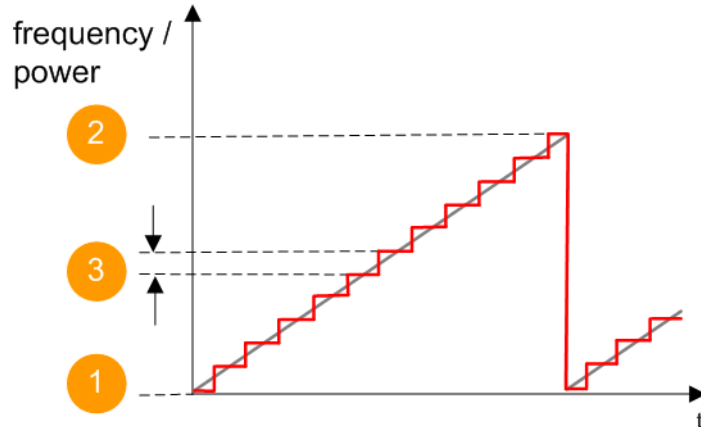

Figure 6-11: Sweep signal sawtooth shape

1 = Start value
2 = Stop value
3 = Step width

"Triangle"

The sweep runs from start to stop value and back, i.e. the shape of the sweep resembles a triangle. Each subsequent sweep starts at the start frequency.

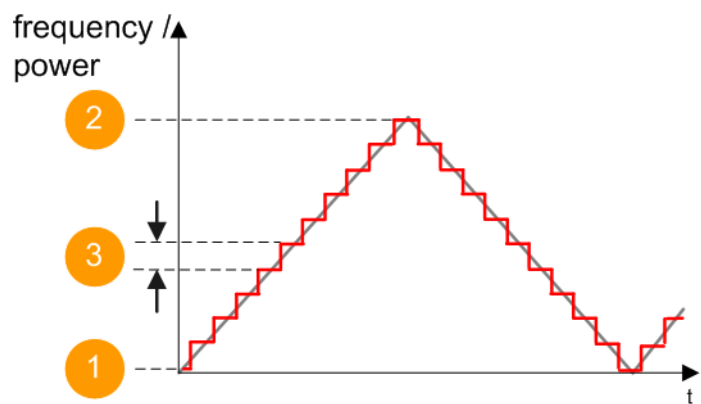

Figure 6-12: Sweep signal triangle shape

1 = Start value
2 = Stop value
3 = Step width

Remote command:

RF frequency sweep:

[\[:SOURce<hw>\]:SWEep\[:FREQuency\]:SHAPE](#) on page 470

RF level sweep:

[\[:SOURce<hw>\]:SWEep:POWer:SHAPE](#) on page 470

RF combined sweep:

[\[:SOURce<hw>\]:SWEep:COMBined:SHAPE](#) on page 474

LF frequency sweep:

[\[:SOURce<hw>\]:LFOutput:SWEep\[:FREQuency\]:SHAPE](#) on page 431

Spacing

In "RF and LF Frequency Sweep" mode, "Spacing" selects the mode for calculating the frequency interval, which increases or decreases the current frequency at each step.

To determine the step size, select the parameter [Step Linear/Step Logarithmic](#).

In "RF Combined Sweep" mode, the parameter indicates that the step intervals are linearly (straight proportional) distributed, i.e. the intervals have the same size. The frequency / level range and the [Dwell Time](#) time determine the calculated step size.

"Linear" Takes the frequency value entered as absolute value in Hz.

"Logarithmic" Takes the value entered as a logarithmic value, i.e. as a constant fraction of the current frequency in %.

Remote command:

RF frequency sweep:

[\[:SOURce<hw>\]:SWEep\[:FREQuency\]:SPACing](#) on page 469

RF combined sweep: n.a.

LF frequency sweep:

[\[:SOURce<hw>\]:LFOutput:SWEep\[:FREQuency\]:SPACing](#) on page 431

Dwell Time

Defines the duration of the individual sweep steps.

Note: In case of considerable overrun conditions, the R&S SMB100B turns off the sweep mode.

See also [Chapter 6.4, "Significant Parameters and Functions"](#), on page 123.

Remote command:

RF frequency sweep:

[\[:SOURce<hw>\]:SWEep\[:FREQuency\]:DWELl](#) on page 468

RF level sweep:

[\[:SOURce<hw>\]:SWEep:POWer:DWELl](#) on page 466

RF combined sweep:

[\[:SOURce<hw>\]:SWEep:COMBined:DWELl](#) on page 473

LF frequency sweep:

[\[:SOURce<hw>\]:LFOutput:SWEep\[:FREQuency\]:DWELl](#) on page 429

Trigger Slope

For "Mode = Extern Step/Single", selects the polarity of the active slope of an applied instrument trigger.

Trigger signal is expected at the Inst Trig connector.

"Positive" The rising edge of the trigger signal triggers the instrument.

"Negative" The falling edge of the trigger signal triggers the instrument.

Remote command:

[\[:SOURce\]:INPut:TRIGger:SLOPe](#) on page 419



Show Connector

Accesses a dialog that displays the physical location of the selected connector on the front/rear panel of the instrument.

Reset Sweep

Resets a sweep.

With the next trigger event, the sweep starts at the initial value.

Remote command:

`[:SOURce<hw>] :SWEep:RESet [:ALL]` on page 475

Execute Single Sweep

In "Mode = Single", starts a sweep manually.

Remote command:

RF frequency sweep:

`[:SOURce<hw>] :SWEep [:FREQuency] :EXECute` on page 470

`:TRIGger<hw>:FSweep [:IMMediate]` on page 507

RF level sweep:

`[:SOURce<hw>] :SWEep:POWer:EXECute` on page 470

`:TRIGger<hw>:PSweep [:IMMediate]` on page 507

RF combined sweep:

`[:SOURce<hw>] :SWEep:COMBined:EXECute` on page 473

LF frequency sweep:

`[:SOURce<hw>] :LFOutput:SWEep [:FREQuency] :EXECute` on page 429

`:TRIGger<hw>:LFFSweep:IMMediate` on page 507

General:

`:TRIGger<hw> [:SWEep] [:IMMediate]` on page 507

6.5.2 Frequency Range Settings

Access:

1. Select for example "Sweep" > "RF Frequency Sweep"
2. Select for example "Frequency Range".

> "Frequency Range"	> "Frequency / Level Range"

Settings

Start Frequency/Stop Frequency	132
Center Frequency	132
Span.....	132
Spacing.....	132
Step Linear/Step Logarithmic	133

Start Frequency/Stop Frequency

Defines the frequency sweep range by setting the start and end values.

See [Chapter 6.2.1, "Correlating Parameters in Sweep Mode"](#), on page 119.

Remote command:

RF frequency sweep:

[:SOURce<hw>] :FREQuency:START on page 417

[:SOURce<hw>] :FREQuency:STOP on page 417

RF combined sweep:

[:SOURce<hw>] :COMBined:FREQuency:START on page 471

[:SOURce<hw>] :COMBined:FREQuency:STOP on page 472

LF frequency sweep:

[:SOURce<hw>] :LFOutput:FREQuency:START on page 424

[:SOURce<hw>] :LFOutput:FREQuency:STOP on page 424

Center Frequency

In "RF Frequency Sweep" mode, sets the RF center frequency.

See [Chapter 6.2.1, "Correlating Parameters in Sweep Mode"](#), on page 119.

Remote command:

[:SOURce<hw>] :FREQuency:CENTer on page 416

Span

In "RF Frequency Sweep" mode, sets the span of the frequency sweep range.

See [Chapter 6.2.1, "Correlating Parameters in Sweep Mode"](#), on page 119.

Remote command:

[:SOURce<hw>] :FREQuency:SPAN on page 416

Spacing

In "RF and LF Frequency Sweep" mode, "Spacing " selects the mode for calculating the frequency interval, which increases or decreases the current frequency at each step.

To determine the step size, select the parameter [Step Linear/Step Logarithmic](#) .

In "RF Combined Sweep" mode, the parameter indicates that the step intervals are linearly (straight proportional) distributed, i.e. the intervals have the same size. The frequency / level range and the [Dwell Time](#) time determine the calculated step size.

"Linear" Takes the frequency value entered as absolute value in Hz.

"Logarithmic" Takes the value entered as a logarithmic value, i.e. as a constant fraction of the current frequency in %.

Remote command:

RF frequency sweep:

`[:SOURce<hw>] :SWEep [:FREQuency] :SPACing` on page 469

RF combined sweep: n.a.

LF frequency sweep:

`[:SOURce<hw>] :LFOutput :SWEep [:FREQuency] :SPACing` on page 431

Step Linear/Step Logarithmic

In "RF/LF Frequency Sweep" mode, sets the step width for the individual frequency sweep steps. The value is added at each sweep step to the current frequency.

Depending on the current [Spacing](#), you can enter either an absolute or logarithmic step width.

See [Chapter 6.2.1, "Correlating Parameters in Sweep Mode"](#), on page 119.

"Step Linear" The step width is a constant value in Hz.

"Step Logarithmic"

The step width is determined logarithmically in %, i.e. as a constant fraction of the current frequency.

Remote command:

`[:SOURce<hw>] :SWEep [:FREQuency] :STEP [:LINear]` on page 471

`[:SOURce<hw>] :SWEep [:FREQuency] :STEP :LOGarithmic` on page 471

`[:SOURce<hw>] :LFOutput :SWEep [:FREQuency] :STEP [:LINear]` on page 432

`[:SOURce<hw>] :LFOutput :SWEep [:FREQuency] :STEP :LOGarithmic`

on page 431

6.5.3 Level Range Settings

Access:

1. Select "Sweep" > "RF Level Sweep"
2. Select for example "Level Range".

Table 6-8: Range settings dialog: Examples of RF Level and RF Combined Sweep dialogs

> "Level Range"	> "Frequency / Level Range"

Settings

Start Level / Stop Level	134
Step Count.....	134
Spacing.....	134
Step	134
Setting Characteristics	134
Level Range	135

Start Level / Stop Level

Defines the RF level sweep range by setting the start and end values.

See [Chapter 6.2.1, "Correlating Parameters in Sweep Mode"](#), on page 119.

Remote command:

RF level sweep:

`[:SOURce<hw>] :POWer:START` on page 455

`[:SOURce<hw>] :POWer:STOP` on page 455

RF combined sweep:

`[:SOURce<hw>] :COMBined:POWer:START` on page 472

`[:SOURce<hw>] :COMBined:POWer:STOP` on page 472

Step Count

In "RF Combined Mode", defines the number of sweeps to be executed in [Mode > Single](#).

To start the sweep cycles, select [Execute Single](#).

Remote command:

`[:SOURce<hw>] :SWEep:COMBined:COUNT` on page 473

Spacing

Indicates that the instrument distributes the level steps linearly (straight proportional), i.e. the level steps have the same size.

To determine the step size, use the parameter [Step](#).

Remote command:

n.a.

Step

Sets the step width for the RF level sweep in dB.

The "RF level sweep" mode increases or decreases the level value linearly by the set value.

Remote command:

`[:SOURce<hw>] :SWEep:POWer:STEP [:LOGarithmic]` on page 468

Setting Characteristics

Selects additional quality characteristics to optimize the behavior of the RF signal level for the specific application.

"Auto"	<p>Sets the RF output level automatically according to the selected mode.</p> <p>In this mode, the instrument provides the highest dynamic range and fastest setting times, as specified in the data sheet.</p> <p>The RF signal is shortly blanked when the step attenuator is switching.</p>
"Uninterrupted"	<p>Suppresses blanking at level transitions. Frequency transitions can lead to an RF level blanking due to hardware specific switching points.</p> <p>This mode reduces the dynamic range of the instrument. The step attenuator is fixed.</p>
"Strictly Monotone"	<p>Executes signal level changes monotonically increasing or decreasing.</p> <p>The setting makes sure that increasing the level value exclusively results in an increased output level, and vice versa.</p> <p>All electronic switches, which might affect the monotonicity are fixed.</p> <p>The operation mode is useful for applications using level searching algorithms which rely on a strictly monotonous behavior.</p>
"Constant-VSWR"	<p>Suppresses output impedance variations at the RF output connector, due to changed level settings.</p>
"User"	<p>Indicates that a setting has been modified in the expert mode. The expert mode is a protected function, that requires protection level 2 password.</p>

Remote command:

[\[:SOURce<hw>\]:POWer:LBEHaviour](#) on page 452

Level Range

Shows the interruption-free range of the level that you can use in the currently selected mode.

Remote command:

[\[:SOURce<hw>\]:POWer:RANGe:LOWer?](#) on page 457

[\[:SOURce<hw>\]:POWer:RANGe:UPPer?](#) on page 457

6.6 List Mode Settings

The "List Mode" dialog contains all the functions and settings for creating and handling lists with RF frequency/level pairs including the corresponding dwell times for generating the RF signal based on these values.

Access:

- ▶ Select "Sweep" > "List mode".

The dialog contains parameters for configuring the list mode processing, entering list mode data and transferring data files from or to the instrument.

The remote commands required to define these settings are described in [Chapter 12.14.6, "SOURCE:LIST Subsystem"](#), on page 432.

- [General Settings](#)..... 136
- [List Mode Data Settings](#)..... 138
- [Import/Export Settings](#)..... 139

6.6.1 General Settings

Access:

- ▶ Select "Sweep" > "List mode".

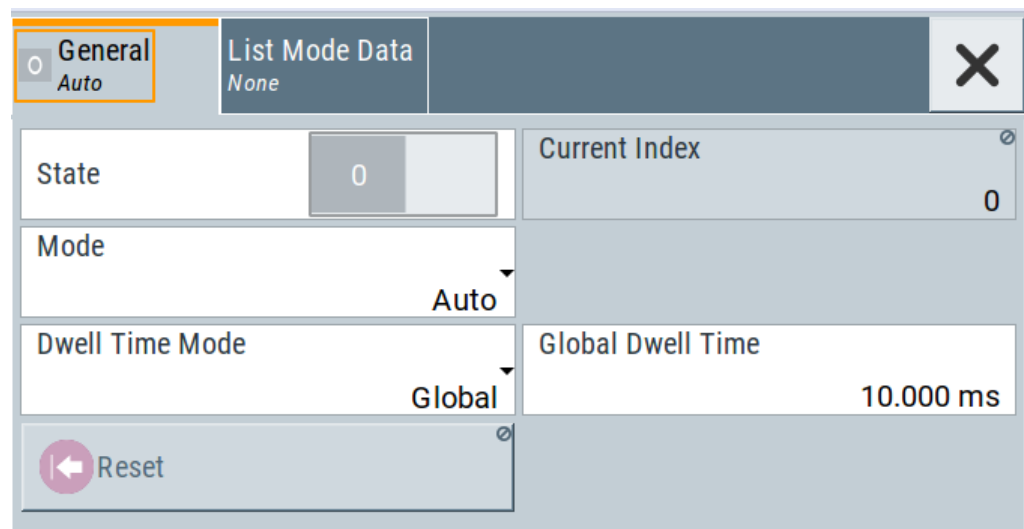

In the "General" tab, you can configure the trigger and dwell time modes for list processing and activate signal generation.

Settings

State	137
Current Index	137
Mode	137
Dwell Time Mode	137
Global Dwell Time	138
Trigger Slope	138
Reset	138
Execute Single	138

State

Activates the list mode and processes the currently selected list.

Note: Active RF frequency, RF level or RF combined sweep modes deactivate the LF sweep or List mode and vice versa.

Remote command:

[:SOURce<hw>] :FREQuency:MODE on page 413

Current Index

Sets the list index for list processing in "Step" mode. In the other modes, the index indicates the current step.

Remote command:

[:SOURce<hw>] :LIST:INDEX on page 437

Mode

Selects the mode for list processing.

See [Chapter 6.1, "Signal Generation and Triggering in the Sweep and List Modes"](#), on page 111.

"Auto" Generates the signal by processing the frequency/level value pairs of the list from the beginning to the end.
The list steps are performed automatically, controlled by the dwell time. If you switch from any mode to "Auto", signal generation always starts at the top of the list.

"Single / Extern Single" Generates the signal by processing the frequency/level value pairs of the list once from the beginning to the end after a trigger event.
The list steps are performed automatically, controlled by the dwell time. If one cycle is completed, the instrument waits for the next trigger event.

"Step / Extern Step" Generates the signal by processing the frequency/level value pairs of the list step-by-step, manually triggered.

Remote command:

[:SOURce<hw>] :LIST:TRIGger:SOURce on page 439

[:SOURce<hw>] :LIST:MODE on page 438

Dwell Time Mode

Selects either variable dwell times or a fixed dwell time to perform signal generation in list mode.

"Global" Uses the same dwell time for all lists steps, set with [Global Dwell Time](#).

"From List" Uses the dwell times from the list.
You can define the dwell time for each frequency/level value pair individually, see [Chapter 6.7, "List Editor"](#), on page 142.

Remote command:

[:SOURce<hw>] :LIST:DWELL:MODE on page 436

Global Dwell Time

Sets the dwell time for [Dwell Time Mode](#) > "Global".

Note: In case of considerable overrun conditions, the R&S SMB100B turns off the list mode.

See also "[Dwell time](#)" on page 124.

Remote command:

[\[:SOURCE<hw>\]:LIST:DWELL](#) on page 435

Trigger Slope

For "Mode = Extern Step/Single", selects the polarity of the active slope of an applied instrument trigger.

Trigger signal is expected at the Inst Trig connector.

"Positive" The rising edge of the trigger signal triggers the instrument.

"Negative" The falling edge of the trigger signal triggers the instrument.

Remote command:

[\[:SOURCE\]:INPut:TRIGger:SLOPe](#) on page 419

Reset

Resets the list to the starting point.

Remote command:

[\[:SOURCE<hw>\]:LIST:RESet](#) on page 442

Execute Single

Manually starts list processing in "Single" mode.

Remote command:

[\[:SOURCE<hw>\]:LIST:TRIGger:EXECute](#) on page 439

6.6.2 List Mode Data Settings

Access:

1. Select "Sweep" > "List mode".
2. Select "List Mode Data".

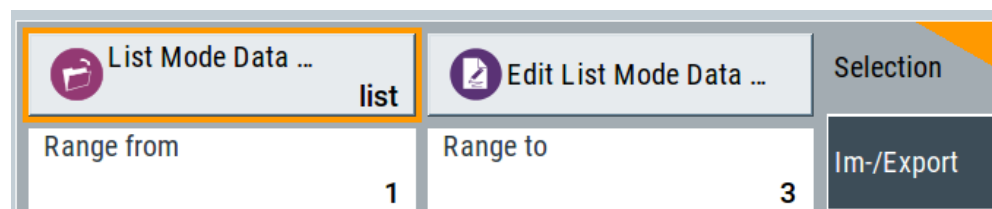

This dialog contains the parameters required for creating and editing lists, activating the learning function and selecting the list processing mode.

Settings

List Mode Data	139
Edit List Mode Data	139
List Range from/to	139

List Mode Data

Accesses the standard "Select List" dialog for selecting, creating and editing a list file. The currently loaded file is indicated.

You can create data lists with the internal editor or import externally created files, see ["Creating and handling lists"](#) on page 123.

Remote command:

[\[:SOURce<hw>\]:LIST:CATalog?](#) on page 441

[\[:SOURce<hw>\]:LIST:SElect](#) on page 442

[\[:SOURce<hw>\]:LIST:DElete](#) on page 441

[\[:SOURce<hw>\]:LIST:DElete:ALL](#) on page 441

Edit List Mode Data

Opens the editor to insert and save data lists with RF frequency, power and dwell time values, see [Chapter 6.7, "List Editor"](#), on page 142.

You find this function also in standard file select dialog, accessed via [List Mode Data](#) .

List Range from/to

Defines an index range in the current list by setting the start and stop index.

The instrument generates the signal with the values of the selected index range and ignores all other list entries.

Remote command:

[\[:SOURce<hw>\]:LIST:INDEX:START](#) on page 438

[\[:SOURce<hw>\]:LIST:INDEX:STOP](#) on page 438

6.6.3 Import/Export Settings

Access:

1. Select "Sweep" > "List Mode".

2. Select "List Mode Data" > "Im-/Export".

The "Im-/Export" dialog provides the parameters for importing or exporting files with user data in standard ASCII *.txt or *.csv file format.

The table separators and the decimal floating point numbers are customizable.

Settings

Mode	140
ASCII File Settings.....	140
Select (ASCII) Source/Select (ASCII) Destination.....	141
Select Source/Select ASCII Destination.....	141
Import / Export.....	141

Mode

Selects import or export of a data list file. The provided parameters vary according to the selected mode.

Remote command:

[:SOURCE<hw>] :LIST:DEXChange:MODE on page 445

[:SOURCE<hw>] :CORRection:DEXChange:MODE on page 412

[:SOURCE<hw>] :PULM:TRain:DEXChange:MODE on page 395

ASCII File Settings

Defines the format and the separators of the associated data file.

"Extension" Selects *.csv or *.txt format.

"Decimal Point" Sets "Point" (dot) or "Comma" as the decimal separator used in the ASCII data with floating-point numerals.

"Column Separator" Sets the separator between the columns in an ASCII table.
Available are: "Tab", "Semicolon", "Comma" or "Space".

Remote command:

[:SOURce<hw>] :LIST:DEXChange:AFILe:EXTension on page 444
 [:SOURce<hw>] :LIST:DEXChange:AFILe:SEParator:DECimal on page 444
 [:SOURce<hw>] :LIST:DEXChange:AFILe:SEParator:COLumn on page 444
 [:SOURce<hw>] :CORRection:DEXChange:AFILe:EXTension on page 410
 [:SOURce<hw>] :CORRection:DEXChange:AFILe:SEParator:DECimal
 on page 411
 [:SOURce<hw>] :CORRection:DEXChange:AFILe:SEParator:COLumn
 on page 411
 [:SOURce<hw>] :PULM:TRAIIn:DEXChange:AFILe:EXTension on page 395
 [:SOURce<hw>] :PULM:TRAIIn:DEXChange:AFILe:SEParator:DECimal
 on page 395
 [:SOURce<hw>] :PULM:TRAIIn:DEXChange:AFILe:SEParator:COLumn
 on page 395

Select (ASCII) Source/Select (ASCII) Destination

In "Mode > Import", access the file select dialog that provides standard file handling functions.

Where:

- "Select ASCII Source": defines the file to be loaded (imported)
- "Select ASCII Destination": selects the filename under that the loaded file is saved

Remote command:

[:SOURce<hw>] :LIST:DEXChange:AFILe:CATalog? on page 443
 [:SOURce<hw>] :LIST:DEXChange:AFILe:SElect on page 444
 [:SOURce<hw>] :CORRection:DEXChange:AFILe:CATalog? on page 410
 [:SOURce<hw>] :CORRection:DEXChange:AFILe:SElect on page 411
 [:SOURce<hw>] :PULM:TRAIIn:DEXChange:AFILe:CATalog? on page 396
 [:SOURce<hw>] :PULM:TRAIIn:DEXChange:AFILe:SElect on page 396

Select Source/Select ASCII Destination

In "Mode > Export", access the file select dialog that provides standard file handling functions.

Where:

- "Select Source": selects the file to be exported
- "Select ASCII Destination": defines the filename and the file path for the exported file

Remote command:

[:SOURce<hw>] :LIST:DEXChange:SElect on page 445
 [:SOURce<hw>] :CORRection:DEXChange:SElect on page 412
 [:SOURce<hw>] :PULM:TRAIIn:DEXChange:SElect on page 396

Import / Export

Imports or exports the selected data list file, depending on the current mode.

Remote command:

[:SOURce<hw>] :LIST:DEXChange:EXECute on page 443
 [:SOURce<hw>] :CORRection:DEXChange:EXECute on page 411
 [:SOURce<hw>] :PULM:TRAIIn:DEXChange:EXECute on page 396

6.7 List Editor

The "User Correction" and "List Mode" dialogs provide a build-in list editor for defining the corresponding value pairs.

The table and navigation functions of the UCOR and list mode editors have the same structure and are therefore summarized below. The access is specified for both modes, the fields and functions are explained using the example of the list mode.

Access to "Edit List Mode Data":

- ▶ "Sweep" > "List Mode" > "List Mode Data" > "Edit List Mode Data"

The editor for list mode provides a table with RF frequency and power values, an extra column for defining variable dwell times, and standard navigation functions.



	Frequency /Hz	Power /dBm	Dwell Time /s
0	1 000 000 000.000	-20.00	0.001 000
1	540 000 000.000	-5.00	0.015 000
2	4 800 000 000.000	10.00	0.002 000
3	4 200 000 000.000	25.00	0.020 000
4	4 200 000 000.000	25.00	1.000 000
5	3 600 000 000.000	-15.00	0.500 000
6			

The remote commands required to define the list mode data are described in [Chapter 12.14.6, "SOURCE:LIST Subsystem"](#), on page 432.

Access to "Edit User Correction Data":

- ▶ "Level" > "User Correction" > "Edit User Cor. Data"

	Frequency /Hz	Correction Value /dB
0	1 560 000 000.00	11.51
1	1 561 000 000.00	11.03
2	1 562 000 000.00	10.55
3	1 563 000 000.00	10.07
4	1 564 000 000.00	9.59
5	1 565 000 000.00	9.11
6		

The editor for user correction data provides a table with RF frequency and power values and standard navigation functions.

The remote commands required to define the user correction data are described in [Chapter 12.14.2, "SOURCE:CORRection Subsystem"](#), on page 404.



All columns in a row must contain values. Cells with missing values are therefore filled automatically, using the value of the previous row.

If you use **global dwell time in list mode**, consider also that the instrument uses the value set with [Global Dwell Time](#) for all list steps and not the values from the list.

Since the table and navigation functions can be assumed to be known, the following description contains a brief overview, shown by the example of the "Edit List Mdoe Data" dialog. If a function relates to a particular dialog, it is explicitly stated.

Settings

Edit List Mode Data	143
Data handling keys	144
L Go To	144
L Edit	144
L Fill with Sensor	144
L Save As/Save	144
Fill...	144

Edit List Mode Data

Table with values for list or user correction processing.

Note: Once you enter a value, the editor automatically adds preset values in the other columns. This functionality protects against data loss, otherwise incomplete rows are lost when saving. You can simply override these values.

"Frequency /Hz"

Sets the frequency values.

Remote command:

[:SOURce<hw>] :LIST:FREQuency on page 437

[:SOURce<hw>] :CORRection:CSET:DATA:FREQuency on page 407

"Power /dBm" (list mode data table)

Sets the level values.

Remote command:

[:SOURce<hw>] :LIST:POWer on page 438

"Correction Value /dBm" (user correction data table)

Sets the level values.

Remote command:

[:SOURce<hw>] :CORRection:CSET:DATA:POWer on page 407

"Dwell /s"

In list mode, sets the dwell time values.

Remote command:

[:SOURce<hw>] :LIST:DWELL:LIST on page 436

Data handling keys

Standard functions for file and data handling.



Go To ← Data handling keys

Selects a row for editing.

Edit ← Data handling keys

Enables you to insert, or delete a row or ranges within a list, and provides access to a dialog for automatic filling, see " Fill... " on page 90.

Fill with Sensor ← Data handling keys

Opens a dialog to configure the automatic filling of user correction data with an R&S NRP power sensor. Available in UCOR mode only.

See [Chapter 7.3.3, "Fill with Sensor"](#), on page 161

Save As/Save ← Data handling keys

Stores the list in a file with user-defined name and predefined file extension. To save a copy or create a file, use the "Save as" function.

Fill...

Provides parameters for filling a table automatically with user-defined values.

From 0	Range 4
Column To Fill Frequency /Hz	
Start Value 2.000 000 000 000 GHz	End Value 2.600 000 000 000 GHz
Increment Value 200.000 000 000 MHz	
<input checked="" type="checkbox"/> Fill	

To fill the table, select "Fill".

Note: Once you enter a value or fill a column, the editor automatically adds preset values in the other columns. This functionality protects against data loss, otherwise incomplete rows will be lost when saving. You can simply override these values.

"From / Range"

Defines the start line and number of lines to be filled.

"Column To Fill"

Selects, if the column is filled up with frequencies in Hz, levels in dBm or dwell times in s.

"Start Value / End Value"

Sets the start value for frequency, level or dwell time. The end value is read only and depends on the increment value and the range.

"Increment Value"

Determines the step size.

"Fill"

Fills the column specified in "Column To fill".

6.8 How to Generate a Signal in List or Sweep Mode

This section shows you how to configure a varying RF output signal for both, the list and sweep modes.

To configure the frequency sweep signal

- For a step-by-step description, see [Chapter 3.3.2, "Generating an RF Frequency Sweep Signal"](#), on page 41.

Example: Fast changing frequency and level settings in list mode

The following example shows you how to generate an amplitude modulated RF signal based on list mode data.

General workflow

Since any change of the hardware settings or list entries can affect the RF signal characteristics directly, we recommend that you proceed as follows:

1. Configure the modulation settings.
Activate the RF signal.
2. Wait until the hardware settings have settled.
3. Create a list file.
4. Configure the list mode.
5. Activate list mode.

To configure amplitude modulation and switch RF on

1. Press [Preset] to start from an initial state.
2. Select "Modulation" > "Amplitude Modulation > On".
3. Select "Level" > "RF ON" to activate RF signal generation.

To create list mode data

1. Select "Sweep" > "List Mode".
2. In the "List Mode Data" tab, select "List Mode Data > New".
3. Enter the filename `ListMode_Test` for the data list and confirm with "Ok".
The instrument creates a file and stores it in the `/var/user/` directory.
4. Select "Edit List Mode Data".
5. Enter the first values "Frequency > 2", "Power > 0" and "Dwell > 2".
6. Enter further frequency, power and dwell time values in the same way.
7. Select "Save" and close the dialog.

To configure the list mode and start signal generation

1. In the "General" tab, select "List Mode > Auto".
2. Select "Dwell Time Mode > From List".
3. Switch state to "On".
4. Select "General > State > On".

The instrument continuously generates an amplitude-modulated RF signal whose frequency and level values change according to the dwell times, as defined in the list.

With active list mode, the generator displays no frequency and level values in the status bar, but you can check the following parameters.

- In the list mode dialog, the current index indicates the steps of the signal generation.

- In remote control mode, you can query:
 - The current state with `[:SOURce<hw>] :LIST:RUNNING?`
 - Current parameters with the commands `FREQ?`, `POW?` and `LIST:DWEL?`.

7 Improving Level Performance

To adapt the RF output signal to specific needs in your application, the R&S SMB100B offers different functions:

- **Attenuator**
The R&S SMB100B is equipped with a step attenuator that enables you to vary the amplitude of the RF signal in a wide range. It is characterized by low VSWR (voltage standing wave ratio) over the full level and frequency range, and provides highest level accuracy and noise suppression.
See ["About the attenuator"](#) on page 148.
- **Automatic Level Control (ALC)**
The automatic level control system ensures stable RF signals with highest absolute level accuracy over temperature and time.
See ["About ALC"](#) on page 151.
- **User correction (UCOR)**
The user correction function allows you to compensate frequency responses of external setups (e.g. losses of cables) and achieve a stable input signal over frequency directly at the DUT.
See ["About UCOR"](#) on page 153.
- **Power sensors**
The R&S SMB100B has excellent absolute level accuracy. Since a DUT is rarely connected directly to the generator, but with cables or other components, the reference level shifts from the RF output to the DUT. To calibrate this level with high accuracy, i.e. in the tenth dB range, you can connect an R&S NRP power sensor to the generator. The power sensor transmits its readings to the generator, which indicates these measurement results in the display. Thus you can adjust the RF output power of the generator until you reach the target level at the DUT.
See [Chapter 7.4, "Using Power Sensors"](#), on page 165

7.1 Attenuator

About the attenuator

The step attenuator is an electronic device without mechanical components, providing fast and wear free level settings.

According to the requirements of your application, you can select different attenuator characteristics.

The following are examples of test requirements and the corresponding configuration:

- **Automatic configuration**
Select standard operation mode ("Auto"), in which the generator adjusts the attenuation of the RF output signal automatically.
- **DUT tests under low signal to noise conditions**
Low output power is suitable to test the behavior of a DUT under low signal to noise conditions.

- Uninterrupted level settings with constant VSWR
A fix attenuation value is required for obtaining uninterrupted level settings with constant VSWR.
The configuration "RF Off Mode > Unchanged" ensures that constant VSWR is maintained if you turn the signal off and on again.
- Noise sensitive applications
The parameter "RF OFF Mode > Full Attenuation" sets maximum attenuation and thus suppresses noise when you turn off the RF signal.

7.1.1 Attenuator Settings

Access:

- ▶ Select "Level" > "Level > Attenuator".

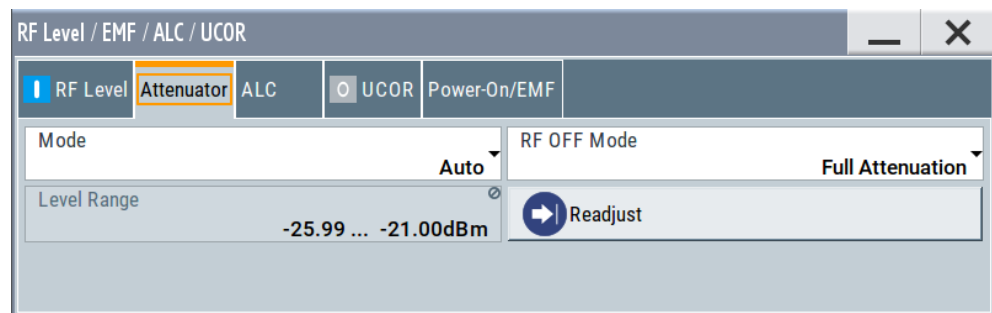

In the "Attenuator" dialog, you can select the operating mode of the electronic step attenuator.

The remote commands required to define these settings are described in [Chapter 12.12, "OUTPut Subsystem"](#), on page 355 and [Chapter 12.14.10, "SOURce:POWer Subsystem"](#), on page 449.

Settings

Mode	149
Level Range	150
RF OFF Mode	150

Mode

Determines the operating mode of the step attenuator.

"Auto"	Adjusts the attenuator settings automatically.
"Fixed"	Fixes the attenuator and amplifier paths for the current RF level and provides signal output with constant output VSWR. The resulting level range is indicated under " Level Range " on page 150.

Remote command:

:OUTPut<hw>:AMODE on page 356

Level Range

Shows the interruption-free range of the level that you can use in the selected mode.

Remote command:

`:OUTPut<hw>:AFIXed:RANGe:LOWer?` on page 357

`:OUTPut<hw>:AFIXed:RANGe:UPPer?` on page 357

RF OFF Mode

Determines the state of the step attenuator, when the RF signal is switched off.

The setting is not affected by an instrument preset ([Preset] key or *RST) and the "Save/Recall" function. It is reset only by factory preset.

"Unchanged" Freezes the setting of the step attenuator.
Use this mode if a constant VSWR (Voltage Standing Wave Ratio) is required.

"Full Attenuation"
Switches to the maximum attenuation.
Use this mode for applications that require a high level of noise suppression.

Remote command:

`[:SOURce<hw>] :POWer:ATTenuation:RFOff:MODE` on page 451

7.1.2 Reverse Power Protection

The R&S SMB100B is equipped with a reverse power protection circuit.

The reverse power protection is tripped when the power of signals reflected from the load or external signals applied to the RF output get too high. A relay opens and interrupts the internal connection to the RF output. This condition is indicated in the status bar by the "Overload" status message.

Overload

If an "Overload" status message is indicated in the status bar, perform the following:

- Remove the cause for the overload
- Press the [RF on/off] key to reset the overload protection

The RF input is activated when the overload protection is reset.

Remote command:

`:OUTPut<hw>:PROTection:TRIPped?` on page 357

`:OUTPut<hw>:PROTection:CLEar` on page 357

7.2 Automatic Level Control (ALC)

The R&S SMB100B is equipped with an automatic level control (ALC) unit to obtain best RF level accuracy.

About ALC

ALC is an adaptive control system to stabilize the RF output level. It continuously monitors the current level and adjusts it to keep a steady state over temperature and time.

ALC is active in almost all applications by default. However, when **pulse modulation** with short pulses is used, the ALC uses table-based level settings with table values depending on the pulse width.

Also note that ALC can detect incorrect values in **multi-transmitter** test setups. If multiple generators are coupled, reverse power can affect the ALC readings, which leads to an incorrect RF output power.

ALC states and their effects

The following description basically explains the ALC states and their principle of operation:

- "Auto"
Adjusts the output level to the operating conditions automatically. ALC is active in almost all operating modes.
- "On"
Activates the internal level control permanently, regardless of the operating conditions.
Note: This mode is not useful for pulse modulation with narrow pulses and low repetition rates, since the automatic level control can not settle in time. Set ALC "Table & On" instead.
- "Off (Sample & Hold)"
Deactivates ALC, but still allows you to maintain a constant output level. The R&S SMB100B switches briefly in the CW mode and enables ALC to adjust the level to the set target value. The instrument freezes this setting, turns off ALC again, and switches back to the operating mode.
- "Off (Table)"
Deactivates internal level control loop. The instrument calculates every level setting using the attenuation values from the internal (ALC) table. Level attenuation between two table values is done with linear interpolation. This mode enables you to perform a fast and strictly monotonic, but not quite as precise level adjustment.
- "Table & On"
Starts with the associated value of the internal level table and then activates the automatic level control. This mode achieves maximum level accuracy and fast setting times.
If pulse modulation is applied, this mode ensures fast level settings even with narrow pulses at low repetition rate.

The R&S SMB100B displays the level control setting as a status message in the info line.

7.2.1 ALC Settings

Access:

- ▶ Select "Level" > "Automatic Level Control".

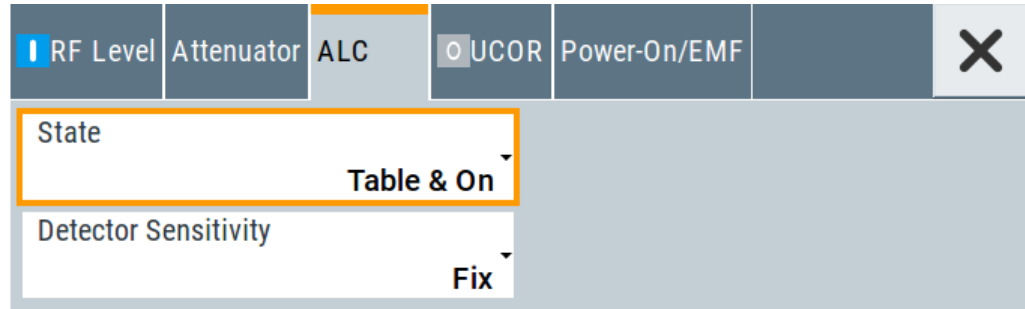

In the "ALC" dialog, you can configure the settings for the automatic level control of the RF signal to achieve optimal accuracy.

The remote commands required to define these settings are described in [Chapter 12.14.10, "SOURCE:POWER Subsystem"](#), on page 449.

Settings

State.....	152
Detector Sensitivity.....	152

State

Selects the internal level control mode.

"Auto"	Selects the most appropriate ALC mode automatically.
"On"	Activates ALC permanently.
"Off (Sample & Hold)"	Deactivates the ALC, but allows you to recalibrate the level at each frequency and level change. The value remains up to the next change.
"Off (Table)"	Controls the level using the attenuation values of the internal ALC table.
"Table & On"	Starts with the attenuation setting from the internal ALC table and continues with automatic level control.

For further details on the individual settings, an overview of the functionality and details on what is to be considered, see ["ALC states and their effects"](#) on page 151.

Remote command:

`[:SOURCE<hw>] :POWER:ALC [:STATe]` on page 450

Detector Sensitivity

Determines the path of the internal level detector.

The level detector of the ALC has multiple paths distinguished by their sensitivity.

"Auto"	Selects the detector path automatically, according to the given level. This mode is the recommended operation mode.
"Low"	Selects the detector path with low sensitivity. This setting is intended for signals with high internal electronic levels.
"Med"	Selects the path with medium sensitivity. This setting corresponds to normal mode. It is intended for signals with medium internal electronic levels.
"High"	Selects the detector path with high sensitivity, intended for signals with low internal electronic levels.
"Fix"	Fixes the last set sensitivity setting.

Remote command:

`[:SOURce<hw>] :POWER:ALC:DSEnsitivity` on page 451

7.3 User Correction

The R&S SMB100B supports a correction function to compensate external losses, caused, for example, by the RF cable, to achieve a precise target input level at the DUT.

The signal at the RF outputs of the R&S SMB100B is flat. However, the DUT is usually not connected directly to the outputs of the instrument but rather via connecting cables. Components like cables, power combiners, switches or mixers can affect the signal flatness at the DUT input.

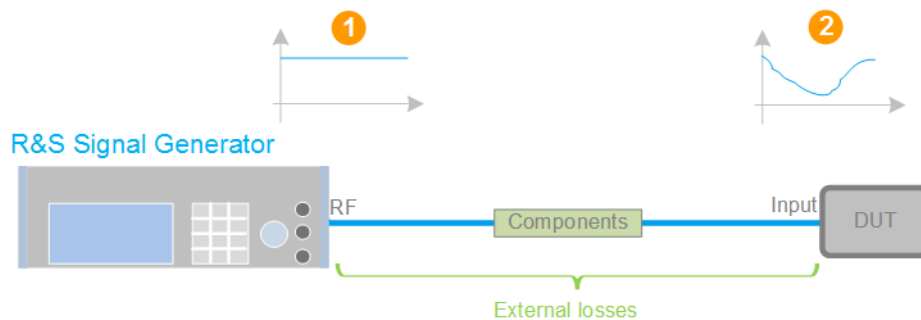

Figure 7-1: Effect of external losses on the signal flatness at the DUT input

DUT	= Device under test
Components	= Designation of all components between the measurement equipment and the DUT, e.g. cables
1	= Flat signal at the outputs of the R&S SMB100B
2	= Signal received at the DUT, incl. the external losses

About UCOR

User correction (UCOR) is a method that determines the external level loss over a frequency range in advance, see [Figure 7-2](#).

The difference between the generator output level and the level at the DUT determines the correction value at the respective frequency. Alternatively, the attenuation characteristics over a certain frequency range of, for example, RF cables are also specified in the associated data sheet.

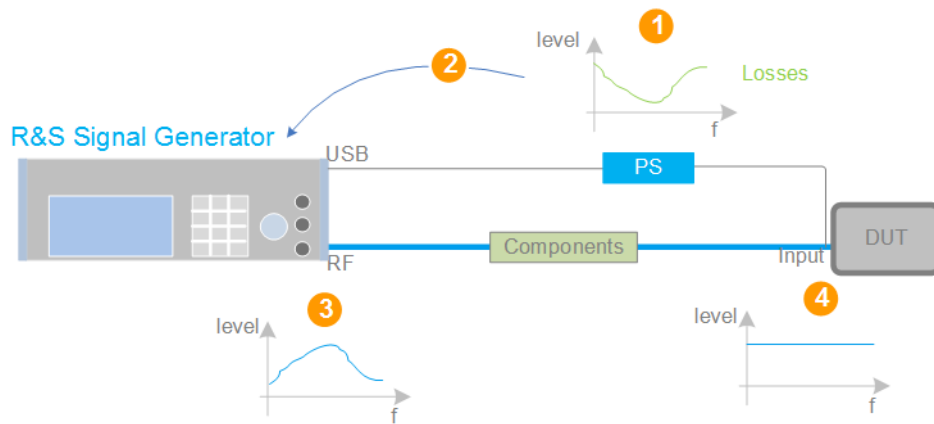

Figure 7-2: Understanding the principle of user correction

DUT	= Device under test
Compo- nents	= Designation of all components between the measurement equipment and the DUT, e.g. cables
PS	= Power sensor, e.g. R&S NRP, connected at the DUT's input and the USB connector of the R&S SMB100B
1	= Power sensor measures the level over a frequency range, where the collected values correspond to the losses caused by the components between the R&S SMB100B and the DUT
2	= Obtain the correction data by inverting the collected data; load the correction parameters in the R&S SMB100B
3	= In the R&S SMB100B, the RF signal is pre-processed with the correction values so that the signal at the outputs is the inverted version of the external losses
4	= Received at the DUT input, the pre-processed signal is flat

With active **UCOR**, the generator adds the correction value internally and thus increases the output level by exactly the amount of the loss between its output and the DUT. For frequencies which are not contained in the list, the level correction is calculated by interpolation of the closest correction values.

Possible ways for configuring the user correction values

You can configure correction values in the following ways:

- **Internally**

- Use the built-in table editor in the "UCOR > Edit User Correction Data" dialog. Once defined, user correction values can be saved in a file. Files with correction data can be exported, for example, to exchange configuration between instruments or to modify the file content with an external program and reload them again.
- Using the corresponding remote-control commands. Note that you have to create a user correction file first.

- **Externally**

Create a file with correction values as a CSV file with Microsoft Excel, with a Notepad or a similar tool and save it with the predefined extension. Transfer the file to and load it into the instrument.

UCOR file format

Files containing correction data are simple files in text or comma-separated value (CSV) file format. The filename is user-definable; the file extension is *.ucor.

The file contains a list of correction values, one row per frequency and correction value pair; a new line indicator separates the correction values.

For file handling, use the standard functions in the "File Manager", see [Chapter 9.8, "Using the File Manager"](#), on page 205.

Collecting correction data

To fill the frequency and power values in the correction table, use one of the following options:

- **Manually**, row by row.
- Fill the table **automatically** with linearly interpolated values, calculated from value range and step size.
- Acquire the real frequency response characteristics of the used component with the **R&S NRP power sensor**, see [Understanding the principle of user correction](#).

Using a power sensor for frequency response measurements

Consider the following when using R&S NRP power sensors to measure the correction values:

- Measure the level directly at the input of the DUT.
- Use the internal correction functions of an R&S NRP power sensor to increase the measurement accuracy.
- Use S-parameter to consider the impact of any two-port device like an adapter between the signal generator and the sensor input.



Interactions and characteristics

Activated user correction is effective in all operating modes.

The RF output level ($Level_{RF}$) is the sum of the level value and the correction for the particular frequency:

$$Level_{RF} = \text{"Status bar > Level"} + \text{"UCOR"}$$

Activated user correction is indicated by the status indication "Lev Ucor" in the "Level" tile.

7.3.1 User Correction Settings

Access:

1. Select "Level" > "User Correction".
2. If you already have created a file with user correction data:
 - a) Select "UCOR Data > navigate to the file *.uco > Select".
 - b) Proceed with [step 4](#).
3. If you need to create a file:
 - a) Select "UCOR Data > New".
 - b) Enter the filename `UCOR_Data` and confirm with "Ok".
 - c) Choose the file and confirm with "Select".
 - d) Select "Edit UCOR Data".
 - e) To fill the user correction data table, proceed as described in [Chapter 6.7, "List Editor"](#), on page 142.
4. Select "RF Level > RF State > On".
5. Select "User Cor. Data > State > On".

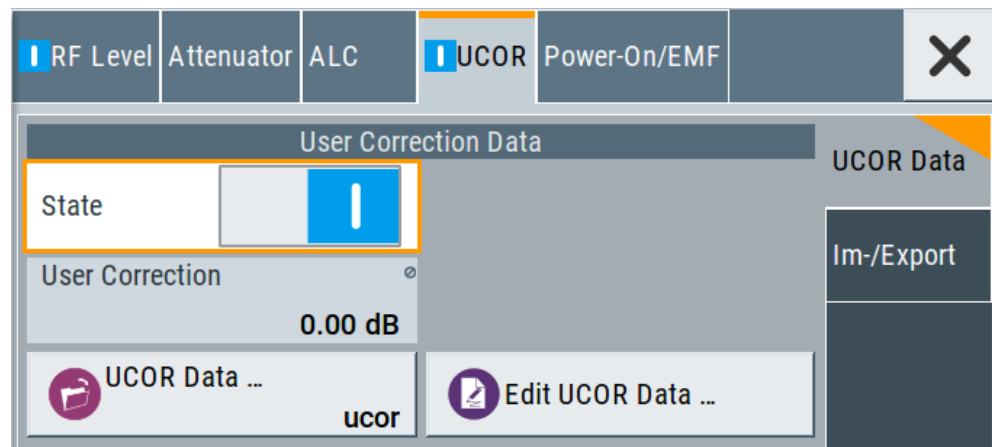

The "UCOR" dialog contains all settings for creating and handling files with user-defined level correction values.

The remote commands required to define these settings are described in [Chapter 12.14.2, "SOURCE:CORREction Subsystem"](#), on page 404.

Settings

State.....	157
User Correction.....	157
UCOR Data.....	157
Edit UCOR Data.....	157

State

Activates user correction.

The R&S SMB100B displays the status icon "Lev Ucor" in the "Level" panel.

Remote command:

[\[:SOURCE<hw>\]:CORREction\[:STATe\]](#) on page 409

User Correction

Indicates the corrected level value for a specific frequency point.

Remote command:

[\[:SOURCE<hw>\]:CORREction:VALue?](#) on page 408

UCOR Data

Accesses the standard "File Select" function of the instrument. The provided navigation possibilities in the dialog are self-explanatory.

Files with user correction values are files with predefined file extension *.uco. When a file is selected, the dialog indicates the filename.

You can create the file internally in the table editor or externally.

- To select an existing file, select "Select List > navigate to the file *.uco > Select"
- Use the general editor function to create internally new file or to edit an existing one.
- Use the standard file manager function to load externally created files to the instrument.

Remote command:

[\[:SOURCE\]:CORREction:CSET:CATalog?](#) on page 409

[\[:SOURCE<hw>\]:CORREction:CSET\[:SElect\]](#) on page 408

[\[:SOURCE\]:CORREction:CSET:DElete](#) on page 410

Edit UCOR Data

Opens the build-in table editor to define a new correction table or edit an existing one.

See also:

- [Chapter 6.7, "List Editor"](#), on page 142
- [" Fill... "](#) on page 90
- [Chapter 7.3.3, "Fill with Sensor"](#), on page 161

7.3.2 List Editor

The "User Correction" and "List Mode" dialogs provide a build-in list editor for defining the corresponding value pairs.

The table and navigation functions of the UCOR and list mode editors have the same structure and are therefore summarized below. The access is specified for both modes, the fields and functions are explained using the example of the list mode.

Access to "Edit List Mode Data":

- ▶ "Sweep" > "List Mode" > "List Mode Data" > "Edit List Mode Data"

The editor for list mode provides a table with RF frequency and power values, an extra column for defining variable dwell times, and standard navigation functions.

	Frequency /Hz	Power /dBm	Dwell Time /s
0	1 000 000 000.000	-20.00	0.001 000
1	540 000 000.000	-5.00	0.015 000
2	4 800 000 000.000	10.00	0.002 000
3	4 200 000 000.000	25.00	0.020 000
4	4 200 000 000.000	25.00	1.000 000
5	3 600 000 000.000	-15.00	0.500 000
6			

The remote commands required to define the list mode data are described in [Chapter 12.14.6, "SOURCE:LIST Subsystem"](#), on page 432.

Access to "Edit User Correction Data":

- ▶ "Level" > "User Correction" > "Edit User Cor. Data"

	Frequency /Hz	Correction Value /dB
0	1 560 000 000.00	11.51
1	1 561 000 000.00	11.03
2	1 562 000 000.00	10.55
3	1 563 000 000.00	10.07
4	1 564 000 000.00	9.59
5	1 565 000 000.00	9.11
6		

The editor for user correction data provides a table with RF frequency and power values and standard navigation functions.

The remote commands required to define the user correction data are described in [Chapter 12.14.2, "SOURCE:CORRection Subsystem"](#), on page 404.



All columns in a row must contain values. Cells with missing values are therefore filled automatically, using the value of the previous row.

If you use **global dwell time in list mode**, consider also that the instrument uses the value set with **Global Dwell Time** for all list steps and not the values from the list.

Since the table and navigation functions can be assumed to be known, the following description contains a brief overview, shown by the example of the "Edit List Mdoe Data" dialog. If a function relates to a particular dialog, it is explicitly stated.

Settings

Edit List Mode Data.....	159
Data handling keys	159
L Go To.....	160
L Edit.....	160
L Fill with Sensor.....	160
L Save As/Save.....	160
Fill.....	160

Edit List Mode Data

Table with values for list or user correction processing.

Note: Once you enter a value, the editor automatically adds preset values in the other columns. This functionality protects against data loss, otherwise incomplete rows are lost when saving. You can simply override these values.

"Frequency /Hz"

Sets the frequency values.

Remote command:

[\[:SOURce<hw>\]:LIST:FREQuency](#) on page 437

[\[:SOURce<hw>\]:CORRection:CSET:DATA:FREQuency](#) on page 407

"Power /dBm" (list mode data table)

Sets the level values.

Remote command:

[\[:SOURce<hw>\]:LIST:POWer](#) on page 438

"Correction Value /dBm" (user correction data table)

Sets the level values.

Remote command:

[\[:SOURce<hw>\]:CORRection:CSET:DATA:POWer](#) on page 407

"Dwell /s"

In list mode, sets the dwell time values.

Remote command:

[\[:SOURce<hw>\]:LIST:DWELL:LIST](#) on page 436

Data handling keys

Standard functions for file and data handling.



Go To ← Data handling keys

Selects a row for editing.

Edit ← Data handling keys

Enables you to insert, or delete a row or ranges within a list, and provides access to a dialog for automatic filling, see "Fill..." on page 90.

Fill with Sensor ← Data handling keys

Opens a dialog to configure the automatic filling of user correction data with an R&S NRP power sensor. Available in UCOR mode only.

See [Chapter 7.3.3, "Fill with Sensor"](#), on page 161

Save As/Save ← Data handling keys

Stores the list in a file with user-defined name and predefined file extension. To save a copy or create a file, use the "Save as" function.

Fill...

Provides parameters for filling a table automatically with user-defined values.

From 0	Range 4
Column To Fill Frequency /Hz	
Start Value 2.000 000 000 000 GHz	End Value 2.600 000 000 000 GHz
Increment Value 200.000 000 000 MHz	
<input checked="" type="checkbox"/> Fill	

To fill the table, select "Fill".

Note: Once you enter a value or fill a column, the editor automatically adds preset values in the other columns. This functionality protects against data loss, otherwise incomplete rows will be lost when saving. You can simply override these values.

"From / Range"

Defines the start line and number of lines to be filled.

"Column To Fill"

Selects, if the column is filled up with frequencies in Hz, levels in dBm or dwell times in s.

"Start Value / End Value"

Sets the start value for frequency, level or dwell time. The end value is read only and depends on the increment value and the range.

"Increment Value"

Determines the step size.

"Fill"

Fills the column specified in "Column To fill".

7.3.3 Fill with Sensor

Access:

1. Select "Level" > "User Correction".
2. Select "UCOR Data > navigate to the file *.ucor > Select".
3. Select "Edit UCOR Data > Fill With Sensor...".

This dialog contains parameters for filling a table automatically with sensor readings.



To fill the table, select "Execute".

For information on power sensors and how to use them, see [Chapter 7.5, "How to Calibrate the Power Level with an R&S NRP Power Sensor"](#), on page 176.

Settings

Fill User Correction Data with Sensor	161
Used SMB100B Settings For Measurement	162

Fill User Correction Data with Sensor

- "Sensor"
Displays connected sensors for selection.
- "List To Fill"
Indicates the used list.

- "Use SParameter"
Indicates whether SParameter correction in the R&S NRP power sensor is used.
- "Include Zeroing"
Performs a zeroing procedure before acquiring the user correction data to improve precision.
No signal is applied to the sensor during zeroing. RF output is temporarily switched off during that time.
When unchecked, the zeroing procedure is skipped. However, the RF signal level might be blanked shortly. This setting is useful if blanking of RF is undesirable or the absence of power at the sensor cannot be guaranteed.
- "Execute"

The "Execute" button is only enabled if a sensor is detected and the user correction list contains at least one frequency value.

Remote command:

[\[:SOURCE<hw>\]:CORREction:ZERoing:STATe](#) on page 409

[\[:SOURCE<hw>\]:CORREction:CSET:DATA\[:SENSor<ch>\]\[:POWER\]:SONCe](#)
on page 408

Used SMB100B Settings For Measurement

Displays the settings relevant for the measurement.

"Modulation" Indicates the modulation state

"Amplitude" Shows the currently set level.

Remote command:

n.a.

7.3.4 Import/Export List Files

Access:

1. Select one of the following:
 - "Sweep" > "List mode".
 - "Level" > "User Correction".
 - "Modulation > Pulse Modulation > Pulse Generator > Pulse Mode = Train".

2. Select "Import/Export".

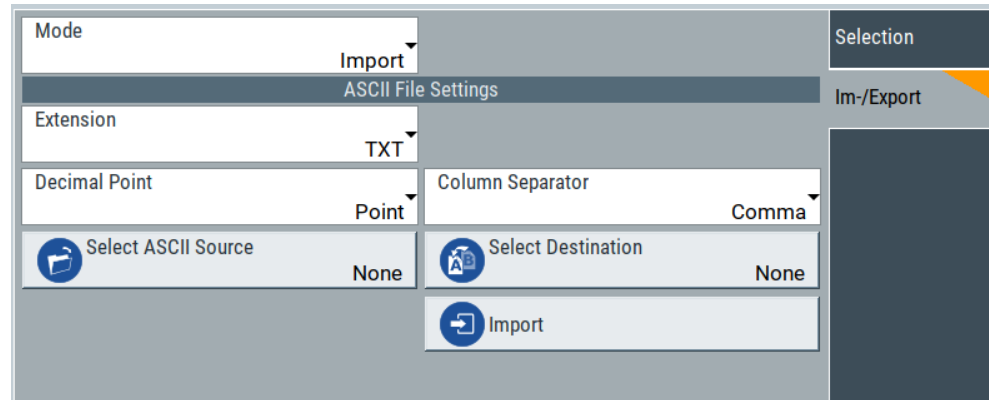

Figure 7-3: Im-/Export dialog (example with UCOR settings)

The "Import/Export" dialog contains all functions and settings to import externally created list data or to export it accordingly. You can process and store a list in the formats `*.txt` (ASCII), or `*.csv` (plain text with identical sequence of fields). The table separators and the decimal floating point numbers are customizable.

Settings

Mode	163
ASCII File Settings.....	163
Select (ASCII) Source/Select (ASCII) Destination.....	164
Select Source/Select ASCII Destination.....	164
Import / Export.....	164

Mode

Selects import or export of a data list file. The provided parameters vary according to the selected mode.

Remote command:

- [\[:SOURCE<hw>\]:LIST:DEXChange:MODE](#) on page 445
- [\[:SOURCE<hw>\]:CORrection:DEXChange:MODE](#) on page 412
- [\[:SOURCE<hw>\]:PULM:TRain:DEXChange:MODE](#) on page 395

ASCII File Settings

Defines the format and the separators of the associated data file.

- "Extension" Selects `*.csv` or `*.txt` format.
- "Decimal Point" Sets "Point" (dot) or "Comma" as the decimal separator used in the ASCII data with floating-point numerals.
- "Column Separator" Sets the separator between the columns in an ASCII table. Available are: "Tab", "Semicolon", "Comma" or "Space".

Remote command:

- [\[:SOURCE<hw>\]:LIST:DEXChange:AFILe:EXTension](#) on page 444
- [\[:SOURCE<hw>\]:LIST:DEXChange:AFILe:SEParator:DECimal](#) on page 444

[\[:SOURCE<hw>\]:LIST:DEXChange:AFIle:SEParator:COLumn](#) on page 444

[\[:SOURCE<hw>\]:CORRection:DEXChange:AFIle:EXTension](#) on page 410

[\[:SOURCE<hw>\]:CORRection:DEXChange:AFIle:SEParator:DECimal](#)
on page 411

[\[:SOURCE<hw>\]:CORRection:DEXChange:AFIle:SEParator:COLumn](#)
on page 411

[\[:SOURCE<hw>\]:PULM:TRAIIn:DEXChange:AFIle:EXTension](#) on page 395

[\[:SOURCE<hw>\]:PULM:TRAIIn:DEXChange:AFIle:SEParator:DECimal](#)
on page 395

[\[:SOURCE<hw>\]:PULM:TRAIIn:DEXChange:AFIle:SEParator:COLumn](#)
on page 395

Select (ASCII) Source/Select (ASCII) Destination

In "Mode > Import", access the file select dialog that provides standard file handling functions.

Where:

- "Select ASCII Source": defines the file to be loaded (imported)
- "Select ASCII Destination": selects the filename under that the loaded file is saved

Remote command:

[\[:SOURCE<hw>\]:LIST:DEXChange:AFIle:CATalog?](#) on page 443

[\[:SOURCE<hw>\]:LIST:DEXChange:AFIle:SElect](#) on page 444

[\[:SOURCE<hw>\]:CORRection:DEXChange:AFIle:CATalog?](#) on page 410

[\[:SOURCE<hw>\]:CORRection:DEXChange:AFIle:SElect](#) on page 411

[\[:SOURCE<hw>\]:PULM:TRAIIn:DEXChange:AFIle:CATalog?](#) on page 396

[\[:SOURCE<hw>\]:PULM:TRAIIn:DEXChange:AFIle:SElect](#) on page 396

Select Source/Select ASCII Destination

In "Mode > Export", access the file select dialog that provides standard file handling functions.

Where:

- "Select Source": selects the file to be exported
- "Select ASCII Destination": defines the filename and the file path for the exported file

Remote command:

[\[:SOURCE<hw>\]:LIST:DEXChange:SElect](#) on page 445

[\[:SOURCE<hw>\]:CORRection:DEXChange:SElect](#) on page 412

[\[:SOURCE<hw>\]:PULM:TRAIIn:DEXChange:SElect](#) on page 396

Import / Export

Imports or exports the selected data list file, depending on the current mode.

Remote command:

[\[:SOURCE<hw>\]:LIST:DEXChange:EXECute](#) on page 443

[\[:SOURCE<hw>\]:CORRection:DEXChange:EXECute](#) on page 411

[\[:SOURCE<hw>\]:PULM:TRAIIn:DEXChange:EXECute](#) on page 396

7.4 Using Power Sensors

The R&S SMB100B works with most of the R&S NRP power sensors and thus supports various application tasks. Using power sensors, you can for example determine attenuation characteristics of downstream equipment or cables. You can use the measured values to compensate the losses with internal control functions or with an external control circuit in real time.

R&S NRP sensors are highly accurate standalone measuring devices, suitable for a wide range of applications. The devices communicate directly with the signal generator, calculate the average or peak power internally, include S-parameter correction and return the measurement results to the generator.

The R&S SMB100B works with any sensor of the R&S NRP series and can perform up to four power measurements simultaneously.



Check the firmware version of the R&S NRP sensors regularly. Update the firmware, if necessary.

For updates, see the Rohde & Schwarz website <http://www.rohde-schwarz.com> in section "Power Meters & Voltmeters".

- [Connecting R&S NRP Power Sensors to the R&S SMB100B](#)..... 165
- [NRP Sensor Mapping](#)..... 166
- [NRP Power Viewer](#)..... 168

7.4.1 Connecting R&S NRP Power Sensors to the R&S SMB100B

R&S NRP sensors are connected to the R&S SMB100B in the following ways:

- Connection to the USB connector
Requires the following cables, depending on the used sensor type:
 - R&S NRP-ZKU (USB interface cable) for R&S NRPxx power sensors
 - R&S NRP-Z3 or R&S NRP-Z4 (USB adapter cables) for sensors of the R&S NRP-Zxx family
- Connection via R&S NRP-Z5 sensor hub
The R&S NRP-Z5 USB sensor hub (high-speed USB 2.0) can host up to 4 R&S NRP sensors. It provides simultaneous internal and external triggering of all connected sensors.
Requires additional cables, depending on the used output connector of the hub. Choose one of the following:
 - Short extension cable R&S NRP-Z2 for connection to the sensor connector. This six-pole connection provides the external trigger capability.
 - Standard USB cable (USB type A to USB type B) to any USB type A connector of the R&S SMB100B. This connection does not support external triggering.
- Connection via USB hub with external power supply unit
Requires the following cables, depending on the used sensor type:
 - R&S NRP-ZKU (USB interface cable) for R&S NRPxx power sensors

- R&S NRP-Z3 or R&S NRP-Z4 (USB adapter cables) for sensors of the R&S NRP-Zxx family
- Connection via LAN for R&S NRPxxxSN/xxxTN/xxxAN power sensors
Using the Ethernet interface requires PoE (Power over Ethernet) to provide the electrical power.
To establish the connection, you can use:
 - A PoE Ethernet switch, e.g. R&S NRP-ZAP1 and an RJ-45 Ethernet cable.
 - A PoE injector and an RJ-45 Ethernet cable.

For details, see the description R&S®NRP®Series Power Sensors Getting Started.

Detection and mapping

The R&S SMB100B automatically detects a connected R&S NRP power sensor and indicates it in the "NRP Power Viewer" and "NRP Sensor Mapping" dialogs.

By default, sensors 1 to 4 are assigned to the sensors at the USB connectors, according to their sequence of connection.

You can change the default mapping in the [NRP Sensor Mapping](#) dialog.



On connection, the R&S SMB100B immediately starts the measurement of a detected R&S NRP power sensor. If you perform an instrument preset ([Preset] key or *RST), the R&S SMB100B stops the measurements. The connection and the mapping of the power sensors remain, the measurements must be restarted.

7.4.2 NRP Sensor Mapping



The "NRP Sensor Mapping" lists all R&S NRP sensors detected by the instrument.

Any R&S NRP sensor that supports the USB legacy protocol and is connected to one of the USB interfaces, is detected automatically and added to the list. Vice versa, the R&S SMB100B removes a sensor from the list, when it is disconnected.

R&S NRP sensors that are connected via LAN or use the USBTMC protocol are not automatically detected. They are detected by the scan search function.

Access:

- ▶ Select "Power Sens" > "NRP Sensor Mapping".

	Sensor Name	Protocol	Connector	Mapping
1	NRP18S-100654	Legacy		2
2	NRP18S-100654	Visa		
3				
4				
5				
6				
7				

Scan  Start

The dialog lists all detected R&S NRP sensors for selection and mapping. You can also browse the network for sensors.

The detected sensors are characterized by the used protocol and the corresponding connector icon. In the "Mapping" column, you can assign the sensor to one of the available sensor channels. The list can contain several entries but the R&S SMB100B can only use up to four sensors simultaneously.

The remote commands required to define these settings are described in [Chapter 12.13, "SENSe, READ, INITiate and SLISt Subsystems"](#), on page 358.

Settings

Sensor Mapping List	167
Scan	167

Sensor Mapping List

Displays a list of all sensor entries with information on the sensor name, the used protocol, the connector and the assigned mapping.

If a sensor is connected via LAN or uses the USBTMC protocol, its protocol is indicated as "Visa".

Remote command:

[:SLISt\[:LIST\]?](#) on page 361

[:SLISt:ELEMent<ch>:MAPPING](#) on page 361

[:SLISt:SENSor:MAP](#) on page 362

Scan

Scans the network and the USB connections for sensors connected via the VISA communication protocol, i.e. sensors that are addressed via LAN or USBTMC.

Sensors communicating via the USB legacy protocol are detected automatically.

Remote command:

`:SLISt:SCAN[:STATe]` on page 361

7.4.3 NRP Power Viewer

The R&S SMB100B features the power viewer function for measuring or monitoring signals with R&S NRP power sensors.

7.4.3.1 About

The R&S SMB100B can perform up to four power measurements simultaneously.

Depending on the signal characteristic (CW, AM, pulsed, etc.) or the parameter to be measured (average, peak, etc...) a suitable R&S power sensor must be used.

About the measuring principle, averaging filter, filter length, and achieving stable results

A sensor measures the average or peak RF power of the source continuously. The measurement results are displayed in the "NRP Power Viewer" dialog.

The power viewer function uses **averaging filters** for getting a stable readout.

Measurement results could be interfered for instance by too much noise in your setup, by a bad suppression of harmonics or non harmonics or when you reach the sensitivity level of your power sensor.

Measurements are continuously repeated in a predefined time window. The measurement result is obtained by averaging the measured values for the last $2N$ time windows. This approach is referred to as a **two-step averaging process**.

The factor of 2 in the formula arises because the output signals from the microwave detector are chopped at the same rate as the time windows to suppress low-frequency noise. An independent measured value can only be obtained from two consecutive values.

The variable N in the formula indicates the **filter length**. The filter length then directly influences the measurement time. The filter length can be selected automatically or it can be manually set to a fixed value.

Depending on the R&S NRP power sensor type, the manual setting of the filter length varies in resolution:

- Resolution = 1 for the R&S NRPxx power sensor family
- Resolution = 2^n for R&S NRP-Zxx power sensors, with $n = 1$ to 16

Follow the following general recommendation to find out the **optimum filter length**:

- Always start a measurement in auto mode ("Filter > Auto").
Check if the measurement results are sufficient.
- If the power is not constant, select the filter length manually ("Filter > User").
Trigger the "Auto Once" function to search for the optimum filter length for the current measurement conditions.
The estimated value is indicated as filter length.

- If the target measurement accuracy value is known, select "Filter > Fixed Noise". The averaging factor is selected automatically and so that the sensor's intrinsic noise (two standard deviations) does not exceed the specified noise content.
- Different sensor types achieve the same filtering result with different filter and time window lengths.

The time window length depends on the sensor type:

- For most sensors, it is fixed to 20 ms.
- For the R&S NRP-Z81 sensor, it is 10 µs.
The R&S NRP-Z81 uses filter length that is 1000 times larger than the filter length for other sensors.

About zeroing

Activates the auto zero function.

Zeroing calibrates the external power sensor by adjusting its reading at zero signal power. For this purpose, the RF power source must be switched off or disconnected from the sensor. If a Rohde & Schwarz power sensor receives an input power during the zeroing process, it aborts zeroing and generates an error message. Zeroing takes a few seconds, depending on the sensor model. Refer to the documentation of your power sensor for more information.

Tips for zeroing

When to perform zeroing:

- During warm up after switching on or connecting the instrument
- After a substantial change of the ambient temperature
- After fastening the power sensor module to an RF connector at high temperature
- After several hours of operation
- When low-power signals are to be measured, e.g. less than 10 dB above the lower measurement limit.
- Switch off the RF power source for zeroing, but do not disconnect it from the power sensor. This proceeding keeps the thermal equilibrium, and the zeroing process also compensates the noise that superimposes the measured signal (e.g. from a broadband amplifier).

Related settings and functions

- Measurements-related settings, like results, filter, filter length:
[Chapter 7.4.3.2, "NRP Power Viewer Settings"](#), on page 170
- Software version of the connected power sensor:
`:SENSe<ch>[:POWer]:TYPE?` on page 370
- Acquisition of level correction data:
[Chapter 7.3, "User Correction"](#), on page 153

Additional information

See Rohde & Schwarz website <http://www.rohde-schwarz.com> in section "Power Meters & Voltmeters" for:

- R&S NRP power sensor manual.
- Information on the R&S NRP-Z5 sensor hub and the available accessories.
- Sensor software updates.

7.4.3.2 NRP Power Viewer Settings

Access:

- ▶ Select "Power Sens" > "NRP Power Viewer".

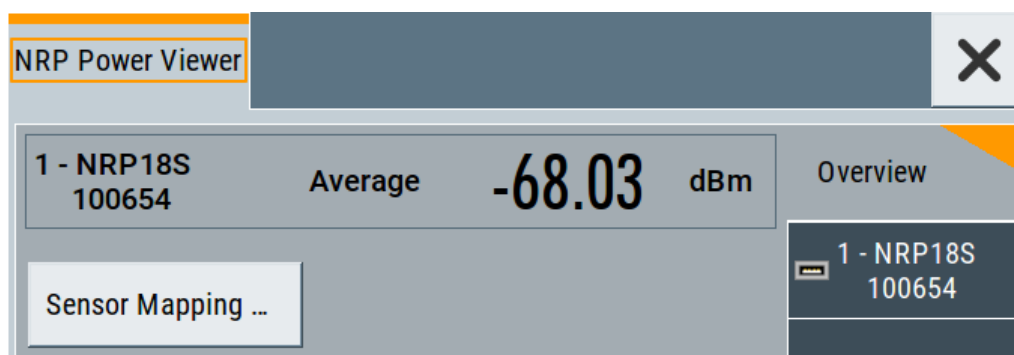

The "Overview" tab shows the list of detected sensors, and provides a separate tab per sensor.

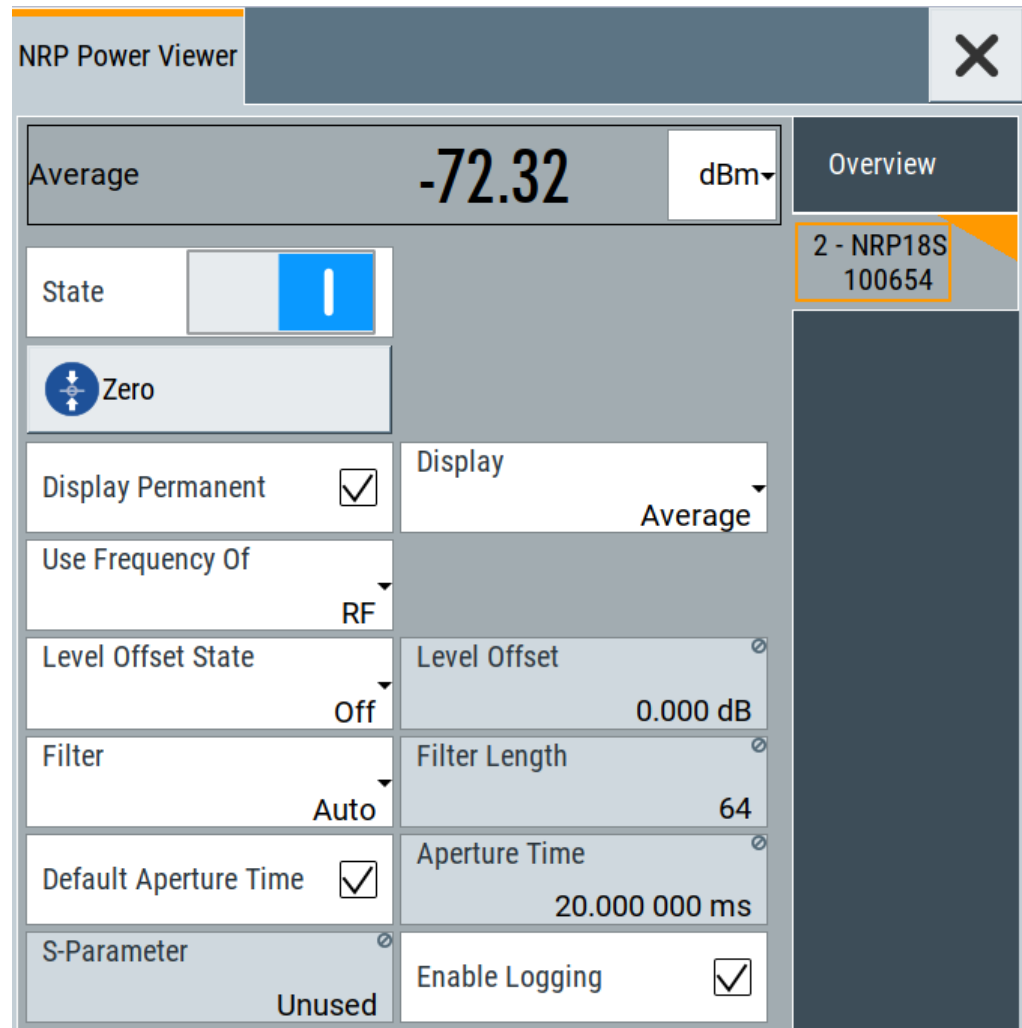

A sensor tab contains all parameters for configuring the sensor settings, like average or peak display, reference source, filter and level offset.

The remote commands required to define these settings are described in [Chapter 12.13, "SENSe, READ, INITiate and SLISt Subsystems"](#), on page 358, including the triggering of the measurement and the retrieval of measurement results. See also [Chapter 7.5, "How to Calibrate the Power Level with an R&S NRP Power Sensor"](#), on page 176.

Settings

Sensor type and serial number.....	172
Level (Peak) / Level (Average)	172
Sensor Mapping.....	172
Sensor settings.....	172
L State	172
L Zero	172

L Display.....	173
L Permanent	173
L Use Frequency Of.....	173
L Frequency	173
L Level Offset State,Level Offset.....	173
L Filter.....	174
L Filter Length.....	174
L Noise/Signal Ratio.....	174
L Auto Once.....	174
L Timeout.....	175
L Default Aperture Time.....	175
L Aperture Time.....	175
L S-Parameter	175
L Enable Logging.....	175

Sensor type and serial number

Indicates the type and the serial number of a selected R&S NRP power sensor, and the channel the sensor is assigned to.

The displayed **Level (Peak) / Level (Average)** values correspond to the particular sensor.

Remote command:

`:SENSe<ch>[:POWER]:TYPE?` on page 370

`:SENSe<ch>[:POWER]:SNUMber?` on page 369

Level (Peak) / Level (Average)

Indicates the measured peak or average level value.

You can also change the unit for the results display: Watt, dBm or dB μ V.

Note: Peak level measurements are provided if the power sensor supports this feature.

Remote command:

`:READ<ch>[:POWER]?` on page 362

`:SENSe<ch>:UNIT[:POWER]` on page 363

Sensor Mapping

Accesses the **NRP Sensor Mapping** dialog.

Sensor settings

One tab per sensor provides the corresponding settings.

State ← Sensor settings

Activates level measurement.

Remote command:

`:INITiate<hw>[:POWER]:CONTinuous` on page 362

To query the availability of a sensor at a given connector, use the command :

`SENSe<ch>[:POWER]:STATus[:DEVICE]?` on page 369.

Zero ← Sensor settings

Activates the auto zeroing.

For details, see "[About zeroing](#)" on page 169.

Remote command:

`:SENSe<ch>[:POWer]:ZERO` on page 370

Display ← Sensor settings

Sets the display mode for power readings.

Permanent ← Display ← Sensor settings

Activates the permanent indication of the power measurement result on the left side of the home screen.

You can activate the permanent display for several sensors.

Remote command:

`:SENSe<ch>[:POWer]:DISPlay:PERManent:STATe` on page 365

Use Frequency Of ← Sensor settings

Selects the source for measurement.

- | | |
|--------|---|
| "RF" | The R&S SMB100B transfers the RF frequency and level settings to the R&S power sensor automatically. Thus you achieve power readings of high accuracy, irrespective from the connected sensor type. |
| "User" | Sets a user defined frequency. |

Example:

If you have a frequency converting device between the generator and the DUT. If the frequency converter doubles the frequency, you can set twice the frequency in the R&S SMB100B. The R&S power sensor considers this RF frequency setting.

Set the parameter [Frequency](#) to the measurement's frequency.

Remote command:

`:SENSe<ch>[:POWer]:SOURce` on page 369

Frequency ← Sensor settings

Defines the frequency value if "Source > User" is used.

Remote command:

`:SENSe<ch>[:POWer]:FREQuency` on page 368

Level Offset State,Level Offset ← Sensor settings

Activates and defines a level offset which is considered in the power measurement result. The level offset value is always expressed in dB, irrespective of the display of the measurement result.

This function allows you to consider, for example, an attenuator in the signal path.

Remote command:

`:SENSe<ch>[:POWer]:OFFSet` on page 368

`:SENSe<ch>[:POWer]:OFFSet:STATe` on page 368

Filter ← Sensor settings

Selects the way the length of the used filter is defined.

See also ["About the measuring principle, averaging filter, filter length, and achieving stable results"](#) on page 168.

"Auto"	Selects the filter length automatically and adjusts it to the measured value. The value is indicated with the parameter Filter Length . When high output power is applied, the filter length and therefore the measurement time can be short. When low output power is applied, the filter length and therefore the measurement time is increased which reduces the considered noise content in your measurement.
"User"	The filter length is defined manually, with the parameter Filter Length . As the filter length works as a multiplier for the time window, constant filter length results in a constant measurement time. Values 1 and 2N are allowed.
"Fixed Noise"	The averaging factor is taken automatically in accordance to the value Noise/Signal Ratio . Thus, the sensor's intrinsic noise (2 standard deviations) does not exceed the specified noise content. To avoid long measurement times when the power is too low, set a Timeout . Timeout is the maximum acceptable measurement time which limits the averaging factor and therefore leads to a more unstable readout.

Remote command:

[:SENSe<ch>\[:POWER\]:FILTer:TYPE](#) on page 367

Filter Length ← Sensor settings

Sets or indicates the filter length, depending on the selected filter mode.

- "Filter > Auto" indicates the automatically adjusted filter length.
- "Filter > User" enables you to set the filter length manually.
- "Filter > Fixed Noise" hides the setting parameter.

Remote command:

[:SENSe<ch>\[:POWER\]:FILTer:LENGth:AUTO?](#) on page 365

[:SENSe<ch>\[:POWER\]:FILTer:LENGth\[:USER\]](#) on page 365

Noise/Signal Ratio ← Sensor settings

For [Filter > Fixed Noise](#), sets the noise content.

Remote command:

[:SENSe<ch>\[:POWER\]:FILTer:NSRatio](#) on page 366

Auto Once ← Sensor settings

Searches the optimum filter length for the current measurement conditions. The result is indicated with the parameter [Filter Length](#).

See also ["About the measuring principle, averaging filter, filter length, and achieving stable results"](#) on page 168.

Remote command:

[:SENSe<ch>\[:POWER\]:FILTer:SONCe](#) on page 367

Timeout ← Sensor settings

For "Filter > Fixed Noise", sets a time limit for the averaging process.

Remote command:

`:SENSe<ch>[:POWer]:FILTer:NSRatio:MTIME` on page 366

Default Aperture Time ← Sensor settings

The sensor default setting is sufficient. Disable this parameter to specify a user-defined aperture time per sensor, if, for example, the readings vary.

To obtain stable readings, set the [Aperture Time](#) exactly to one modulation period.

Remote command:

`:SENSe<ch>[:POWer]:APERTure:DEFault:STATE` on page 363

Aperture Time ← Sensor settings

If "Use Default Aperture Time > Off", defines the acquisition time per sensor.

For example, to obtain a sufficient low average value, set the aperture time exactly to one modulation period.

Remote command:

`:SENSe<ch>[:POWer]:APERture:TIME` on page 364

S-Parameter ← Sensor settings

Lists the S-Parameter correction data files retrieved for the connected power sensor. To activate the correction data, select the corresponding file.

S-Parameter correction is used to mathematically shift the reference plane to the DUT by considering the S-parameters for any components connected upstream of the sensor.

The S-Parameter table can be changed with the S-Parameters tool, provided as part of the free R&S NRP Toolkit software. For more information, refer to the manual of the connected R&S NRP power sensor.

Remote command:

`:SENSe<ch>[:POWer]:CORRection:SPDevice:STATE` on page 364

`:SENSe<ch>[:POWer]:CORRection:SPDevice:LIST?` on page 365

`:SENSe<ch>[:POWer]:CORRection:SPDevice:SElect` on page 364

Enable Logging ← Sensor settings

Activates recording of R&S NRP power sensor readings in a log file.

There is 1 log file per sensor. The log files are created automatically and filled in continuously. They are text files with predefined filename `SensLog<n>.txt`, where `<n>` indicates the connected sensor. Log files are stored on the internal memory, in the directory `/var/user/SensorLogging`.

Each log file contains the measured value (2 readings when you work with peak sensors), the sensor type, and the measurement time (timestamp). Logged data is not overwritten. When a new measurement is started, the collected logging data is appended in the log file.

Check the used disc space regularly and remove log files to maintain storage capacity.

Note: The logging function is intended for measurements with long time intervals. It is suitable source for data reconstructions if the connection to the sensor was interrupted.

Remote command:

:SENSe<ch>[:POWER]:LOGGing:STATe on page 368

7.5 How to Calibrate the Power Level with an R&S NRP Power Sensor

Using a R&S NRP power sensor and the user correction function of the instrument, you can compensate external frequency responses. The R&S SMB100B utilizes the readings of the power sensor and creates a correction value table for controlling the output level during operation.

To connect the R&S NRP to the R&S SMB100B

1. Connect the power sensor.
See [Chapter 7.4.1, "Connecting R&S NRP Power Sensors to the R&S SMB100B"](#), on page 165.
2. Select "Power Sens" > "NRP Sensor Mapping".
3. If the sensor is not detected automatically, select "Scan > Start".
The instrument scans the network and the USB connections for connected sensors and lists all detected R&S NRP sensors in the mapping table.
4. In the "Mapping" column, assign the sensor to a sensor channel (see [Chapter 7.4.2, "NRP Sensor Mapping"](#), on page 166
5. Close the dialog.

To configure and calibrate the R&S NRP in the R&S SMB100B

Provided the power sensor is connected to the R&S SMB100B and is assigned to a sensor channel, we recommend that you calibrate and configure the power sensor in the "NRP Power Viewer" dialog.

1. Select "Level" > "RF ON > Off"
2. Select "Power Sens" > "NRP Power Viewer".

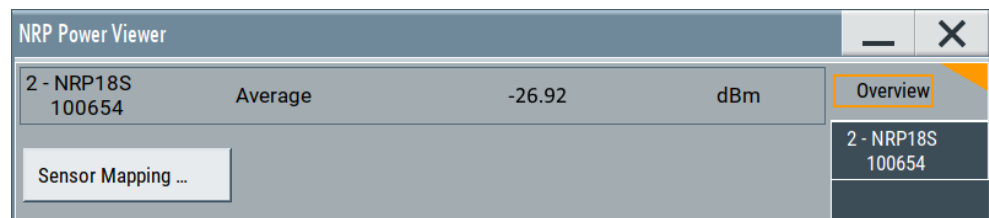

3. If the R&S SMB100B has detected several connected power sensors, select the tab of the sensor you want to use.
4. Select "Zero" to start zeroing of the sensor.

How to Calibrate the Power Level with an R&S NRP Power Sensor

Note: Always turn the RF power off or disconnect the sensor from RF before zeroing, since the function calibrates the power sensor at zero signal power.

The zeroing process takes a few seconds, depending on the power sensor type.

5. Configure additional parameters for the selected sensor as required.
6. Select "State > On".
7. Close the dialog.

To create user correction data with an R&S NRP and the R&S SMB100B

We assume, that the power sensor is connected, assigned and ready for operation.

1. Select "Level" > "User Correction".

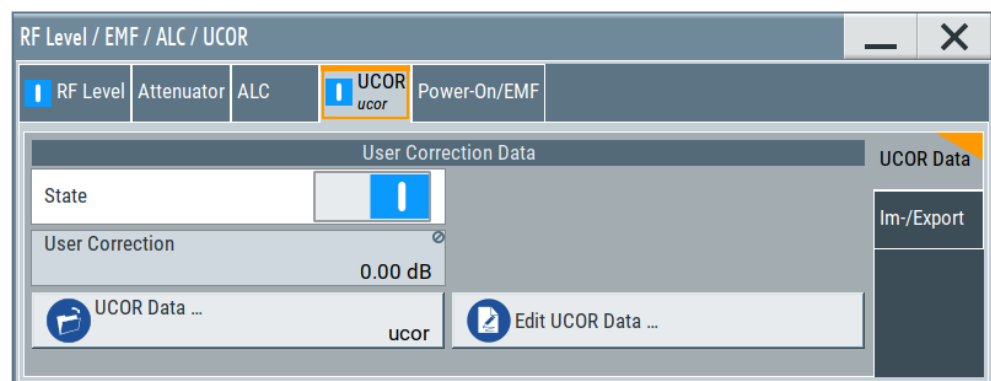

2. Select "UCOR Data" > "UCOR Data...."
3. Create a file: "New" > Filename and confirm with "OK".
4. Select the new file with "Select".
5. Select "Edit UCOR Data...".
6. Select "Edit" > "Fill".

The "Fill Table" dialog enables you to fill in the values of the columns automatically.

7. To fill in the frequency column:

From	0	Range	15
Column To Fill	Frequency / Hz		
Start Value	1.560 000 000 00 GHz	End Value	1.574 000 000 00 GHz
Increment Value	1.000 000 00 MHz		
<input checked="" type="checkbox"/> Fill			

- a) Select "Select Column To Fill > Frequency / Hz".
- b) Select "Range > e.g. 15" to determine the number of values.

- c) Select "Start Value > e.g. 1.56 GHz".
- d) Select "Increment Value > e.g. 1 MHz", to determine the frequency steps.
- e) Select "Fill", to insert the frequency values.

The "Fill" function also fills the column of the "Correction Value / dB" values with a predefined value, since empty cells lead to the data loss of the entire line. If you need different values, you can change them manually, or you can use the automatic function "Fill with Sensor" as described in the next steps.

- 8. Select "Fill with Sensor".

The "Fill User Correction Data With Sensor" dialog provides an overview of the sensor configuration.

- 9. Select "Execute".

The R&S SMB100B successively sets each frequency point, reads the measured power of the sensor and fills in the value in the correction table.

Edit User Correction Data		
	Frequency /Hz	Correction Value /dB
0	1 560 000 000.00	-11.51
1	1 561 000 000.00	-11.03
2	1 562 000 000.00	-10.58
3	1 563 000 000.00	-9.80
4	1 564 000 000.00	-9.46

Buttons: Go To, Edit, Fill with Sensor ..., Save As ..., Save

- 10. Select "Save" to save the data in the file.

- 11. Close the dialog.

To perform power leveling calibration with user correction data

We assume that a user correction file is available in the user directory of the R&S SMB100B or on a memory stick or in a shared directory.

If you have created and saved the file immediately before this step, the file is loaded in the "User Correction" dialog automatically. Otherwise you can load a previously saved file.

- 1. Select "Level" > "User Correction".

2. Select "UCOR Data" > "UCOR Data...", if there is no file loaded already.
3. Select the directory and file you want to use.
4. Load the file with "Select".
5. To view the file content, select "Edit UCOR Data...".
6. Select "UCOR Data" > "State" > "On" to apply the user correction values.

When you activate the RF output, the R&S SMB100B considers the user correction data and adjusts the signal level accordingly to compensate external frequency responses.

8 Reference Oscillator

The R&S SMB100B is equipped with an internal reference oscillator that generates a reference frequency of 10 MHz. It is used as internal reference source for the synthesizer.

Alternatively, you can apply an external reference signal. If equipped with the required options, the R&S SMB100B can process external reference frequency in the range 1 MHz to 100 MHz and the 1 GHz reference frequency.

Regardless of the used reference source (internal or external), the R&S SMB100B always provides the configured reference frequency at the output. You can use it, for example to synchronize several interconnected instruments, see [Chapter 8.5, "Using the Reference Frequency for Instruments Synchronization"](#), on page 185, for an overview of typical test situations.

The reference oscillator settings are not affected by an instrument preset ([Preset] key or *RST) and the "Save/Recall" function. They are reset only by factory preset.

8.1 Required Options

R&S SMB100B base unit equipped with the following options:

- Reference oscillator (R&S SMBB-B1/-B1H)
- 1 GHz reference (R&S SMBB-B3)
- 1 MHz to 100 MHz flexible reference input (R&S SMBB-K704)

For more information, see data sheet.

8.2 Reference Frequency Settings

Access:

1. Select ""Frequency" > Reference Frequency".

Reference Frequency	Reference Output	Adjustment	
<div style="display: flex; justify-content: space-between; align-items: center;"> ← Set To Default ✕ </div>			
Source	External	<div style="display: flex; justify-content: flex-end; align-items: center;"> 🔍 Show Connector ... </div>	
Deactivate RF Output <i>(if external reference is missing)</i>	<input checked="" type="checkbox"/>		
External Reference Frequency	10 MHz		
Synchronization Bandwidth	Wide		
Nominal Synchronization Bandwidth	400 Hz	Minimum Locking Range	+/- 100 ppm

In the "Reference Frequency" tab, you can select the reference frequency signal source and the frequency and synchronization bandwidth mode of an external reference signal.

- Observe the information on the home screen, "Frequency" tile.

The "Frequency" tile indicates the current reference oscillator configuration, including the reference oscillator source, external reference frequency (rounded value) and output connector. A warning symbol in the "Frequency" tile indicates a missing external source.

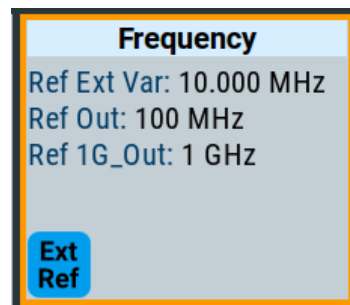

The remote commands required to define these settings are described in [Chapter 12.14.11, "SOURCE:ROSCillator Subsystem"](#), on page 458.

Settings:

Set to Default	182
Source	182
Show Connector	182
Deactivate RF Output (if external reference is missing)	182
External Reference Frequency	182

Variable Reference Frequency.....	183
Synchronization Bandwidth.....	183
Nominal Synchronization Bandwidth.....	183
Minimum Locking Range.....	183

Set to Default

Calls the default settings.

Remote command:

`[:SOURce] :ROSCillator :PRESet` on page 460

Source

Selects the reference frequency source.

"Internal" Uses the internal reference oscillator, either with calibrated or a user-defined [Adjustment Value](#).

"External" Uses an external reference signal.

Note: If the external reference is missing, the R&S SMB100B issues a warning message and indicates the icon  (external reference missing).

To set the frequency of the external reference, see "[External Reference Frequency](#)" on page 182.

Remote command:

`[:SOURce] :ROSCillator :SOURce` on page 460



Show Connector

Accesses a dialog that displays the physical location of the selected connector on the front/rear panel of the instrument.

Deactivate RF Output (if external reference is missing)

Turns off the RF output when the external reference signal is selected, but no signal is supplied.

This function prevents that no improper RF signal due to the missing external reference signal is used for measurements. A message indicates that the RF output is deactivated.

Remote command:

`[:SOURce] :ROSCillator :EXTernal :RFOff [:STATe]` on page 460

External Reference Frequency

Selects the frequency of the external reference signal.

Set the reference output frequency with the parameters in the [Reference Output Settings](#) dialog.

"10 MHz" Selects 10 MHz for the external reference frequency signal.

"100 MHz, 1 GHz"

Option: R&S SMBB-B3

The R&S SMB100B locks its internal 500 MHz reference oscillator on the 100 MHz or 1 GHz reference.

Selects the external reference frequency.

"Variable" Option: R&S SMBB-K704
The external reference signal has an arbitrary frequency, within the permissible range from 1 MHz to 100 MHz.

Remote command:

`[:SOURCE] :ROSCillator:EXTernal:FREquency` on page 460

Variable Reference Frequency

Option: R&S SMBB-K704

Sets the variably settable external reference frequency.

Remote command:

`[:SOURCE] :ROSCillator:EXTernal:FREquency:VARiable` on page 460

Synchronization Bandwidth

Selects the synchronization bandwidth for an external reference signal.

The resulting bandwidth is indicated by the parameter [Nominal Synchronization Bandwidth](#).

"Narrow" The internal reference oscillator is synchronized to the external signal with narrow bandwidth.

This setting is recommended if the phase noise of the external signal is worse than the phase noise of the internal OCXO.

"Wide" Synchronizes the internal oscillator to the external signal with the maximum possible bandwidth.

This mode is the recommended standard mode and for precise reference sources of high spectral purity.

Note: If the frequency of the external reference signal is outside the locking range of the internal reference oscillator, spurs due to the difference of the internal and external reference frequency are generated in the reference PLL.

The R&S SMB100B issues an error message.

For more information, see data sheet.

Remote command:

`[:SOURCE] :ROSCillator:EXTernal:SBANdwidth` on page 461

Nominal Synchronization Bandwidth

Indicates the nominal synchronization bandwidth for the selected [External Reference Frequency](#) and the [Synchronization Bandwidth](#).

Remote command:

`[:SOURCE] :ROSCillator:EXTernal:NSBandwidth?` on page 462

Minimum Locking Range

Indicates the minimum locking range for the selected [External Reference Frequency](#) and the [Synchronization Bandwidth](#).

Remote command:

`[:SOURCE] :ROSCillator:EXTernal:MLRange?` on page 461

8.3 Reference Output Settings

Access:

1. Select ""Frequency" > Reference Frequency".
2. Select "Reference Output".

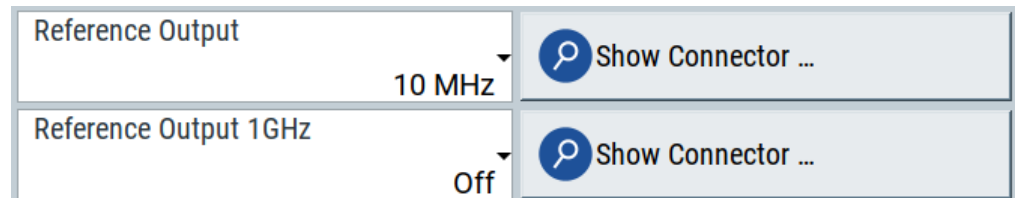

In the "Reference Output" tab, you can set the reference frequency value at the output connectors.

As a result of parameter dependencies, "Preset This Parameter" sometimes does not affect output dialogs.

The remote commands required to define these settings are described in [Chapter 12.14.11, "SOURce:ROSCillator Subsystem"](#), on page 458.

Settings:

Reference Output/1 GHz Reference Output	184
Show Connector	184

Reference Output/1 GHz Reference Output

Selects frequency reference output signal for downstream instruments.

"Off"	Deactivates the reference signal output.
"10 MHz"	Derives a signal with 10 MHz frequency from the internal reference oscillator and provides this signal at the output.
"100 MHz"	Option: R&S SMBB-B3 Derives a signal with 100 MHz frequency from the internal reference oscillator and provides this signal at the output.
"1 GHz"	Option: R&S SMBB-B3 Provides the 1 GHz reference frequency signal at the output.
"Input Signal (loop through)"	Passes the external reference frequency to the output directly.

Remote command:

[\[:SOURce\]:ROSCillator:OUTPut:FREQuency:MODE](#) on page 462

[\[:SOURce\]:ROSCillator:OUTPut:ALternate:FREQuency:MODE](#) on page 462



Show Connector

Accesses a dialog that displays the physical location of the selected connector on the front/rear panel of the instrument.

8.4 Adjustment Settings

Access:

1. Select "Frequency" > "Reference Frequency".
2. Select "Adjustment".

Adjustment Active <input checked="" type="checkbox"/>	Adjustment Value 0
---	---

Settings:

Adjustment Active	185
Adjustment Value	185

Adjustment Active

Selects the adjustment mode.

- | | |
|-------|--|
| "Off" | Uses the calibrated internal reference frequency. |
| "On" | Allows you to apply a deviation to the internal reference frequency, according to your requirements.
Enter the value in the Adjustment Value field. |

Remote command:

`[:SOURce] :ROSCillator [:INTernal] :ADJust [:STATe]` on page 463

Adjustment Value

Sets a user-defined adjustment value for the internal reference frequency. This value takes effect when it is activated with [Adjustment Active](#).

- "0" represents the calibrated state.
- The setting range depends on the reference oscillator type and its factory calibration value.

Note:

The setting is not affected by an instrument preset ([Preset] key or *RST) and the "Save/Recall" function. It is reset only by factory preset.

Remote command:

`[:SOURce] :ROSCillator [:INTernal] :ADJust:VALue` on page 463

8.5 Using the Reference Frequency for Instruments Synchronization

Test setups with two or more instruments often require that the instruments use a common reference frequency. Depending on the availability of external reference frequency source and its quality, the instruments are connected and configured in different ways.

This section gives an overview of the possible test setups and the related settings. The following situations are considered:

- External reference source is not available or the **built-in reference oscillator** is of better quality than the external source
(see ["Distributing the internal 10 MHz reference signal to further instruments"](#) on page 186)
- **Clean external reference source** with quality exceeding the quality of the built-in reference oscillator
(see ["Using external reference source"](#) on page 187)
- **Interfered or noisy external reference signal**
(see ["Deriving 10 MHz from the external reference frequency"](#) on page 188)
- **1 GHz reference coupling** for phase coherence of the RF signals with enhanced long-term phase stability
(see ["Sharing the 1 GHz reference frequency to obtain phase-coherent signals"](#) on page 186)

Connectors overview

Use the "Show Connector" function to indicate the connector on the front/rear panel:

- ["Ref In/Ref Out"](#) on page 37
- 1GHz ["Ref In/Ref Out"](#) on page 37

Distributing the internal 10 MHz reference signal to further instruments

The internal reference oscillator provides the reference frequency:

- Internal $f_{\text{ref}} = 10 \text{ MHz}$ (10 MHz at connector Ref Out)
- [Source](#) = "Internal"
- [Reference Output/1 GHz Reference Output](#) = "10 MHz"

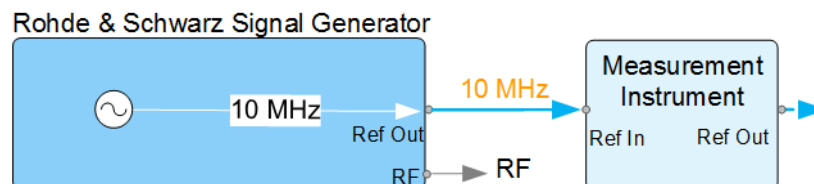

Figure 8-1: Synchronizing instruments using the internal 10 MHz reference signal of the R&S SMB100B

Ref In, Ref Out = Connectors

Sharing the 1 GHz reference frequency to obtain phase-coherent signals

Compared to 10 MHz, a 1 GHz reference signal significantly improves the achievable phase stability between two signal sources. Because the synchronization frequency increases by a factor of 100, the relative phase fluctuations between the sources can be reduced.

1 GHz at connector Ref In 1GHz and 1 GHz at Ref Out 1GHz

- External $f_{\text{Ref}} = 1 \text{ GHz}$

Using the Reference Frequency for Instruments Synchronization

- Source = "External"
- External Reference Frequency = "1 GHz"
- 1GHz Reference Output = "1 GHz"

Using external reference source

If you have a clean external reference signal with 10 MHz or 100 MHz frequency, for example, you can **directly pass it to the output**. The signal quality remains the same.

10 MHz, 100 MHz at connector Ref Out and Ref In

- External f_{Ref} = 10 MHz or 100 MHz
(earlier RF hardware versions: 5 MHz, 10 MHz, 13 MHz)
- Source = "External"
- Reference Output = "10 MHz, 100 MHz" or "Input Signal (loop through)"
(earlier RF hardware versions: 5 MHz, 10 MHz, 13 MHz)
- Set the synchronization bandwidth according to the requirements of the application.

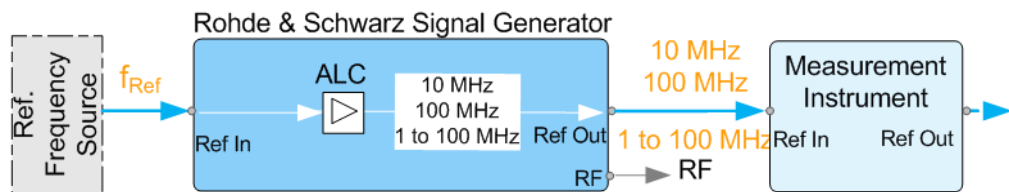

Figure 8-2: Synchronizing instruments with a 10 MHz external reference signal

Ref. Frequency Source = e.g., Rohde & Schwarz signal analyzer

f_{Ref} = 10 MHz, 100 MHz, 1 MHz to 100 MHz external reference frequency

Ref In, Ref Out = Connectors

You can forward reference frequency between 1 MHz and 100 MHz directly to the output in the same way.

Note: R&S SMB100B can forward only a defined range of external reference frequencies, see data sheet.

- External f_{Ref} = 1 MHz to 100 MHz
(**1 MHz to 100 MHz at connector Ref In and Ref Out**)
- Source = "External"
- Variable Reference Frequency = "Variable"
- External Reference Frequency = current external frequency
- Reference Output = "Input Signal (loop through)" or specify the reference frequency the synchronized instrument supports
- Set the synchronization bandwidth according to the requirements of the application.

Deriving 10 MHz from the external reference frequency

10 MHz reference frequency can be derived from the following external reference signals:

- 10 MHz from internal oscillator locked to external input
- 100 MHz and 1 GHz external reference signals
- External reference signal between 1 MHz and 100 MHz
- If the external reference signal is interfered (noisy)

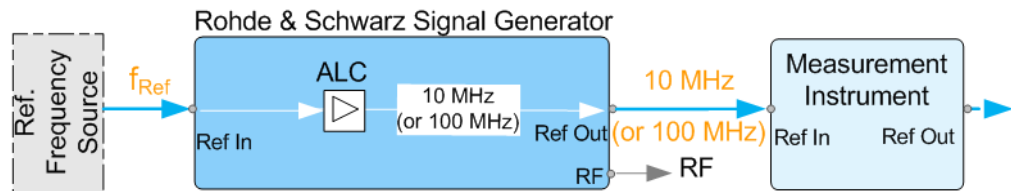

Figure 8-3: Synchronizing instruments with 10 MHz (derived from an external reference frequency)

Ref. Frequency Source = e.g., Rohde & Schwarz signal analyzer

f_{Ref} = 10 MHz, 100 MHz, 1 MHz to 100 MHz, 1 GHz** external reference frequency

** = 1 GHz uses Ref In 1 GHz connector

Ref In, Ref Out = Connectors

1 GHz, 1 MHz to 100 MHz at connector Ref In 1 GHz/Ref In and 10 MHz at Ref Out

- E.g., external Ref. $f_{\text{ref}} = 100 \text{ MHz}$
- **Source** = "External"
- **External Reference Frequency** = "100 MHz"
- **Reference Output/1 GHz Reference Output** = "10 MHz"
- **Synchronization Bandwidth** = "Narrow"

9 File and Data Management

The R&S SMB100B uses files to save all instrument data. The instrument allows you to store and to load instrument settings, and to import and to export user data for processing in another instrument or later. Finally, you can create a screenshot of the current settings displayed on the screen and save it as a file.

This section focuses on the functions provided for managing of user data files and covers the topics listed below.

For information on the related remote control commands, refer to [Chapter 12.5, "Memory Subsystem"](#), on page 327.

For information on how to save the displayed setting in a file, refer to [Chapter 9.10, "Creating Screenshots of Current Settings"](#), on page 218.

• About the File System	189
• Restoring the (Default) Instrument Configuration	192
• Protecting Data	197
• Saving and Recalling Instrument Settings	197
• Accessing Files with User Data	202
• Exporting Remote Command Lists	204
• Loading, Importing and Exporting Lists	205
• Using the File Manager	205
• How to Transfer Files from and to the Instrument	212
• Creating Screenshots of Current Settings	218

9.1 About the File System

Depending on the contained information, two file groups can be distinguished: system and user files.



Due to security reasons, system files and the system directory are protected and therefore not accessible.

The scope of this section is only the files with user data.

This section is an overview of the R&S SMB100B file system and covers the following topics:

- ["Types of user data"](#) on page 190
- ["File storage location"](#) on page 190
- ["File handling"](#) on page 190
- ["File naming conventions"](#) on page 191
- ["File extensions"](#) on page 191
- ["File contents"](#) on page 191

Types of user data

Depending on the **content**, the **user data** can be roughly divided into the following data types:

- *Settings*, e.g. the current instrument settings, can be saved and loaded later or used in other instrument of the same kind.
See [Chapter 9.4, "Saving and Recalling Instrument Settings"](#), on page 197
- *SCPI scripts*, a series of commands that can be run to perform a task.
See [Chapter 9.6, "Exporting Remote Command Lists"](#), on page 204
- Externally or internally generated *lists*, e.g. user correction lists, or data lists can be loaded in the instrument.
See [Chapter 9.7, "Loading, Importing and Exporting Lists"](#), on page 205 and [Chapter 9.5, "Accessing Files with User Data"](#), on page 202

Depending on the **data storage method**, user data can be:

- *Persistent*, i.e. user files that are recorded on the data storage.
Data is preserved when instrument is powered off and can be accessed and modified subsequently.
- *Temporary*, i.e. volatile data that the instrument retains while it is powered on.
Volatile data is immediately lost when the R&S SMB100B is switched off.

File storage location

Without any additional measures, the R&S SMB100B stores user files on the internal memory or if connected, on a memory stick.

Both, the user directory `/var/user/` on the internal memory or the `/usb/` directory on the memory stick, can be used to **preserve** user-defined data. Any directory structure can be created.

The `/var/volatile` directory serves as a RAM drive and can be used to protect sensitive information. The data is available **temporarily**.

Default storage location

The R&S SMB100B stores user data in the user directory.

In the file system, user directory is always indicated as `/var/user/`.

In manual control, you access this directory via the "File Manager", see [Chapter 9.8, "Using the File Manager"](#), on page 205. In remote control, you can query it with the command `:SYSTEM:MMEMory:PATH:USER?`.

To query and change the default directory used for mass storage, use the command `:MMEMory:CDIRectory`.

File handling

To *access files* and the file system of the instrument or to use the general file management functions such as copying and moving data, use the standard "File Manager" dialog.

See [Chapter 9.8, "Using the File Manager"](#), on page 205.

To *transfer files* from and to the instruments or to exchange files, use one of the following alternatives:

- Connect a memory stick to one of the USB interfaces.
The instrument recognizes automatically a connected memory stick and assigns the `/usb/` drive to it.
- Connect the instrument to a LAN.
An instrument connected to a LAN supports two standard file transfer methods from a remote client:
 - FTP (file transfer protocol)
 - File sharing according to the SAMBA/SMB (server message block) protocol.Both file transfer methods access the folder `/user`, that is the `/var/user/` folder on the instrument.
For step-by-step description, see [Chapter 9.9, "How to Transfer Files from and to the Instrument"](#), on page 212.
- Map a network folder or a computer to an instrument connected to a LAN.
A mapped network folder is indicated as `/shares/<"Local Folder">`.
For step-by-step description, see [Chapter 9.8.4, "How to Map a Network Folder"](#), on page 209.

File naming conventions

To enable files to be used in different file systems, consider the following file naming conventions:

- The *filename* can be of any length and *is case-sensitive*, i.e it is distinguished between uppercase and lowercase letters.
- All letters and numbers are permitted (numbers are, however, not permitted at the beginning of the filename).
- Avoid using special characters.
- Do not use slashes "`\`" and "`/`". These symbols are used in file paths.
- Avoid using the following filenames: `CLOCK$`, `CON`, `COM1` to `COM4`, `LPT1` to `LPT3`, `NUL` or `PRN`
They are reserved by the operating system.

File extensions

The R&S SMB100B distinguishes the files according to their extensions; each type of file is assigned a specific file content and also a specific file extension. The extension is usually of no consequence to you since access to the files occurs in the individual dialogs where only the relevant type of file is available. For example, files with user correction data can only be saved and loaded in the "UCOR" dialog.

See [Chapter A.3, "Extensions for User Files"](#), on page 581 for an overview of the supported file extensions.

File contents

To maintain the file size and to accelerate the loading and processing times, not all instrument settings but rather the settings in state different than the preset one are

stored. Considered is also configuration data for the operating elements and lists with user data, e.g. dialog positions and a list of user correction data. However, if a list data is part of the instrument settings, a reference to this list is stored, not the list itself.

This approach ensures that the created files contain only relevant information and allows you to transfer instrument settings even between different equipped signal generators. During the recall process, the instrument interprets only the relevant settings; all non-referenced parameters are set to their preset values. Error messages indicate the settings which cannot be implemented, like referencing non-existing lists or the attempt to activate settings which are not supported by the instrument.



Network settings and remote settings cannot be saved and restored.

9.2 Restoring the (Default) Instrument Configuration

The R&S SMB100B has various options to set default settings. You can preset the R&S SMB100B to an initial state at any time as a known starting point for configurations. It is often useful as a first step in troubleshooting when unusual results arise.

The graph on [Figure 9-1](#) shows the impact of the particular reset functions.

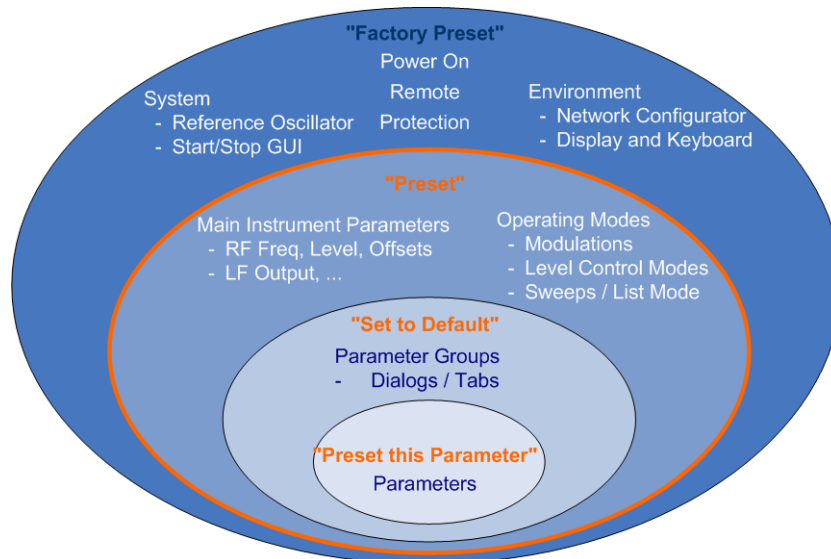

Figure 9-1: Parameter and operating modes, reset by the respective preset functions

Overview of the characteristics of the preset functions

Select the preset option that most fits to your particular application:



- [Preset]
It is the most frequently used function.

A **Preset** executes a defined instrument setup to provide an initial instrument state as a basis for a new configuration. It resets all parameters and switching states, including also the states of inactive operating modes. Network, remote access or system settings are retained.

- ▶ To execute a preset, press the [Preset] key at the front panel.



- "Set to Default"
[Set To Default](#) relates to individual dialogs or tabs and resets the associated settings of the corresponding dialog. All other settings are retained.
- ▶ To reset the grouped settings, click "Set To Default".

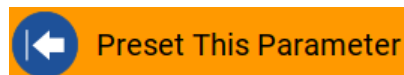

- "Preset this parameter"
 Sets a single parameter to its default value.
- ▶ To reset an individual parameter: Open its context-sensitive menu and select "Preset this parameter...".

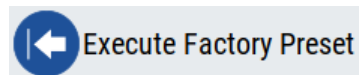

- "Factory Preset"
 A factory preset is the most profound preset function that resets almost all instrument settings, including reference oscillator, network and remote access settings. Retained are the following settings:
 - Security, password, and settings protected by these passwords
 - User-defined data, like setups or data lists
 - Settings that relate to an integration of the instrument in a measurement setup.
- ▶ To restore the factory defaults, select [System Config > Setup > Settings > Factory Preset](#).

Note: Perform a "Factory Preset" only if it is necessary. After a "Factory Preset", the network connection to the instrument no longer exists.

Presetting the instrument to a user-defined instrument state

The reset functions set the parameters and operating modes to default values predefined by the factory. Alternatively to these default settings, you can:

- Define user-specific recall settings to be restored after a preset

(see [Chapter 9.2.3, "How to Recall User Settings Automatically after Preset"](#), on page 195)

- Store and reload user-defined instrument states
(see [Chapter 9.4.2, "How to Save and Recall Instrument Settings"](#), on page 201)

Mark / Do not mark parameters changed from preset

To survey the current state of the settings concerning default values, the R&S SMB100B offers a feature that visually identifies deviations from the default values.

For more information, see [Chapter 9.2.2, "How to Identify Parameters Which Are Not in a Preset State"](#), on page 195.

9.2.1 Preset, Set to Default and Factory Preset Settings

Preset	194
Set To Default	194
Preset this Parameter	194
Execute Factory Preset	194

Preset

Resets all parameters and switching states, and closes all opened dialogs.

Note:

In contrast to the [Preset] key, the SCPI commands `*RST` and `:SYSTEM:PRESet` do not close open dialogs in the GUI.

Consider also the following possibilities:

- You can define the settings that are restored when you preset the instrument
(see [Chapter 9.2.3, "How to Recall User Settings Automatically after Preset"](#), on page 195)
- You can reset the instrument to the factory state
(see ["Execute Factory Preset"](#) on page 194)

See also [Table 9-1](#) that contains the key parameters that are reset by the corresponding preset functions.

Remote command:

`*RST` on page 324

Set To Default

Resets the associated settings of the corresponding dialog or tab.

Preset this Parameter

Restores the default value of a single parameter.

Execute Factory Preset

Resets the instrument to its factory settings.

Note: "Factory Preset" retains all security settings and does not delete any user files like setups or user data.

See also [Table 9-1](#) that contains the key parameters that are reset by the corresponding preset functions.

Remote command:

:SYSTem:FPReset on page 327

9.2.2 How to Identify Parameters Which Are Not in a Preset State

To recognize the current state of the settings related to their default values at the first glance, enable a function that visually identifies parameters in states different than preset.

To activate this display:

1. Open the context-sensitive menu (touch and hold the screen anywhere in the GUI of the R&S SMB100B).
2. Select "Mark all parameters changed from preset".

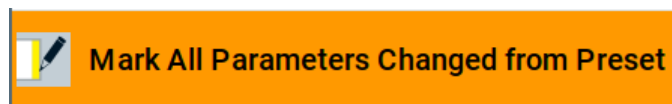

If enabled, the corresponding settings are marked.

Example:

Frequency	4.000 000 000 000 GHz		
Offset	10.000 000 kHz	Multiplier	1.000
User Variation			
Variation Active	<input checked="" type="checkbox"/>	Variation Step	1.000 000 000 MHz

Figure 9-2: Labeled parameters show that the value deviates from its default

Frequency = changed (default = 1 GHz)
 Offset = changed (default = 0 kHz)
 Multiplier = unchanged
 Variation active = changed (default = disabled)
 Variation step = unchanged

9.2.3 How to Recall User Settings Automatically after Preset

You can define the settings that are restored when you preset the instrument.

1. Configure the settings as required. Save them as described in [Chapter 9.4.2, "How to Save and Recall Instrument Settings"](#), on page 201.
2. Save the settings as a file with the predefined filename `UserPreset.savrc1.txt`.

Save this file in the directory `/var/user/`.

The filename `UserPreset.savrcltxt` and the directory `/var/user/` are mandatory.

Now when you press the [Preset] key or send the `*RST` command to the instrument, the defined settings are restored.

An "Info" message appears and confirms, that a file with user-defined preset setting is loaded.

9.2.4 Reference

See [Table 9-1](#) for an overview of the main generator settings that are affected by the corresponding preset functions. While the regular [Preset] key primarily resets the signal relevant parameters of the instrument, the "Factory Preset" affects almost all instrument settings.

For information on the default values of further parameters, refer to the description of the corresponding remote commands.

Table 9-1: Key parameters affected by preset and factory preset

Parameter	Preset value	Preset	Factory Preset
RF frequency	1 GHz	x	x
RF level (RF output)	off	x	x
RF OFF mode	-	-	x
Modulation state	off	x	x
Uninterrupted level settings	off	x	x
Level attenuator mode	auto	x	x
Level ALC (internal level control)	auto	x	x
Level UCOR (user correction)	off	x	x
LF output state	off	x	x
Sweep state	off	x	x
List mode state	off	x	x
Reference frequency settings (reference oscillator)	-	-	x
Power on settings (Level/EMF)	-	-	x
Network settings	-	-	x
Hostname	-	-	x
GPIB address	-	-	x
Start/Stop display update	-	-	x
Display and keyboard settings	-	-	x

Parameter	Preset value	Preset	Factory Preset
Password and settings protected by passwords (e.g. disabled LAN or USB)	-	-	-
Security settings	-	-	-
User files (setups ²⁾ , data lists, etc.)	-	-	-

- ²⁾ `UserPreset.savrcltxt` is renamed as `UserPresetInactive.savrcltxt`; an existing file with the same name is overwritten.



If the default values in the "Remote Access" dialog had been changed, a factory preset via remote control (`:SYSTem:FPReset`) terminates the connection to the instrument. Security settings are never reset.

Resets all parameters and switching states, and closes all opened dialogs.

9.3 Protecting Data

During operation, the R&S SMB100B saves user data permanently in the user directory, see ["File storage location"](#) on page 190.

To protect any classified data and to avoid saving any sensitive data on the R&S SMB100B permanently, you have the following options:

- Activate the **volatile mode**. This mode redirects user data to the volatile memory. The internal memory is write-protected. Instead, you can redirect the user data to an **external storage medium**, as e.g. a USB stick.
See also:
 - ["Default storage location"](#) on page 190
 - ["Volatile Mode"](#) on page 245
 - [Chapter 9.9.4, "Using a USB Storage Device for File Transfer"](#), on page 217
- Save user files **temporarily in the `/var/volatile` directory**, which remains available only until the instrument is turned off. You can access data in the volatile memory just as data that is saved permanently in the `/var/user/`.
See also [Chapter 9.8.3, "How to Display All Saved Files"](#), on page 209.

9.4 Saving and Recalling Instrument Settings

Possibly you would like to restore or repeat a signal generation you performed under specific conditions on the instrument. Or, in a test setup with more than one signal generator, you want to transfer the used settings to another R&S SMB100B. In these

cases, you can save and recall instrument and user settings, and possibly other related data.

Save/Recall the complete instrument settings

Two different methods are available for managing *complete instrument settings*:

- Immediate (quick) Save/Recall
A defined set of instrument settings are saved or recalled quickly in just one step, without defining a filename or storage location. This function enables a fast switching between different instrument settings.
- Save/Recall in files with user-defined names
The defined set of instrument settings are stored to a definable storage location. The file extension is *.savrc1.txt.
Settings files created in this way are visible in the file system and accessible with the supported methods for file handling.

In the general case, a recall process replaces the instruments settings with the saved values. An exception is the frequency and level settings. During recall of the instrument settings, it is possible to retain the current settings or to overwrite them with the stored values.

9.4.1 Save/Recall Settings

To access the dialog for storing and loading the complete instrument settings

1. Select "System Config > Save/Recall".
2. Select "Operation Mode > Save or Recall" to access the corresponding settings.

The provided settings for both operations are similar and closely related.

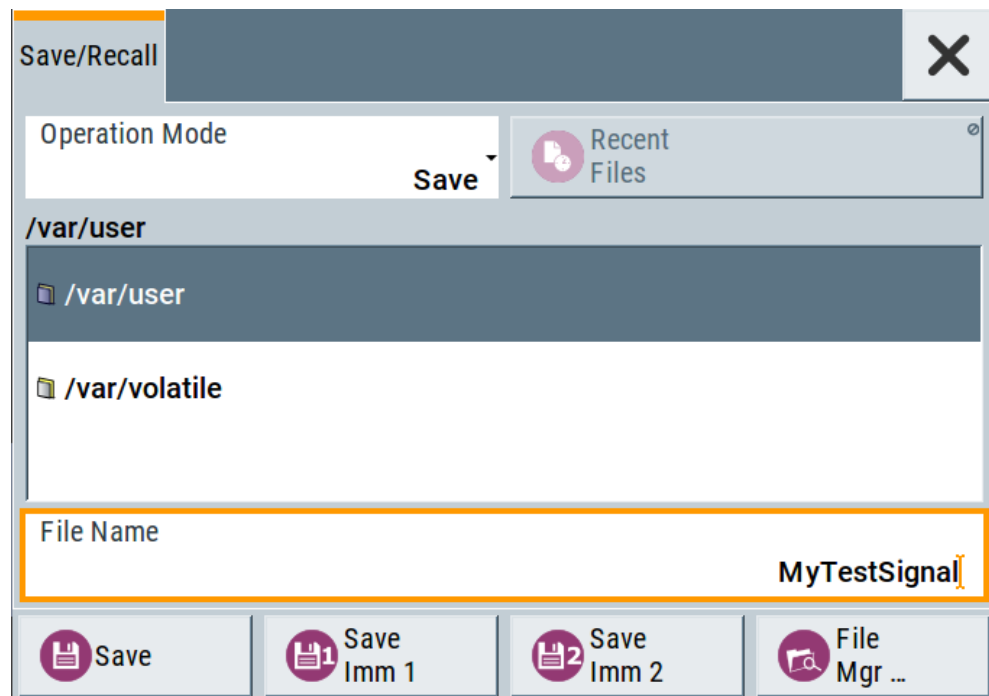
**Settings:**

Operation Mode.....	199
Directory, File List and Filename.....	199
Recent files.....	200
Show SCPI List.....	200
SCPI List.....	200
Save.....	200
Save Immediate x.....	200
Exclude Frequency.....	200
Exclude Level.....	201
Recall.....	201
Recall Immediate x.....	201
File Manager.....	201

Operation Mode

Accesses the settings for storing ("Save") and loading ("Recall") of the instrument settings, or for exporting created SCPI files ("SCPI-Export").

See [Chapter 9.6, "Exporting Remote Command Lists"](#), on page 204.

Directory, File List and Filename**Note:**

You access this generic standard function each time you perform one of the following:

- Save or load (settings) files
- Define a folder in that these files are saved
- Navigate through the file system.

The dialog name changes depending on the context. The provided functions are self-explanatory and similar.

Use the settings for example as follows:

- To navigate through the file system, use the directory tree.
- To create a file, load and save files, use the dedicated functions "New", "Select", [Save](#), and [Recent files](#).
- To access the general data list editor, use the "Edit" button (see also [Chapter 6.7, "List Editor"](#), on page 142).
- To perform standard file management functions, like create directories, move, copy, delete files and/or directories, use the standard "File Manager" function (see [Chapter 9.8, "Using the File Manager"](#), on page 205).

Remote command:

To list all files in a directory:

[:MMEMory:CDIRectory](#) on page 333

[:MMEMory:CATalog?](#) on page 332

[\[:SOURce\]:CORRection:CSET:CATalog?](#) on page 409

Recent files

Displays the files last used.

Show SCPI List

Opens the "SCPI List", which lists the current settings of the R&S SMB100B as SCPI commands.

The R&S SMB100B provides this function for [Operation Mode > SCPI-Export](#).

SCPI List

Contains a list of all SCPI commands corresponding to the current instrument settings.

See also ["How to create a SCPI list with the current instrument settings in one step"](#) on page 306

Save

Saves the current instrument settings under the defined filename.

Remote command:

[:MMEMory:STORe:STATe](#) on page 337

Save Immediate x

Stores the current instrument setting in one of the intermediate memories.

These instrument settings are retained until a different instrument setting is stored in the intermediate memory. When the instrument is switched off, the contents of the intermediate memories are retained.

Remote command:

[*SAV](#) on page 324

Exclude Frequency

The current frequency is retained when a stored instrument setting is loaded.

Remote command:

[\[:SOURce<hw>\]:FREQuency\[:CW|FIXed\]:RCL](#) on page 414

Exclude Level

The current level is retained when a stored instrument setting is loaded.

Remote command:

`[:SOURce<hw>] :POWer [:LEVel] [:IMMediate] :RCL` on page 456

Recall

Restores the selected configuration.

During recall, the instrument considers all related settings, for example sweeps in active state or lists. An error message indicates the settings which cannot be implemented.

Remote command:

`:MMEMory:LOAD:STATe` on page 335

Recall Immediate x

Loads the selected configuration from one of the intermediate memories. A message appears if no instrument configuration is stored in this memory.

Remote command:

`*RCL` on page 324

File Manager

Accesses the "File Manager" dialog, see [Chapter 9.8, "Using the File Manager"](#), on page 205.

9.4.2 How to Save and Recall Instrument Settings

Instrument settings can be saved to a file and loaded again later, so that you can repeat the tests with the same settings.

To access and recall instrument setups quickly

- ▶ Assign the appropriate action to the [**★** (User)] key.
See [Chapter 10.2.4, "How to Assign Actions to the \[**★** \(User\)\] Key"](#), on page 235.

To save and recall instrument settings

1. Select "System Config > Save/Recall" > "Operation Mode > Save".
2. Select "Save Immediate 1".
The instrument saves its settings in the intermediate memory 1. The filename and the storage location cannot be changed.
3. Adapt the instrument settings as required. Select "Save Immediate 2"
4. To restore the settings, select the "Operation Mode > Recall"
5. Select "Recall Immediate 1"
The instrument is restored to the previous state.
6. Select "Recall Immediate 2" to switch to the settings stored in the second file.

To save complete instrument settings

1. Select "System Config > Save/Recall" > "Operation Mode > Save".
2. In the file selection dialog, select a filename and storage location for the settings file.
3. Select "Save".

A file with the defined name and path and the extension `*.savrc1.txt` is created.

To restore instrument's configuration

Save the configuration as described in ["To save complete instrument settings"](#) on page 202.

1. To restore settings, select "System Config > Save/Recall" > "Operation Mode > Recall".
2. To retain the current frequency and level settings, enable "Save/Recall > Exclude Frequency/Level"
3. In the file selection dialog, select the filename and storage location of the settings file.

The settings are restored, but the frequency and level settings are retained; you can repeat the signal generation with the same settings.

See also [Chapter 9.2.3, "How to Recall User Settings Automatically after Preset"](#), on page 195.

9.5 Accessing Files with User Data

Signal generation in list mode, the generation of pulse train signals or applying user correction values use data from list files. Whenever a list file is required as a data source, the instrument provides direct access to the standard "File Select" function. This function enables you to select, create and edit the list files.

9.5.1 File Select Settings

The "File Select" dialog opens automatically each time the signal generation requires list file as data source.

To access a loadable data list file

1. Select ""Sweep" > List Mode Data > List Mode = Data".

A "File Select" dialog for loading, creating and modifying a file is displayed.

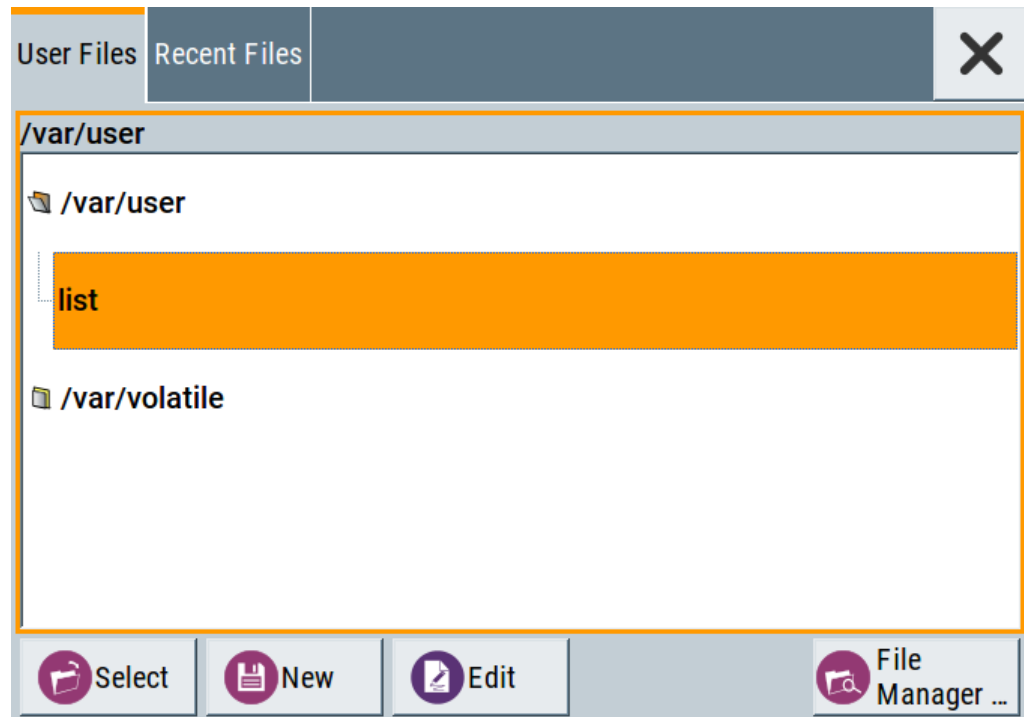

Tip: The name of the dialog is context-sensitive and differs depending on the particular function this dialog is from. However, the provided functions are similar.

2. To load an existing file:
Navigate through the file system.
Select the file and confirm with "Select".
3. To create a file, for example if there is no data list file specified:
Navigate through the file system.
Select "New" and specify the filename.
A new empty file is created and saved in the selected folder.
4. To edit an existing or newly created file:
Navigate through the file system.
Select the file and select "Edit".
The standard "Data List Editor" dialog opens
5. Edit the file content.
Confirm with "Save".

Settings:

Directory, File List and Filename	203
Functions for handling of data lists	204
Recent files	204
File Manager	204

Directory, File List and Filename

Note:

You access this generic standard function each time you perform one of the following:

- Save or load (settings) files
- Define a folder in that these files are saved
- Navigate through the file system.

The dialog name changes depending on the context. The provided functions are self-explanatory and similar.

Use the settings for example as follows:

- To navigate through the file system, use the directory tree.
- To create a file, load and save files, use the dedicated functions "New", "Select", Save, and Recent files.
- To access the general data list editor, use the "Edit" button (see also [Chapter 6.7, "List Editor"](#), on page 142).
- To perform standard file management functions, like create directories, move, copy, delete files and/or directories, use the standard "File Manager" function (see [Chapter 9.8, "Using the File Manager"](#), on page 205).

Remote command:

To list all files in a directory:

[:MMEMory:CDIRectory](#) on page 333

[:MMEMory:CATalog?](#) on page 332

[\[:SOURce\]:CORRection:CSET:CATalog?](#) on page 409

Functions for handling of data lists

Provided are the following standard functions for file handling:

"Select" Select and load the file.

Remote command:

[\[:SOURce<hw>\]:LIST:SElect](#) on page 442

[\[:SOURce<hw>\]:PULM:TRAI:n:SElect](#) on page 394

[\[:SOURce<hw>\]:CORRection:CSET\[:SElect\]](#) on page 408

"New" Creates file with the specified "Filename".
To confirm, select "OK"; use "Cancel" to undo the operation.
To edit the file content, select "File Select > Edit".

"Edit" Accesses the "Data List Editor" and loads the selected file for editing

Recent files

Displays the files last used.

File Manager

Accesses the "File Manager" dialog, see [Chapter 9.8, "Using the File Manager"](#), on page 205.

9.6 Exporting Remote Command Lists

To set specific instrument settings or perform tasks automatically, you can create scripts that contain the settings in the form of remote control command sequences.

The R&S SMB100B also offers a SCPI macro recorder with code generator that is used to record manual settings and create an executable script, see [Chapter 11.8.4, "How to Record / Create SCPI Lists"](#), on page 305.

Completed scripts are stored in files and possibly converted to different formats, depending on the used language of the source code.

The R&S SMB100B supports the following commonly used languages:

- Plain SCPI: *.txt
- MATLAB: *.m
- NICVI: *.c
- Python: *.py

It is also possible to convert the SCPI command list to a user-specific language, see [Chapter 11.8.5, "How to Convert and Save SCPI Lists"](#), on page 308.

9.7 Loading, Importing and Exporting Lists

The R&S SMB100B provides built-in editors for creating list files, for example for the list mode or lists with user correction data. You can also create or evaluate them with an external application. The instrument provides interfaces with the following functionality:

- Import and export list files in a standard ASCII format file

Lists are saved and loaded in the corresponding dialogs. For example, the user correction data list is created and stored in the "User Correction" dialog.

9.8 Using the File Manager

The "File Manager" is a tool similar to a standard Windows Explorer. It helps you manage mass storage media and files stored on the R&S SMB100B.

You can perform the following tasks:

- Copying multiple files from disk to other media
See [Chapter 9.9, "How to Transfer Files from and to the Instrument"](#), on page 212
- Copying files into another directory
See [Cut, Copy&Paste and Delete](#)
- Renaming and deleting files
- Creating directories
See [Create New Directory](#)
- Mapping shared network folders
See [Chapter 9.8.4, "How to Map a Network Folder"](#), on page 209
- Displaying saved files
See [Chapter 9.8.3, "How to Display All Saved Files"](#), on page 209

Access:

- ▶ Select "System Config > Save/Recall" > "File Manager".

Tip: Each "Save/Recall" dialog and each "File Select" dialog provides a quick access to the "File Manager", i.e. whenever you select data lists or files with user data.

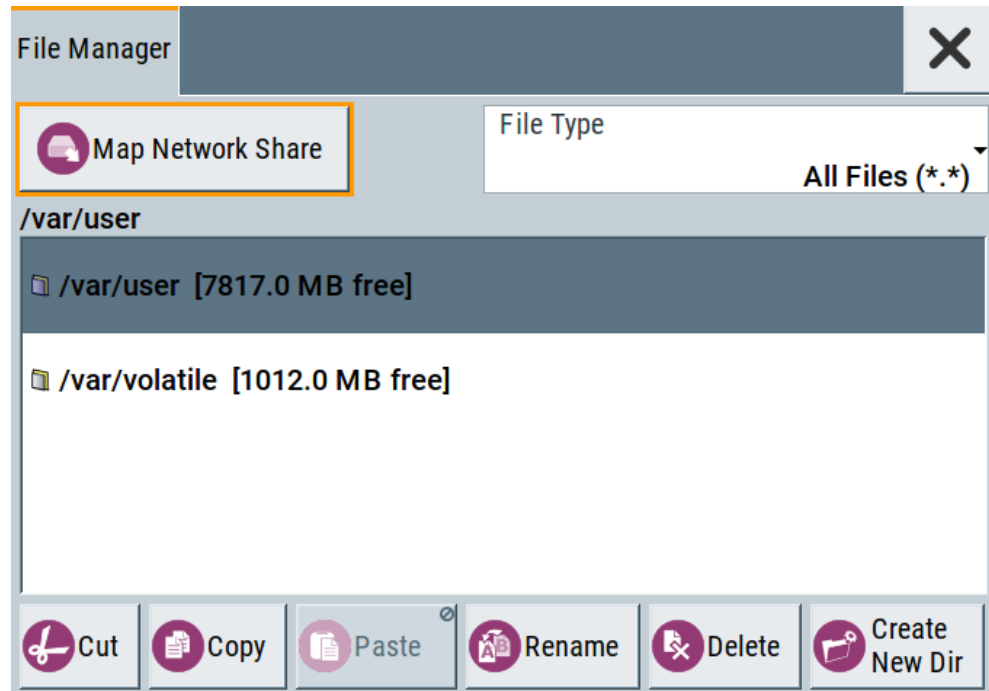

The "File Manager" dialog provides all standard functions required for file management. It displays the contents of the selected folder on the R&S SMB100B and provides functions to rename, delete, copy, or move individual files.

9.8.1 File Manager Settings

Access:

- ▶ Select "System Config > Save/Recall" > "File Manager".

Settings:

Map Network Share.....	207
File Type.....	207
Directory and Filename.....	207
Cut, Copy&Paste and Delete.....	207
Rename	207
Create New Directory.....	207

Map Network Share

Accesses the [Map Network Share Settings](#) dialog where you can map one or more network folders.

See also [Chapter 9.8.4, "How to Map a Network Folder"](#), on page 209.

File Type

Selects the file type to be listed. If a file type with a specific file extension is selected, only files with this extension are listed.

See [Chapter A.3, "Extensions for User Files"](#), on page 581 for an overview of the supported file extensions.

Directory and Filename

Selects the directory in which the file to be deleted or copied is located. The dialog lists all files in this directory. Selected files are highlighted. The path is indicated above the directory tree.

Unlike the "Save/Recall" and "File Select" dialogs, the "File Manager" displays the full filenames including extensions.

Remote command:

[:MMEMory:CDIRectory](#) on page 333

Cut, Copy&Paste and Delete

Standard file management functions.

Before a file is deleted, you have to confirm the delete operation.

Remote command:

[:MMEMory:DELeTe](#) on page 335

[:MMEMory:COpy](#) on page 333

Rename

Renames the selected file or directory.

Remote command:

[:MMEMory:MOVE](#) on page 336

Create New Directory

Creates a folder and opens an edit dialog box to enter name and path (absolute or relative to the current directory) of the new folder.

Remote command:

[:MMEMory:MDIRectory](#) on page 336

9.8.2 Map Network Share Settings

Access:

- ▶ Select "System Config > Save/Recall" > "File Manager > Map Network Share".

The "Map Network Share" dialog provides settings that are similar to the standard Windows Explorer function "Map network drive". These settings help you to create up to 10 "shortcuts" to shared folders or computers in the network.

The dialog displays a list of current mapped network folders. The directory tree of the "File Manager", "Save/Recall", and "File Select" dialogs indicate a mapped network folder as /shares/<"Local Folder">.

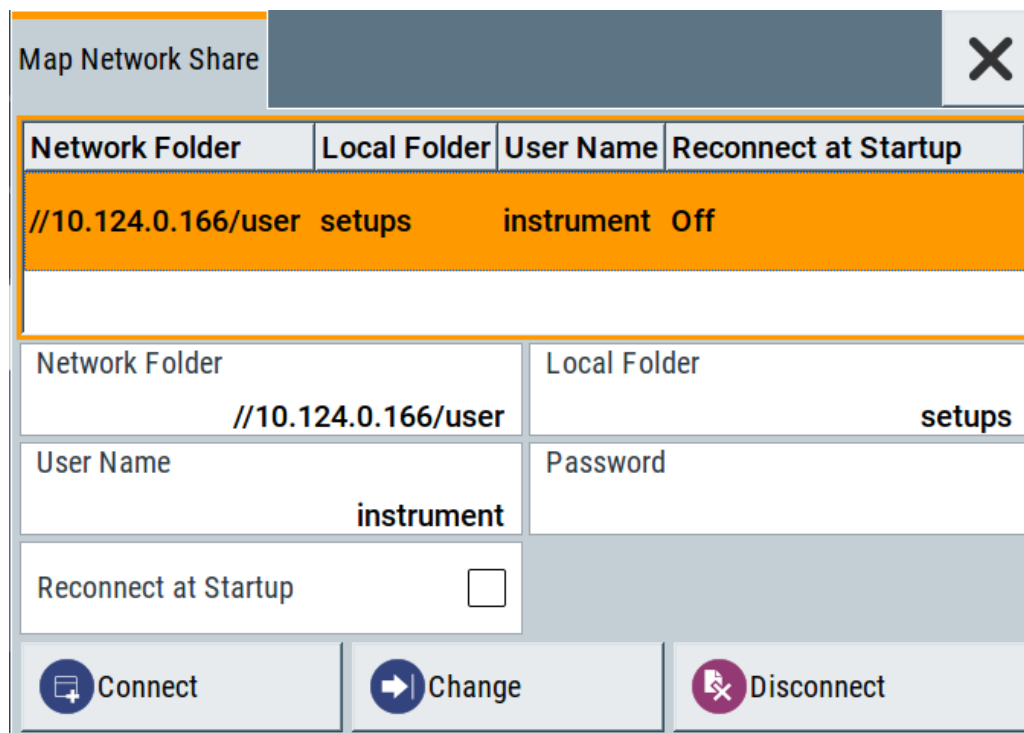

Network Folder	Local Folder	User Name	Reconnect at Startup
//10.124.0.166/user	setups	instrument	Off

Network Folder: //10.124.0.166/user

Local Folder: setups

User Name: instrument

Password: _____

Reconnect at Startup:

Buttons: Connect, Change, Disconnect

See also [Chapter 9.8.4, "How to Map a Network Folder"](#), on page 209.

Settings:

Network Folder	208
Local Folder	208
User Name	209
Password	209
Reconnect at Startup	209
Connect	209
Change	209
Disconnect	209

Network Folder

Enter the path of the folder or computer, e.g. //<IP Address>/user or //<server name>/user.

Local Folder

Enter a letter or an alias name to describe the folder.

In the directory tree, a mapped network folder is indicated as `/shares/`
<"Local Folder">.

User Name

Enter a user name of a user that has the permission to access the selected network folder.

Password

Enter the password of the selected user.

Reconnect at Startup

Enables reconnecting every time you start up the instrument.

Connect

Triggers the instrument to prove the credential and to map (i.e. connect) the selected network folder or computer to the instrument.

You can map up to 10 network folders.

Change

Applies the changes.

Disconnect

Disconnects the network drive.

9.8.3 How to Display All Saved Files

To display all files on the internal memory

1. Select "System Config > Save/Recall" > "File Manager".
2. Navigate to `/var/user/`.

To display all files on a connected USB flash drive

1. Select "System Config > Save/Recall" > "File Manager".
2. Navigate to `/usb/`.

To display all files in the volatile memory

1. Select "System Config > Save/Recall" > "File Manager".
2. Navigate to `/var/volatile/`.

9.8.4 How to Map a Network Folder

Possibly you would like to transfer instrument or user settings to another R&S SMB100B, distribute waveform files to several instruments or you have to access

frequently the same network drive. In these cases, on a R&S SMB100B connected to a LAN you can create a shortcut to this network folder or this computer.

How to: see [Chapter 11.6.3, "How To Connect to LAN"](#), on page 286.

To map a network folder, proceed as follows:

1. On the computer or the network folder you want to map, enable remote access. You can specify a list of users allowed for remote access. The remote access settings depend on the operating system the remote computer is using. For step-by-step instructions, refer to the documentation of the particular operating system.
2. On the R&S SMB100B, [enable file transfer via SMB \(samba\)](#).
3. Select "System Config > Setup > Remote Access > Network".
Select:
 - a) "Address Mode > Auto (DHCP)"
 - b) Check that the "DNS Suffix" and "DNS Server" are correct.
4. In the "Save/Recall" dialog, select "File Manager > Map Network Share".
5. In the "Map Network Share" dialog, select:
 - a) In the "Network Folder" field, enter `//<IP Address>/user` or `//<Server Name>/user`.
 - b) In the "Local Folder" field, enter an alias name, e.g. *setups*.
 - c) Enter the "User Name" and "Password" of a user with a remote access permission to the selected network folder.
 - d) If necessary, enable "Reconnect at Startup".
 - e) Select "Connect".

The selected network folder is mapped to your instrument. The list of mapped network folders is updated.

Map Network Share			
Network Folder	Local Folder	User Name	Reconnect at Startup
//10.124.0.166/user	setups	instrument	Off
Network Folder //10.124.0.166/user		Local Folder setups	
User Name instrument		Password	
Reconnect at Startup		<input type="checkbox"/>	
Connect		Change	
Disconnect			

- Close the "Map Network Share" dialog.

The navigation tree in the "File Manager" dialog displays the mapped network folder as /shares/Setups.

File Manager	
Map Network Share	File Type List Mode List (*.lsw)
/shares/Setups	
/var/user [7817.0 MB free]	
/shares/Setups [1012.0 MB free]	
/var/volatile [1012.0 MB free]	
Cut	Copy
Paste	Rename
Delete	Create New Dir



If the connection does not succeed, consider to check the following:

- Is the network folder or computer you try to map turned on?
- Is the network folder or computer enabled for remote access?
- Does the selected user name have the necessary permissions?

See also [Chapter 9.9.5, "Using a File Server for Test Files Exchange"](#), on page 217.

9.9 How to Transfer Files from and to the Instrument

As explained in ["File handling"](#) on page 190, you access the file system of the R&S SMB100B via one of the following ways:

- Via the built-in "File Manager"
See [Chapter 9.8, "Using the File Manager"](#), on page 205.
- On an instrument connected to a LAN:
 - Via one of the standard functions ftp or SMB (samba)
See [Chapter 9.9.2, "Accessing the File System of the R&S SMB100B via ftp"](#), on page 214 and
[Chapter 9.9.3, "Accessing the R&S SMB100B File System via SMB \(Samba\)"](#), on page 215
 - Via mapped network drives
See [Chapter 9.8.4, "How to Map a Network Folder"](#), on page 209.
- Via a connected USB storage device
See [Chapter 9.9.4, "Using a USB Storage Device for File Transfer"](#), on page 217

Mainly because of security reasons, the access to the file system of your R&S SMB100B can be denied, because one or all these access methods are deliberately disabled. Access to the file system via LAN and/or USB requires that the corresponding service is enabled and a write access to the file system is enabled. Refer to [Chapter 9.9.1, "Removing File System Protection"](#), on page 212 for description of the required steps.

This section provides an introduction to the topic. For comprehensive information, refer to the application note [1GP72: Connectivity of Rohde&Schwarz Signal Generators](#).

- [Removing File System Protection](#).....212
- [Accessing the File System of the R&S SMB100B via ftp](#).....214
- [Accessing the R&S SMB100B File System via SMB \(Samba\)](#)..... 215
- [Using a USB Storage Device for File Transfer](#).....217
- [Using a File Server for Test Files Exchange](#)..... 217

9.9.1 Removing File System Protection

Before you try to access the file system via ftp, SMB (samba) or USB, fulfill the following:

- Disable write protection on the file system

- Enable the corresponding service or interface

To enable write permission on the file system

1. Select "System Config > Setup > Security > Security > General"
2. Enable "Volatile Mode"
3. Enter the "Security Password".
The default password is 123456. For more information, see [Chapter 10.4, "Using the Security Settings"](#), on page 240.
4. Select "System Config > Setup > Maintenance > Shut Down"
5. Select "Reboot".
The system reboots. The enabled settings are active.

To enable file transfer via ftp

1. Select "System Config > Setup > Security > Security > LAN Services".
2. Enable "LAN Interface"
3. Enable "FTP"
4. Enter the "Security Password".
The default password is 123456. For more information, refer to [Chapter 10.4, "Using the Security Settings"](#), on page 240.
5. Select "Accept".

To enable file transfer via SMB (samba)

1. Select "System Config > Setup > Security > Security > LAN Services"
2. Enable "LAN Interface"
3. Enable "SMB (Samba)"
4. Enter the "Security Password".
The default password is 123456. For more information, refer to [Chapter 10.4, "Using the Security Settings"](#), on page 240.
5. Select "Accept".

To enable file transfer via USB

1. Select "System Config > Setup > Security > Security > General"
2. Enable "USB Storage"
3. Enter the "Security Password".
The default password is 123456. For more information, refer to [Chapter 10.4, "Using the Security Settings"](#), on page 240.
4. Select "Accept".

9.9.2 Accessing the File System of the R&S SMB100B via ftp

If the R&S SMB100B is connected to a LAN, you can use file transfer protocol (ftp) to access the file system and to transfer files from and to the instrument.

How to: see [Chapter 11.6.3, "How To Connect to LAN"](#), on page 286.

To access the file system via ftp

We assume that the instrument and the remote PC are connected to a LAN.

1. [Enable file transfer via ftp](#)
2. [Enable write permission on the file system](#)
3. On the remote PC, start the Windows Explorer.
4. In the address field, enter `ftp://<"IP Address" of the Instrument>`, e.g. `ftp://10.124.0.166`.

Tip: The R&S SMB100B indicates its IP address on the home screen.

A log-on dialog opens and requests a password.

The default user name and password is *instrument*.

Tip:

Default password

The FTP and SAMBA file access use the user "instrument" with default password "instrument".

We recommend that you change this password in the "Setup > Security > Password Management > Change User Password" dialog before connecting the instrument to the network.

See [Chapter 10.4.4, "Password Management"](#), on page 250.

5. Enter the password to access the `user` directory.
The `user` directory corresponds to the `/var/user/` directory of the instrument.

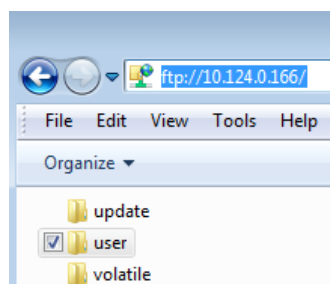

There, you can perform standard functions like creating directory, or saving files.

6. In the `user` directory, create a directory, e.g. `test ftp`.
7. Select "System Config > Save/Recall".
Open the `/var/user/` directory.

The dialog displays the `/var/user/test ftp` directory.

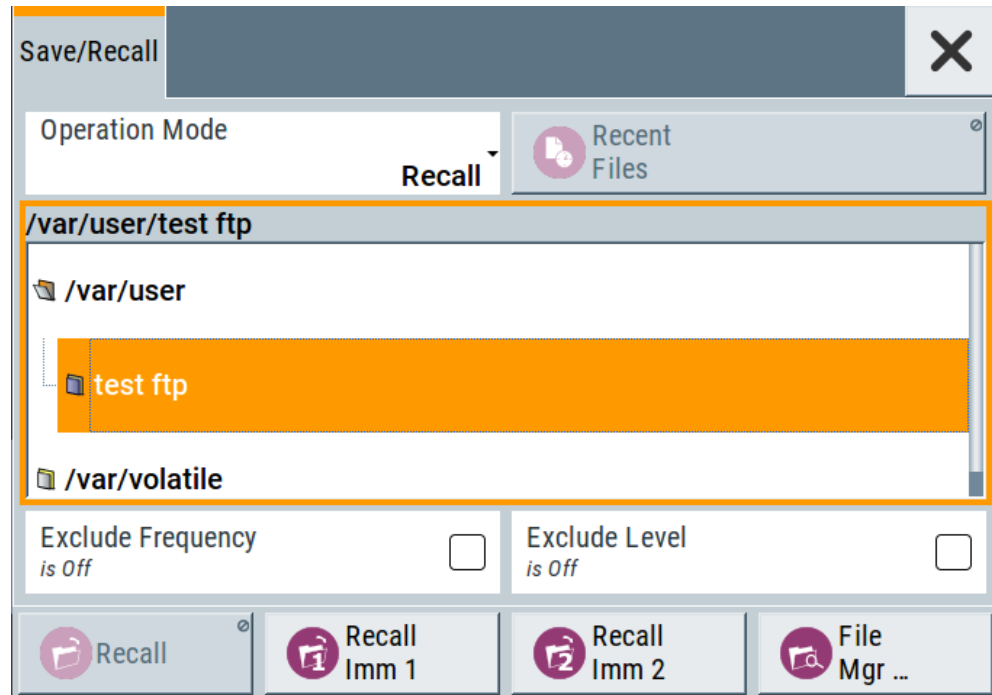

9.9.3 Accessing the R&S SMB100B File System via SMB (Samba)

The SMB (Samba) protocol is an alternative way to access the file system of the instrument from a remote PC. This protocol works if both the instrument and the PC are connected to a LAN.

How to: see [Chapter 11.6.3, "How To Connect to LAN"](#), on page 286.

To access the file system via SMB

We assume that the instrument and the remote PC are connected to a LAN.

1. [Enable file transfer via ftp](#)
2. [Enable write permission on the file system](#)
3. On the remote PC, start the Windows Explorer.
4. In the address field, enter `\\<"IP Address" of the Instrument>`, e.g. `ftp://10.124.0.166`.

Tip: The R&S SMB100B indicates its IP address on the home screen.

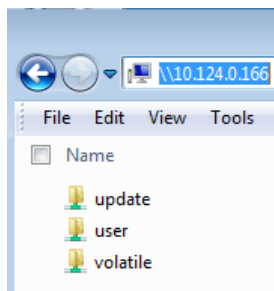

The `user` directory corresponds to the `/var/user/` directory of the instrument; the `volatile` directory - to the `/var/volatile` directory.

To map the R&S SMB100B as a network drive to the remote PC

We assume that the instrument and the remote PC are connected to a LAN.

1. [Enable file transfer via SMB \(Samba\)](#)
2. [Enable write permission on the file system](#)
3. On the remote PC, start the Windows Explorer. Open the "Map Network Drive" dialog.
 - a) Select a valid "Drive", e.g. *W*.
 - b) In the "Folder" field, enter `//<"IP Address" of the Instrument>/user` or `//<"Hostname" of the Instrument>/user`
For example: `//10.124.0.166/user` or `//SMB100B-102030/user`.
Tip: The R&S SMB100B indicates its IP address on the screen.
 - c) Select "Finish".

A log-on dialog opens and requests a user name and a password.

The default user name and password is *instrument*.

Tip:

Default password

The FTP and SAMBA file access use the user "instrument" with default password "instrument".

We recommend that you change this password in the "Setup > Security > Password Management > Change User Password" dialog before connecting the instrument to the network.

See [Chapter 10.4.4, "Password Management"](#), on page 250.

4. Enter the user name and the password of your instrument.

The `/var/user/` directory of the instrument is mapped to and displayed as a network drive of the remote PC.

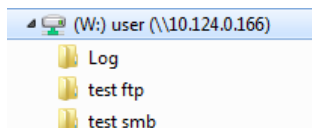

You can access the files in the `/var/user/` directory, perform standard function like creating directory, or storing files.

9.9.4 Using a USB Storage Device for File Transfer

Alternatively to the file transfer possibility via LAN, you can use a USB storage device for direct file transfer from and to the instrument.

We recommend that you transfer files with user data (like lists or instrument setup files) to the instrument, rather than load and play them from a connected USB storage device.

To transfer a file with user data to the instrument

1. Connect a USB storage device, for example a USB memory stick to one of the USB interfaces of the instrument.
The R&S SMB100B recognizes the connected USB storage device automatically.
2. [Enable file transfer via USB](#)
3. [Enable write permission on the file system](#)
4. Select "System Config > Save/Recall".
The dialog displays the `/var/user/` directory and the `/usb/` drive.
5. In the "Save/Recall" dialog, select "File Manager".
6. In the directory tree, navigate to the `/usb/` drive.
Select the required file with user data.
7. Select "Copy".
8. In the directory tree, navigate to the `/var/user/` directory.
Select "Paste".
The file with user data is transferred to the instrument.

9.9.5 Using a File Server for Test Files Exchange

You can use a central file storage location like a file server in your company network to store setup files, SCPI scripts, application programs, or waveform files on it. Usually, you would like to distribute the files to several instruments. If the R&S SMB100Bs are connected to a LAN, you can create a shortcut on the instruments to the file server.

To access the file server

1. On each R&S SMB100B, map the required directory of the file server to the instrument.
Perform the steps described in [Chapter 9.8.4, "How to Map a Network Folder"](#), on page 209.

- On each R&S SMB100B, use the same alias name for the directory of the file server, i.e. enter the same "Local Folder" (in this example *Setups*).

On any of the R&S SMB100B, you access the file server directly from the "File Manager" and under the same name, e.g. `/shares/Setups`.

An extra advantage in remote control is that the same application program would control the instruments.

For example, use the remote control command `MMEemory:CDIRectory "/shares/Setups"` to set the default directory for mass storage.

9.10 Creating Screenshots of Current Settings

The save/recall function enables you to save current settings in a file. To document the most important settings for a performed signal generation, you can also save a hardcopy of the current display.

- [Hardcopy Settings](#).....218
- [How to Save a Hardcopy of the Display](#).....222

9.10.1 Hardcopy Settings

Access:

- ▶ Select "System Config > Setup > User Interface > Hardcopy".

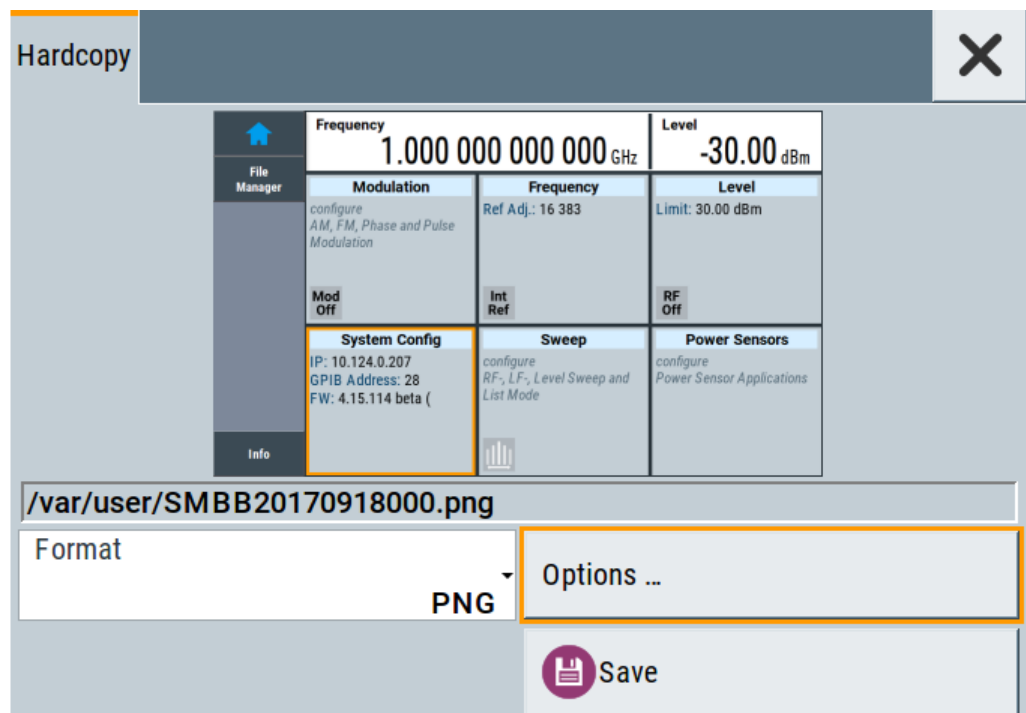

The remote commands required to define these settings are described in [Chapter 12.10, "HCOPY Subsystem"](#), on page 349.

Settings:

File.....	219
Format.....	219
Options.....	219
Save.....	219
Hardcopy Options > Common.....	219
L Automatic Naming.....	220
L Format.....	220
L Region.....	220
Hardcopy Options > Automatic Naming.....	220
L Path.....	221
L Clear Path.....	221
L Prefix, Year, Month, Day.....	221
L Current Auto Number.....	221

File...

In "Automatic Naming > Off" mode, accesses the standard file select dialog for selecting the filename and folder the hardcopy is stored in.

If you have enabled "Automatic Naming", the instrument displays the automatically generated filename.

Remote command:

`:HCOPY:FILE[:NAME]` on page 351

Format

Selects the output file format, for example *.bmp, *.jpg*.xpm and *.png.

Remote command:

`:HCOPY:IMAGe:FORMat` on page 351

`:HCOPY:DEVIce:LANGUage` on page 351

Options...

Accesses [Hardcopy Options](#) dialog.

Save

Saves a hardcopy of the current display as a file.

Remote command:

`:HCOPY[:EXECute]` on page 352

Hardcopy Options > Common

Access: select "Hardcopy > Options... > Common".

With the provided settings, you can customize the file format and the syntax of the automatically assigned filename.

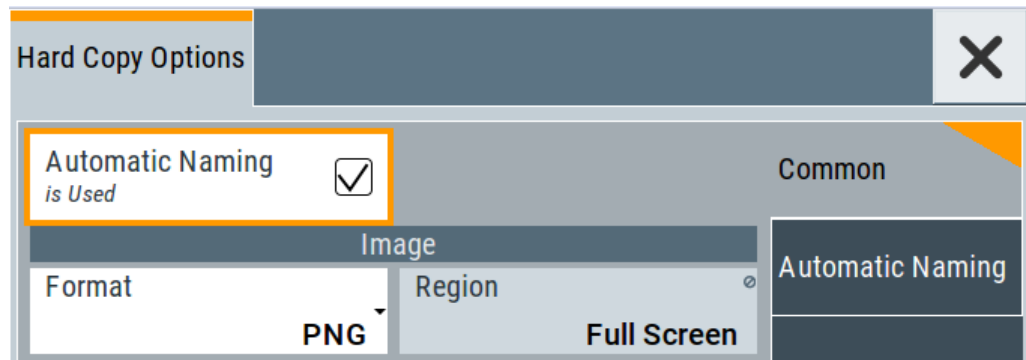

Automatic Naming ← Hardcopy Options > Common

If enabled, creates the output filenames automatically according to the rules set with the [Hardcopy Options > Automatic Naming](#) settings.

Remote command:

[:HCOPY:FILE\[:NAME\]:AUTO:STATE](#) on page 353

Format ← Hardcopy Options > Common

Selects the output file format, for example *.bmp, *.jpg*.xpm and *.png.

Remote command:

[:HCOPY:IMAGE:FORMAT](#) on page 351

[:HCOPY:DEVICE:LANGUAGE](#) on page 351

Region ← Hardcopy Options > Common

Displays the snapshot area.

Remote command:

[:HCOPY:REGION](#) on page 351

Hardcopy Options > Automatic Naming

Access: select "Hardcopy > Options... > Automatic Naming".

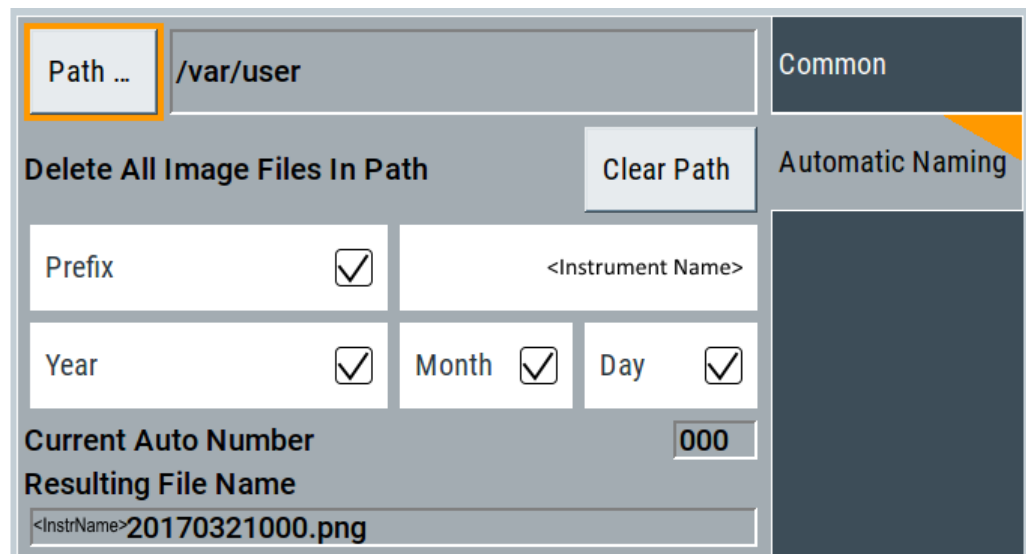

Provided are the following settings:

Path... ← Hardcopy Options > Automatic Naming

Selects the directory.

Note: To select the destination path, specify also a filename. Otherwise an error message is displayed and selection is canceled.

Remote command:

`:HCOPY:FILE[:NAME]:AUTO:DIRectory` on page 352

Clear Path ← Hardcopy Options > Automatic Naming

Deletes all image files with extensions *.bmp, *.jpg, *.png and *.xmp in the directory set for automatic naming.

Before the command is executed, a warning message prompts you to confirm the deletion of the files.

Remote command:

`:HCOPY:FILE[:NAME]:AUTO:DIRectory:CLEar` on page 353

Prefix, Year, Month, Day ← Hardcopy Options > Automatic Naming

Determines the rules for "Automatic Naming".

Per default, the automatically generated filename is composed of:

`<Path>/<Prefix><YYYY><MM><DD><Number>.<Format>`, where Y, M and D mean year, month, Day; Number is the [Current Auto Number](#).

You can activate or deactivate each component separately.

The "Resulting filename" indicates the current filename syntax.

Remote command:

`:HCOPY:FILE[:NAME]:AUTO[:FILE]:PREFix` on page 354

`:HCOPY:FILE[:NAME]:AUTO[:FILE]:PREFix:STATe` on page 354

`:HCOPY:FILE[:NAME]:AUTO[:FILE]:YEAR:STATe` on page 353

`:HCOPY:FILE[:NAME]:AUTO[:FILE]:MONTH:STATe` on page 353

`:HCOPY:FILE[:NAME]:AUTO[:FILE]:DAY:STATe` on page 353

Current Auto Number ← Hardcopy Options > Automatic Naming

Indicates the number which is used in the automatically generated filename.

Note: When initially switching on the instrument, the number is reset to the lowest possible value. Starting with number 0 the output directory is scanned for existing files. As long as files with the same name are existing, the number is increased by 1. The number is automatically set so that the resulting filename is unique within the selected path. The current number is not in the save/recall file but is temporarily stored within the database. At the following save operation, the number is increased.

Remote command:

`:HCOPY:FILE[:NAME]:AUTO[:FILE]:NUMBer?` on page 354

9.10.2 How to Save a Hardcopy of the Display

1. Select "System Config > Setup > User Interface > Hardcopy".

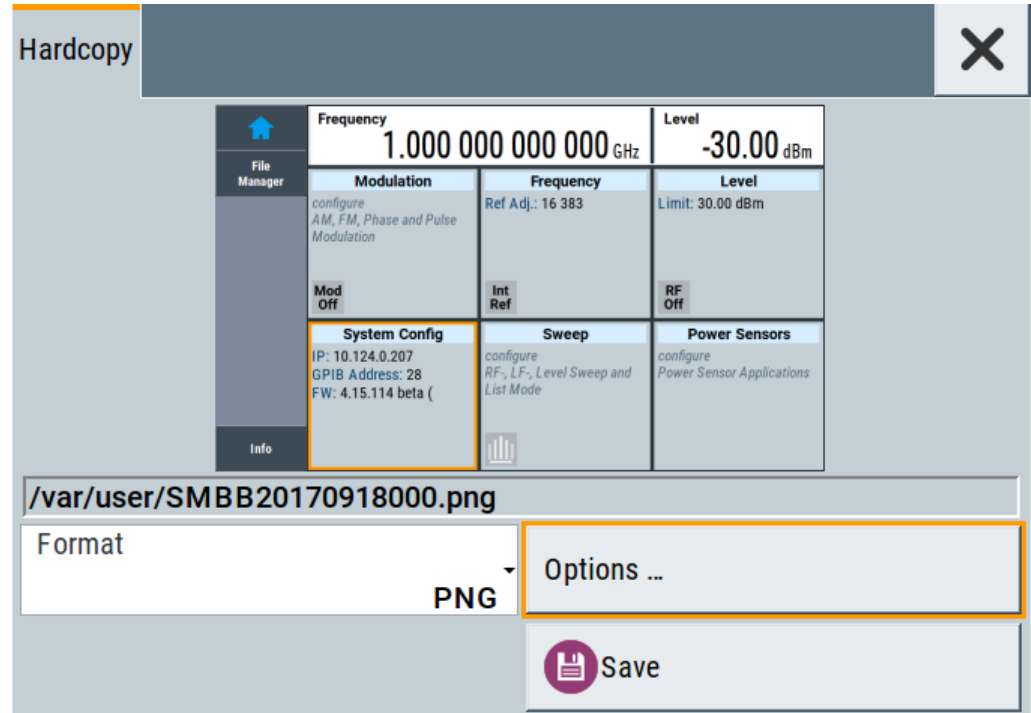

2. To define the output format, select "Format > JPG".
3. To enable the instrument to create output filenames, select "Automatic Naming > On".
4. Select "Options...".
5. In the "Hardcopy Options" dialog:
 - a) To change the default directory the file is saved in, select "Automatic Naming Settings > Path" and define a path and a filename. For example, select the default directory `/var/user`.
 - b) If necessary, disable or change some of the parameters in the "Automatic Naming Settings".
 - c) Close the "Hardcopy Options" dialog.
6. In the "Hardcopy" dialog, select "Save".
The instrument saves a hardcopy of the current instrument display as a `*.jpg` file. The filename is automatically created.
7. To print the hardcopy, connect the instrument to a LAN and:
 - a) Transfer the file to a remote computer as described in [Chapter 9.9, "How to Transfer Files from and to the Instrument"](#), on page 212.
 - b) On the remote computer, navigate through the file system.

- c) Print the selected file.
For more information, refer to the online help of the operating system.

10 General Instrument Functions

The general instrument functions include basic instrument settings, regardless of the selected operating mode and measurement. Some of these settings like screen display and peripherals are initially configured at the setup of the instrument, according to personal preferences and requirements. However, you can individually adjust the settings at any time, for example, if necessary for specific applications.

The following special functions help you in service and basic system configuration:

- [Chapter 10.1, "Customizing the User Interface"](#), on page 224
Allows you to adjust the display and keyboard language settings.
- [Chapter 10.2, "Organizing Frequently Used Settings as Favorites"](#), on page 229
Enables you to group user defined settings in a favorites list or to assign actions to the [★ (User)] as quick access for later retrieval.
- [Chapter 10.3, "Managing Licenses and License Keys"](#), on page 236
If you have purchased an additional option for the R&S SMB100B, you can enable it using a license key.
- [Chapter 9.2, "Restoring the \(Default\) Instrument Configuration"](#), on page 192
At any time, you can restore a default configuration to start a measurement at a defined instrument state, or set the instrument to factory preset.
- [Chapter 15.3, "Performing Maintenance Tasks"](#), on page 544
Special functions like calibration routines and self-tests put your instrument to an initial state.
- [Chapter 10.4, "Using the Security Settings"](#), on page 240
Special security and protection functions protect your instrument from unauthorized use or activate specific test routines.

10.1 Customizing the User Interface

The R&S SMB100B provides basic alignments of instrument settings regarding the user interface, that means the touch panel (screen), the appearance of the displayed dialogs and graphics, and an external keyboard.

Start / stop display update

The operating system of the R&S SMB100B refreshes the displayed settings by default in almost real-time, to keep the display updated with the internally used values. However, you can turn off this function to reduce settling times when the instrument is remote controlled.



We recommend that you switch off the display update for optimum sweep performance with short dwell times and for fast settling times.

Consider that in this case the displayed values can differ from the operated values.

In detail described in the following paragraphs, you can:

- Set display and keyboard language, see [Chapter 10.1.1, "Display and Keyboard Settings"](#), on page 225
- Set date and time for the system clock, see [Chapter 15.3.1, "Date and Time"](#), on page 544
- Configure and activate a [Screen Saver](#)
- Deactivate display update to improve performance, see [Chapter 10.1.2, "Display Update Settings"](#), on page 226
- Determine the state of the RF signal, and the level display in the status bar when you turn on the R&S SMB100B, see [Chapter 10.1.3, "Defining the RF Signal State On Power On"](#), on page 227.

10.1.1 Display and Keyboard Settings

Access:

1. Select "System Config > Setup > User Interface > Display/Keyboard > Display".

Display	USB Keyboard
Screen Saver <i>is Active</i> <input checked="" type="checkbox"/>	Wait time 10 Min
Brightness	
Display 14	RF Hardkey 14

2. Select "Display/Keyboard > USB Keyboard".

Display	USB Keyboard
Layout English (US)	

In the "Display/Keyboard" dialog, you can change regional and language options for the GUI and an external keyboard, and define the screen saver settings.

The remote commands required to configure the display and keyboard are described in [Chapter 12.8, "DISPlay Subsystem"](#), on page 343 and [Chapter 12.11, "KBOard Subsystem"](#), on page 354.

Screen Saver.....	226
Wait Time.....	226
Display.....	226
RF Hardkey.....	226
USB Keyboard > Layout.....	226

Screen Saver

Activates the screensaver.

If activated, the display including backlight is switched off after the selected **Wait Time** elapses and if no entries via touch panel, front panel, external mouse, or external keyboard are made

Remote command:

`:DISPlay:PSAVe[:STATe]` on page 345

Wait Time

Enters the idle time that must elapse before the display lamp is shut off when no entries are made.

Remote command:

`:DISPlay:PSAVe:HOLDoff` on page 344

Display

Adjusts the brightness of the display.

Increase the value to turn up the display brightness.

Remote command:

`:DISPlay:BRIGhtness` on page 345

RF Hardkey

Adjusts the brightness of the [RF on/off] key.

Increase the value to change the contrast between the key and the front panel background color.

Remote command:

`:DISPlay:BUtTon:BRIGhtness` on page 345

USB Keyboard > Layout

Selects the language of an externally connected keyboard via USB. The function assigns the corresponding keys automatically.

Remote command:

`:KBOard:LAYout` on page 355

10.1.2 Display Update Settings

Access:

- ▶ Select "System Config > Setup > User Interface > Start/Stop Display Update".

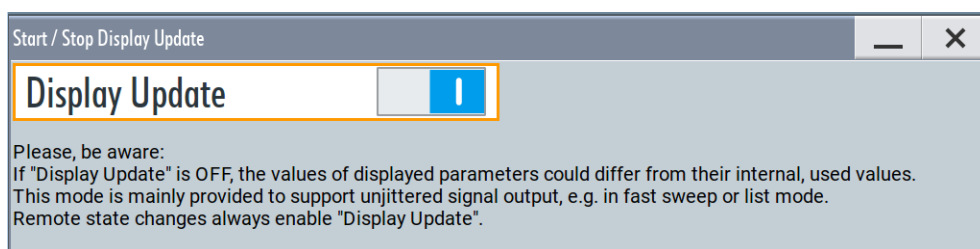

This dialog enables you, to deactivate updating the display.

The remote command to switch off the display update is described in [Chapter 12.8, "DISPlay Subsystem"](#), on page 343.

Display Update is

Disables the automatic refreshing of the displayed values.

Remote command:

[:DISPlay:UPDate](#) on page 345

10.1.3 Defining the RF Signal State On Power On

As additional functions for the level settings, you can determine the state of the RF signal, and the level display in the status bar when you turn on the R&S SMB100B.

Power-On/EMF settings

Access:

- ▶ Select "Level" > "Power-On / EMF".

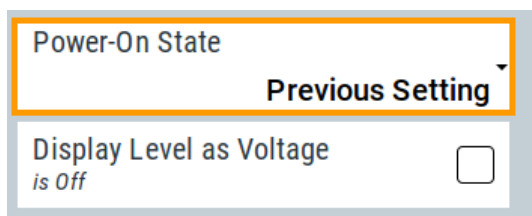

The "Power-On/EMF" dialog contains all settings for configuring the power-on behavior and the level display.

Settings:

Power-On State	227
Display Level as Voltage of EMF	228

Power-On State

Determines the RF signal output state when the instrument is switched on.

You can disable the RF output signal in general, or start it in the same state as it had been when it was switched off.

Remote command:

`:OUTPut<hw> [:STATe] :PON` on page 356

Display Level as Voltage of EMF

Activates display of the signal level as voltage of the EMF (no-load voltage).

If disabled, the level is displayed as a voltage over a 50 Ohm load.

Note:

The setting is not affected by an instrument preset ([Preset] key or *RST) and the "Save/Recall" function. It is reset only by factory preset.

Remote command:

`[:SOURce<hw>] :POWer:EMF:STATe` on page 452

10.1.4 How to Set the Initial Instrument Settings

This section describes how to set up the R&S SMB100B initially.

10.1.4.1 Setting the Keyboard Language

You can select the language of the external keyboard connected to the instrument.

To adjust the keyboard settings

1. Press the [Setup] key.
2. Select "User Interface > Keyboard".

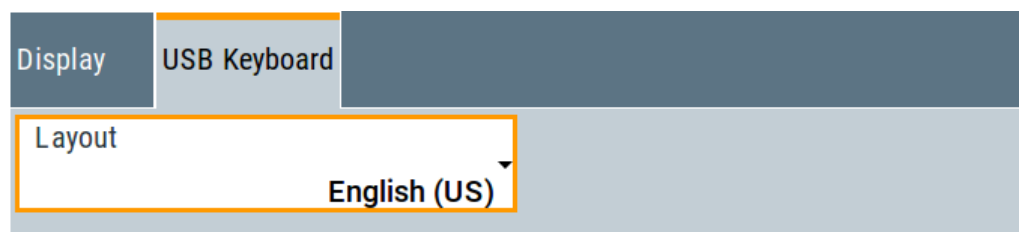

3. Select the "Layout".

The dialog closes and the changes take effect immediately.

10.1.4.2 Setting the Screen Saver

You can enable a screen saver that automatically turns off the display after a user-defined period of time. The screen saver is activated if no settings are made on the touch screen, or via keys or the rotary knob during the selected wait time.

To activate the screen saver

1. Press the [Setup] key.
2. Select "User Interface > Display"

3. Activate the "Screen Saver".

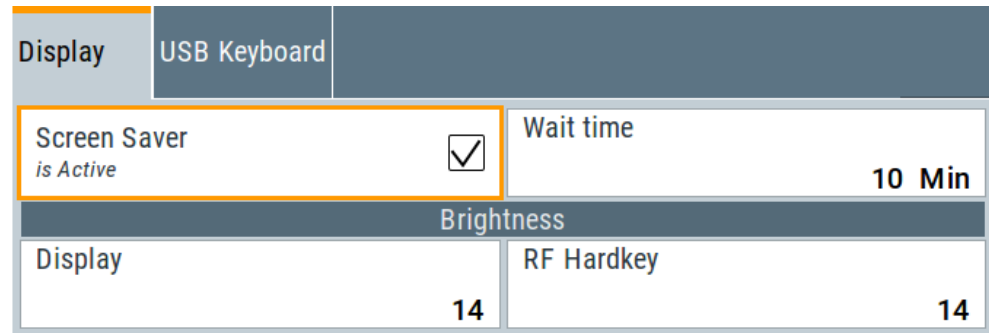

4. Define the "Wait Time" in minutes.
The instrument turns off the display after the defined period of time.
5. To reactivate the display, tap the screen or press any key on the front panel.

To deactivate the screen saver

1. Press the [Setup] key.
2. Select "User Interface > Display"
3. Disable the "Screen Saver" state.

10.2 Organizing Frequently Used Settings as Favorites

The R&S SMB100B provides two possibilities to define frequently used settings and procedures for later retrieval individually.

User menu and [★ (User)] key

These two functions work similar to the favorites function of a browser or other programs. They allow you to create a list of frequently used actions or to group frequently used settings in one dialog.

You can collect the parameters of your configuration in a favorites list, i.e. in the "User Menu", or define settings and actions with the [★ (User)] key:

- "User Menu" to group settings of specific tasks.
Similar to a favorites function, you can use this menu for:
 - Grouping the settings required for a task in one dialog.
 - Saving and recalling the settings of a task.
 - Transferring the settings for use on multiple instruments.
- [★ (User)] key, with customizable function.
You can perform the following steps using this key:
 - Open the "User Menu" (default functionality).
 - Add or remove settings and functions.

- Execute actions and access functions.

Possible applications

The ★ (User) key and the "User Menu" are useful for the following situations:

- There are functions or tasks you have to perform in a defined order but the setting parameters are distributed across several dialogs.
- There are functions or tasks you have to perform frequently but they are not accessible via the front panel keys.
- The required functions are grouped in a dialog that is not directly accessible from the home screen.
- Your task involves the frequently loading and executing of certain SCPI scripts. Refer to [Chapter 11.8.4, "How to Record / Create SCPI Lists"](#), on page 305 for information on how to create an SCPI script.
- A quick access to saved setups is required.
- There are functions and tasks you have to perform on several instruments.

Dialog identification

To identify each dialog, the instrument uses a dedicated dialog ID. The dialog ID contains the dialog position on the display and the current active tab. The action that triggers the instrument to open a dialog uses this identification.

Save/Recall vs. recall setup

If you need to restore a specific signal generation setup and perform further configurations based on this particular instrument state, the R&S SMB100B provides two options:

- "Save/Recall" function
For a detailed description, refer to [Chapter 9.4, "Saving and Recalling Instrument Settings"](#), on page 197.
- "Recall Setup" function
If the "Recall Setup" is the only user action assigned to the [★ (User)] key, pressing this key triggers the R&S SMB100B to load the user-defined preset file immediately.

10.2.1 User Menu Settings

The "User Menu" dialog contains function keys to organize, save and load a favorites list. You can also modify, add or delete list entries directly in the dialog.

Clear User Menu

Removes all entries from the "User Menu" at once.

Save User Menu

Saves the current "User Menu" under the defined filename.

Recall User Menu

Loads the selected "User Menu" file.

This function enables you to use the user specific favorites file on another instrument. However, if functions or parameters are not provided due to varying configuration of the instrument, the settings of these particular parameters take no effect.

10.2.2 How To Use the User Menu for Fast Adjustments

Access:



1. Press the [★ (User)] key.

The "User Menu" dialog opens.

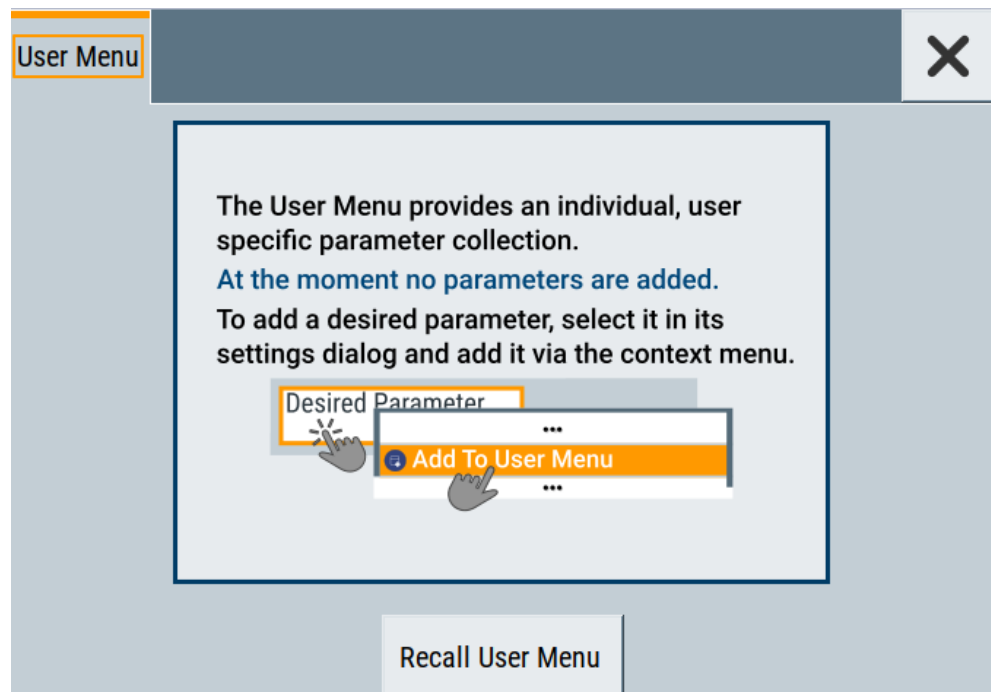

If you execute this action for the first time, the dialog displays instructions on how to use the "User Menu".

2. If you already have a saved user menu file on the instrument, you can load with "Recall User Menu".

Creating a "User Menu"

To create your own user dialog with settings:

1. Open a dialog with settings you frequently use.
2. Select a parameter.
3. Open the context menu and select "Add to User Menu".



A favorites icon ★ indicates that the parameter is used in the "User Menu".

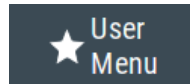

The "User Menu" button in the taskbar confirms that you have created a "User Menu" with at least one entry.

4. Press the [★ (User)] key.

The "User Menu" dialog shows all parameters that you have added to the list.

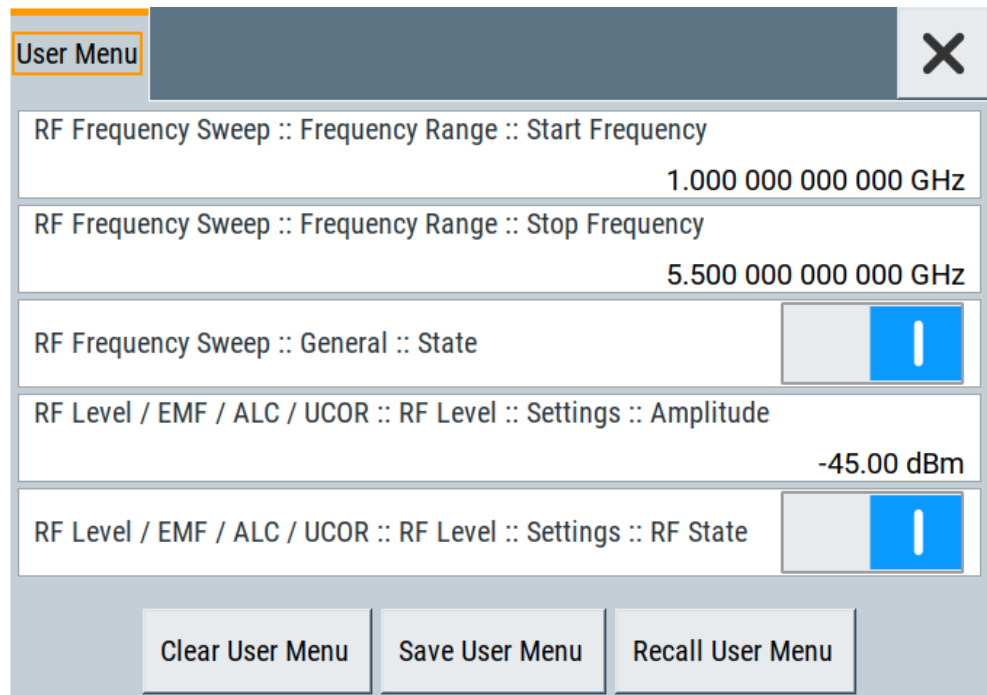

You can modify the parameter settings directly in this dialog, e.g. change a state or set values, as you do in the particular dialog the parameter originally belongs to.

5. To remove an entry, select the parameter either in the "User Menu" or in the dialog where it originally belongs to.
 - a) Open the context menu and select "Remove from User Menu".



6. To remove all entries at once, select "Clear User Menu".

7. To save your individual favorites list, select "Save User Menu", and follow the file managing instructions.
The file system automatically assigns the file extension *.user_menu.
8. To recall a previously saved user menu, select "Recall User Menu" and proceed accordingly.

Providing a user menu favorites list for several instruments

To transfer files from or to an instrument:

1. Create the favorites list, as described in "Creating a "User Menu"" on page 231.
2. Save the favorites list.
3. To transfer a file from or to an instrument, the R&S SMB100B provides several options, see "File handling" on page 190.

10.2.3 Define User Key Actions Settings

Access:

- ▶ Select "System Configuration > Setup > User Interface > Define User Key".

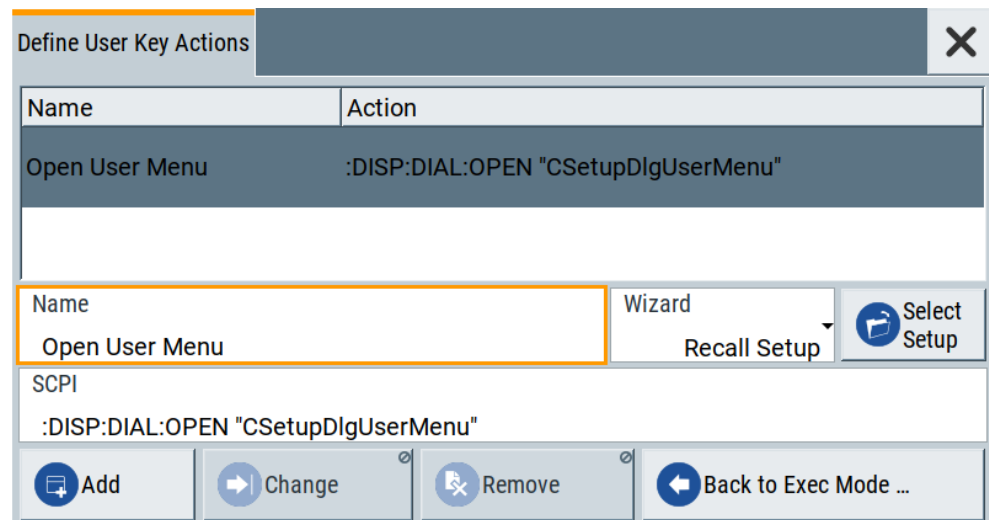

The dialog displays a list of the currently enabled actions and provides functions to define new, edit or remove existing actions. If no actions have been defined, the list is empty.

See [Chapter 10.2.4, "How to Assign Actions to the \[★ \(User\)\] Key"](#), on page 235.

The remote commands required to define these settings are described in [Chapter 12.8, "DISPlay Subsystem"](#), on page 343.

Name

Enters a user-defined name for the action.

Wizard

Defines the action to be executed.

"Load SCPI Script"

Selecting the action load and executes the SCPI script.

"Recall Setup" Load a setup for quick access to the user-defined settings.

"Open Dialog"

Quick access to the selected dialog.

Select

Depending on the selected "Wizard", provides access to:

- The standard "File Select" function for loading of an SCPI script or setup file
- A list of the dialog IDs of all currently opened dialogs. The dialog ID is used for dialog identification in the remote control.
See [SCPI](#).

SCPI

For the currently selected action, displays the corresponding SCPI command with the associated parameter for dialog identification (dialog ID). The automatically displayed SCPIs are enabled for subsequent modification.

Remote command:

[:DISPlay:DIALog:OPEN](#) on page 347

See also [:DISPlay:DIALog:ID?](#) on page 346

Add, Change, Remove

Standard functions for managing of the actions.

Back to Execute Mode

Opens the "Select Action to Execute" dialog. Select an Action form the list to execute it.

To return to the "Define User Key Actions" dialogs, select [Select Action to Execute > Define Actions](#).

Select Action to Execute > Define Actions

Name	Action
Open User Menu	:DISP:DIAL:OPEN "CSetupDlgUserMenu"
Open	:DISP:DIAL:OPEN "CSetupFrontPanelKe...

 Define Actions ...

Accesses the "Define User Key Actions" dialog.

10.2.4 How to Assign Actions to the [★ (User)] Key

The customizable [★ (User)] key has no predefined function assigned. You can individually define actions to be executed or functions to be accessed when pressing this key.

To assign a frequently used dialog to the [★ (User)] key:

1. Open the dialog you want to quickly access.
For example, select "Level > UCOR > Import/Export"
2. Select "System Configuration > Setup > User Interface > Define User Key".
3. To create an action:
 - a) Specify the "Name".
E.g. *OpenUcorImportExportList*.
 - b) Select "Wizard > Open Dialog"
 - c) Select "Select" and select the dialog ID from the list

The corresponding SCPI command is automatically displayed and can be later modified.

4. Select "Add" to store the new action in the list of user key actions.

Name	Action
Open User Menu	:DISP:DIAL:OPEN "CSetupDlgUserMenu"
OpenUcorImportExportList	:DISP:DIAL:OPEN "DlgKeyRf_Ucor\$t3\$t0\$t0"

Name: OpenUcorImportExportList Wizard: Open Dialog Select

SCPI: :DISP:DIAL:OPEN "DlgKeyRf_Ucor\$t3\$t0\$t0"

Add Change Remove Back to Exec Mode ...

5. To execute the created action, press ★ (User).
In the list of actions ("Select Action to Execute" dialog), navigate to the required action.
In this example, this is "OpenUCORImportExportList".

Define User Key Actions	
Name	Action
OpenUCORImportExportList	:DISP:DIAL:OPEN "DlgKeyRf_Ucor\$t3\$t0..."
Open User Menu	:DISP:DIAL:OPEN "CSetupDlgUserMenu"

The R&S SMB100B executes the action and opens the dialog.

10.3 Managing Licenses and License Keys

An option is ready to operate after it is enabled with a license keycode supplied with the option. The license key is delivered as a file or on paper. Unregistered licenses must be registered for a particular instrument before the corresponding option can be enabled for operation.



For reliable operation, a software option usually requires the latest firmware version. The required version is specified in the delivery. If your instrument works with a former firmware version, update the firmware before enabling the software option.

The firmware update is described in the R&S SMB100B service manual.

10.3.1 Manage License Keys Settings

This dialog is the central dialog for licenses registration and performing the required instrument-related steps during the process of unregistration.

Access:

1. Select "System Config > Setup > Instrument Assembly > Manage License Keys > Manage License Keys".

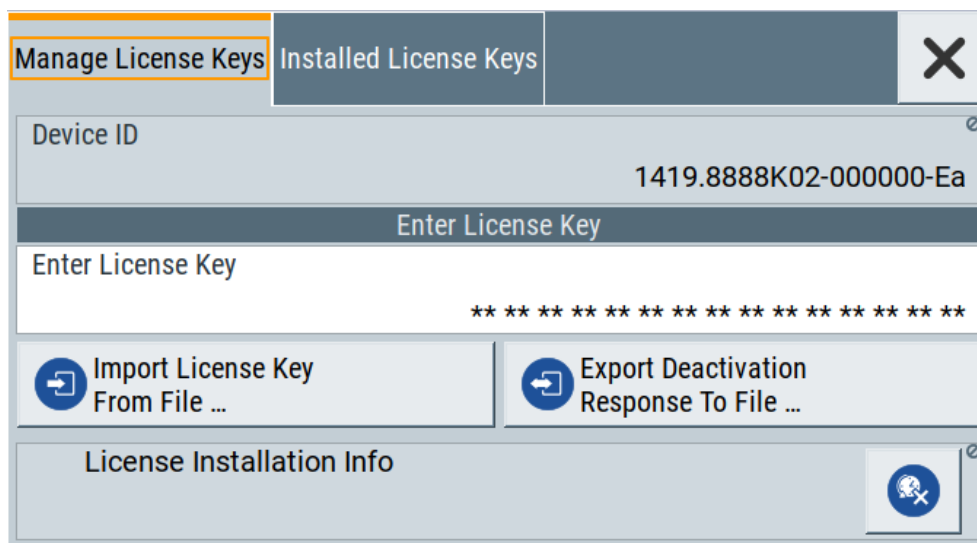

2. Select "System Config > Setup > Instrument Assembly > Manage License Keys > Installed License Keys".

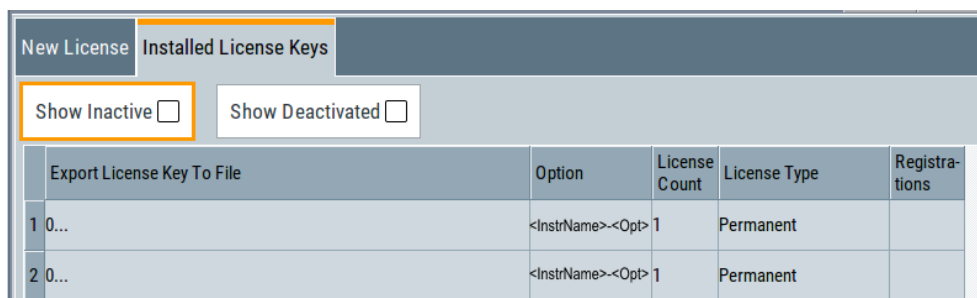

In the "New License" tab, you can activate licenses for newly purchased or newly registered options. The "Installed License Keys" tab enables you to cancel already registered options, or move licenses.

Settings

Device ID.....237

Enter License Key.....238

Import License Key from File.....238

Export Deactivation Response to File.....238

License Installation Info.....238

Installed License Keys.....238

- └ Show Inactive.....238
- └ Show Deactivated.....238
- └ Installed License Keys Table.....238

Device ID

Displays the instrument-specific identification number. The device ID is a unique string with the following structure:

<stock number>-<serial number>-<checksum>

Enter License Key

Type here the license key provided with the option.

For license keys delivered as a file, use [Import License Key from File...](#)

Import License Key from File...

Opens a dialog for selecting the file with the license key.

Use this function also to import the deactivation key file generated by the R&S License Manager online tool (see [How to Move a Portable License](#)).

Export Deactivation Response to File...

Exports the generated deactivation response key to a file and opens a file management dialog to save the file.

This key is required during the unregistration process, e.g. when you want to deinstall an option or have a portable option, which you want to register later on another instrument (see [How to Move a Portable License](#)).

License Installation Info

Indicates status information on the performed actions.

Installed License Keys

Access: select "System Config > Setup > Instrument Assembly > Manage License Keys > Installed License Keys".

Comprises information on the installed options.

Show Inactive ← Installed License Keys

Enables the display of the inactive (expired) licenses in the [Installed License Keys Table](#).

Show Deactivated ← Installed License Keys

Enables the display of the deactivated licenses in the [Installed License Keys Table](#).

See [How to Move a Portable License](#) for information on how to activate deactivated licenses.

Installed License Keys Table ← Installed License Keys

Shows information on the currently installed options.

"Export License Key to File"

Opens a dialog to save the generated license key file. This file is required during the unregistration process.

If you have a portable unregistered option, you can register it later on another instrument (see [How to Move a Portable License](#)).

"Option"

Displays the option short designation.

Tip: Open the [Hardware Options/Software Options](#) dialog to retrieve more information about the installed options.

"License Count"

Displays the number of the licenses for the selected option key.

- "License Type" Displays the type of license.
A license type determines the common qualification application duration and the portability of a license. The following license types are provided: evaluation, permanent, portable, quantified, time-controlled with a duration of 1, 3, 6 or 12 months. A license can also be deactivated or expired.
For time limited licenses, the left time of applicability is displayed too.
- "Registrations" (reserved for future use)

10.3.2 How to Move a Portable License

This example is intended to explain how to perform the required steps at the instrument.

Use a USB flash drive to transfer the license key files between the instruments and the browser.



We assume knowledge about the handling of the R&S License Manager online tool and the description of the whole process.

1. Open your browser. Enter <https://extranet.rohde-schwarz.com/service>.
Select "Manage Licenses > Move Portable License".
The first step requires the Device IDs of the source and target instruments.
2. To find out the Device IDs, proceed as follows:
 - a) On the source instrument, select "System Config > Setup > Instrument Assembly > Manage License Keys > Manage License Keys > Device ID".

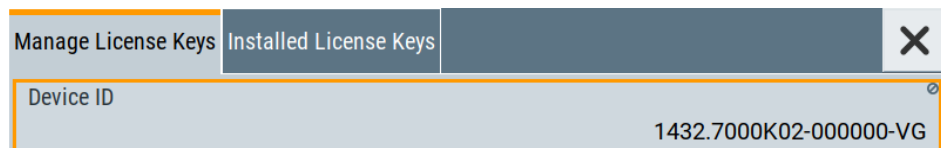

- b) On the target instrument, select "System Config > Setup > Instrument Assembly > Manage License Keys > New License > Device ID".
 - c) In the browser, select "Manage Licenses > Move Portable License > Select Devices" and enter the Device IDs.
3. On the source instrument, select "System Config > Setup > Instrument Assembly > Manage License Keys > Installed License Keys > License Keys Table".
Navigate to the portable license you want to move.
Select the "Export License to File" column.
A standard file manager dialog opens.
4. Enter a filename. Save the exported license key, e.g.
`k123_portable_key_to_move.xml`.
5. In the browser, select "Manage Licenses > Move Portable License > Select License (from file)" and select the exported license key.

Check the selection. Create the deactivation key. Save it to file.

6. On the source instrument, select "System Config > Setup > Instrument Assembly > Manage License Keys > Manage License Keys > Import License Keys from File".
Select the transferred deactivation key.
7. On the source instrument, select "System Config > Setup > Instrument Assembly > Manage License Keys > Manage License Keys > Export Deactivation Response to File".
8. In the browser, go to "Manage Licenses > Move Portable License > Install Deactivation Key (from file)".
Enter the deactivation response of the instrument.
The license is deactivated for the source instrument.
9. In the "Manage Licenses > Move Portable License", go to step "Create License" to generate a license key for this portable option and the selected target instrument.
Download the license key as a file. Transfer it to the target instrument.
10. In the target instrument, select "System Config > Setup > Instrument Assembly > Manage License Keys > New License > Import License Keys from File".
Select the created license key file.

The portable option is installed on the target instrument.

10.4 Using the Security Settings

The protection function of the R&S SMB100B offers several levels to activate particular functions like self-test or tests for service purposes specifically.

Protection

The five protection levels are automatically active on startup, the protection levels, that means all protected functions are locked.

To unlock a protection level:

- ▶ In the "System Config > Setup > Security > Protection", enter the correct password.

To lock a protection level:

- ▶ Clear the corresponding checkbox.

Protection levels

The following functions are protected in the respective levels:

- Protection level 1
Protects against accidental changes, like, for example, the clock and date, several internal adjustments functions and the self-test, as well as network settings or the instrument hostname.
You can access this level with the password 123456.

- Protection level 2
Unlocks protected service functions. It is accessible to authorized personnel of Rohde & Schwarz service department only.
- Protection level 3 to 5
Are reserved for internal use.

Security

The security concept of the R&S SMB100B helps you to protect your instrument against uncontrolled access and changes. All provided security services require that you enter the security password.

Provided security services are:

- **General** security parameters, such as:
 - **USB storage** that secures controlled access to the mass memory of the instrument
 - **Volatile mode** that prevents information to be written to the internal memory permanently.
 - **Sanitizing** that prevents the instrument from leaving a secure environment with stored user information.
 - **Annotation** frequency and amplitude prevent reading the display.
 - **Secure Update Policy** check that verifies the integrity and origin of the firmware package to be installed.
To access the settings of these topics, see [Setting Security Parameters > "Secure Update Policy"](#) on page 243.
- **Password** management secures controlled user access to the instrument
With the two-step password concept, you can assign a user-defined password for the operating system, and a security password for accessing the mass storage of the instrument.
See also [Chapter 10.4.4, "Password Management"](#), on page 250.
- **LAN services** secure controlled network access
You can individually lock and unlock the supported LAN interface services, see [Chapter 10.4.3, "Configuring LAN Services"](#), on page 248.
Remote control via LAN interface requires that the interface is activated, but you can enable the required services specifically.
- **User interface** prevents front panel operation and/or reading the display.

For more information, see the document R&S SMB100B Instrument Security Procedures.

10.4.1 Protection Level Settings

Access:

- ▶ Select "System Config > Setup > Security > Protection".

Protection Level 1	<input checked="" type="checkbox"/>	<input type="password" value="Password"/> *****
Protection Level 2	<input checked="" type="checkbox"/>	<input type="password" value="Password"/> *****
Protection Level 3	<input checked="" type="checkbox"/>	<input type="password" value="Password"/> *****
Protection Level 4	<input checked="" type="checkbox"/>	<input type="password" value="Password"/> *****
Protection Level 5	<input checked="" type="checkbox"/>	<input type="password" value="Password"/> *****

The "Protection" dialog provides access to the unlocking of different protection levels.

Several functions in the instrument are password-protected to prevent for example accidental changes, "[Protection](#)" on page 240.

The remote commands required to unlock a protected stage are described in [Chapter 12.15, "SYSTem Subsystem"](#), on page 475.

Protection Level/Password

Unlocks the selected level of protection, if you enter the correct password.

The default protection level 1 password is 123456.

To lock the protection level again, clear the checkbox.

Remote command:

`:SYSTem:PROTect<ch>[:STATe]` on page 483

10.4.2 Setting Security Parameters

Access:

- ▶ Select "System Config > Setup > Security > Security > General".

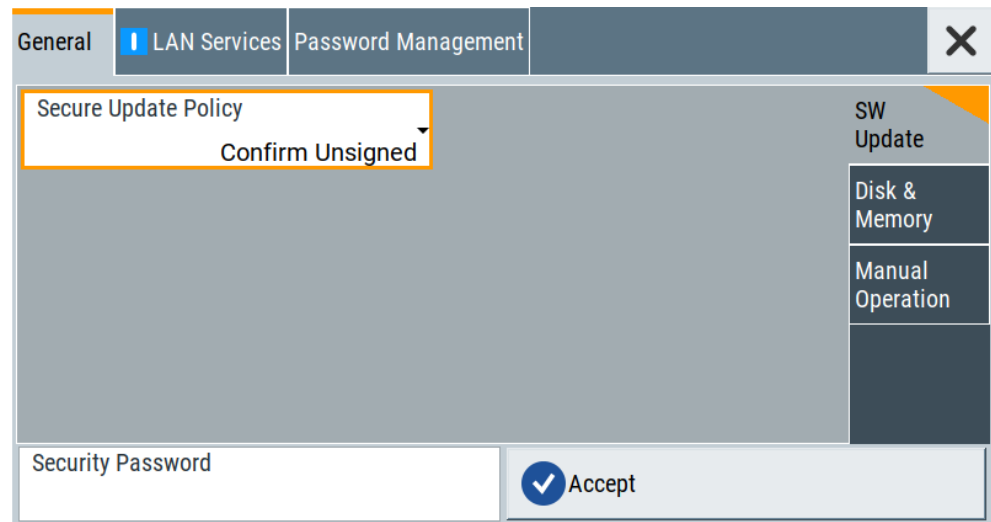

In the "General" tab, you can determine the security level for firmware updates, and configure the security settings for the mass memory and manual operation.



All modified settings in this dialog are not applied until you enter the [Security Password](#) and confirm with [Accept](#).

10.4.2.1 Update Policy Security Settings

Access:

- ▶ Select "System Config > Setup > Security > Security > General > SW Update".

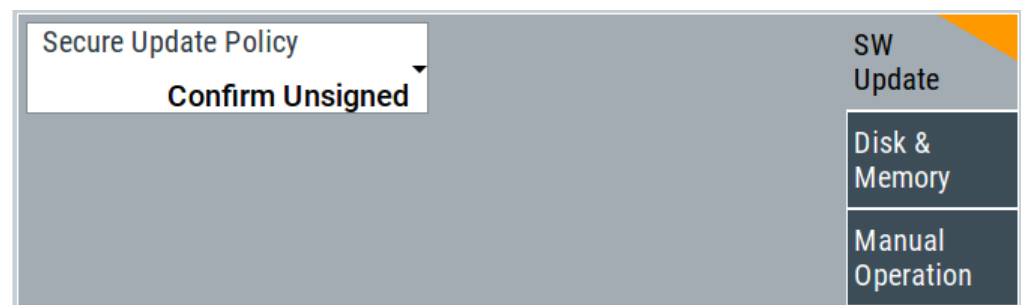

The SW Update tab enables you to select the security mode for firmware updates.

The remote commands available to control security settings are described in [Chapter 12.15, "SYSTem Subsystem"](#), on page 475.

Secure Update Policy

Allows you to configure the automatic signature verification for firmware installation.

To apply the change: enter the security password and confirm with "Accept". Otherwise the change has no effect.

See also:

- [Chapter 10.4, "Using the Security Settings"](#), on page 240 for more information on the security concept.
- The release notes for details on signature verification when installing new or former firmware versions, available at www.rohde-schwarz.com/firmware/smb100b.

"Confirm Unsigned"

Performs the signature verification.

If the check detects any discrepancies, the instrument issues a warning message. You can still update the firmware or reject updating.

This setting also enables you to downgrade the firmware version.

"All Packages" Accepts all packages without signature verification.

"R&S Signed Packages"

Performs the signature check.

If the check detects any discrepancies, the instrument issues a warning message and locks the update to this firmware.

Remote command:

:SYSTem:SECurity:SUPolicy on page 492

10.4.2.2 Disk & Memory Security Settings

Access:

- ▶ Select "System Config > Setup > Security > Security > General > Disk & Memory".

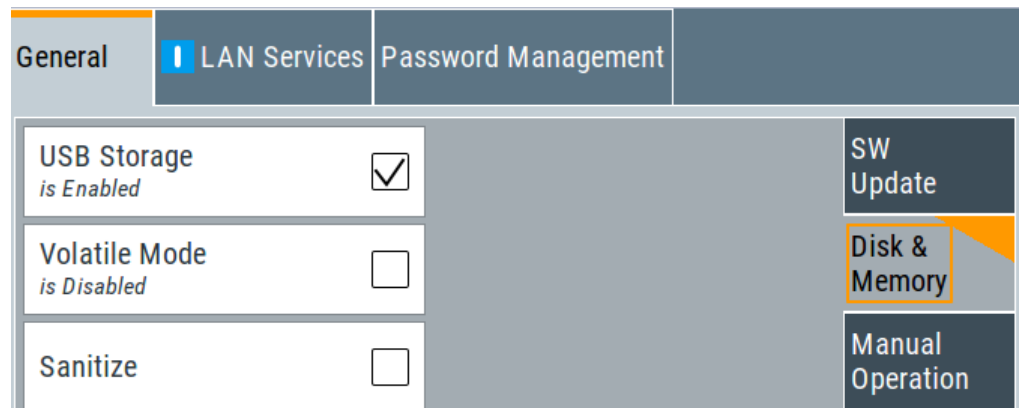

The "Disk & Memory" tab secures controlled access to the mass memory and prevents information from leaving a secure environment.

The remote commands available to control security settings are described in [Chapter 12.15, "SYSTem Subsystem"](#), on page 475.

USB Storage

Activates the access to external USB storage media.

To apply the change: enter the security password and confirm with "Accept". Otherwise the change has no effect.

See also [Chapter 9.9.4, "Using a USB Storage Device for File Transfer"](#), on page 217.

Note: Remove all USB memory devices before disabling the USB storage. If any USB memory device remains connected, disabling is blocked, and the instrument returns a warning message.

Volatile Mode

Activates volatile mode, so that no user data can be written on the internal memory permanently.

In volatile mode:

- Data that the instrument normally stores on the internal memory is redirected to volatile memory.
- The user directory is mapped to the volatile memory. You access the temporary data just as data stored in the `/var/user/`, see [Chapter 9.3, "Protecting Data"](#), on page 197.
- Data on the internal memory cannot be changed. It is protected against modification or erasure.
- You can only save data:
 - Temporarily in the volatile memory
 - On a connected external storage device, such as a memory stick

To activate volatile mode: enter the security password, confirm with "Accept" and reboot the instrument. Otherwise the change has no effect.

Activated volatile mode is indicated by the icon .

Remote command:

`:SYSTEM:SECURITY:VOLMode[:STATe]` on page 484

Sanitize

Executes the erase procedure that sanitizes the internal memory.

If the instrument is subject to high security, and you have not enabled the volatile mode, the internal flash memory holds user-data, i.e. it poses a security risk. The sanitizing function makes sure that no user information is stored on the instrument when it leaves the secure environment.

To apply the change: enter the security password and confirm with "Accept". Otherwise the change has no effect.

See also [Chapter 10.4, "Using the Security Settings"](#), on page 240 for more information on the security concept.

Remote command:

`:SYSTEM:SECURITY:SANitize[:STATe]` on page 492

10.4.2.3 Manual Operation Security Settings

Access:

- ▶ Select "System Config > Setup > Security > Security > General > Manual Operation".

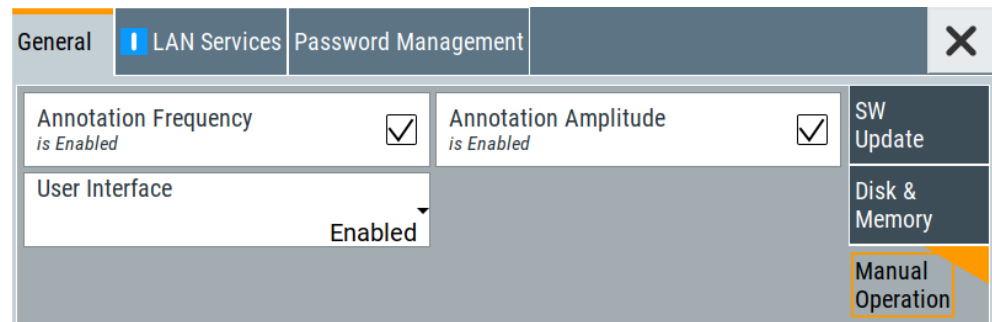

The "SW Update" tab enables you to lock front panel operation and/or reading the display.

The remote commands available to control security settings are described in:

- [Chapter 12.8, "DISPlay Subsystem"](#), on page 343
- [Chapter 12.15, "SYSTem Subsystem"](#), on page 475.

Annotation Frequency

Enables the display of the currently used frequency in the status bar.

How to: see ["Disabling the frequency and level indication in the status bar"](#) on page 253.

Remote command:

`:DISPlay:ANNotation:FREQuency` on page 346

Annotation Amplitude

Enables the display of the currently selected level in the status bar.

How to: see ["Disabling the frequency and level indication in the status bar"](#) on page 253.

Remote command:

`:DISPlay:ANNotation:AMPLitude` on page 346

User Interface

Allows you to lock the controls for manual operation and the display individually.

How to: see ["Deactivating the user interface"](#) on page 253.

See also [Chapter 10.4, "Using the Security Settings"](#), on page 240.

"Enabled" Enables the display and all controls for the manual operation of the instrument.

"Touchscreen Off"

Locks the touch sensitivity of the screen.

This security feature protects the instrument against unintentional change of settings by accidentally touching of the screen.

Still available controls for manual operation are:

- The keys at the front panel, including the rotary knob
- The external mouse and keyboard
- Remote operation over VNC

The instrument indicates the locked touchscreen by an icon .

Unlocking is possible via VNC, external controls or remote control.

"VNC Only"

Locks the keys at the front panel, the touchscreen and externally connected keyboard and mouse.

The display on the screen remains and shows the current settings and changes.

The instrument indicates the activated "VNC only" feature by the icon .

Unlocking is possible via VNC or turning off and on again.

"Display Only"

Locks the manual operation of the instrument. The display on the screen remains and shows the current settings and changes.

This security feature protects the instrument against unauthorized access, but still shows the current settings and processes, for example when you operate the instrument via remote control.

The function disables:

- The touchscreen functionality of the display
- The keys at the front panel of the instrument
- The external mouse and keyboard

The instrument indicates the locked controls by a padlock  softkey.

How to unlock: see ["Unlocking \(reactivating\) the user interface for manual operation"](#) on page 254.

"Disabled"

Locks the display and all controls for the manual operation of the instrument.

This security feature protects the instrument against unauthorized reading and access, for example when you operate the instrument via remote control.

The function disables:

- The display
- The touchscreen
- The keys at the front panel of the instrument
- The external mouse and keyboard

The screen shuts off and displays a padlock symbol  instead.

How to unlock: see ["Unlocking \(reactivating\) the user interface for manual operation"](#) on page 254.

Remote command:

:SYSTem:ULOCK on page 482

:SYSTem:DLOCK on page 481

:SYSTem:KLOCK on page 481

Enabling a locked user interface for manual operation

Follow the instructions listed in "[Unlocking \(reactivating\) the user interface for manual operation](#)" on page 254.

Remote command:

:SYSTem:ULOCK on page 482

:SYSTem:DLOCK on page 481

:SYSTem:KLOCK on page 481

10.4.3 Configuring LAN Services

Access:

- ▶ Select "System Config > Setup > Security > Security > LAN Services".

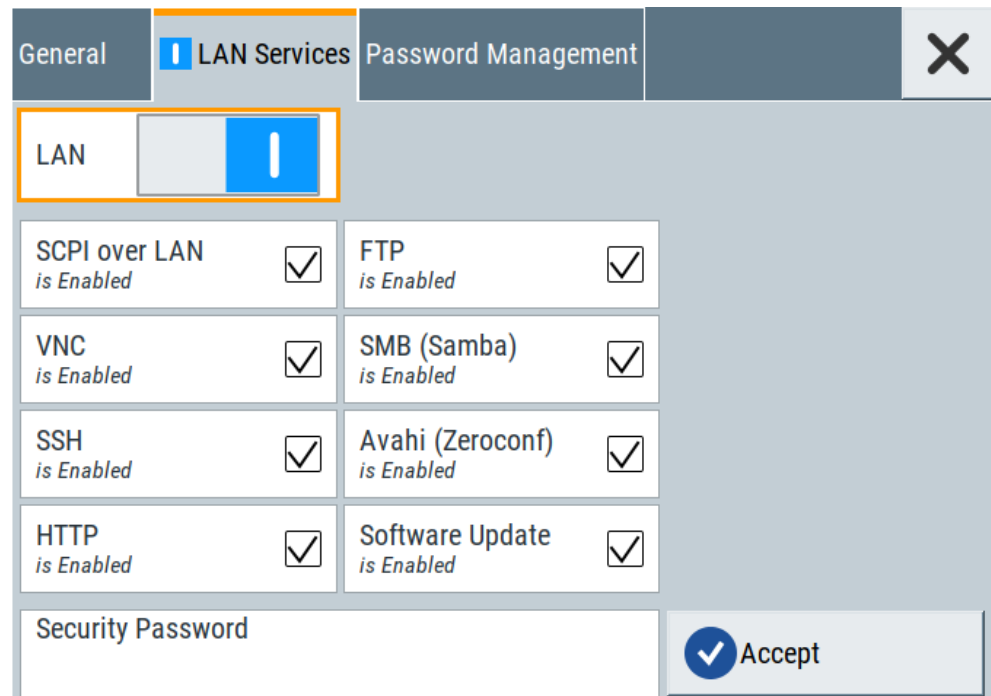

In the "LAN Services" dialog, you can individually enable or disable the supported LAN interface services.

How to:

- "[Disabling the LAN interface](#)" on page 253.
- "[Disabling LAN services](#)" on page 253.

LAN

Enables the LAN interface in general, and thus provides remote access via all unlocked services.

Enable LAN Services individually

Enables or disables the following interface services individually.

"SCPI over LAN"

Activates access over LAN to control the instrument remotely, by using SCPI (Standard Commands for Programmable Instruments) commands.

See also ["Starting a remote control session over LAN with R&S VISA"](#) on page 294.

"VNC"

Activates access via VNC (Virtual Network Computing) interface, a graphical desktop sharing system that uses RFB protocol to control the instrument remotely.

See also [Chapter 11.9, "Operating the R&S SMB100B Remotely via VNC"](#), on page 310.

"SSH"

Activates access via SSH (Secure Shell), a network protocol for secure data communication.

"HTTP"

Activates access via HTTP (Hyper Text Transfer Protocol), the application protocol for hypermedia information systems.

"FTP"

Activates access via FTP (File Transfer Protocol), used to transfer files from a host to the instrument and vice versa.

See also [Chapter 9.9.2, "Accessing the File System of the R&S SMB100B via ftp"](#), on page 214.

"SMB (Samba)"

Activates access to SMB (Server Message Block), used for providing shared access to files, printers and serial ports of a network.

See also [Chapter 9.9.3, "Accessing the R&S SMB100B File System via SMB \(Samba\)"](#), on page 215.

"Avahi (Zeroconf)"

Activates Avahi, a service for automatic configuration of the instrument in a network environment.

"Software Update"

Allows updating the software.

Security Password

Enters the password that is required to enable or to disable the settings protected by a security password. Default is 123456.

How to:

- ["Disabling the LAN interface"](#) on page 253
- ["Disabling LAN services"](#) on page 253
- ["Changing the default security password"](#) on page 253.

Accept

Applies the modified settings, provided the security password is entered and correct.

10.4.4 Password Management

Access:

1. Select "System Config > Setup > Security > Security > Password Management > User Password".

General	LAN Services	Password Management
Valid for VNC, FTP and SMB (Samba) access		User Password
User Name		instrument
Old Password		Security Password
New Password		
Confirm Password		
		 Change Password

In this tab, you can assign the security and a user-defined password.

2. Select "System Config > Setup > Security > Security > Password Management > Security Password".

General	LAN Services	Password Management
Old Password		User Password
New Password		Security Password
Confirm Password		
		 Change Password

How to:

- ["Changing the default user password of the instrument"](#) on page 252.

- ["Changing the default security password"](#) on page 253.

User Name

Indicates the user name used for access to the Linux operating system and valid for VNC, FTP and SMB (Samba) access.

User Password

Access: select "System Config > Setup > Security > Security > Password Management > User Password".

Allows you to change and confirm the user password.

Old Password ← User Password

Enters the current user password. The default password is "instrument".

Note: We recommend that you change the default password before connecting the instrument to a network.

How to:

- ["Changing the default user password of the instrument"](#) on page 252.
- ["Changing the default security password"](#) on page 253.

New Password ← User Password

Enters the new user password.

The security password can contain decimal characters only.

Confirm Password ← User Password

Confirms the new user password by repeating.

How to:

- ["Changing the default user password of the instrument"](#) on page 252.
- ["Changing the default security password"](#) on page 253.

Change Password ← User Password

Changes the user password accordingly.

Security Password

Access: select "System Config > Setup > Security > Security > Password Management > Security Password".

Enables you to change and confirm the security password.

Old Password ← Security Password

Enters the currently used security password. The default password is '123456'.

Note: We recommend that you change the default password before connecting the instrument to a network.

How to:

- ["Changing the default user password of the instrument"](#) on page 252.
- ["Changing the default security password"](#) on page 253.

The security password is required when changing the status of the USB and LAN interface.

New Password ← Security Password

Enters the new security password.

The security password can contain decimal characters only.

Confirm Password ← Security Password

Confirms the new security password by repeating.

How to:

- ["Changing the default user password of the instrument"](#) on page 252.
- ["Changing the default security password"](#) on page 253.

Change Password ← Security Password

Changes the password accordingly.

10.4.5 How to Prevent Unauthorized Access

The default computer name and user password are *instrument*. The user password is the password required for VNC, FTP and SMB (samba) connections. If, for example, the VNC service or FTP are enabled, anyone in the network who knows the computer name and user password of the instrument can access it.

The default security password is *123456*. The security password is required when changing the status of the USB and LAN interface.

To prevent unauthorized access, use the following configurations exclusively or complementary:

- ["Changing the default user password of the instrument"](#) on page 252
- ["Changing the default security password"](#) on page 253
- ["Disabling the LAN interface"](#) on page 253
- ["Disabling LAN services"](#) on page 253
- ["Disabling the frequency and level indication in the status bar"](#) on page 253
- ["Deactivating the user interface"](#) on page 253

If security is a concern, see the document instrument security procedures for comprehensive description.

Changing the default user password of the instrument

- **Note:** We recommend that you change the default password before connecting the instrument to a network.

How to:

- ["Changing the default user password of the instrument"](#) on page 252.
 - ["Changing the default security password"](#) on page 253.
- a) Select "System Config > Setup > Security > Security > Password Management > User Password".
 - b) Enter the current password in the "Old Password" field.
 - c) Enter the new password in the "New Password" and "Confirm Password" fields.

d) Select "Change Password".

The user password is changed; the user name is displayed ("Security > Password Management > User Password > User Name").

Changing the default security password

► **Note:** We recommend that you change the default password before connecting the instrument to a network.

How to:

- ["Changing the default user password of the instrument"](#) on page 252.
- ["Changing the default security password"](#) on page 253.

- a) Select "System Config > Setup > Security > Security > Password Management > Security Password".
- b) Enter the current password in the "Old Password" field.
The default password is *123456*
- c) Enter the new password in the "New Password" and "Confirm Password" fields.
- d) Select "Change Password".

Disabling the LAN interface

1. Select "System Config > Setup > Security > Security > LAN Services".
2. Select "LAN > Off".

All LAN connections and hence all LAN services are disabled.

Disabling LAN services

1. Select "System Config > Setup > Security > Security > LAN Services".
2. Select, for example, "FTP > Off" or "VNC > Off".
3. Enter the [Security Password](#).
4. Select "Accept".

Disabling the frequency and level indication in the status bar

These settings are useful to prevent unauthorized personnel from reading the display, when you remotely control the instrument from a different location.

1. Select "System Config > Setup > Security > General > Manual Operation".
2. Select "Annotation Frequency > Off" or "Annotation Amplitude > Off".
3. Enter the [Security Password](#).
4. Select "Accept".

Deactivating the user interface

1. Select "System Config > Setup > Security > General > Manual Operation".
2. Select "User Interface > Disabled".

3. Enter the [Security Password](#).
4. Select "Accept".

The screen shuts off and displays a padlock symbol  instead.

There are further possible configurations. For details, see "[User Interface](#)" on page 246.

Unlocking (reactivating) the user interface for manual operation

1. In manual operation:
 - a) On the instrument's keypad or external keyboard, press any key.
The instrument prompts you to enter the security password for unlocking.

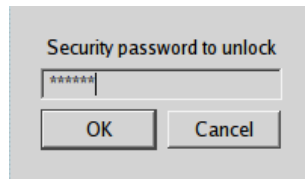

The character of the first key you pressed is immediately added in the input field.

- b) Delete the entry before inserting the password.
Enter the security password `123456`.
2. In remote control mode:
 - a) Send the command `SYST:ULOC ENABled` to release all locks at once.
 - b) Send the command `SYST:KLOC OFF` to unlock the keyboard and touchscreen.
 - c) Send the command `SYST:DLOC OFF` to release all locks.

Via remote control, there is no password required.

10.5 Undoing or Restoring Actions

"Undo" is a function that removes the effect of the last action on the instrument and reverts it to an older state. Conversely, "Redo" restores a previously undone action.

You can "Undo/Redo" actions according to two criteria:

- Step by step
Gradually undo/redo the actions in reverse order as previously performed. Depending on the available memory the "Undo/Redo" steps may restore all actions.
- Multiple steps at once
Select any specific action in the history list to "Undo/Redo" multiple actions in a single step.
Note: This mode requires a system restoration file on the instrument.

Access:

- ▶ Select "Setup > Settings > Undo/Redo".

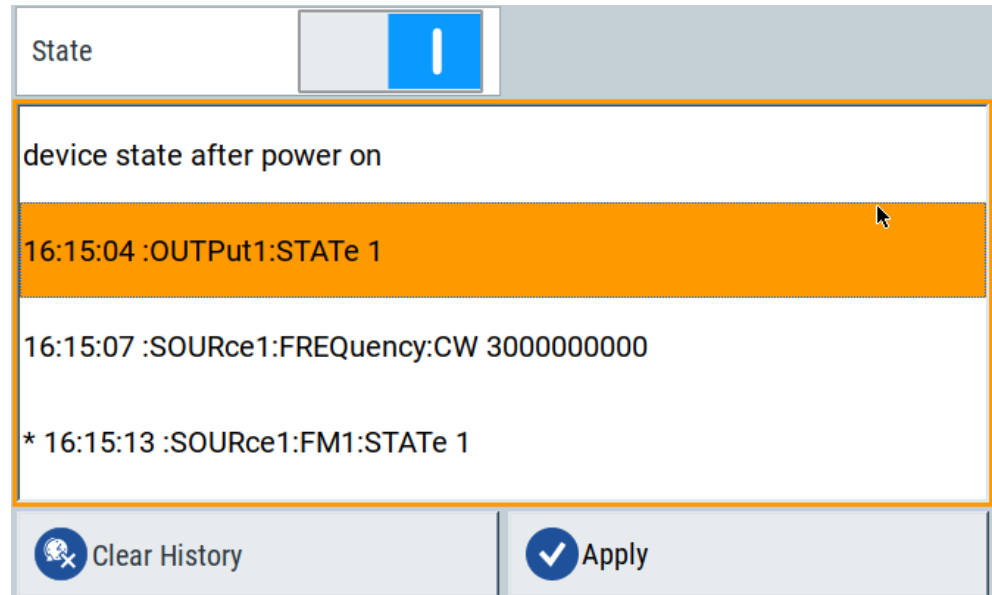

The dialog contains all functions for enabling the "Undo/Redo" functionality.

Settings:

State.....	255
History List.....	255
Clear History.....	255
Apply.....	255

State

Enables the recording of the performed actions.

History List

Lists the performed actions, provided "Undo/Redo" state is "On".

Clear History

Deletes the recorded list of the performed steps.

Apply

Performs the "Undo/Redo".

If you select a previously performed action of the list, all subsequent actions are undone. The list entries remain.

If you select a subsequently executed action, you can restore all the actions undone up to this state.

10.6 Shutting Down and Rebooting the Instrument

The [Power On/Standby] front panel key switches the instrument from the standby to the ready state or vice versa. In remote operation from a remote computer or in manual control, there is another possibility to shut down the instrument or to reboot the system.

Access:

- ▶ Select "System Config > Setup > Maintenance > Shut Down".

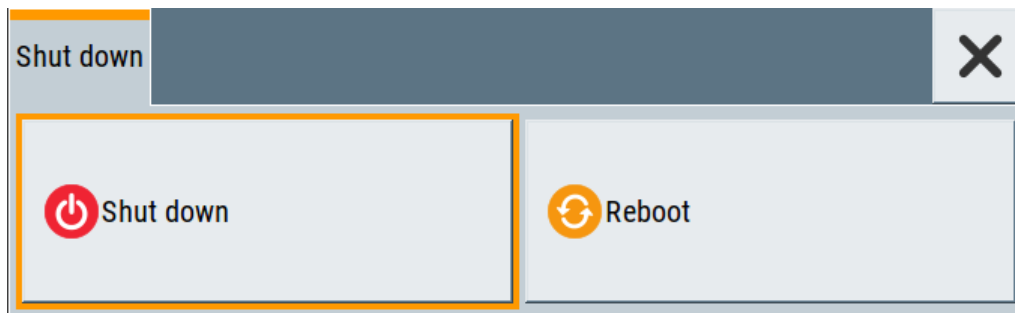

Remote command:

- `:SYSTem:REBoot` on page 499
- `:SYSTem:SHUTdown` on page 499

11 Network Operation and Remote Control



The description in this section requires basic knowledge of the remote control operation. Definitions specified in the SCPI standard are not provided.

You find some basic information to the SCPI syntax, command lists, and general programming recommendations in [Chapter A.1, "Additional Basics on Remote Control"](#), on page 555.

See also [Chapter A.1.5, "Status Reporting System"](#), on page 567.

As an alternative to the interactive operation directly at the instrument, you can operate the R&S SMB100B also from a remote location.

The [Figure 11-1](#) shows the possibilities of the physical connection (interfaces) for the remote access.

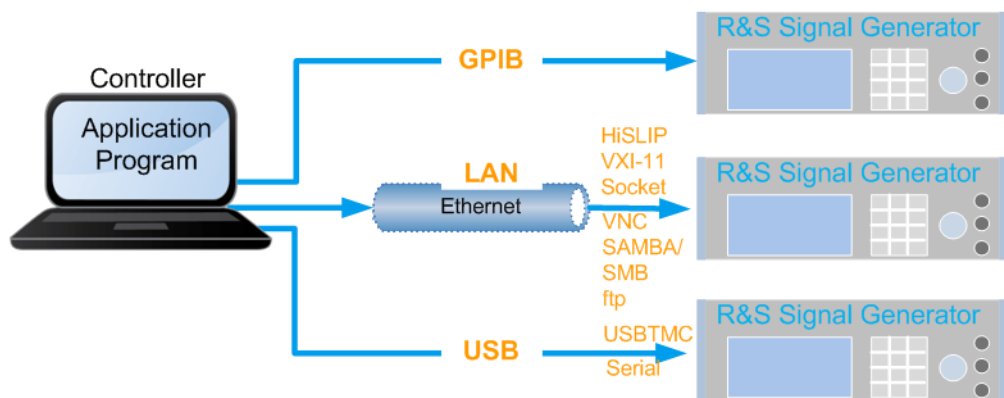

Figure 11-1: Supported remote connections

The various interfaces provide flexible access to the instrument, such as *remote control*, *remote operation* or *remote file access*. These **remote access modes** are fundamentally different, although they are often considered interchangeable.

See:

- [Overview of Remote Access Modes](#)
- [1GP72: Connectivity of Rohde&Schwarz Signal Generators](#)
- [Chapter 3.1.7, "Connecting to LAN"](#), on page 27

11.1 Overview of Remote Access Modes

This section outlines the possible access modes and their major characteristics.

Remote control (SCPI)

- A remote PC controls the instrument, usually via VISA (Virtual Instrument Software Architecture) interfaces.
- Remote control disables the manual operation of the instrument; you can set different lock states.
- The GUI is not visible.
- Remote control commands (SCPI) perform the settings, either individually or in sequences (SCPI programs).
- Using SCPI programs is faster than the manual operation, since they automate repeating applications.

Remote operation (VNC)

- A remote device accesses the instrument via the common platform technology VNC (Virtual Network Computing).
- The protocol allows simultaneous operation from several remote devices and the instrument nevertheless remains locally operable.
- The GUI is visible.
- To perform the settings, you can operate the instrument as with the manual control.
- During remote operation via VNC, the direct control of the instrument is not disabled.
You can control the instrument from the front panel and via the remote computer alternately.
- Clients supporting remote operation depend on the used remote device, see [Table 11-1](#).
- How to: see [Chapter 11.9, "Operating the R&S SMB100B Remotely via VNC"](#), on page 310.

Table 11-1: Supported VNC operation modes

Remote device	VNC client	Requirements	Characteristics
Desktop (Windows, Linux, Mac™OS)	<ul style="list-style-type: none"> • Ultr@VNC • Other dedicated client software 	<i>Ultr@VNC or Client Software</i> must be installed.	Fast, supports several options like full screen mode or auto-login.
	<ul style="list-style-type: none"> • Any web browser 	<i>Java Runtime</i> must be installed and activated in the browser settings.	Fast and convenient - only the instrument address required. Java runtime is sometimes considered as security concern.
	<ul style="list-style-type: none"> • Web browser with HTML5 	<i>Web sockets</i> must be supported.	Slower than the other modes. No additional installation or activation required. No security concern.
Smart device (Tablet/ smartphone)	<ul style="list-style-type: none"> • Dedicated client App 	<i>App</i> must be installed.	Fast, supports several options like full screen mode or auto-login.
	<ul style="list-style-type: none"> • Web browser with HTML5 	<i>Web sockets</i> must be supported.	Support of QR code scanning Slower than a dedicated App.

Remote file access (FTP, SAMBA/SMB)

- A remote client accesses the instrument's file system, using the protocols FTP (file transfer protocol) and SAMBA/SMB (server message block).
- The protocols enable you to transfer files from or to the instrument and to get direct access to its file sharing directory `share`.

How to: see [Chapter 9.9, "How to Transfer Files from and to the Instrument"](#), on page 212.

11.2 Remote Control Interfaces and Protocols

The instrument supports various interfaces for remote control. The table gives an overview on the connectivity:

Table 11-2: Remote control interfaces and protocols

Interface	Protocols, VISA ^{*)} address string and library	Remarks
Local area network (LAN)	<ul style="list-style-type: none"> • HiSLIP High-Speed LAN Instrument Protocol (IVI-6.1) TCP/IP::host address::hislip0[::INSTR] VISA • VXI-11 TCP/IP::host address[::LAN device name][::INSTR] VISA • Socket communication (Raw Ethernet, simple Telnet) TCP/IP::host address[::LAN device name]::<port>::SOCKET VISA or socket controller 	<p>The LAN connector is on the rear panel of the instrument.</p> <p>The interface is based on TCP/IP and supports various protocols.</p> <p>For a description of the protocols, refer to:</p> <ul style="list-style-type: none"> • Chapter 11.2.1.2, "HiSLIP Protocol", on page 262 • Chapter 11.2.1.3, "VXI-11 Protocol", on page 262 • Chapter 11.2.1.4, "Socket Communication", on page 262
USB	<ul style="list-style-type: none"> • USBTMC USB::<vendor ID>::<product ID>::<serial number>[::INSTR] VISA 	<p>The USB In connector is located at the rear panel of the instrument.</p> <p>For a description of the interface, refer to Chapter 11.2.2, "USB Interface", on page 263</p>
GPIB (IEC/IEEE Bus Interface)	<ul style="list-style-type: none"> • – GPIB::<address>[::INSTR] (no secondary address) VISA 	<p>Optional GPIB bus interfaces according to standard IEC 625.1/IEEE 488.1 are located on the rear panel of the instrument.</p> <p>For a description of the interface, refer to Chapter 11.2.3, "GPIB Interface (IEC/IEEE Bus Interface)", on page 263.</p>

^{*)} VISA (Virtual Instrument Software Architecture) is a standardized software interface library providing input and output functions to communicate with instruments. A VISA installation on the controller is a prerequisite for remote control over LAN (when using VXI-11 or HiSLIP protocol), USB and serial interface. For remote control via socket communication VISA installation is optional. For more information, see [Chapter 11.3.1, "VISA Library"](#), on page 265.



Rohde & Schwarz provides the standardized I/O software library R&S VISA for communication with the instruments via TCP/IP (LAN: HiSLIP, VXI-11 and raw socket) or USB (USBTMC) interfaces.

R&S VISA is available for download at the Rohde & Schwarz website <http://www.rohde-schwarz.com/rsvisa>.

How to configure the remote control interfaces is described in [Chapter 11.7, "Controlling the R&S SMB100B Remotely"](#), on page 288.

SCPI (Standard Commands for Programmable Instruments)

SCPI commands - messages - are used for remote control. Commands that are not taken from the SCPI standard follow the SCPI syntax rules. The instrument supports the SCPI version 1999. The SCPI standard is based on standard IEEE 488.2 and aims at the standardization of device-specific commands, error handling and the status registers. The tutorial "Automatic Measurement Control - A tutorial on SCPI and IEEE 488.2" from John M. Pieper (Rohde & Schwarz order number 0002.3536.00) offers detailed information on concepts and definitions of SCPI.

Tables provide a fast overview of the bit assignment in the status registers. The tables are supplemented by a comprehensive description of the status registers.

For more information, see also [Chapter A.1, "Additional Basics on Remote Control"](#), on page 555.

11.2.1 LAN Interface

To be integrated in a LAN, the instrument is equipped with a LAN interface, consisting of a connector, a network interface card and protocols.

For remote control via a network, the PC and the instrument must be connected via the LAN interface to a common network with TCP/IP network protocol. The TCP/IP network protocol and the associated network services are preconfigured on the instrument. Software for instrument control and (for specified protocols only) the VISA program library must be installed on the controller.

If several instruments are connected to the network, each instrument has its own IP address and associated resource string. The controller identifies these instruments by the resource string.

11.2.1.1 VISA Resource Strings

The VISA resource string is required to establish a communication session between the controller and the instrument in a LAN. The resource string is a unique identifier, composed of the specific IP address of the instrument and some network and VISA-specific keywords.

`TCPIP::host address[:LAN device name][:INSTR]`

TCPIP	= designates the network protocol
host address	= designates the IP address or hostname of the instrument
[::LAN device name]	= defines the protocol and the instance number of a subinstrument
::INSTR]	= indicates the instrument resource class (optional)

The **IP address** (host address/computer name) is used by the programs to identify and control the instrument. It is automatically assigned by the DHCP server the first time the device is registered on the network. Alternatively, you can also assign its **LAN device name**.

If assigned, the IP address is displayed on home screen. You can adjust it manually with the parameter the "System Config > Remote Access > Network" > [IP Address Enabling a locked user interface for manual operation](#).

The following section lists the characteristics of the VISA resource strings for the corresponding interface protocols. The highlighted characters are crucial.

HiSLIP

`TCPIP::host address::hislip0::INSTR]`

hislip0 = HiSLIP device name, designates that the interface protocol HiSLIP is used (mandatory)

hislip0 is composed of [`::HiSLIP device name[,HiSLIP port]`] and must be assigned.

For details of the HiSLIP protocol, refer to [Chapter 11.2.1.2, "HiSLIP Protocol"](#), on page 262.

VXI-11

`TCPIP::host address::inst0::INSTR]`

[::inst0] = LAN device name, indicates that the VXI-11 protocol is used (optional)

inst0 currently selects the VXI-11 protocol by default and can be omitted.

For details of the VXI-11 protocol, refer to [Chapter 11.2.1.2, "HiSLIP Protocol"](#), on page 262.

Socket communication

`TCPIP::host address::port::SOCKET`

port = determines the used port number
SOCKET = indicates the raw network socket resource class

Socket communication requires the specification of the port (commonly referred to as port number) and of "SOCKET" to complete the VISA resource string with the associated protocol used.

The registered port for socket communication is port 5025.

See also [Chapter 11.2.1.4, "Socket Communication"](#), on page 262.

11.2.1.2 HiSLIP Protocol

The HiSLIP (**H**igh **S**peed **L**AN **I**nstrument **P**rotocol) is the successor protocol for VXI-11 for TCP-based instruments specified by the IVI foundation. The protocol uses two TCP sockets for a single connection - one for fast data transfer, the other for non-sequential control commands (e.g. `Device Clear` or `SRQ`).

HiSLIP has the following characteristics:

- High performance as with raw socket network connections
- Compatible IEEE 488.2 support for Message Exchange Protocol, Device Clear, Serial Poll, Remote/Local, Trigger, and Service Request
- Uses a single IANA registered port (4880), which simplifies the configuration of firewalls
- Supports simultaneous access of multiple users by providing versatile locking mechanisms
- Usable for IPv6 or IPv4 networks



Using VXI-11, each operation is blocked until a VXI-11 device handshake returns. However, using HiSLIP, data is sent to the device using the "fire and forget" method with immediate return. Thus, a successful return of a VISA operation such as `viWrite()` does not guarantee that the instrument has finished or started the requested command, but is delivered to the TCP/IP buffers.

For more information see also the application note:

[1MA208: Fast Remote Instrument Control with HiSLIP](#)

11.2.1.3 VXI-11 Protocol

The VXI-11 standard is based on the ONC RPC (Open Network Computing Remote Procedure Call) protocol which in turn relies on TCP/IP as the network/transport layer. The TCP/IP network protocol and the associated network services are preconfigured. TCP/IP ensures connection-oriented communication, where the order of the exchanged messages is adhered to and interrupted links are identified. With this protocol, messages cannot be lost.

11.2.1.4 Socket Communication

An alternative way for remote control of the software is to establish a simple network communication using sockets. The socket communication, also referred to as "Raw Ethernet communication", does not necessarily require a VISA installation on the remote controller side. It is available by default on all operating systems.

The simplest way to establish socket communication is to use the built-in telnet program. The telnet program is part of every operating system and supports a communication with the software on a command-by-command basis. For more convenience and to enable automation by means of programs, user-defined sockets can be programmed.

Socket connections are established on a specially defined port. The socket address is a combination of the IP address or the host name of the instrument and the number of the port configured for remote-control. All R&S SMB100B use port number 5025 for this purpose. The port is configured for communication on a command-to-command basis and for remote control from a program.

11.2.2 USB Interface

For remote control via the USB connection, the PC and the instrument must be connected via the USB type B interface. A USB connection requires the VISA library to be installed. VISA detects and configures the R&S instrument automatically when the USB connection is established. You do not have to install a separate driver.

USBTMC (USB Test & Measurement Class Specification) is a protocol that is built on top of USB for communication with USB devices, like GPIB. It defines class code information of the instrument, that identifies its functionality to load the respective device driver. Using VISA library, it supports service request, triggers, and other specific operations, similar to GPIB.

11.2.2.1 USB Resource String

The resource string represents an addressing scheme that is used to establish a communication session with the instrument. It is based on the instrument address and some instrument- and vendor-specific information.

The USB resource string syntax is as follows:

```
USB::<vendor ID>::<product ID>::<serial number>[::INSTR]
```

USB	= denotes the used interface
<vendor ID>	= is the manufacturer ID for Rohde & Schwarz
<product ID>	= is the product identification of the instrument
<serial number>	= is the individual serial number on the rear of the instrument
[::INSTR]	= indicates the instrument resource class (optional)

To set the USB resource string, see [Remote Access Settings](#).

Example:

```
USB::0x0AAD::0x01DE::100001
```

0x0AAD is the vendor ID for Rohde & Schwarz.

0x01DE is the product ID for the R&S SMB100B

100001 is the serial number of the particular instrument.

11.2.3 GPIB Interface (IEC/IEEE Bus Interface)

To be able to control the instrument via the GPIB bus, the instrument and the controller must be linked by a GPIB bus cable. A GPIB bus card, the card drivers and the program libraries for the programming language used must be provided in the controller.

GPIB address

The controller must address the instrument with the GPIB bus channel (see [Chapter 11.4.3, "GPIB Address Settings"](#), on page 272). GPIB provides channel addresses from 0 to 30.

The GPIB resource string syntax is as follows:

`GPIB::<address>[:INSTR]`

`GPIB` = denotes the used interface
`<channel address>` = the used channel
`[:INSTR]` = indicates the instrument resource class (optional)

Note: If the VISA implementation supports the GPIB interface, you can optionally define the VISA Instrument Control Resource (INSTR). It is used to define the basic operations and attributes for a device, such as reading, writing, or triggering.

Notes and characteristics

In connection with the GPIB interface, note the following:

- Up to 15 instruments can be connected.
- The total cable length is restricted to a maximum of 15 m, or 2 m times the number of devices, whichever is less. The maximum recommended cable length between two instruments is 2 m.
- A wired "OR"-connection is used if several instruments are connected in parallel, since the slowest instrument determines the speed.
- Any connected IEC bus cable must be terminated by an instrument or controller.

11.2.4 LXI Browser Interface

The LXI browser interface allows easy configuration of the LAN and remote control of the R&S SMB100B without additional installation requirements. The instrument's LXI browser interface works correctly with all W3C compliant browsers.

See [Chapter 11.10.1, "LXI Functionality"](#), on page 316 for more about LXI.

The LAN settings are configured using the instrument's LXI browser interface described in [Chapter 11.5.2.1, "LAN Configuration"](#), on page 281. The LXI status settings in the R&S SMB100B are described in [Chapter 11.5.1, "LXI Status Settings"](#), on page 278.

11.3 Remote Control Programs and Libraries

This section shows how the remote-control programs access the instrument, and the libraries they require for the appropriate interface protocols.

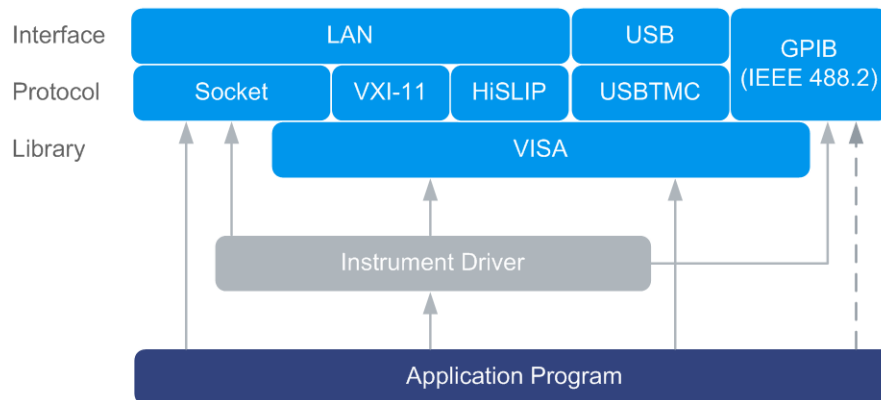

Figure 11-2: Overview of remote control interfaces, protocols and libraries

11.3.1 VISA Library

VISA is a standardized software interface library providing input and output functions to communicate with instruments. Thus, you can configure the interface without having to adjust the application program to the used interface. The I/O channel (LAN or TCP/IP, USB, GPIB,...) is selected at initialization time with the channel-specific address string ("VISA resource string"), or by an appropriately defined VISA alias (short name). See also [Table 11-2](#) for an overview.

Instrument access via VXI-11 or HiSLIP protocols is achieved from high level programming platforms using VISA as an intermediate abstraction layer. VISA encapsulates the low-level VXI or GPIB function calls and thus makes the transport interface transparent for the user.

A VISA installation is a prerequisite for remote control using the following interfaces:

- LAN interface using [HiSLIP Protocol](#)
- LAN interface using [VXI-11 Protocol](#)
- [USB Interface](#)

Instrument access via the LAN socket protocol or GPIB connections can be operated both, with or without the VISA library. See also [Chapter 11.2.1.4, "Socket Communication"](#), on page 262 and [Chapter 11.2.3, "GPIB Interface \(IEC/IEEE Bus Interface\)"](#), on page 263.

For more information about VISA library, refer to the user documentation.

11.3.2 Possible Setups and Access Functions

The following examples give an overview of dependencies between the available libraries, the possible interfaces and protocols, and whether an instrument driver is provided. The involved parts are **highlighted**. For more information, see the application note [1GP72: Connectivity of Rohde&Schwarz Signal Generators](#).

- Remote control (application) program using VISA

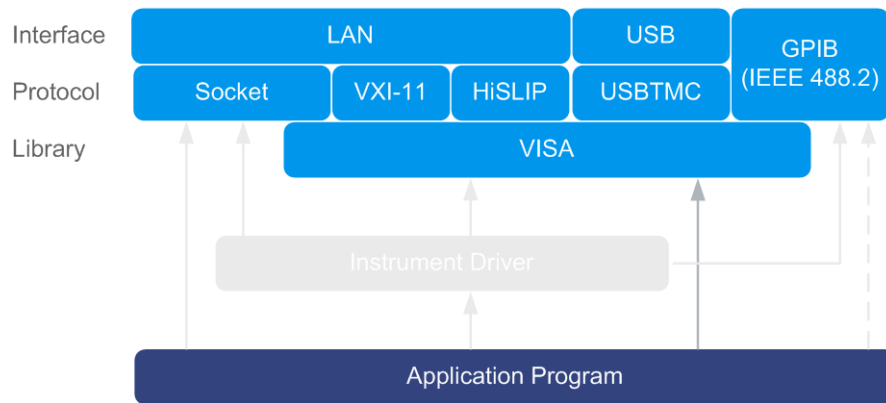

Figure 11-3: Application program using VISA

Protocol	Remote control program
Socket	<pre>viOpen (... , "TCPIP:SMB100B-102030::5025::SOCKET", ...) viPrintf (... , "SOUR:FREQ 2GHz\n")</pre>
VXI-11	<pre>viOpen (... , "TCPIP:SMB100B-102030::inst0::INSTR", ...) viPrintf (... , "SOUR:FREQ 2GHz\n")</pre>
HiSLIP	<pre>viOpen (... , "TCPIP:SMB100B-102030::hislip0::INSTR", ...) viPrintf (... , "SOUR:FREQ 2GHz\n")</pre>
USBTMC	<pre>viOpen (... , "USB::0x0AAD::0x01DE::100001::INSTR", ...) viPrintf (... , "SOUR:FREQ 2GHz\n")</pre>
GPIB	<pre>viOpen (... , "GPIB::28::INSTR", ...) viPrintf (... , "SOUR:FREQ 2GHz\n")</pre>

- Remote control program using instrument driver (VISA available)

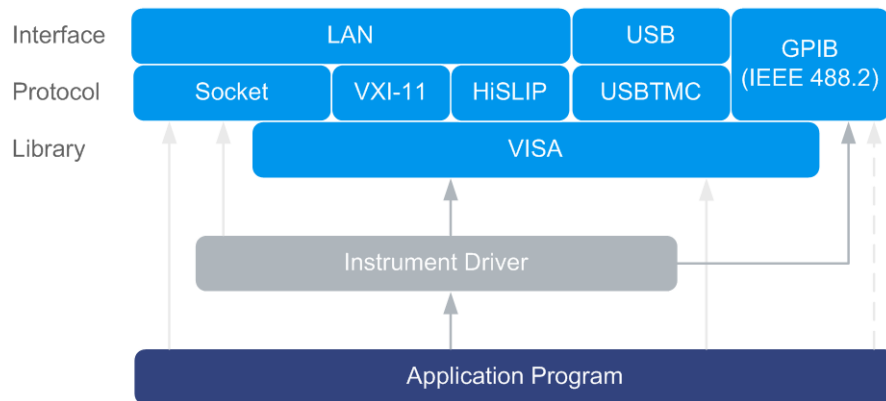

Figure 11-4: Application using instrument driver (VISA available)

Protocol	Remote control program
Socket	<code>rssmb_init ("TCPIP:SMB100B-102030::5025::SOCKET", ...)</code> <code>rssmb_SetFrequency (... , 2e9)</code>
VXI-11	<code>rssmb_init ("TCPIP:SMB100B-102030::inst0::INSTR", ...)</code> <code>rssmb_SetFrequency (... , 2e9)</code>
HiSLIP	<code>rssmb_init ("TCPIP:SMB100B-102030::hislip0::INSTR", ...)</code> <code>rssmb_SetFrequency (... , 2e9)</code>
USBTMC	<code>rssmb_init ("USB::0x0AAD::0x01DE::100001::INSTR", ...)</code> <code>rssmb_SetFrequency (... , 2e9)</code>
GPIO	<code>rssmb_init ("GPIO::28::INSTR", ...)</code> <code>rssmb_SetFrequency (... , 2e9)</code>

- Remote control program using instrument driver (VISA not available)

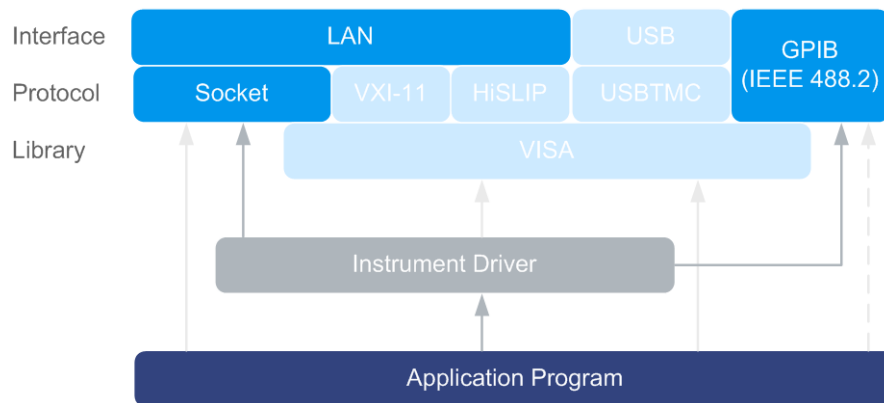

Figure 11-5: Remote control program using instrument driver (VISA not available)

Protocol	Remote control program
Socket	<code>rssmb_init ("TCPIP:SMB100B-102030::5025::SOCKET", ...)</code> <code>rssmb_SetFrequency (... , 2e9)</code>
GPIO	<code>rssmb_init ("GPIO::28::INSTR", ...)</code> <code>rssmb_SetFrequency (... , 2e9)</code>

11.4 Remote Access Settings

This section outlines the settings required for accessing and configuring the provided remote control interfaces. It includes network settings, access addresses, emulation settings for using the command sets of other generators, and the access via smart devices.

About instrument emulations

You can also remotely control the R&S SMB100B via the command set of another signal generator. With this function you can, for example, replace a signal generator with an R&S SMB100B in an automated test setup, without adjusting the command scripts used.



The R&S SMB100B also covers command sets of Rohde & Schwarz signal generators. To achieve optimal compatibility when replacing an instrument, we recommend that you select the emulation command set for the corresponding signal generator.

You find all the remote control command sets supported by the R&S SMB100B in a selection list.

The selected instrument also defines the identification string that is retrieved with query `*IDN?`. If necessary, use the parameter `Mode` and `IDN String` to change this string.

As any other parameter, the remote control command set can also be changed remotely by the command `:SYSTEM:LANGUage`.

While working in an emulation mode, the R&S SMB100B specific command set is disabled and the SCPI command `:SYSTEM:LANGUage` is discarded.

To return to the SCPI command set of the R&S SMB100B, use the appropriate command of the selected command set.

If for example an HP generator is emulated, the HP command `EX` returns to the instrument-specific GPIB command set.

11.4.1 Network Settings

Access:

- ▶ Select "System Config > Remote Access > Network".

Net-work	Visa Res. Strings	GPIB Addr.	RS232	Instrument Emulations	Remote Connections	QR-Code	✕
Network Status		● Connected		Restart Network			
Instrument Name							
Hostname		Workgroup					
instrument		INSTRUMENT					
Instrument Address							
Address Mode		Auto (DHCP)					
IP Address		Subnet Mask		Default Gateway			
10.124.0.211		255.255.252.0		10.124.0.1			
DNS Suffix		DNS Server		MAC Address			
rsint.net		10.0.2.166		08 00 27 b7 82 49			

In the "Network" dialog, you can configure the settings of the general network environment and specific identification parameters of the instrument in the network.

The remote commands required to configure the network remotely are described in [Chapter 12.15, "SYSTEM Subsystem"](#), on page 475.

How to: see [Chapter 11.6.3, "How To Connect to LAN"](#), on page 286.

Network Status

Indicates that the instrument is connected to the network.

Remote command:

`:SYSTEM:COMMunicate:NETWork:STATus?` on page 487

Restart Network

Terminates the network connection of the instrument and subsequently sets it up again. You can use this function to fix network problems.

Note: This function restarts only the connection of the instrument to the network. It does not impact the network itself.

Remote command:

`:SYSTEM:COMMunicate:NETWork:REStart` on page 487

Hostname

Displays the hostname.

Each instrument is delivered with an assigned hostname, a logical name which can be used instead of the IP address. With the default network settings, the IP address is allocated by the DHCP server. This address can change each time the instrument is reconnected. Unlike the IP address, the hostname name does not change.

Note:

This function is password-protected. Unlock the protection level 1 to access it.

- We recommend that you do not change the default network settings or the host-name to avoid problems with the network connection.
If you change the hostname, be sure to use a unique name.

Remote command:

`:SYSTem:COMMunicate:NETWork[:COMMON]:HOSTname` on page 487

Workgroup

Sets the individual windows workgroup name of the R&S SMB100B. This parameter is required in case the instrument is integrated in a windows network.

This function is password-protected. Unlock the protection level 1 to access it.

Remote command:

`:SYSTem:COMMunicate:NETWork[:COMMON]:WORKgroup` on page 488

Address Mode

Selects the mode for assigning the IP address.

How to: see [Chapter 11.6.4, "How to Assign the IP Address"](#), on page 286.

"Auto (DHCP)"

Assigns the IP address automatically, provided the network supports DHCP (Dynamic Host Configuration Protocol).

"Static"

Enables you to assign the IP address manually.

Remote command:

`:SYSTem:COMMunicate:NETWork:IPAddress:MODE` on page 486

IP Address

Displays the IP address of the instrument in the network.

By default, the R&S SMB100B is configured to use dynamic TCP/IP configuration and to obtain the whole address information automatically.

If the network does not support DHCP or the attempt does not succeed, the instrument tries to obtain the IP address via Zeroconf (APIPA) protocol. IP addresses assigned via Zeroconf start with the number blocks 169.254.*.*.

Note: An IP address that is assigned via the Zeroconf protocol although the network requires an IP address assigned via the DHCP server can cause network connection failures.

See [Chapter 13.5, "Resolving Network Connection Failures"](#), on page 534.

How to:

- ["To assign the IP address manually on the instrument"](#) on page 287.
- [Chapter 11.6.2, "How To Activate LAN Services"](#), on page 286.

Remote command:

`:SYSTem:COMMunicate:NETWork:IPAddress` on page 485

Subnet Mask

Displays the bit group of the subnet in the host identifier.

To assign the subnet mask manually, select [Address Mode](#) > "Static".

Remote command:

`:SYSTem:COMMunicate:NETWork[:IPAddress]:SUBNet:MASK` on page 488

Default Gateway

Displays the gateway address.

This address identifies the router on the same network as the instrument that is used to forward traffic to destinations beyond the local network.

To assign the gateway address manually, select **Address Mode** > "Static".

Remote command:

`:SYSTem:COMMunicate:NETWork[:IPAddress]:GATeway` on page 488

DNS Suffix

Displays the primary DNS (Domain Name System) suffix, that means the DNS name without the hostname part.

The DNS system uses the suffix for registration and name resolution for unique identification of the instrument in the entire network.

To assign the DNS suffix manually, select **Address Mode** > "Static".

Remote command:

`:SYSTem:COMMunicate:NETWork[:COMMON]:DOMain` on page 487

DNS Server

Determines the preferred server for name resolution. The DNS server contains the underlying numerical values that are required for name resolution of the hostname as part of the IP address.

To select the DNS server manually, select **Address Mode** > "Static".

Remote command:

`:SYSTem:COMMunicate:NETWork[:IPAddress]:DNS` on page 488

MAC Address

Indicates the MAC (Media Access Control) address, a unique identifier of the network adapter in the R&S SMB100B.

Remote command:

`:SYSTem:COMMunicate:NETWork:MACaddress` on page 486

11.4.2 VISA Resource Strings

Access:

- ▶ Select "System Config > Remote Access > VISA Resource Strings".

Network	Visa Res. Strings	GPIB Addr.	RS232	Instrument Emulations	Remote Connections	QR-Code	✕
HISLIP	TCPIP::10.124.1.233::hislip0::INSTR						
VXI11	TCPIP::10.124.1.233::inst0::INSTR						
Socket	TCPIP::10.124.1.233::5025::SOCKET						
GPIB	GPIB::28::INSTR						
USB	USB::0x0AAD::0x01dd::000000::INSTR						
SERIAL	ASRL1::INSTR						

The "Visa Resource String" dialog displays the Visa resource strings provided for remote control via the different interfaces.

Remote command:

`:SYSTEM:COMMunicate:HISLip:RESource?` on page 485

`:SYSTEM:COMMunicate:NETWork:RESource?` on page 486

`:SYSTEM:COMMunicate:SOCKet:RESource?` on page 489

`:SYSTEM:COMMunicate:GPIB:RESource?` on page 485

`:SYSTEM:COMMunicate:USB:RESource?` on page 490

`:SYSTEM:COMMunicate:SERial:RESource?` on page 489

11.4.3 GPIB Address Settings

Access:

1. Select "System Config > Remote Access > GPIB Address".

Network	Visa Res. Strings	GPIB Addr.	RS232	Instrument Emulations	Remote Connections	QR-Code	✕
GPIB Channel Address		28					

- Set the GPIB channel address of the connected instrument.

Remote command:

:SYSTem:COMMunicate:GPIB[:SELF]:ADDRes on page 485

11.4.4 RS232 Settings

Access:

- ▶ Select "System Config > Remote Access > RS232".

Network	Visa Res. Strings	GPIB Addr.	RS232	Instrument Emulations	Remote Connections	QR-Code	✕
Needs USB Adapter (R&S TS1-USB)							
Baud Rate		Parity		Stop Bits			
115200		None		1			

The "RS232" dialog enables you to control the instrument over a serial interface using a USB adapter. The controller and the instrument must be connected with the external USB/serial-adapter R&S TS1-USB (see recommended extras in the data sheet) and a serial crossover (null modem) cable. The USB connection requires the Visa library to be installed on the controller. Visa detects and configures the R&S SMB100B automatically when the USB connection is established.

The remote commands required to configure the emulation settings remotely are described in [Chapter 12.15, "SYSTem Subsystem"](#), on page 475.

Baud Rate

Sets the baudrate for the serial remote control interface.

Remote command:

:SYSTem:COMMunicate:SERial:BAUD on page 488

Parity

Sets the parity for the serial remote control interface.

Remote command:

:SYSTem:COMMunicate:SERial:PARity on page 489

Stop Bits

Sets the number of stop bits for the serial remote control interface.

Remote command:

:SYSTem:COMMunicate:SERial:SBITs on page 489

11.4.5 Instrument Emulations Settings

Access:

- ▶ Select "System Config > Remote Access > Instrument Emulations".

The "Instrument Emulations" dialog enables you to emulate a remote control command set of another signal generator.

The remote commands required to configure the emulation settings remotely are described in [Chapter 12.15, "SYSTEM Subsystem"](#), on page 475.

Language

Selects the instrument whose remote command set is emulated by the R&S SMB100B.

Remote command:

[:SYSTEM:LANGUage](#) on page 492

Mode

Selects the way the instrument identification is performed.

"Automatic" Sets the "IDN String" and the "OPT String" automatically for the instrument selected with the parameter [Language](#).

"User Defined" Enables you to define the "IDN String" and the "OPT String".

Remote command:

[:SYSTEM:IDENTification](#) on page 490

Set to Default

In "Mode > User Defined", resets the *IDN and *OPT strings.

Remote command:

`:SYSTem:IDENtification:PRESet` on page 491

IDN String

Indicates the identification string of the instrument when queried with the common command `*IDN?`.

In addition to the preset values, you can define your own identification string so that each generator uses an individual identification, like `My_SigGen` for instance, see [Mode](#) .

Remote command:

`*IDN?` on page 322

`:SYSTem:IRESpOnse` on page 491

OPT String

Indicates the option string of the instrument as queried with common command `*OPT?`.

In [Mode](#) > "User Defined", you can define your own option string, additionally to the automatically created one.

Remote command:

`*OPT?` on page 323

`:SYSTem:ORESpOnse` on page 491

11.4.6 Remote Connections Settings

The "Remote Connections" dialog covers the active SCPI and TCP/IP connections, and a history list of the connections that have accessed the instrument before.

11.4.6.1 Active Connections

Access:

- ▶ Select "System Config > Remote Access > Remote Connections > Active".

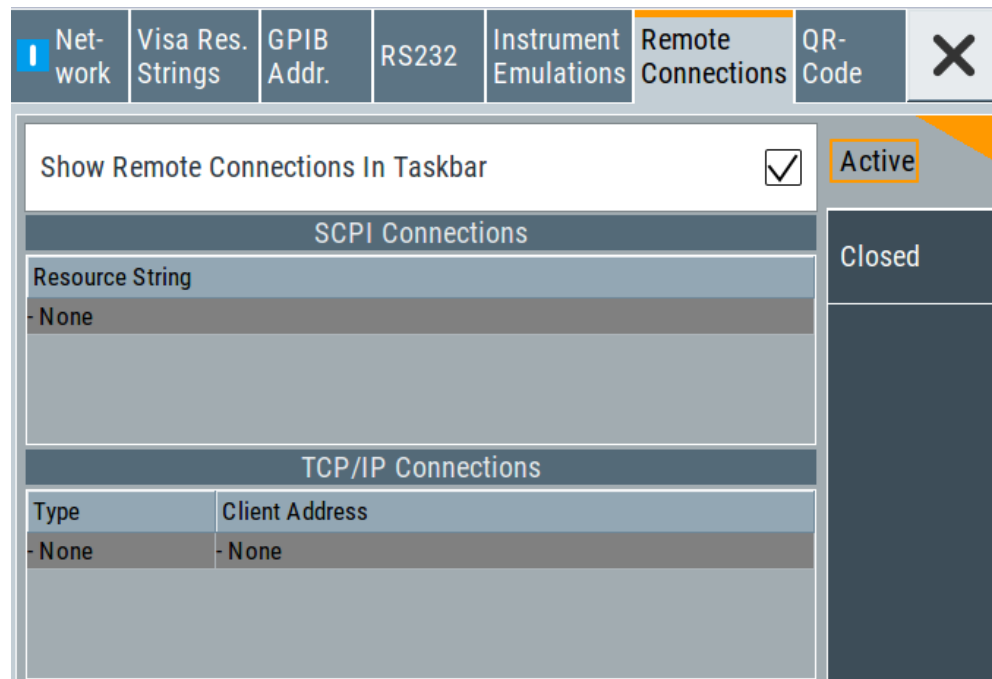

The "Active " tab shows the currently active remote connections, and you can enable the display of the active connections in the task bar.

Show Remote Connections in Taskbar

Displays the currently active connections in the taskbar.

SCPI Connections

Displays the VISA resources strings of the remote connections currently controlling the instrument via the LAN interface.

Remote command:

n.a.

TCP/IP Connections

Displays the types and client addresses of the remote connections currently controlling the instrument via the LAN interface.

Remote command:

n.a.

11.4.6.2 Closed Connections

Access:

- ▶ Select "System Config > Remote Access > Remote Connections > Closed".

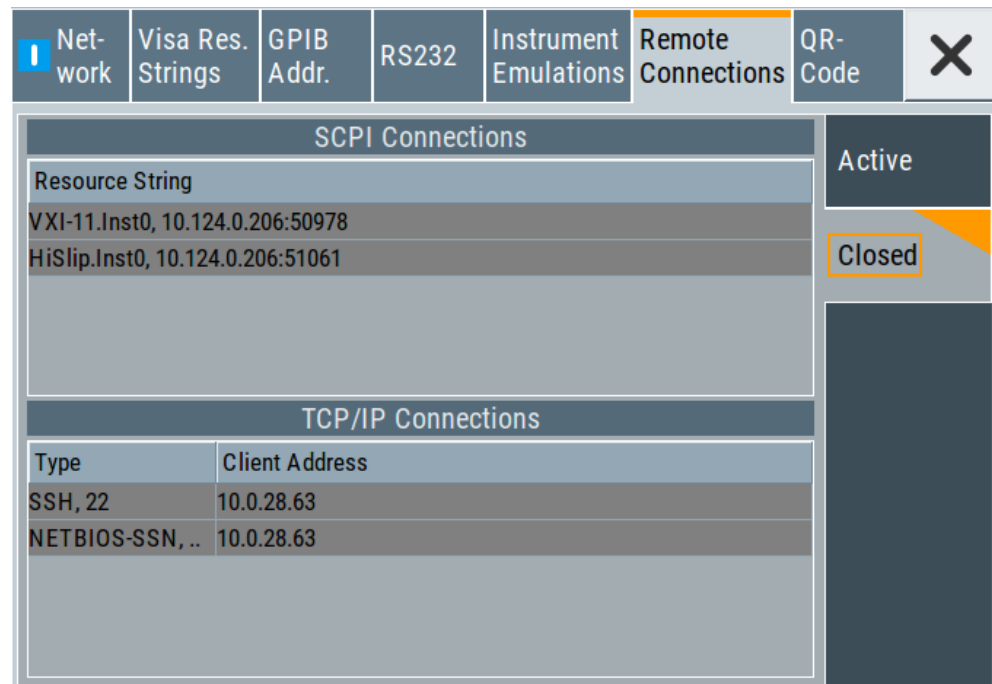

The "Closed" tab shows the currently active remote connections, and you can enable the display of the active connections in the task bar.

SCPI Connections

Lists the VISA resource strings of the last remote connections that have accessed the instrument via the LAN interface before.

Remote command:
n.a.

TCP/IP Connections

Lists the types and client addresses of the last remote connections that had accessed the instrument via the LAN interface before.

Remote command:
n.a.

11.4.7 QR Code

Access:

- ▶ Select "System Config > Remote Access > QR Code".



The "QR Code" dialog shows the current instrument address (IP address) in quick response (QR) format.

This functionality provides fast access to the instrument via VNC with, for example, a smartphone or a tablet.

See [Chapter 11.9.3, "How To Set Up a Remote Operation from a Smart Device"](#), on page 313.

11.5 LXI Settings

On the R&S SMB100B the LXI functionality is already installed and enabled, see [LXI Status Settings](#). Thus, the instrument can be accessed via any web browser (like the Microsoft Internet Explorer) to perform the following tasks:

- Modifying network configurations
- Remote control the instrument
- Performing SCPI remote diagnostics

The LAN settings are configured using the instrument's LXI browser interface described in [Chapter 11.5.2.1, "LAN Configuration"](#), on page 281.

11.5.1 LXI Status Settings

Access:

- ▶ Select "System Config > Setup > Remote Access > LXI Status...".

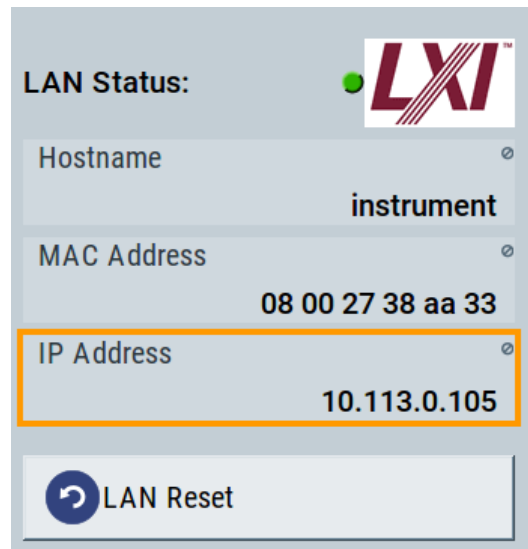

The "LXI - Status" dialog shows the parameters of the LAN connection.

Alternatively, you can change the LAN settings using the LXI web browser interface, see [Chapter 11.5.2.1, "LAN Configuration"](#), on page 281.

LAN Status

The LED indicates the LXI status.

"green"	Normal operation
"green (flashing)"	Device identification
"red"	LAN fault

Hostname / MAC Address / IP Address

See "[Hostname](#)" on page 269.

LAN Reset

Initiates the network configuration reset mechanism for the instrument and resets the hostname, MAC address, and IP address.

According to the LXI standard, a LAN reset must place the following network settings to a default state:

Parameter	Value
TCP/IP mode	DHCP + Auto IP address
Dynamic DNS	Enabled
ICMP ping	Enabled
Password for LAN configuration	LxiWebIfc

The LAN reset also resets the following parameters for the RF signal generator:

Parameter	
Hostname	Instrument-specific hostname
Description	Vector signal generator
Negotiation	Auto detect
VXI-11 discovery	Enabled

11.5.2 LXI Browser Settings

To access the instrument via the web browser:

- ▶ In the address field of the browser on your PC, type the instrument's host name or IP address, for example *http://10.113.1.151*.

Note: Do not add the missing zeros in the IP address, while opening the instrument homepage.

The instrument homepage (welcome page) opens.

The navigation pane of the browser interface contains the following elements:

- "LXI"
 - "Home" opens the instrument homepage.
The homepage displays the device information required by the LXI standard, including the VISA resource string in read-only format.
 - "Device Indicator" activates or deactivates the LXI status indication.
When activated, the LXI LEDs flash, both in the browser dialog and in the LXI dialog of the connected instrument, see [LAN Status](#). A green LXI status symbol indicates that a LAN connection has been established; a red symbol indicates that no LAN cable is connected.
 - "Lan Configuration" allows you to configure LAN parameters and to initiate a ping, see ["Ping Client"](#) on page 283.
 - "Status" displays information about the LXI status of the instrument.
 - "Utilities" provides access to the LXI event log functionality required by the LXI standard.
- "Instrument Control"
 - "Web Control" provides remote access to the instrument, see ["Starting a remote control via the LXI web browser"](#) on page 290.
- "Diagnostics"
 - "SCPI Remote Trace" records messages exchanged via the remote control interface, see ["SCPI Remote Trace"](#) on page 283.
- "Help"
 - "Glossary" explains terms related to the LXI standard.
 - www.rohde-schwarz.com opens the Rohde & Schwarz homepage.
- "Data Sheet"
 - Provides the data sheet with the specification data of the instrument at the time of delivery, see ["Data Sheet"](#) on page 285.

11.5.2.1 LAN Configuration

The "LAN Configuration" web page displays all mandatory LAN parameters and allows their modification.

It comprises the following navigation entries.

- [IP Configuration](#)..... 281
- [Advanced Config](#).....282
- [Ping Client](#).....283
- [SCPI Remote Trace](#)..... 283
- [Data Sheet](#)..... 285

IP Configuration

The "IP configuration" web page displays all mandatory LAN parameters and allows their modification.

The screenshot displays the LXI LAN Parameters configuration interface. The left sidebar contains navigation options: Home, Lan Configuration (with sub-options IP Configuration, Advanced Config, Ping Client), Status, Utilities, Instrument Control (with sub-option Web Control), Diagnostics (with sub-option SCPI Remote Trace), Help (with sub-options Glossary and www.rohde-schwarz.com), and Datasheet (with sub-option Production Version). The main content area is titled 'LAN Parameters' and includes the following fields:

- Hostname: instrument
- DNS Hostname(s): instrument.rsint.net
- Domain: rsint.net
- Description: Instrument (FW version) Serial number
- IP Address Mode: DHCP + Auto IP Address (dropdown menu)
- IP Address: 10.113.1.151
- Subnet Mask: 255.255.252.0
- Default Gateway: 10.113.0.1
- Obtain DNS Server Address automatically:
- DNS Server(s): 10.0.2.166
- Register Device at DNS Server dynamically:

Additional elements include a 'Submit' button, a password field with '(Password required!)', and a status bar at the bottom showing 'No error'. A copyright notice '© 2016 ROHDE&SCHWARZ. All rights reserved.' is located at the bottom right.

The "IP Address Mode" selects a configuration mode for the IP address of the instrument. With static configuration, the entered IP address, subnet mask, and default gateway are used. With dynamic configuration, DHCP or dynamic link local addressing (automatic IP) is used to obtain the instrument IP address.



Changing the LAN configuration

This function is password-protected. Unlock the protection level 1 to access it.

Note: We recommend that you change the default password before connecting the instrument to a network.

How to:

- ["Changing the default user password of the instrument"](#) on page 252.
- ["Changing the default security password"](#) on page 253.

See [Chapter 10.4.4, "Password Management"](#), on page 250.

Advanced Config

The "Advanced Config" web page provides LAN settings that are not declared mandatory by the LXI standard.

The screenshot shows the LXI web interface for the "Advanced Config" page. The page title is "LAN Parameters". The left sidebar contains navigation links: Home, Lan Configuration (with sub-links for IP Configuration, Advanced Config, Ping Client, Status, and Utilities), Instrument Control (with sub-links for Web Control), Diagnostics (with sub-link for SCPI Remote Trace), Help (with sub-links for Glossary and www.rohde-schwarz.com), and Datasheet (with sub-link for Production Version). The main content area displays three settings: "mDNS and DNS-SD" with a dropdown menu, "ICMP Ping enabled" with a checkbox, and "VXI-11 Discovery" with a checkbox. A "Submit" button and a password input field (labeled "(Password required)") are also visible. At the bottom, a "Status" section shows "No error" and a copyright notice "© 2016 ROHDE&SCHWARZ. All rights reserved."

The following advanced parameters are available:

- "mDNS and DNS-SD": The additional protocols "multicast DNS" and "DNS service discovery" are used for device communication in zero configuration networks, working without DNS and DHCP.
- "ICMP Ping": Must be enabled to use the ping utility. If you disable this setting, the instrument does not answer ping requests. The setting does not affect the LXI ping client. You can ping other hosts from the instrument, even if the setting is disabled.
- "VXI-11 Discovery": Must be enabled to detect the instrument in the LAN. If you disable this setting, the instrument cannot be detected by the VXI-11 discovery protocol mechanism. The setting does not affect other detection mechanisms. Setting up a VXI-11 connection via the IP address or the host name is independent of this setting.



Changing the LAN configuration

This function is password-protected. Unlock the protection level 1 to access it.

Note: We recommend that you change the default password before connecting the instrument to a network.

How to:

- ["Changing the default user password of the instrument"](#) on page 252.
- ["Changing the default security password"](#) on page 253.

See [Chapter 10.4.4, "Password Management"](#), on page 250.

Ping Client

The "Ping Client" page provides the ping utility to verify the connection between the LXI-compliant instrument and another device.

The ping is initiated from the instrument. Using the ICMP echo request and echo reply packets, this function checks whether the communication with a device via LAN is working. Ping is useful for the diagnosis of IP network or router failures.

To initiate a ping at the instrument:

1. On the "Ping Client" page, enter the IP address of the host in the "Destination Address" field (for example 10.113.1.151).
2. Select "Submit".

SCPI Remote Trace

The remote trace functionality allows you to trace input and output strings at the remote control interface of the R&S SMB100B, see [Chapter 11.7.8, "How to Trace Messages with the LXI Web Browser Interface"](#), on page 299.

A recorded trace (message log) can be evaluated directly in the dialog. Use the highlighting and navigation functions provided by the lower toolbar to locate error messages and messages containing arbitrary search strings. You can also export the message log to a *.CSV file and evaluate the file using a suitable program.

To trace and display messages, switch on "logging" and "live mode" in the toolbar.

Toolbars

The toolbar at the top of the dialog provides basic settings and functions.

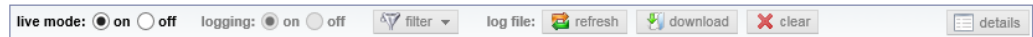

- "Live mode" / "logging": If logging is switched on, messages are traced. They are stored in an internal database and can be displayed upon request, using the refresh button (live mode off) or they can be displayed automatically (live mode on).
- "Filter": applies a filter to columns and/or rows when working (live mode off)
- "Refresh": reads the message log from the internal database and displays it
- "Download": stores the SCPI trace log to a *.CSV file
- "Clear": deletes all message log entries in the database and at the screen
- "Details": displays details of the selected message, for example an SCPI command in hex format (also possible by double-clicking a message)

Columns

The following columns are available if no column filter is applied:

- "Rec": record number of the message within the message log
- I: number of the subinstrument
- "MT": indicates the type of the message. Possible values and related message contents are:
 - > = incoming command
 - < = outgoing response to a query
 - E = error message, highlighted by red color
 - T = execution time, i.e. time required by the instrument to process the command internally.
- "message": indicates the type of the message. Possible values and related message contents are:
 - > = incoming command
 - < = outgoing response to a query
 - E = error message, denoted in red
 - T = execution time, i.e. time required by the instrument to process the command internally

Data Sheet

The data sheet functionality allows you to retrieve the specification data of the instrument at the time of delivery.

The document contains all specified value ranges and information of the data sheet, for example important as reference values for recalibration.

Instrument Name Specifications Data sheet version

This document contains all specified limits of the data sheet. These values can be used as reference values for recalibration.
 Examples for usage (SCPI) :system:spec? "ID_RF_FREQ_SETTING_TIME_BX03_BX06_MS" or :syst:spec:par?
 "ID_RF_LEVEL_MAX_GENERAL_FORMULA_GHZ_DBM",1.0
 For details please see user manual.

Contents

ID	Type	Value	ValueTypical	Formula
ID_RF_FREQ_SETTING_TIME_BX03_BX06_MS	ms			
ID_RF_FREQ_SETTING_TIME_BX12_BX20_MS	ms			
ID_RF_FREQ_SETTING_TIME_B131_B140_MS	ms			

Status
No error

© 2018 ROHDE&SCHWARZ. All rights reserved.

11.6 Connecting the Instrument to the Network (LAN)

The R&S SMB100B is equipped with a network interface and can be connected to an Ethernet LAN (local area network).

There are two methods to establish a LAN connection to the instrument:

- A non-dedicated network (Ethernet) connection from the instrument to an existing network
- A dedicated network connection (Point-to-point connection) between the instrument and a single computer

For addressing, both the instrument and the computer require an IP address. The address information is usually assigned to the devices automatically, see [Chapter 11.6.4, "How to Assign the IP Address"](#), on page 286.

- [How To Enable Access via LAN](#).....286
- [How To Activate LAN Services](#).....286
- [How To Connect to LAN](#).....286
- [How to Assign the IP Address](#).....286
- [How to Use Computer Names \(Hostnames\)](#).....287

11.6.1 How To Enable Access via LAN

Per default, the LAN interfaces on the instrument are enabled.

If they have been disabled because of security reasons, enable them as follows:

1. Select "Setup > Security > LAN Services > LAN Interface = On".
2. Enter the [Security Password](#).
3. Select "Accept".

11.6.2 How To Activate LAN Services

Per default, the LAN interfaces and all LAN services are enabled.

If they have been disabled because of security reasons, enable them as follows:

1. Select "Setup > Security > LAN Services".
2. Enable the required service, e.g. "LAN Services > FTP > On".
3. Enter the [Security Password](#).
4. Select "Accept".

See [Chapter 10.4.5, "How to Prevent Unauthorized Access"](#), on page 252.

11.6.3 How To Connect to LAN

1. **NOTICE!** Connecting to the network can cause network failure. Errors can affect the entire network.

Consult your network administrator before performing the following tasks:

- Connecting the instrument to the network
- Configuring the network
- Changing IP addresses

2. Connect the LAN socket on the rear panel via an RJ-45 cable to the LAN.

The R&S SMB100B displays its IP address on the screen.

11.6.4 How to Assign the IP Address

Depending on the network capacities, the TCP/IP address information for the instrument can be obtained in different ways.

- If the network supports DHCP (dynamic host configuration protocol), the address information is assigned automatically.

- If the network does not support DHCP, the instrument tries to obtain the IP address via Zeroconf (APIPA) protocol. If this attempt does not succeed or if the instrument is set to use alternate TCP/IP configuration, the addresses must be set manually.

Since the dynamic TCP/IP configuration assigns the address information automatically, it is safe to establish a physical connection to the LAN without any previous instrument configuration.

To assign the IP address manually on the instrument

1. **NOTICE!** Connecting to the network can cause network failure. Errors can affect the entire network.

Consult your network administrator before performing the following tasks:

- Connecting the instrument to the network
- Configuring the network
- Changing IP addresses

2. Select "System Config > Remote Access > Network".

3. Select "Address Mode > Static".

4. Select the "IP Address".

5. Enter the IP address, for example *192.168.0.1*.

The IP address consists of four number blocks separated by dots. Every block contains 3 numbers in maximum.

6. Select the "Subnet Mask" and enter the subnet mask, for example *255.255.255.0*.

The subnet mask consists of four number blocks separated by dots. Every block contains 3 numbers in maximum.

To assign the IP address manually on the computer

- ▶ Obtain the necessary information from your network administrator. If you use more than one LAN connector, you need separate address information for each connector.

For information on how to perform the configurations, refer to the documentation of the operating system the computer uses.

11.6.5 How to Use Computer Names (Hostnames)

In a LAN that uses a DNS server, each PC or instrument connected in the LAN can be accessed via an unambiguous computer name (*hostname*) instead of the IP address. The DNS server translates the hostname to the IP address. It is especially useful when a DHCP server is used, as a new IP address can be assigned each time the instrument is restarted.

Each instrument is delivered with an assigned computer name, that remains permanent as long as it is not explicitly changed.

The default computer name follows the syntax <INST>-<Serial Number>, where:

- <INST> is the short name of your instrument, as stated on the front panel.
- <Serial Number> is the individual serial number of the instrument.
You can find the serial number at the rear panel of instrument. It is the third part of the device ID printed on the barcode sticker .



Example:

The default hostname of an R&S SMB100B with a serial number 102030 is SMB100B-102030.

To query and change a computer name

1. Select "System Config > Remote Access > Network".
The computer name is displayed under "Hostname".
2. Select "System Config > Setup > Security > Protection".
3. Enable the "Protection Level 1".
The default password is 123456.
The parameter "Hostname" in the "Network" tab is now enabled for configuration.
4. Change the "Hostname".

11.7 Controlling the R&S SMB100B Remotely

This section shows you how to set up remote control connections over the available interfaces.

The following general prerequisites must be fulfilled:

- The instrument and the controller have to be connected with the suitable cable and switched on.
See [Chapter 11.6, "Connecting the Instrument to the Network \(LAN\)"](#), on page 285.
- To operate the instrument via remote control, it must be addressed using the defined interface address.

See:

- [Chapter 11.2.1, "LAN Interface"](#), on page 260
- [Chapter 11.2.2, "USB Interface"](#), on page 263
- [Chapter 11.2.3, "GPIB Interface \(IEC/IEEE Bus Interface\)"](#), on page 263
- [Chapter 11.7.1, "How to Find the VISA Resource String"](#), on page 289

- A remote control program must open a connection to the instrument, before it can send commands to and receive device responses from the instrument.

If security is a concern, see:

- Document instrument security procedures.
- [Chapter 10.4.5, "How to Prevent Unauthorized Access"](#), on page 252.
- [How to Find the VISA Resource String](#).....289
- [How to Change the GPIB Instrument Address](#).....289
- [Establishing a Remote Control Connection over the LXI Browser Interface](#).....290
- [Establishing a Remote Control Connection over LAN Using VXI-11 Protocol](#).....290
- [Establishing a Remote Control Connection over LAN Using Socket Communication](#).....296
- [Setting Up a Remote Control Connection over GPIB](#).....297
- [Setting Up a Remote Control Connection over USB](#).....298
- [How to Trace Messages with the LXI Web Browser Interface](#).....299
- [How to Return to Manual Operation](#).....299

11.7.1 How to Find the VISA Resource String

- ▶ Select "System Config > Remote Access > VISA Resource Strings".

Network	Visa Resource Strings	GPIB Address	RS232	Instrument Emulations	Remote Connections	QR-Code
HISLIP						TCPIP::10.124.1.212::hislip0::INSTR
VXI11						TCPIP::10.124.1.212::inst0::INSTR
Socket						TCPIP::10.124.1.212::5025::SOCKET
GPIB						GPIB::28::INSTR
USB						USB::0x0AAD::0x01df::000000::INSTR
SERIAL						ASRL1::INSTR

The dialog shows all specified resource strings of the supported remote control interfaces.

Note: Using the RS232 serial interface via USB requires the USB serial adapter R&S TS-USB1.

11.7.2 How to Change the GPIB Instrument Address

To control the instrument remotely via the GPIB bus, it must be addressed using the GPIB address. The remote control address is factory-set to 28, but it can be changed if it does not fit in the network environment. For remote control, addresses 0 through 30 are allowed. The GPIB address is maintained after a reset of the instrument settings.

To set the GPIB address:

1. Select "System Config > Remote Access > GPIB Address".
2. Select "GPIB Channel Address" and enter a value between 0 and 30.



Risk of losing remote connection

If the remote access and network settings had been configured to values different to the default, executing a factory preset via remote control terminates the connection to the instrument.

11.7.3 Establishing a Remote Control Connection over the LXI Browser Interface

Via the LXI browser interface to the R&S SMB100B one or more users can control the instrument remotely from another PC without additional installation. Most instrument controls are available via the front panel simulation. File upload and download between the instrument and the remote PC is also available.

Starting a remote control via the LXI web browser

1. On the instrument, enable the LAN interface.
See [Chapter 11.6.1, "How To Enable Access via LAN"](#), on page 286.
2. Connect the remote PC and the instrument in the same network.
See [Chapter 11.6.3, "How To Connect to LAN"](#), on page 286.
3. On the remote PC, start a web browser that supports HTML5 (W3C compliant).
4. Enter the IP address of the R&S SMB100B in the browser's address bar.
The R&S SMB100B's welcome page is displayed.
5. In the navigation pane, select "Instrument Control" > "Web Control".
Remote access to the instrument requires the password. The default password is *instrument*.
6. Enter the password and confirm with the [Enter] key.
After the connection is established, the current screen of the R&S SMB100B is displayed in the browser window.
7. Use the mouse cursor and keyboard to access the functionality of the instrument as you would directly perform on the instruments touchscreen and front panel.

11.7.4 Establishing a Remote Control Connection over LAN Using VXI-11 Protocol

In this example, the I/O software library R&S VISA from Rohde & Schwarz is used to set up a LAN remote control link and remotely control the R&S SMB100B. R&S VISA is

running on a controller PC with Windows operating system. When the connection is set up, you can send commands to the instrument and receive the responses.

The remote control connection requires a VISA installation but no additional hardware on the controller PC. The LAN I/O channel is selected at initialization time using the VISA resource string (also referred to as "address string"). A VISA alias (short name) is used to replace the complete resource string. The host address is the R&S SMB100B's hostname or its IP address.

See also [Chapter 11.2.1, "LAN Interface"](#), on page 260.

Setting up the controller with R&S VISA

To remote control the R&S SMB100B, we use the R&S VISA Tester application. The application communicates via TCP/IP protocol.



The instrument is preconfigured for networks using DHCP (dynamic host configuration protocol). If this configuration is used, enter the computer name in the position of the IP address.

1. On the instrument:
 - a) Enable the LAN interface.
See [Chapter 11.6.1, "How To Enable Access via LAN"](#), on page 286.
 - b) Enable "SCPI over LAN".
See [Chapter 11.6.2, "How To Activate LAN Services"](#), on page 286.
2. On the controller (remote PC), install the R&S VISA program.
See <http://www.rohde-schwarz.com/rsvisa> > "RS VISA Release Notes".
3. Connect the controller and the instrument in the same network (network cable).
Switch them on.
See also [Chapter 11.6.3, "How To Connect to LAN"](#), on page 286.
4. On the controller, start "R&S VISA > Tester 32bit" or "R&S VISA > Tester 64bit".

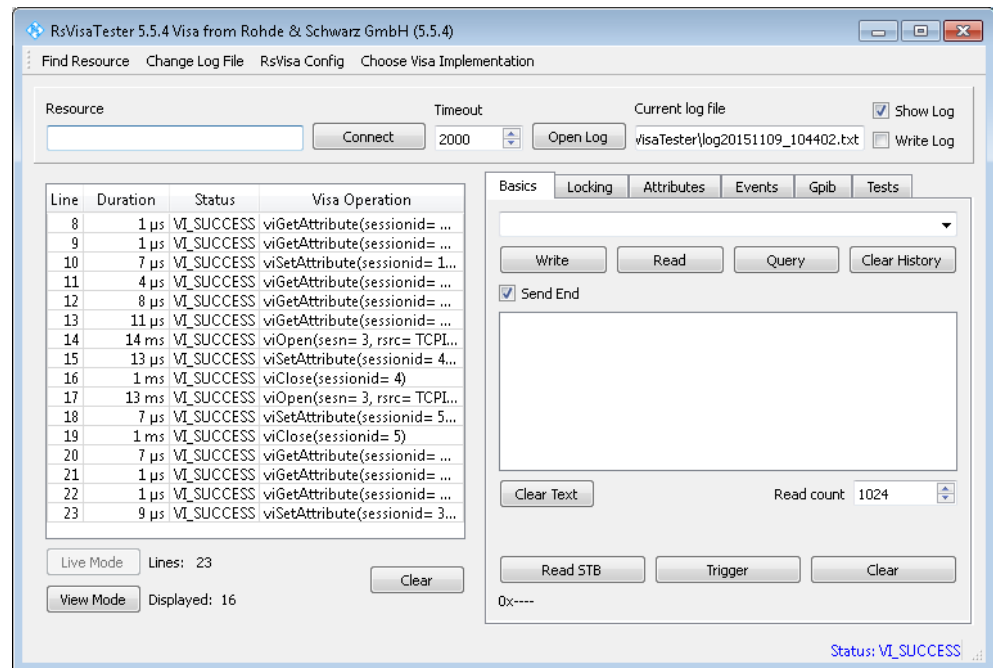

- In the menu bar, select "Choose VISA Implementation > Rohde & Schwarz Visa" and confirm with "OK".

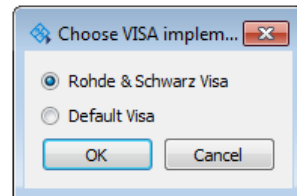

- In the menu bar, select "Find Resource" to search for the instrument in the LAN.

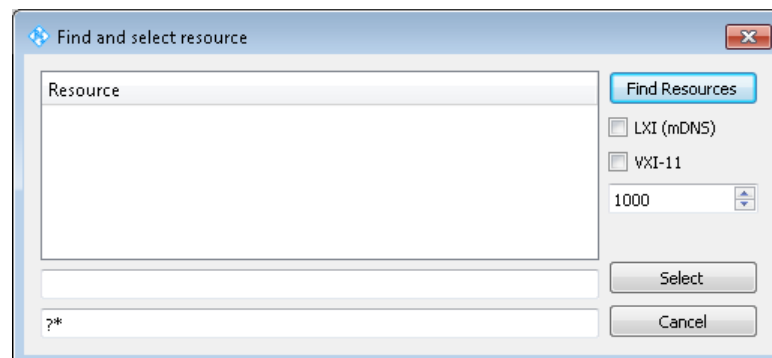

- Select "VXI-11" and "Find Resources".
R&S VISA scans the network for connected instruments and lists all detected instruments in the "Resource" list.
Note: The search may take some time, particularly in large networks.
- Select the required instrument and confirm with "Select".

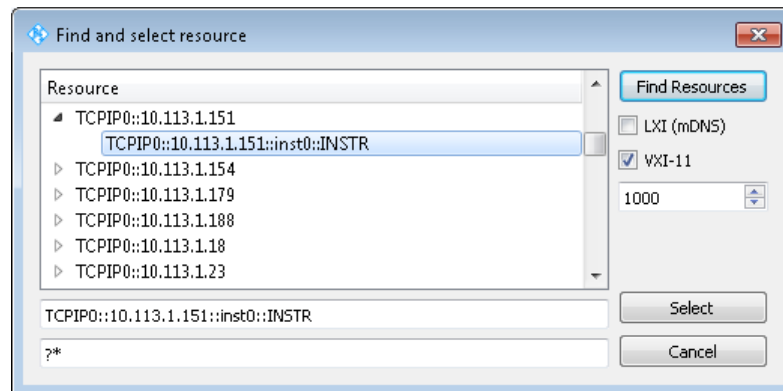

The "Find and select resource" dialog closes and R&S VISA indicates the IP address in the "Resource" field of the main application window.

9. As an alternative to the IP address, you can assign an alias name to the R&S SMB100B:
 - a) In the menu bar, select "RsVisaConfig".

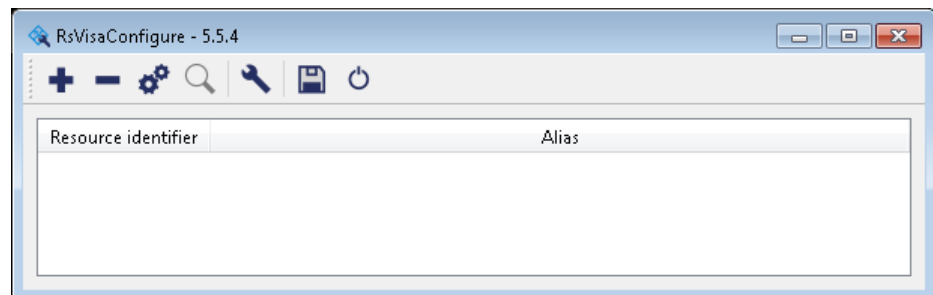

- b) In the toolbar, select "+" to access the "VISA Resource String Composer".

- c) Fill in the "Alias" name, the "VISA Resource String" and the "Device IP Address or host name" as shown in the figure, and confirm with "OK".

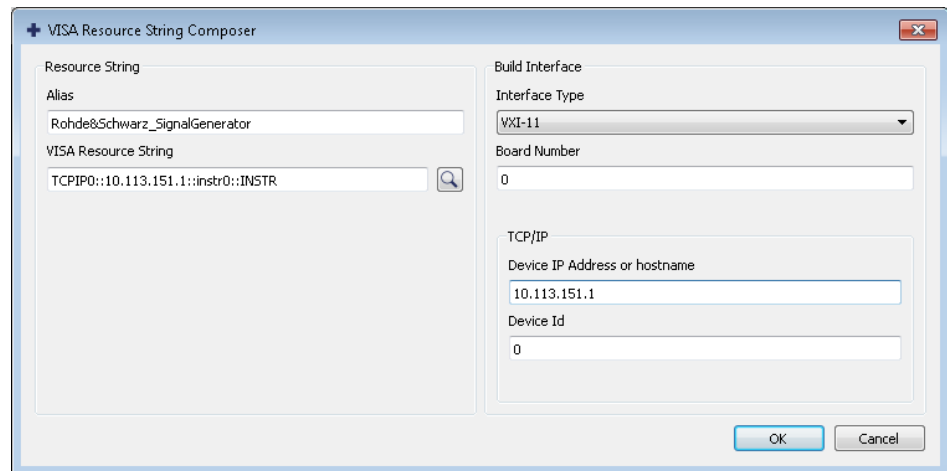

The "Alias" name is assigned.

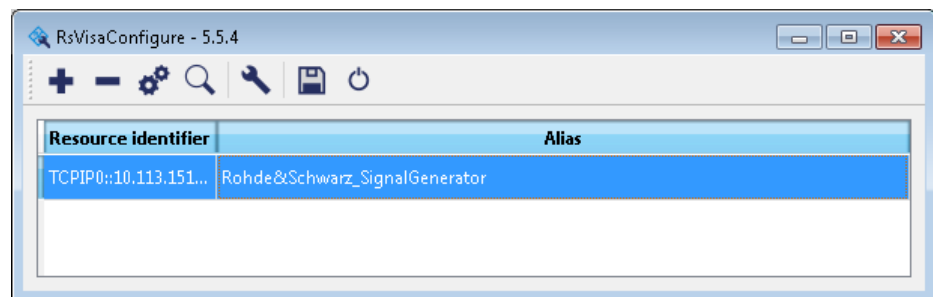

- d) Close the dialog.
The R&S SMB100B is registered in the program. It can be addressed via the resource string or alias name.

10. In the main window, select "Connect".

R&S VISA establishes the connection to the R&S SMB100B.

You can send settings to configure the instrument and receive its responses.

Note: If the connection cannot be set up, R&S VISA displays an error in the log view.

See also [Chapter 13.5, "Resolving Network Connection Failures"](#), on page 534.

For further information on the functions to read and write to an open session, and the utility applications the software provides, see the R&S VISA user manual.

Starting a remote control session over LAN with R&S VISA

To set the instrument to remote control, you can use the addressed command `>R` or send any command from the controller.

1. Start the R&S VISA Tester.
Establish the connection to the R&S SMB100B.
See ["Setting up the controller with R&S VISA"](#) on page 291.

- In the R&S VISA "Basics" tab, enter an SCPI command, e.g. "*IDN?". Confirm with "Query".

The instrument is switched to remote control when it receives a command from the controller.

- Select "Read" to obtain the instrument response.

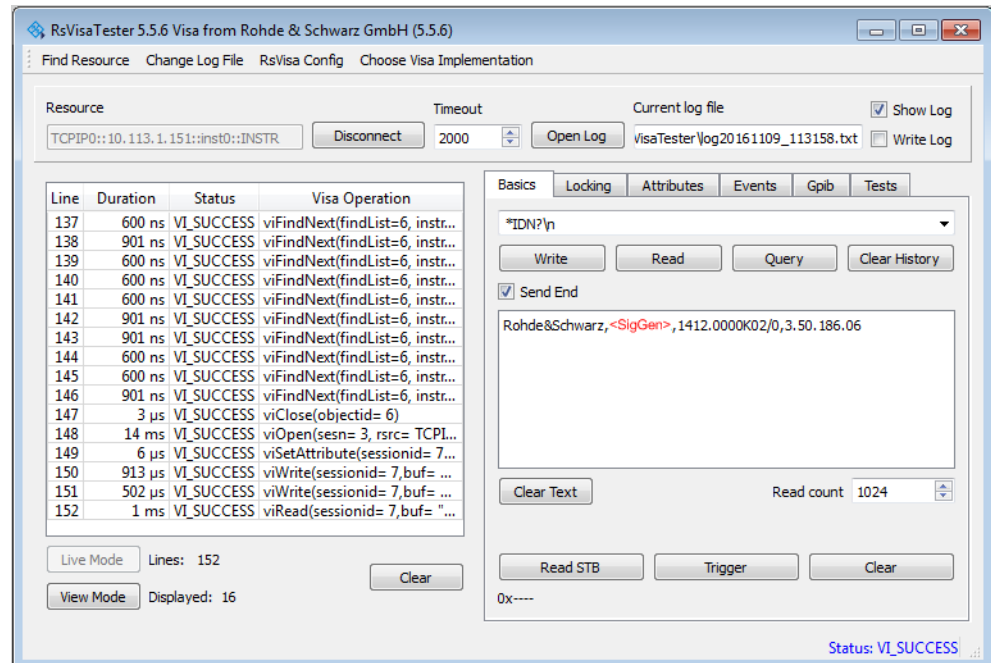

Tip: If the "Show Log" checkbox is checked, R&S VISA displays each VISA function call in the log-view on the left. If you check the "Write Log" checkbox, the log-view entry is written to the log file as well. You can operate the log-view in two modes: the "Live Mode" shows only the most recent messages whereas the "View Mode" allows you to scroll the history.

- To set, e.g. the frequency, enter `SOUR1:FREQ 4 GHz` and select "Write". To check the performed setting, `SOUR1:FREQ?` and select "Query". The instrument response is `4000000000`. The value corresponds to the frequency in Hz.

While remote control is active, the "Remote" icon in the status bar indicates that the instrument is in remote control mode. Currently ongoing communication (data transfer) is indicated by green colored arrows in the icon.

Operating via the front and touch panel or via mouse and keyboard are locked, allowing a remote control program to be performed without interruption. On the display, keys and entry fields are grayed out and cannot be activated or modified, but you can still open dialogs, for example to verify settings.

- To disable the access to the dialogs, use the command `SYST:KLOC ON`.
- To prevent unintentional return to manual operation, use the command `&LLO`. See also [Chapter A.1.2, "LAN Interface Messages"](#), on page 556.

The instrument switches to "Remote LLO" state. The [Setup] key is disabled.

7. To enable the [Setup] key, use the command `>R`.
8. To return to manual operation, see [Chapter 11.7.9, "How to Return to Manual Operation"](#), on page 299.

Tip: Switching from manual operation to remote control and vice versa does not affect the other instrument settings.

11.7.5 Establishing a Remote Control Connection over LAN Using Socket Communication

This section provides an example on how to establish a remote control connection over Telnet client and a simple sockets-based program example that can be further developed.

See also [Chapter A.2, "Telnet program examples"](#), on page 576.



The telnet client transmits information unencrypted. Therefore, for sensitive information we recommend that you use a client which supports secure protocols, like SSH.

In the following example, we assume basic knowledge of programming and operation of the controller. You can find information on the interface commands in the corresponding manuals.

Setting up a Telnet connection

To control the software, only a Telnet program is required. The Telnet program is part of every operating system.

1. On the instrument:
 - a) Enable the LAN interface.
See [Chapter 11.6.1, "How To Enable Access via LAN"](#), on page 286.
 - b) Enable "SCPI over LAN".
See [Chapter 11.6.2, "How To Activate LAN Services"](#), on page 286.
2. Connect the remote PC and the instrument in the same network.
See also [Chapter 11.6.3, "How To Connect to LAN"](#), on page 286.
3. On the remote PC, start the Telnet program.
Enter the socket address.
The socket address is a combination of the IP address or the hostname of the R&S SMB100B and the number of the port configured for remote-control via Telnet.
Tip: The R&S SMB100B uses the port number 5025 for remote connection via Telnet.

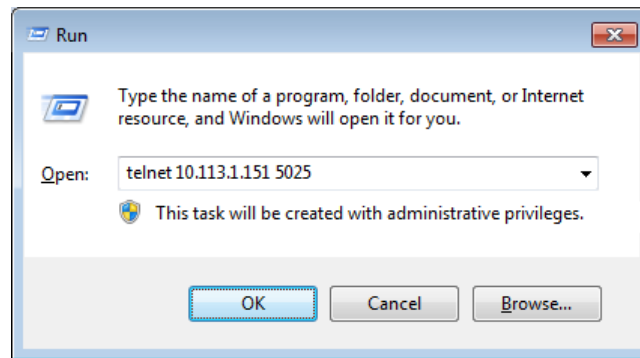

The connection to the instrument is set up and you can send remote-control commands.

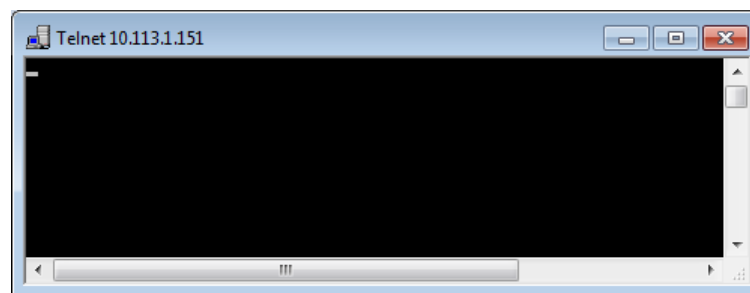

4. Telnet does not reflect your first entry. Insert a command, e.g. *IDN and confirm with "Enter".
5. Observe the screen.
A response on the query confirms that the connection is working. The client displays all subsequent inputs and responses.
6. Even if the cursor is not visible on the screen, blindly enter a remote-control command. Confirm with Enter.

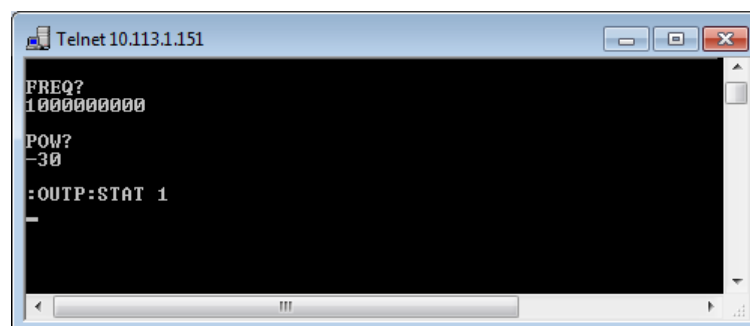

11.7.6 Setting Up a Remote Control Connection over GPIB

The program example in this section is written in VISUAL BASIC. A condition for programming in VISUAL BASIC is that the modules NIGLOBAL (Niglobal.bas) and VBIB32 (Vbib_32.bas) are added to the projects.



Drivers for instrument, for example IVI-COM and LabVIEW drivers, are available for download area on the product page at:

<https://www.rohde-schwarz.com/driver/smb100b/>

Starting a remote control session over GPIB

1. Connect instrument and controller using a GPIB cable. Switch them on.
2. Select "System Config > Remote Access > GPIB Address " > "**GPIB Channel Address = 28**".
The GPIB address of the instrument must be the default value of 28.
3. Execute the following commands on the controller:
 - a) Open the port to the instrument.
`CALL IBFIND("DEV1", generator%)`
 - b) Inform the controller about instrument address.
`CALL IBPAD(generator%, 28)`
 - c) Reset the instrument.
`CALL IBWRT(generator%, "*RST;*CLS")`
 - d) Set the instrument to new address.
`CALL IBWRT(generator%, "SYST:COMM:GPIB:ADDR 18")`
 - e) Inform the controller about new address.
`CALL IBPAD(generator%, 18)`

The GPIB address of the instrument is changed.
4. To return to manual operation, press the Local key at the front panel.

11.7.7 Setting Up a Remote Control Connection over USB

For remote control via the USB connection, the PC and the instrument must be connected via the USB type B interface. A USB connection requires the VISA library to be installed. VISA detects and configures the R&S instrument automatically when the USB connection is established. You do not have to enter an address string or install a separate driver.

Starting a remote control session over USB

1. Connect instrument and controller using USB cable. Switch them on.
2. Execute the following commands on the controller:
 - a) Open the port to the instrument.
`viOpen (... , "USB::0x0AAD::0x01DE::100001::INSTR", ...)`
 - b) Reset the instrument.
`viRST(generator%, "*RST;*CLS")`
 - c) Set 2 GHz frequency
`viPrintf (... , "SOUR:FREQ 2GHz\n")`

- d) Set 20 dBm output level

```
viPrintf (... , "SOUR:POW -20dBm\n")
```

The RF frequency and signal level of the instrument are changed.

3. To return to manual operation, press the [Local] key.

11.7.8 How to Trace Messages with the LXI Web Browser Interface

The remote trace functionality allows you to trace commands and messages exchanged via a remote control interface of the R&S SMB100B.

Activating the SCPI remote trace

1. On the instrument:
 - a) Enable the LAN interface.
See [Chapter 11.6.1, "How To Enable Access via LAN"](#), on page 286.
 - b) Enable "SCPI over LAN".
See [Chapter 11.6.2, "How To Activate LAN Services"](#), on page 286.
2. Connect the remote PC and the instrument in the same network.
See also [Chapter 11.6.3, "How To Connect to LAN"](#), on page 286.
3. Start a web browser that supports HTML5 (W3C compliant).
4. Enter the IP address of the R&S SMB100B in the browser's address bar.
The welcome page is displayed.
5. In the navigation pane, select "Diagnostics > SCPI Remote Trace".
6. In the toolbar bar of the "SCPI Remote Trace" page, select "live mode > on" and "logging > on".
"live mode > on" displays all commands and responses, and "logging > on" also traces messages.

If you now control the R&S SMB100B with SCPI commands, using an appropriate tool, the LXI function records the information sent and received.

The function records all sent commands, received responses and messages, and saves them in an internal database. If "live mode" is disabled, you can display the recent traces upon request, using the "refresh" button. You can also save the log in a file.

Note: The diagnostics functionality will be extended in later releases, e.g. to download or upload SCPI command files from / to the instrument.

11.7.9 How to Return to Manual Operation



Before returning to manual control, command processing must be completed. Otherwise, the instrument switches back to remote control immediately.

1. To return from "Remote" state to manual state, perform one of the following:
 - On the controller, use the command `>L`

Note: If `&NREN` has been set before `>L` is locked. Use `>R` instead.
 - In the status bar, select the "Remote" icon.
 - On the front panel, press the [Local] key.
 - In the block diagram, select "Context sensitive menu > Key Emulation > Local"
2. To return from "Remote LLO" state to manual or to "Remote" state, perform one of the following:

Note: In the local lockout state, the command `>L` and the [Local] key are locked. You can unlock this state only via remote control.

 - On the controller, use the command `&LOCS`.
This command switches directly to manual operation.
 - Send the command `&REMS`.
This command changes the remote control state from "Remote LLO" to "Remote".
 - Use the Visual Basic command `CALL IBLOC (generator%)`.
The command switches directly to manual operation.
 - VISA function `viGpibControlREN()`
This function switches directly to manual operation.

11.8 Automating Tasks with Remote Command Scripts

To achieve fast configuration, make complex test setups or repeating measurements reproducible, you can automate the required settings with scripts. A script contains a series of SCPI commands corresponding to the settings. When completed, it is converted to an executable format, saved in a file and can be run whenever needed.



If you frequently need to load and run a script, assign the script to the [★ (User)], and you can quickly and easily perform the task.

See [Chapter 10.2.4, "How to Assign Actions to the \[★ \(User\)\] Key"](#), on page 235.

In contrast to "Recall Setup" via the [★ (User)] key, an assigned script execution does not close active dialogs and windows. On the contrary, even active window control (open / close) is possible.

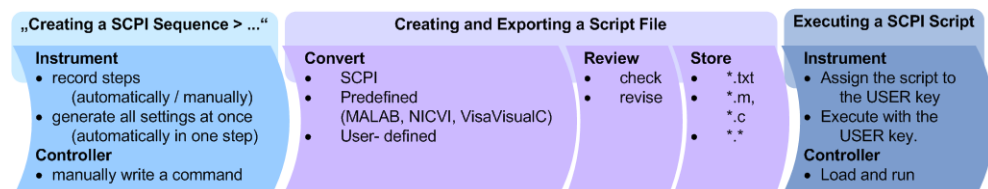

Figure 11-6: Steps for performing SCPI Scripts

In the graph, you can see the main steps required to work with an SCPI script.

Creating a SCPI list

With the SCPI record functions, you can create a SCPI command list directly in the instrument and then export the list to the controller. If you want to edit or write a script manually, use a suitable editor on the controller. Even for manually creating, the instrument supports you by showing the corresponding command syntax and the current settings value.

Directly in the instrument, you can create a SCPI list at any time of operation, in the following ways:

- Recording steps

Both, automatic and manual SCPI recording of settings is possible. You can start, stop and resume automatic recording, and also record individual commands manually.

 - Manually record the steps selectively

In manual recording mode, you can deliberately record a SCPI command with the "Add CPI Command to Recording List" function, see [How to record SCPI lists manually](#).
 - Automatically record all performed steps

The instrument records the SCPI command and settings value of each step you perform, and then writes the commands to the file system, see [How to record SCPI lists automatically](#).
You can also add a SCPI command manually to the recording list during automatic SCPI recording.

Note: The RF signal generator clears the SCPI list after booting automatically.
- Generating all settings at once

Generates the SCPI commands of the current instrument settings in one step, and writes the command list in a temporary list, see [How to create a SCPI list with the current instrument settings in one step](#).

Note: This function lists all commands in alphabetical order, in contrast to the recording or manual creation, which consider the order the settings are configured. Using this function can slow down the runtime or cause errors during execution. Therefore, always check and revise a script if necessary, see ["How to check an SCPI list"](#) on page 307.
- Manually create a command script with "Copy" and paste

Enables you to copy the SCPI command and the current setting, see [Chapter 11.8.1, "Show SCPI Command"](#), on page 303.



Some parameters cannot be set by an SCPI command.

If so, *no SCPI command found* is entered instead of a command when you record or generate all settings at once.

The difference between Show SCPI Command and the provided cross-reference

If you want to enter your settings in a script, or use a remote control program, you must know the corresponding SCPI command and the exact syntax.

If you need to look up the SCPI command, the instrument offers two ways to figure it out quickly.

- "Show SCPI command" (context-sensitive menu)
Displays the SCPI command syntax of a selected parameter including the current setting value, see ["Findig out the SCPI command using "Show SCPI Command" on page 309.](#)
The "Copy" function enables you to write an SCPI script conveniently by hand.
- Instrument help ([Help] key)
Opens a help topic that describes the selected parameter or instrument function, including a cross-reference to the corresponding SCPI command. The reference leads you to the description of the SCPI command comprising the complete SCPI syntax, all available setting values, value ranges, etc.
See ["Findig out the SCPI command using the online help" on page 309.](#)

Creating and exporting a script file

When the script list is completed, a code generator translates the SCPI commands into the source code of a proprietary programming language, using a code template. Therefore, each language requires an appropriate code template. When converted, you can save the script in a file with an extension corresponding to the programming language.

The R&S SMB100B provides the following predefined code templates by default:

- Plain SCPI
Represents SCPI base format, that is ASCII format, saved as text file (*.txt).
- MATLAB
A programming environment, frequently used in signal processing and test and measurement applications (*.m).
You can directly use this format with MATLAB(c) Toolkit. For comprehensive information on this topic, refer to the application note [1GP60: MATLAB Toolkit for R&S Signal Generators.](#)
- NICVI
An ANSI C programming environment designed for measurements and tests (*.c).
You can directly use this format with National Instruments LabWindows CVI.
- Python3
A general purpose and high level programming language (*.py).

You can also convert a script to a user-specific format. In this case, you need a code template with the extension *.expcodetmpl.

For information on how to select the code template and save the script in a file, see [Chapter 11.8.3, "SCPI Recording Export Settings"](#), on page 304.

Executing an SCPI script

An SCPI script primarily runs on the controller PC. In addition, you can execute a script directly on the instrument, by assigning the script to the [★ (User)] key.

See [Chapter 10.2.4, "How to Assign Actions to the \[★ \(User\)\] Key"](#), on page 235.

11.8.1 Show SCPI Command

Access:

1. Select the parameter.
2. Open the context-sensitive menu (tap and hold).
3. Select "Show SCPI Command".

This function provides the syntax of the remote command with the current setting.

Copy

Copies the command and the current setting.

Close

Exits the "SCPI Command" dialog.

11.8.2 Displaying an SCPI List

The instrument displays a recorded SCPI list and thus provides viewing the recorded results before exporting.

- ▶ Depending on the starting point, you can access the "SCPI Recording List" dialog as follows:
 - During recording
Select "Show SCPI Recording List" in the context-sensitive menu.
 - At any time outside recording
Select "Show SCPI Recording List" in the context-sensitive menu.
This function assumes that at least one recording has been executed after power-on.
 - At the end of the recording
Select "Stop automatic SCPI recording". The dialog opens automatically.
 - After you have exported the script to a file.
Select "SCPI Recording Export > Show file content"
See [Chapter 11.8.3, "SCPI Recording Export Settings"](#), on page 304.

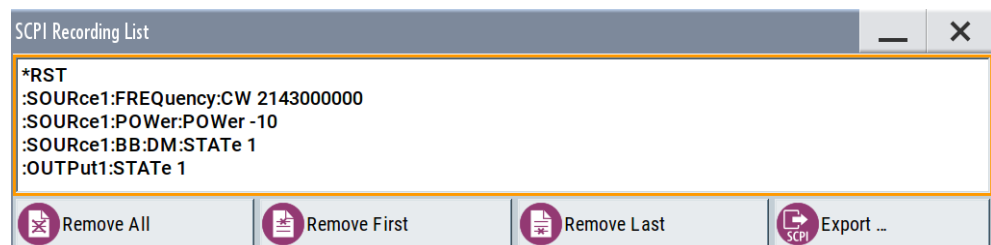

The "SCPI Recording List" shows the last recorded and exported commands.

SCPI Recording List

Lists the automatically or manually recorded recorded SCPI commands.

Export

Opens the [SCPI Recording Export](#) dialog for configuring the file parameters for export.

Remove All, Remove First, Remove Last

Deletes either the first, the last or all recorded SCPI commands.

To remove several recorded commands, repeat the removing.

For post processing, export the SCPI command list in a file, see [Chapter 11.8.5, "How to Convert and Save SCPI Lists"](#), on page 308.

11.8.3 SCPI Recording Export Settings

Scripts are configured and saved in the "SCPI Recording Export" dialog. This dialog opens automatically, when you stop recording.

Access:

1. Select "Show SCPI Recording List" in the context-sensitive menu.
The "SCPI Recording List" dialog opens.
2. Select "Export".

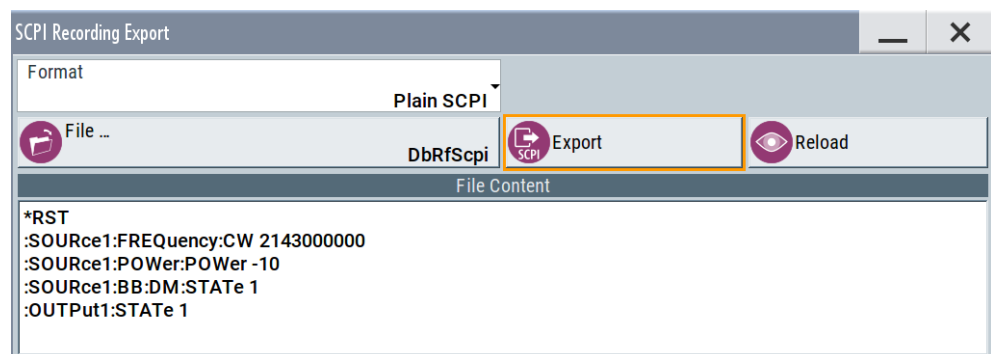

The "SCPI Recording Export" dialog contains all functions required for export of command lists to a file. It enables you to select the source code format, assign an individual filename and display the file content.

Format

Selects the source code format for the command list.

"Plain SCPI" Uses SCPI syntax.

"Predefined Code Generator"

Accesses the predefined templates for common source code generators that convert the recorded settings in the programming languages MATLAB or NICVI or Python.

"User Code Generator"

Use this setting to convert a script by a user-specific code generator.

Select Code Template

Opens the standard "File Select" dialog and lists the predefined or user-defined code templates.

See [Chapter 9.5.1, "File Select Settings"](#), on page 202.

File

Opens the standard file select dialog "Select Output File", see [Chapter 9.5.1, "File Select Settings"](#), on page 202.

Export

Executes data export.

The SCPI list is saved in as file with the selected filename and in the selected directory, see [File](#).

Reload

Reloads a SCPI list from a file.

You can export recorded SCPI lists to files (see [File](#) and [Export](#)), that can be modified.

File content

Displays the content of the script in the selected format and code template.

11.8.4 How to Record / Create SCPI Lists

How to record SCPI lists automatically

The following example briefly explains how to proceed when you want to record SCPI lists.

For comprehensive description, see [1GP98: SCPI Recorder Test Automation on a Fingertip](#).

1. On the screen, open the context-sensitive menu (touch and hold, or right mouse click) and select "Start SCPI recording".



Starting from now, all steps you perform are recorded.

2. To stop SCPI recording, select "context-sensitive menu > Stop SCPI recording".

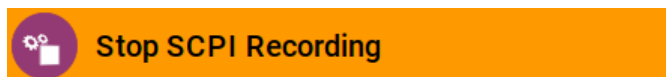

The "SCPI Recording List" dialog opens automatically.

3. Proceed with [How to check an SCPI list](#).

How to record SCPI lists manually

1. To retrace your settings, open the context-sensitive menu and select "Mark all Parameters Changed from Preset".



Mark All Parameters Changed from Preset

This function identifies and highlights all settings you have changed, both in the block diagram, and in the dialogs.

Frequency	4.000 000 000 000 GHz	
Offset	10.000 000 kHz	Multiplier 1.000
User Variation		
Variation Active	<input checked="" type="checkbox"/>	Variation Step 1.000 000 000 MHz

2. For selectively recording your steps:
 - a) Set the parameter.
 - b) Open the context-sensitive menu.
 - c) Select "Add SCPI Command to Recording List"



Add SCPI Command to Recording List

Tip: You cannot see "Add SCPI ..." in the menu?

A possible reason is opening the menu outside of a dialog or input field, for example in a block diagram. Open the context-sensitive menu within the corresponding dialog or input field, and the feature is available.

- d) Continue with the next setting, and repeat steps *a to b* whenever needed.

Each time you select "Add SCPI ...", the SCPI command is appended to a temporary list.

3. To check the progress of the recording, select "Context-Sensitive > Show SCPI Recording List".



Show SCPI Recording List (4)

The "SCPI Recording List" dialog opens, displaying all recorded settings so far.

4. Proceed with [How to check an SCPI list](#).

How to create a SCPI list with the current instrument settings in one step

You can also generate a SCPI list from a manually created instrument state at any time, in only one step.

To generate an SCPI list with commands for all settings performed:

1. Select "Save/Recall > SCPI Export".

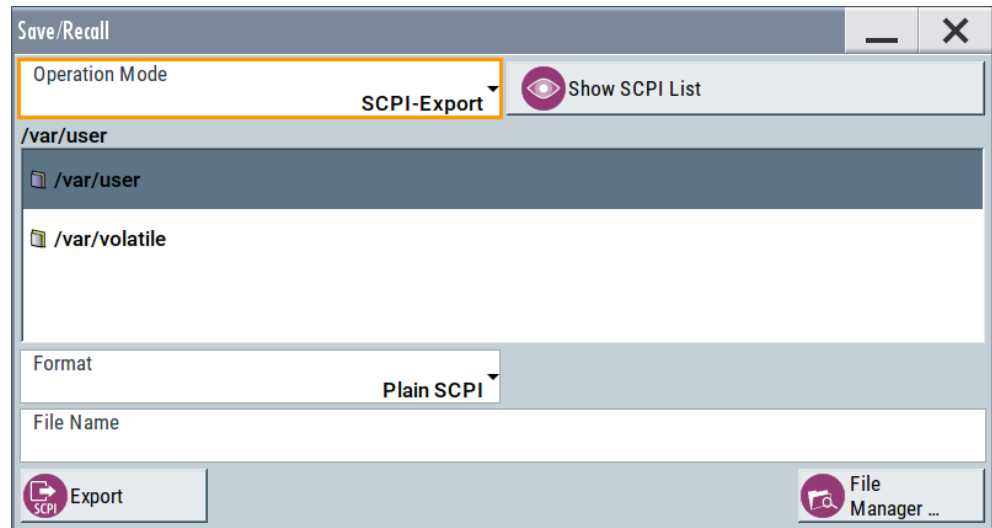

The instrument opens the standard file select dialog, see [Chapter 9.4.1, "Save/Recall Settings"](#), on page 198.

2. In the "Format" entry field, select the source code.
3. Depending on the selected format, convert the script as described in [Chapter 11.8.5, "How to Convert and Save SCPI Lists"](#), on page 308
4. Enter a filename.
5. Select "Export".
The instrument writes all SCPI commands of the key parameters and the modified settings in the file. Also assigns the file extension automatically according to the source code format.
6. To preview the content of the SCPI list:
 - a) Select "System Config > Save/Recall".
 - b) Select "Operation Mode > SCPI-Export".
 - c) In the `/var/user/` directory, select a previously saved file.
 - d) Select "Show SCPI List".

The list of all SCPI commands is displayed, for example, for a final check.



Exporting the SCPI list of the instrument state in one step is a fast and convenient method. Nevertheless, it usually requires postprocessing on an external PC.

How to check an SCPI list

The easiest way to check a list, is to execute it. The generator returns a warning if a setting could not be performed.

However, we recommend that you check the list and possibly rework. It can be that ...

- A parameter has not assigned an SCPI command or an element of the user interface has not an assigned parameter. In these cases, `:SYST:INF:SCPI 'SCPI command not available'` is entered in the list instead.
Such entries are also detected during execution. The instrument recognizes these incomplete commands and displays an error message.
- A preset has been executed, but several standards subsequently perform some internal settings that are also assigned to the list with "SCPI Export".
- After a preset still some settings are defined, which are then written to the list generated with "SCPI Export."

Some suggestions on how you can check and revise a list:

1. Search and remove missing command entries.
2. Remove unnecessary content written after a preset.
3. Rearrange the commands to a reasonable order. If you, for example, set a `STATE` command to the last position of a list, you can avoid intermediate calculations of the signal.
4. Preview the list for completeness by comparing it with the modified settings in the manual mode.
 - a) To retrace your settings in manual operation, open the context-sensitive menu and select "Mark all parameters changed from preset".
The function identifies all settings you have changed, both in the block diagram, and in the dialogs. They appear orange.
 - b) Check whether there is a command in the list for all modified settings.
5. To perform modifications, export the list to a PC, using for example a USB flash drive.

11.8.5 How to Convert and Save SCPI Lists

After completing the recording, the "SCPI Recording Export" dialog opens.

1. Select the "Format" for the command syntax in which you want to save the list.
2. "Select Code Template"
Depending on the selected format, proceed accordingly:
Note: Select the code template **before** exporting.
 - a) Plain SCPI
Continue with the next step.
 - b) Predefined code generator
The "SCPI Recording Export - Select Predefined Code Template" dialog opens.
Select one of the predefined code templates.

- c) User code generator
 - A file system ("SCPI Recording Export - Select User Code Template") dialog opens.
 - Select your user-defined code template. The code template must have file extension *.expcodetmpl.
3. Select "File..."
 - The "SCPI Recording Export - Select Output File" dialog opens.
4. Select "New" and assign a filename for saving the recorded list.
5. In the "SCPI Recording Export" dialog, select "Export".
 - Saves the recorded data either in ASCII format (plain SCPI), or in the corresponding format of the used code template, and shows the SCPI list in the "File Content" section.

11.8.6 How to Find Out the SCPI Commands for GUI Functions

Findig out the SCPI command using "Show SCPI Command"

1. To find out the SCPI command of a parameter in manual operation, select the respective parameter.
2. Open the context-sensitive menu and select "Show SCPI command"

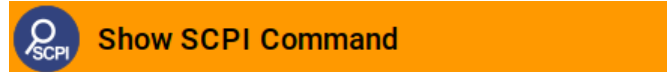

You get the detailed command syntax, including the currently set value.

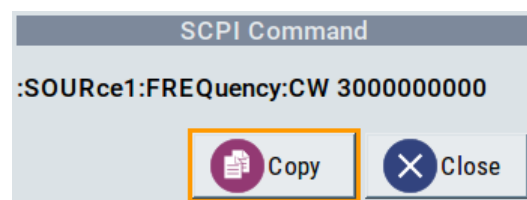

With the "Copy" function, you can conveniently paste the command including the current setting, e.g., in a command script.

Findig out the SCPI command using the online help

If you are looking for the remote command to a function in manual operation, you find it in the description of the online help.

1. To find out the SCPI command of a parameter in manual operation, select the respective parameter.
2. To open the corresponding help topic, select one of the following:
 - In the display, select "context-sensitive menu > Help".

 Help

- On the front panel, press the [Help] key.

The help topic opens. Apart from the function description, it contains the SCPI command in detailed syntax.

**How to find the corresponding GUI function to a command**

Conversely, if you are looking for a function in the GUI, which belongs to a SCPI, you find it via a cross-reference in the online help and in the user manual.

11.9 Operating the R&S SMB100B Remotely via VNC

This section shows you some examples of the various possibilities to set up remote operation.

- Using a desktop system
 - [Chapter 11.9.2.1, "Using a Web Browser"](#), on page 311
 - [Chapter 11.9.2.2, "Using a VNC Client Software"](#), on page 311
- Using a smart device
 - [Chapter 11.9.3.1, "Using a VNC App"](#), on page 314
 - [Chapter 11.9.3.2, "Using a Web Browser with HTML5"](#), on page 314
 - [Chapter 11.9.3.3, "Special Mode QR Code "](#), on page 315

11.9.1 How To Enable the VNC Service

1. **NOTICE!** Enabled VNC service can lead to unauthorized access.
Change the computer name and password of the instrument.
See [Chapter 10.4.5, "How to Prevent Unauthorized Access"](#), on page 252.
2. Select "System Config > Setup > Security > Security > LAN Services".
3. Select "VNC > On".
4. Enter the [Security Password](#).
5. Select "Accept".

11.9.2 How To Set Up a Remote Operation from a Desktop System

11.9.2.1 Using a Web Browser

The R&S SMB100B supports remote operation via VNC with any web browser, like Windows Internet Explorer or Mozilla Firefox for instance, or alternatively, an HTML5 web browser.

To operate the instrument via a web browser remotely:

1. Install the *JRE (Java Runtime Environment)* on the remote computer.
Note: Skip this step if you are working with an HTML5 web browser.
2. Type the instruments' IP address in the address field of the web browser on your PC, e.g. `http://10.113.1.151`

The VNC authentication screen appears.

3. Enter the password and confirm with "OK".
The default password is *instrument*.

After the connection is established, the current screen of the signal generator is displayed and the instrument can be remotely operated from the remote computer.

11.9.2.2 Using a VNC Client Software

A VNC client software is an application which can be used to access and control the instrument from a remote computer through a LAN connection.

The VNC client software for setting up the connection is included in the operating system Linux/Unix per default. For Windows operating systems, a VNC client software must be installed manually.

Various free-of charge programs such as Ultr@VNC or similar VNC client programs are available for download on the Internet.

Setting up the VNC connection on a Linux/Unix desktop client

1. Start a web browser on the remote computer. Enter the IP address of the instrument.
2. Enter the following address:
`vnc://<IP-address of the instrument>`, for example `vnc://10.113.1.151`.

A dialog opens requesting the password for the remote VNC connection.

3. Enter the password and confirm with "OK".
The default password is *instrument*.

After the connection is established, the current screen of the signal generator is displayed and the instrument can be remotely operated from the remote computer.

Setting up the VNC connection on a Windows desktop client

1. Install the VNC viewer program component on the remote computer.
 - a) On the Internet, select a VNC client program and download it onto your PC.
For example the free of charge software Ultr@VNC (`vncviewer.exe` is available, see <http://www.uvnc.com/download/index.html>.
 - b) Execute the VNC client installation.
 - c) Select the VNC viewer program component and follow the installation instructions.
2. Start VNC viewer program component on the PC.

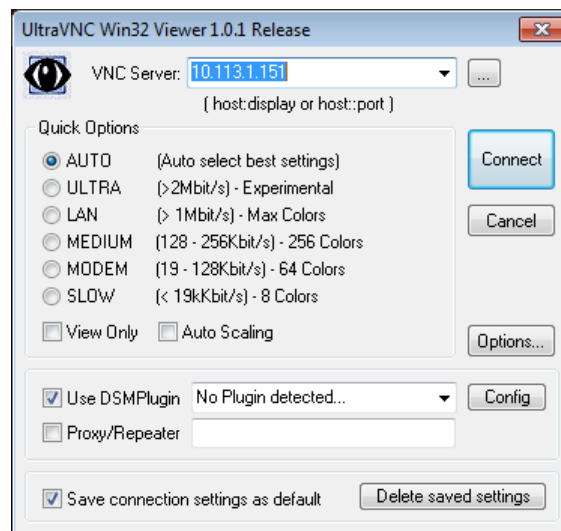

3. Select "VNC Server" and enter the IP address of the instrument.
4. To initialize the connection, select "Connect".
A dialog opens requesting the password.

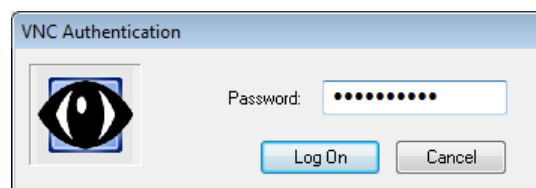

5. Enter the password and confirm with "OK".
The default password is *instrument*.

After the connection is established, the current screen of the signal generator is displayed and the instrument can be remotely operated from the remote computer.

Terminating VNC connection

- ▶ Perform one of the following:
 - a) On an external Unix/Linux PC, close the Internet browser or the signal generator window.

b) On an external Windows PC, close the VNC viewer program.

The connection is terminated but not disabled. It can be established again any time.

In the "Active Connections" tab, the displayed TCP/IP connection disappears.

See [Chapter 10.4.5, "How to Prevent Unauthorized Access"](#), on page 252.

11.9.3 How To Set Up a Remote Operation from a Smart Device

The R&S SMB100B supports remote operation via VNC from a smart device (remote client), like a tablet (tablet computer) or a smartphone. The smart device accesses the instrument via WLAN, either by a suitable App, or an HTML5 web browser, that means with embedded *javascript*.

There are several possibilities to establish a WLAN connection between the smart device and the R&S SMB100B. This section gives an example of how a network environment can be built up, and some essential configuration steps.

For more information, see:

- [1MA216: Remote Operation of Windows Based Instruments with Apple iPad](#)
- [7BM82: Apple iPad Remote Control of Broadcasting T&M Instruments](#)

Example:

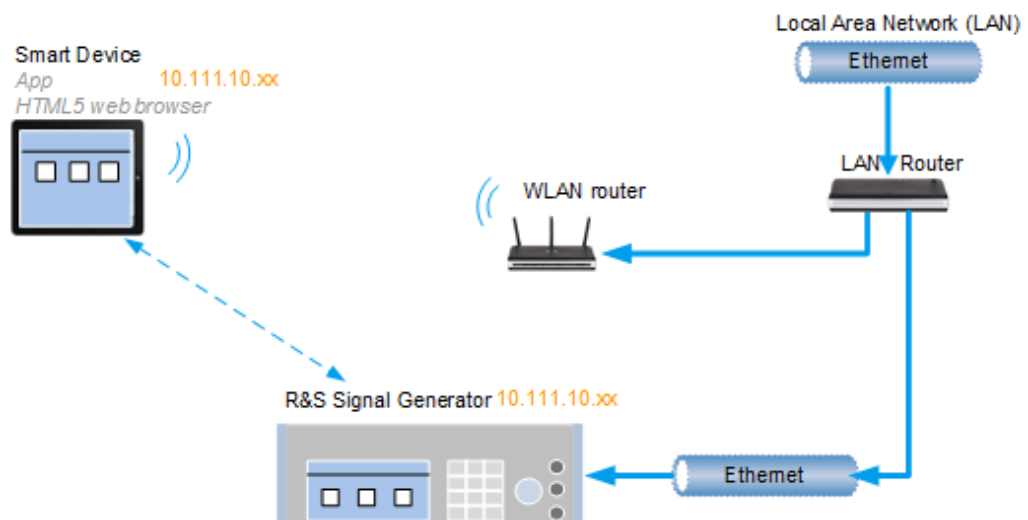

Figure 11-7: Example of a network configuration for remote operation with a smart device

As shown in the figure, the R&S SMB100B and the WLAN router are connected to the LAN router. The smart device accesses the Rohde & Schwarz instrument via the WLAN router.

Prerequisites

For this network configuration, the following prerequisites must be met:

- The required equipment is:

- A LAN router
- A WLAN router (hot spot)
Required for accessing the R&S SMB100B
- The smart device must be known and accepted in the network of the R&S SMB100B.
- The *App* or web browser implements the VNC functionality on the smart device for remote operation.

It is recommended that all components in the network use DHCP, which automatically assigns the relevant address information.



With the configuration in the example, you can reach the instrument from a great distance, since the WLAN router acts as an additional access point.

11.9.3.1 Using a VNC App

Using a *VNC App* enables the smart device to access the R&S SMB100B via WLAN.

The VNC Apps are available from various manufacturers of the smart devices.

The list of supported devices is different according to the smart device.

1. Refer to the manufacturer's website to find out whether a VNC App is available for your device, and how it is installed.
2. In the network, establish the connection of the WLAN router to the LAN router. We assume the connection of the LAN router and the R&S SMB100B and their configuration in the LAN.
3. Configure the WLAN router according to the manufacturer's instructions.
4. Install the required *VNC App* on your smart device.
5. On the smart device, start the *VNC App*.
6. In the address field, enter the IP address of the instrument.

A log-on dialog opens and requests the password for the VNC connection.

7. Enter the password to establish the remote access.
The default user name and password is *instrument*.
See [Chapter 10.4.5, "How to Prevent Unauthorized Access"](#), on page 252.

After the connection is established, the current screen of the signal generator is displayed and the instrument can be remotely operated.

11.9.3.2 Using a Web Browser with HTML5

The R&S SMB100B supports remote operation from a smart device via VNC with any HTML5 compliant web browser, like Internet Explorer, Firefox, Google Chrome, or Safari for instance.

To operate the instrument remotely via a web browser, proceed as follows:

1. In the web browser enter the IP address of the instrument, e.g. *http://10.113.1.151*.
2. Type the instrument IP address in the address field of the web browser on your PC, e.g. *http://10.113.1.151*

The VNC authentication screen appears.

3. Enter the password and confirm with "OK".

The default password is *instrument*.

See [Chapter 10.4.5, "How to Prevent Unauthorized Access"](#), on page 252.

After the connection is established, the current screen of the signal generator is displayed and the instrument can be remotely operated.

11.9.3.3 Special Mode QR Code

If your smart device is equipped with a camera and a QR code reader, you can scan the instrument's IP address or access the instrument with the Safari web browser.

QR code readers are available from various manufacturers of the smart devices.

The list of supported devices is different according to the smart device.

1. Refer to the manufacturer's website of your smart device to find out whether a reader is available for your device, and how it is installed.
2. Install the required QR code reader software on your device.
3. Start the reader.
4. On the R&S SMB100B, select "System Config > Remote Access".
5. In the "Remote Access" dialog, select the "QR-Code" tab.
6. Scan the QR code of the instrument with your smart device.
7. On the device, decode the scanned QR code and pass it to the web browser.
A dialog opens requesting the password for the VNC connection.
8. Enter the password and confirm with "OK".
The default password is *instrument*.

After the connection is established, the current screen of the signal generator is displayed and the instrument can be remotely operated.

11.10 References

11.10.1 LXI Functionality

LAN Extensions for Instrumentation (LXI) is an instrumentation platform for measuring instruments and test systems that is based on standard Ethernet technology. LXI is intended to be the LAN-based successor to GPIB, combining the advantages of Ethernet with the simplicity and familiarity of GPIB.

Like GPIB, LXI determines and standardizes the way the instrument behaves in a LAN. The LXI implementation in the R&S SMB100B allows you to change certain LAN settings, to reset the LAN connection, and to identify the instrument.



For information about the LXI standard, refer to the LXI website at <http://www.lxistandard.org>.

See also "News from Rohde & Schwarz, article 2006/II - 190".

The LXI functionality in the R&S SMB100B is characterized by a common LAN implementation, including an ICMP ping responder for diagnostics. The instrument can be configured via a web browser. A LAN Configuration Initialize (LCI) mechanism resets the LAN configuration. The instrument also supports automatic detection in a LAN via the VXI-11 discovery protocol and programming by IVI drivers.

In addition the R&S SMB100B provides the following LXI-related functionality:

- Integrated "LXI Status" dialog for LXI status indication and reset of the LAN configuration, see [Chapter 11.5.1, "LXI Status Settings"](#), on page 278.
- "LXI Browser Interface", as described in [Chapter 11.5.2.1, "LAN Configuration"](#), on page 281.
- "SCPI Remote Trace" utility, see ["SCPI Remote Trace"](#) on page 283.



Firmware update

To enable the full LXI functionality after a firmware update, shut down and restart the instrument.

11.10.2 Code Generator Templates

This section describes the main structure of the code generator templates, and shows the method by means of the NICVI template.

The code generation is controlled by templates with the following blocks:

Command	Function
#EXTENSION_START #EXTENSION_END	Defines the output file extension.
#INIT_CODE_START #INIT_CODE_END	Contains initial entries, such as included files and libraries, buffer size, commands for synchronization, or creating a VISA session. All entries between start and end are written once at the beginning of the output file.
#COMMAND_CODE_START #COMMAND_CODE_END	Frame for an SCPI command. A command is accessed with %COMMAND.
#NO_COMMAND_CODE_START #NO_COMMAND_CODE_END	Frame for a parameter with no SCPI command available. A parameter is accessed with %PARAMETER.
#EXIT_CODE_START #EXIT_CODE_END	Closes the visa session. All entries between start and end are written once at the end of the output file.

Templates are created in ASCII format with file extension *.expcodetempl.

Example:

Example to the code generator template NICVI.expcodetmpl:

```
#EXTENSION_START
.c
#EXTENSION_END

#INIT_CODE_START
#include <ansi_c.h>
#include <visa.h>
#include <cvirte.h>

#define MAX_BUFFER_SIZE 200
static ViStatus status;
static ViSession defaultRM, handle;

static void write_command(char *command)
{
    char writeBuffer[MAX_BUFFER_SIZE];
    char readBuffer[MAX_BUFFER_SIZE];
    int length;
    int readCount;

    strcpy(writeBuffer, command);
    //append "*OPC?" to sync
    strcat(writeBuffer, "*OPC?");
    length = strlen (writeBuffer);
    writeBuffer[length]='\n';
```

```

        length = length+1;
        viWrite (handle, writeBuffer, length, VI_NULL);
        //read result
        viRead(handle, readBuffer, 100, &readCount);
    }
int main (int argc, char *argv[])
{
    if (InitCVIRTE (0, argv, 0) == 0)
        return -1;    /* out of memory */
        //create a VISA session and return a handle to it
        viOpenDefaultRM (&defaultRM);
        //create a VISA session to the serial port and return a handle to it
        viOpen (defaultRM, (ViRsrc)"TCPIP::localhost::INSTR", VI_NULL, VI_NULL,
&handle);
#INIT_CODE_END

#COMMAND_CODE_START
    write_command("%COMMAND");
#COMMAND_CODE_END

#NO_COMMAND_CODE_START
    //no SCPI command available for parameter %PARAMETER !
#NO_COMMAND_CODE_END

#EXIT_CODE_START
    viClose (handle);
        viClose (defaultRM);
        return 0;
}
#EXIT_CODE_END

```

11.10.3 Remote Control States

How to recognize if there is an active remote connection to the instrument

- Observe the indication on the taskbar.





SCPI, VNC,
SMB, FTP

A softkey in the taskbar indicates if and what kind of remote connections are currently set up.

See also [Chapter 11.4.6, "Remote Connections Settings"](#), on page 275.

The following table shows the different remote control states and the associated commands or actions to return to manual control.

Table 11-3: Remote control status icons

GUI symbol	Transition to remote control state...	Transition to manual operation...(local state)
 	<p>&GTR (controller)</p> <p>Remote control, but usable front panel keys. The parameters are in read-only mode.</p>	<ul style="list-style-type: none"> • &GTL (controller) • Tap the "Remote" icon (display) • [Local] (front panel or key emulation) <p>A currently performed setting is indicated by the green arrows.</p> <p>The setting must be completed (white arrows), otherwise the instrument remains in remote state.</p>
	<p>&LLO (controller)</p> <p>Remote control with locked front panel keys to prevent user interaction. The parameters are in read-only mode.</p> <p>You can unlock LLO, and thus return to manual operation only via remote control.</p>	<ul style="list-style-type: none"> • &LOCS (controller) • CALL IBLOC (generator%) (controller) <p>Note: The command &REMS returns to "Remote" state.</p>

12 Remote Control Commands

In the following, all remote-control commands are presented in detail with their parameters and the ranges of numerical values.

For an introduction to remote control and the status registers, refer to:

- [Chapter 11, "Network Operation and Remote Control"](#), on page 257
- [Chapter A.1, "Additional Basics on Remote Control"](#), on page 555

12.1 Conventions Used in SCPI Command Descriptions

Note the following conventions used in the remote command descriptions:

- **Command usage**
If not specified otherwise, commands can be used both for setting and for querying parameters.
If a command can be used for setting or querying only, or if it initiates an event, the usage is stated explicitly.
- **Parameter usage**
If not specified otherwise, a parameter can be used to set a value and it is the result of a query.
Parameters required only for setting are indicated as **Setting parameters**.
Parameters required only to refine a query are indicated as **Query parameters**.
Parameters that are only returned as the result of a query are indicated as **Return values**.
- **Conformity**
Commands that are taken from the SCPI standard are indicated as **SCPI confirmed**. All commands used by the R&S SMB100B follow the SCPI syntax rules.
- **Asynchronous commands**
A command which does not automatically finish executing before the next command starts executing (overlapping command) is indicated as an **Asynchronous command**.
- **Reset values (*RST)**
Default parameter values that are used directly after resetting the instrument (*RST command) are indicated as ***RST values**, if available.
- **Factory preset values**
Default parameter values that are reset only by factory preset.
- **Default unit**
The default unit is used for numeric values if no other unit is provided with the parameter.
- **Manual operation**
If the result of a remote command can also be achieved in manual operation, a link to the description is inserted.

12.2 Programming Examples

The corresponding sections of the same title provide simple programming examples for the R&S SMB100B. The purpose of the examples is to present **all** commands for a given task. In real applications, one would rather reduce the examples to an appropriate subset of commands.

The programming examples have been tested with a software tool which provides an environment for the development and execution of remote tests. To keep the examples as simple as possible, only the "clean" SCPI syntax elements are reported. Non-executable command lines (for example comments) start with two // characters.

At the beginning of the most remote control program, an instrument (p)reset is recommended to set the R&S SMB100B to a definite state. The commands *RST and SYSTem:PRESet are equivalent for this purpose. *CLS also resets the status registers and clears the output buffer.

In all the examples we assume that:

- A remote PC is connected to the instrument
- The remote PC and the instrument are switched on
- A connection between them is established
- The security setting "System Config > Setup > Security > SCPI over LAN" is enabled.

12.3 Common Commands

Common commands are described in the IEEE 488.2 (IEC 625-2) standard. These commands have the same effect and are employed in the same way on different devices. The headers of these commands consist of "*" followed by three letters. Many common commands are related to the Status Reporting System.

Available common commands:

*CLS.....	322
*ESE.....	322
*ESR?.....	322
*IDN?.....	322
*IST?.....	323
*OPC.....	323
*OPT?.....	323
*PRE.....	323
*PSC.....	323
*RCL.....	324
*RST.....	324
*SAV.....	324
*SRE.....	325
*STB?.....	325

*TRG.....	325
*TST?.....	325
*WAI.....	325

*CLS

Clear status

Sets the status byte (STB), the standard event register (ESR) and the `EVENT` part of the `QUESTIONABLE` and the `OPERATION` registers to zero. The command does not alter the mask and transition parts of the registers. It clears the output buffer.

Usage: Setting only

*ESE <Value>

Event status enable

Sets the event status enable register to the specified value. The query returns the contents of the event status enable register in decimal form.

Parameters:

<Value> Range: 0 to 255

*ESR?

Event status read

Returns the contents of the event status register in decimal form and then sets the register to zero.

Return values:

<Contents> Range: 0 to 255

Usage: Query only

*IDN?

Identification

Returns the instrument identification.

Return values:

<ID> "Rohde&Schwarz,<device type>,<part number>/<serial number>,<firmware version>"

Example: Rohde&Schwarz,SMB100B,11400.1000K02/0,4.00.033

Usage: Query only

Manual operation: See "[IDN String](#)" on page 275
 See "[Hardware Options/Software Options](#)" on page 538

***IST?**

Individual status query

Returns the contents of the IST flag in decimal form. The IST flag is the status bit which is sent during a parallel poll.

Return values:

<ISTflag> 0 | 1

Usage: Query only

***OPC**

Operation complete

Sets bit 0 in the event status register when all preceding commands have been executed. This bit can be used to initiate a service request. The query writes a "1" into the output buffer when all preceding commands have been executed, which is useful for command synchronization.

***OPT?**

Option identification query

Queries the options included in the instrument. For a list of all available options and their description, refer to the data sheet.

Return values:

<Options> The query returns a list of options. The options are returned at fixed positions in a comma-separated string. A zero is returned for options that are not installed.

Usage: Query only

Manual operation: See "[OPT String](#)" on page 275
 See "[Hardware Options/Software Options](#)" on page 538

***PRE <Value>**

Parallel poll register enable

Sets parallel poll enable register to the indicated value. The query returns the contents of the parallel poll enable register in decimal form.

Parameters:

<Value> Range: 0 to 255

***PSC <Action>**

Power on status clear

Determines whether the contents of the `ENABLe` registers are preserved or reset when the instrument is switched on. Thus a service request can be triggered when the instrument is switched on, if the status registers ESE and SRE are suitably configured. The query reads out the contents of the "power-on-status-clear" flag.

Parameters:

<Action> 0 | 1

0

The contents of the status registers are preserved.

1

Resets the status registers.

***RCL** <Number>

Recall

Loads the instrument settings from an intermediate memory identified by the specified number. The instrument settings can be stored to this memory using the command `*SAV` with the associated number.

It also activates the instrument settings which are stored in a file and loaded using the `MMEMory:LOAD <number>, <file_name.extension>` command.

Manual operation: See "Recall Immediate x" on page 201

***RST**

Reset

Sets the instrument to a defined default status. The default settings are indicated in the description of commands.

The command is equivalent to `SYSTem:PRESet`.

Usage: Setting only

Manual operation: See "Preset" on page 194

***SAV** <Number>

Save

Stores the current instrument settings under the specified number in an intermediate memory. The settings can be recalled using the command `*RCL` with the associated number.

To transfer the stored instrument settings in a file, use the command `:MMEMory:STORe:STATe`.

Manual operation: See "Save Immediate x" on page 200

***SRE** <Contents>

Service request enable

Sets the service request enable register to the indicated value. This command determines under which conditions a service request is triggered.

Parameters:

<Contents> Contents of the service request enable register in decimal form.
 Bit 6 (MSS mask bit) is always 0.
 Range: 0 to 255

***STB?**

Status byte query

Reads the contents of the status byte in decimal form.

Usage: Query only

***TRG**

Trigger

Triggers all actions waiting for a trigger event. In particular, *TRG generates a manual trigger signal. This common command complements the commands of the TRIGger subsystem.

Usage: Event

***TST?**

Self-test query

Initiates self-tests of the instrument and returns an error code.

Return values:

<ErrorCode> **integer > 0 (in decimal format)**
 An error occurred.
 (For details, see the Service Manual supplied with the instrument).
 0
 No errors occurred.

Usage: Query only

***WAI**

Wait to continue

Prevents servicing of the subsequent commands until all preceding commands have been executed and all signals have settled (see also command synchronization and *OPC).

Usage: Event

12.4 Preset Commands

The preset commands are not bundled in one subsystem. Therefore, they are listed separately in this section.

Four presetting actions are available:

- Activating the default state of all internal instrument functions (*RST on page 324). Functions that concern the integration of the instrument into a measurement setup are not changed, e.g. GPIB address or reference oscillator source settings.
- Activating the preset state of the parameters related to the selected signal path (:SOURce<hw>:PRESet on page 326)
- Activating the preset state of all parameters that are not related to the signal path (:DEVIce:PRESet on page 326)
- Activating the original state of delivery (factory reset, :SYSTem:FPRreset on page 327). Only functions that are protected by a password remain unchanged as well as the passwords themselves.



When resetting, the following deviation between remote and manual control exists:

In contrast to the [Preset] key, the SCPI commands *RST and :SYSTem:PRESet do not close open dialogs in the GUI.

:DEVIce:PRESet.....	326
:SOURce<hw>:PRESet.....	326
:SYSTem:PRESet.....	327
:SYSTem:FPRreset.....	327

:DEVIce:PRESet

Presets all parameters which are not related to the signal path, including the LF generator.

Example: DEV:PRES
Presets all instruments settings that are not related to the signal path.

Usage: Event

:SOURce<hw>:PRESet

Presets all parameters which are related to the selected signal path.

Example: `SOUR:PRES`
Presets all settings that are related to signal path

Usage: Event

:SYSTem:PRESet

Triggers an instrument reset. It has the same effect as:

- The [Preset] key.
However, the command does not close open GUI dialogs like the key does.
- The `*RST` command

For an overview of the settings affected by the preset function, see [Table 9-1](#)

Example: `SYST:PRES`
All instrument settings (also the settings that are not currently active) are reset to their default values.

Usage: Setting only

Manual operation: See "[Preset](#)" on page 194

:SYSTem:FPReset

Triggers an instrument reset to the original state of delivery.

Example: `SYST:FPR`
All instrument settings (also the settings that are not currently active) are reset to the factory values.

Usage: Event

Manual operation: See "[Execute Factory Preset](#)" on page 194

12.5 MMEMory Subsystem

The `MMEMory` subsystem (Mass MEMory) contains the commands for managing files and directories as well as for loading and storing complete instrument settings in files.

Mass storage location

Without any additional measures, the R&S SMB100B stores user files on the internal memory or if connected, on a memory stick.

Both, the user directory `/var/user/` on the internal memory or the `/usb/` directory on the memory stick, can be used to **preserve** user-defined data. Any directory structure can be created.

The `/var/volatile` directory serves as a RAM drive and can be used to protect sensitive information. The data is available **temporarily**.

Default storage location

The R&S SMB100B stores user data in the user directory.

In the file system, user directory is always indicated as `/var/user/`.

In manual control, you access this directory via the "File Manager", see [Chapter 9.8, "Using the File Manager"](#), on page 205. In remote control, you can query it with the command `:SYSTEM:MMEMory:PATH:USER?`.

To query and change the default directory used for mass storage, use the command `:MMEMory:CDIRectory`.

12.5.1 File Naming Conventions

To enable files to be used in different file systems, consider the following file naming conventions:

- The *filename* can be of any length and *is case-sensitive*, i.e. it is distinguished between uppercase and lowercase letters.
- All letters and numbers are permitted (numbers are, however, not permitted at the beginning of the filename).
- Avoid using special characters.
- Do not use slashes "\" and "/". These symbols are used in file paths.
- Avoid using the following filenames: CLOCK\$, CON, COM1 to COM4, LPT1 to LPT3, NUL or PRN
They are reserved by the operating system.

File extension

The file and the optional file *extension* are separated by a period sign. The R&S SMB100B distinguishes the files according to their extensions; each type of file is assigned a specific file content and hence a specific file extension. Refer to [Chapter A.3, "Extensions for User Files"](#), on page 581 for an overview of the supported file extensions.

Wildcards

The two characters "*" and "?" function as "wildcards", i.e. they are used for selecting several files. The "?" character represents exactly one character, while the "*" character represents all characters up to the end of the filename. "*.*" therefore represents all files in a directory.

Filename and file path

When used in remote control commands, the parameter `<filename>` is specified as a string parameter with quotation marks. It can contain either the complete path including the root user directory `/var/user` and filename, or only the filename. The filename must include the file extension. The same applies for the directory `/var/volatile` and for the parameters `<directory_name>` and `<path>`.

Depending on how much information is provided, the values specified in the parameter or with the command `MMEM:CDIR` are used for the path and drive setting in the commands.

12.5.2 Accessing Files in the Default or in a Specified Directory

For better overview and easy file handling, you may not save all user files in the user directory `/var/user` but rather organize them into subdirectories.

The command syntax defines two general ways to access files with user data in a *specific* directory:

- **Change the current default directory** for mass memory storage and then directly access the files in this default directory, like stored list files, files with user data or save/recall files.
The subsequent commands for file handling (select, delete, read out files in the directory, etc.) require only specification of the filename. File extension can be omitted; after syntax evaluation of the used command, the R&S SMB100B filters out the relevant files.
- Define the **absolute file path**, including the user directory `/var/user`, created subdirectories and filename (see [Example "Load file with user data from a specific directory"](#) on page 329).
As a rule, whenever an absolute file path is determined, it overwrites a previously specified default directory.

The following example explains this rule as a principle. Exceptions of this general rule are stated in the description of the corresponding command. The [Chapter 12.5.3, "Programming Examples"](#), on page 330 explains the general working principle with the commands for mass memory storage.

The same rule applies to the `/var/volatile` directory, see [Example "Working with files in the volatile memory"](#) on page 331.

Example: Load file with user data from a specific directory

This example shows the principle of file handling in remote environment by using list commands. Working with the files of other subsystems is analogical. We assume that the directory `/var/user/my_files` is existing and contains the files `list_test.lsw` and `list_2.lsw`.

```
//Query files in the user diectory
SOURCE1:LIST:CATalog?
// -
// no files

// Set the default directory
MMEMory:CDIRectory "/var/user/my_files"
SOURCE1:LIST:CATalog?
// "list_test","list_2"
```

```
// Specify the complete path to select a list file (*.lsw)
// in the specific directory
SOURCEl:LIST:SElect "/var/user/my_files/list_test"
SOURCEl:LIST:DElete "/var/user/my_files/list_2"
```

12.5.3 Programming Examples

Example: Storing and loading current settings

This example shows two ways of how to store the current instrument setting in the file `settings.savrcltxt` in the directory `/var/user/savrcl`.



Before the instrument settings can be stored in a file, they have to be stored in an intermediate memory using common command `*SAV <number>`. The specified number is then used in the `:MMEMory:STORe:STATe` command.

Also, after loading a file with instrument settings with command `:MMEMory:LOAD:STATe`, these settings have to be activated with the common command `*RCL <number>`.

```
// Store the current settings in an intermediate memory with number 4
*SAV 4

// store the settings in a file in a specific directory;
// the complete path has to be specified
MMEMory:STORe:STATe 4,"/var/user/savrcl/settings.savrcltxt"

// store the settings in a file in the default directory;
// set the default directory; specify only the file name
MMEMory:CDIRectory "/var/user/savrcl"
*SAV 4
MMEMory:STORe:STATe 4,"settings.savrcltxt"

// Load the stored settings in the intermediate memory 4 and activate them
MMEMory:LOAD:STATe 4,"/var/user/settings.savrcltxt"
*RCL 4
```

Example: Working with files and directories

This example shows how to list files in a directory, list the subdirectories, query the number of files in a directory, create directory, rename and delete files.

```
// Query the current default directory for mass storage,
// change the directory to the default user directory "/var/user"
// and read out the files in it
MMEMory:CDIRectory?
// "/var/user/temp"
MMEMory:CDIRectory
MMEMory:CDIRectory?
```

```

// "/var/user/"
MMEMory:CATalog?
// 1282630,8102817792,".",DIR,4096","..,DIR,4096","Log,DIR,4096",
// "settings.savrc.txt,BIN,16949","temp,DIR,4096","test,DIR,4096",
// "list.lsw,BIN,1245201"
// the directory "/var/user" contains the predefined directory "Log",
// the subdirectories "test" and "temp"
// as well as the files "settings.savrc.txt" and "list.lsw"

// query only the subdirectories of the current or specified directory
MMEMory:DCATalog? "/var/user"
// ".", "..", "Log", "temp", "test"

// query only number of subdirectories in the current or specified directory
MMEMory:DCATalog:LENGth? "/var/user"
// 5

// query number of files in the current or specified directory
MMEMory:CATalog:LENGth? "/var/user"
// 7

// Create a new directory for mass memory storage in the specified directory
MMEMory:MDIRectory "/var/user/new"

// Copy the file "settings.savrc.txt" into the new directory
MMEMory:COPIY "/var/user/settings.savrc.txt","/var/user/new/settings.savrc.txt"

// Rename the file "settings.savrc.txt" into the new directory
// and read out the files in this specific directory
MMEMory:CDIRectory "/var/user/new"
MMEMory:MOVE "settings.savrc.txt","settings_new.savrc.txt"
MMEMory:CATalog? "/var/user/new"
// 25141,8102789120,".",DIR,4096","..,DIR,4096","settings_new.savrc.txt,BIN,16949"

// Delete the "test" directory
MMEMory:RDIRectory "/var/user/test"

```

Example: Working with files in the volatile memory

This example shows how to work with files in the `/var/volatile` directory.

```

// Change the default directory for mass storage,
// read out the files, load and play a file with the ARB
MMEMory:CDIRectory "/var/volatile"
MMEMory:CDIRectory?
// "/var/volatile"
MMEMory:CATalog?
//13928,525352960,".",DIR,60","..,DIR,4096","list.lst,BIN,9772"

:SOURce1:LIST:SElect "/var/volatile/list"

```

```
:SOURce1:FREQuency:MODE LIST
:OUTPut1:STATe 1
```

12.5.4 Remote Control Commands

:MMEMory:CATalog?	332
:MMEMory:CATalog:LENGth?	333
:MMEMory:CDIRectory	333
:MMEMory:COpy	333
:MMEMory:DATA	334
:MMEMory:DCATalog?	334
:MMEMory:DCATalog:LENGth?	335
:MMEMory:DELeTe	335
:MMEMory:LOAD:STATe	335
:MMEMory:MDIRectory	336
:MMEMory:MOVE	336
:MMEMory:MSIS	336
:MMEMory:RDIRectory	336
:MMEMory:STORe:STATe	337
:MEMory:HFRee?	337

:MMEMory:CATalog? <path>

Returns the content of a particular directory.

Query parameters:

<path>	string
--------	--------

String parameter to specify the directory.
If you leave out the path, the command returns the contents of the directory selected with `:MMEMory:CDIRectory`.
The path may be relative or absolute.

Return values:

<UsedDiskSpace>	Byte size of all files in the directory.
<FreeDiskSpace>	Remaining disk space in bytes.
<FileInfo>	<NameFileN>,<SuffixFileN>,<SizeFileN>

List of files, separated by commas

<NameFileN>
Name of the file.

<SuffixFileN>
Type of the file. Possible suffixes are: ASCii, BINary, DIRectory

<SizeFileN>
Size of the file in bytes.

Usage: Query only

Manual operation: See "Directory, File List and Filename" on page 199

:MMEMory:CATalog:LENGth? <Path>

Returns the number of files in the current or in the specified directory.

Query parameters:

<Path>	string
---------------------	--------

String parameter to specify the directory. If the directory is omitted, the command queries the content of the current directory, queried with [:MMEMory:CDIRectory](#) command.

Return values:

<FileCount>	integer
--------------------------	---------

Number of files.

Usage:	Query only
---------------	------------

:MMEMory:CDIRectory <Directory>

Changes the default directory for mass memory storage. The directory is used for all subsequent `MMEM` commands if no path is specified with them.

Parameters:

<Directory>	<directory_name>
--------------------------	-------------------------------

String containing the path to another directory. The path can be relative or absolute.
To change to a higher directory, use two dots '..'.

Usage:	SCPI confirmed
---------------	----------------

Manual operation:	See "Directory, File List and Filename" on page 199 See "Directory and Filename" on page 207
--------------------------	---

:MMEMory:COpy <SourceFile>[,<DestinationFile>]

Copies an existing file to a new file. Instead of just a file, this command can also be used to copy a complete directory together with all its files.

Setting parameters:

<SourceFile>	string
---------------------------	--------

String containing the path and file name of the source file

<DestinationFile>	string
--------------------------------	--------

String containing the path and name of the target file. The path can be relative or absolute.
If **<DestinationFile>** is not specified, the **<SourceFile>** is copied to the current directory, queried with the [:MMEMory:CDIRectory](#) command.

Note: Existing files with the same name in the destination directory are overwritten without an error message.

Usage:	Setting only SCPI confirmed
---------------	--------------------------------

Manual operation: See "Cut, Copy&Paste and Delete" on page 207

:MMEMory:DATA <Filename>, <BinaryBlock>
:MMEMory:DATA? <Filename>

The setting command writes the block data <BinaryBlock> to the file identified by <Filename>.

Tip: Use this command to read/transfer stored instrument settings or waveforms directly from/to the instrument.

Parameters:

<BinaryBlock> #<number><length_entry><data>
 #: Hash sign; always comes first in the binary block
 <number>: the first digit indicates how many digits the subsequent length entry has
 <length_entry>: indicates the number of subsequent bytes
 <data>: binary block data for the specified length.
 For files with a size with more than nine digits (gigabytes), the instrument allows the syntax # (<Length>), where <Length> is the file size in decimal format.

Parameters for setting and query:

<Filename> string
 String parameter to specify the name of the file.

Example: `MMEMory:DATA '/var/user/test.txt',#15hallo`
 Writes the block data to the file `test.txt`.
 The digit 1 indicates a length entry of one digit; the digit 5 indicate a length of the binary data (`hallo`) in bytes.
`MMEMory:DATA? '/var/user/test.txt'`
 Sends the data of the file `test.txt` from the instrument to the controller in the form of a binary block.
 Response: `#15hallo`

Usage: SCPI confirmed

:MMEMory:DCATalog? <path>

Returns the subdirectories of a particular directory.

Query parameters:

<path> String parameter to specify the directory. If the directory is omitted, the command queries the content of the current directory, queried with `:MMEMory:CDIRectory` command.

Return values:

<Catalog> <file_entry>
 Names of the subdirectories separated by colons. The first two strings are related to the parent directory.

Usage: Query only

:MMEMory:DCATalog:LENGth? [<Path>]

Returns the number of subdirectories in the current or specified directory.

Query parameters:

<Path> String parameter to specify the directory. If the directory is omitted, the command queries the contents of the current directory, to be queried with `:MMEMory:CDIRectory` command.

Return values:

<DirectoryCount> integer
Number of parent and subdirectories.

Usage: Query only

:MMEMory:DELeTe <Filename>

Removes a file from the specified directory.

Setting parameters:

<Filename> string
String parameter to specify the name and directory of the file to be removed.

Usage: Event
SCPI confirmed

Manual operation: See "[Cut, Copy&Paste and Delete](#)" on page 207

:MMEMory:LOAD:STATe <SavRclStateNumb>, <file_name>

Loads the specified file stored under the specified name in an internal memory.

After the file has been loaded, the instrument setting must be activated using an `*RCL` command.

Setting parameters:

<SavRclStateNumb> Determines to the specific <number> to be used with the `*RCL` command, e.g. `*RCL 4`.

<file_name> String parameter to specify the file name with extension `*.savrcltxt`.

Usage: Setting only

Manual operation: See "[Recall](#)" on page 201

:MMEMory:MDIRectory <Directory>

Creates a subdirectory for mass memory storage in the specified directory. If no directory is specified, a subdirectory is created in the default directory. This command can also be used to create a directory tree.

Setting parameters:

<Directory> string
 String parameter to specify the new directory.

Usage: Event

Manual operation: See "[Create New Directory](#)" on page 207

:MMEMory:MOVE <SourceFile>, <DestinationFile>

Moves an existing file to a new location or, if no path is specified, renames an existing file.

Setting parameters:

<SourceFile> string
 String parameter to specify the name of the file to be moved.

<DestinationFile> string
 String parameters to specify the name of the new file.

Usage: Event
 SCPI confirmed

Manual operation: See "[Rename](#) " on page 207

:MMEMory:MSIS <Msis>

Defines the drive or network resource (in the case of networks) for instruments with windows operating system, using `msis` (MSIS = Mass Storage Identification String).

Note: Instruments with Linux operating system ignore this command, since Linux does not use drive letter assignment.

Usage: SCPI confirmed

:MMEMory:RDIRectory <Directory>

Removes an existing directory from the mass memory storage system. If no directory is specified, the subdirectory with the specified name is deleted in the default directory.

Setting parameters:

<Directory> string
 String parameter to specify the directory to be deleted.

Usage: Event

:MMEMory:STORe:STATe <savrcl_state_nr>, <file_name>

Stores the current instrument setting in the specified file.

The instrument setting must first be stored in an internal memory with the same number using the common command *SAV.

Setting parameters:

<savrcl_state_nr> Corresponds to the specific <number> defined with the *SAV command, e.g. *SAV 4.

<file_name> String parameter to specify the file name with extension *.savrcltxt.

Usage: Event

Manual operation: See "Save" on page 200

:MEMory:HFRee?

Returns the used and available memory in Kb.

Return values:

<TotalPhysMemKb> integer
Total physical memory.

<ApplicMemKb> integer
Application memory.

<HeapUsedKb> integer
Used heap memory.

<HeapAvailableKb> integer
Available heap memory.

Usage: Query only

12.6 CALibration Subsystem

The CALibration subsystem contains the commands needed for performing internal adjustments. This procedure is triggered by the query commands.

Suffix <hw>

Suffix	Value range	Description
CALibration<hw>	[1]	Optional suffix

Understanding the query response

- 0: error-free execution of the adjustments

- 1: indicates that an error occurred; the process has been canceled

:CALibration:ALL[:MEASure]?	338
:CALibration<hw>:ALL:DATE?	338
:CALibration<hw>:ALL:INFormation?	338
:CALibration<hw>:ALL:TEMP?	339
:CALibration<hw>:ALL:TIME?	339
:CALibration:DATA:FACTory:DATE?	339
:CALibration<hw>:CONTInueonerror	340

:CALibration:ALL[:MEASure]? [<Force>]

Starts all internal adjustments that do not need external measuring equipment.

Query parameters:

<Force> string

Return values:

<Measure> 0 | 1 | OFF | ON

Example:

```
CAL:ALL:MEAS?
// 0
// Executes the adjustments of all instrument functions.
// When completed, it indicates that the adjustment
// has been performed successfully.
```

Usage: Query only

Manual operation: See "[Adjust All](#)" on page 550

:CALibration<hw>:ALL:DATE?

Queries the date of the most recently executed full adjustment.

Suffix:

<hw> [1]
Optional suffix

Return values:

<Date> string

Example:

```
CAL:ALL:DATE?
// "2016-01-01"
```

Usage: Query only

Manual operation: See "[Last Full Adjustment](#)" on page 550

:CALibration<hw>:ALL:INFormation?

Queries the current state of the internal adjustment.

Return values:

<CallInfoText> string

Example: `CAL:ALL:INF?`
 "Instrument is calibrated, no adjustment required."
 "UNCAL, instrument is warming up."
 "UNCAL, Please perform full adjustment after warming up."
 "UNCAL, Please perform full adjustment."

Usage: Query only

Manual operation: See ["Information"](#) on page 551

:CALibration<hw>:ALL:TEMP?

Queries the temperature deviation compared to the calibration temperature.

Suffix:
 <hw> [1]
 Optional suffix

Return values:
 <Temperature> string

Example: `CALibration:ALL:TEMP?`
 // "+12.00 K"

Usage: Query only

Manual operation: See ["Temperature Offset"](#) on page 551

:CALibration<hw>:ALL:TIME?

Queries the time elapsed since the last full adjustment.

Return values:
 <Time> string

Example: `CAL:ALL:TIME?`
 // "22 days"

Usage: Query only

Manual operation: See ["Time"](#) on page 550

:CALibration:DATA:FACTory:DATE?

Queries the date of the last factory calibration.

Return values:
 <Date> string

Example: `CAL:DATA:FACT:DATE?`
 // "2016-01-01"

Usage: Query only

Manual operation: See ["Last Factory Calibration"](#) on page 537

:CALibration<hw>:CONTinueonerror <State>

Continues the calibration even though an error was detected. By default adjustments are aborted on error.

Suffix:

<hw> [1]
Optional suffix

Parameters:

<State> 0 | 1 | OFF | ON
*RST: n.a. (factory preset: 0)

Example:

```
CAL:CONT ON
// Continues calibration after an error
```

Manual operation: See "[Continue Adjustment on Error](#)" on page 551

12.7 DIAGnostic Subsystem

The `DIAGnostic` subsystem contains the commands used for instrument diagnosis and servicing. SCPI does not define any `DIAGnostic` commands; the commands listed here are all device-specific. All `DIAGnostic` commands are query commands which are not affected by `*RST`.



The test functions are intended for services purposes.

They are thus password-protected functions. Unlock the corresponding protection level to access them, see `:SYSTem:PROTect<ch>[:STATe]`

For more information, see R&S SMB100B Service Manual.

Common suffixes

The following common suffixes are used in remote commands:

Suffix	Value range	Description
DIAGnostic<hw>	[1]	Optional suffix

Example: Programming example

The example lists the commands required to query assemblies and test points for diagnosis purposes.

```
// Query the modules available in the instrument
// and variant and revision state of a certain assembly
DIAGnostic1:BGInfo:CATalog?
// FRONT_AF,PSU300,IFB.BV,MB2_AF,...
DIAGnostic1:BGInfo? "PSU300"
// PSU300 2118.2067.02 01.00 100000

// Query the test points available in the instrument
// and trigger the measurement in a selected test point
DIAGnostic1:POINt:CATalog?
// ATT6HP_AF_DET_N,ATT6HP_AF_DET_P,ATT6HP_AF_DET_TEMP...
DIAGnostic1:MEASure:POINt? "ATT6HP_AF_DET_N"
// 0.000000V

// Query the operating hours and number of power-on so far.
DIAGnostic:INFO:OTIME?
// 112 h
DIAGnostic:INFO:POCount?
// 14
```

:DIAGnostic<hw>:BGInfo:CATalog?	341
:DIAGnostic<hw>:BGInfo?	341
:DIAGnostic:INFO:OTIME?	342
:DIAGnostic:INFO:POCount?	342
:DIAGnostic<hw>:POINt:CATalog?	343
:DIAGnostic<hw>[:MEASure]:POINt?	343

:DIAGnostic<hw>:BGInfo:CATalog?

Queries the names of the assemblies available in the instrument.

Return values:

<Catalog> string
 List of all assemblies; the values are separated by commas
 The length of the list is variable and depends on the instrument
 equipment configuration.

Example: See [Example "Programming example"](#) on page 341.

Usage: Query only

:DIAGnostic<hw>:BGInfo? [<Board>]

Queries information on the modules available in the instrument, using the variant and revision state.

Query parameters:

<Board> string
 Module name, as queried with the command :
[DIAGnostic<hw>:BGInfo:CATalog?](#).
 To retrieve a complete list of all modules, omit the parameter.
 The length of the list is variable and depends on the instrument equipment configuration.

Return values:

<BgInfo> <Module name> <Module stock number incl. variant> <Module revision> <Module serial number>
 List of comma-separated entries, one entry per module.
 Each entry for one module consists of four parts that are separated by space characters.

Example: See [Example "Programming example"](#) on page 341.

Usage: Query only

Manual operation: See ["Assembly"](#) on page 536

:DIAGnostic:INFO:OTIME?

Queries the operating hours of the instrument so far.

Return values:

<OperationTime> integer
 Range: 0 to INT_MAX
 *RST: 0

Example: See [Example "Programming example"](#) on page 341.

Usage: Query only

Manual operation: See ["Operation Time / h"](#) on page 537

:DIAGnostic:INFO:POCount?

Queris how often the instrument has been turned on so far.

Return values:

<PowerOnCount> integer
 Range: 0 to INT_MAX
 *RST: 0

Example: See [Example "Programming example"](#) on page 341.

Usage: Query only

Manual operation: See ["Power On Count"](#) on page 537

:DIAGnostic<hw>:POINT:CATalog?

Queries the test points available in the instrument.

For more information, see R&S SMB100B Service Manual.

Return values:

<Catalog> string
List of comma-separated values, each representing a test point

Example: See [Example "Programming example"](#) on page 341.

Usage: Query only

:DIAGnostic<hw>[:MEASure]:POINT? <Name>

Triggers the voltage measurement at the specified test point and returns the measured voltage.

For more information, see R&S SMB100B Service Manual.

Query parameters:

<Name> <test point identifier>
Test point name, as queried with the command :
[DIAGnostic<hw>:POINT:CATalog?](#)

Return values:

<Value> <value><unit>

Example: See [Example "Programming example"](#) on page 341.

Usage: Query only

12.8 DISPlay Subsystem

The DISPlay system contains the commands to set the power-save mode of the instrument.

Programming Examples

Example: Activating screen saver mode and display update

Use the following commands to switch on the screen saver of your instrument or to automatic display. These settings are particularly useful when you control the instrument remotely.

```
// Set the wait time interval and activate the screen saver
:DISPlay:PSAVE:HOLDoff 10
:DISPlay:PSAVE:STATe ON

// Disable the display of the current frequency and level values in remote control
:DISPlay:ANNotation:ALL ON
```

```
// :DISPlay:ANNotation:FREQuency ON
// :DISPlay:ANNotation:AMPLitude ON

// Enable automatic update of the display at defined time intervals
:DISPlay:UPDate ON
```

Example: Querying the dialog IDs, opening and closing dialogs

Use the following commands to query the dialog IDs of all currently open dialogs. The dialog ID is a prerequisite for opening and closing dialogs via the remote control.



The dialog ID is also required to define user key actions.

See [Chapter 10.2.4, "How to Assign Actions to the \[★ \(User\)\] Key"](#), on page 235.

```
// Query the dialog IDs of all open dialogs
:DISPlay:DIALog:ID?
// CEUltraDLGenSetDlg,_, $A DlgKeyRf_Rosc

// Open and close dialogs via remote control
:DISPlay:DIALog:OPEN "CEUltraDLGenSetDlg,_, $A"
:DISPlay:DIALog:OPEN "DlgKeyRf_Rosc"
:DISPlay:DIALog:CLOSe "DlgKeyRf_Rosc"
:DISPlay:DIALog:CLOSe:ALL

:DISPlay:PSAVE:HOLDoff..... 344
:DISPlay:PSAVE[:STATe]..... 345
:DISPlay:BRIGHtness..... 345
:DISPlay:BUTTon:BRIGHtness..... 345
:DISPlay:UPDate..... 345
:DISPlay:ANNotation:AMPLitude..... 346
:DISPlay:ANNotation:FREQuency..... 346
:DISPlay:ANNotation[:ALL]..... 346
:DISPlay:DIALog:ID?..... 346
:DISPlay:DIALog:OPEN..... 347
:DISPlay:DIALog:CLOSe..... 347
:DISPlay:DIALog:CLOSe:ALL..... 348
```

:DISPlay:PSAVE:HOLDoff <HoldoffTimeMin>

Sets the wait time for the screen saver mode of the display.

Parameters:

<HoldoffTimeMin> integer
 Range: 1 to 60
 *RST: n.a. (factory preset: 10)
 Default unit: minute

Example: see [Example "Activating screen saver mode and display update"](#)
 on page 343

Manual operation: See ["Wait Time"](#) on page 226

:DISPlay:PSAVe[:STATe] <State>

Activates the screen saver mode of the display.

We recommend that you use this mode to protect the display, if you operate the instrument in remote control.

To define the wait time, use the command `:DISPlay:PSAVe:HOLDoff`.

Parameters:

<State> 0 | 1 | OFF | ON
*RST: n.a. (factory preset: 0)

Example: See [Example "Activating screen saver mode and display update"](#) on page 343

Manual operation: See ["Screen Saver"](#) on page 226

:DISPlay:BRIGhtness <BRIGhtness>

Sets the brightness of the display.

Parameters:

<BRIGhtness> float
Range: 1.0 to 20.0
Increment: 1.0
*RST: 14.0

Example: `DISPlay:BRIGhtness 14`

Manual operation: See ["Display"](#) on page 226

:DISPlay:BUtTon:BRIGhtness <ButtonBrightness>

Sets the brightness of the [RF on/off] key.

Parameters:

<ButtonBrightness> integer
Range: 1 to 20
*RST: n.a. (no preset. default: 14)

Example: `DISPlay:BUtTon:BRIGhtness 15`

Manual operation: See ["RF Hardkey"](#) on page 226

:DISPlay:UPDate <Update>

Activates the refresh mode of the display.

Parameters:

<Update> 0 | 1 | OFF | ON
*RST: n.a. (factory preset: 1)

Example: See [Example "Activating screen saver mode and display update"](#) on page 343

Manual operation: See ["Display Update is"](#) on page 227

:DISPlay:ANNOtation:AMPLitude <State>

Indicates asterisks instead of the level values in the status bar.

Parameters:

<State> 0 | 1 | OFF | ON
 *RST: n.a. (factory preset: 1)

Example: See [Example "Activating screen saver mode and display update"](#) on page 343

Manual operation: See ["Annotation Amplitude"](#) on page 246

:DISPlay:ANNOtation:FREQuency <State>

Indicates asterisks instead of the frequency values in the status bar.

Parameters:

<State> 0 | 1 | OFF | ON
 *RST: n.a. (factory preset: 1)

Example: See [Example "Activating screen saver mode and display update"](#) on page 343

Manual operation: See ["Annotation Frequency"](#) on page 246

:DISPlay:ANNOtation[:ALL] <State>

Displays asterisks instead of the level and frequency values in the status bar of the instrument.

We recommend that you use this mode if you operate the instrument in remote control.

Parameters:

<State> 0 | 1 | OFF | ON
 *RST: 1

Example: See [Example "Activating screen saver mode and display update"](#) on page 343

:DISPlay:DIALog:ID?

Returns the dialog identifiers of the open dialogs in a string separated by blanks.

Return values:

<DialogIdList> <DialogID#1>< ><DialogID#2>< > ... < ><DialogID#n>

Dialog identifiers are string without blanks. Blanks are represented as \$\$.

Dialog identifiers <DialogID> are composed of two main parts: <DialogName> [<OptionalParts>]

<DialogName>

Meaningful information, mandatory input parameter for the commands:

:DISPlay:DIALog:OPEN on page 347

:DISPlay:DIALog:CLOSe on page 347

<Optional parts>

String of \$<X> values, where <X> is a character, interpreted as follows:

\$q<DialogQualifier>: optional dialog qualifier, usually the letter A or B, as displayed in the dialog title.

\$i<Instances>: comma-separated list of instance indexes, given in the order h, c, s, d, g, u, 0. Default is zero; the terminating ", 0" can be omitted.

\$t<TabIds>: comma-separated indexes or tab names; required, if a dialog is composed of several tabs.

\$x<Left>\$y<Top>\$h<Left>\$w<Top>: position and size; superfluous information.

Example: See [Example "Querying the dialog IDs, opening and closing dialogs"](#) on page 344

Usage: Query only

Manual operation: See ["SCPI"](#) on page 234

:DISPlay:DIALog:OPEN <DialogId>

Opens the specified dialog.

Setting parameters:

<DialogId> string

To find out the dialog identifier, use the query [:DISPlay:DIALog:ID?](#).

The <DialogName> part of the query result is mandatory.

Example: See [Example "Querying the dialog IDs, opening and closing dialogs"](#) on page 344

Usage: Setting only

Manual operation: See ["SCPI"](#) on page 234

:DISPlay:DIALog:CLOSe <DialogId>

Closes the specified dialog.

Setting parameters:

<DialogId> string
 To find out the dialog identifier, use the query `:DISPlay:DIALog:ID?`.
 The <DialogName> part of the query result is sufficient.

Example: See [Example "Querying the dialog IDs, opening and closing dialogs"](#) on page 344

Usage: Setting only

:DISPlay:DIALog:CLOSE:ALL

Closes all open dialogs.

Example: See [Example "Querying the dialog IDs, opening and closing dialogs"](#) on page 344

Usage: Event

12.9 FORMat Subsystem

The commands in the FORMat subsystem determine the format of data returned by the R&S SMB100B to the controller. This affects all query commands that return a list of numerical data or block data, noted in the descriptions of the commands. The set data format applies to both paths.

:FORMat:BORDER	348
:FORMat:SREGister	349
:FORMat[DATA]	349

:FORMat:BORDER <Border>

Determines the sequence of bytes within a binary block. This only affects blocks which use the IEEE754 format internally.

Parameters:

<Border> NORMal | SWAPped

NORMal
 Expects/sends the *least* significant byte of each IEEE754 floating-point number first and the *most* significant byte last.

SWAPped
 Expects/sends the *most* significant byte of each IEEE754 floating-point number first and the *least* significant byte last.

*RST: NORMal

Example: FORM:BORD SWAP
 transfers the data with the most significant bit first.

:FORMat:SREGister <Format>

Determines the numeric format for responses of the status register.

Parameters:

<Format> ASCII | BINary | HEXadecimal | OCTal

ASCII

Returns the register content as a decimal number.

BINary|HEXadecimal|OCTal

Returns the register content either as a binary, hexadecimal or octal number. According to the selected format, the number starts with #B (binary), #H (hexadecimal) or #O (octal).

*RST: ASCII

Example:

FORM:SREG HEX

returns the register content as a hexadecimal number.

:FORMat[:DATA] <Data>

Determines the data format the instrument uses to return data via the IEC/IEEE bus.

The instrument automatically detects the data format used by the controller, and assigns it accordingly. Data format determined by this SCPI command is in this case irrelevant.

Parameters:

<Data> ASCII | PACKed

ASCII

Transfers numerical data as plain text separated by commas.

PACKed

Transfers numerical data as binary block data.

The format within the binary data depends on the command.

The various binary data formats are explained in the description of the parameter types.

*RST: ASCII

Example:

FORM ASC

transfers the data as ASCII data.

12.10 HCOPI Subsystem

The HCOPI subsystem contains the commands to generate and save a hard copy of the display.



To access a stored hard copy file, use the commands of the MEMM subsystem.

Example: Store a hard copy of the display

The following example lists commands to configure and execute a hard copy to an automatic named file.

```
:HCOPY:DEVIce:LANGUage PNG
:HCOPY:FILE:NAME:AUTO:STATe 1
// defines the output format
// sets the instrument to automatically create output file names

// *****
// Configure hard copy options, set automatic naming rules
// An automatically generated file name consists of:
// <Prefix><YYYY><MM><DD><Number>.<Format>
// *****
:HCOPY:DEVIce:LANGUage BMP
// defines output format *.bmp
:HCOPY:REGIon DIALog
// selects the region to be copied
:HCOPY:FILE:AUTO:DIR "/usb/HCopy"
// sets destination directory of automatic named file
:HCOPY:FILE:NAME:AUTO:FILE:PREFIx:STATe 1
:HCOPY:FILE:NAME:AUTO:FILE:PREFIx:"hardcopy"
:HCOPY:FILE:NAME:AUTO:FILE:YEAR:STATe 1
:HCOPY:FILE:NAME:AUTO:FILE:MONTh:STATe 1
// uses automatic naming prefix
// sets automatic naming prefix to "hardcopy"
// uses automatic naming date parameters year and month

// *****
// Execute and transfer the hard copy
// *****
:HCOPY:EXECute
:HCOPY:DATA
// generates a hard copy
// transfers the hard copy to the remote client
:HCOPY:FILE:AUTO:FILE?
// queries the automatic file name
// "hardcopy1607001.bmp"
:HCOPY:FILE:AUTO:NUMBer?
// queries the number in the automatic file name
// "001"
:HCOPY:FILE:AUTO?
// queries the path and file name of the automatically generated file
// "/usb/HCopy/hardcopy1607001.bmp"
```

12.10.1 Hard Copy Settings

With the following commands, you can configure the settings of a hard copy.

:HCOPY:DATA?.....	351
:HCOPY:IMAGe:FORMat.....	351
:HCOPY:DEVIce:LANGUage.....	351
:HCOPY:REGion.....	351
:HCOPY:FILE[:NAME].....	351
:HCOPY[:EXECute].....	352

:HCOPY:DATA?

Transfers the hard copy data directly as a NByte stream to the remote client.

Return values:

<Data> block data

Example: See [Example "Store a hard copy of the display"](#) on page 350

Usage: Query only

:HCOPY:IMAGe:FORMat <Format>

:HCOPY:DEVIce:LANGUage <Language>

Selects the graphic format for the hard copy. You can use both commands alternatively.

Parameters:

<Language> BMP | JPG | XPM | PNG

*RST: PNG

Example: See [Example "Store a hard copy of the display"](#) on page 350

Manual operation: See ["Format"](#) on page 219

:HCOPY:REGion <Region>

Selects the area to be copied.

You can create a snapshot of the screen or an active dialog.

Parameters:

<Region> ALL | DIALog

*RST: ALL

Example: See [Example "Store a hard copy of the display"](#) on page 350

Manual operation: See ["Region"](#) on page 220

:HCOPY:FILE[:NAME] <Name>

Determines the file name and path to save the hard copy, provided automatic naming is disabled.

Note: If you have enabled automatic naming, the instrument automatically generates the file name and directory, see [Chapter 12.10.2, "Automatic Naming"](#), on page 352.

Parameters:

<Name> string

Example: See [Example "Store a hard copy of the display"](#) on page 350

Manual operation: See ["File..."](#) on page 219

:HCOPY[:EXECute]

Generates a hard copy of the current display. The output destination is a file.

Example: See [Example "Store a hard copy of the display"](#) on page 350

Usage: Event

Manual operation: See ["Save"](#) on page 219

12.10.2 Automatic Naming

Use the following commands to automatically assign a file name.

:HCOPY:FILE[:NAME]:AUTO?	352
:HCOPY:FILE[:NAME]:AUTO:DIRectory	352
:HCOPY:FILE[:NAME]:AUTO:DIRectory:CLear	353
:HCOPY:FILE[:NAME]:AUTO:FILE?	353
:HCOPY:FILE[:NAME]:AUTO:STATe	353
:HCOPY:FILE[:NAME]:AUTO[:FILE]:DAY:STATe	353
:HCOPY:FILE[:NAME]:AUTO[:FILE]:MONTh:STATe	353
:HCOPY:FILE[:NAME]:AUTO[:FILE]:YEAR:STATe	353
:HCOPY:FILE[:NAME]:AUTO[:FILE]:NUMBer?	354
:HCOPY:FILE[:NAME]:AUTO[:FILE]:PREFix	354
:HCOPY:FILE[:NAME]:AUTO[:FILE]:PREFix:STATe	354

:HCOPY:FILE[:NAME]:AUTO?

Queries path and file name of the hardcopy file, if you have enabled *Automatic Naming*.

Return values:

<Auto> string

Example: See [Example "Store a hard copy of the display"](#) on page 350

Usage: Query only

:HCOPY:FILE[:NAME]:AUTO:DIRectory <Directory>

Determines the path to save the hard copy, if you have enabled *Automatic Naming*.

If the directory does not yet exist, the instrument automatically creates a new directory, using the instrument name and `/var/user/` by default.

Parameters:

<Directory> string
 *RST: /var/user/

Example: See [Example "Store a hard copy of the display"](#) on page 350

Manual operation: See ["Path..."](#) on page 221

:HCOPY:FILE[:NAME]:AUTO:DIRectory:CLEar

Deletes all files with extensions *.bmp, *.jpg, *.png and *.xpm in the directory set for automatic naming.

Example: See [Example "Store a hard copy of the display"](#) on page 350

Usage: Event

Manual operation: See ["Clear Path"](#) on page 221

:HCOPY:FILE[:NAME]:AUTO:FILE?

Queries the name of the automatically named hard copy file.

An automatically generated file name consists of:

<Prefix><YYYY><MM><DD><Number>.<Format>.

You can activate each component separately, to individually design the file name.

Return values:

<File> string

Example: See [Example "Store a hard copy of the display"](#) on page 350.

Usage: Query only

:HCOPY:FILE[:NAME]:AUTO:STATe <State>

Activates automatic naming of the hard copy files.

Parameters:

<State> 0 | 1 | OFF | ON
 *RST: 1

Example: See [Example "Store a hard copy of the display"](#) on page 350

Manual operation: See ["Automatic Naming"](#) on page 220

:HCOPY:FILE[:NAME]:AUTO[:FILE]:DAY:STATe <State>**:HCOPY:FILE[:NAME]:AUTO[:FILE]:MONTH:STATe <State>****:HCOPY:FILE[:NAME]:AUTO[:FILE]:YEAR:STATe <State>**

Uses the date parameters (year, month or day) for the automatic naming. You can activate each of the date parameters separately.

Parameters:

<State> 0 | 1 | OFF | ON
 *RST: 1

Example: See [Example "Store a hard copy of the display"](#) on page 350

Manual operation: See ["Prefix, Year, Month, Day"](#) on page 221

:HCOPY:FILE[:NAME]:AUTO[:FILE]:NUMBER?

Queries the number that is used as part of the file name for the next hard copy in automatic mode.

At the beginning, the count starts at 0. The R&S SMB100B searches the specified output directory for the highest number in the stored files. It increases this number by one to achieve a unique name for the new file.

The resulting auto number is appended to the resulting file name with at least three digits.

Return values:

<Number> integer
 Range: 0 to 999999
 *RST: 0

Example: See [Example "Store a hard copy of the display"](#) on page 350

Usage: Query only

Manual operation: See ["Current Auto Number"](#) on page 221

:HCOPY:FILE[:NAME]:AUTO[:FILE]:PREFIX <Prefix>**:HCOPY:FILE[:NAME]:AUTO[:FILE]:PREFIX:STATE <State>**

Uses the prefix for the automatic generation of the file name, provided `PREF:STAT` is activated.

Parameters:

<State> 0 | 1 | OFF | ON
 *RST: 1

Example: See [Example "Store a hard copy of the display"](#) on page 350

Manual operation: See ["Prefix, Year, Month, Day"](#) on page 221

12.11 KBOard Subsystem

The `KBOard` subsystem contains the commands to set a connected keyboard.

[:KBOard:LAYout](#).....355

:KBOard:LAYout <Layout>

Selects the language for an external keyboard and assigns the keys accordingly.

Parameters:

<Layout> CHINese | DANish | DUTCh | DUTBe | ENGLish | ENGUk |
 FINNish | FRENch | FREBe | FRECa | GERMan | ITALian |
 JAPAnese | KORean | NORWegian | PORTuguese | RUSSian |
 SPANish | SWEDish | ENGUS
 *RST: n.a. (factory preset: ENGLish)

Example:

```
:KBOard:LAYout US
// activates American keyboard
```

Manual operation: See "[USB Keyboard > Layout](#)" on page 226

12.12 OUTPut Subsystem

In the OUTPut subsystem, you can configure the output signals.

The LF output signal is defined with the commands of the [Chapter 12.14.5, "SOURce:LFOutput Subsystem"](#), on page 419 system.

Common suffixes

The following common suffixes are used in remote commands:

Suffix	Value range	Description
OUTPut<hw>	[1]	Optional suffix

:OUTPut:ALL[:STATe].....	355
:OUTPut<hw>[:STATe].....	356
:OUTPut<hw>[:STATe]:PON.....	356
:OUTPut<hw>:AMODE.....	356
:OUTPut<hw>:IMPedance?.....	356
:OUTPut<hw>:AFIXed:RANGe:LOWer?.....	357
:OUTPut<hw>:AFIXed:RANGe:UPPer?.....	357
:OUTPut<hw>:PROTection:CLEar.....	357
:OUTPut<hw>:PROTection:TRIPped?.....	357

:OUTPut:ALL[:STATe] <State>

Activates the RF output signal of the instrument.

Parameters:

<State> 0 | 1 | OFF | ON
 *RST: n.a. (factory preset: 0)

Example:

```
OUTPut:ALL:STATe 0
```

:OUTPut<hw>[:STATe] <State>

Activates the RF output signal.

Parameters:

<State> 0 | 1 | OFF | ON
*RST: 0

Example: OUTP ON
 Activates the RF output.

Manual operation: See "[RF State/RF ON](#)" on page 57

:OUTPut<hw>[:STATe]:PON <Pon>

Defines the state of the RF output signal when the instrument is switched on.

Parameters:

<Pon> OFF | UNCHanged
*RST: n.a. (factory preset: UNCHanged)

Example: OUTP:PON OFF
 The RF output is deactivated when the instrument is switched on.

Manual operation: See "[Power-On State](#)" on page 227

:OUTPut<hw>:AMODe <AMode>

Sets the step attenuator mode at the RF output.

Parameters:

<AMode> AUTO | FIXEd

AUTO

The step attenuator adjusts the level settings automatically, within the full variation range.

FIXEd

The step attenuator and amplifier stages are fixed at the current position, providing level settings with constant output VSWR. The resulting variation range is calculated according to the position.

*RST: AUTO

Example: SOURce:POWer:ALC:STATe 1
 OUTPut:AMODe FIXEd

Manual operation: See "[Mode](#)" on page 149

:OUTPut<hw>:IMPedance?

Queries the impedance of the RF outputs.

Return values:

<Impedance> G1K | G50 | G10K
 *RST: G50

Example:

OUTP:IMP?
 queries the impedance of RF output.
 Response: 50
 the impedance is 50 ohms

Usage: Query only

Manual operation: See "[RF output impedance](#)" on page 57

:OUTPut<hw>:AFIXed:RANGe:LOWer?**:OUTPut<hw>:AFIXed:RANGe:UPPer?**

Queries the settable minimum/maximum value in mode :OUTPut:AMODE FIXed, i.e. when the attenuator is not being adjusted.

See :OUTPut<hw>:AMODE on page 356

Return values:

<Upper> float
 Increment: 0.01
 Default unit: dBm

Example:

```
OUTPut1:AMODE FIXed
OUTPut1:AFIXed:RANGe:UPPer?
// -27
OUTPut1:AFIXed:RANGe:LOW?
// -50
```

Usage: Query only

Manual operation: See "[Level Range](#)" on page 150

:OUTPut<hw>:PROTection:CLEar

Resets the protective circuit after it has been tripped.

To define the output state, use the command :OUTPut<hw>[:STATE].

Example:

OUTP:PROT:CLE
 Resets the protective circuit of the RF output.

Usage: Event

Manual operation: See "[Overload](#)" on page 150

:OUTPut<hw>:PROTection:TRIPped?

Queries the state of the protective circuit.

Return values:

<Tripped> 0 | 1 | OFF | ON
 *RST: 0

Example:

OUTP:PROT:TRIP
 queries the state of the protective circuit of the RF output.
 Response: 0
 the protective circuit has not tripped.

Usage: Query only

Manual operation: See "[Overload](#)" on page 150

12.13 SENSEe, READ, INITiate and SLISt Subsystems

These subsystems contain the commands for configuring the power measurements with R&S NRP power sensor connected to the R&S SMB100B.



The local state is set with the `INIT` command. Switching off the local state enhances the measurement performance. Measurements results can be retrieved in local state on or off.

Sensor parameters are set with the `SENSEe` commands.

To start the measurement and retrieve the result, use the `:READ<ch>[:POWER]?` command.

Suffix	Value range	Description
SENSE<ch>	[1] to 4	Indicates the sensor Use the <code>:SLISt</code> commands to change the sensor mapping
READ<ch>	[1] to 4	Sensor assignment
INIate<hw>	[1] to 4	Sensor assignment
ELEMent<ch>	[1] to 25	Sensor mapping list

Programming examples

Example: Detecting and assigning a power sensor

```
SLISt:LIST?
// Response: "NRP33SN-V-900007-USB Legacy","NRP-Z211-900001-USB Legacy"
// list of automatically detected sensors

SLISt:SCAN:STATe 1
// searches for sensors connected in the LAN or via the USBTMC protocol

SLISt:LIST?
// Response:
// "NRP33SN-V-900007-USB Legacy","NRP-Z211-900001-USB Legacy",
// "NRP33SN-V-900005-USBTMC","NRP33SN-V-900011-LAN"
// list of automatically detected sensors
// the list can contain more entries

SLISt:ELEMent3:MAPPing SENS1
// maps the third sensor from the list to the first sensor channel

SLISt:SENSor:MAP "NRPS18S-100654-USB Legacy", SENS3
// maps the sensor directly to channel 3
```

Example: Performing a simple power measurement

Prerequisite: The sensor is connected to the instrument and mapped to the first sensor channel.

```
:INITiate1:CONTinuous ON
//Switches the continuous power measurement on

:READ1?
// Triggers the measurement and displays the results
```

Example: Performing a power measurement with a fixed filter

Prerequisite: The sensor is connected to the instrument and mapped to the first sensor channel.

```

SENSe1:SOURce RF
//Sensor measures the power of the RF signal

SENSe1:FILTer:TYPE NSRatio
//Selects fixed noise filter mode

SENSe1:FILTer:NSRatio 0.02 DB
//Sets the maximum noise component in the result to 0.02 DB

SENSe1:FILTer:NSRatio:MTIME 10
//Limits the settling time to 10 seconds.

:SENSe1:APERTure:DEFault:STATe 0
// Deactivates the default aperture time of the sensor

:SENSe1:APERTure:TIME 10e-6
// Sets the aperture time to 10 us

SENSe1:UNIT DBM
//Selects unit dBm for the measured value

:INITiate:CONTinuous ON
//Switches the continous power measurement on

:READ?
//Triggers the measurement and displays the results

```

:SLISt[:LIST]?.....	361
:SLISt:SCAN[:STATe].....	361
:SLISt:ELEMent<ch>:MAPPing.....	361
:SLISt:SENSor:MAP.....	362
:INITiate<hw>[:POWer]:CONTinuous.....	362
:READ<ch>[:POWer]?.....	362
:SENSe<ch>:UNIT[:POWer].....	363
:SENSe<ch>[:POWer]:APERTure:DEFault:STATe.....	363
:SENSe<ch>[:POWer]:APERTure:TIME.....	364
:SENSe<ch>[:POWer]:CORRection:SPDevice:SElect.....	364
:SENSe<ch>[:POWer]:CORRection:SPDevice:STATe.....	364
:SENSe<ch>[:POWer]:CORRection:SPDevice:LIST?.....	365
:SENSe<ch>[:POWer]:DISPlay:PERManent:STATe.....	365
:SENSe<ch>[:POWer]:FILTer:LENGth:AUTO?.....	365
:SENSe<ch>[:POWer]:FILTer:LENGth[:USER].....	365
:SENSe<ch>[:POWer]:FILTer:NSRatio.....	366
:SENSe<ch>[:POWer]:FILTer:NSRatio:MTIME.....	366
:SENSe<ch>[:POWer]:FILTer:SONCe.....	367
:SENSe<ch>[:POWer]:FILTer:TYPE.....	367

:SENSe<ch>[:POWer]:FREQuency.....	368
:SENSe<ch>[:POWer]:LOGGing:STATe.....	368
:SENSe<ch>[:POWer]:OFFSet.....	368
:SENSe<ch>[:POWer]:OFFSet:STATe.....	368
:SENSe<ch>[:POWer]:SNUMber?.....	369
:SENSe<ch>[:POWer]:SOURce.....	369
:SENSe<ch>[:POWer]:STATus[:DEVice]?.....	369
:SENSe<ch>[:POWer]:TYPE?.....	370
:SENSe<ch>[:POWer]:ZERO.....	370

:SLISt[:LIST]?

Returns a list of all detected sensors in a comma-separated string.

Return values:

<SensorList> String of comma-separated entries
 Each entry contains information on the sensor type, serial number and interface.
 The order of the entries does not correspond to the order the sensors are displayed in the "NRP Sensor Mapping" dialog.

Example: See [Example "Detecting and assigning a power sensor"](#) on page 359.

Usage: Query only

Manual operation: See "[Sensor Mapping List](#)" on page 167

:SLISt:SCAN[:STATe] <State>

Starts the search for R&S NRP power sensors, connected in the LAN or via the USBTMC protocol.

Parameters:

<State> 0 | 1 | OFF | ON
 *RST: 0

Example: See [Example "Detecting and assigning a power sensor"](#) on page 359.

Manual operation: See "[Scan](#)" on page 167

:SLISt:ELEMent<ch>:MAPPING <Mapping>

Assigns an entry from the [:SLISt\[:LIST\]?](#) to one of the four sensor channels.

Parameters:

<Mapping> SENS1 | SENSor1 | SENS2 | SENSor2 | SENS3 | SENSor3 |
 SENS4 | SENSor4 | UNMapped
 Sensor channel.
 *RST: UNMapped

Example: See [Example "Detecting and assigning a power sensor"](#) on page 359.

Manual operation: See "[Sensor Mapping List](#)" on page 167

:SLISt:SENSor:MAP <SensorId>, <Mapping>

Assigns a sensor directly to one of the sensor channels, using the sensor name and serial number.

To find out the the sensor name and ID, you can get it from the label of the R&S NRP, or using the command `:SLISt:SCAN[:STATe]`. This command detects all R&S NRP power sensors connected in the LAN or via 'USBTMC protocol.

Setting parameters:

<SensorId> string

<Mapping> enum

Example: See [Example "Detecting and assigning a power sensor"](#) on page 359.

Usage: Setting only

Manual operation: See "[Sensor Mapping List](#)" on page 167

:INITiate<hw>[:POWER]:CONTInuous <Continuous>

Switches the local state of the continuous power measurement by R&S NRP power sensors on and off. Switching off local state enhances the measurement performance during remote control.

The remote measurement is triggered with `:READ<ch>[:POWER]?`). This command also returns the measurement results. The local state is not affected, measurement results can be retrieved with local state on or off.

Parameters:

<Continuous> 0 | 1 | OFF | ON

*RST: 0

Example: `INIT1:CONT ON`
Switches local state of continuous power measurement on.

Manual operation: See "[State](#)" on page 172

:READ<ch>[:POWER]?

Triggers power measurement and displays the results.

Note: This command does not affect the local state, i.e. you can get results with local state on or off. For long measurement times, we recommend that you use an SRQ for command synchronization (MAV bit).

Suffix:

<ch> 1 to 3

Return values:

<Power> float or float,float

The sensor returns the result in the unit set with command :

[SENSe<ch>:UNIT\[:POWER\]](#)

Certain power sensors, such as the R&S NRP-Z81, return two values, first the value of the average level and - separated by a comma - the peak value.

Example:

SENS1:UNIT DBM

Selects unit dBm for presentation of measurement result.

READ1?

Queries the measurement result of the sensor.

-45.6246576745440230

-45.6 dBm were measured at the given frequency.

Example:

R&S NRP-Z81

READ1?

-55.62403263352178,-22.419472478812476

-55.6 dBm is the measured average level, -22.4 dBm is the measured peak level at the given frequency.

Usage:

Query only

Manual operation: See "[Level \(Peak\) / Level \(Average\)](#)" on page 172

:SENSe<ch>:UNIT[:POWER] <Power>

Selects the unit (Watt, dBm or dBµV) of measurement result display, queried with :

[READ<ch>\[:POWER\]?](#)

Parameters:

<Power> DBM | DBUV | WATT

*RST: DBM

Example:

SENS2:UNIT DBM

Selects dBm as unit for the measured value returned by command READ.

READ2?

Response: 7.34

7.34 dBm are measured by sensor 2.

Manual operation: See "[Level \(Peak\) / Level \(Average\)](#)" on page 172

:SENSe<ch>[:POWER]:APERTure:DEFault:STATe <UseDefAp>

Deactivates the default aperture time of the respective sensor.

To specify a user-defined value, use the command [:SENSe<ch>\[:POWER\]:APERTure:TIME](#) on page 364.

Parameters:

<UseDefAp> 0 | 1 | OFF | ON
 *RST: 1

Example:

See [Example "Performing a power measurement with a fixed filter"](#) on page 360.

Manual operation: See ["Default Aperture Time"](#) on page 175

:SENSe<ch>[:POWer]:APERture:TIME <ApTime>

Defines the aperture time (size of the acquisition interval) for the corresponding sensor.

Parameters:

<ApTime> float
 Range: depends on connected power sensor
 Increment: 1E-9
 *RST: depends on connected power sensor

Example:

See [Example "Performing a power measurement with a fixed filter"](#) on page 360.

Manual operation: See ["Aperture Time"](#) on page 175

:SENSe<ch>[:POWer]:CORRection:SPDevice:SELEct <Select>

Several S-parameter tables can be stored in a sensor. The command selects a loaded data set for S-parameter correction for the corresponding sensor.

Parameters:

<Select> float
 *RST: 0

Manual operation: See [" S-Parameter "](#) on page 175

:SENSe<ch>[:POWer]:CORRection:SPDevice:STATE <State>

Activates the use of the S-parameter correction data.

Note: If you use power sensors with attenuator, the instrument automatically activates the use of S-parameter data.

Parameters:

<State> 0 | 1 | OFF | ON
 *RST: 0

Example:

SENSe1:POWer:CORRection:SPDevice:STATE 1
 Activates the use of the S-parameters correction data.

Manual operation: See [" S-Parameter "](#) on page 175

:SENSe<ch>[:POWer]:CORRection:SPDevice:LIST?

Queries the list of the S-parameter data sets that have been loaded to the power sensor.

Return values:

<List> string list
*RST: 0

Usage: Query only

Manual operation: See " [S-Parameter](#) " on page 175

:SENSe<ch>[:POWer]:DISPlay:PERMANent:STATe <State>

Activates the permanent display of the measured power level results. The instrument also indicates the sensor type, the connection, the measurement source and the offset if set.

Parameters:

<State> 0 | 1 | OFF | ON
*RST: 0

Example: SENS1:POW:DISP:PERM:STAT ON
The permanent viewer is switched on.

Manual operation: See " [Permanent](#) " on page 173

:SENSe<ch>[:POWer]:FILTer:LENGth:AUTO?

Queries the current filter length in filter mode AUTO (`:SENSe<ch>[:POWer]:FILTer:TYPE`)

Return values:

<Auto> float
Range: 1 to 65536

Example: SENS1:FILT:TYPE AUTO
Selects auto filter.
SENS1:FILT:LENG:AUTO?
Queries the automatically set filter length.
Response: 1024

Usage: Query only

Manual operation: See " [Filter Length](#) " on page 174

:SENSe<ch>[:POWer]:FILTer:LENGth[:USER] <User>

Selects the filter length for `SENS:POW:FILT:TYPE USER`. As the filter length works as a multiplier for the time window, a constant filter length results in a constant measurement time (see also " [About the measuring principle, averaging filter, filter length, and achieving stable results](#) " on page 168).

The R&S NRP power sensors provide different resolutions for setting the filter length, depending on the used sensor type:

- Resolution = 1 for R&S NRPxx power sensors
- Resolution = 2^n for sensors of the R&S NRP-Zxx family, with $n = 1$ to 16

Parameters:

<User> float
 Range: 1 to 65536
 *RST: 1

Example:

```
SENS1:FILT:TYPE USER
Selects user filter mode.
SENS1:FILT:LENG 16
Sets a filter length of 16. E.g. using a sensor with 20 ms time
window, the resulting measurement time is 640 ms (2x16x20
ms)
```

Manual operation: See ["Filter Length"](#) on page 174

:SENSe<ch>[:POWer]:FILTer:NSRatio <NSRatio>

Sets an upper limit for the relative noise content in fixed noise filter mode (: [SENSe<ch>\[:POWer\]:FILTer:TYPE](#)). This value determines the proportion of intrinsic noise in the measurement results.

Parameters:

<NSRatio> float
 Range: 0.001 to 1
 Increment: 0.001
 *RST: 0.01

Example: See [Example "Performing a power measurement with a fixed filter"](#) on page 360.

Manual operation: See ["Noise/Signal Ratio"](#) on page 174

:SENSe<ch>[:POWer]:FILTer:NSRatio:MTIME <MTime>

Sets an upper limit for the settling time of the auto-averaging filter in the `NSRatio` mode and thus limits the length of the filter. The filter type is set with command : [SENSe<ch>\[:POWer\]:FILTer:TYPE](#).

Parameters:

<MTime> float
 Range: 1 to 999.99
 Increment: 0.01
 *RST: 4

Example: See [Example "Performing a power measurement with a fixed filter"](#) on page 360.

Manual operation: See ["Timeout"](#) on page 175

:SENSe<ch>[:POWer]:FILTer:SONCe

Starts searching the optimum filter length for the current measurement conditions. You can check the result with command `:SENS1:POW:FILT:LENG:USER?` in filter mode USER (`:SENSe<ch>[:POWer]:FILTer:TYPE`).

Example:

```
SENS1:FILT:TYPE USER
Selects user filter mode.
SENS1:FILT:SONC
Activates the search for the optimum filter length.
SENS1:FILT:LENG?
Returns the found optimum filter length.
Response: 128
```

Usage: Event

Manual operation: See "Auto Once" on page 174

:SENSe<ch>[:POWer]:FILTer:TYPE <Type>

Selects the filter mode. The filter length is the multiplier for the time window and thus directly affects the measurement time.

Parameters:

<Type>

AUTO | USER | NSRatio

AUTO

Automatically selects the filter length, depending on the measured value. The higher the power, the shorter the filter length, and vice versa.

USER

Allows you to set the filter length manually. As the filter-length takes effect as a multiplier of the measurement time, you can achieve constant measurement times.

NSRatio

Selects the filter length (averaging factor) according to the criterion that the intrinsic noise of the sensor (2 standard deviations) does not exceed the specified noise content. You can define the noise content with command `:SENSe<ch>[:POWer]:FILTer:NSRatio`.

Note: To avoid long settling times when the power is low, you can limit the averaging factor limited with the "timeout" parameter (`:SENSe<ch>[:POWer]:FILTer:NSRatio:MTIME`).

*RST: AUTO

Example: See [Example "Performing a power measurement with a fixed filter"](#) on page 360.

Manual operation: See "Filter" on page 174

:SENSe<ch>[:POWer]:FREQuency <Frequency>

Sets the RF frequency of the signal, if signal source "USER" is selected (:SENSe<ch>[:POWer]:SOURce).

Parameters:

<Frequency> float
*RST: 1 GHz

Example:

SENS1:SOUR USER
Selects user-defined source.
SENS1:FREQ 2.44GHz
Sets the RF frequency of the source which is 2.44 GHz.

Manual operation: See " [Frequency](#) " on page 173

:SENSe<ch>[:POWer]:LOGGing:STATe <State>

Activates the recording of the power values, measured by a connected R&S NRP power sensor.

Parameters:

<State> 0 | 1 | OFF | ON
*RST: 0

Example:

SENS:LOGG:STAT ON
Activates recording of the power measurement of the first sensor.

Manual operation: See "[Enable Logging](#)" on page 175

:SENSe<ch>[:POWer]:OFFSet <Offset>

Sets a level offset which is added to the measured level value after activation with command :SENSe<ch>[:POWer]:OFFSet:STATe. The level offset allows, e.g. to consider an attenuator in the signal path.

Parameters:

<Offset> float
Range: -100.0 to 100.0
*RST: 0
Default unit: dB

Example:

SENS1:POW:OFFS 10.0
Sets a level offset of 10 dB

Manual operation: See " [Level Offset State,Level Offset](#)" on page 173

:SENSe<ch>[:POWer]:OFFSet:STATe <State>

Activates the addition of the level offset to the measured value. The level offset value is set with command :SENSe<ch>[:POWer]:OFFSet.

Parameters:

<State> 0 | 1 | OFF | ON
 *RST: 0

Example:

```
SENS1:POW:OFFS 0.4dB
Sets a level offset of 0.4 dB
SENS1:POW:OFFS:STAT ON
A level offset of 0.4 dB is added to the measured value.
```

Manual operation: See "[Level Offset State,Level Offset](#)" on page 173

:SENSe<ch>[:POWer]:SNUMber?

Queries the serial number of the sensor.

Return values:

<SNumber> string

Example:

```
SENS1:SNUM?
Queries the serial number.
```

Usage:

Query only

Manual operation: See "[Sensor type and serial number](#)" on page 172

:SENSe<ch>[:POWer]:SOURce <Source>

Determines the signal to be measured.

Note: When measuring the RF signal, the sensor considers the corresponding correction factor at that frequency, and uses the level setting of the instrument as reference level.

Parameters:

<Source> A | USER | RF
 *RST: A

Example:

See [Example "Performing a power measurement with a fixed filter"](#) on page 360.

Manual operation: See "[Use Frequency Of](#)" on page 173

:SENSe<ch>[:POWer]:STATus[:DEVice]?

Queries if a sensor is connected to the instrument.

Return values:

<Status> 0 | 1 | OFF | ON
 *RST: 0

Example:

```
SENS1:STAT?
Response: 1
A sensor is connected.
```

Usage: Query only

Manual operation: See "[State](#)" on page 172

:SENSe<ch>[:POWer]:TYPE?

Queries the sensor type. The type is automatically detected.

Return values:

<Type> string

Example:

SENS1:TYPE?

Queries the type of sensor.

Response: NRP-Z21

The R&S NRP-Z21 sensor is used.

Usage: Query only

Manual operation: See "[Sensor type and serial number](#)" on page 172

:SENSe<ch>[:POWer]:ZERO

Performs zeroing of the sensor.

Zeroing is required after warm-up, i.e. after connecting the sensor.

Note: Switch off or disconnect the RF power source from the sensor before zeroing.

We recommend that you zero in regular intervals (at least once a day), if:

- The temperature has varied more than about 5 °C.
- The sensor has been replaced.
- You want to measure very low power.

Example:

SENS1:ZERO

Executes zeroing.

Usage: Event

Manual operation: See "[Zero](#)" on page 172

12.14 SOURce Subsystem

The SOURce subsystem contains the commands for configuring the digital and analog signals.

Common suffixes

The following common suffixes are used in remote commands:

Suffix	Value range	Description
SOURce<hw>	[1]	<ul style="list-style-type: none"> SOURce[1] = RF output (optional keyword) LF output = SOURce:LFOutput (SOURce is optional keyword)

• Analog Modulation Subsystems	371
• SOURce:CORRection Subsystem	404
• SOURce:FREQUency Subsystem	412
• SOURce:INPUt Subsystem	418
• SOURce:LFOutput Subsystem	419
• SOURce:LIST Subsystem	432
• SOURce:NOISe Subsystem	445
• SOURce:PGEN Subsystem	447
• SOURce:PHASe Subsystem	449
• SOURce:POWEr Subsystem	449
• SOURce:ROSCillator Subsystem	458
• SOURce:SWEep Subsystem	463

12.14.1 Analog Modulation Subsystems

Option: see [Chapter 5.1, "Required Options"](#), on page 67.

The subsystems in this section describe all commands for analog modulation of the RF signal. Divided in separate sections, you can configure amplitude modulation (AM), frequency modulation (FM), phase modulation (PhiM) and pulse modulation (PULM).

You can perform each of the modulations either with an internally generated modulation signal or with an externally applied signal.

To configure the internal signal, use the commands listed in [Chapter 12.14.5, "SOURce:LFOutput Subsystem"](#), on page 419.

For more information:

See [Chapter 5, "Analog Modulations"](#), on page 67.

12.14.1.1 SOURce:MODulation Subsystem

The command in this subsystem allows you to disable all active modulations at once, and, vice versa, to restore the last active ones.

[:SOURce<hw>]:MODulation[:ALL][:STATE] <State>

Activates all modulations that were active before the last switching off.

Parameters:

<State> 0 | 1 | OFF | ON
 *RST: 0

Example:

```

SOURce1:AM1:DEPTH 30
SOURce1:AM1:SOURce LF1
SOURce1:AM1:STATe 1
SOURce1:FM1:DEVIation 1000
SOURce1:FM1:STATe 1
// disable both modulation
SOURce1:MODulation:ALL:STATe 0
SOURce1:AM1:STATe?
// 0
SOURce1:FM1:STATe?
// 0
// enable both modulation
SOURce1:MODulation:ALL:STATe 1
SOURce1:AM1:STATe?
// 1
SOURce1:FM1:STATe?
// 1

```

Manual operation: See "[Mod on/off]" on page 69

12.14.1.2 SOURce:AM Subsystem

Option: R&S SMBB-K720

The AM subsystem contains the commands for setting the amplitude modulation and also the broadband amplitude modulation.

The following examples show some variants for generating AM signals.

Example: Creating an amplitude modulated RF signal

Using the internal LF generator, the following command sequence configures an amplitude modulated signal.

```

// Reset the instrument to start from a defined state
*RST

// Set RF frequency and amplitude
SOURce1:FREQuency:CW 6000000000
SOURce1:POWer:LEVel:IMMediate:AMPLitude -25

// Configure the modulation signal
SOURce1:LFOutput1:SHAPE SINE
SOURce1:LFOutput1:FREQuency 20000

// Configure the amplitude modulation settings and switch AM on
SOURce1:AM1:SOURce LF1
SOURce1:AM1:DEPTH 30
SOURce1:AM:RATio 40
SOURce1:AM1:DEVIation:MODE UNC
SOURce1:AM1:STATe 1

```

Example: Using combined LF signals

Using the internal LF generators of both paths, the following command sequences configure an amplitude modulated signal with determined deviations depths.

```
// Configure the AM modulation settings with combined LF signal sources
SOURcel:AM1:SOURce LF1
SOURcel:AM1:DEPTh 32
// Select the modulation signal source for the second path
SOURcel:AM2:SOURce LF2
// Combine the signals of both paths with fixed total deviation depth
SOURcel:AM1:DEVIation:MODE TOT
SOURcel:AM1:DEPTh:SUM 60

// Query the deviation depth of modulation signal in the second path
SOURcel:AM2:DEPTh?
// Response: 28

// Combine the signals of both paths with fixed ratio
SOURcel:AM1:DEVIation:MODE RAT
SOURcel:AM1:RATio 100
SOURcel:AM2:DEPTh 25

// Query the deviation depth of modulation signal in the first path
SOURcel:AM1:DEPTh?
// Response: 25

SOURcel:AM1:STATe 1
SOURcel:AM2:STATe 1
```

Example: Using an external signal source

Using an external signal source, you can additionally determine whether you want to use only the AC component of the external modulation signal.

```
// Reset the instrument to start from a defined state
*RST

// Set frequency and amplitude
SOURcel:FREQuency:CW 6000000000
SOURcel:POWer:LEVel:IMMediate:AMPLitude -25

// Configure the amplitude modulation settings and turn on AM
SOURcel:AM1:SOURce EXT1
SOURcel:AM1:DEPTh 40

// Query the input sensitivity at the external modulation input
SOURcel:AM1:SENSitivity?
// Response: 40
// Since the voltage value for full modulation is 1V,
// the resulting sensitivity is precisely 50%/V.
```

```
// This value is assigned to the voltage value for full
// modulation of the input.

// Select the coupling mode AC for external amplitude modulation
SOURce1:INPut:MODext:COUPling1 AC

// For external AM signal input, adjust the sensitivity
SOURce1:AM1:SOURce EXT1
SOURce1:AM1:SENSitivity 25
SOURce1:AM1:SENSitivity?
Response: 25

// Switch on AM and RF signal output
SOURce1:AM1:STATe 1
OUTPut1:STATe 1
```

The following commands are available:

[:SOURce<hw>]:AM<ch>:STATe	374
[:SOURce<hw>]:AM<ch>:SOURce	374
[:SOURce<hw>]:AM<ch>[:DEPTH]	375
[:SOURce<hw>]:AM:DEPTH:SUM	375
[:SOURce<hw>]:AM:DEVIation:MODE	375
[:SOURce<hw>]:AM:RATio	376
[:SOURce<hw>]:AM<ch>:SENSitivity	376

[\[:SOURce<hw>\]:AM<ch>:STATe <State>](#)

Activates amplitude modulation.

Parameters:

<State> 0 | 1 | OFF | ON
 *RST: 0

Example: See [Example "Creating an amplitude modulated RF signal"](#) on page 372.

Manual operation: See ["State"](#) on page 72

[\[:SOURce<hw>\]:AM<ch>:SOURce <Source>](#)

Selects the modulation source for amplitude modulation.

Parameters:

<Source> EXT1 | NOISe | LF2 | LF1 | INTernal | EXTernal
LF1|LF2
 Uses an internally generated LF signal.
EXT1
 Uses an externally supplied LF signal.
NOISe
 Uses the internally generated noise signal.

INTernal

Uses the internally generated signal of LF1.

EXTernal

Uses an external LF signal (EXT1).

Example: See [Example "Creating an amplitude modulated RF signal"](#) on page 372.

Manual operation: See ["Source"](#) on page 72

[[:SOURce<hw>]:AM<ch>[:DEPT] <Depth>

Sets the depth of the amplitude modulation in percent.

Suffix:

<ch> 1..2
Modulation signal channel

Parameters:

<Depth> float
Range: 0 to 100

Example: See [Example "Creating an amplitude modulated RF signal"](#) on page 372.

Manual operation: See ["Depth"](#) on page 75

[[:SOURce<hw>]:AM:DEPT:SUM <AmDepthSum>

Sets the total depth of the LF signal when using combined signal sources in amplitude modulation.

Parameters:

<AmDepthSum> float
Range: 0 to 100
Increment: 0.1
*RST: 30

Example: See [Example "Using combined LF signals"](#) on page 373.

Manual operation: See ["Total Depth"](#) on page 76

[[:SOURce<hw>]:AM:DEVIation:MODE <AmDevMode>

Selects the coupling mode. The coupling mode parameter also determines the mode for fixing the total depth.

Parameters:

<AmDevMode> UNCOupled | TOTal | RATio

UNCOupled

Does not couple the LF signals.

The deviation depth values of both paths are independent.

TOTal

Couples the deviation depth of both paths.

RATio

Couples the deviation depth ratio of both paths

*RST: UNCOupled

Example: See [Example "Using combined LF signals"](#) on page 373.

Manual operation: See ["Deviation Mode"](#) on page 76

[:SOURce<hw>]:AM:RATio <Ratio>

Sets the deviation ratio (path#2 to path#1) in percent.

Parameters:

<Ratio> float
 Range: 0 to 100
 Increment: 0.1
 *RST: 100

Example: See [Example "Creating an amplitude modulated RF signal"](#) on page 372.

Manual operation: See ["Ratio Path2/Path1"](#) on page 76

[:SOURce<hw>]:AM<ch>:SENSitivity <Sensitivity>

Sets the sensitivity of the external signal source for amplitude modulation in %/V.

Parameters:

<Sensitivity> float
 Range: 0 to 100
 Increment: 0.1
 *RST: 30

Example: See [Example "Using an external signal source"](#) on page 373.

Manual operation: See ["Sensitivity"](#) on page 76

12.14.1.3 SOURce:FM Subsystem

Option: R&S SMBB-K720

The FM subsystem contains the commands for setting the frequency modulation.

Example: Creating a frequency modulated RF signal

Using the internal LF generator, the following command sequence configures a frequency modulated signal.

```
// Reset the instrument to start from a defined state
*RST
```

```

// Set RF frequency and amplitude
SOURCE:FREQUENCY:CW 600000000
SOURCE:POWER:LEVEL:IMMEDIATE:AMPLITUDE -25

// Configure the modulation signal
SOURCE:LFOUTPUT1:SHAPE SINE
SOURCE:LFOUTPUT1:FREQUENCY 20000

// Configure the frequency modulation settings and switch FM on
SOURCE:FM1:SOURCE LF1
SOURCE:FM1:DEVIATION 1000
SOURCE:FM:RATIO 40
SOURCE:FM:MODE LNOISE
SOURCE:FM1:STATE 1

// Switch on LF and RF signal output
SOURCE:LFOUTPUT1:STATE 1
OUTPUT1:STATE 1

```

Example: Using combined LF signals

Using the internal LF generators of both paths, the following command sequences configure a frequency modulated signal with determined deviations.

```

// Configure the FM modulation settings with combined LF signal sources
SOURCE:FM1:SOURCE LF1
SOURCE:FM1:DEVIATION 1000
// Select the modulation signal source for the second path
SOURCE:FM2:SOURCE LF2
// Combine the signals of both paths with fixed total deviation depth
SOURCE:FM1:DEVIATION:MODE TOT
SOURCE:FM1:DEVIATION:SUM 5000

// Query the deviation depth of modulation signal in the second path
SOURCE:FM2:DEVIATION?
// Response: 4000

// Combine the signals of both paths with fixed ratio
SOURCE:FM1:DEVIATION:MODE RAT
SOURCE:FM1:RATIO 100
SOURCE:FM2:DEVIATION 10000

// Query the deviation depth of modulation signal in the first path
SOURCE:AM1:DEVIATION?
// Response: 1000

SOURCE:FM1:STATE 1
SOURCE:FM2:STATE 1

```

Example: Using an external signal source

Alternatively configure the frequency modulation settings with an external modulation signal.

```
// Reset the instrument to start from a defined state
*RST

// Set RF frequency and amplitude
SOURce1:FREQuency:CW 6000000000
SOURce1:POWer:LEVel:IMMediate:AMPLitude -25

// Configure the frequency modulation settings and switch FM on
SOURce1:FM1:SOURce EXT1
SOURce1:FM1:DEVIation 5000

// Query the input sensitivity at the external modulation input
:SOURce1:FM1:SENSitivity?
// Response: 1000
// since the voltage value for full modulation is 1V,
// the resulting sensitivity is precisely 5000 Hz/V.

// Switch on FM and RF signal output
SOURce1:FM1:STATe 1
OUTPut1:STATe 1
```

The following commands are available:

[:SOURce<hw>]:FM<ch>:STATe	378
[:SOURce<hw>]:FM<ch>[:DEVIation]	379
[:SOURce<hw>]:FM<ch>:SOURce	379
[:SOURce<hw>]:FM:DEVIation:MODE	380
[:SOURce<hw>]:FM:DEVIation:SUM	380
[:SOURce<hw>]:FM:RATio	380
[:SOURce<hw>]:FM:MODE	381
[:SOURce<hw>]:FM:SENSitivity?	381

[\[:SOURce<hw>\]:FM<ch>:STATe <State>](#)

Activates frequency modulation.

Suffix:

FM<ch> 1..2
 determines the modulation signal channel.

Parameters:

<State> 0 | 1 | OFF | ON
*RST: 0

Example: See [Example "Creating a frequency modulated RF signal"](#)
 on page 376.

Manual operation: See ["State"](#) on page 72

[[:SOURce<hw>]:FM<ch>[:DEVIation] <Deviation>

Sets the modulation deviation of the frequency modulation in Hz.

Suffix:

FM<ch> 1|2
 Modulation signal channel

Parameters:

<Deviation> float
 The maximum deviation depends on the RF frequency and the selected modulation mode (see data sheet).
 Range: 0 to max
 Increment: 0.01
 *RST: 1E3

Example: See [Example "Creating a frequency modulated RF signal"](#) on page 376.

Manual operation: See ["Deviation"](#) on page 73

[[:SOURce<hw>]:FM<ch>:SOURce <Source>

Selects the modulation source for frequency modulation.

Suffix:

FM<ch> 1|2
 Modulation signal channel.

Parameters:

<Source> EXT1 | NOISe | LF2 | LF1 | INTernal | EXTernal
LF1|LF2
 Uses an internally generated LF signal.
INTernal
 Uses the internally generated signal of LF1.
EXTernal
 Uses an external LF signal (EXT1).
NOISe
 Uses the internally generated noise signal.
 *RST: LF1 <FM1>; LF2 <FM2>

Example: See [Example "Creating a frequency modulated RF signal"](#) on page 376.

Manual operation: See ["Source"](#) on page 72

[[:SOURce<hw>]:FM:DEVIation:MODE <FmDevMode>

Selects the coupling mode. The coupling mode parameter also determines the mode for fixing the total deviation.

Parameters:

<FmDevMode> UNCOupled | TOTal | RATio

UNCOupled

Does not couple the LF signals.

The deviation values of both paths are independent.

TOTal

Couples the deviation of both paths.

RATio

Couples the deviation ratio of both paths

*RST: UNCOupled

Example: See [Example "Using combined LF signals"](#) on page 377.

Manual operation: See ["Deviation Mode"](#) on page 73

[[:SOURce<hw>]:FM:DEVIation:SUM <FmDevSum>

Sets the total deviation of the LF signal when using combined signal sources in frequency modulation.

Parameters:

<FmDevSum> float
 Range: 0 to 40E6
 Increment: 0.01
 *RST: 1E3

Example: See [Example "Using combined LF signals"](#) on page 377.

Manual operation: See ["Total Deviation"](#) on page 73

[[:SOURce<hw>]:FM:RATio <Ratio>

Sets the deviation ratio (path2 to path1) in percent.

Parameters:

<Ratio> float
 Range: 0 to 100
 Increment: 0.1
 *RST: 100

Example: See [Example "Creating a frequency modulated RF signal"](#) on page 376.

Manual operation: See ["Ratio Path2/Path1"](#) on page 73

[:SOURce<hw>]:FM:MODE <Mode>

Selects the mode for the frequency modulation.

Parameters:

<Mode> HBANdwidth | LNOise

HBANdwidth

Selects maximum range for modulation bandwidth.

LNOise

Selects optimized phase noise and spurious characteristics with reduced modulation bandwidth and FM deviation.

*RST: HBANdwidth

Example: See [Example "Creating a frequency modulated RF signal"](#) on page 376.

Manual operation: See ["Mode"](#) on page 74

[:SOURce<hw>]:FM:SENSitivity?

Queries the sensitivity of the externally supplied signal for frequency modulation. The sensitivity depends on the set modulation deviation.

Return values:

<Sensitivity> float

Sensitivity in Hz/V.

It is assigned to the voltage value for full modulation of the input.

Range: 0 to max

Increment: 0.01

Example: See [Example "Using an external signal source"](#) on page 378.

Usage: Query only

12.14.1.4 SOURce:PM Subsystem

Option: R&S SMBB-K720

The PM subsystem contains the commands for setting the phase modulation. You can configure the internal modulation source (LF generator) with the commands listed in [Chapter 12.14.5, "SOURce:LFOutput Subsystem"](#), on page 419 .

Example: Performing phase modulation

The following example shows a command sequence to perform phase modulation.

```
// Reset the instrument to start from an initial state
*RST; *CLS

// Set the RF signal frequency and level
SOURce:FREQuency:CW 4000000000
SOURce:POWer:LEVel:IMMediate:AMPLitude -25
```

```

// Configure the phase modulation settings
SOURcel:LFOutput1:SHAPE SINE
SOURcel:LFOutput1:FREQuency 1000

// Select the LF signal generated by the internal modulation generator
// or the internally generated noise signal
SOURcel:PM1:DEVIation 1
SOURcel:PM1:SOURce LF1
// SOURcel:PM1:SOURce INTernal
// SOURcel:PM1:SOURce NOISe
SOURcel:PM1:RATio 40
SOURcel:PM1:MODE HBAN

// Alternatively configure the phase modulation settings for an
// external modulation source and query the input sensitivity.
SOURcel:PM1:SOURce EXT1
// SOURcel:PM1:SOURce EXTernal
SOURcel:PM1:DEVIation 1
SOURcel:PM1:SENSitivity?
// Response: 1
// since the voltage value for full modulation is 1V,
// the resulting sensitivity is precisely 1RAD/V.

// Activate the signal output
SOURcel:PM1:STATe 1
OUTPut1:STATe 1

```

Example: Using combined LF signals

Using the internal LF generators of both paths, the following command sequences configure an phase modulated signal with determined deviations.

```

// Configure the Phase modulation settings with combined LF signal sources
SOURcel:PM1:SOURce LF1
SOURcel:PM1:DEVIation 1.5
// Select the modulation signal source for the second path
SOURcel:PM2:SOURce LF2
// Combine the signals of both paths with fixed total deviation depth
SOURcel:PM1:DEVIation:MODE TOT
SOURcel:PM1:DEVIation:SUM 2

// Query the deviation depth of the modulation signal in the second path
SOURcel:PM2:DEVIation?
// Response: 0.5

// Combine the signals of both paths with fixed ratio
SOURcel:PM1:DEVIation:MODE RAT
SOURcel:PM1:RATio 80
SOURcel:PM2:DEVIation?
// Response: 1.2

```

```
// Query the deviation depth of modulation signal in the first path
SOURce1:PM1:DEVIation?
// Response: 1.5
```

```
SOURce1:FM1:STATe 1
SOURce1:FM2:STATe 1
```

The following commands are available:

[:SOURce<hw>]:PM<ch>:STATe	383
[:SOURce<hw>]:PM<ch>:SOURce	383
[:SOURce<hw>]:PM:MODE	384
[:SOURce<hw>]:PM:DEVIation:MODE	384
[:SOURce<hw>]:PM:DEVIation:SUM	385
[:SOURce<hw>]:PM:RATIo	385
[:SOURce<hw>]:PM:SENSitivity?	385
[:SOURce]:PM<ch>[:DEVIation]	385

[:SOURce<hw>]:PM<ch>:STATe <State>

Activates phase modulation.

Activation of phase modulation deactivates frequency modulation.

Suffix:

PM<ch> 1|2
Sets the modulation signal channel.

Parameters:

<State> 0 | 1 | OFF | ON
*RST: 0

Example: See [Example "Performing phase modulation"](#) on page 381.

Manual operation: See ["State"](#) on page 72

[:SOURce<hw>]:PM<ch>:SOURce <Source>

Selects the modulation source for phase modulation signal.

Suffix:

PM<ch> 1|2
Sets the modulation signal channel.

Parameters:

<Source> EXT1 | NOISe | LF2 | LF1 | INTernal | EXTernal

LF1|LF2

Uses an internally generated LF signal.

EXT1

Uses an externally supplied LF signal.

NOISe

Uses the internally generated noise signal.

INTernal

Uses the internally generated signal of LF1.

EXTernal

Uses an external LF signal (EXT1).

Example: See [Example "Performing phase modulation"](#) on page 381.

Manual operation: See ["Source"](#) on page 72

[[:SOURce<hw>]:PM:MODE <Mode>

Selects the mode for the phase modulation.

Parameters:

<Mode> HBANdwidth | HDEViation | LNOise

HBANdwidth

Sets the maximum available bandwidth.

HDEViation

Sets the maximum range for Φ M deviation.

LNOise

Selects a phase modulation mode with phase noise and spurious characteristics close to CW mode.

*RST: HBANdwidth

Example: See [Example "Performing phase modulation"](#) on page 381.

Manual operation: See ["Mode"](#) on page 75

[[:SOURce<hw>]:PM:DEVIation:MODE <PmDevMode>

Selects the coupling mode. The coupling mode parameter also determines the mode for fixing the total deviation.

Parameters:

<PmDevMode> UNCOupled | TOTal | RATio

UNCOupled

Does not couple the LF signals.

The deviation values of both paths are independent.

TOTal

Couples the deviation of both paths.

RATio

Couples the deviation ratio of both paths

*RST: UNCOupled

Example: See [Example "Using combined LF signals"](#) on page 382

Manual operation: See ["Deviation Mode"](#) on page 74

[:SOURce<hw>]:PM:DEVIation:SUM <PmDevSum>

Sets the total deviation of the LF signal when using combined signal sources in phase modulation.

Parameters:

<PmDevSum> float
Range: 0 to 20
Increment: 1E-6
*RST: 1

Example: See [Example "Using combined LF signals"](#) on page 382

Manual operation: See ["Total Deviation"](#) on page 75

[:SOURce<hw>]:PM:RATio <Ratio>

Sets the deviation ratio (path2 to path1) in percent.

Parameters:

<Ratio> float
Range: 0 to 100
Increment: 0.01
*RST: 100

Example: See [Example "Performing phase modulation"](#) on page 381.

Manual operation: See ["Ratio Path2/Path1"](#) on page 75

[:SOURce<hw>]:PM:SENSitivity?

Queries the sensitivity of the externally applied signal for phase modulation.

The returned value reports the sensitivity in RAD/V. It is assigned to the voltage value for full modulation of the input.

Return values:

<Sensitivity> float

Example: See [Example "Performing phase modulation"](#) on page 381.

Usage: Query only

[:SOURce]:PM<ch>[:DEVIation] <Deviation>

Sets the modulation deviation of the phase modulation in RAD.

Parameters:

<Deviation> float

The maximal deviation depends on the RF frequency and the selected modulation mode (see data sheet).

Range: 0 to max

Increment: 1

*RST: 1

Default unit: RAD

Example: See [Example "Performing phase modulation"](#) on page 381.**Manual operation:** See ["Deviation"](#) on page 74**12.14.1.5 SOURce:PULM Subsystem**Option: see [Chapter 5.1, "Required Options"](#), on page 67.

The PULM subsystem contains the commands for setting the pulse modulation.

- [Pulse Modulation Settings](#).....386
- [Pulse Train Settings](#).....391
- [Pulse Train Data Exchange](#).....394

Pulse Modulation Settings

With the commands described in this section, you can configure the settings for pulse modulation, select the trigger mode and determine delay times for the pulse modulation signal.

Example: Perform pulse modulation

The example shows a command sequence to perform pulse modulation.

```
// Reset the instrument to start from an initial state
*RST; *CLS

// Set the RF signal frequency and level
SOURce:FREQuency:CW 4000000000
SOURce:POWer:LEVel:IMMediate:AMPLitude -25

// Configure the pulse modulation settings
// Select the internal modulation generator,
// set trigger mode, select pulse mode, transition type

// Trigger a single pulse

SOURce:PULM:SOURce INT
SOURce:PULM:TRIGger:MODE SING
SOURce:PULM:MODE DOUB
SOURce:PULM:TTYPe SMO

SOURce:PULM:TRIG:IMM
```

```

// Alternatively configure the pulse modulation settings for
// external modulation source
// Select the source, set the polarity of the external signal,
// select the impedance for the external pulse modulation input/
// for the external pulse modulation trigger input
SOURce:PULM:SOURce EXT
SOURce:PULM:POLarity NORMal
SOURce:PULM:IMPedance G1K

// Configure the pulse generator settings
// Set pulse period, width, and delay
SOURce:PULM:PERiod 10 us
SOURce:PULM:WIDTH 8 us
SOURce:PULM:DOUBle:WIDTH 0.0000012
SOURce:PULM:DOUBle:DELay 0.0000045

// Activate the signal output
SOURce:PGENerator:OUTPut:STATe 1
SOURce:PULM:STATe 1
OUTPut1:STATe 1

```

The following commands are available:

[:SOURce<hw>]:PULM:MODE	387
[:SOURce<hw>]:PULM:TRIGger:MODE	388
[:SOURce]:PULM[:INTernal][:TRAIIn]:TRIGger:IMMEDIATE	388
[:SOURce<hw>]:PULM:PERiod	388
[:SOURce<hw>]:PULM:WIDTH	389
[:SOURce<hw>]:PULM:DELay	389
[:SOURce<hw>]:PULM:DOUBle:DELay	389
[:SOURce<hw>]:PULM:DOUBle:WIDTH	389
[:SOURce<hw>]:PULM:DOUBle:STATe	390
[:SOURce<hw>]:PULM:STATe	390
[:SOURce<hw>]:PULM:SOURce	390
[:SOURce<hw>]:PULM:TTYPe	390
[:SOURce<hw>]:PULM:POLarity	391
[:SOURce<hw>]:PULM:IMPedance	391

[:SOURce<hw>]:PULM:MODE <Mode>

Selects the mode for the pulse modulation.

Parameters:

<Mode>	SINGle DOUBle PTRain
	SINGle
	Generates a single pulse.
	DOUBle
	Generates two pulses within one pulse period.

Ptrain

Generates a user-defined pulse train.

Specify the pulse sequence with the commands:

```
[ :SOURce<hw> ] :PULM:TRAIIn:ONTime
```

```
[ :SOURce<hw> ] :PULM:TRAIIn:OFFTime
```

```
[ :SOURce<hw> ] :PULM:TRAIIn:REPetition
```

```
*RST: SINGle
```

Example: See [Example "Perform pulse modulation"](#) on page 386.

Options: Ptrain requires R&S SMBB-K27

Manual operation: See ["Pulse Mode"](#) on page 86

[:SOURce<hw>] :PULM:TRIGger:MODE <Mode>

Selects a trigger mode - auto, single, external, external single or external gated - for generating the modulation signal.

Parameters:

<Mode> AUTO | EXTernal | EGATe | SINGle | ESINGle

```
*RST: AUTO
```

Example: See [Example "Perform pulse modulation"](#) on page 386.

Manual operation: See ["Trigger Mode"](#) on page 86

[:SOURce] :PULM [:INTernal] [:TRAIIn] :TRIGger:IMMEDIATE

If `[:SOURce<hw>] :PULM:TRIGger:MODESINGle`, triggers the pulse generator.

Example: See [Example "Perform pulse modulation"](#) on page 386.

Manual operation: See ["Execute Single Trigger"](#) on page 87

[:SOURce<hw>] :PULM:PERiod <Period>

Sets the period of the generated pulse, that means the repetition frequency of the internally generated modulation signal.

Parameters:

<Period> float

The minimum value depends on the installed options
R&S SMBB-K22 or R&S SMBB-K23

Range: 20E-9 to 100

Increment: 5E-9

```
*RST: 10E-6
```

Example: See [Example "Perform pulse modulation"](#) on page 386.

Manual operation: See ["Pulse Period"](#) on page 87

[:SOURce<hw>]:PULM:WIDTH <Width>

Sets the width of the generated pulse, that means the pulse length. It must be at least 20ns less than the set pulse period.

Parameters:

<Width> float
 Range: 20E-9 to 100
 Increment: 10E-9
 *RST: 2E-6

Example: See [Example "Perform pulse modulation"](#) on page 386.

Manual operation: See ["Pulse Width"](#) on page 87

[:SOURce<hw>]:PULM:DELay <Delay>

Sets the pulse delay.

Parameters:

<Delay> float
 *RST: 1ms

Example: See [Example "Perform pulse modulation"](#) on page 386.

Manual operation: See ["Pulse Delay"](#) on page 87

[:SOURce<hw>]:PULM:DOUBLE:DELay <Delay>

Sets the delay from the start of the first pulse to the start of the second pulse.

Parameters:

<Delay> float
 *RST: 1E-6

Example: See [Example "Perform pulse modulation"](#) on page 386.

Manual operation: See ["Double Pulse Delay"](#) on page 87

[:SOURce<hw>]:PULM:DOUBLE:WIDTH <Width>

Sets the width of the second pulse.

Parameters:

<Width> float
 Increment: 5E-9

Example: See [Example "Perform pulse modulation"](#) on page 386.

Manual operation: See ["Double Pulse Width"](#) on page 87

[:SOURce<hw>]:PULM:DOUBLE:STATE <State>

Provided for backward compatibility with former Rohde & Schwarz signal generators.

Works like the command `[:SOURce<hw>] :PULM:MODEDOUBLE`.

Parameters:

<State> 0 | 1 | OFF | ON
*RST: 0

[:SOURce<hw>]:PULM:STATE <State>

Activates pulse modulation.

Parameters:

<State> 0 | 1 | OFF | ON
*RST: 0

Example: See [Example "Perform pulse modulation"](#) on page 386.

Manual operation: See ["State"](#) on page 70

[:SOURce<hw>]:PULM:SOURce <Source>

Selects between the internal (pulse generator) or an external pulse signal for the modulation.

Parameters:

<Source> INTernal | EXTernal
*RST: INTernal

Example: See [Example "Perform pulse modulation"](#) on page 386.

Manual operation: See ["Source"](#) on page 70

[:SOURce<hw>]:PULM:TTYPe <Source>

Sets the transition mode for the pulse signal.

Parameters:

<Source> SMOothed | FAST
SMOothed
flattens the slew rate, resulting in longer rise/fall times.
FAST
enables fast transitions with shortest rise and fall times.
*RST: FAST

Example: See [Example "Perform pulse modulation"](#) on page 386.

Manual operation: See ["Transition Type"](#) on page 71

[[:SOURce<hw>]:PULM:POLarity <Polarity>

Sets the polarity of the externally applied modulation signal.

Parameters:

<Polarity> NORMal | INVerted

NORMal

Suppresses the RF signal during the pulse pause.

INVerted

Suppresses the RF signal during the pulse.

*RST: NORMal

Example: See [Example "Perform pulse modulation"](#) on page 386.

Manual operation: See ["Polarity"](#) on page 95

[[:SOURce<hw>]:PULM:IMPedance <Impedance>

Sets the impedance for the external pulse trigger and pulse modulation input.

Parameters:

<Impedance> G50 | G10K

*RST: G50

Example: See [Example "Perform pulse modulation"](#) on page 386.

Manual operation: See ["Impedance"](#) on page 95

Pulse Train Settings

Option: R&S SMBB-K27

This section describes the commands for the pulse train modulation and the associated file handling. For background information, see [Chapter 5.4.4.2, "Pulse Generator > Pulse Train Settings"](#), on page 88.

Example: Generating a pulse train signal

The following settings are required to perform pulse train modulation.



Always create and select pulse train data list first before you activate the pulse train mode.

Otherwise, an error is displayed

```
*RST; *CLS
```

```
// Set the RF signal frequency and level
SOURce:FREQuency:CW 4000000000
SOURce:POWer:LEVel:IMMediate:AMPLitude -25
```

```
// Create a pulse train data list
// Select the directory
```

```

MMEM:CDIR '/var/user/'
SOURce1:PULM:TRAI:n:CATalog?
// my_pt
// Create and/or select the pulse train data file
SOURce1:PULM:TRAI:n:SElect "/var/user/pt"
// Enter the pulse train data
SOURce:PULM:TRAI:n:ONTime 0.0001,0.00025,0.0001
SOURce:PULM:TRAI:n:OFFTime 500us,500us,300us
SOURce:PULM:TRAI:n:REPetition 2,0,3
// the second pulse is ignored

// Select pulse train mode
// Select the internal modulation generator and the pulse mode
SOURce1:PULM:SOURce INT
SOURce1:PULM:MODE PTR
SOURce1:PULM:TRIGger:MODE EXT
SOURce1:PGENERator:OUTPut:STATe 1
SOURce1:PGENERator:OUTPut:POLarity NORM
SOURce:PGENERator:OUTPut:STATe 1
SOURce:PULM:STATe 1
OUTPut1:STATe 1

// SOURce1:PULM:TRAI:n:CATalog?
// my_pt, pt
// SOURce1:PULM:TRAI:n:DEL "/var/user/my_pt"

```

The following commands are available:

[:SOURce<hw>]:PULM:TRAI:n:CATalog?	392
[:SOURce<hw>]:PULM:TRAI:n:DELete	393
[:SOURce<hw>]:PULM:TRAI:n:ONTime	393
[:SOURce<hw>]:PULM:TRAI:n:OFFTime	393
[:SOURce<hw>]:PULM:TRAI:n:REPetition:POINts?	393
[:SOURce<hw>]:PULM:TRAI:n:ONTime:POINts?	393
[:SOURce<hw>]:PULM:TRAI:n:OFFTime:POINts?	393
[:SOURce<hw>]:PULM:TRAI:n:REPetition	393
[:SOURce<hw>]:PULM:TRAI:n:SElect	394

[\[:SOURce<hw>\]:PULM:TRAI:n:CATalog?](#)

Queries the available pulse train files in the specified directory.

Return values:

<Catalog> string
 List of list filenames, separated by commas

Example: See [Example "Generating a pulse train signal"](#) on page 391.

Usage: Query only

Manual operation: See ["Pulse Train Data"](#) on page 89

[[:SOURce<hw>]:PULM:TRAI:DELete <Filename>

Deletes the specified pulse train file.

Setting parameters:

<Filename> string
 Filename or complete file path; file extension is optional.

Example: See [Example "Generating a pulse train signal"](#) on page 391.

Usage: Setting only

Manual operation: See ["Pulse Train Data"](#) on page 89
 See ["Edit Pulse Train Data"](#) on page 90

[[:SOURce<hw>]:PULM:TRAI:ONTime <OnTime>

[[:SOURce<hw>]:PULM:TRAI:OFFTime <OffTime>

Enters the pulse on/off times values in the selected list.

Parameters:

<OffTime> Offtime#1{, Offtime#2, ...} | binary block data
 List of comma-separated numeric values or binary block data, where:
 The list of numbers can be of any length.
 In binary block format, 8 (4) bytes are always interpreted as a floating-point number with double accuracy.
 See [:FORMat \[:DATA\]](#) on page 349 for details.
 The maximum length is 2047 values.
 Range: 0 ns to 5 ms

Example: See [Example "Generating a pulse train signal"](#) on page 391.

Manual operation: See ["Edit Pulse Train Data"](#) on page 90

[[:SOURce<hw>]:PULM:TRAI:REPetition:POINTs?

[[:SOURce<hw>]:PULM:TRAI:ONTime:POINTs?

[[:SOURce<hw>]:PULM:TRAI:OFFTime:POINTs?

Queries the number of on and off time entries and repetitions in the selected list.

Return values:

<Points> integer
 Range: 0 to INT_MAX
 *RST: 0

Example: See [Example "Generating a pulse train signal"](#) on page 391.

Usage: Query only

[[:SOURce<hw>]:PULM:TRAI:REPetition <Repetition>

Sets the number of repetitions for each pulse on/off time value pair.

Parameters:

<Repetition> Repetition#1{, Repetition#2, ...}
 0 = ignore value pair
 Set "Repetition = 0" to skip a particular pulse without deleting
 the pulse on/off time value pair
 Range: 0 to 65535

Example: See [Example "Generating a pulse train signal"](#) on page 391.

Manual operation: See ["Edit Pulse Train Data"](#) on page 90

[:SOURce<hw>]:PULM:TRAI:n:SElect <Filename>

Selects or creates a data list in pulse train mode.

If the list with the selected name does not exist, a new list is created.

Parameters:

<Filename> string
 Filename or complete file path; file extension can be omitted.

Example: See [Example "Generating a pulse train signal"](#) on page 391.

Manual operation: See ["Pulse Train Data"](#) on page 89
 See ["File Name"](#) on page 94
 See ["Functions for handling of data lists"](#) on page 204

Pulse Train Data Exchange

Option: R&S SMBB-K27

With the following commands, you can configure pulse trains in ASCII format and export or import them accordingly.

```
SOURce1:PULM:SOURce INT
SOURce1:PULM:MODE PTR
SOURce1:PULM:TRAI:n:SElect "/var/user/pt"
SOURce1:PULM:STATe 1

SOURce1:PULM:TRAI:n:DEXChange:MODE EXP
SOURce1:PULM:TRAI:n:DEXChange:AFIle:EXtension TXT
SOURce1:PULM:TRAI:n:DEXChange:AFIle:SEParator:DECimal DOT
SOURce1:PULM:TRAI:n:DEXChange:AFIle:SEParator:COLumn SEM
SOURce1:PULM:TRAI:n:DEXChange:AFIle:SEParator:COLumn COMM
SOURce1:PULM:TRAI:n:DEXChange:SElect "/var/user/pt.pulstrn"
SOURce1:PULM:TRAI:n:DEXChange:AFIle:SElect "/var/user/pt_script.txt"
SOURce1:PULM:TRAI:n:DEXChange:EXECute
```

The following commands are available:

[:SOURce<hw>]:PULM:TRAI:n:DEXChange:MODE	395
[:SOURce<hw>]:PULM:TRAI:n:DEXChange:AFIle:EXtension	395
[:SOURce<hw>]:PULM:TRAI:n:DEXChange:AFIle:SEParator:DECimal	395
[:SOURce<hw>]:PULM:TRAI:n:DEXChange:AFIle:SEParator:COLumn	395

[:SOURce<hw>]:PULM:TRAI:DEXChange:AFILe:CATalog?	396
[:SOURce<hw>]:PULM:TRAI:DEXChange:AFILe:SElect	396
[:SOURce<hw>]:PULM:TRAI:DEXChange:SElect	396
[:SOURce<hw>]:PULM:TRAI:DEXChange:EXECute	396

[:SOURce<hw>]:PULM:TRAI:DEXChange:MODE <Mode>

Determines the import or export of a list.

Specify the source or destination file with the command [\[:SOURce<hw>\]:PULM:TRAI:DEXChange:SElect](#).

Parameters:

<Mode> IMPort | EXPort
 *RST: IMPort

Example: See ["Pulse Train Data Exchange"](#) on page 394.

Manual operation: See [" Mode "](#) on page 92

[:SOURce<hw>]:PULM:TRAI:DEXChange:AFILe:EXTension <Extension>

Determines the extension of the ASCII file for import or export, or to query existing files.

Parameters:

<Extension> TXT | CSV
 *RST: TXT

Example: See ["Pulse Train Data Exchange"](#) on page 394.

Manual operation: See ["ASCII File Settings"](#) on page 92

[:SOURce<hw>]:PULM:TRAI:DEXChange:AFILe:SEParator:DECimal <Decimal>

Sets "." (decimal point) or "," (comma) as the decimal separator used in the ASCII data with floating-point numerals.

Parameters:

<Decimal> DOT | COMMa
 *RST: DOT

Example: See ["Pulse Train Data Exchange"](#) on page 394.

Manual operation: See ["ASCII File Settings"](#) on page 92

[:SOURce<hw>]:PULM:TRAI:DEXChange:AFILe:SEParator:COLumn <Column>

Selects the separator between the frequency and level column of the ASCII table.

Parameters:

<Column> TABulator | SEMicolon | COMMa | SPACe
 *RST: COMMa

Example: See ["Pulse Train Data Exchange"](#) on page 394.

Manual operation: See ["ASCII File Settings"](#) on page 92

[:SOURce<hw>]:PULM:TRAI:n:DEXChange:AFILe:CATalog?

Queries the available ASCII files in the current or specified directory.

Return values:

<Catalog> string
List of ASCII files *.txt or *.csv, separated by commas.

Example: See ["Pulse Train Data Exchange"](#) on page 394.

Usage: Query only

Manual operation: See ["Select \(ASCII\) Source/Select \(ASCII\) Destination"](#) on page 93

[:SOURce<hw>]:PULM:TRAI:n:DEXChange:AFILe:SElect <Filename>

Selects the ASCII file to be imported or exported.

Parameters:

<Filename> string
Filename or complete file path; file extension can be omitted.

Example: See ["Pulse Train Data Exchange"](#) on page 394.

Manual operation: See ["Select \(ASCII\) Source/Select \(ASCII\) Destination"](#) on page 93

[:SOURce<hw>]:PULM:TRAI:n:DEXChange:SElect <Filename>

Selects the ASCII file for import or export, containing a pulse train list.

Parameters:

<Filename> string
Filename or complete file path; file extension can be omitted.

Example: See ["Pulse Train Data Exchange"](#) on page 394.

Manual operation: See ["Select Source/Select ASCII Destination"](#) on page 93

[:SOURce<hw>]:PULM:TRAI:n:DEXChange:EXECute

Usage: Event

Manual operation: See ["Import / Export"](#) on page 93

Executes the import or export of the selected list file, according to the transfer direction set with command `[:SOURce<hw>]:PULM:TRAI:n:DEXChange:MODE`.

12.14.1.6 SOURce:STEReo Subsystem

Option: R&S SMBB-B5

The SOURce:STEReo subsystem contains the commands for generating FM stereo multiplex signals, the radio traffic service ARI (Automotive Radio Information) and Radio Data System (RDS).

Additional functions are available using the SOURce:STEReo:DIReCt commands, see [Chapter 12.20, "Direct Commands for the Stereo/RDS Coder Option R&S SMBB-B5"](#), on page 508.

Example: Activating stereo modulation

The following example shows a command sequence for stereo modulation.

```
// Reset the instrument to start from an initial state
*RST; *CLS
// Set the FM deviation, audio source, preemphasis
// and max modulation frequency

SOURce:STEReo:DEVIation 25000
SOURce:STEReo:SOURce SPEX
SOURce:STEReo:AUDio:PREemphasis:STATe 1
SOURce:STEReo:AUDio:PREemphasis 75 us
SOURce:STEReo:AUDio:MODE RNEL
SOURce:STEReo:MMF 1500

// Configure the pilot tone
SOURce:STEReo:PIlot:DEVIation 5000
SOURce:STEReo:PIlot:PHASe 3

// Configure and activate ARI
STEReo:ARI 2800
SOURce:STEReo:ARI:TYPE BK
STEReo:ARI:BK C
SOURce:STEReo:ARI:STATe 1

//Configure and activate RDS
STEReo:RDS 1200
SOURce:STEReo:RDS:DATaset DS3
SOURce:STEReo:RDS:TRAFfic:PROGram:STATe 1
SOURce:STEReo:RDS:TRAFfic:ANNouncement:STATe 1
STEReo:RDS:STATe 1

// Activate the signal output
SOURce:STEReo:STATe 1
```

[:SOURce]:STEReo:DIReCt	398
[:SOURce]:STEReo:STATe	398
[:SOURce]:STEReo[:DEVIation]	398
[:SOURce]:STEReo:AUDio:MODE	399

[:SOURce]:STEReo:SOURce	399
[:SOURce]:STEReo:EXtErnal:IMPedance	400
[:SOURce]:STEReo:MMF	400
[:SOURce]:STEReo:AUDio:PREEmphasis	400
[:SOURce]:STEReo:AUDio:PREEmphasis:STATe	401
[:SOURce]:STEReo:PILot:STATe	401
[:SOURce]:STEReo:PILot[:DEViation]	401
[:SOURce]:STEReo:PILot:PHASe	401
[:SOURce]:STEReo:ARI:STATe	402
[:SOURce]:STEReo:ARI[:DEViation]	402
[:SOURce]:STEReo:ARI:TYPE:STATe	402
[:SOURce]:STEReo:ARI:TYPE	402
[:SOURce]:STEReo:ARI:BK[:CODE]	403
[:SOURce]:STEReo:RDS:STATe	403
[:SOURce]:STEReo:RDS[:DEViation]	403
[:SOURce]:STEReo:RDS:DATaset	404
[:SOURce]:STEReo:RDS:TRAFfic:PROGram[:STATe]	404
[:SOURce]:STEReo:RDS:TRAFfic:ANNouncement[:STATe]	404

[\[:SOURce\]:STEReo:DIRect](#) <Direct>

Sends a R&S SMB100B command string to the stereo coder.

The direct commands offer extended settings possibilities for the stereo coder, see [Chapter 12.20, "Direct Commands for the Stereo/RDS Coder Option R&S SMBB-B5"](#), on page 508.

Parameters:

<Direct> string

Example: See [Example "Activating stereo modulation"](#) on page 397.

Manual operation: See " [Program Service Name](#) " on page 84
 See " [Program Identification](#) " on page 84

[\[:SOURce\]:STEReo:STATe](#) <State>

Activates/deactivates stereo modulation.

Parameters:

<State> 0 | 1 | OFF | ON
 *RST: 0

Example: See [Example "Activating stereo modulation"](#) on page 397.

Manual operation: See "[State](#)" on page 78

[\[:SOURce\]:STEReo\[:DEViation\]](#) <Deviation>

Sets the MPX (Multiplex stereo signal) deviation.

Parameters:

<Deviation> integer
 Range: 0 to depends on instrument hardware
 *RST: 40 kHz

Example: See [Example "Activating stereo modulation"](#) on page 397.

Manual operation: See ["FM Deviation"](#) on page 78

[[:SOURce]:STEReo:AUDio:MODE <Mode>

Selects the generated identifiers of the AUDio signal.

Parameters:

<Mode> LEFT | RIGHT | RELeft | REMLeft | RNELeft

LEFT

A mono signal containing the left channel is generated/fed in.

RIGHT

A mono signal containing the right channel is generated/fed in.

RELeft

A stereo signal with right and left channel is generated/fed in. The channels have the same frequency and phase.

REMLeft

The signal on the left external audio input is used for both channels, left and right. The right channel is inverted.

RNELeft

(External source only)

A stereo signal containing different, independent right and left channels is feed in. It is possible, for example, to feed a fixed audio frequency to the first channel while a frequency sweep is being performed in the second channel.

*RST: LEFT

Example: See [Example "Activating stereo modulation"](#) on page 397.

Manual operation: See ["Mode"](#) on page 79

[[:SOURce]:STEReo:SOURce <Source>

Selects the source for the audio signal.

Parameters:

<Source> OFF | LREXt | SPEXt | LFGen

OFF

No audio signal is provided, ARI and RDS signal can be generated separately.

LREX

The external audio signal is feed in via the analog L and R inputs.

SPEX

The external audio signal is feed in via the digital S/P DIF interface

LFG

The audio stereo signal is internally generated by the LF generator.

*RST: LREXt

Example: See [Example "Activating stereo modulation"](#) on page 397.

Manual operation: See ["Audio Source"](#) on page 79

[:SOURce]:STEReo:EXTErnal:IMPedance <Impedance>

For [\[:SOURce\]:STEReo:SOURceLREX](#), selects the input impedance for the external analog audio signal inputs L and R.

Parameters:

<Impedance> 600 | 600Ohm | 100000 | 100kOhm | 100000Ohm

*RST: 100000

Example: See [Example "Activating stereo modulation"](#) on page 397.

Manual operation: See [" External R/L Impedance "](#) on page 79

[:SOURce]:STEReo:MMF <Mmf>

For [\[:SOURce\]:STEReo:SOURceLREX](#) and [\[:SOURce\]:STEReo:AUDio:PREEmphasis:STATe1](#), sets the maximum modulation frequency. It prevents over modulation but decreases S/N ratio.

Parameters:

<Mmf> integer

Range: 1000 to 18000

*RST: 1000

Example: See [Example "Activating stereo modulation"](#) on page 397.

Manual operation: See [" Max Modulation Frequency "](#) on page 80

[:SOURce]:STEReo:AUDio:PREEmphasis <PreEmphasis>

If [\[:SOURce\]:STEReo:AUDio:PREEmphasis:STATe1](#), sets the preemphasis used for signal generation.

Parameters:

<PreEmphasis> OFF | 50 | 75

Range: 50 us to 75 us

Example: See [Example "Activating stereo modulation"](#) on page 397.

Manual operation: See [" Preemphasis "](#) on page 80

[[:SOURce]:STEReo:AUDio:PREemphasis:STATe <State>

Activates the use of preemphasis for signal generation.

Parameters:

<State> 0 | 1 | OFF | ON
*RST: 0

Example: See [Example "Activating stereo modulation"](#) on page 397.

Manual operation: See "[Preemphasis](#)" on page 80

[[:SOURce]:STEReo:PILot:STATe <State>

Activates/deactivates the pilot tone generation.

Parameters:

<State> 0 | 1 | OFF | ON
*RST: 1

Example: See [Example "Activating stereo modulation"](#) on page 397.

Manual operation: See "[Pilot State](#)" on page 81

[[:SOURce]:STEReo:PILot[:DEViation] <Deviation>

Sets the deviation of the pilot tone.

Parameters:

<Deviation> integer
Range: 0 to 10 kHz
*RST: 6.75 kHz

Example: See [Example "Activating stereo modulation"](#) on page 397.

Manual operation: See "[Pilot Deviation](#)" on page 81

[[:SOURce]:STEReo:PILot:PHASe <Phase>

Sets the phase of the pilot tone in degrees, in relation to the 38 kHz carrier signal of the receiver. For a correct demodulation, the pilot tone must be in phase with the 38 kHz carrier.

Parameters:

<Phase> float
Range: -5 to 5
Increment: 0.1
*RST: 0

Example: See [Example "Activating stereo modulation"](#) on page 397.

Manual operation: See "[Pilot Phase](#)" on page 81

[[:SOURce]:STEReo:ARI:STATe <State>

Activates/deactivates the ARI signal generation. ARI signals can be generated simultaneously with MPX and RDS signals.

Parameters:

<State> 0 | 1 | OFF | ON
*RST: 0

Example: See [Example "Activating stereo modulation"](#) on page 397.

Manual operation: See " [ARI State](#) " on page 82

[[:SOURce]:STEReo:ARI[:DEViation] <Deviation>

Sets the frequency deviation of the ARI subcarrier signal.

Parameters:

<Deviation> integer
Range: 0 to 10000
*RST: 3500

Example: See [Example "Activating stereo modulation"](#) on page 397.

Manual operation: See " [ARI Deviation](#) " on page 82

[[:SOURce]:STEReo:ARI:TYPE:STATe <State>

Activates/deactivates the Stereo ARI Identifier. Activating selects the previously selected identifier type.

Parameters:

<State> 0 | 1 | OFF | ON
*RST: 0

Example: See [Example "Activating stereo modulation"](#) on page 397.

Manual operation: See " [ARI Identification](#) " on page 82

[[:SOURce]:STEReo:ARI:TYPE <Type>

Selects the generated identifiers of the ARI signal.

DK and BK are abbreviations of the German words Durchsagekennung and Bereichskennung.

Parameters:

<Type> OFF | DK | BK | BKDK

OFF

Only the 57 kHz subcarrier is generated.

DK

The message identification is generated in addition (low-frequency 30% AM).

BK

The area identification is generated in addition (60% AM). The specific code is selected in `[:SOURce] :STEReo:ARI:BK [:CODE]` on page 403.

BKDK

The area and message identification are generated in addition. The BK code is selected in `[:SOURce] :STEReo:ARI:BK [:CODE]` on page 403.

*RST: OFF

Example: See [Example "Activating stereo modulation"](#) on page 397.

Manual operation: See "[ARI Identification](#)" on page 82

[:SOURce] :STEReo:ARI:BK [:CODE] <Code>

Selects the area identification (BK) code of the ARI signal. The code is generated if the BK or DK+BK identifier of the ARI signal is activated.

Parameters:

<Code> A | B | C | D | E | F

The six letters (six different frequencies) identify a specific region in each country.

*RST: A

Example: See [Example "Activating stereo modulation"](#) on page 397.

Manual operation: See "[ARI BK](#)" on page 82

[:SOURce] :STEReo:RDS:STATe <State>

Activates/deactivates the RDS signal generation. RDS signals can be generated simultaneously with MPX (FM stereo multiplex) and ARI signals.

Parameters:

<State> 0 | 1 | OFF | ON

*RST: 0

Example: See [Example "Activating stereo modulation"](#) on page 397.

Manual operation: See "[RDS State](#)" on page 83

[:SOURce] :STEReo:RDS [:DEVIation] <Deviation>

Sets the deviation of the RDS subcarrier.

Parameters:

<Deviation> integer

Range: 0 to 10 kHz

*RST: 2 kHz

Example: See [Chapter 12.14.1.6, "SOURce:STEReo Subsystem"](#), on page 397.

Manual operation: See "[RDS Deviation](#)" on page 83

[[:SOURce]:STEReo:RDS:DATaset <Dataset>

Selects one of the five data sets provided on the instrument for use in the RDS signal.

Parameters:

<Dataset> DS1 | DS2 | DS3 | DS4 | DS5
*RST: DS1

Example: See [Example "Activating stereo modulation"](#) on page 397.

Manual operation: See "[RDS Data Set](#)" on page 84

[[:SOURce]:STEReo:RDS:TRAFfic:PROGram[:STATe] <State>

Activates the RDS traffic program. The receiver can recognize a frequency as being capable of traffic information only if the TP function is active.

Parameters:

<State> 0 | 1 | OFF | ON
*RST: 0

Example: See [Example "Activating stereo modulation"](#) on page 397.

Manual operation: See "[Traffic Program](#)" on page 84

[[:SOURce]:STEReo:RDS:TRAFfic:ANNouncement[:STATe] <State>

Activates the RDS traffic announcement.

If TP is on, this function switches the receiver from the current status, e.g. playing a CD, to the receive mode and enables the broadcast of a traffic announcement.

Parameters:

<State> 0 | 1 | OFF | ON
*RST: 0

Example: See [Example "Activating stereo modulation"](#) on page 397.

Manual operation: See "[Traffic Announcement](#)" on page 85

12.14.2 SOURce:CORRection Subsystem

The SOURce:CORRection subsystem contains the commands for defining correction values for external test assemblies.

You can acquire the correction values any time, regardless of the modulation settings of the generator. The correction is performed by adding the correction values to the output level of the respective RF frequency.

Determine the correction values in one of the following ways:

- Measure the RF output level at several frequency points and enter the value pairs manually in a table
- Connect an R&S NRP to the generator output signal and send the command [:SOURce<hw>] :CORRection:CSET:DATA [:SENSor<ch>] [:POWer] :SONCe to fill the table automatically.

Correction values can be stored in files with the predefined file extension *.uco.

Refer to [Chapter 12.5.2, "Accessing Files in the Default or in a Specified Directory"](#), on page 329 for general information on file handling in the default and in a specific directory.

Programming example

The examples in this section assume that:

- The files are stored in the default directory.
- *RST does not affect data lists.

Example: Create a table with user-defined correction values for the RF level

The following example shows a command sequence to create and activate a list for assigning level correction values to arbitrary RF frequencies. Further hardware settings are not considered.

```
// Reset the instrument to start from an initial state
// Query the available user correction list files in the default directory
// Select a file or create a new one
// *****
*RST; *CLS
SOURcel:CORRection:CSET:CATalog?
// Response: shows the name of available user correction files (if applicable)
// Select a file
SOURcel:CORRection:CSET:SElect "/var/user/ucor1"
// Create a new file (if not existing)
SOURcel:CORRection:CSET:SElect "/var/user/ucor2"

// Enter the frequency/level value pairs in the table;
// existing data is overwritten
// Query the number of frequency/power entries in the selected list
SOURcel:CORRection:CSET:DATA:FREQuency 100MHz,110MHz,120MHz,130MHz,140MHz,150MHz
SOURcel:CORRection:CSET:DATA:POWer -10,-7.5,-5.0,-2.5,0,2.5
SOURcel:CORRection:CSET:DATA:FREQuency:POINTs?
// 6
SOURcel:CORRection:CSET:DATA:POWer:POINTs?
// 6

// Enable user correction mode and RF output
SOURcel:CORRection:STATe 1
OUTPut1:STATe ON
```

```
// Query the currently used correction value
SOURcel:CORRection:VALue?
// -2.5

// Delete a user correction file
SOURcel:CORRection:CSET:DELEte "/var/user/ucor1.uco"
```

Example: Fill user correction data with sensor

The following example shows a command sequence to fill a user correction list automatically supported by a connected R&S NRP.

```
// Fill a user correction list with the level values
// measured by an R&S NRP,
// store the data in a file and enable user correction.

*RST; *CLS

SOURcel:CORRection:CSET:SElect "/var/user/Ucor1_AutoFill.uco"
SOURcel:CORRection:CSET:DATA:FREQuency 100MHz,110MHz,120MHz,130MHz,140MHz,150MHz
SOURcel:CORRection:ZERoing:STATe 1
SOURcel:CORRection:CSET:DATA:SENSor1:POWer:SONce
// Query the number of automatically filled correction level values
SOURcel:CORRection:CSET:DATA:POWer:POINTs?
// 6
SOURcel:CORRection:STATe 1

// Query the correction value at a certain frequency
FREQ 120000000
SOURcel:CORRection:VALue?
// -52.13
```

Example: User correction data exchange

The following example shows a command sequence to export a user correction list (here the list created with the example before) into an ASCII file. Further hardware settings are not considered.

```
// Select a user correction file for exporting to file in ASCII format
// Set ASCII data parameters
// Set the ASCII file extension, the decimal separator
// and the column separator for the ASCII data
SOURcel:CORRection:DEXChange:AFILe:CATalog?
// my_ucor
SOURcel:CORRection:CSET:CATalog?
// ucor1,Ucor1_AutoFill
SOURcel:CORRection:CSET:SElect "/var/user/Ucor1_AutoFill.uco"
SOURcel:CORRection:DEXChange:AFILe:EXTension CSV
SOURcel:CORRection:DEXChange:AFILe:SEParator:DECimal DOT
SOURcel:CORRection:DEXChange:AFILe:SEParator:COLumn COMMa
```

```
// Select source and destination
SOURce1:CORRection:DEXChange:AFILe:SElect "/var/user/ucor2ASCII"

// Export the user correction data into the ASCII file
SOURce1:CORRection:DEXChange:MODE EXPort
SOURce1:CORRection:DEXChange:EXECute

// Query the available ASCII files with extension .csv
SOURce1:CORRection:DEXChange:AFILe:CATalog?
// ucor2ASCII,my_ucor

// Import a user correction ASCII file
SOURce1:CORRection:DEXChange:MODE IMPort
SOURce1:CORRection:DEXChange:AFILe:SElect "/var/user/my_ucor"
SOURce1:CORRection:DEXChange:EXECute
```

- [Correction Settings](#).....407
- [Correction Data Exchange](#).....410

12.14.2.1 Correction Settings

[:SOURce<hw>]:CORRection:CSET:DATA:FREQuency <Frequency>

Enters the frequency value in the table selected with [\[:SOURce<hw>\]:CORRection:CSET\[:SElect\]](#).

Parameters:

<Frequency> Frequency#1[, Frequency#2, ...]
String of values with default unit Hz.

Example: See [Example "Create a table with user-defined correction values for the RF level"](#) on page 405 .

Manual operation: See ["Edit List Mode Data"](#) on page 143

[:SOURce<hw>]:CORRection:CSET:DATA:POWer <Power>

Enters the level values to the table selected with [\[:SOURce<hw>\]:CORRection:CSET\[:SElect\]](#).

Parameters:

<Power> Power#1[, Power#2, ...]
String of values with default unit dB.
*RST: 0

Example: See [Example "Create a table with user-defined correction values for the RF level"](#) on page 405 .

Manual operation: See ["Edit List Mode Data"](#) on page 143

**[[:SOURce<hw>]:CORRection:CSET:DATA:FREQUency:POINts?
[:SOURce<hw>]:CORRection:CSET:DATA:POWer:POINts?**

Queries the number of frequency/level values in the selected table.

Return values:

<Points> integer
 Range: 0 to 10000
 *RST: 0

Example: See [Example "Create a table with user-defined correction values for the RF level"](#) on page 405 .

Usage: Query only

[[:SOURce<hw>]:CORRection:CSET:DATA[:SENSor<ch>][:POWer]:SONCe

Fills the selected user correction table with the level values measured by the power sensor for the given frequencies.

To select the used power sensor set the suffix in key word `SENSe`.

Example: See [Example "Fill user correction data with sensor"](#) on page 406.

Usage: Event

Manual operation: See [" Fill User Correction Data with Sensor"](#) on page 161

[[:SOURce<hw>]:CORRection:CSET[:SElect] <Filename>

Selects or creates a file for the user correction data.

If the file with the selected name does not exist, a new file is created.

Parameters:

<Filename> string
 Filename or complete file path; file extension can be omitted.

Example: See [Example "Create a table with user-defined correction values for the RF level"](#) on page 405 .

Manual operation: See ["UCOR Data"](#) on page 157
 See ["Functions for handling of data lists"](#) on page 204

[[:SOURce<hw>]:CORRection:VALue?

Queries the current value for user correction.

Return values:

<Value> float
 Range: -100 to 100
 Increment: 0.01
 *RST: 0

Example: See [Example "Create a table with user-defined correction values for the RF level"](#) on page 405 .

Usage: Query only

Manual operation: See ["User Correction"](#) on page 157

[:SOURce<hw>]:CORRection:ZERoing:STATe <State>

Activates the zeroing procedure before filling the user correction data acquired by a sensor.

Parameters:

<State> 0 | 1 | OFF | ON
*RST: 1

Example: See [Example "Fill user correction data with sensor"](#) on page 406.

Manual operation: See [" Fill User Correction Data with Sensor"](#) on page 161

[:SOURce<hw>]:CORRection:CSET:DATA[:SENSor<ch>][:POWER]:SONCe

Fills the selected user correction list with the level values measured by the power sensor for the given frequencies.

Suffix:

SENSor<ch> Defines the used power sensor, i.e. the sensor whose values are used.

Example: See [Example "Fill user correction data with sensor"](#) on page 406.

Usage: Event

[:SOURce<hw>]:CORRection[:STATe] <State>

Activates user correction with the currently selected table.

Parameters:

<State> 0 | 1 | OFF | ON
*RST: 0

Example: See [Example "Create a table with user-defined correction values for the RF level"](#) on page 405 .

Manual operation: See ["State"](#) on page 157

[:SOURce]:CORRection:CSET:CATalog?

Queries a list of available user correction tables.

Return values:

<Catalog> string
List of list filenames, separated by commas

Example: See [Example "Create a table with user-defined correction values for the RF level"](#) on page 405 .

Usage: Query only

Manual operation: See ["UCOR Data"](#) on page 157
See ["Directory, File List and Filename"](#) on page 199

[:SOURce]:CORRection:CSET:DELeTe <Filename>

Deletes the specified user correction list file.

Setting parameters:

<Filename> string
Filename or complete file path; file extension is optional.

Example: See [Example "Create a table with user-defined correction values for the RF level"](#) on page 405 .

Usage: Setting only

Manual operation: See ["UCOR Data"](#) on page 157

12.14.2.2 Correction Data Exchange

With the following commands, you can configure user correction lists and export or import them accordingly.

[:SOURce<hw>]:CORRection:DEXChange:AFILe:CATalog?

Queries the available ASCII files for export or import of user correction data in the current or specified directory.

Return values:

<Catalog> string
List of ASCII files *.txt or *.csv, separated by commas.

Example: See [Example "Create a table with user-defined correction values for the RF level"](#) on page 405 .

Usage: Query only

Manual operation: See ["Select \(ASCII\) Source/Select \(ASCII\) Destination"](#) on page 93

[:SOURce<hw>]:CORRection:DEXChange:AFILe:EXTension <Extension>

Determines the extension of the ASCII files for file import or export, or to query existing files.

Parameters:

<Extension> TXT | CSV
 *RST: TXT

Example: See [Example "User correction data exchange"](#) on page 406 .

Manual operation: See ["ASCII File Settings"](#) on page 92

[[:SOURce<hw>]:CORRection:DEXChange:AFILe:SElect <Filename>

Selects the ASCII file to be imported or exported.

Parameters:

<Filename> string
 Filename or complete file path; file extension can be omitted.

Example: See [Example "User correction data exchange"](#) on page 406 .

Manual operation: See ["Select \(ASCII\) Source/Select \(ASCII\) Destination"](#) on page 93

[[:SOURce<hw>]:CORRection:DEXChange:AFILe:SEParator:COLumn <Column>

Selects the separator between the frequency and level column of the ASCII table.

Parameters:

<Column> TABulator | SEMicolon | COMMa | SPACe
 *RST: COMMa

Example: See [Example "User correction data exchange"](#) on page 406 .

Manual operation: See ["ASCII File Settings"](#) on page 92

[[:SOURce<hw>]:CORRection:DEXChange:AFILe:SEParator:DECimal <Decimal>

Sets the decimal separator used in the ASCII data between '.' (decimal point) and ',' (comma) with floating-point numerals.

Parameters:

<Decimal> DOT | COMMa
 *RST: DOT

Example: See [Example "User correction data exchange"](#) on page 406 .

Manual operation: See ["ASCII File Settings"](#) on page 92

[[:SOURce<hw>]:CORRection:DEXChange:EXECute

Executes the import or export of the selected correction list, according to the previously set transfer direction with command `[[:SOURce<hw>]:CORRection:DEXChange:MODE`.

Example: See [Example "User correction data exchange"](#) on page 406 .

Usage: Event

Manual operation: See ["Import / Export"](#) on page 93

[:SOURce<hw>]:CORRection:DEXChange:MODE <Mode>

Determines import or export of a user correction list.

Specify the source or destination file with the command `[:SOURce<hw>] : CORRection:DEXChange:SElect`.

Parameters:

<Mode> IMPort | EXPort
*RST: IMPort

Example: See [Example "User correction data exchange"](#) on page 406 .

Manual operation: See [" Mode "](#) on page 92

[:SOURce<hw>]:CORRection:DEXChange:SElect <Filename>

Selects the ASCII file for import or export, containing a user correction list.

Parameters:

<Filename> string
Filename or complete file path; file extension can be omitted.

Example: See [Example "User correction data exchange"](#) on page 406 .

Manual operation: See ["Select Source/Select ASCII Destination"](#) on page 93

12.14.3 SOURce:FREQuency Subsystem

The `SOURce:FREQuency` subsystem contains the commands used to define the frequency settings for the RF sources and sweeps.

Example: Frequency configuration

```
SOURce1:FREQuency:MODE CW
SOURce1:FREQuency:CW 6000000000
SOURce1:FREQuency:OFFSet 2000000000
SOURce1:FREQuency:MULTIplier 1.5
SOURce1:FREQuency:CW?
// 11000000000

// SOURce1:FREQuency:STEP:MODE USER
// SOURce1:FREQuency:STEP:INCRement 1000000
// SOURce1:FREQuency:CW UP

SOURce1:PHASe 2
SOURce1:PHASe:REFerence
```

<code>[:SOURce<hw>]:FREQUENCY:MODE</code>	413
<code>[:SOURce<hw>]:FREQUENCY[:CW FIXed]</code>	414
<code>[:SOURce<hw>]:FREQUENCY[:CW FIXed]:RCL</code>	414
<code>[:SOURce<hw>]:FREQUENCY:MANual</code>	415
<code>[:SOURce<hw>]:FREQUENCY:MULTIplier</code>	415
<code>[:SOURce<hw>]:FREQUENCY:OFFSet</code>	415
<code>[:SOURce<hw>]:FREQUENCY:CENTer</code>	416
<code>[:SOURce<hw>]:FREQUENCY:SPAN</code>	416
<code>[:SOURce<hw>]:FREQUENCY:STARt</code>	417
<code>[:SOURce<hw>]:FREQUENCY:STOP</code>	417
<code>[:SOURce<hw>]:FREQUENCY:STEP:MODE</code>	417
<code>[:SOURce<hw>]:FREQUENCY:STEP[:INCRement]</code>	418

`[:SOURce<hw>]:FREQUENCY:MODE <Mode>`

Sets the frequency mode for generating the RF output signal. The selected mode determines the parameters to be used for further frequency settings.

Parameters:

<Mode>

CW | FIXed | SWEEp | LIST

CW|FIXed

Sets the fixed frequency mode. CW and FIXed are synonyms. The instrument operates at a defined frequency, set with command `[:SOURce<hw>]:FREQUENCY[:CW|FIXed]`.

SWEEp

Sets sweep mode.

The instrument processes frequency (and level) settings in defined sweep steps.

Set the range and current frequency with the commands:

`[:SOURce<hw>]:FREQUENCY:STARt` on page 417 and `[:SOURce<hw>]:FREQUENCY:STOP` on page 417,

`[:SOURce<hw>]:FREQUENCY:CENTer` on page 416,

`[:SOURce<hw>]:FREQUENCY:SPAN` on page 416,

`[:SOURce<hw>]:FREQUENCY:MANual` on page 415

LIST

Sets list mode.

The instrument processes frequency and level settings by means of values loaded from a list.

To configure list mode settings, use the commands of the [Chapter 12.14.6, "SOURce:LIST Subsystem"](#), on page 432.

*RST: CW

Example: See [Example "Frequency configuration"](#) on page 412

Example: See [Example "Setup an RF frequency or power sweep"](#) on page 464

Manual operation: See ["State \(RF frequency sweep\)"](#) on page 126
See ["State \(RF frequency / level sweep\)"](#) on page 127
See ["State"](#) on page 137

[:SOURce<hw>]:FREQuency[:CW|FIXed] <Fixed>

Sets the frequency of the RF output signal in the selected path.

The effect depends on the selected mode:

- In CW mode (`FREQ:MODE CW | FIXed`), the instrument operates at a fixed frequency.
- In sweep mode (`FREQ:MODE SWE`), the value applies to the sweep frequency. The instrument processes the frequency settings in defined sweep steps.
- In user mode (`FREQ:STEP:MODE USER`), you can vary the current frequency step by step.

Parameters:

<Fixed>

float

The following settings influence the value range:

An offset set with the command `[:SOURce<hw>]:FREQuency:OFFSet`

Numerical value

Sets the frequency in CW and sweep mode

UP|DOWN

Varies the frequency step by step in user mode.

The frequency is increased or decreased by the value set with the command `[:SOURce<hw>]:FREQuency:STEP[:INCRement]`.

Range: (RFmin + OFFSet) to (RFmax + OFFSet)

*RST: 100 MHz

Example: See [Example "Frequency configuration"](#) on page 412

Example: See [Example "Setup an RF frequency or power sweep"](#) on page 464

Options: RFmax depends on the installed options, for example 3 GHz with R&S SMBB-B103

Manual operation: See ["Frequency"](#) on page 60

[:SOURce<hw>]:FREQuency[:CW|FIXed]:RCL <Rcl>

Set whether the RF frequency value is retained or taken from a loaded instrument configuration, when you recall instrument settings with command `*RCL`.

Parameters:

<Rcl>

INCLude | EXCLude

INCLude

Takes the frequency value of the loaded settings.

EXCLude

Retains the current frequency when an instrument configuration is loaded.

*RST: INCLude

Example: SOURce1:FREQuency:CW:RCL INCLude

Manual operation: See ["Exclude Frequency"](#) on page 200

[:SOURce<hw>]:FREQuency:MANual <Manual>

Sets the frequency and triggers a sweep step manually if [SWEep:MODE MAN](#).

Parameters:

<Manual> float

You can select any frequency within the setting range, where:

START is set with [\[:SOURce<hw>\]:FREQuency:START](#)

STOP is set with [\[:SOURce<hw>\]:FREQuency:STOP](#)

OFFSet is set with [\[:SOURce<hw>\]:FREQuency:OFFSet](#)

Range: (START + OFFSet) to (STOP + OFFSet)

Increment: 0.01Hz

*RST: 100 MHz

Default unit: Hz

Example: See [Example "Setup an RF frequency or power sweep"](#) on page 464

Manual operation: See ["Current Frequency"](#) on page 127

[:SOURce<hw>]:FREQuency:MULTiplier <Multiplier>

Sets the multiplication factor $N_{\text{FREQ:MULT}}$ of a subsequent downstream instrument.

The parameters offset $f_{\text{FREQ:OFFSer}}$ and multiplier $N_{\text{FREQ:MULT}}$ affect the frequency value set with the command [FREQ](#).

The query [FREQ?](#) returns the value corresponding to the formula:

$$f_{\text{FREQ}} = f_{\text{RFout}} * N_{\text{FREQ:MULT}} + f_{\text{FREQ:OFFSer}}$$

See ["RF frequency and level display with a downstream instrument"](#) on page 58.

Parameters:

<Multiplier> float

Range: -10000 to 10000

Increment: 0.001

*RST: 1

Example: See [Example "Frequency configuration"](#) on page 412

Manual operation: See ["Multiplier"](#) on page 60

[:SOURce<hw>]:FREQuency:OFFSet <Offset>

Sets the frequency offset $f_{\text{FREQ:OFFSet}}$ of a downstream instrument.

The parameters offset $f_{\text{FREQ:OFFSer}}$ and multiplier $N_{\text{FREQ:MULT}}$ affect the frequency value set with the command [FREQ](#).

The query `FREQ?` returns the value corresponding to the formula:

$$f_{\text{FREQ}} = f_{\text{RFout}} * N_{\text{FREQ:MULT}} + f_{\text{FREQ:OFFSet}}$$

See ["RF frequency and level display with a downstream instrument"](#) on page 58.

Note: The offset also affects RF frequency sweep.

Parameters:

<Offset> float
 Increment: 0.01
 *RST: 0

Example: See [Example "Frequency configuration"](#) on page 412

Manual operation: See ["Offset"](#) on page 60

[:SOURce<hw>]:FREQuency:CENTer <Center>

Sets the center frequency of the sweep.

See [Chapter 6.2.1, "Correlating Parameters in Sweep Mode"](#), on page 119.

Parameters:

<Center> float
 Range: 300 kHz to RFmax
 Increment: 0.01 Hz
 *RST: 300E6
 Default unit: Hz

Example: See [Example "Setup an RF frequency or power sweep"](#) on page 464

Manual operation: See [" Center Frequency "](#) on page 132

**[:SOURce<hw>]:FREQuency:SPAN **

Sets the span of the frequency sweep range.

See [Chapter 6.2.1, "Correlating Parameters in Sweep Mode"](#), on page 119.

Parameters:

 float
 Full frequency range
 Increment: 0.01
 *RST: 400E6

Example: See [Example "Setup an RF frequency or power sweep"](#) on page 464

Manual operation: See ["Span"](#) on page 132

[:SOURce<hw>]:FREQUENCY:START <Start>

Sets the start frequency for the RF sweep.

See [Chapter 6.2.1, "Correlating Parameters in Sweep Mode"](#), on page 119.

Parameters:

<Start>	float
	Range: 300kHz to RFmax
	Increment: 0.01Hz
	*RST: 100 MHz

Example: See [Example "Setup an RF frequency or power sweep"](#) on page 464

Manual operation: See "[Start Frequency/Stop Frequency](#)" on page 132

[:SOURce<hw>]:FREQUENCY:STOP <Stop>

Sets the stop frequency range for the RF sweep.

See [Chapter 6.2.1, "Correlating Parameters in Sweep Mode"](#), on page 119.

Parameters:

<Stop>	float
	Range: 300kHz to RFmax
	Increment: 0.01Hz
	*RST: 500 MHz
	Default unit: Hz

Example: See [Example "Setup an RF frequency or power sweep"](#) on page 464

Manual operation: See "[Start Frequency/Stop Frequency](#)" on page 132

[:SOURce<hw>]:FREQUENCY:STEP:MODE <Mode>

Defines the type of step size to vary the RF frequency at discrete steps with the commands [FREQ UP](#) or [FREQ DOWN](#).

Parameters:

<Mode>	DECimal USER
	DECimal
	Increases or decreases the level in steps of ten.
	USER
	Increases or decreases the level in increments, set with the command FREQ:STEP[:INCR] .
	*RST: DECimal

Example:

```
// increasing the RF frequency with a step size of 50 KHz
SOURce1:FREQUENCY:STEP 50E3
SOURce1:FREQUENCY:STEP:MODE USER
SOURce1:FREQUENCY:CW UP
```

Manual operation: See "Variation Active" on page 61

[:SOURce<hw>]:FREQuency:STEP[:INCRement] <Increment>

Sets the step width.

You can use this value to vary the RF frequency with command [FREQ UP](#) or [FREQ DOWN](#), if you have activated [FREQ:STEP:MODE USER](#).

Note: This value also applies to the step width of the rotary knob on the instrument and, in user-defined step mode, increases or decreases the frequency.

Parameters:

<Increment>	float
	Range: 0 Hz to RFmax - 100 kHz
	Increment: 0.01 Hz
	*RST: 1E6

Example: See [Example "Frequency configuration"](#) on page 412

Manual operation: See "Variation Step" on page 61

12.14.4 SOURce:INPut Subsystem

The `SOURce:INPut` subsystem contains the commands for configuring the inputs for external modulation signals. The instrument trigger setting influences all sweeps and is effective in the List mode (Instrument Trigger).

[:SOURce<hw>]:INPut:MODext:COUPling	418
[:SOURce<hw>]:INPut:MODext:IMPedance<ch>	419
[:SOURce]:INPut:TRIGger:SLOPe	419

[:SOURce<hw>]:INPut:MODext:COUPling <Coupling>

Selects the coupling mode for an externally applied modulation signal.

Parameters:

<Coupling>	AC DC
	AC
	Passes the AC signal component of the modulation signal.
	DC
	Passes the modulation signal with both components, AC and DC.
	*RST: AC

Example:

```
SOURce1:INPut:MODext:COUPling AC
SOURce1:INPut:MODext:IMPedance G50
```

Manual operation: See "[Coupling \(AC/DC\)](#)" on page 100

[[:SOURce<hw>]:INPut:MODext:IMPedance<ch> <Impedance>

Sets the impedance for the externally supplied modulation signal.

Parameters:

<Impedance> G50 | G600 | HIGH
 G50 = 50 Ohm to ground
 G600 = 600 Ohm to ground
 HIGH = 100 kOhm to ground
 *RST: HIGH

Example: See [\[:SOURce<hw>\]:INPut:MODext:COUPling](#)
 on page 418.

Manual operation: See ["Impedance"](#) on page 101

[[:SOURce]:INPut:TRIGger:SLOPe <Slope>

Sets the polarity of the active slope of an applied instrument trigger.

Parameters:

<Slope> NEGative | POSitive
 *RST: POSitive

Example: INP:TRIG:SLOP NEG
 Activates the falling slope of the external trigger signal at the
 trigger input.

Manual operation: See ["Trigger Slope"](#) on page 130

12.14.5 SOURce:LFOutput Subsystem

The `SOURce:LFOutput` subsystem contains the commands for setting the LF signal source in CW and Sweep mode and for analog modulation.

Example: Setup an LF sweep

The following example shows a command sequence to set up an LF sweep.

```
// Reset the instrument to start from an initial state
*RST; *CLS

// Set the trigger mode, the sweep mode and the sweep range
TRIGger1:LFFSweep:SOURce SINGLE
SOURce1:LFOutput1:SWEep:FREQuency:MODE AUTO
SOURce1:LFOutput1:FREQuency:START 1 kHz
SOURce1:LFOutput1:FREQuency:STOP 7 kHz

// Select linear spacing
// Select the waveform shape for the frequency sweep cycle
// Set the step width and the dwell time.
```

```

SOURcel:LFOOutput1:SWEep:FREQuency:SPACing LINear
SOURcel:LFOOutput1:SWEep:FREQuency:SHApe SAWtooth
SOURcel:LFOOutput1:SWEep:FREQuency:STEP:LINear 100 Hz
SOURcel:LFOOutput1:SWEep:FREQuency:DWELl 150 ms
// Alternatively to the step width set the number of steps
SOURcel:LFOOutput1:SWEep:FREQuency:POINts 61

// Activate change to start frequency while waiting for next trigger
// Prerequisites: sweep mode single and sweep waveform sawtooth
SOURcel:LFOOutput:SWEep:FREQuency:RETRace 1

// Activate the LF frequency sweep
SOURcel:LFOOutput:FREQuency:MODE SWE

// Trigger the sweep (depending on the set mode) and query the status
// Perform a one-off LF sweep
SOURcel:LFOOutput1:SWEep:FREQuency:EXECute
SOURcel:LFOOutput1:SWEep:FREQuency:RUNning?
// 1
// the sweep is running

// *****
// For manual step LF sweep use the following commands
*RST; *CLS
SOURcel:LFOOutput:SWEep:FREQuency:MODE MANual
// Activate the LF frequency sweep
SOURcel:LFOOutput:FREQuency:MODE SWEep
// Activate LF Output1.
SOURcel:LFOOutput1:STATE 1
// Input the frequency manually for each step
SOURcel:LFOOutput1:FREQuency:MANual 2 kHz
SOURcel:LFOOutput1:FREQuency:MANual 2.1 kHz
// Alternatively use UP or DOWN parameter with set step width.
SOURcel:LFOOutput1:SWEep:FREQuency:STEP:LINear 500 Hz
SOURcel:LFOOutput1:FREQuency:MANual UP

```

Example: Configuring the LF generator

The following is a simple example on how to configure the LF generator and output the generated signal.

```

// configure the signal of the LF1 generator
SOURcel:LFOOutput1:SHApe SQU
SOURcel:LFOOutput1:SHApe:PULSe:PERiod 0.001
SOURcel:LFOOutput1:SHApe:PULSe:WIDTh 0.0005
SOURcel:LFOOutput1:SHApe:PULSe:DCYCLE 0.5
// configure the signal of the LF1 generator
SOURcel:LFOOutput2:SHApe SINE
SOURcel:LFOOutput2:FREQuency 1000000
SOURcel:LFOOutput2:PERiod?
// 0.000001

```



```
// changing the LF signal shape
// SOURCE1:LFOutput2:SHAPE TRAP
// SOURCE1:LFOutput2:SHAPE:PULSE:PERIOD 0.2
// SOURCE1:LFOutput2:SHAPE:TRAPEZE:RISE 0.0001
// SOURCE1:LFOutput2:SHAPE:TRAPEZE:FALL 0.001
// SOURCE1:LFOutput2:SHAPE:TRAPEZE:FALL 0.0001
// SOURCE1:LFOutput2:SHAPE:TRAPEZE:HIGh 0.0005
// SOURCE1:LFOutput2:SHAPE TRI
// SOURCE1:LFOutput2:SHAPE:PULSE:PERIOD 0.1
// SOURCE1:LFOutput2:SHAPE:TRIANGLE:RISE 0.0001

// activate the LF output and select the LF1 as signal source
// configure the LF output signal
SOURCE1:LFOutput1:FREQUENCY:MODE CW
SOURCE1:LFOutput1:STATE 1
SOURCE1:LFOutput1:SOURCE LF1
SOURCE1:LFOutput1:INTERNAL:VOLTAGE 1
SOURCE1:LFOutput1:OFFSET 0.001
```

- [LF Generator Settings](#).....421
- [LF Sweep Settings](#).....429

12.14.5.1 LF Generator Settings

With the commands described in this section, you can configure the LF signal source.

[:SOURCE]:LFOutput<ch>:BANDwidth?	422
[:SOURCE]:LFOutput<ch>:FREQUENCY	422
[:SOURCE<hw>]:LFOutput<ch>:PERIOD?	422
[:SOURCE<hw>]:LFOutput:FREQUENCY:MANual	423
[:SOURCE<hw>]:LFOutput:FREQUENCY:MODE	423
[:SOURCE<hw>]:LFOutput:FREQUENCY:STOP	424
[:SOURCE<hw>]:LFOutput:FREQUENCY:START	424
[:SOURCE]:LFOutput<ch>[:STATE]	424
[:SOURCE]:LFOutput<ch>:INTERNAL:VOLTAGE	424
[:SOURCE]:LFOutput:OFFSet	425
[:SOURCE]:LFOutput<ch>:SOURCE	425
[:SOURCE]:LFOutput:SIMPedance	425
[:SOURCE]:LFOutput<ch>:SOURCE:PATH	426
[:SOURCE]:LFOutput:VOLTAGE	426
[:SOURCE<hw>]:LFOutput<ch>:SHAPE	426
[:SOURCE<hw>]:LFOutput<ch>:SHAPE:PULSE:DCYCLE	426
[:SOURCE<hw>]:LFOutput<ch>:SHAPE:PULSE:PERIOD	427
[:SOURCE<hw>]:LFOutput<ch>:SHAPE:PULSE:WIDTH	427
[:SOURCE<hw>]:LFOutput<ch>:SHAPE:TRAPEZE:FALL	427
[:SOURCE<hw>]:LFOutput<ch>:SHAPE:TRAPEZE:HIGh	427
[:SOURCE<hw>]:LFOutput<ch>:SHAPE:TRAPEZE:PERIOD	428

<code>[:SOURce<hw>]:LFOOutput<ch>:SHAPE:TRAPeZe:RISE</code>	428
<code>[:SOURce<hw>]:LFOOutput<ch>:SHAPE:TRIAngle:PERiod</code>	428
<code>[:SOURce<hw>]:LFOOutput<ch>:SHAPE:TRIAngle:RISE</code>	428

`[:SOURce]:LFOOutput<ch>:BANDwidth?`

Queries the bandwidth of the external LF signal.

Return values:

<Bandwidth> BW0M2 | BW10m
 *RST: BW10m

Example:

```
LFO:BAND?
// BW10m
// the bandwidth of the externally supplied LF signal is 10 MHz
```

Usage: Query only

Manual operation: See "[Bandwidth](#)" on page 101

`[:SOURce]:LFOOutput<ch>:FREQuency <Frequency>`

Sets the frequency of the LF signal in `[:SOURce<hw>]:LFOOutput:FREQuency:MODE` CW | FIXed mode.

Note

- If signal source "Internal" is set, the instrument performs the analog modulations (AM/FM/PhiM/PM) with this frequency.
- In sweep mode (`[:SOURce<hw>]:LFOOutput:FREQuency:MODE` SWE), the frequency is coupled with the sweep frequency.

Parameters:

<Frequency> float
 Range: depends on the installed options
 Increment: 0.01
 *RST: 1000
 Default unit: Hz

Example:

```
SOURce1:LFOOutput1:FREQuency 5 kHz
// sets the LF frequency
```

Manual operation: See "[LF Gen Frequency](#)" on page 79
 See "[Frequency](#)" on page 99

`[:SOURce<hw>]:LFOOutput<ch>:PERiod?`

Queries the repetition frequency of the sine signal.

Return values:

<LfSinePeriod> float
 Range: 1E-6 to 100
 Increment: 10E-9
 *RST: 0.001
 Default unit: s

Example: See [Example "Configuring the LF generator"](#) on page 420.

Usage: Query only

[:SOURce<hw>]:LFOutput:FREQuency:MANual <Manual>

Sets the frequency of the subsequent sweep step if `LFO:SWE:MODE MAN`.

Use a separate command for each sweep step.

Parameters:

<Manual> float
 You can select any value within the setting range, where:
 START is set with `[:SOURce<hw>]:LFOutput:FREQuency:START`
 STOP is set with `[:SOURce<hw>]:LFOutput:FREQuency:STOP`
 Range: START to STOP
 Increment: 0.1
 *RST: 1000

Example: See [Example "Setup an LF sweep"](#) on page 419.

Manual operation: See ["Current Frequency"](#) on page 127

[:SOURce<hw>]:LFOutput:FREQuency:MODE <Mode>

Sets the mode for the output of the LF generator frequency, and determines the commands to be used for frequency settings.

Parameters:

<Mode> CW | FIXed | SWEep
CW|FIXed
 Sets the fixed-frequency mode. CW and FIXed are synonyms.
 To set the output frequency, use command `[:SOURce]:LFOutput<ch>:FREQuency`
SWEep
 Sets sweep mode.
 To set the frequency, use the commands:
`[:SOURce<hw>]:LFOutput:FREQuency:START` and `[:SOURce<hw>]:LFOutput:FREQuency:STOP`
 Or `[:SOURce<hw>]:LFOutput:FREQuency:MANual`
 *RST: CW

Example: See [Example "Setup an LF sweep"](#) on page 419.

Manual operation: See ["State \(LF frequency sweep\)"](#) on page 97

```
[ :SOURce<hw>]:LFOutput:FREQuency:STOP <Stop>
[ :SOURce<hw>]:LFOutput:FREQuency:START <Start>
```

Sets the start/stop frequency for `[:SOURce<hw>]:LFOutput:FREQuency:MODE` `SWEep`.

Parameters:

<Start> float
 Range: 0.1 Hz to 1 MHz
 Increment: 0.1
 *RST: 1 KHz

Example: See [Example "Setup an LF sweep"](#) on page 419.

Manual operation: See [" Start Frequency/Stop Frequency "](#) on page 132

```
[ :SOURce]:LFOutput<ch>[:STATe] <State>
```

Activates LF signal output.

Parameters:

<State> 0 | 1 | OFF | ON
 *RST: 0

Example: See [Example "Configuring the LF generator"](#) on page 420.

Manual operation: See ["State"](#) on page 103

```
[ :SOURce]:LFOutput<ch>:INTernal:VOLTagE <Voltage>
```

Sets the output voltage for the LF generators.

The sum of both values must not exceed the overall output voltage, set with command `[:SOURce]:LFOutput:VOLTagE`.

Suffix:

<ch> [1]2
 LF1 and LF2

Parameters:

<Voltage> float
 Range: 0 to 4
 Increment: 0.001
 *RST: 1

Example: See [Example "Configuring the LF generator"](#) on page 420.

Manual operation: See ["Output Voltage"](#) on page 103

[[:SOURce]:LFOutput:OFFSet <Offset>

Sets a DC offset at the LF Output.

Parameters:

<Offset>	float
Range:	depends on lfo voltage
Increment:	0.001
*RST:	0

Example: See [Example "Configuring the LF generator"](#) on page 420.

Manual operation: See ["DC-Offset"](#) on page 103

[[:SOURce]:LFOutput<ch>:SOURce <Source>

Determines the LF signal to be synchronized, when monitoring is enabled.

Parameters:

<Source>	LF1 LF2 NOISe AM FMPM EXT1
LF1 LF2	Selects an internally generated LF signal.
NOISe	Selects an internally generated noise signal.
EXT1	Selects an externally supplied LF signal
AM	Selects the AM signal.
FMPM	Selects the signal also used by the frequency or phase modulations.
*RST:	LF1

Example: See [Example "Configuring the LF generator"](#) on page 420.

Manual operation: See ["Source"](#) on page 103

[[:SOURce]:LFOutput:SIMPedance <SImpedance>

Selects the impedance of the LF output.

Parameters:

<SImpedance>	G600 G50
*RST:	G50

Example: `SOURce:LFOutput:SIMPedance G600`
Sets the output impedance of the LF generator to 600 Ohm.

Manual operation: See ["Source Impedance"](#) on page 103

[[:SOURce]:LFOutput<ch>:SOURce:PATH <SourPath>

Determines the path of the LF output source.

Parameters:

<SourPath> A | B
*RST: A

Example:

LFO:SOUR:PATH?
Queries the currently set path for the LF output signal source.

[[:SOURce]:LFOutput:VOLTage <Voltage>

Sets the voltage of the LF output.

Parameters:

<Voltage> float
Range: dynamic (see data sheet)
Increment: 0.001
*RST: 1

Example:

SOURce:LFOutput:VOLTage 1.5

[[:SOURce<hw>]:LFOutput<ch>:SHAPE <Shape>

Selects the waveform shape of the LF signal.

Parameters:

<Shape> SINE | SQUARE | PULSE | TRIangle | TRAPEze
*RST: SINE

Example:

See [Example "Configuring the LF generator"](#) on page 420.

Options:

TRIangle|TRAPEze require R&S SMBB-K24

Manual operation:

See "[LF Gen Shape](#)" on page 79
See "[Shape](#)" on page 97

[[:SOURce<hw>]:LFOutput<ch>:SHAPE:PULSE:DCYCLE <DCycle>

Sets the duty cycle for the shape pulse.

Parameters:

<DCycle> float
Range: 1E-6 to 100
Increment: 1E-6
*RST: 50
Default unit: PCT

Example:

See [Example "Configuring the LF generator"](#) on page 420.

Manual operation:

See "[Pulse Duty Cycle](#)" on page 99

[[:SOURce<hw>]:LFOutput<ch>:SHAPE:PULSE:PERiod <Period>

Sets the period of the generated pulse. The period determines the repetition frequency of the internal signal.

Parameters:

<Period> float
 Range: 1E-6 to 100
 Increment: 1E-8
 *RST: 1E-3

Example: See [Example "Configuring the LF generator"](#) on page 420.

Manual operation: See ["Period"](#) on page 99

[[:SOURce<hw>]:LFOutput<ch>:SHAPE:PULSE:WIDTH <Width>

Sets the pulse width of the generated pulse.

Parameters:

<Width> float
 Range: 1E-6 to 100
 Increment: 1E-8
 *RST: 5E-4

Example: See [Example "Configuring the LF generator"](#) on page 420.

Manual operation: See ["Pulse Width"](#) on page 99

[[:SOURce<hw>]:LFOutput<ch>:SHAPE:TRAPEze:FALL <Fall>

Selects the fall time for the trapezoid shape of the LF generator.

Parameters:

<Fall> float
 Range: 1E-6 to 100
 Increment: 10E-9
 *RST: 250E-6

Example: See [Example "Configuring the LF generator"](#) on page 420.

Manual operation: See ["Trapezoid Rise / Fall"](#) on page 100

[[:SOURce<hw>]:LFOutput<ch>:SHAPE:TRAPEze:HIGh <High>

Sets the high time for the trapezoid signal of the LF generator.

Parameters:

<High> float
 Range: 1E-6 to 100
 Increment: 10E-9
 *RST: 250E-6

Example: See [Example "Configuring the LF generator"](#) on page 420.

Manual operation: See ["Trapezoid High"](#) on page 100

[:SOURce<hw>]:LFOutput<ch>:SHAPE:TRAPeZe:PERiod <Period>

Sets the period of the generated trapezoid shape. The period determines the repetition frequency of the internal signal.

Parameters:

<Period>	float
	Range: 1E-6 to 100
	Increment: 1E-8
	*RST: 1E-3

Example: See [Example "Configuring the LF generator"](#) on page 420.

Manual operation: See ["Period"](#) on page 99

[:SOURce<hw>]:LFOutput<ch>:SHAPE:TRAPeZe:RISE <Rise>

Selects the rise time for the trapezoid shape of the LF generator.

Parameters:

<Rise>	float
	Range: 1E-6 to 100
	Increment: 10E-9
	*RST: 250E-6

Example: See [Example "Configuring the LF generator"](#) on page 420.

Manual operation: See ["Trapezoid Rise / Fall"](#) on page 100

[:SOURce<hw>]:LFOutput<ch>:SHAPE:TRlangle:PERiod <Period>

Sets the period of the generated pulse. The period determines the repetition frequency of the internal signal.

Parameters:

<Period>	float
	Range: 1E-6 to 100
	Increment: 10E-9
	*RST: 0.001

Example: See [Example "Configuring the LF generator"](#) on page 420.

Manual operation: See ["Period"](#) on page 99

[:SOURce<hw>]:LFOutput<ch>:SHAPE:TRlangle:RISE <Rise>

Selects the rise time for the triangle single of the LF generator.

Parameters:

<Rise> float
 Range: 1E-6 to 100
 Increment: 10E-9
 *RST: 0.5E-3

Example: See [Example "Configuring the LF generator"](#) on page 420.

Manual operation: See ["Triangle Rise"](#) on page 99

12.14.5.2 LF Sweep Settings

With the commands described in this section, you can configure the sweep of the LF signal.

[:SOURce<hw>]:LFOutput:SWEep[:FREQUENCY]:DWELI	429
[:SOURce<hw>]:LFOutput:SWEep[:FREQUENCY]:EXECute	429
[:SOURce<hw>]:LFOutput:SWEep[:FREQUENCY]:MODE	430
[:SOURce<hw>]:LFOutput:SWEep[:FREQUENCY]:POINts	430
[:SOURce<hw>]:LFOutput:SWEep[:FREQUENCY]:RETRace	430
[:SOURce<hw>]:LFOutput:SWEep[:FREQUENCY]:RUNNING?	431
[:SOURce<hw>]:LFOutput:SWEep[:FREQUENCY]:SHAPE	431
[:SOURce<hw>]:LFOutput:SWEep[:FREQUENCY]:SPACing	431
[:SOURce<hw>]:LFOutput:SWEep[:FREQUENCY]:STEP:LOGarithmic	431
[:SOURce<hw>]:LFOutput:SWEep[:FREQUENCY]:STEP:LINear	432

[\[:SOURce<hw>\]:LFOutput:SWEep\[:FREQUENCY\]:DWELI](#) <Dwell>

Sets the dwell time for each frequency step of the sweep.

Parameters:

<Dwell> float
 Range: 0.001 to 100
 Increment: 100E-6
 *RST: 0.01
 Default unit: s

Example: See [Example "Setup an LF sweep"](#) on page 419.

Manual operation: See ["Dwell Time"](#) on page 130

[\[:SOURce<hw>\]:LFOutput:SWEep\[:FREQUENCY\]:EXECute](#)

Immediately starts an LF sweep.

[\[:SOURce<hw>\]:LFOutput:SWEep\[:FREQUENCY\]:MODE](#) determines which sweep is executed, e.g. `SOURce:LFOutput:SWEep:FREQUENCY:MODE STEP`.

Example: See [Example "Setup an LF sweep"](#) on page 419.

Usage: Event

Manual operation: See ["Execute Single Sweep"](#) on page 131

[:SOURce<hw>]:LFOutput:SWEep[:FREQUENCY]:MODE <Mode>

Sets the cycle mode of the LF sweep.

Parameters:

<Mode>

AUTO | MANual | STEP

AUTO

Performs a complete sweep cycle from the start to the end value when a trigger event occurs.

The dwell time determines the time period until the signal switches to the next step.

MANual

Performs a single sweep step when a manual trigger event occurs.

The trigger system is not active. To trigger each frequency step of the sweep individually, use the command `[:SOURce<hw>] :LFOutput:FREQUENCY:MANual` on page 423.

STEP

Each trigger command triggers one sweep step only.

The frequency increases by the value set with the commands:

`[:SOURce<hw>] :LFOutput:SWEep[:FREQUENCY]:STEP[:LINear]` (linear spacing)

`[:SOURce<hw>] :LFOutput:SWEep[:FREQUENCY]:STEP:LOGarithmic` (logarithmic spacing)

*RST: AUTO

Example: See [Example "Setup an LF sweep"](#) on page 419.

Manual operation: See ["Mode"](#) on page 127

[:SOURce<hw>]:LFOutput:SWEep[:FREQUENCY]:POINTS <Points>

Sets the number of steps in an LF sweep.

For information on how the value is calculated and the interdependency with other parameters, see [Chapter 6.2.1, "Correlating Parameters in Sweep Mode"](#), on page 119

Parameters:

<Points>

integer

Range: 2 to POINTs

*RST: 50

Example: See [Example "Setup an LF sweep"](#) on page 419.

[:SOURce<hw>]:LFOutput:SWEep[:FREQUENCY]:RETRace <State>

Activates that the signal changes to the start frequency value while it is waiting for the next trigger event.

You can enable this feature, when you are working with sawtooth shapes in sweep mode "Single" or "External Single".

Parameters:

<State> 0 | 1 | OFF | ON
 *RST: 0

Manual operation: See ["Retrace"](#) on page 128

[[:SOURce<hw>]:LFOutput:SWEep[:FREQUENCY]:RUNNING?

Queries the current status of the LF frequency sweep mode.

Return values:

<State> 0 | 1 | OFF | ON

Example: See [Example "Setup an LF sweep"](#) on page 419.

Usage: Query only

[[:SOURce<hw>]:LFOutput:SWEep[:FREQUENCY]:SHAPE <Shape>

Sets the cycle mode for a sweep sequence (shape).

Parameters:

<Shape> SAWTooth | TRIangle
 *RST: SAWTooth

Example: See [Example "Setup an LF sweep"](#) on page 419.

Manual operation: See [" Shape"](#) on page 128

[[:SOURce<hw>]:LFOutput:SWEep[:FREQUENCY]:SPACing <Spacing>

Selects linear or logarithmic sweep spacing.

Parameters:

<Spacing> LINear | LOGarithmic
 *RST: LINear

Example: See [Example "Setup an LF sweep"](#) on page 419.

Manual operation: See [" Spacing"](#) on page 130

**[[:SOURce<hw>]:LFOutput:SWEep[:FREQUENCY]:STEP:LOGarithmic
 <Logarithmic>**

Sets the step width factor for logarithmic sweeps to calculate the frequencies of the steps.

For information on how the value is calculated and the interdependency with other parameters, see [Chapter 6.2.1, "Correlating Parameters in Sweep Mode"](#), on page 119

Parameters:

<Logarithmic> float
 The unit is mandatory
 Range: 0.01 to 100
 Increment: 0.01
 *RST: 1
 Default unit: PCT

Example: See [Example "Setup an LF sweep"](#) on page 419.

Manual operation: See "[Step Linear/Step Logarithmic](#)" on page 133

[:SOURce<hw>]:LFOutput:SWEep[:FREQuency]:STEP[:LINear] <Linear>

Sets the step width for the linear sweep.

For information on how the value is calculated and the interdependency with other parameters, see [Chapter 6.2.1, "Correlating Parameters in Sweep Mode"](#), on page 119

Parameters:

<Linear> float
 Range: 0.1 to STOP-START
 Increment: 0.1
 *RST: 1000

Example: See [Example "Setup an LF sweep"](#) on page 419.

Manual operation: See "[Step Linear/Step Logarithmic](#)" on page 133

12.14.6 SOURce:LIST Subsystem

The SOURce:LIST subsystem contains all commands for defining lists and for handling of list files.

List files have the predefined file extension *.lsw.

Refer to [Chapter 12.5.2, "Accessing Files in the Default or in a Specified Directory"](#), on page 329 for general information on file handling in the default and in a specific directory.



- *RST does not affect data lists.
- SCPI refers to the individual lists as segments.

Example: Create an RF list and activate the list mode

The following example shows a command sequence to create an RF list and to activate the list mode. Further hardware settings are not considered.

```
// Reset the instrument to start from an initial state
// Query the available list files in the default
// directory /var/user
```

```

// Select the list file or create it (if not existing)
*RST; *CLS
SOUR1:LIST:CAT?
// Response:- shows the name of available list files (if applicable)
SOUR1:LIST:SEL "/var/user/list1.lsw"

// Write the frequency/level/dwell time values in the selected list file
// existing data is overwritten
// Query the number of frequency/power/dwell time entries in the selected list
// Query the amount of free memory (in bytes) for list mode lists
SOUR1:LIST:FREQ 58 MHz, 61 MHz, 73 MHz, 86 MHz, 91 MHz, 92 MHz, 98 MHz
SOUR1:LIST:POW 13 dBm, 12 dBm, 5 dBm, 3 dBm, 0 dBm, 4 dBm, 6 dBm
SOUR1:LIST:DWEL:LIST 10000, 100000, 200000, 19000, 10000, 150000, 220000
SOUR1:LIST:FREQ:POIN?
// 7
SOUR1:LIST:POW:POINT?
// 7
SOUR1:LIST:DWEL:LIST:POIN?
// 7
SOUR1:LIST:FREE?
// 2147483647 (bytes of free memory)

// Use dwell times from list
// Configure the list mode parameters
// Enable RF output
SOUR1:LIST:MODE AUTO
SOUR1:LIST:TRIG:SOUR AUTO
SOUR1:LIST:DWEL:MODE "LIST"

OUTP1:STAT ON

// Use global dwell time
// Set only a part of the list (value pairs 3 to 5) to be processed
// Configure the list mode parameters using global dwell time
// Enable RF output
SOUR1:LIST:IND:START 2
SOUR1:LIST:IND:STOP 4
SOUR1:LIST:MODE AUTO
SOUR1:LIST:TRIG:SOUR AUTO
SOUR1:LIST:DWEL:LIST 500 ms
OUTP1:STAT ON

// Enable the list mode
// Trigger the list (depending on the mode, not needed with trigger
// mode AUTO); query the current index
// Reset the list to the starting point
SOUR1:FREQ:MODE LIST
SOUR1:LIST:TRIG:EXEC
SOUR1:LIST:RUNN?
SOUR1:LIST:IND?
// 3

```

```

// value changes when the value is queried again
SOUR1:LIST:RES

// For list mode STEP use the following commands
*RST; *CLS
// Change list mode to STEP
SOUR1:LIST:MODE STEP
// Activate RF Output1
OUTP1:STAT 1
// Activate the list mode
SOUR1:FREQ:MODE LIST
// For each step: select frequency/powerlevel pair as index from the list
SOUR1:LIST:IND 2
SOUR1:LIST:IND 3
SOUR1:LIST:IND 4

// Use the selected list for path B (with List Mode B default settings)
SOUR2:LIST:SEL "/var/user/list1.lsw"
OUTP2:STAT ON
SOUR2:FREQ:MODE LIST
SOUR2:LIST:IND?
// 2
// value changes when the value is queried again

// Deactivate the list mode
SOUR1:FREQ:MODE CW

```

Example: List mode data exchange

The following example shows a command sequence to export a list (here the RF list created with the example before) into an ASCII file. Further hardware settings are not considered.

```

*RST; *CLS
LIST:DEXC:MODE EXP

// Set ASCII data parameters
// Set the ASCII file extension, the decimal separator
// and the column separator for the ASCII data
SOUR1:LIST:DEXC:AFIL:EXT CSV
SOUR1:LIST:DEXC:AFIL:SEP:DEC DOT
SOUR1:LIST:DEXC:AFIL:SEP:COL COMM

// Select source and destination path/directory
// Query available listfiles in default directory "/var/user"
SOUR1:LIST:CAT?
// list1
SOUR1:LIST:DEXC:AFIL:SEL "/var/user/list1ASCII"
SOUR1:LIST:DEXC:SEL "/var/user/list1"

// Export the list file data into the ASCII file

```

```
SOUR1:LIST:DEXC:EXEC
```

```
// Query the available ASCII files with extension .csv
```

```
SOUR1:LIST:DEXC:AFIL:CAT?
```

```
// Response: "list1ASCII"
```

```
// Deactivate the list mode
```

```
SOUR1:FREQ:MODE CW
```

- [List Mode Settings](#).....435
- [List Mode File Operation](#).....440
- [List Mode Data Exchange](#).....443

12.14.6.1 List Mode Settings

With the following commands, you can create list mode data, select the trigger mode and determine the dwell time.

[:SOURce<hw>]:LIST:DWELL	435
[:SOURce<hw>]:LIST:DWELL:MODE	436
[:SOURce<hw>]:LIST:DWELL:LIST	436
[:SOURce<hw>]:LIST:DWELL:LIST:POINts?	436
[:SOURce<hw>]:LIST:FREQuency	437
[:SOURce<hw>]:LIST:FREQuency:POINts?	437
[:SOURce<hw>]:LIST:INDex	437
[:SOURce<hw>]:LIST:INDex:START	438
[:SOURce<hw>]:LIST:INDex:STOP	438
[:SOURce<hw>]:LIST:MODE	438
[:SOURce<hw>]:LIST:POWer	438
[:SOURce<hw>]:LIST:POWer:POINts?	439
[:SOURce<hw>]:LIST:TRIGger:EXECute	439
[:SOURce<hw>]:LIST:TRIGger:SOURce	439
[:SOURce<hw>]:LIST:RUNNing?	440

[:SOURce<hw>]:LIST:DWELL <Dwell>

Sets the global dwell time. The instrument generates the signal with the frequency / power value pairs of each list entry for that particular period.

See also [Significant Parameters and Functions](#).

Parameters:

<Dwell>	float
	Range: 1E-3 to 100
	Increment: 1E-6
	*RST: 0.01

Example: See [Example "Create an RF list and activate the list mode"](#) on page 432.

Manual operation: See ["Global Dwell Time"](#) on page 138

[:SOURce<hw>]:LIST:DWELI:MODE <DwellMode>

Selects the dwell time mode.

Parameters:

<DwellMode>

LIST | GLOBal

LIST

Uses the dwell time, specified in the data table for each value pair individually.

GLOBal

Uses a constant dwell time, set with command [:

[SOURce<hw>\]:LIST:DWEL1](#).

*RST: GLOBal

Example:

See [Example "Create an RF list and activate the list mode"](#) on page 432.

Manual operation: See ["Dwell Time Mode"](#) on page 137

[:SOURce<hw>]:LIST:DWELI:LIST <Dwell>

Enters the dwell time values in the selected list in μ s.

Parameters:

<Dwell>

<Dwell#1>{, <Dwell#2>, ...} | block data

You can either enter the data as a list of numbers, or as binary block data. The list of numbers can be of any length, with the list entries separated by commas.

In binary block format, 8 (4) bytes are always interpreted as a floating-point number with double accuracy. See also :

[FORMat \[:DATA\]](#) on page 349 for more details.

Example:

See [Example "Create an RF list and activate the list mode"](#) on page 432.

Manual operation: See ["Edit List Mode Data"](#) on page 143

[:SOURce<hw>]:LIST:DWELI:LIST:POINTs?

Queries the number (points) of dwell time entries in the selected list.

Return values:

<Points>

integer

Range: 0 to INT_MAX

*RST: 0

Example:

See [Example "Create an RF list and activate the list mode"](#) on page 432.

Usage:

Query only

[:SOURce<hw>]:LIST:FREQuency <Frequency>

Enters the frequency values in the selected list.

Parameters:

<Frequency> <Frequency#1>{, <Frequency#2>, ...} | block data
 You can either enter the data as a list of numbers, or as binary block data.
 The list of numbers can be of any length, with the list entries separated by commas.
 In binary block format, 8 (4) bytes are always interpreted as a floating-point number with double accuracy.
 See also :FORMat [:DATA].
 Range: 300 kHz to RFmax (depends on the installed options)

Example: See [Example "Create an RF list and activate the list mode"](#) on page 432.

Manual operation: See "[Edit List Mode Data](#)" on page 143

[:SOURce<hw>]:LIST:FREQuency:POINts?

Queries the number (points) of frequency entries in the selected list.

Return values:

<Points> integer
 Range: 0 to INT_MAX
 *RST: 0

Example: See [Example "Create an RF list and activate the list mode"](#) on page 432.

Usage: Query only

[:SOURce<hw>]:LIST:INDex <Index>

Sets the list index in [LIST:MODE STEP](#).

After the trigger signal, the instrument processes the frequency and level settings of the selected index.

Parameters:

<Index> integer
 *RST: 0

Example: See [Example "Create an RF list and activate the list mode"](#) on page 432.

Manual operation: See "[Current Index](#)" on page 137

[[:SOURce<hw>]:LIST:INDEX:START <Start>

[[:SOURce<hw>]:LIST:INDEX:STOP <Stop>

Sets the start and stop index of the index range which defines a subgroup of frequency/level value pairs in the current list.

Parameters:

<Stop> integer
 Index range
 Only values inside this range are processed in list mode
 Range: 0 to list length
 *RST: 0

Example: See [Example "Create an RF list and activate the list mode"](#) on page 432.

Manual operation: See "[List Range from/to](#)" on page 139

[[:SOURce<hw>]:LIST:MODE <Mode>

Sets the list mode.

The instrument processes the list according to the selected mode and trigger source. See [LIST:TRIG:SOUR AUTO](#), [SING](#) or [EXT](#) for the description of the trigger source settings.

Parameters:

<Mode> AUTO | STEP
AUTO
 Each trigger event triggers a complete list cycle.
STEP
 Each trigger event triggers only one step in the list processing cycle. The list is processed in ascending order.
 *RST: AUTO

Example: See [Example "Create an RF list and activate the list mode"](#) on page 432.

Manual operation: See "[Mode](#)" on page 137

[[:SOURce<hw>]:LIST:POWER <Power>

Enters the level values in the selected list. The number of level values must correspond to the number of frequency values. Existing data is overwritten.

Parameters:

<Power> <Power#1>{, <Power#2>, ...} | block data
 You can either enter the data as a list of numbers, or as binary block data.
 The list of numbers can be of any length, with the list entries separated by commas.

In binary block format, 8 (4) bytes are always interpreted as a floating-point number with double accuracy.

See also :FORMat [:DATA].

Range: depends on the installed options

Default unit: dBm

Example: See [Example "Create an RF list and activate the list mode"](#) on page 432.

Manual operation: See ["Edit List Mode Data"](#) on page 143

[:SOURce<hw>]:LIST:POWer:POINts?

Queries the number (points) of level entries in the selected list.

Return values:

<Points> integer
 Range: 0 to INT_MAX
 *RST: 0

Example: See [Example "Create an RF list and activate the list mode"](#) on page 432.

Usage: Query only

[:SOURce<hw>]:LIST:TRIGger:EXECute

Starts the processing of a list in list mode.

Example: See [Example "Create an RF list and activate the list mode"](#) on page 432.

Usage: Event

Manual operation: See ["Execute Single"](#) on page 138

[:SOURce<hw>]:LIST:TRIGger:SOURce <Source>

Selects the trigger source for processing lists.

The designation of the parameters correspond to those in sweep mode. SCPI standard uses other designations for the parameters, which are also accepted by the instrument. The SCPI designation should be used if compatibility is an important consideration. For an overview, see the following table:

Rohde & Schwarz parameter	SCPI parameter	Applies to the list mode parameters:
AUTO	IMMediate	[:SOURce<hw>]:LIST:MODE AUTO
SINGle	BUS	[:SOURce<hw>]:LIST:MODE AUTO or [:SOURce<hw>]:LIST:MODE STEP
EXTernal	EXTernal	[:SOURce<hw>]:LIST:MODE AUTO or [:SOURce<hw>]:LIST:MODE STEP

Parameters:

<Source>

AUTO | IMMediate | SINGle | BUS | EXTernal

AUTO|IMMediate

The trigger is free-running, i.e. the trigger condition is fulfilled continuously. The selected list is restarted as soon as it is finished.

SINGle|BUS

The list is triggered by the command [:SOURce<hw>]:LIST:TRIGger:EXECute. The list is executed once.

EXTernal

The list is triggered externally and executed once.

*RST: AUTO

Example:

See [Example "Create an RF list and activate the list mode"](#) on page 432.

Manual operation: See ["Mode"](#) on page 137

[:SOURce<hw>]:LIST:RUNNING?

Queries the current state of the list mode.

Return values:

<State> 0 | 1 | OFF | ON

1

Signal generation based on the list mode is active.

Example:

See [Example "Create an RF list and activate the list mode"](#) on page 432.

Usage:

Query only

12.14.6.2 List Mode File Operation

The following section covers basic commands to file handling in list mode.

[:SOURce<hw>]:LIST:CATalog?.....	441
[:SOURce<hw>]:LIST:DELeTe.....	441
[:SOURce<hw>]:LIST:DELeTe:ALL.....	441

[:SOURce<hw>]:LIST:FREE?	442
[:SOURce<hw>]:LIST:RESet	442
[:SOURce<hw>]:LIST:SElect	442

[:SOURce<hw>]:LIST:CATalog?

Queries the available list files in the specified directory.

Return values:

<Catalog> string
 List of list filenames, separated by commas

Example: See [Example "Create an RF list and activate the list mode"](#) on page 432.

Usage: Query only

Manual operation: See "[List Mode Data](#)" on page 139

[:SOURce<hw>]:LIST:DELeTe <Filename>

Deletes the specified list.

Setting parameters:

<Filename> string
 Filename or complete file path; file extension is optional.

Example: See [\[:SOURce<hw>\]:LIST:DELeTe:ALL](#) on page 441.

Usage: Setting only

Manual operation: See "[List Mode Data](#)" on page 139

[:SOURce<hw>]:LIST:DELeTe:ALL

Deletes all lists in the set directory.

This command can only be executed, if:

- No list file is selected.
- List mode is disabled.

Example:

```

SOUR1:LIST:CAT?
// list,my_list
SOUR1:LIST:DEL "/var/user/list1"
SOUR1:LIST:CAT?
// my_list
SOUR1:FREQ:MODE?
// LIST
SOUR1:LIST:SEL?
// /var/user/my_list.lsw
//deactivate list mode
SOUR1:FREQ:MODE CW
SOUR1:LIST:DELeTe:ALL
SOUR1:LIST:CAT?
// -
// all list files are deleted

```

Usage: Event

Manual operation: See " [List Mode Data](#) " on page 139

[:SOURce<hw>]:LIST:FREE?

Queries the amount of free memory (in bytes) for list mode lists.

Return values:

<Free>	integer
	Range: 0 to INT_MAX
	*RST: 0

Example: See [Example "Create an RF list and activate the list mode"](#) on page 432.

Usage: Query only

[:SOURce<hw>]:LIST:RESet

Jumps to the beginning of the list.

Example: See [Example "Create an RF list and activate the list mode"](#) on page 432.

Usage: Event

Manual operation: See " [Reset](#) " on page 138

[:SOURce<hw>]:LIST:SElect <Filename>

Selects or creates a data list in list mode.

If the list with the selected name does not exist, a new list is created.

Parameters:

<Filename> string
 Filename or complete file path; file extension can be omitted.

Example: See [Example "Create an RF list and activate the list mode"](#) on page 432.

Manual operation: See ["List Mode Data"](#) on page 139
 See ["Functions for handling of data lists"](#) on page 204

12.14.6.3 List Mode Data Exchange

With the following commands, you can configure lists in ASCII format and export or import them accordingly.

[:SOURce<hw>]:LIST:DEXChange:AFILe:CATalog?	443
[:SOURce<hw>]:LIST:DEXChange:EXECute	443
[:SOURce<hw>]:LIST:DEXChange:AFILe:EXTension	444
[:SOURce<hw>]:LIST:DEXChange:AFILe:SElect	444
[:SOURce<hw>]:LIST:DEXChange:AFILe:SEParator:COLumn	444
[:SOURce<hw>]:LIST:DEXChange:AFILe:SEParator:DECimal	444
[:SOURce<hw>]:LIST:DEXChange:MODE	445
[:SOURce<hw>]:LIST:DEXChange:SElect	445

[\[:SOURce<hw>\]:LIST:DEXChange:AFILe:CATalog?](#)

Queries the available ASCII files for export or import of list mode data in the current or specified directory.

Return values:

<Catalog> string
 List of ASCII files *.txt or *.csv, separated by commas.

Example: See [Example "List mode data exchange"](#) on page 434.

Usage: Query only

Manual operation: See ["Select \(ASCII\) Source/Select \(ASCII\) Destination"](#) on page 93

[\[:SOURce<hw>\]:LIST:DEXChange:EXECute](#)

Executes the import or export of the selected list file, according to the previously set transfer direction with command [\[:SOURce<hw>\]:LIST:DEXChange:MODE](#)

Example: See [Example "List mode data exchange"](#) on page 434.

Usage: Event

Manual operation: See ["Import / Export"](#) on page 93

[:SOURce<hw>]:LIST:DEXChange:AFILe:EXTension <Extension>

Determines the extension of the ASCII file for import or export, or to query existing files.

Parameters:

<Extension> TXT | CSV
*RST: TXT

Example: See [Example "List mode data exchange"](#) on page 434.

Manual operation: See ["ASCII File Settings"](#) on page 92

[:SOURce<hw>]:LIST:DEXChange:AFILe:SElect <Filename>

Selects the ASCII file to be imported or exported.

Parameters:

<Filename> string
Filename or complete file path; file extension can be omitted.

Example: See [Example "List mode data exchange"](#) on page 434.

Manual operation: See ["Select \(ASCII\) Source/Select \(ASCII\) Destination"](#) on page 93

[:SOURce<hw>]:LIST:DEXChange:AFILe:SEParator:COLumn <Column>

Selects the separator between the frequency and level column of the ASCII table.

Parameters:

<Column> TABulator | SEMicolon | COMMa | SPACe
*RST: COMMa

Example: See [Example "List mode data exchange"](#) on page 434.

Manual operation: See ["ASCII File Settings"](#) on page 92

[:SOURce<hw>]:LIST:DEXChange:AFILe:SEParator:DECimal <Decimal>

Sets "." (decimal point) or "," (comma) as the decimal separator used in the ASCII data with floating-point numerals.

Parameters:

<Decimal> DOT | COMMa
*RST: DOT

Example: See [Example "List mode data exchange"](#) on page 434.

Manual operation: See ["ASCII File Settings"](#) on page 92

[:SOURce<hw>]:LIST:DEXChange:MODE <Mode>

Determines the import or export of a list.

Specify the source or destination file with the command `[:SOURce<hw>]:LIST:DEXChange:SElect`.

Parameters:

<Mode> IMPort | EXPort
*RST: IMPort

Example: See [Example "List mode data exchange"](#) on page 434.

Manual operation: See [" Mode "](#) on page 92

[:SOURce<hw>]:LIST:DEXChange:SElect <Filename>

Selects the ASCII file for import or export, containing a list.

Parameters:

<Filename> string
 Filename or complete file path; file extension can be omitted.

Example: See [Example "List mode data exchange"](#) on page 434.

Manual operation: See ["Select Source/Select ASCII Destination"](#) on page 93

12.14.7 SOURce:NOISe Subsystem

The SOURce:NOISe subsystem contains the commands for:

- Setting the noise modulation signal. The noise generator is optional.

Example: Configuring the noise generator

```
SOURce1:NOISe:DIStributioN GAUSS
SOURce1:NOISe:BANDwidth 10000000
SOURce1:NOISe:BANDwidth:STATe 1
```

```
SOURce1:LFOutput1:SOURce NOIS
SOURce1:LFOutput1:STATe 1
```

```
SOURce1:NOISe:LEVel:RELative?
// -83.86
SOURce1:NOISe:LEVel:ABSolute?
// -13.86
```

- [Noise Generator](#).....446

12.14.7.1 Noise Generator

[:SOURce<hw>]:NOISE:BANDwidth BWIDth.....	446
[:SOURce<hw>]:NOISE:BWIDth:STATe.....	446
[:SOURce<hw>]:NOISE:DISTRibution.....	446
[:SOURce<hw>]:NOISE:LEVel:RELative?.....	446
[:SOURce<hw>]:NOISE:LEVel[:ABSolute]?.....	447

[:SOURce<hw>]:NOISE:BANDwidth|BWIDth <BWidth>

Sets the noise level in the system bandwidth when bandwidth limitation is enabled.

Parameters:

<BWidth>	float
Range:	100E3 to 10E6
Increment:	100E3
*RST:	100E3

Example: See [Example "Configuring the noise generator"](#) on page 445.

Manual operation: See ["Bandwidth"](#) on page 102

[:SOURce<hw>]:NOISE:BWIDth:STATe <State>

Activates noise bandwidth limitation.

Parameters:

<State>	0 1 OFF ON
*RST:	0

Example: See [Example "Configuring the noise generator"](#) on page 445.

Manual operation: See ["Bandwidth"](#) on page 102

[:SOURce<hw>]:NOISE:DISTRibution <Distribution>

Sets the distribution of the noise power density.

Parameters:

<Distribution>	GAUSSs EQUal
*RST:	GAUSSs

Example: See [Example "Configuring the noise generator"](#) on page 445.

Manual operation: See ["Distribution"](#) on page 101

[:SOURce<hw>]:NOISE:LEVel:RELative?

Queries the level of the noise signal per Hz in the total bandwidth.

Return values:

<Relative> float
 Range: -149.18 to -52.67
 Increment: 0.1
 *RST: -69.84

Example: See [Example "Configuring the noise generator"](#) on page 445.

Usage: Query only

Manual operation: See ["Noise Density"](#) on page 104

[:SOURce<hw>]:NOISe:LEVel[:ABSolute]?

Queries the level of the noise signal in the system bandwidth within the enabled bandwidth limitation.

Return values:

<Absolute> float
 Noise level within the bandwidth limitation
 *RST: 3.84 MHz

Example: See [Example "Configuring the noise generator"](#) on page 445.

Usage: Query only

Manual operation: See ["Noise Level"](#) on page 104

12.14.8 SOURce:PGEN Subsystem

The PGEN subsystem contains the commands for setting output of the pulse modulation signal.

Example: Using pulse generator as source for pulse modulation

```
// select pulse generator as source for pulse modulation
// enable pulse modulation
SOURce1:PULM:SOURce INT
SOURce1:PULM:STATe 1
// pulse generator and signal output are also activated
SOURce1:PGENerator:STATe?
// 1
SOURce1:PGENerator:OUTPut:STATe?
// 1
PGENerator:OUTPut:POLarity NORMAL
// to disable pulse generator
SOURce1:PGENerator:STATe 0
// activate the pulse modulation of the RF carrier
SOURce1:PULM:STATe 1
```

[:SOURce<hw>]:PGENERator:OUTPut:POLarity.....	448
[:SOURce<hw>]:PGENERator:OUTPut[:STATe].....	448
[:SOURce<hw>]:PGENERator:STATe.....	448

[:SOURce<hw>]:PGENERator:OUTPut:POLarity <Polarity>

Sets the polarity of the pulse output signal.

Parameters:

<Polarity> NORMal | INVerted

NORMal

Outputs the pulse signal during the pulse width, that means during the high state.

INVerted

Inverts the pulse output signal polarity. The pulse output signal is suppressed during the pulse width, but provided during the low state.

*RST: NORMal

Example: See [Example "Using pulse generator as source for pulse modulation"](#) on page 447.

Manual operation: See ["Pulse Output Polarity"](#) on page 87

[:SOURce<hw>]:PGENERator:OUTPut[:STATe] <State>

Activates the output of the pulse modulation signal.

Parameters:

<State> 0 | 1 | OFF | ON

*RST: 0

Example: See [Example "Using pulse generator as source for pulse modulation"](#) on page 447.

Manual operation: See ["Pulse Output State"](#) on page 87

[:SOURce<hw>]:PGENERator:STATe <State>

Enables the output of the video/sync signal.

If the pulse generator is the current modulation source, activating the pulse modulation automatically activates the signal output and the pulse generator.

Parameters:

<State> 0 | 1 | OFF | ON

*RST: 0

Example: See [Example "Using pulse generator as source for pulse modulation"](#) on page 447.

12.14.9 SOURce:PHASe Subsystem

This subsystem contains the commands for adjusting the phase of the RF output signal relative to a reference signal of the same frequency.

Example: Programming Example

```
// change the phase relative to the current phase
SOURce1:PHASe 2 DEG
// adopt the setting as the current phase
SOURce1:PHASe:REFerence
```

The following commands are available:

[:SOURce<hw>]:PHASe	449
[:SOURce<hw>]:PHASe:REFerence	449

[:SOURce<hw>]:PHASe <Phase>

Sets the phase variation relative to the current phase.

Parameters:

<Phase>	float
Range:	-36000 to 36000
Increment:	0.001
*RST:	0
Default unit:	DEG

Example: See [Example "Programming Example"](#) on page 449.

Manual operation: See ["Delta Phase"](#) on page 66

[:SOURce<hw>]:PHASe:REFerence

Assigns the value set with command [\[:SOURce<hw>\]:PHASe](#) as the reference phase.

Example: See [Example "Programming Example"](#) on page 449.

Usage: Event

Manual operation: See ["Reset Delta Phase Display"](#) on page 66

12.14.10 SOURce:POWer Subsystem

The SOURce:POWer subsystem contains the commands for setting the output level, level control and level correction of the RF signal.

The default units are dBm. To change the units, perform one of the following:

- Enter the unit after the numerical value
Example: :POW 0.5V
- Set the unit with the command [:UNIT:POWer](#).

<code>[:SOURce<hw>]:POWer:ALC:MODE?</code>	450
<code>[:SOURce<hw>]:POWer:ALC[:STATe]</code>	450
<code>[:SOURce<hw>]:POWer:ALC:DSEnsitivity</code>	451
<code>[:SOURce<hw>]:POWer:ALC:SONCe</code>	451
<code>[:SOURce<hw>]:POWer:ATTenuation:RFOFF:MODE</code>	451
<code>[:SOURce<hw>]:POWer:EMF:STATe</code>	452
<code>[:SOURce<hw>]:POWer:LBEHaviour</code>	452
<code>[:SOURce<hw>]:POWer:LIMit[:AMPLitude]</code>	452
<code>[:SOURce<hw>]:POWer:LMODE</code>	453
<code>[:SOURce<hw>]:POWer:MANual</code>	453
<code>[:SOURce<hw>]:POWer:MODE</code>	454
<code>[:SOURce<hw>]:POWer:POWer</code>	454
<code>[:SOURce<hw>]:POWer:START</code>	455
<code>[:SOURce<hw>]:POWer:STOP</code>	455
<code>[:SOURce<hw>]:POWer:STEP:MODE</code>	455
<code>[:SOURce<hw>]:POWer:STEP[:INCRement]</code>	455
<code>[:SOURce<hw>]:POWer[:LEVel][:IMMediate]:OFFSet</code>	456
<code>[:SOURce<hw>]:POWer[:LEVel][:IMMediate]:RCL</code>	456
<code>[:SOURce<hw>]:POWer[:LEVel][:IMMediate][:AMPLitude]</code>	457
<code>[:SOURce<hw>]:POWer:RANGe:LOWer?</code>	457
<code>[:SOURce<hw>]:POWer:RANGe:UPPer?</code>	457
<code>[:SOURce]:POWer:WIGNore</code>	458

`[:SOURce<hw>]:POWer:ALC:MODE?`

Queries the currently set ALC mode.

See `[:SOURce<hw>]:POWer:ALC[:STATe]` on page 450.

Return values:

`<PowAlcMode>` 0 | AUTO | 1 | PRESet | OFFTable | ON | OFF | ONSample | ONTable

Example:

`POW:ALC:MODE?`

Response: ONTable "Table and On" is set automatically.

Usage:

Query only

`[:SOURce<hw>]:POWer:ALC[:STATe] <State>`

Parameters:

`<State>` 0 | OFF | AUTO | 1 | ON | ONTable | PRESet | OFFTable

AUTO

Adjusts the output level to the operating conditions automatically.

1|ON

Activates internal level control permanently.

OFFTable

Controls the level using attenuation values of the internal ALC table.

0|OFF

Deactivates the ALC, but allows you to recalibrate the level at each frequency and level change. The value remains up to the next change.

ONTable

Starts with the attenuation setting from the table and continues with automatic level control.

*RST: AUTO

Example:

POW:ALC ON

Activates internal level control.

Manual operation: See "[State](#)" on page 152

[:SOURce<hw>]:POWer:ALC:DSENSitivity <Sensitivity>

Sets the sensitivity of the ALC detector.

Parameters:

<Sensitivity>

AUTO | FIXed | LOW | MEDium | HIGH

AUTO

Selects the optimum sensitivity automatically.

LOW|MEDium|HIGH

Sets either low, medium or high sensitivity.

FIXed

Fixes the internal level detector.

*RST: AUTO

Example:

POW:ALC:DSEN FIX

Manual operation: See "[Detector Sensitivity](#)" on page 152

[:SOURce<hw>]:POWer:ALC:SONCe

Activates level control for correction purposes temporarily.

Example:

POW:ALC OFF

Deactivates automatic level control at the RF output.

POW:ALC:SONC

Executes level control (once).

Usage:

Event

Manual operation: See "[Readjust](#)" on page 65

[:SOURce<hw>]:POWer:ATTenuation:RFOff:MODE <Mode>

Selects the state the attenuator is to assume if the RF signal is switched off.

Parameters:

<Mode>

UNCHanged | FATTenuation

FATTenuation

The step attenuator switches to maximum attenuation

UNCHanged

Retains the current setting and keeps the output impedance constant during RF off.

*RST: n.a. (factory preset: FATTenuation)

Example:

```
SOURce1:POWer:ATTenuation:RFOff:MODE
FATTenuation
```

uses maximum attenuation when the RF output is turned off.

Manual operation: See " [RF OFF Mode](#) " on page 150

[:SOURce<hw>]:POWer:EMF:STATe <State>

Displays the signal level as voltage of the EMF. The displayed value represents the voltage over a 50 Ohm load.

Parameters:

<State> 0 | 1 | OFF | ON

*RST: n.a. (factory preset: 0)

Example:

```
POW:EMF:STAT 1
```

Activates voltage level display.

Manual operation: See " [Display Level as Voltage of EMF](#) " on page 228

[:SOURce<hw>]:POWer:LBEHaviour <Behaviour>

Selects the level behavior at the RF output over time.

Parameters:

<Behaviour> AUTO | UNINterrupted | MONotone | CVSWr | USER | CPHase

UNINterrupted|MONotone

Uninterrupted level settings and strictly monotone modes.

CWSWr

Constant VSWR

*RST: AUTO

Example:

```
SOURce1:POWer:LBEHaviour AUTO
```

Manual operation: See " [Setting Characteristics](#) " on page 64

[:SOURce<hw>]:POWer:LIMit[:AMPLitude] <Amplitude>

Limits the maximum RF output level in CW and sweep mode.

It does not influence the "Level" display or the response to the query `[:SOURce<hw>] :POWer [:LEVel] [:IMMediate] [:AMPLitude]`.

Parameters:

<Amplitude> float
 Range: depends on the installed options
 Increment: 0.01
 *RST: n.a. (factory preset: 30)

Example: SOURce1:POWer:LIMit:AMPLitude 10

Manual operation: See " [Limit](#) " on page 63

[:SOURce<hw>]:POWer:LMODe <LevMode>

Sets the RF level mode.

Parameters:

<LevMode> NORMal | LOWNoise | LOWDistortion

NORMal
 Supplies the RF signal with the standard power level of the instrument.

LOWNoise
 Supplies a very low noise sinewave signal.

LOWDistortion
 Supplies a very pure sinewave signal.

*RST: NORMal

Example: SOURce1:POWer:LMODe LOWD
 Sets low distortion mode. The instrument reduces distortions of the RF signal to a minimum.

Manual operation: See " [Mode](#) " on page 64

[:SOURce<hw>]:POWer:MANual <Manual>

Sets the level for the subsequent sweep step if [SWE:POW:MODE MAN](#).

Use a separate command for each sweep step.

Parameters:

<Manual> float

You can select any level within the setting range, where:
 START is set with `[:SOURce<hw>] :POWer:START`
 STOP is set with `[:SOURce<hw>] :POWer:STOP`
 OFFSet is set with `[:SOURce<hw>] :POWer [:LEVel] [:IMMediate] :OFFSet`

Range: (START + OFFSet) to (STOP + OFFSet)
 Increment: 0.01
 Default unit: dBm

Example: See [Example "Setup an RF frequency or power sweep"](#) on page 464

Manual operation: See "[Current Level](#)" on page 127

[:SOURce<hw>]:POWer:MODE <Mode>

Selects the operating mode of the instrument to set the output level.

Parameters:

<Mode>

CW | FIXed | SWEep

CW|FIXed

Operates at a constant level.

CW and FIXed are synonyms.

To set the output level value, use the command [:SOURce<hw>]:POWer[:LEVel] [:IMMediate] [:AMPLitude].

SWEep

Sets sweep mode.

Set the range and current level with the commands:

[:SOURce<hw>]:POWer:STARt and [:SOURce<hw>]:POWer:STOP,

[:SOURce<hw>]:POWer:MANual.

*RST: CW

Example: See [Example "Setup an RF frequency or power sweep"](#) on page 464

Manual operation: See "[State \(RF level sweep\)](#)" on page 126
See "[State \(RF frequency / level sweep\)](#)" on page 127

[:SOURce<hw>]:POWer:POWer <Power>

Sets the level **at the RF output** connector.

This value does not consider a specified offset.

The command [:SOURce<hw>]:POWer[:LEVel] [:IMMediate] [:AMPLitude] sets the level of the "Level" display, that means the level containing offset.

See "[RF frequency and level display with a downstream instrument](#)" on page 58.

Parameters:

<Power>

float

Level at the RF output, without level offset

Range: See data sheet

Increment: 0.01

Default unit: dBm

Example: SOURce1:POWer:POWer 15
Sets the level at RF output

Manual operation: See "[Amplitude](#)" on page 63

[:SOURce<hw>]:POWER:START <Start>

[:SOURce<hw>]:POWER:STOP <Stop>

Sets the RF start/stop level in sweep mode.

Parameters:

<Stop>

float

Sets the setting range calculated as follows:

(Level_min + OFFSet) to (Level_max + OFFSet)

Where the values are set with the commands:

`[:SOURce<hw>]:POWER[:LEVel] [:IMMediate]:OFFSet`

`[:SOURce<hw>]:POWER:START`

`[:SOURce<hw>]:POWER:STOP`

Range: Minimum level to maximum level

*RST: -30 (Start)/ -10 (Stop)

Default unit: dBm

Example:

See [Example "Setup an RF frequency or power sweep"](#) on page 464

Manual operation: See "[Start Level / Stop Level](#)" on page 134

[:SOURce<hw>]:POWER:STEP:MODE <Mode>

Defines the type of step width to vary the RF output power step-by-step with the commands `POW UP` or `POW DOWN`.

Parameters:

<Mode>

DECimal | USER

DECimal

Increases or decreases the level in steps of ten.

USER

Increases or decreases the level in increments, determined with the command `[:SOURce<hw>]:POWER:STEP[:INCRement]`.

*RST: DECimal

Example:

`SOURce1:POWER:STEP:INCRement 2`

`SOURce1:POWER:STEP:MODE USER`

`SOURce1:POWER:LEVel:IMMediate:AMPLitude UP`

Increasing the RF level with a step size of 2 dB

Manual operation: See "[Variation Active](#)" on page 61

[:SOURce<hw>]:POWER:STEP[:INCRement] <Increment>

Specifies the step width in the appropriate path for `POW:STEP:MODE USER`.

To adjust the level step-by-step with this increment value, use the command `POW UP`, or `POW DOWN`.

Note: The command also sets "Variation Step" in the manual control, that means the user-defined step width for setting the level with the rotary knob or the [Up/Down] arrow keys.

Parameters:

<Increment> float
 Range: 0 to 200
 Increment: 0.01
 *RST: 1
 Default unit: dB

Example: See [:SOURce<hw>]:POWER:STEP:MODE on page 455.

Manual operation: See "Variation Step" on page 61

[:SOURce<hw>]:POWER[:LEVel][:IMMediate]:OFFSet <Offset>

Sets the level offset of a downstream instrument.

The level at the RF output is not changed.

To query the resulting level, as it is at the output of the downstream instrument, use the command [:SOURce<hw>]:POWER[:LEVel][:IMMediate][:AMPLitude].

See "RF frequency and level display with a downstream instrument" on page 58.

Note: The level offset also affects the RF level sweep.

Parameters:

<Offset> float
 Range: -100 to 100
 Increment: 0.01
 *RST: 0
 Default unit: dB
 Level offset is always expreced in dB; linear units (V, W, etc.) are not supported

Example: POWER:OFFSet 10
 Sets the RF level offset to 10 dB

Manual operation: See " Offset " on page 63

[:SOURce<hw>]:POWER[:LEVel][:IMMediate]:RCL <Rcl>

Determines whether the current level is retained or if the stored level setting is adopted when an instrument configuration is loaded.

Parameters:

<Rcl> INCLUDE | EXCLUDE
INCLUDE
 Takes the current level when an instrument configuration is loaded.

EXCLude

Retains the current level when an instrument configuration is loaded.

*RST: INCLude

Example:

POW:RCL INCL

Takes the level value from an instrument configuration loaded with command *RCL.

Manual operation: See "Exclude Level" on page 201

[:SOURce<hw>]:POWer[:LEVel][:IMMediate][:AMPLitude] <Amplitude>

Sets the RF level applied to the DUT.

To activate the RF output use command :OUTPut<hw>[:STATe] ("RF On"/"RF Off").

The following applies $POWer = RF\ output\ level + OFFSet$, where:

- $POWer$ is the values set with `[:SOURce<hw>]:POWer[:LEVel][:IMMediate][:AMPLitude]`
- RF output level is set with `[:SOURce<hw>]:POWer:POWer`
- $OFFSet$ is set with `[:SOURce<hw>]:POWer[:LEVel][:IMMediate]:OFFSet`

Parameters:

<Amplitude> float

The following settings influence the value range:

$OFFSet$ set with the command `[:SOURce<hw>]:POWer[:LEVel][:IMMediate]:OFFSet`

Numerical value

Sets the level

UP|DOWN

Varies the level step by step.

The level is increased or decreased by the value set with the command `[:SOURce<hw>]:POWer:STEP[:INCRement]`.

Range: (Level_min + OFFSet) to (Level_max + OFFSet)

*RST: -30

Default unit: dBm

Example:

POWer -30

Sets the RF level

Example:

See also `[:SOURce<hw>]:POWer:STEP:MODE` on page 455.

Manual operation: See "Amplitude" on page 63

[:SOURce<hw>]:POWer:RANGe:LOWer?

[:SOURce<hw>]:POWer:RANGe:UPPer?

Queries the current interruption-free range of the level.

Return values:

<Upper> float
 Increment: 0.01
 Default unit: dBm

Example:

```
SOURce1:POWer:RANGe:UPPer?
// -15
SOURce1:POWer:RANGe:LOW?
// -50
```

Usage: Query only

Manual operation: See " [Level Range](#) " on page 64

[[:SOURce]:POWer:WIGNore <State>

Ignores level range warnings.

Parameters:

<State> 0 | 1 | OFF | ON
 *RST: n.a. (factory preset: 0)

Example: SOURce:POWer:WIGNore 1

12.14.11 SOURce:ROSCillator Subsystem

The SOURce:ROSCillator subsystem contains the commands for setting the external and internal reference frequency.



The commands of this subsystem are not affected by an instrument reset (*RST on page 324).

Example: Configuring the reference oscillator

```
// Using 100 MHz external reference source
SOURce:ROSCillator:PRESet
SOURce:ROSCillator:SOURce EXT
SOURce:ROSCillator:EXTernal:RFOff:STATe 1
SOURce:ROSCillator:EXTernal:FREQuency 100MHZ
SOURce:ROSCillator:EXTernal:SBANDwidth WIDE
// 100 MHz (loop through) and 1 GHz output
SOURce:ROSCillator:OUTPut:FREQuency:MODE LOOP
SOURce:ROSCillator:OUTPut:ALternate:FREQuency:MODE DER1G
SOURce:ROSCillator:INTernal:ADJust:STATe 0

// Variable external reference frequency
// SOURce:ROSCillator:EXTernal:FREQuency VAR
// SOURce:ROSCillator:EXTernal:FREQuency:VARIable 10000000

// Using the internal reference frequency
SOURce:ROSCillator:SOURce INT
SOURce:ROSCillator:INTernal:TUNing:STATe 1
SOURce:ROSCillator:INTernal:TUNing:SLOPe LOW
// 10 MHz and 1 GHz output
SOURce:ROSCillator:OUTPut:FREQuency:MODE DER10M
SOURce:ROSCillator:OUTPut:ALternate:FREQuency:MODE DER1G

// Query calibration value
CALibration:ROSCillator?
// 32767
// Set an internal source
// Activate user-defined adjustment value of 1000
SOURce:ROSCillator:SOURce INT
SOURce:ROSCillator:INTernal:ADJust:STATe 1
SOURce:ROSCillator:INTernal:ADJust:VALue 1000

// to resume calibrated state
SOURce:ROSCillator:INTernal:ADJust:VALue 0
SOURce:ROSCillator:INTernal:ADJust:STATe 0
// or
// SYSTem:FPRest
```

[:SOURce]:ROSCillator:PRESet	460
[:SOURce]:ROSCillator:SOURce	460
[:SOURce]:ROSCillator:EXTernal:RFOff[:STATe]	460
[:SOURce]:ROSCillator:EXTernal:FREQuency	460
[:SOURce]:ROSCillator:EXTernal:FREQuency:VARIable	460
[:SOURce]:ROSCillator:EXTernal:SBANDwidth	461
[:SOURce]:ROSCillator:EXTernal:MLRange?	461
[:SOURce]:ROSCillator:EXTernal:NSBandwidth?	462
[:SOURce]:ROSCillator:OUTPut:FREQuency:MODE	462
[:SOURce]:ROSCillator:OUTPut:ALternate:FREQuency:MODE	462
[:SOURce]:ROSCillator[:INTernal]:ADJust:VALue	463
[:SOURce]:ROSCillator[:INTernal]:ADJust[:STATe]	463

[[:SOURce]:ROSCillator:PRESet

Resets the reference oscillator settings.

Example: See [Example "Configuring the reference oscillator"](#) on page 459.

Usage: Event

Manual operation: See ["Set to Default"](#) on page 182

[[:SOURce]:ROSCillator:SOURce <Source>

Selects between internal or external reference frequency.

Parameters:

<Source> INTernal | EXTernal
*RST: n.a. (factory preset: INTernal)

Example: See [Example "Configuring the reference oscillator"](#) on page 459.

Manual operation: See ["Source"](#) on page 182

[[:SOURce]:ROSCillator:EXTernal:RFOFF[:STATe] <State>

Determines that the RF output is turned off when the external reference signal is selected, but missing.

Parameters:

<State> 0 | 1 | OFF | ON
*RST: n.a. (factory preset: 0)

Example: See [Example "Configuring the reference oscillator"](#) on page 459.

Manual operation: See ["Deactivate RF Output \(if external reference is missing\)"](#) on page 182

[[:SOURce]:ROSCillator:EXTernal:FREQUENCY <Frequency>

Sets the frequency of the external reference.

Parameters:

<Frequency> 100MHZ | 1GHZ | VARiable | 10MHZ
*RST: n.a. (factory preset: 10MHZ)

Example: See [Example "Configuring the reference oscillator"](#) on page 459.

Options: VARiable requires R&S SMBB-K704
1GHZ requires R&S SMBB-B3

Manual operation: See ["External Reference Frequency"](#) on page 182

[[:SOURce]:ROSCillator:EXTernal:FREQUENCY:VARiable <Frequency>

Specifies the user-defined external reference frequency.

Parameters:

<Frequency> float
 Range: 1E6 to 100E6
 Increment: 0.1
 *RST: n.a. (factory preset: 1E7)
 Default unit: Hz

Example: See [Example "Configuring the reference oscillator"](#) on page 459.

Options: R&S SMBB-K704

Manual operation: See ["Variable Reference Frequency"](#) on page 183

[[:SOURce]:ROSCillator:EXTernal:SBANDwidth <SBandwidth>

Selects the synchronization bandwidth for the external reference signal.

Depending on the RF hardware version, and the installed options, the synchronisation bandwidth varies.

For more information, see data sheet.

Parameters:

<SBandwidth> WIDE | NARRow
NARRow
 The synchronization bandwidth is a few Hz.
WIDE
 Uses the widest possible synchronization bandwidth.
 *RST: n.a. (factory preset)

Example: See [Example "Configuring the reference oscillator"](#) on page 459.

Manual operation: See ["Synchronization Bandwidth"](#) on page 183

[[:SOURce]:ROSCillator:EXTernal:MLRange?

Queries the minimum locking range for the selected external reference frequency.

Depending on the RF hardware version, and the installed options, the minimum locking range varies.

For more information, see data sheet.

Return values:

<MinLockRange> string

Example: SOUR:ROSC:EXT:MLR?

Usage: Query only

Manual operation: See ["Minimum Locking Range"](#) on page 183

[[:SOURce]:ROSCillator:EXTernal:NSBandwidth?

Queries the nominal synchronization bandwidth for the selected external reference frequency and synchronization bandwidth.

Return values:

<NomBandwidth> string

Example: SOUR:ROSC:EXT:NSB?

Usage: Query only

Manual operation: See "[Nominal Synchronization Bandwidth](#)" on page 183

[[:SOURce]:ROSCillator:OUTPut:FREQUENCY:MODE <OutpFreqMode>

Selects the mode for the output reference frequency.

Parameters:

<OutpFreqMode> DER10M | OFF | LOOPthrough

OFF

Disables the output.

DER10M

Sets the output reference frequency to 10 MHz.

The reference frequency is derived from the internal reference frequency.

LOOPthrough

This option is unavailable for

ROSCillator:EXTernal:FREQUENCY 1GHZ. Forwards the input reference frequency to the reference frequency output.

*RST: n.a. (factory preset: DER10M)

Example: See [Example "Configuring the reference oscillator"](#) on page 459.

Manual operation: See "[Reference Output/1 GHz Reference Output](#)" on page 184

[[:SOURce]:ROSCillator:OUTPut:ALTErnate:FREQUENCY:MODE <OutpFreqMode>

Sets the output reference frequency.

Parameters:

<OutpFreqMode> LOOPthrough | DER1G | OFF

OFF

Disables the output.

DER1G

Sets the output reference frequency to 1 GHz.

The reference frequency is derived from the internal reference frequency.

LOOPthrough

If `[:SOURce] :ROSCillator:EXTernal:FREQuency1GHZ`, forwards the input reference frequency to the reference frequency output.

*RST: n.a. (factory preset: OFF)

Example: See [Example "Configuring the reference oscillator"](#) on page 459.

Options: DER1G requires R&S SMBB-B3

Manual operation: See ["Reference Output/1 GHz Reference Output"](#) on page 184

`[:SOURce] :ROSCillator[:INTernal]:ADJust:VALue <Value>`

Specifies the frequency correction value (adjustment value).

Parameters:

<Value> integer

*RST: 0

Example: See `[:SOURce] :ROSCillator[:INTernal]:ADJust[:STATe]` on page 463

Manual operation: See ["Adjustment Value"](#) on page 185

`[:SOURce] :ROSCillator[:INTernal]:ADJust[:STATe] <State>`

Determines whether the calibrated (off) or a user-defined (on) **adjustment value** is used for fine adjustment of the frequency.

Parameters:

<State> 0 | 1 | OFF | ON

0

Fine adjustment with the calibrated frequency value

1

User-defined adjustment value.

The instrument is no longer in the calibrated state.

The calibration value is, however, not changed. The instrument resumes the calibrated state if you send

`SOURce:ROSCillator:INTernal:ADJust:STATe 0`.

*RST: n.a. (factory preset: 0)

Example: See [Example "Configuring the reference oscillator"](#) on page 459.

Manual operation: See ["Adjustment Active"](#) on page 185

12.14.12 SOURce:SWEep Subsystem

The `SOURce:SWEep` subsystem contains the commands for configuring RF sweep signals.



- The keyword [:FREQuency] can be omitted, then the commands are SCPI-compliant.
- To activate an RF sweep mode, use the following commands:
 - RF frequency sweep: SOURce:FREQuency:MODE SWEEp (SOURce:FREQuency:MODE CW (off))
 - RF level sweep: SOURce:POWEr:MODE SWEEp (SOURce:POWEr:MODE CW (off))
 - RF combined sweep: SOURce:FREQuency:MODE SWEEp (SOURce:FREQuency:MODE CW (off))
- All sweeps, including the LF sweep, can be set independently of each other.
- All sweeps can be set independently of each other.

See [Chapter 6.1, "Signal Generation and Triggering in the Sweep and List Modes"](#), on page 111.

Example: Setup an RF frequency or power sweep

The following example shows a command sequence to set up an RF frequency sweep, triggered by the execute command. For an RF power sweep, replace FREQuency in the SWEEp commands with POWEr.

Exceptions are the power spacing (defined with LINear only) and the power step width (defined with LOGarithmic only).

```
// Reset the instrument to start from an initial state
// Switch off display update to improve performance
// (especially with short dwell times)
// Set the sweep mode (first two commands) and the sweep range
// Select linear spacing
// Select the waveform shape for the frequency sweep
*RST; *CLS
SYSTEM:DISPlay:UPDate OFF
TRIGger1:FSWep:SOURce SINGLE
SOURce1:SWEEp:FREQuency:MODE AUTO
SOURce1:FREQuency:SPAN 300 MHz
SOURce1:FREQuency:CENTer 200 MHz
// Alternatively use
// SOURce1:FREQuency:STARt 50 MHz
// SOURce1:FREQuency:STOP 350 MHz
SOURce1:SWEEp:FREQuency:SPACing LINear
SOURce1:SWEEp:FREQuency:SHAPE SAWTooth

// Activate change to start frequency while waiting for next trigger
// Prerequisites: sweep mode single and sweep waveform sawtooth
SOURce1:SWEEp:FREQuency:RETRace 1
// Alternatively reset all sweeps to their initial value
SOURce1:SWEEp:RESet:ALL

// Set the step width and dwell time
```

```

SOURCE1:SWEep:FREQuency:STEP:LINear 1 MHz
// Alternatively set the number of steps, then the sweep step width is
// set automatically
SOURCE1:SWEep:FREQuency:POINTs 301
SOURCE1:SWEep:FREQuency:DWELL 500 ms
// With logarithmic spacing select the step width as follows
// (steps of 10 percent of the previous frequency in each instance)
SOURCE1:SWEep:FREQuency:SPACing LOG
SOURCE1:SWEep:FREQuency:STEP:LOGarithmic 10PCT

// Activate the sweep
// Trigger the sweep (depending on the set mode) and query the status
SOURCE1:FREQuency:MODE SWEep
// Perform a one-off RF frequency sweep
SOURCE1:SWEep:FREQuency:EXECute
SOURCE1:SWEep:FREQuency:RUNning?
// 1
// the frequency sweep is running

// For manual step RF sweep use the following commands
*RST; *CLS
// Activate manual step RF sweep
SOURCE1:SWEep:FREQuency:MODE MANual
// Activate the RF frequency sweep.
SOURCE1:FREQuency:MODE SWEep
// Activate RF Output1.
Output1:STATe 1
// Input the frequency manually for each step
SOURCE1:FREQuency:MANual 200 MHz
SOURCE1:FREQuency:MANual 201 MHz
// Alternatively use the UP or DOWN commands with the set step width.
SOURCE1:SWEep:FREQuency:STEP:LINear 1 MHz
SOURCE1:FREQuency:MANual UP

// Activate combined RF frequency / level sweep
*RST; *CLS
*RST; *CLS
SYSTEM:DISPlay:UPDate OFF
TRIGger1:FSWep:SOURce SINGLE
SOURCE1:SWEep:COMBined:MODE AUTO
SOURCE1:SWEep:COMBined:COUNT 200
SOURCE1:FREQuency:START 1000000000 Hz
SOURCE1:FREQuency:STOP 5000000000 Hz
SOURCE1:POWer:START -30 dBm
SOURCE1:POWer:STOP -10 dBm
SOURCE1:SWEep:COMBined:RETRace 1
SOURCE1:SWEep:COMBined:SHAPE SAWT
SOURCE1:SWEep:COMBined:DWELL 0.01
// Activate combined RF frequency/level sweep
SOURCE1:FREQuency:MODE CW

```

```
// Activate RF Output1.
Output1:STATE 1
// Execute combined frequency / level sweep
SOURce1:SWEep:COMBined:EXECute
```

[SOURce<hw>]:SWEep:POWer:DWELI.....	466
[SOURce<hw>]:SWEep:POWer:MODE.....	467
[SOURce<hw>]:SWEep:POWer:POINts.....	467
[SOURce<hw>]:SWEep:POWer:SPACing:MODE?.....	467
[SOURce<hw>]:SWEep:POWer:STEP[:LOGarithmic].....	468
[SOURce<hw>]:SWEep[:FREQuency]:DWELI.....	468
[SOURce<hw>]:SWEep[:FREQuency]:MODE.....	468
[SOURce<hw>]:SWEep[:FREQuency]:POINts.....	469
[SOURce<hw>]:SWEep[:FREQuency]:SPACing.....	469
[SOURce<hw>]:SWEep:POWer:SHAPE.....	470
[SOURce<hw>]:SWEep[:FREQuency]:SHAPE.....	470
[SOURce<hw>]:SWEep:POWer:EXECute.....	470
[SOURce<hw>]:SWEep[:FREQuency]:EXECute.....	470
[SOURce<hw>]:SWEep:POWer:RETRace.....	470
[SOURce<hw>]:SWEep[:FREQuency]:RETRace.....	470
[SOURce<hw>]:SWEep:POWer:RUNNing?.....	471
[SOURce<hw>]:SWEep[:FREQuency]:RUNNing?.....	471
[SOURce<hw>]:SWEep[:FREQuency]:STEP:LOGarithmic.....	471
[SOURce<hw>]:SWEep[:FREQuency]:STEP[:LINear].....	471
[SOURce<hw>]:COMBined:FREQuency:START.....	471
[SOURce<hw>]:COMBined:FREQuency:STOP.....	472
[SOURce<hw>]:COMBined:POWer:START.....	472
[SOURce<hw>]:COMBined:POWer:STOP.....	472
[SOURce<hw>]:SWEep:COMBined:COUNT.....	473
[SOURce<hw>]:SWEep:COMBined:DWELI.....	473
[SOURce<hw>]:SWEep:COMBined:EXECute.....	473
[SOURce<hw>]:SWEep:COMBined:MODE.....	474
[SOURce<hw>]:SWEep:COMBined:RETRace.....	474
[SOURce<hw>]:SWEep:COMBined:SHAPE.....	474
[SOURce<hw>]:SWEep:RESet[:ALL].....	475

[SOURce<hw>]:SWEep:POWer:DWELI <Dwell>

Sets the dwell time for a level sweep step.

Parameters:

<Dwell>	float
	Range: 0.001 to 100
	Increment: 100E-6
	*RST: 0.01

Example: See [Example "Setup an RF frequency or power sweep"](#) on page 464.

Manual operation: See " [Dwell Time](#) " on page 130

[:SOURce<hw>] :SWEep:POWer:MODE <Mode>

Sets the cycle mode for the level sweep.

Parameters:

<Mode> AUTO | MANual | STEP

AUTO

Each trigger triggers exactly one complete sweep.

MANual

The trigger system is not active. You can trigger every step individually with the command [:SOURce<hw>] :POWer:MANual.

The level value increases at each step by the value that you define with [:SOURce<hw>] :POWer:STEP [:INCRement].

Values directly entered with the command [:SOURce<hw>] :POWer:MANual are not taken into account.

STEP

Each trigger triggers one sweep step only. The level increases by the value entered with [:SOURce<hw>] :POWer:STEP [:INCRement].

*RST: AUTO

Example: See [Example "Setup an RF frequency or power sweep"](#) on page 464.

Manual operation: See ["Mode"](#) on page 127

[:SOURce<hw>] :SWEep:POWer:POINts <Points>

Sets the number of steps within the RF level sweep range.

See [Chapter 6.2.1, "Correlating Parameters in Sweep Mode"](#), on page 119.

Parameters:

<Points> integer

Range: 2 to Max

Example: See [Example "Setup an RF frequency or power sweep"](#) on page 464.

[:SOURce<hw>] :SWEep:POWer:SPACing:MODE?

Queries the level sweep spacing. The sweep spacing for level sweeps is always linear.

Return values:

<Mode> LINear

*RST: LINear

Example: SWE : POW : SPAC : MODE?
queries the sweep spacing for a level sweep at RF output.
Result: "LIN"
linear spacing

Usage: Query only

[[:SOURce<hw>]:SWEep:POWER:STEP[:LOGarithmic] <Logarithmic>

Sets a logarithmically determined step size for the RF level sweep. The level is increased by a logarithmically calculated fraction of the current level.

See [Chapter 6.2.1, "Correlating Parameters in Sweep Mode"](#), on page 119.

Parameters:

<Logarithmic> float
 The unit dB is mandatory.
 Range: 0.01 to 139 dB
 Increment: 0.01
 *RST: 1
 Default unit: dB

Example: See [Example "Setup an RF frequency or power sweep"](#) on page 464.

Manual operation: See "[Step](#)" on page 134

[[:SOURce<hw>]:SWEep[:FREQUENCY]:DWEll <Dwell>

Sets the dwell time for a frequency sweep step.

Parameters:

<Dwell> float
 Range: 0.001 to 100
 Increment: 100E-6
 *RST: 0.01

Example: See [Example "Setup an RF frequency or power sweep"](#) on page 464.

Manual operation: See "[Dwell Time](#)" on page 130

[[:SOURce<hw>]:SWEep[:FREQUENCY]:MODE <Mode>

Sets the cycle mode for the frequency sweep.

Parameters:

<Mode> AUTO | MANual | STEP

AUTO

Each trigger event triggers exactly one complete sweep.

MANual

The trigger system is not active. You can trigger every step individually by input of the frequencies with the command [:

[SOURce<hw>\]:FREQUENCY:MANual.](#)

STEP

Each trigger event triggers one sweep step. The frequency increases by the value entered with `[:SOURce<hw>] :SWEep [:FREQuency] :STEP [:LINear]` (linear spacing) or `[:SOURce<hw>] :SWEep [:FREQuency] :STEP:LOGarithmic` (logarithmic spacing).

*RST: AUTO

Example: See [Example "Setup an RF frequency or power sweep"](#) on page 464.

Manual operation: See ["Mode"](#) on page 127

[:SOURce<hw>] :SWEep [:FREQuency] :POINts <Points>

Sets the number of steps within the RF frequency sweep range.

See [Chapter 6.2.1, "Correlating Parameters in Sweep Mode"](#), on page 119.

Two separate `POINts` values are used for linear or logarithmic sweep spacing (`[:SOURce<hw>] :SWEep [:FREQuency] :SPACing LIN | LOG`). The command always affects the currently set sweep spacing.

Parameters:

<Points> integer
Range: 2 to Max

Example: See [Example "Setup an RF frequency or power sweep"](#) on page 464.

[:SOURce<hw>] :SWEep [:FREQuency] :SPACing <Spacing>

Selects the mode for the calculation of the frequency intervals, with which the current frequency at each step is increased or decreased.

The keyword `[:FREQuency]` can be omitted; then the command is SCPI-compliant.

Parameters:

<Spacing> LINear | LOGarithmic

LINear

Sets a fixed frequency value as step width and adds it to the current frequency.

The linear step width is entered in Hz, see `[:SOURce<hw>] :SWEep [:FREQuency] :STEP [:LINear]`.

LOGarithmic

Sets a constant fraction of the current frequency as step width and adds it to the current frequency.

The logarithmic step width is entered in %, see `[:SOURce<hw>] :SWEep [:FREQuency] :STEP:LOGarithmic`.

*RST: LINear

Example: See [Example "Setup an RF frequency or power sweep"](#) on page 464.

Manual operation: See "[Spacing](#)" on page 130

```
[ :SOURce<hw>]:SWEep:POWer:SHAPE <Shape>
[:SOURce<hw>]:SWEep[:FREQuency]:SHAPE <Shape>
```

Determines the waveform shape for a frequency sweep sequence.

Parameters:

<Shape> SAWTooth | TRIangle
*RST: SAWTooth

Example: See [Example "Setup an RF frequency or power sweep"](#) on page 464.

Manual operation: See "[Shape](#)" on page 128

```
[ :SOURce<hw>]:SWEep:POWer:EXECute
[:SOURce<hw>]:SWEep[:FREQuency]:EXECute
```

Executes an RF frequency sweep.

The command performs a single sweep and is therefore only effective in manual sweep mode.

Example: See [Example "Setup an RF frequency or power sweep"](#) on page 464.

Usage: Event

Manual operation: See "[Execute Single Sweep](#)" on page 131

```
[ :SOURce<hw>]:SWEep:POWer:RETRace <State>
[:SOURce<hw>]:SWEep[:FREQuency]:RETRace <State>
```

Activates that the signal changes to the start frequency value while it is waiting for the next trigger event.

You can enable this feature, when you are working with sawtooth shapes in sweep mode "Single" or "External Single".

Parameters:

<State> 0 | 1 | OFF | ON
*RST: 0

Example: See [Example "Setup an RF frequency or power sweep"](#) on page 464.

Manual operation: See "[Retrace](#)" on page 128

**[[:SOURce<hw>]:SWEep:POWer:RUNNing?
[:SOURce<hw>]:SWEep[:FREQuency]:RUNNing?**

Queries the current sweep state.

Return values:

<State> 0 | 1 | OFF | ON

Example: See [Example "Setup an RF frequency or power sweep"](#) on page 464.

Usage: Query only

[[:SOURce<hw>]:SWEep[:FREQuency]:STEP:LOGarithmic <Logarithmic>

Sets a logarithmically determined step width for the RF frequency sweep. The value is added at each sweep step to the current frequency.

See [Chapter 6.2.1, "Correlating Parameters in Sweep Mode"](#), on page 119.

Parameters:

<Logarithmic> float
 The unit is mandatory.
 Range: 0.01 to 100
 Increment: 1E-3
 *RST: 1
 Default unit: PCT

Example: See [Example "Setup an RF frequency or power sweep"](#) on page 464.

Manual operation: See "[Step Linear/Step Logarithmic](#)" on page 133

[[:SOURce<hw>]:SWEep[:FREQuency]:STEP[:LINear] <Linear>

Sets the step width for linear sweeps.

See [Chapter 6.2.1, "Correlating Parameters in Sweep Mode"](#), on page 119.

Omit the optional keywords so that the command is SCPI-compliant.

Parameters:

<Linear> float
 Range: 0.001 Hz to (STOP - START)
 Increment: 0.01

Example: See [Example "Setup an RF frequency or power sweep"](#) on page 464.

Manual operation: See "[Step Linear/Step Logarithmic](#)" on page 133

[[:SOURce<hw>]:COMBined:FREQuency:START <CombFreqStart>

Sets the start frequency of the combined RF frequency / level sweep.

See [Chapter 6.2.1, "Correlating Parameters in Sweep Mode"](#), on page 119.

Parameters:

<CombFreqStart> float
 Range: -59999E5 to 12E9
 Increment: 0.01
 *RST: 100E6

Example: See [Example "Setup an RF frequency or power sweep"](#) on page 464.

Manual operation: See "[Start Frequency/Stop Frequency](#)" on page 132

[:SOURce<hw>]:COMBined:FREQUency:STOP <CombFreqStop>

Sets the end frequency of the combined RF frequency / level sweep.

Parameters:

<CombFreqStop> float
 Range: -59999E5 to 12E9
 Increment: 0.01
 *RST: 500E6

Example: See [Example "Setup an RF frequency or power sweep"](#) on page 464.

Manual operation: See "[Start Frequency/Stop Frequency](#)" on page 132

[:SOURce<hw>]:COMBined:POWER:START <CombPowStart>

Sets the start level value of the combined RF frequency / level sweep.

See [Chapter 6.2.1, "Correlating Parameters in Sweep Mode"](#), on page 119.

Parameters:

<CombPowStart> float
 Range: -245 to 120
 Increment: 0.01
 *RST: -30

Example: See [Example "Setup an RF frequency or power sweep"](#) on page 464.

Manual operation: See "[Start Level / Stop Level](#)" on page 134

[:SOURce<hw>]:COMBined:POWER:STOP <CombPowStop>

Sets the stop level value of the combined RF frequency / level sweep.

Parameters:

<CombPowStop> float
 Range: -245 to 120
 Increment: 0.01
 *RST: -10

Example: See [Example "Setup an RF frequency or power sweep"](#) on page 464.

Manual operation: See "[Start Level / Stop Level](#)" on page 134

[:SOURce<hw>]:SWEep:COMBined:COUNT <StepCount>

Defines the number of sweeps you want to execute.

This parameter applies to `[:SOURce<hw>]:SWEep:COMBined:MODE > SINGLE`. To start the sweep signal generation, use the command `[:SOURce<hw>]:SWEep:COMBined:EXECute` on page 473.

Parameters:

<StepCount> integer
 Range: 1 to SeMAX_INT_STEP-1
 *RST: 501

Example: See [Example "Setup an RF frequency or power sweep"](#) on page 464.

Manual operation: See "[Step Count](#)" on page 134

[:SOURce<hw>]:SWEep:COMBined:DWELI <Dwell>

Sets the dwell time for the combined frequency / level sweep.

Parameters:

<Dwell> float
 Range: 0.01 to 100
 Increment: 100E-6
 *RST: 0.01

Example: See [Example "Setup an RF frequency or power sweep"](#) on page 464.

Manual operation: See "[Dwell Time](#)" on page 130

[:SOURce<hw>]:SWEep:COMBined:EXECute

Executes an RF frequency / level sweep cycle.

The command triggers one single sweep manually. Therefore, you can use it in manual sweep mode, selected with the command `[:SOURce<hw>]:SWEep:COMBined:MODE > MANual`.

- Example:** See [Example "Setup an RF frequency or power sweep"](#) on page 464.
- Usage:** Event
- Manual operation:** See "[Execute Single Sweep](#)" on page 131

[:SOURce<hw>] :SWEep:COMBined:MODE <SweepCombMode>

Sets the cycle mode for the combined frequency / level sweep.

Parameters:

<SweepCombMode> AUTO | MANual | STEP

AUTO

Each trigger event triggers exactly one complete sweep.

MANual

The trigger system is not active. You can trigger every step individually by input of the frequencies with the commands [:SOURce<hw>] :FREQuency:MANual and [:SOURce<hw>] :POWer:MANual.

STEP

Each trigger event triggers one sweep step.

*RST: AUTO

- Example:** See [Example "Setup an RF frequency or power sweep"](#) on page 464.
- Manual operation:** See "[Mode](#)" on page 127

[:SOURce<hw>] :SWEep:COMBined:RETRace <RetraceState>

Activates that the signal changes to the start level value while it is waiting for the next trigger event.

You can enable this feature, when you are working with sawtooth shapes in sweep mode "Single" or "External Single".

Parameters:

<RetraceState> 0 | 1 | OFF | ON

*RST: 0

- Example:** See [Example "Setup an RF frequency or power sweep"](#) on page 464.
- Manual operation:** See "[Retrace](#)" on page 128

[:SOURce<hw>] :SWEep:COMBined:SHAPE <Shape>

Selects the waveform shape for the combined frequency / level sweep sequence.

Parameters:

<Shape> SAWTooth | TRIangle
 *RST: SAWTooth

Example: See [Example "Setup an RF frequency or power sweep"](#)
 on page 464.

Manual operation: See "[Shape](#)" on page 128

[:SOURce<hw>]:SWEep:RESet[:ALL]

Resets all active sweeps to the starting point.

Usage: Event

Manual operation: See "[Reset Sweep](#)" on page 131

12.15 SYSTEM Subsystem

The SYSTEM subsystem contains a series of commands for general functions which do not directly affect signal generation.

Example: Retrieving information on network-related settings

```

SYSTEM:COMMunicate:NETWork:STATus?
// 1
SYSTEM:PROTection1:STATe 0,123456

SYSTEM:COMMunicate:NETWork:IPAddress:MODE STAT
SYSTEM:COMMunicate:NETWork:IPAddress "10.113.0.104"
SYSTEM:COMMunicate:NETWork:IPAddress:DNS "10.0.2.166"
SYSTEM:COMMunicate:NETWork:COMMON:HOSTname?
// "SMB100B-102030"
SYSTEM:COMMunicate:NETWork:COMMON:WORKgroup "instrument"
SYSTEM:COMMunicate:NETWork:COMMON:DOMAIN "rsint.net"
SYSTEM:COMMunicate:NETWork:IPAddress:GATeway "10.113.0.1"
SYSTEM:COMMunicate:NETWork:IPAddress:SUBNet:MASK "255.255.252.0"
SYSTEM:COMMunicate:NETWork:MACaddress "08 00 27 a3 a1 70"
SYSTEM:PROTection1:STATe 1

```

Example: Finding out the used VISA resource strings

```

SYSTEM:COMMunicate:NETWork:RESource?
// "TCPIP::10.113.0.104::inst0::INSTR"

SYSTEM:COMMunicate:HISLip:RESource?
// "TCPIP::10.113.0.104::hislip0::INSTR"

SYSTEM:COMMunicate:SOCKET:RESource?
// "TCPIP::10.113.0.104::5025::SOCKET"

```

```

SYSTem:COMMunicate:USB:RESource?
// "USB::0x0AAD::0x01DE::100001::INSTR"

SYSTem:COMMunicate:GPIB:RESource?
// "GPIB::28::INSTR"
SYSTem:COMMunicate:GPIB:SELF:ADDRESS?
// 28
SYSTem:COMMunicate:GPIB:LTERminator?
// STAN

SYSTem:COMMunicate:SERial:RESource?
// "ASRL1::INSTR"
SYSTem:COMMunicate:SERial:SBITs?
// 1
SYSTem:COMMunicate:SERial:BAUD?
// 115200
SYSTem:COMMunicate:SERial:PARity?
// NONE

```

Example: Querying the error queue

```

SYSTem:ERRor:STATic?
// -221,"Settings conflict", 153,"Input voltage out of range", ...
// returns all static errors that are collected in the error queue

```

```

SYSTem:ERRor:HISTory:CLear
// deletes the history entries

```

:SYSTem:ERRor:ALL?	478
:SYSTem:ERRor:CODE:ALL?	478
:SYSTem:ERRor:CODE[:NEXT]?	479
:SYSTem:ERRor:COUNT?	479
:SYSTem:ERRor[:NEXT]?	479
:SYSTem:ERRor:GNEXt?	480
:SYSTem:ERRor:HISTory:CLear	480
:SYSTem:ERRor:STATic?	480
:SYSTem:DLOCK	481
:SYSTem:KLOCK	481
:SYSTem:NINformation?	481
:SYSTem:ULOCK	482
:SYSTem:LOCK:OWNer?	482
:SYSTem:LOCK:RELease:ALL	482
:SYSTem:LOCK:REQuest[:EXCLusive]?	483
:SYSTem:SAV	483
:SYSTem:RCL	483
:SYSTem:PROTect<ch>[:STATe]	483
:SYSTem:SECurity:VOLMode[:STATe]	484
:SYSTem:COMMunicate:GPIB:LTERminator	484
:SYSTem:COMMunicate:GPIB:RESource?	485
:SYSTem:COMMunicate:GPIB[:SELF]:ADDRESS	485
:SYSTem:COMMunicate:HISLip:RESource?	485

:SYSTem:COMMunicate:NETWork:IPADdress.....	485
:SYSTem:COMMunicate:NETWork:IPADdress:MODE.....	486
:SYSTem:COMMunicate:NETWork:MACaddress.....	486
:SYSTem:COMMunicate:NETWork:RESource?.....	486
:SYSTem:COMMunicate:NETWork:RESart.....	487
:SYSTem:COMMunicate:NETWork:STATus?.....	487
:SYSTem:COMMunicate:NETWork[:COMMon]:DOMain.....	487
:SYSTem:COMMunicate:NETWork[:COMMon]:HOSTname.....	487
:SYSTem:COMMunicate:NETWork[:COMMon]:WORKgroup.....	488
:SYSTem:COMMunicate:NETWork[:IPADdress]:DNS.....	488
:SYSTem:COMMunicate:NETWork[:IPADdress]:GATeway.....	488
:SYSTem:COMMunicate:NETWork[:IPADdress]:SUBNet:MASK.....	488
:SYSTem:COMMunicate:SERial:BAUD.....	488
:SYSTem:COMMunicate:SERial:PARity.....	489
:SYSTem:COMMunicate:SERial:RESource?.....	489
:SYSTem:COMMunicate:SERial:SBITs.....	489
:SYSTem:COMMunicate:SOCKet:RESource?.....	489
:SYSTem:COMMunicate:USB:RESource?.....	490
:SYSTem:HELP:EXPort.....	490
:SYSTem:IDENtification.....	490
:SYSTem:IDENtification:PRESet.....	491
:SYSTem:IREsponse.....	491
:SYSTem:OREsponse.....	491
:SYSTem:LANGuage.....	492
:SYSTem:INFormaTion:SCPI.....	492
:SYSTem:SECurity:SANitize[:STATe].....	492
:SYSTem:SECurity:SUPolicy.....	492
:SYSTem:SPECification?.....	492
:SYSTem:SPECification:VERsion.....	493
:SYSTem:SPECification:IDENtification:CATalog?.....	494
:SYSTem:SPECification:PARAmeter?.....	494
:SYSTem:SPECification:VERsion:CATalog?.....	494
:SYSTem:SPECification:VERsion:FACTory?.....	495
:SYSTem:SRData?.....	495
:SYSTem:STARtup:COMPLete?.....	495
:SYSTem:DATE.....	495
:SYSTem:NTP:HOSTname.....	496
:SYSTem:NTP:STATe.....	496
:SYSTem:TIME.....	496
:SYSTem:TIME:ZONE.....	497
:SYSTem:TIME:ZONE:CATalog?.....	497
:SYSTem:UPTime?.....	497
:SYSTem:BIOS:VERsion?.....	497
:SYSTem:VERsion?.....	498
:SYSTem:OSYStem?.....	498
:SYSTem:MMEMory:PATH:USER?.....	498
:SYSTem:DFPR?.....	498
:SYSTem:REBoot.....	499
:SYSTem:RESart.....	499

:SYSTem:SHUTdown.....	499
:SYSTem:WAIT.....	499
:SYSTem:FILEs:TEMPorary:DELeTe.....	499

:SYSTem:ERRor:ALL?

Queries the error/event queue for all unread items and removes them from the queue.

Return values:

<All> string
 Error/event_number,"Error/event_description>[:Device-dependent info]"
 A comma separated list of error number and a short description of the error in FIFO order.
 If the queue is empty, the response is 0, "No error"
 Positive error numbers are instrument-dependent. Negative error numbers are reserved by the SCPI standard.
 Volatile errors are reported once, at the time they appear. Identical errors are reported repeatedly only if the original error has already been retrieved from (and hence not any more present in) the error queue.

Example:

```
SYST:ERR:ALL?
Queries all entries in the error queue.
Response: 0, 'no error'
No errors have occurred since the error queue was last read out.
```

Usage: Query only

Manual operation: See "[Clear History](#)" on page 534

:SYSTem:ERRor:CODE:ALL?

Queries the error numbers of all entries in the error queue and then deletes them.

Return values:

<All> string
 Returns the error numbers. To retrieve the entire error text, send the command :SYSTem:ERRor:ALL?.
0
 "No error", i.e. the error queue is empty
Positive value
 Positive error numbers denote device-specific errors
Negative value
 Negative error numbers denote error messages defined by SCPI.

Example:

```
SYST:ERR:CODE:ALL
Queries all entries in the error queue.
Response: 0
No errors have occurred since the error queue was last read out.
```

Usage: Query only

:SYSTem:ERRor:CODE[:NEXT]?

Queries the error number of the oldest entry in the error queue and then deletes it.

Return values:

<Next> string
Returns the error number. To retrieve the entire error text, send the command :SYSTem:ERRor:ALL?.

0

"No error", i.e. the error queue is empty

Positive value

Positive error numbers denote device-specific errors

Negative value

Negative error numbers denote error messages defined by SCPI.

Example:

SYST:ERR:CODE

Queries the oldest entry in the error queue.

Response: 0

No errors have occurred since the error queue was last read out.

Usage: Query only

:SYSTem:ERRor:COUNT?

Queries the number of entries in the error queue.

Return values:

<Count> integer

0

The error queue is empty.

Example:

SYST:ERR:COUN

Queries the number of entries in the error queue.

Response: 1

One error has occurred since the error queue was last read out.

Usage: Query only

:SYSTem:ERRor[:NEXT]?

Queries the error/event queue for the oldest item and removes it from the queue.

Return values:

<Next> string
Error/event_number,"Error/event_description>[:Device-dependent info]"
Error number and a short description of the error.

If the queue is empty, the response is 0, "No error"
 Positive error numbers are instrument-dependent. Negative error numbers are reserved by the SCPI standard.
 Volatile errors are reported once, at the time they appear. Identical errors are reported repeatedly only if the original error has already been retrieved from (and hence not any more present in) the error queue.

Example: `SYST:ERR?`
 Queries the oldest entry in the error queue.
 Response: 0, 'no error'
 No errors have occurred since the error queue was last read out.

Usage: Query only

Manual operation: See ["Static Errors/Error History"](#) on page 534

:SYSTem:ERRor:GNEXt?

Similar to `:SYSTem:ERRor[:NEXT]?`, but queries the next entry from the global persistent error/event queue.

Return values:
 <NextGlobalError> string
 Error/event number, "Error/event description" [;Device dependent info]"
 An error number and a short description of the error.
 Positive error numbers are instrument-dependent. Negative error numbers are reserved by the SCPI standard.

Example: `SYST:ERR:GNEX?`
 Returns the next error message from the global error queue.

Usage: Query only

:SYSTem:ERRor:HISTory:CLEar

Clears the error history.

Example: See [Example "Querying the error queue"](#) on page 476

Usage: Event

Manual operation: See ["Clear History"](#) on page 534

:SYSTem:ERRor:STATic?

Returns a list of all errors existing at the time when the query is started. This list corresponds to the display on the info page under manual control.

Return values:
 <StaticErrors> string

Example: See [Example "Querying the error queue"](#) on page 476

Usage: Query only
Manual operation: See ["Static Errors/Error History"](#) on page 534

:SYSTem:DLOCK <DispLockStat>

Disables the manual operation via the display, including the front panel keyboard of the instrument and the Local key.

Parameters:

<DispLockStat> 0 | 1 | OFF | ON
 *RST: n.a. (factory preset: 0)

Example: SYST:DLOC ON
 Activates the display lock. The instrument cannot be operated via the display until it has been enabled with SYST:DLOC OFF.

Manual operation: See ["User Interface"](#) on page 246
 See ["Enabling a locked user interface for manual operation"](#) on page 248

:SYSTem:KLOCK <State>

Disables the front panel keyboard of the instrument including the Local key.

Parameters:

<State> 0 | 1 | OFF | ON
 *RST: n.a. (factory preset: 0)

Example: SYST:KLOC ON
 Locks the front panel and external controls.
 To enable the controls, send SYST:KLOC OFF.

Manual operation: See ["User Interface"](#) on page 246
 See ["Enabling a locked user interface for manual operation"](#) on page 248

:SYSTem:NINformation?

Queries the oldest information message ("Error History > Level > Info") in the error/event queue.

Return values:

<NextInfo> string

Example: :SYSTem:NINformation?
 Queries the oldest entry in the info message queue.
 Response: 90,"Info;=== Instrument startup...
 ==="
 Information message containing error number 90, that states, that the instrument startup is complete.

Usage: Query only

:SYSTem:ULOCK <Mode>

Locks or unlocks the user interface of the instrument.

Parameters:

<Mode> ENABLEd | DONLy | DISabled | TOFF | VNConly

ENABLEd

Unlocks the display, the touchscreen and all controls for the manual operation.

DONLy

Locks the touchscreen and controls for the manual operation of the instrument. The display shows the current settings.

VNConly

Locks the touchscreen and controls for the manual operation, and enables remote operation over VNC. The display shows the current settings.

TOFF

Locks the touchscreen for the manual operation of the instrument. The display shows the current settings.

DISabled

Locks the display, the touchscreen and all controls for the manual operation.

*RST: n.a. (factory preset: ENABLEd)

Example:

```
:SYST:ULOC DIS
```

Activates the user interface lock, including display and controls.

Manual operation:

See "[User Interface](#)" on page 246

See "[Enabling a locked user interface for manual operation](#)" on page 248

:SYSTem:LOCK:OWNer?

Queries the sessions that have locked the instrument currently.

If an exclusive lock is set, the query returns the owner of this exclusive lock, otherwise it returns `NONE`.

Return values:

<Owner> string

Example:

```
SYST:LOCK:OWN?
```

Returns the owner of locking.

Response: `NONE`

The instrument is not locked.

Usage:

Query only

:SYSTem:LOCK:RELease:ALL

Revokes the exclusive access to the instrument.

Usage: Setting only

:SYSTEM:LOCK:REQuest[:EXCLusive]?

Queries whether a lock for exclusive access to the instrument via ethernet exists. If successful, the query returns a 1, otherwise 0.

Return values:

<Success> integer

Example:

SYST:LOCK:REQ?

Queries the state of exclusive locking.

Response: 1

The exclusive locking is active.

Usage: Query only

:SYSTEM:SAV <Pathname>

Saves the current instrument settings to a file with defined filename.

Setting parameters:

<Pathname> string

Example:

SYSTEM:SAV

"/var/user/Instrument_settings.savrcltxt"

Usage: Setting only

:SYSTEM:RCL <Pathname>

Loads a file with previously saved instrument settings.

Setting parameters:

<Pathname> string

Example:

SYSTEM:RCL

"/var/user/Instrument_settings.savrcltxt"

Usage: Setting only

:SYSTEM:PROTECT<ch>[:STATE] <State>[, <Key>]

Activates and deactivates the specified protection level.

Suffix:

<ch> Indicates the protection level.
See also "[Protection](#)" on page 240

Parameters:

<State> 0 | 1 | OFF | ON

*RST: n.a. (factory preset: 1)

Setting parameters:**<Key>** integer

The respective functions are disabled when the protection level is activated. No password is required for activation of a level. A password must be entered to deactivate the protection level. The default password for the first level is 123456. This protection level is required to unlock internal adjustments for example.

Example:

To activate protection level:

SYSTEM:PROTECT1:STATE 1

Internal adjustments or hostname cannot be changed.

To unlock protection level 1:

SYSTEM:PROTECT1:STATE 0,123456

Internal adjustments are accessible.

Manual operation: See "[Protection Level/Password](#)" on page 242**:SYSTEM:SECURITY:VOLMODE[:STATE] <SecPassWord>, <MmemProtState>**

Activates volatile mode, so that no user data can be written to the internal memory permanently.

To enable volatile mode, reboot the instrument. Otherwise the change has no effect.

Parameters:**<MmemProtState>** 0 | 1 | OFF | ON***RST:** 0**Setting parameters:****<SecPassWord>** string

Current security password

The default password is 123456.

Example:

SYSTEM:SECURITY:VOLMODE:STATE "123456", 1

SYSTEM:REBOOT

Manual operation: See "[Volatile Mode](#)" on page 245**:SYSTEM:COMMUNICATE:GPIB:LTERMINATOR <LTerminator>**

Sets the terminator recognition for remote control via GPIB interface.

Parameters:**<LTerminator>** STANDARD | EOI**EOI**

Recognizes an LF (Line Feed) as the terminator only when it is sent with the line message EOI (End of Line). This setting is recommended particularly for binary block transmissions, as binary blocks may coincidentally contain a character with value LF (Line Feed), although it is not determined as a terminator.

STANdard

Recognizes an LF (Line Feed) as the terminator regardless of whether it is sent with or without EOI.

*RST: n.a. (factory preset: STANdard)

Example: See [Example "Finding out the used VISA resource strings"](#) on page 475.

:SYSTem:COMMunicate:GPIB:RESource?

Queries the visa resource string for remote control via the GPIB interface.

To change the GPIB address, use the command `:SYSTem:COMMunicate:GPIB[:SELF]:ADDRess`.

Return values:

<Resource> string

Example: See [Example "Finding out the used VISA resource strings"](#) on page 475.

Usage: Query only

:SYSTem:COMMunicate:GPIB[:SELF]:ADDRess <Address>

Sets the GPIB address.

Parameters:

<Address> integer
 Range: 0 to 30
 *RST: 28

Example: See [Example "Finding out the used VISA resource strings"](#) on page 475.

:SYSTem:COMMunicate:HISLip:RESource?

Queries the VISA resource string. This string is used for remote control of the instrument with HiSLIP protocol.

Return values:

<Resource> string

Example: See [Example "Finding out the used VISA resource strings"](#) on page 475.

Usage: Query only

:SYSTem:COMMunicate:NETWork:IPADdress <IpAddress>

Sets the IP address.

Parameters:

<IpAddress> string
 Range: 0.0.0.0. to ff.ff.ff.ff

Example: See [Example "Retrieving information on network-related settings"](#) on page 475.

Manual operation: See ["IP Address"](#) on page 270

:SYSTEM:COMMunicate:NETWork:IPADdress:MODE <Mode>

Selects manual or automatic setting of the IP address.

Parameters:

<Mode> AUTO | STATic
 *RST: n.a. (factory preset: AUTO)

Example: See [Example "Retrieving information on network-related settings"](#) on page 475.

Example:
 SYSTEM:COMMunicate:NETWork:IPADdress:MODE
 STATic
 SYSTEM:COMMunicate:NETWork:IPADdress
 "10.113.0.105"

Manual operation: See ["Address Mode"](#) on page 270

:SYSTEM:COMMunicate:NETWork:MACaddress <MacAddress>

Queries the MAC address of the network adapter.

This is a password-protected function. Unlock the protection level 1 to access it.

Parameters:

<MacAddress> string

Example: See [Example "Retrieving information on network-related settings"](#) on page 475.

Manual operation: See ["MAC Address"](#) on page 271

:SYSTEM:COMMunicate:NETWork:RESource?

Queries the visa resource string for Ethernet instruments.

Return values:

<Resource> string

Example: See [Example "Finding out the used VISA ressource strings"](#) on page 475.

Usage: Query only

:SYSTEM:COMMunicate:NETWork:REStart

Restarts the network.

Example: `SYSTEM:COMMunicate:NETWork:REStart`
 // Terminates the network connection and sets it up again

Usage: Event

Manual operation: See ["Restart Network"](#) on page 269

:SYSTEM:COMMunicate:NETWork:STATus?

Queries the network configuration state.

Return values:
<State> 0 | 1 | OFF | ON

Example: See [Example "Retrieving information on network-related settings"](#) on page 475.

Usage: Query only

Manual operation: See ["Network Status"](#) on page 269

:SYSTEM:COMMunicate:NETWork[:COMMON]:DOMain <Domain>

Determines the primary suffix of the network domain.

Parameters:
<Domain> string

Example: See [Example "Retrieving information on network-related settings"](#) on page 475.

Manual operation: See ["DNS Suffix"](#) on page 271

:SYSTEM:COMMunicate:NETWork[:COMMON]:HOSTname <Hostname>

Sets an individual hostname for the RF signal generator.

Note:We recommend that you do not change the hostname to avoid problems with the network connection. If you change the hostname, be sure to use a unique name.

This is a password-protected function. Unlock the protection level 1 to access it.

Parameters:
<Hostname> string

Example: See [Example "Retrieving information on network-related settings"](#) on page 475.

Manual operation: See ["Hostname"](#) on page 269

:SYSTem:COMMunicate:NETWork[:COMMON]:WORKgroup <Workgroup>

Sets an individual workgroup name for the instrument.

Parameters:

<Workgroup> string

Example: See [Example "Retrieving information on network-related settings"](#) on page 475.

Manual operation: See ["Workgroup"](#) on page 270

:SYSTem:COMMunicate:NETWork[:IPAddress]:DNS <DNS>

Determines or queries the network DNS server to resolve the name.

Parameters:

<DNS> string

Example: See [Example "Retrieving information on network-related settings"](#) on page 475.

Manual operation: See ["DNS Server"](#) on page 271

:SYSTem:COMMunicate:NETWork[:IPAddress]:GATeway <Gateway>

Sets the IP address of the default gateway.

Parameters:

<Gateway> string
Range: 0.0.0.0 to ff.ff.ff.ff

Example: See [Example "Retrieving information on network-related settings"](#) on page 475.

Manual operation: See ["Default Gateway"](#) on page 271

:SYSTem:COMMunicate:NETWork[:IPAddress]:SUBNet:MASK <Mask>

Sets the subnet mask.

Parameters:

<Mask> string

Example: See [Example "Retrieving information on network-related settings"](#) on page 475.

Manual operation: See ["Subnet Mask"](#) on page 270

:SYSTem:COMMunicate:SERial:BAUD <Baud>

Defines the baudrate for the serial remote control interface.

Parameters:

<Baud> 2400 | 4800 | 9600 | 19200 | 38400 | 57600 | 115200
 *RST: n.a. (factory preset: 115200)

Example: See [Example "Finding out the used VISA resource strings"](#) on page 475.

Manual operation: See ["Baud Rate"](#) on page 273

:SYSTem:COMMunicate:SERial:PARity <Parity>

Enters the parity for the serial remote control interface.

Parameters:

<Parity> NONE | ODD | EVEN
 *RST: n.a. (factory preset: NONE)

Example: See [Example "Finding out the used VISA resource strings"](#) on page 475.

Manual operation: See ["Parity"](#) on page 273

:SYSTem:COMMunicate:SERial:RESource?

Queries the visa resource string for the serial remote control interface. This string is used for remote control of the instrument.

Return values:

<Resource> string

Example: See [Example "Finding out the used VISA resource strings"](#) on page 475.

Usage: Query only

:SYSTem:COMMunicate:SERial:SBITs <SBits>

Defines the number of stop bits for the serial remote control interface.

Parameters:

<SBits> 1 | 2
 *RST: n.a. (factory preset: 1)

Example: See [Example "Finding out the used VISA resource strings"](#) on page 475.

Manual operation: See ["Stop Bits"](#) on page 273

:SYSTem:COMMunicate:SOCKet:RESource?

Queries the visa resource string for remote control via LAN interface, using TCP/IP socket protocol.

Return values:

<Resource> string

Example:See [Example "Finding out the used VISA resource strings"](#) on page 475.**Usage:**

Query only

:SYSTem:COMMunicate:USB:RESource?

Queries the visa resource string for remote control via the USB interface.

Return values:

<Resource> string

Example:See [Example "Finding out the used VISA resource strings"](#) on page 475.**Usage:**

Query only

:SYSTem:HELP:EXPort

Saves the online help as zip archive in the user directory.

Example:

```
:SYSTem:HELP:EXPort
MMEM:CDIR?
// "/var/user"
MMEM:CAT?
// ..,"Log,DIR,4096","help.tgz,BIN,69836600"
// confirms that help zip archive is saved.
```

Usage:

Event

Manual operation:: "Setup > Help > Export Help to User Path"**:SYSTem:IDENtification <Identification>**Selects the mode to determine the "IDN String" and the "OPT String" for the instrument, selected with command `:SYSTem:LANGuage`.**Note:** While working in an emulation mode, the R&S SMB100B specific command set is disabled, that is, the SCPI command `SYST:IDEN` is discarded.**Parameters:**

<Identification>

AUTO | USER

AUTO

Automatically determines the strings.

USER

User-defined strings can be selected.

***RST:** n.a. (factory preset: AUTO)

Example: `SYST:IDEN AUTO`
Automatically assigns the OPT and IDN strings according to the selected instrument language.

Manual operation: See "[Mode](#)" on page 274

:SYSTem:IDENtification:PRESet

Sets the *IDN and *OPT strings in user defined mode to default values.

Example: `SYST:IDEN USER`
`SYST:IDEN:PRES`

Usage: Event

Manual operation: See "[Set to Default](#)" on page 274

:SYSTem:IRESpone <IdnResponse>

Defines the user defined identification string for *IDN.

Note: While working in an emulation mode, the instrument's specific command set is disabled, i.e. the SCPI command `SYST:IRES` is discarded.

Parameters:

<IdnResponse> string

Example: `SYST:IDEN USER`
`// Selects a user-defined identification`
`SYST:IRES "Test Device"`
`// Defines identification string 'test device'`
`*IDN?`
`// Response: 'test device'`

Manual operation: See "[IDN String](#)" on page 275

:SYSTem:ORESpone <OResponse>

Defines the user defined response string for *OPT.

Note: While working in an emulation mode, the instrument's specific command set is disabled, i.e. the SCPI command `SYST:ORES` is discarded.

Parameters:

<OResponse> string

Example: `SYST:IDEN USER`
`// Selects a user-defined identification`
`SYST:ORES "Test Option"`
`// Defines the OPT string 'test option'`
`*OPT?`
`// Response: 'test option'`

Manual operation: See "[OPT String](#)" on page 275

:SYSTEM:LANGUage <Language>

Sets the remote control command set.

Parameters:

<Language> string

Example:

```
SYSTEM:LANGUage "SCPI"
// selects SCPI command set
```

Manual operation: See "[Language](#)" on page 274

:SYSTEM:INFormation:SCPI <InfoString>

Inserts system information in recorded SCPI command lists, for example information on a missing command.

Parameters:

<InfoString> string

Example:

```
SYST:INF:SCPI "missing command"
enters the information into a recorded SCPI command list.
```

:SYSTEM:SECurity:SANitize[:STATE] <SecPassWord>, <MmemProtState>

Sanitizes the internal memory.

Parameters:

<MmemProtState> 0 | 1 | OFF | ON
*RST: 0

Setting parameters:

<SecPassWord> string

Example:

```
SYSTEM:SECurity:SANitize[:STATE] 1
```

Manual operation: See "[Sanitize](#)" on page 245

:SYSTEM:SECurity:SUPolicy <SecPassWord>, <UpdatePolicy>

Configures the automatic signature verification for firmware installation.

Parameters:

<UpdatePolicy> STRict | CONFirm | IGNore
*RST: n.a. (factory preset: CONFirm)

Setting parameters:

<SecPassWord> string

Manual operation: See "[Secure Update Policy](#)" on page 243

:SYSTEM:SPECification? <Id>

Retrieves data sheet information for a specific parameter.

Setting parameters:

<Id> string
 Identifies the name of the entry in the data sheet, as queried with the command `:SYSTem:SPECification:IDENTification:CATalog?` on page 494

Return values:

<ValList> float
 Comma-separated list with the specified and, if available, the typical value of the parameter, as specified in the data sheet. See also "Data Sheet" on page 285.

Example:

Retrieving instruments specification

Note: The following values are merely an example.

Query the data sheet versions stored in the instrument:

```
:SYSTem:SPECification:VERSion:CATalog?
"04.03,04.02,04.01,04.00,03.04,03.03,03.02,
03.01,03.00,02.96,02.95,02.94,02.02,02.01,
02.00,01.03,01.02,01.01,01.00"
```

Query the data sheet version with that the instrument was delivered:

```
:SYSTem:SPECification:VERSion:FACTory?
"04.00"
```

Select a data sheet version:

```
:SYSTem:SPECification:VERSion?
"04.00"
:SYSTem:SPECification:VERSion "04.01"
```

Selects one particular data sheet version.

Queries regarding data sheet parameters (IDs) and their values refer to this particular data sheet

Query the IDs of all parameters listed in the **selected** data sheet version:

```
:SYSTem:SPECification:IDENTification:CATalog?
"ID_RF_FREQ_SETTING_TIME_ALC_ON_MS,
ID_RF_FREQ_SETTING_TIME_MS,..."
```

Query the data sheet information on a specific parameter, defined by its ID

```
:SYSTem:SPECification?
"ID_RF_FREQ_SETTING_TIME_ALC_ON_MS"
```

Returned is the specified and, if available, the typical value of the parameter

Usage: Query only

:SYSTem:SPECification:VERSion <Version>

Selects a data sheet version from the data sheets saved on the instrument.

Further queries regarding the data sheet parameters (<Id>) and their values refer to the selected data sheet.

To query the list of data sheet versions, use the command `:SYSTEM:SPECification:VERSion:CATalog?` on page 494.

Parameters:

<Version> string

Example: See `:SYSTEM:SPECification?` on page 492.

:SYSTEM:SPECification:IDENTification:CATalog?

Queries the parameter identifiers (<Id>) available in the data sheet.

Return values:

<IdList> string
Comma-separated string of the parameter identifiers (<Id>)

Example: See `:SYSTEM:SPECification?` on page 492.

Usage: Query only

:SYSTEM:SPECification:PARAmeter? <Id>[, <Parameter>]

Retrieves data sheet information for a specific parameter.

Setting parameters:

<Id> string
Identifies the name of the entry in the data sheet.
Query the data sheet parameters with the command `:SYSTEM:SPECification:IDENTification:CATalog?`.

<Parameter> float
An additional value the result (<ValList>) depends on.

Return values:

<ValList> float
Comma-separated list with the specified and, if available, the typical value of the parameter, as specified in the data sheet.

Example: **Note:** The following values are merely an example. Your instrument may not support the same parameters.

```

SYS:SPEC:PAR? "ID_RF_FREQ_SETTING_TIME_MS",0.1
SYS:SPEC:PAR? "ID_RF_LEVEL_MAX_GENERAL_DBM",
0.1

```

Usage: Query only

:SYSTEM:SPECification:VERSion:CATalog?

Queries all data sheet versions stored in the instrument.

Return values:

<VersCatalog> string

Example: See [:SYSTem:SPECification?](#) on page 492.

Usage: Query only

:SYSTem:SPECification:VERSion:FACTory?

Queries the data sheet version of the factory setting.

Return values:

<Version> string

Example: See [:SYSTem:SPECification?](#) on page 492.

Usage: Query only

Manual operation: See ["Versions"](#) on page 538

:SYSTem:SRData?

Queries the SCPI recording data from the internal file.

This feature enables you to transfer an instrument configuration to other test environments, as e.g. laboratory virtual instruments.

Return values:

<FileData> block data

Example:

```
SYSTem:SRData?
// #3118:SOURcel:ROSCillator:SOURce EXT
// :SOURcel:FREQuency:CW 4000000000
// :SOURcel:FREQuency:OFFSet 1000000
// :SOURcel:AMl:STATe 1
// :OUTPut1:STATe 1
```

Usage: Query only

:SYSTem:STARtup:COMPLete?

Queries if the startup of the instrument is completed.

Return values:

<Complete> 0 | 1 | OFF | ON
*RST: 0

Example:

```
SYST:STAR:COMP?
Response: 1
the startup of the instrument is completed.
```

Usage: Query only

:SYSTem:DATE <Year>, <Month>, <Day>

Queries or sets the date for the instrument-internal calendar.

This is a password-protected function. Unlock the protection level 1 to access it.

Parameters:

<Year>	integer	
<Month>	integer	
	Range:	1 to 12
<Day>	integer	
	Range:	1 to 31

Example:

```
:SYSTem:DATE?
// 2016,05,01
```

Manual operation: See ["Date"](#) on page 545

:SYSTem:NTP:HOSTName <NTPName>

Sets the address of the NTP server. You can enter the IP address, or the hostname of the time server, or even set up an own vendor zone. See the Internet for more information on NTP.

Parameters:

<NTPName>	string
-----------	--------

Manual operation: See ["NTP Address"](#) on page 546

:SYSTem:NTP:STATe <UseNtpState>

Activates clock synchronization via NTP.

Parameters:

<UseNtpState>	0 1 OFF ON
*RST:	n.a. (factory preset: 0)

Example:

```
SYSTem:NTP:STATe 1
```

Manual operation: See ["Use Time from NTP Server"](#) on page 546

:SYSTem:TIME <Hour>, <Minute>, <Second>

Queries or sets the time for the instrument-internal clock.

This is a password-protected function. Unlock the protection level 1 to access it.

Parameters:

<Hour>	integer	
	Range:	0 to 23
<Minute>	integer	
	Range:	0 to 59
<Second>	integer	
	Range:	0 to 59

Example: `SYSTem:TIME?`
 `// 10,27,14`

Manual operation: See "Time" on page 545

:SYSTem:TIME:ZONE <TimeZone>

Sets the timezone. You can query the list of the available timezones with `:SYSTem:TIME:ZONE:CATalog?`.

Parameters:

<TimeZone> string

Manual operation: See "Timezone" on page 546

:SYSTem:TIME:ZONE:CATalog?

Queries the list of available timezones.

Return values:

<Catalog>

Usage: Query only

Manual operation: See "Timezone" on page 546

:SYSTem:UPTime?

Queries the up time of the operating system.

Return values:

<UpTime> "<ddd.hh:mm:ss>"

Example: `SYSTem:UPTime?`
 Response: "0.08:11:00"

Usage: Query only

:SYSTem:BIOS:VERSion?

Queries the BIOS version of the instrument.

Return values:

<Version> string

Example: `SYST:BIOS:VERS?`
 queries the BIOS version.
 Response: 123456

Usage: Query only

:SYSTEM:VERSion?

Queries the SCPI version the instrument's command set complies with.

Return values:

<Version> string

Example:

SYST:VERS

queries the SCPI version.

Response: "1996"

The instrument complies with the SCPI version from 1996.

Usage: Query only

:SYSTEM:OSYSstem?

Queries the operating system of the instrument.

Return values:

<OperSystem> string

Example:

SYSTEM:OSYSstem?

Response: "Linux"

Usage: Query only

:SYSTEM:MMEMory:PATH:USER?

Queries the user directory, that means the directory the R&S SMB100B stores user files on.

Return values:

<PathUser> string

Example:

SYSTEM:MMEMory:PATH:USER?

Response: "/var/user/"

Usage: Query only

:SYSTEM:DFPR?

Queries the device footprint of the instrument. The retrieved information is in machine-readable form suitable for automatic further processing.

Return values:

<DeviceFootprint> string

Information on the instrument type, device identification and details on the installed FW version, hardware and software options.

Example:

:SYSTEM:DFPR?

Usage: Query only

:SYSTem:REBoot

Reboots the instrument including the operating system.

Usage: Event

:SYSTem:REStArt

Restarts the instrument without restarting the operating system.

Usage: Event

:SYSTem:SHUTdown

Shuts down the instrument.

Usage: Event

Manual operation: See "[Shut down](#)" on page 554

:SYSTem:WAIT <TimeMs>

Delays the execution of the subsequent remote command by the specified time.

This function is useful, for example to execute an SCPI sequence automatically but with a defined time delay between some commands.

See [Chapter 10.2.4, "How to Assign Actions to the \[★ \(User\)\] Key"](#), on page 235.

Setting parameters:

<TimeMs> integer
Wait time in ms
Range: 0 to 10000
*RST: 0

Example:

```
:SYSTem:WAIT 10000
// waits 10s before resetting the instrument
*RST
```

Usage: Setting only

:SYSTem:FILEs:TEMPorary:DELeTe

Deletes the temporary files from the internal memory.

Example:

```
:SYSTem:FILEs:TEMPorary:DELeTe
// temporary files are removed
```

Usage: Event

12.16 STATus Subsystem

This system contains the commands for the status reporting system. See also [Chapter A.1.5, "Status Reporting System"](#), on page 567 for detailed information.

*RST on page 324 has no effect on the status registers.

Value ranges

- Queries return the current value of the respective register, which permits a check of the device status.
Return values: A decimal value in the range 0 to 32767 ($=2^{15}-1$)
- The configuration commands set the respective register thus determining which status changes of the R&S SMB100B cause the status registers to be changed.
Setting values: A decimal value in the range 0 to 32767 ($=2^{15}-1$)

:STATus:OPERation:CONDition?	500
:STATus:OPERation:ENABle	500
:STATus:OPERation[:EVENT]	501
:STATus:OPERation:NTRansition	501
:STATus:OPERation:PTRansition	501
:STATus:PRESet	501
:STATus:QUEStionable:CONDition	502
:STATus:QUEStionable:ENABle	502
:STATus:QUEStionable[:EVENT]	502
:STATus:QUEStionable:NTRansition	502
:STATus:QUEStionable:PTRansition	503
:STATus:QUEue[:NEXT]?	503

:STATus:OPERation:CONDition?

Queries the content of the CONDition part of the STATus:OPERation register.

This part contains information on the action currently being performed in the instrument. The content is not deleted after being read out because it indicates the current hardware status.

Return values:

<Condition> string

Example: :STATus:OPERation:CONDition?

Usage: Query only

:STATus:OPERation:ENABle <Enable>

Sets the bits of the ENABle part of the STATus:OPERation register. This setting determines which events of the Status-Event part are forwarded to the sum bit in the status byte. These events can be used for a service request.

Parameters:

<Enable> string

Example: :STAT:OPER:ENAB 32767
all events are forwarded to the sum bit of the status byte.

:STATus:OPERation[:EVENT] <Event>

Queries the content of the EVENT part of the STATus:OPERation register. This part contains information on the actions performed in the instrument since the last readout. The content of the EVENT part is deleted after being read out.

Parameters:

<Event> string

Example: :STAT:OPER:EVEN?
queries the STATus:OPERation:EVENT register.

:STATus:OPERation:NTRansition <Ntransition>

Sets the bits of the NTRansition part of the STATus:OPERation register. If a bit is set, a transition from 1 to 0 in the condition part causes an entry to be made in the EVENT part of the register. The disappearance of an event in the hardware is thus registered, for example the end of an adjustment.

Parameters:

<Ntransition> string

Example: :STAT:OPER:NTR 0
a transition from 1 to 0 in the condition part of the Status:Operation register does not cause an entry to be made in the EVENT part.

:STATus:OPERation:PTRansition <Ptransition>

Sets the bits of the PTRansition part of the STATus:OPERation register. If a bit is set, a transition from 0 to 1 in the condition part causes an entry to be made in the EVENT part of the register. A new event in the hardware is thus registered, for example the start of an adjustment.

Parameters:

<Ptransition> string

Example: :STAT:OPER:PTR 32767
all transitions from 0 to 1 in the condition part of the Status:Operation register cause an entry to be made in the EVENT part.

:STATus:PRESet <Preset>

Resets the status registers. All PTRansition parts are set to FFFFh (32767), i.e. all transitions from 0 to 1 are detected. All NTRansition parts are set to 0, i.e. a transition from 1 to 0 in a CONDition bit is not detected. The ENABLE parts of STATus:OPERation and STATus:QUESTionable are set to 0, i.e. all events in these registers are not passed on.

Parameters:

<Preset> string

Example:

STAT:PRES
resets the status registers.

:STATus:QUEStionable:CONDition <Condition>

Queries the content of the CONDition part of the STATus:QUEStionable register. This part contains information on the action currently being performed in the instrument. The content is not deleted after being read out since it indicates the current hardware status.

Parameters:

<Condition> string

Example:

:STATus:QUEStionable:CONDition?
queries the Status:Questionable:Condition register.

:STATus:QUEStionable:ENABle <Enable>

Sets the bits of the ENABle part of the STATus:QUEStionable register. The enable part determines which events of the STATus:EVENT part are enabled for the summary bit in the status byte. These events can be used for a service request.

If a bit in the ENABle part is 1, and the corresponding EVENT bit is true, a positive transition occurs in the summary bit. This transition is reported to the next higher level.

Parameters:

<Enable> string

Example:

STAT:QUES:ENAB 1
Problems when performing an adjustment cause an entry to be made in the sum bit.

:STATus:QUEStionable[:EVENT] <Event>

Queries the content of the EVENT part of the STATus:QUEStionable register. This part contains information on the actions performed in the instrument since the last readout. The content of the EVENT part is deleted after being read out.

Parameters:

<Event> string

Example:

STAT:QUES:EVENT?
queries the Status:Questionable:Event register.

:STATus:QUEStionable:NTRansition <Ntransition>

Sets the bits of the NTRansition part of the STATus:QUEStionable register. If a bit is set, a transition from 1 to 0 in the condition part causes an entry to be made in the EVENT part of the register.

Parameters:**<Ntransition>** string**Example:**

STAT:QUES:NTR 0

a transition from 1 to 0 in the condition part of the STATUS:QUESTIONable register does not cause an entry to be made in the EVENT part

:STATUS:QUESTIONable:PTRansition <PTransition>

Sets the bits of the NTRansition part of the STATUS:QUESTIONable register. If a bit is set, a transition from 1 to 0 in the condition part causes an entry to be made in the EVENT part of the register.

Parameters:**<PTransition>** string**Example:**

STAT:QUES:PTR 32767

all transitions from 0 to 1 in the condition part of the STATUS:QUESTIONable register cause an entry to be made in the EVENT part

:STATUS:QUEue[:NEXT]?

Queries the oldest entry in the error queue and then deletes it. Positive error numbers denote device-specific errors, and negative error numbers denote error messages defined by SCPI. If the error queue is empty, 0 ("No error") is returned.

The command is identical to :SYSTEM:ERROR[:NEXT]? on page 479.

Return values:**<Next>** string**Example:**

:STATUS:QUEue?

queries the oldest entry in the error queue.

Response: 0, 'no error'

no errors have occurred since the error queue was last read out

Usage:

Query only

12.17 TEST Subsystem

The TEST subsystem contains the commands for performing test routines directly at the hardware assemblies.

The selftest responses with a 0 if the test is performed successfully, otherwise a value other than 0 is returned. None of the commands of this system has a *RST value.

:TEST<hw>:ALL:START..... 504
 :TEST<hw>:ALL:RESult?..... 504

:TEST<hw>:ALL:START**Usage:** EventStarts the selftest. Use the command `:TEST<hw>:ALL:RESult?` to query the result.**:TEST<hw>:ALL:RESult?**Queries the result of the performed selftest. Start the selftest with `:TEST<hw>:ALL:START`.**Return values:**

<Result> 0 | 1 | RUNning | STOPped

*RST: STOPped

Usage: Query only

12.18 TRIGger Subsystem

The TRIGger system contains the commands for selecting the trigger source for the RF and LF sweep.

You can work with an internal or with an externally applied trigger signal. In this case, use the commands in the `SOURCE:INPut` subsystem to configure the signal.

The trigger system of the R&S SMB100B is a simplified implementation of the SCPI trigger system. The TRIGger system differs from the SCPI system as follows:

- No `INITiate` command; the instrument behaves as if `INITiate:CONTinuous ON` were set.
- Under TRIGger several sweep subsystems exist.
- The trigger source names correspond directly to the various settings of manual control. SCPI uses different names which are also accepted by the instrument. The SCPI names should be used if compatibility is an important consideration.

In addition to these commands, see more trigger-related commands in the modulation and RF signal subsystems.

Table 12-1: Cross-reference between the manual and remote control

R&S proprietary value name	SCPI conform value name	Parameter in manual control
AUTO	IMMediate	"Auto" mode
SINGle	BUS	"Single" mode.
EXTErnal	EXTErnal	"Ext Single" and "Ext Step" mode. Use command <code>LFO:SWEEp:MODE</code> to select between the two sweep modes.
EAUTO	-	"Ext Start/Stop" mode.

:TRIGger<hw>:FSweep:SOURce.....	505
:TRIGger<hw>:LFFSweep:SOURce.....	505
:TRIGger<hw>:PSweep:SOURce.....	505
:TRIGger<hw>[:SWEep]:SOURce.....	505
:TRIGger<hw>:FPSweep:SOURce.....	506
:TRIGger<hw>:FSweep[:IMMediate].....	507
:TRIGger<hw>:LFFSweep:IMMediate.....	507
:TRIGger<hw>:PSweep[:IMMediate].....	507
:TRIGger<hw>[:SWEep][:IMMediate].....	507
:TRIGger<hw>:LFFSweep.....	507

:TRIGger<hw>:FSweep:SOURce <Source>
:TRIGger<hw>:LFFSweep:SOURce <Source>
:TRIGger<hw>:PSweep:SOURce <Source>
:TRIGger<hw>[:SWEep]:SOURce <Source>

Selects the trigger source for the corresponding sweeps:

- FSweep - RF frequency
- LFFSweep - LF frequency
- PSweep - RF level
- SWEep - all sweeps

The source names of the parameters correspond to the values provided in manual control of the instrument. They differ from the SCPI-compliant names, but the instrument accepts both variants.

Use the SCPI name, if compatibility is an important issue. Find the corresponding SCPI-compliant commands in [Cross-reference between the manual and remote control](#).

Setting parameters:

<Source> AUTO | IMMediate | SINGLE | BUS | EXTernal | EAUTO

AUTO [IMMediate]

Executes a sweep automatically.

In this free-running mode, the trigger condition is met continuously. I.e. when a sweep is completed, the next one starts immediately.

SINGle [BUS]

Executes one complete sweep cycle.

The following commands initiate a trigger event:

*TRG on page 325

```
[ :SOURce<hw> ] :SWEep:POWer:EXECute
[ :SOURce<hw> ] :SWEep [ :FREQuency ] :EXECute
:TRIGger<hw> [ :SWEep ] [ :IMMediate ], :TRIGger<hw>:
PSWep [ :IMMediate ] and :TRIGger<hw>:FSWep [ :
IMMediate ].
```

Set the sweep mode with the commands:

```
[ :SOURce<hw> ] :SWEep:POWer:MODEAUTO | STEP
[ :SOURce<hw> ] :SWEep [ :FREQuency ] :MODEAUTO | STEP
[ :SOURce<hw> ] :LFOutput:SWEep [ :FREQuency ] :MODE
AUTO | STEP
```

In step mode (STEP), the instrument executes only one step.

EXtErnal

An external signal triggers the sweep.

EAUTO

An external signal triggers the sweep. When one sweep is finished, the next sweep starts.

A second trigger event stops the sweep at the current frequency, a third trigger event starts the trigger at the start frequency, and so on.

```
*RST:      AUTO
```

Example: See [Example "Setup an LF sweep"](#) on page 419

Usage: Setting only

:TRIGger<hw>:FPSWep:SOURce <FpTrigSource>

Selects the trigger source for the combined RF frequency / level sweep.

The parameter names correspond to the manual control. If needed, see [table Table 12-1](#) for selecting the trigger source with SCPI compliant parameter names.

Parameters:

<FpTrigSource> AUTO | IMMediate | SINGle | BUS | EXtErnal | EAUTO

AUTO|IMMediate

Executes the combined RF sweep automatically. In this free-running mode, the trigger condition is met continuously. I.e. as soon as a sweep is completed, the next one starts immediately.

SINGle|BUS

Executes one complete sweep cycle triggered by the GPIB commands [:SOURce<hw>] :SWEep:COMBined:EXECute or *TRG. The mode has to be set to [:SOURce<hw>] :SWEep:COMBined:MODE > AUTO.

EXtErnal

An external signal triggers the sweep.

EAUTO

An external signal triggers the sweep. As soon as one sweep is finished, the next sweep starts. A second trigger event stops the sweep at the current frequency and level value pairs, a third trigger event starts the trigger at the start values, and so on.

*RST: No enum range assigned!

Manual operation: See "[Mode](#)" on page 127

:TRIGger<hw>:FSweep[:IMMEDIATE]
:TRIGger<hw>:LFFSweep:IMMEDIATE
:TRIGger<hw>:PSweep[:IMMEDIATE]
:TRIGger<hw>[:SWEep][:IMMEDIATE]

Performs a single sweep and immediately starts the activated, corresponding sweep:

- FSWep - RF frequency
- PSweep - RF level
- LFFSweep - LF frequency
- SWEep - all sweeps

Effective in the following configuration:

- TRIG:FSW|LFFS|PSW|[:SWE]:SOUR **SING**
- SOUR:SWE:FREQ|POW:MODE **AUTO** or SOUR:LFO:SWE:[FREQ:]MODE **AUTO**

Alternatively, you can use the IMMEDIATE command instead of the respective SWEep : [FREQ:] | POW:EXECute command.

Example: TRIG
Starts all active sweeps.

Usage: Event

Manual operation: See "[Execute Single Sweep](#)" on page 131

:TRIGger<hw>:LFFSweep

Executes an LF frequency sweep in the following configuration:

- TRIG:LFFS:SOUR SING
- LFO:SWE:MODE AUTO

Example: LFO:SWE:MODE AUTO
TRIG:LFFS:SOUR SING
TRIG:LFFSweep

Usage: Event

12.19 UNIT Subsystem

The `UNIT` subsystem is used to set default units for parameters if no unit is indicated in a command. These settings are valid for the entire instrument.

Example: Setting default units for remote control

```
UNIT:POW V
UNIT:ANGL DEG
```

Sets V (volts) as unit of all power parameters, DEG (degrees) for the phase modulation angle and KMH for the speed.

```
:UNIT:ANGLE.....508
:UNIT:POWer.....508
```

:UNIT:ANGLE <Angle>

Sets the default unit for phase modulation angle. The command affects no other parameters, such as RF phase, or the manual control or display.

Parameters:

```
<Angle>          DEGREE | DEGREE | RADIAN
                  *RST:      RADIAN
```

:UNIT:POWer <Power>

Sets the default unit for all power parameters. This setting affects the GUI, as well as all remote control commands that determine power values.

Parameters:

```
<Power>          V | DBUV | DBM
                  *RST:      DBM
```

12.20 Direct Commands for the Stereo/RDS Coder Option R&S SMBB-B5

The direct commands allow you the access to all functions of the stereo coder option R&S SMBB-B5.

Some of the functions are also available via SCPI commands. In this case, we recommend that you use the SCPI commands to keep the settings of the R&S SMB100B and the stereo coder synchronized. Direct commands for which an SCPI command is available are marked with “for documentation reasons only” and the SCPI command is given.

To send the direct commands, use the command `[:SOURCE] :STEReo:DIRect "command string"`.

To retrieve information, send the query `[:SOURCE] :STEReo:DIRect? "command string"`.

All parameters are string parameters. Send them in quotation marks ("). These characters are part of the full direct command.

Before using the stereo coder, activate stereo modulation of the R&S SMB100B with the command `SOURce:STEReo:STATe ON`. The SCPI command `SOURce:STEReo:AUDio:FREQuency` sets the LF-Generator frequency. `SOURce:STEReo:MMF` limits the modulation frequency. These commands have no counterpart in the direct commands.

12.20.1 Programming Examples

Example: Alternative frequency lists (AF)

Alternative frequency lists can be transmitted in two ways.

- **Method A:**
Set the frequencies of an AF list one after the other; the frequency currently transmitted has to be specified as the first frequency.
- **Method B:**
Set the frequencies of an AF list in pairs, where each pair contains the frequency currently transmitted and an alternative frequency.
Enter the frequency pairs in ascending order.
Choose descending order only if the alternative frequencies belong to different regions or are used to broadcast different programs at different times.

A maximum of five AF lists can be generated. For type A lists, max. 25 frequencies per list can be specified, for type B lists, max. 12 frequencies per list.



Consider the following:

- Do not combine method A and B.
- You can generate a maximum of five AF lists.
For type A lists, you can specify up to 25 frequencies per list; for type B - up to 12.
- There is no validity check for the frequency lists. Make sure that the syntax is correct.

```
// Method A
// Generate a new alternative frequency list
STEReo:DIRect "AF=N,87.6,87.7,87.8"
// Set the group sequence
STEReo:DIRect "GS=0A,14A"
// The group sequence must contain group 0A
// The alternative frequencies are now transmitted in group 0A

// Add another alternative frequency list
STEReo:DIRect "AF=+,88.6,88.7,88.8"
```

Direct Commands for the Stereo/RDS Coder Option R&S SMBB-B5

```
// Method B
// Generate a new alternative frequency list
STEReo:DIrect "AF=N,87.6,90.2,87.6,90.2"
// Set the group sequence
STEReo:DIrect "GS=0A,14A"
// The group sequence must contain group 0A
// The alternative frequencies are now transmitted in group 0A

// Add another alternative frequency list
STEReo:DIrect "AF=+,88.6,91.2,88.6,91.2"
```

Example: Creating an EON (Enhanced Other Networks) data set

```
// Query the list of existing EON data sets
STEReo:DIrect? "EON-PI"
// the list shows the EON PI codes already used and codes remaining for new data sets

// Create an EON data set
STEReo:DIrect "EON-PI=1234"
// Set the program service (PS) name for the EON data set
STEReo:DIrect "EON-PS=1234,TEST EON"
// Set the group sequence, e.g. group 14A with variants 0 to 3
STEReo:DIrect "GS=0A,14A"

// Create an AF list for the EON
// Method A
STEReo:DIrect "EON-AFA=1234,N,87.6,87.7,87.8"
// Add further AF lists for the EON
STEReo:DIrect "EON-AFA=1234,+,88.6,88.7,88.8"
// Query the first AF list of the EON
STEReo:DIrect? "EON-AFA,1234,1"

// Create an AF list for the EON
// Method B
STEReo:DIrect "EON-AFB=1234,N,87.6,87.7,87.8"
// 87.6 = tuned frequency, 87.7 = mapped frequency 1 (variant 5),
// 87.8 = mapped frequency 2 (variant 6)
```

Example: Free Format Groups (FFGs)

In the user-definable groups 1A, 3A, 5A, 6A, 7A, 8A, 9A, 10A, 11A, 12A and 13A, any desired data can be transmitted. Five bits of this data are transmitted in block B and 16 bits each in blocks C and D of the specified group.

You can define up to 20 different data sequences.

```
// Define the transmitted data in group 1A
STEReo:DIrect "1A=05,0000000000,1FFFFFFFFF"
// Group 1A transmits 5 times "0000000000" followed by 5 times "1FFFFFFFFF"

// Set the group sequence, e.g. transmit the defined data in group 1A
STEReo:DIrect "GS=0A,1A"
```

Example: Transparent Mode

The transparent mode allows you to transmit user-defined binary data instead of the standard RDS data. The transparent mode uses blocks A to D of the RDS groups. Standard RDS data is suppressed and not transmitted.

You can define up to 20 different data sequences.

The binary data is sent even if it constitutes no valid or meaningful RDS data. Always delete the transparent data first, before you resume the transmission of standard RDS data.

```
// Transmit the alternating sequences '0123456789ABCDEF' and
// 'ABCDEF0123456789' instead of the RDS data

// Delete the transparent data
// Enable standard RDS data transmission
STEReo:DIrect "TRANS=0"
```

12.20.2 Remote-Control Commands

STEReo:DIrect "<FFG>=<RetrNumb>,<DataSeq#1>,<DataSeq#2>,..."
STEReo:DIrect? "<FFG>"

Transmits data via free format groups (FFGs). A free format group can be filled with any desired data. (5 bits in block B and 16 bits each in blocks C and D of the group).

Note: This command causes that a queue is filled with data for a specific group. Sends the data only if the group in question is added to the group sequence with the command [STEReo:DIrect](#).

Setting parameters:

<RetrNumb> Number of retransmissions

<DataSeq> You can define up to 20 different data sequences.
Specify at least 10 characters per <DataSeq>. Add leading zeros, if any.
00 Erases the data.
Range: 0000000000 to 1FFFFFFFFF (10 ASCII coded hexadecimal characters each)

Parameters for setting and query:

<FFG> 1A | 3A | 5A | 6A | 7A | 8A | 9A | 10A | 11A | 12A | 13A
Determines the free format group.
To transmit the FFGs of the B group, use same commands.
Replace the A groups are by the B groups in the group sequence. If B groups are transmitted, block C is overwritten with the PI code.

Direct Commands for the Stereo/RDS Coder Option R&S SMBB-B5

Example: STEReo:DIReCt "1A=01,0123456789,1FFFFFFFF"

Fills a queue with the data "0123456789,1FFFFFFFF". The data is sent in consecutive order in group 1A after group 1A is added to the group sequence.

Query the data of group 1A

STEReo:DIReCt? "1A"

Response: "01,0123456789,1FFFFFFFF"

STEReo:DIReCt "AF=<A>,<Freq#1>,<Freq#2>,..."
STEReo:DIReCt? "AF<z>"

Defines an alternative frequency list.

A maximum of five AF lists with max. 25 frequencies per list can be created.

Parameters:

<Freq> xxx.x

Sets the alternative frequencies as ASCII coded decimal numbers.

If list <z> is not available, the response is ().

Range: 87.6 to 107.9

Setting parameters:

<A> **N**

New AF list

+

AF list to be added.

Query parameters:

<z> AF list to be read.

Range: 1 to 5

Example: STEReo:DIReCt "AF=N,97.4,98.3"

Defines an alternative frequency list, the alternative frequencies 97.4 and 98.3 are inserted.

STEReo:DIReCt? "AF1"

Response: "97.4,98.3"

STEReo:DIReCt "AF=N"

Deletes all frequency lists.

STEReo:DIReCt "ARI=<State>"
STEReo:DIReCt? "ARI"

(for documentation reasons only)

Activates ARI signal transmission.

Use the command [:SOURce] :STEReo:ARI:STATe instead.

Setting parameters:

<State> 0 | 1

Direct Commands for the Stereo/RDS Coder Option R&S SMBB-B5

Example: STEReo:DIReCt "ARI=0"
 Deactivates ARI signal transmission.
 STEReo:DIReCt? "ARI"
 Response: "0"

STEReo:DIReCt "ARI-DEV=<Deviation>"
STEReo:DIReCt? "ARI-DEV"

(for documentation reasons only)

Sets the frequency deviation of the ARI signal (max. deviation).

Use the command [:SOURce]:STEReo:ARI[:DEViation] instead.

Setting parameters:

<Deviation> Sets the frequency deviation.
Note: Always set a four-digit value. Specify leading zeros, if any.
 Range: 0000 to 1000 (ASCII coded decimal numbers),
 corresponding to 0 Hz to 10 kHz

Example: STEReo:DIReCt "ARI-DEV=1000"
 Sets the ARI frequency deviation to 10 kHz.
 STEReo:DIReCt? "ARI"
 Response: "1000"

STEReo:DIReCt "ARI-ID=<Id>"
STEReo:DIReCt? "ARI-ID"

(for documentation reasons only)

Selects the ARI identification.

Use the command [:SOURce]:STEReo:ARI:TYPE instead.

Parameters:

<Id> 0 | 1 | 2 | 3
0
 Off
1
 DK (traffic announcement identification)
2
 BK (area identification)
3
 DK and BK (traffic announcement identification and area identification)

Example: STEReo:DIReCt "ARI-ID=0"
 Deactivates the ARI identification.
 STEReo:DIReCt? "ARI-ID"
 Response: "0"

STEReo:DIReCt "BIN=<x>"

Defines and sends, or queries, binary test patterns. The BIN command causes the Stereo/RDS Coder to send periodic binary bit patterns instead of RDS data.

Parameters:

<x>	0 Binary mode OFF
	1 00000000...,
	2 11111111...,
	3 01010101...,
	4 11001100...

Example:

```
STEReo:DIReCt "BIN=2"
```

The binary test pattern is set to "2" so that only "1s" are transmitted.

STEReo:DIReCt "BK=<Code>"**STEReo:DIReCt? "BK"**

(for documentation reasons only)

Sets the ARI area identification.

Use the command `[:SOURce] :STEReo:ARI: BK [:CODE]` instead.

Parameters:

<Code>	A B C D E F
--------	-----------------------

Example:

```
STEReo:DIReCt "BK=E"
```

The ARI area identification is set to "E".

```
STEReo:DIReCt? "BK"
```

Response: "E"

STEReo:DIReCt "CT= <Hour>:<Min>:<Sec>,<Day>.<Month>.<Year>"**STEReo:DIReCt? "CT"**

Sets and activates transmission of the real-time clock.

Note: The CT data is transmitted in group 4A. Setting the real-time clock (CT command) automatically adds group 4A to the group sequence.

Do not manually add group 4A to, or remove group 4A from, the group sequence.

To remove group 4A from the group sequence, use the command `STEReo:DIReCt.`

Setting parameters:

<Hour>:<Min>:<Sec> Range: 00:00:00 to 23:59:59

Direct Commands for the Stereo/RDS Coder Option R&S SMBB-B5

<Day>.<Month>.<Year> Range: 01.01.00 to 31.12.85

Example: STEReo:DIRect "CT=20:30:59,01.08.03"
The real-time clock is set.
STEReo:DIRect? "CT"
Response: "20:31:06,01.08.03"

STEReo:DIRect "CT=off"

Deactivates transmission of the real-time clock signal in the RDS signal.

Note: This command is used to remove group 4A from the group sequence. Do not manually remove group 4A from the group sequence.

Example: STEReo:DIRect "CT=off"
The real-time clock signal is no longer transmitted in the RDS signal.

Usage: Setting only

STEReo:DIRect "DI=<x>"**STEReo:DIRect? "DI"**

Sets or reads the decoder information (DI).

This command reads, and if necessary changes, the current decoder operating mode (mono, stereo, etc.).

Parameters:

<x> Range: 0 to F (ASCII coded hexadecimal numbers)

Example: STEReo:DIRect "DI=4"

STEReo:DIRect "DS=<x>"**STEReo:DIRect? "DS"**

(for documentation reasons only)

Selects/activates a storage area in the Stereo/RDS Coder.

If activated, the settings stored in the selected area can be loaded.

Use the command [:SOURce]:STEReo:RDS:DATaset instead.

Parameters:

<x> Range: 1 to 5

Example: STEReo:DIRect "DS=2"
Storage area 2 is activated.

STEReo:DIRect "EON-AFA= <PI>,<A>,<Freq#1>,<Freq#2>,..."

STEReo:DIRect? "EON-AFA,<PI>,<z>"

Enhanced Other Networks: Defines type A alternative frequencies for the EON with the selected PI.

Parameters:

<PI> Range: 0000 to FFFF (ASCII coded hexadecimal numbers)

<Freq> xxx.x
Sets the alternative frequencies as ASCII coded decimal numbers.

If list <z> is not available, the response is ().

Note: For each Enhanced Other Network (EON), a maximum of five type A alternative frequency lists can be created.

Range: 87.6 to 107.9

Setting parameters:

<A> **N**
New AF list
+
AF list to be added.

Query parameters:

<z> AF list to be read.
Range: 1 to 5

Example:

STEReo:DIRect "EON-AFA=1000,N,97.4,98.3"

Creates a type A alternative frequency list for the EON with PI=1000. The new list contains the alternative frequencies 97.4 MHz and 98.3 MHz.

STEReo:DIRect? "EON-AFA,1000,1"

Queries the first type A alternative frequency list of the EON with PI=1000.

Response: "97.4,98.3"

STEReo:DIRect "EON-AFB= <PI>,<A>,<Freq#1>,<Freq#2>,..."

STEReo:DIRect? "EON-AFB,<PI>,<z>"

Enhanced Other Networks: Defines type B alternative frequencies for the EON with the selected PI.

Parameters:

<PI> Range: 0000 to FFFF (ASCII coded hexadecimal numbers)

Direct Commands for the Stereo/RDS Coder Option R&S SMBB-B5

<Freq> xxx.x

Sets the alternative frequencies as ASCII coded decimal numbers.

If list <z> is not available, the response is ().

Note: For each Enhanced Other Network (EON), a maximum of five type B alternative frequency lists can be created. Each list contains a maximum of five frequencies, where <Freq#1> is Tuned Frequency (TF) and <Freq#2..5> are the Mapped Frequencies (MF). A minimum of two frequencies per EON is required.

Range: 87.6 to 107.9

Setting parameters:

<A> **N**

New AF list

+

AF list to be added.

Query parameters:

<z> AF list to be read.

Range: 1 to 5

Example: See [STEReo:DIRect](#).

STEReo:DIRect "EON-DEL=<PI>"

Enhanced Other Networks: Deletes the complete EON with selected <PI>.

Parameters:

<PI> Range: 0000 to FFFF (ASCII coded hexadecimal numbers)

Example: STEReo:DIRect "EON-DEL=1000"
Deletes the EON with PI=1000.

Usage: Setting only

STEReo:DIRect "EON-PI=<PI>"**STEReo:DIRect? "EON-PI"**

Enhanced Other Networks: Creates an EON or reads the list of the program identification (PI) codes of all EONs created so far.

Note: A maximum of eight EONs can be created.

Parameters:

<PI> **Note:** Always set a four-digit value. Leading zeros, if any, must also be specified.

Range: 0000 to FFFF (ASCII coded hexadecimal numbers)

Direct Commands for the Stereo/RDS Coder Option R&S SMBB-B5

Example: STEReo:DIReCt "EON-PI=1000"
Creates an EON with PI=1000.

STEReo:DIReCt "EON-PS=<PI>,<PS>"
STEReo:DIReCt? "EON-PS,<PI>"

Enhanced Other Networks: Sets the program service (PS) name for the EON with the selected <PI>.

Parameters:

<PI> Range: 0000 to FFFF (ASCII coded hexadecimal numbers)

Setting parameters:

<PS> 8 ASCII characters

Note: Always set an eight-digit value. Blank spaces, if any, must also be entered.

Example: STEReo:DIReCt "EON-PS=1000,Test 123"
Sets the program service name for the EON with PI=1000 to "Test 123".

STEReo:DIReCt "EON-PTY=<PI>,<PTY>"
STEReo:DIReCt? "EON-PTY,<PI>"

Enhanced Other Networks: Sets the program type (PTY) for the EON with the selected <PI>.

Parameters:

<PI> Range: 0000 to FFFF (ASCII coded hexadecimal numbers)

Setting parameters:

<PTY> Range: 00 to 31 (ASCII coded decimal numbers)

Example: STEReo:DIReCt "EON-PTY=1000,10"
Sets the program type for the EON with PI=1000 to "10".

STEReo:DIReCt "EON-TA=<PI>,<TA>"
STEReo:DIReCt? "EON-TA,<PI>"

Enhanced Other Networks: Sets the TA flag for the EON with the selected <PI>.

Parameters:

<PI> Range: 0000 to FFFF (ASCII coded hexadecimal numbers)

Setting parameters:

<TA> 0 | 1

Example: STEReo:DIReCt "EON-TA=1000,1"
Sets the TA flag for the EON with PI=1000 to "1".

STEReo:DIRect "EON-TP=<PI>,<TP>"

STEReo:DIRect? "EON-TP,<PI>"

Enhanced Other Networks: Sets the TP flag for the EON with the selected <PI>.

Parameters:

<PI> Range: 0000 to FFFF (ASCII coded hexadecimal numbers)

Setting parameters:

<TP> 0 | 1

Example:

STEReo:DIRect "EON-TP=1000,1"

Sets the TP flag for the EON with PI=1000 to "1".

STEReo:DIRect "GS=<Group#1>,<Group#2>,...<Group#36>"

STEReo:DIRect? "GS"

Sets or reads the group sequence.

Note: Sends only group A **or** group B data at a time. Transmits only groups that contain data. The groups 4A, 14B and 15B are automatically added to the group sequence and must not be added or removed manually.

Setting parameters:

<Group> 0A,1A,2A, ... to 15B

Example:

STEReo:DIRect "GS=0A,1B,10A,15A"

The groups 0A, 1B, 10A and 15A are transmitted.

STEReo:DIRect "IMP=<x>"

STEReo:DIRect? "IMP"

(for documentation reasons only)

Sets external L, R impedances.

Use the SCPI command `[:SOURCE] :STEReo:EXTernal:IMPedance` instead.

Setting parameters:

<x> 1 | 2
 1
 600 Ohms
 2
 100 kOhm

Example:

STEReo:DIRect "IMP=1"

Sets the external impedance to 600 Ohms.

STEReo:DIRect

```
"MASK=<NumbGroups>,<ErrFreeGroups>,<BitMaskBlcA>,<BitMaskBlcB>,<BitMaskBlcC>,<BitMaskBlcD>"
```

STEReo:DIRect? "MASK"

Sets a bit mask to generate defined bit errors in the RDS data stream.

Setting parameters:

<NumbGroups>	<p>Number of groups to be masked.</p> <p>If <NumbGroups> = 0, the RDS groups are continuously linked to the error mask.</p> <p>If <NumbGroups> ≠ 0, this value is decremented after each errored group transmitted. When zero count is reached, no further errored groups are transmitted, and STEReo:DIRect is set to "0".</p> <p>Range: 00 to FF (hexadecimal values)</p>
<ErrFreeGroups>	<p>Number of error-free groups to be inserted after each errored group.</p> <p>Range: 00 to FF (hexadecimal values)</p>
<BitMaskBlc>	<p><BitMaskBlcA>,<BitMaskBlcB>,<BitMaskBlcC>,<BitMaskBlcD></p> <p>Hexadecimal bit mask for blocks A, B, C and D of the RDS groups. For each block, 26 bits (16 data bits and 10 CRC bits) have to be entered in hexadecimal code.</p> <p>Range: 0000000 to 3FFFFFFF</p>

Example:

```
STEReo:DIRect
```

```
"MASK=09,01,0000001,0000000,0000000,0000000"
```

In nine RDS groups, the least significant bit of the CRC code of block A is inverted, i.e. an errored bit is sent. After each errored group, one error-free group is inserted. After transmission of the complete sequence, **MASK_STATE** is set to "0".

With the command **MASK_STATE=1**, the above sequence (9 errored groups with one error-free group inserted after each errored group) is retransmitted once.

Then, **MASK_STATE** is again set to "0".

STEReo:DIRect "MASK_STATE=<State>"**STEReo:DIRect? "MASK_STATE"**

Switches on or off the transmission of defined bit errors in the RDS data stream.

Setting parameters:

<State> 0 | 1

Direct Commands for the Stereo/RDS Coder Option R&S SMBB-B5

Example: `STEReo:DIReCt "MASK_STATE=1"`
 With the command `MASK_STATE=1`, a sequence of errored groups as defined by the `MASK` command is retransmitted once if the number of groups to be masked is other than zero. Then, `MASK_STATE` is automatically set to "0".
 If the number of groups to be masked is equal to zero in the `MASK` command (which means continuous error transmission), the masking function can be switched off with `MASK_STATE=0`.

Example: `STEReo:DIReCt? "MASK_STATE"`
 Response: "1"
 The `MASK_STATE` query provides information whether the RDS data stream is linked to an error mask.

STEReo:DIReCt "MODE=<EMODE>"
STEReo:DIReCt? "MODE"

(for documentation reasons only)

Sets one of various transmission modes.

Use the command `[:SOURCE] :STEReo:AUDio:MODE` instead.

Setting parameters:

<EMODE> 1 | 2 | 3 | 4 | 5
1
 L: Signal in left channel only
2
 R: Signal in right channel only
3
 Signal of equal frequency and phase in left and right channel
4
 Signal of equal frequency and opposite phase in left and right channel
5
 Different, independent signals in left and right channel
 (5 is not possible if the internal LF generator is selected as source (SRC = LFGen)).

Example: `STEReo:DIReCt "MODE=1"`
 Only the signal of the left channel is transmitted.

STEReo:DIReCt "MS=<Flag>"
STEReo:DIReCt? "MS"

Sets or reads the music/speech flag.

The flag signals whether music or speech is being transmitted.

Setting parameters:

<Flag> M | S

Direct Commands for the Stereo/RDS Coder Option R&S SMBB-B5

Example: `STEReo:DIReCt "MS=M"`
 The music/speech flag is set to "M", which signals that music is transmitted.

STEReo:DIReCt "MPX-DEV=<Deviation>"
STEReo:DIReCt? "MPX-DEV"

(for documentation reasons only)

Sets the MPX frequency deviation (max. deviation).

Use the the command `[:SOURce] :STEReo [:DEViation]` instead.

Setting parameters:

<Deviation> **Note:** Always set a four-digit value. Leading zeros, if any, must also be specified.

Range: 00000 to 10000 (ASCII coded decimal numbers),
 corresponding to 0 Hz to 100 kHz

Example: `STEReo:DIReCt "MPX-DEV=00201"`
 Sets the MPX frequency deviation to 2.01 kHz.

STEReo:DIReCt "PI=<PI>"
STEReo:DIReCt? "PI"

Sets or reads the RDS program identification (PI) code.

Setting parameters:

<PI> **Note:** Always set a four-digit value. Add leading zeros, if any.

Range: 0000 to FFFF (ASCII coded hexadecimal numbers)

Example: `STEReo:DIReCt "PI=1234"`
 The program identification code to be transmitted is set to "1234".

STEReo:DIReCt "PIL=<State>"
STEReo:DIReCt? "PIL"

(for documentation reasons only)

Activates/deactivates the pilot tone.

Use the command `[:SOURce] :STEReo :PILot :STATe` instead.

Setting parameters:

<State> 0 | 1

Example: `STEReo:DIReCt "PIL=1"`
 The pilot tone is activated.

STEReo:DIRect "PIL-DEV=<Deviation>"

STEReo:DIRect? "PIL-DEV"

(for documentation reasons only)

Sets the pilot tone frequency deviation (max. deviation).

Use the command `[:SOURce] :STEReo:PILot [:DEViation]` instead.

Setting parameters:

<Deviation>

Note: Always set a four-digit value. Add leading zeros, if any.

Range: 0000 to 1000 (ASCII coded decimal numbers), corresponding to 0 Hz to 10 kHz

Example:

`STEReo:DIRect "PIL-DEV=1000"`

Sets the frequency deviation of the pilot tone to 10 kHz.

STEReo:DIRect "PIL-PH=<Phase>"

STEReo:DIRect? "PIL-PH"

(for documentation reasons only)

Sets the pilot tone phase.

Use the command `[:SOURce] :STEReo:PILot :PHASe` instead.

Setting parameters:

<Phase>

Note: Always set a two-digit value with a sign ("+" or "-") in front of it. Add leading zeros, if any.

Range: -5.0 to +5.0 (ASCII coded decimal numbers), corresponding to ± 5.0

Example:

`STEReo:DIRect "PIL-PH=-33"`

Sets the pilot tone phase.

STEReo:DIRect "PRE=<Preemphasis>"

STEReo:DIRect? "PRE"

(for documentation reasons only)

Sets one of various preemphasis options.

Use the commands `[:SOURce] :STEReo:AUDio:PREemphasis:STATe` and `[:SOURce] :STEReo:AUDio:PREemphasis` instead.

Setting parameters:

<Preemphasis> 0 | 1 | 2

0

Off

1

50 us

2

75 us

Example: STEReo:DIReCt "PRE=1"
The preemphasis is set to 50 us.

STEReo:DIReCt "PRESET"

Sets the default settings in accordance with specifications.

Example: STEReo:DIReCt "PRESET"

Usage: Event

STEReo:DIReCt "PS=<PS>"

STEReo:DIReCt? "PS"

Sets or reads the RDS program service (PS) name.

Setting parameters:

<PS> 8 ASCII characters

Note: Always set an eight-digit value. Blank spaces, if any, must also be entered.

Special characters in the program service name are entered with a leading back slash (\) followed by the decimal code of the special character according to table E1 of CENELEC.

Example: STEReo:DIReCt "RT=02,0,test text with \217"
Sets the program service name. 217 denotes the German letter ü.

STEReo:DIReCt "PS-TABLE=<Table>"

STEReo:DIReCt? "PS-TABLE"

Selects the character set table used for the display of the RDS program service (PS) name in the receiver.

The information concerning the character set is transmitted in segment 0 of the PS. Segment 0 is repeatedly transmitted if the value for PS-TABLE > 0. For PS-TABLE = 0 no information concerning the character set is transmitted.

Setting parameters:

<Table> 0 | 1 | 2 | 3

0

No information concerning the character set table in the PS

1

Table E.1 is used.

2

Table E.2 is used.

3

Table E.3 is used.

Direct Commands for the Stereo/RDS Coder Option R&S SMBB-B5

Example: `STEReo:DIReCt "PS-TABLE=2"`
 The information concerning the character set is transmitted in segment 0 of the PS in group 0A. To this end, segment 0 is transmitted repeatedly. At the first transmission segment 0 contains the information about the character set, at the second transmission segment 0 contains the first two characters of the PS.

STEReo:DIReCt "PTY=<PTY>"
STEReo:DIReCt? "PTY"

Sets or reads the program type (PTY).

Setting parameters:

<PTY> **Note:** Always set a two-digit value. Add leading zero, if any.
 Range: 00 to 31 (ASCII coded decimal numbers)

Example: `STEReo:DIReCt "PTY=08"`
 Sets the program type.

STEReo:DIReCt "PTYN=<PTYN>"
STEReo:DIReCt? "PTYN"

Sets or reads the RDS program type (PTY) name.

Setting parameters:

<PTYN> 8 ASCII characters
Note: Always set an eight-digit value. Add blank spaces, if any.

Example: `STEReo:DIReCt "PTYN=Football"`
 Sets the program type name.
`STEReo:DIReCt "GS=0A,10A"`
 Group 10A is activated in addition to group 0A.
 The specified program type name is transmitted.

STEReo:DIReCt "RDS=<State>"
STEReo:DIReCt? "RDS"

(for documentation reasons only)

Switches RDS on or off.

Use the command `[:SOURce] :STEReo:RDS:STATe` instead.

Setting parameters:

<State> 0 | 1

Example: `STEReo:DIReCt "RDS=1"`
 Activates RDS.

STEReo:DIRect "RDS-PH=<Phase>"

STEReo:DIRect? "PDS-PH"

Sets the RDS phase.

Setting parameters:

<Phase> Range: 000 to 359 (ASCII coded decimal numbers)

Example: STEReo:DIRect "RDS-PH=100"

Sets the RDS phase.

STEReo:DIRect "RDS-DEV=<Deviation>"

STEReo:DIRect? "RDS-DEV"

(for documentation reasons only)

Sets the RDS frequency deviation (max. deviation).

Use the command `[:SOURce] :STEReo:PILot [:DEVIation]` instead.

Setting parameters:

<Deviation> **Note:** Always set a four-digit value. Add leading zeros, if any.
 Range: 0000 to 1000 (ASCII coded decimal numbers),
 corresponding to 0 Hz to 10.00 kHz)

Example: STEReo:DIRect "RDS-DEV=0201"

Sets the RDS frequency deviation to 2.01 kHz.

STEReo:DIRect "RDS-PRESET"

All RDS-specific parameters are deleted or set to default values.

Example: STEReo:DIRect "RDS-PRESET"

Sets all RDS parameter to their preset values.

Usage: Event

STEReo:DIRect "RT=<RetranNumber>,<A/
 BFlag>,<RadioTextMsg#1>,<RadioTextMsg#2>"

STEReo:DIRect? "RT"

Sets a flag signaling the transmission of new radio text and the message of the radio text.

Setting parameters:

<RetranNumber> Range: 00 to 15 (ASCII coded decimal numbers), number
 of retransmissions of radio text message

<A/BFlag> 0 | 1

If the A/B flag is set, the A/B bit in group 2A is toggled to signal that a new radio text message is transmitted.

Direct Commands for the Stereo/RDS Coder Option R&S SMBB-B5

<RadioTextMsg> Max. 64 characters
 Two texts of 64 characters each can be transmitted in a radio text message.
Note: For group B, the length of a radio text is limited to 32 characters. Special characters in the radio text are entered with a leading back slash (\) followed by the decimal code of the special character according to table E1 of CENELEC.

Example: `STEReo:DIReCt "RT=02,0,test text with \217"`
 Sets the radio text message. 217 denotes the German letter ü.

STEReo:DIReCt "SPS=<Time>,<PSN#1>,<PSN#2>,...<PSN#20>"
STEReo:DIReCt? "SPS"

Switches program service names (PSN). The program service name automatically changes after the set time interval.

Parameters:

<PSN> 8 ASCII characters
 Max. 20 program service names of eight characters each can be entered.
Note: Enter the program service names as 8-digit texts. Add blank spaces, if any.
`STEReo:DIReCt "SPS=0"` stops the transmission of the scrolling PS and starts the transmission of the standard PS.

Setting parameters:

<Time> Time interval in seconds
 Range: 00 to 59 s

Example: `STEReo:DIReCt "SPS=05,TEST0123,TEST4567"`
 Transmits the program service names "TEST0123" and "TEST4567" alternately, each 5 seconds.

STEReo:DIReCt "SRC=<SigSource>"
STEReo:DIReCt? "SRC"

(for documentation reasons only)

Selects the signal source.

Use the command `[:SOURce] :STEReo:SOURce` instead.

Setting parameters:

<SigSource> 0 | 1 | 2 | 3
0
 Off
1
 External analog (via L and R inputs)
2
 External digital

3

Internal with LF generator

Example: `STEReo:DIRect "SRC=1"`
 Selects the external analog L and R inputs as source.

STEReo:DIRect? "STATUS"

Status request whether the encoder or the update loader program is being executed.

Return values:

<Status> **ENC**
 Encoder program is running.
UPL
 Update loader program is running.

Example: `STEReo:DIRect? "STATUS"`
 Response: "ENC"

Usage: Query only

STEReo:DIRect "STORE=<DataSet#>"

Saves data in the flash memory. All RDS-specific settings are stored in data set <Data-Set#> of the flash memory.

Setting parameters:

<DataSet#> Range: 1 to 5

Example: `STEReo:DIRect "STORE=1"`
 Current setting are saved as data set 1.

Usage: Setting only

STEReo:DIRect "TA=<State>"**STEReo:DIRect? "TA"**

(for documentation reasons only)

Sets or reads the traffic announcement flag.

This flag signals whether traffic information is being broadcast.

Use the command `[:SOURce] :STEReo:RDS:TRAFfic:ANNouncement [:STATe]` instead.**Setting parameters:**

<State> 0 | 1

Example: `STEReo:DIRect "TA=1"`

STEReo:DIReCt "TP=<State>"

STEReo:DIReCt? "TP"

(for documentation reasons only)

Sets or reads the traffic program flag. This flag signals whether traffic information is transmitted.

Use the command `[:SOURce] :STEReo:RDS:TRAFfic:PROGram[:STATe]` instead.

Setting parameters:

<State> 0 | 1

Example: STEReo:DIReCt "TP=1"

STEReo:DIReCt "TRANS<DataNumber>=<DataStream>"

STEReo:DIReCt? "TRANS<DataNumber>"

Transparent mode.

An RDS data stream of binary data is generated. If transparent data is selected, all other RDS data is ignored.

Parameters:

<DataNumber> Max. 20 different data sequences can be defined.

Range: 0 to 13

<DataStream> 16 ASCII coded hexadecimal characters (blocks A to D of the RDS groups)

TRANS=0 deletes all transparent data and switches back to normal RDS data transmission.

Note: 16 characters must be specified for each data sequence. Leading zeros, if any, must also be specified. Transmits the data even if it constitutes no meaningful RDS data.

Example: STEReo:DIReCt "TRANS1=0123456789ABCDEF"
Sends the data "0123456789ABCDEF" instead of the RDS data.

13 Troubleshooting and Error Messages

The R&S SMB100B distinguishes between various messages such as status messages, error messages, warnings, or information that are displayed in the "Info" line on the screen, and also entered in the error/event queue of the status reporting system.

This section describes the types of error messages and warnings. The status reporting system is described in detail in [Chapter A.1.5, "Status Reporting System"](#), on page 567.

You can also access an Info window with detailed information about all messages in a history list. For details, see [Chapter 13.4, "Querying Error Messages"](#), on page 532

13.1 Error Messages

Error messages indicate errors in the instrument. They are displayed in different colors depending on their importance and display duration. Errors (e.g. no calibration data) are displayed in red, information (e.g. file not found) and warnings in black. Warnings indicate less significant errors (e.g. the instrument operates outside specified data).

Some error messages require that the error must be eliminated before correct instrument operation can be ensured. To access the "Info" dialog with a list of current messages and a detailed description of each message, select "Info".

In the remote control mode, error messages are entered in the error/event queue of the status reporting system and can be queried with the command `SYSTem:ERRor?`. If the error queue is empty, 0 ("No error") is returned.

13.1.1 Volatile Messages

Volatile messages report automatic settings in the instrument (e.g. switching off incompatible types of modulation) or on illegal entries that are not accepted by the instrument (e.g. range violations). They are displayed in the info line on a yellow background. They are displayed on top of status information or permanent messages.

Volatile messages do not normally demand user actions and disappear automatically after a brief period of time. They are stored in the history, however.

Remote command:

```
:SYSTem:ERRor:ALL? or  
:SYSTem:ERRor:CODE[:NEXT]?
```

13.1.2 Permanent Messages

Permanent messages are displayed if an error occurs that impairs further instrument operation, e.g. a hardware fault. The error signaled by a permanent message must be eliminated before correct instrument operation can be continued.

The message is displayed until the error is eliminated. It covers the status display in the info line. After error elimination, the message automatically disappears and is also recorded in the history.

Remote command:

```
:SYSTem:ERRor:STATic?
```

13.2 SCPI-Error Messages

The SCPI error messages are the same in all SCPI instruments. Detailed information and an overview of all error messages as defined in SCPI standard can be found in the corresponding documentation.

SCPI errors have negative codes (numbers). The error text being entered into the error/event queue or being displayed is printed in bold face on the left together with the error code. Below the error text, there is an explanation as to the respective error.

13.3 Device-Specific Error Messages

The following table contains all error messages specific for the instrument in alphabetical order, as well as an explanation of the error situation. The positive error codes mark the errors specific to the instrument.

The device-specific error messages set bit 3 in the ESR register.



The index provides a list of the error messages sorted according to their error codes.

Error Code	Error	Description	Remedy
50	Extern reference out of range or disconnected	External reference is selected but no external signal is applied or the signal is out of range.	<ul style="list-style-type: none"> Check the selected reference signal source (internal or external) in the "Setup > Reference Oscillator" dialog. Change setting to 'internal' if no appropriate external source is available.
140	This modulation forces other modulations off	A modulation has been switched on which cannot be used at the same time as an already active modulation. The previous modulation has been switched off.	
180	Adjustment failed	Adjustment could not be executed	Generate the adjustment data and load it into the device
182	Adjustment data missing	Adjustment data is missing.	Generate the adjustment data and load it into the device

Error Code	Error	Description	Remedy
183	Adjustment data invalid	Adjustment data is invalid and must be restored.	Generate the adjustment data and load it into the device
200	Cannot access hardware	The data transmission to a module was unsuccessful.	The module is not installed, not properly installed or missing.
201	Hardware revision out of date	A later version of certain parts of the instrument is necessary to execute the function selected.	The driver does not support the installed version of a module.
202	Cannot access the EEPROM	An error occurs when writing or reading a EEPROM.	The EEPROM is possibly defect. Replace it.
203	Invalid EEPROM data	Reading a EEPROM is possible, however the data are inconsistent.	
204	Driver initialization failed	Initialization of a driver fails when booting the instrument firmware.	The driver is not compatible with the hardware or software configuration of the instrument.
241	No current list	There is no list selected. To execute the required operation, a list has to be selected in the related dialog. If no list is available, a new list must be created.	
242	Unknown list type specified	The list type selected is not valid for the required operation.	Check the selected list type.
460	Cannot open the file	The selected file cannot be opened.	Check the path and file name.
461	Cannot write file	The file cannot be written.	Check if the file is read-only.
462	Cannot read file	The file cannot be read.	Check if the file contents are compatible with the file type.
463	Filename missing	The required operation cannot be executed because the file name is not specified.	Enter file name when creating list.
464	Invalid filename extension	The file extension is not valid for the required operation.	Check the file extension.
465	File contains invalid data	The selected file contains data that is not valid for the file type. The file extension determines the data that is valid for this file type. If the file extension is changed, the lists are no longer recognized and the data is therefore invalid.	Check the file extension.

13.4 Querying Error Messages

The R&S SMB100B monitors the functions performed and automatically detects errors and irregularities. The instrument displays the messages in the "Info" line and records them in the background with a detailed description.

Find details to the system messages in [Chapter 13, "Troubleshooting and Error Messages"](#), on page 530.

To display information on static errors and error history

1. In the taskbar, select the "Info" icon.
2. For some messages, the information line appears briefly on the home screen. To open the dialog, in the "Info" line select the "Info" button.

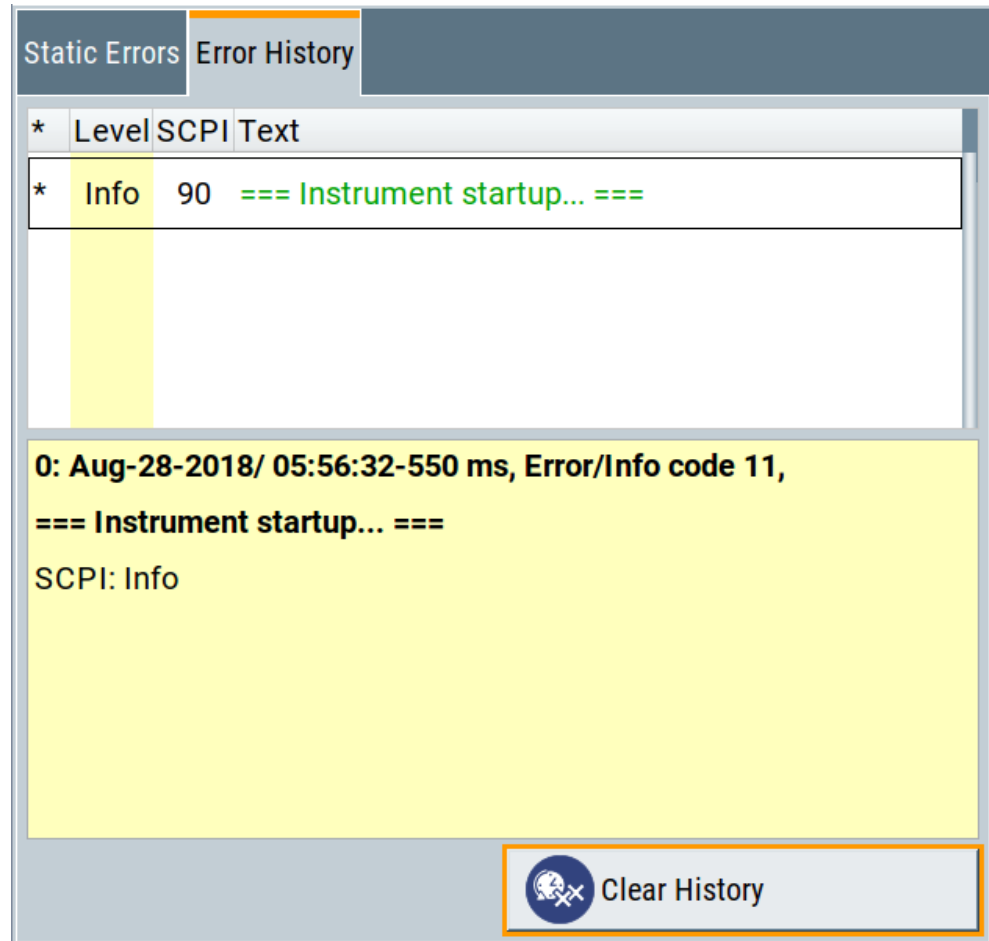

- The "Static Errors" dialog lists the last monitored messages chronologically and displays additional information on the highlighted message.
- The "Error History" dialog lists the accumulated messages with a short description.
 Volatile errors are reported once, at the time they appear. If identical errors occur subsequently, they are not reported repeatedly.
 In the "Info" line, identical errors are displayed repeatedly only if the original error has already disappeared from the display. If queried by SCPI command, identical errors are only reported if the original error has already been retrieved from (and hence not any more present in) the error queue.



Indication and handling of permanent messages

If any critical error occurs, the R&S SMB100B automatically shows the  icon in the taskbar. Select the icon to obtain information on the error and the number of occurrences.

The icon is assigned to permanent messages. The message and icon are displayed until the error is eliminated.

Static Errors/Error History

Toggles between "Static" and "History" view of the info dialog.

Remote command:

`:SYSTem:ERRor[:NEXT]?` on page 479

Each time a `SYST:ERR:NEXT?` query is sent, the eldest entry in the error queue is returned and at the same time cleared in the list.

`:SYSTem:ERRor:STATic?` on page 480

Queries the list of all errors.

Clear History

Clears all messages in the "History" view.

Remote command:

`:SYSTem:ERRor:ALL?` on page 478

Each time a `SYST:ERR:ALL?` query is sent, the error queue is returned and at the same time cleared.

`:SYSTem:ERRor:HISTory:CLEar` on page 480

Clears the messages in the "History" view.

13.5 Resolving Network Connection Failures

Several issues may cause failures in the network connection to the instrument. This section lists the most likely reasons and the recommended solutions.

Common reasons for network connection failures

- Network connecting cables and cable connectors of poor quality
- Incompatibility between the network interface of the R&S SMB100B and certain switches or routers available on the market
- An invalid IP address assigned to the instrument

Possible solutions to network connection failures

1. **NOTICE!** Connecting to the network can cause network failure. Errors can affect the entire network.

Consult your network administrator before performing the following tasks:

- Connecting the instrument to the network
- Configuring the network
- Changing IP addresses

2. Try out the following to resolve network connection failures:
 - Check the network infrastructure. Exchange connecting cables, if obvious damage is visible.
See also "[Cable selection and electromagnetic interference \(EMI\)](#)" on page 26.
 - Observe the link status LED on the R&S SMB100B or the connected network device. The link status LED is located next to the LAN connector.
If a link failure is detected, connect the instrument to a different device port or to a different network device.
 - Check whether the LAN interface and the required LAN services are enabled.
See [Chapter 10.4.3, "Configuring LAN Services"](#), on page 248.
 - If the IP address is set manually (no DHCP) or obtained via the Zeroconf (APIPA) protocol:
 - Check whether the IP address of the instrument is within the network's address range.
 - Check whether the IP address is valid.See also "[IP Address](#)" on page 270.

13.6 Measuring USB cable quality

To check the quality of the USB cable, see the service manual of the R&S SMB100B.

13.7 Requesting Instrument Configuration and Specifications

The R&S SMB100B is equipped with various hardware and software components. To get an overview of what your instrument is equipped with, you can request the assemblies, hardware and software options, and the firmware version. The components are structured according to the hardware configuration, software options, including the license management, and externally used Rohde & Schwarz equipment, like R&S NRP power sensors.



Software options purchased at a later stage can be activated with a keycode. The activation code is supplied with the software option. How to install options is described in chapter 4 of the R&S SMB100B service manual.

The installation of hardware options purchased at a later stage is also described in chapter 4 of the service manual. Most of the hardware options have to be installed at an authorized Rohde & Schwarz service center.

13.7.1 Hardware Configuration Settings

Access:

- ▶ Select "System Config > Setup > Instrument Assembly > Hardware Config".

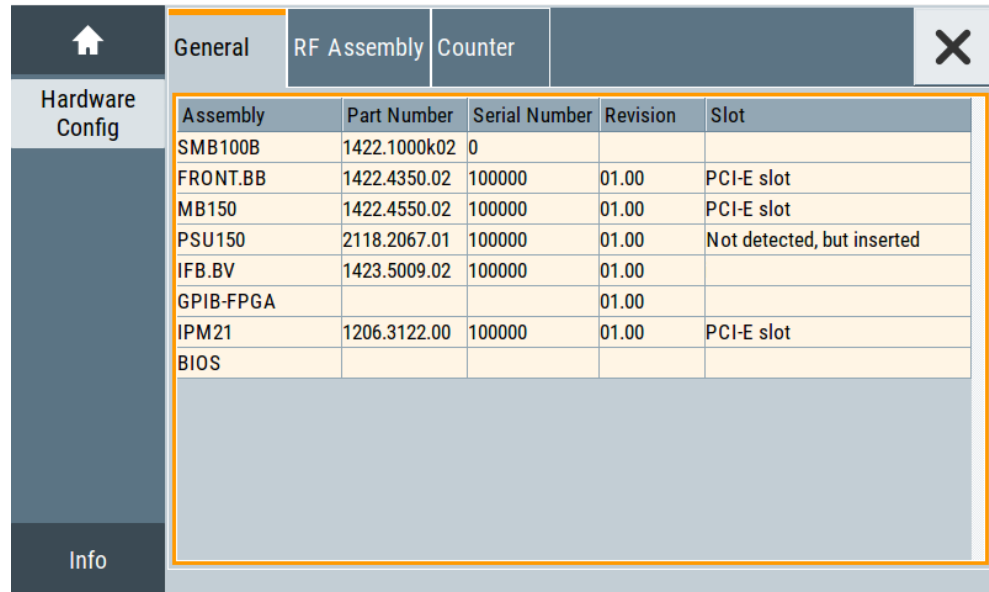

Assembly	Part Number	Serial Number	Revision	Slot
SMB100B	1422.1000k02	0		
FRONT.BB	1422.4350.02	100000	01.00	PCI-E slot
MB150	1422.4550.02	100000	01.00	PCI-E slot
PSU150	2118.2067.01	100000	01.00	Not detected, but inserted
IFB.BV	1423.5009.02	100000	01.00	
GPIB-FPGA			01.00	
IPM21	1206.3122.00	100000	01.00	PCI-E slot
BIOS				

The "Hardware Config" dialog lists all installed assemblies and externally connected instruments with information on their part and serial numbers, and revision states. The BIOS version is also listed; firmware updates do not update the BIOS version.

The dialog is divided in tabs, according to the hardware components of the signal domains. The "Counter" tab provides information on the operation time and number of times the instrument was powered on.

The remote commands required to query the hardware configuration are described in [Chapter 12.7, "DIAGnostic Subsystem"](#), on page 340.

Assembly

The tables in the tabs show characteristics of the installed assemblies.

"Assembly" Assembly designation.

"Part Number" Part number of the assembly.

"Serial Number" Serial number of the assembly.

"Revision" Revision state of the assembly.

"Slot" Indicates whether the assembly is connected to the serial bus or PCI bus.

Remote command:

:DIAGnostic<hw>:BGInfo? on page 341

Counter

Displays information on the operation times of the R&S SMB100B.

Operation Time / h ← Counter

Displays the operation time in hours so far.

Remote command:

`:DIAGnostic:INFO:OTIME?` on page 342

Power On Count ← Counter

Displays the number the instrument has been turned on.

Remote command:

`:DIAGnostic:INFO:POCount?` on page 342

Last Factory Calibration ← Counter

Displays the date of the last factory calibration.

Remote command:

`:CALibration:DATA:FACTory:DATE?` on page 339

13.7.2 Versions/Options Settings

Access:

- ▶ Select "System Config > Setup > Instrument Assembly > Versions / Options".

Firmware	Hardware Options	Software Options	Versions
Package	Version		
FW	4.20.044		
Service Pack	not installed		
Bios Version	VirtualBox		
Downgrade Info:			
Package	Version		
Factory Version	4.20.044		
Min. Version	4.00.016.00		
<p>The Min. Version is the first version supporting all hardware modules installed in this instrument. Please read release notes carefully before downgrading, some software options and features may get lost.</p>			
<input type="button" value="Show Open Source Acknowledgements"/>			

The "Versions/Options" dialog shows the version of the installed instrument firmware, the hardware and software options, the data sheet and the software components of the firmware. The BIOS version is also listed; firmware updates do not update the BIOS version.

The remote commands required to query the hardware configuration are described in [Chapter 12.7, "DIAGnostic Subsystem"](#), on page 340.

Firmware

Shows the firmware version and the version of the software platform.

Note: Your instrument is delivered with the latest firmware version available. You can download firmware updates and the "Release Notes" that describe the modifications and the firmware update procedure.

See www.rohde-schwarz.com/firmware/smb100b

Remote command:

n.a.

Downgrade Info

Shows downgrade information, like factory firmware version and minimum firmware version to that the instrument can be downgraded.

Remote command:

n.a.

Show Open Source Acknowledgments

Accesses the list of the used open-source software packages and the corresponding verbatim license texts.

Hardware Options/Software Options

The tables in the "Hardware" and "Software" tabs list the installed hardware and software options.

"Option" Short name of option

"Designation" Name of option

"Expiration Date"

For regular options, "Permanent" is indicated in this column. Some options are available as trial versions. This column shows their expiration date. After this date, the option is no longer available on the instrument.

Remote command:

[*OPT?](#) on page 323

[*IDN?](#) on page 322

Versions

The "Versions" tab shows the versions of the technical specification of the R&S SMB100B and of the software components that comprise the firmware.

"Package" Name of the component.

"Version" Current issue of the component.

E.g. the data sheet covers the technical data of the hardware components of the factory settings.

See also "[Data Sheet](#)" on page 285.

Remote command:

[:SYSTEM:SPECification:VERSion:FACTory?](#) on page 495

13.7.3 How to Query Instrument Configuration

To get information on the components and installed options of the R&S SMB100B, proceed as described in the following examples.

Checking the installed hardware options

To find out the installed options:

1. Select "System Config > Setup > Instrument Assembly > Versions/Options".
2. Select "Hardware Options".

Option	Designation	
SMBB-B3	1 GHz Reference	
SMBB-B5	Stereo/RDS Coder	
SMBB-B1H	High Performance OCXO	
SMBB-B86	Remote Control (GPIB and USB)	
SMBB-B106	RF option 9 KHz to 6 GHz	

The dialog lists all hardware options that are installed on the R&S SMB100B.

Proceed the same way to get information for instance on the firmware, or the installed software options in the corresponding tab.

Checking the RF hardware assembly

To find out the installed RF hardware:

1. Select "System Config > Setup > Instrument Assembly > Hardware Config".

2. Select "RF Assembly".

General		RF Assembly	Counter			✕
Assembly	Part Number	Serial Number	Revision	Slot		
STEREOCODER	1407.3240.00	100000	01.00			
FIRMWARE			01.00			
DSP			01.00			
OCX10M	1416.2508.04	100000	04.00			
HP6	1422.4180.02	100000	01.00			
HP6-CPLD (Hw)			00.00			
RFBB	1422.4009.02	100000	01.00			
MOD-FPGA			01.00			
SMBB_MOD (Hw)			00.00			
SMBB_MOD (Fw)			00.00.00.00			

The dialog lists the RF hardware components that are installed on the R&S SMB100B.

Proceed the same way to get information for instance on general or baseband hardware modules, or on the operating times of the R&S SMB100B in the corresponding tab.

13.7.4 How to Request the Data Sheet

You can access data sheet related information via the LXI web browser, see "[Data Sheet](#)" on page 285.

13.8 Collecting Information for Technical Support

If you encounter problems that you cannot solve yourself, contact your Rohde & Schwarz support center as listed at <http://www.customersupport.rohde-schwarz.com>. Our support center staff is optimally trained to assist you in solving problems.

The support center finds solutions more quickly and efficiently if you provide them with information on the instrument and an error description.

- The following dialog boxes in the "Setup > Instrument Assembly" menu provide useful information:
 - **Hardware Configuration:** hardware assemblies

- **Software and Options:** the status of all software and hardware options installed on your instrument
- **System Messages:** displayed in the "Info" line and provide information on any errors that have occurred
- **Support file:** a special file (*.tar.gz file) with important support information that can be created automatically.
The support *.tar.gz file has a user definable name and contains the following files and information:
 - SgErrors.txt: chronological record of errors
 - SystemRestorationSMB100B.savrc1.txt: instrument settings at the last correct shutdown of the instrument
 - UndoHistSuppInfo.xml: list of the last user interactions
 - DeviceFootprint_<SerialNumber>_<Date>_<Time>.xml: service-related information on the instrument's configuration.
 - crashlog.txt, coreDump: Postmortem debug info
 - Several files with information on the last performed adjustment and self-test.

See also the description of error messages [Chapter 13.1, "Error Messages"](#), on page 530.

To collect error information in a support file

1. Connect a USB device to the R&S SMB100B.
2. Select "System Config > Setup > Maintenance > Create R&S Support Information".
3. In the "Create R&S Support Information" dialog, navigate to the /usb directory. Enter the support filename, for example RSupport_DeviceInfo.

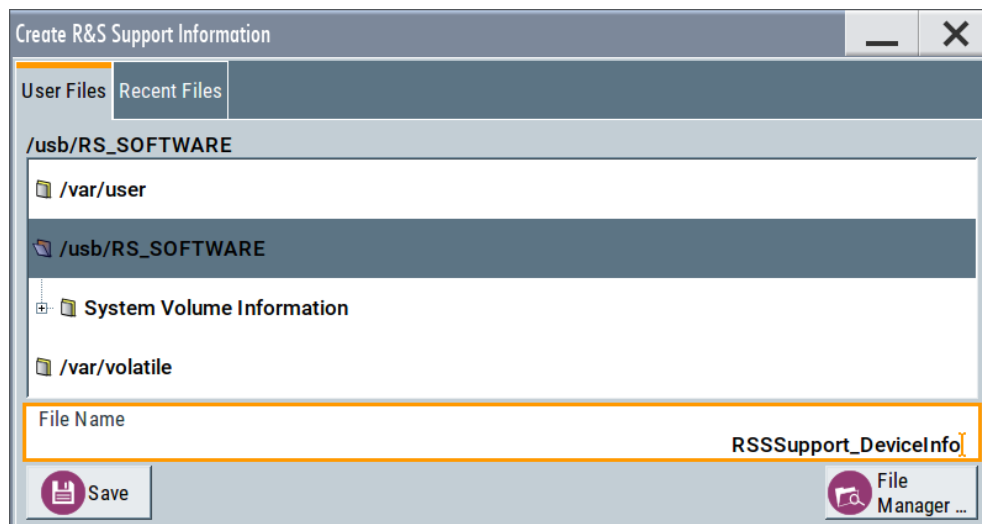

The error information and further required data is collected automatically. The support file RSupport_DeviceInfo.tar.gz is created and stored in the /usb directory.

Collect the error information and attach it to an email in which you describe the problem. Send the email to the customer support address for your region as listed on the Internet (<http://www.customersupport.rohde-schwarz.com>).

To remove sensitive data

- ▶ For information on how to handle or remove the sensitive data from your instrument, refer to the description "Resolving Security Issues when working with R&S SMB100B".

Packing and transporting the instrument

- ▶ If the instrument has to be transported or shipped, see [Chapter 14, "Transporting"](#), on page 543.

13.9 Contacting Customer Support

Technical support – where and when you need it

For quick, expert help with any Rohde & Schwarz product, contact our customer support center. A team of highly qualified engineers provides support and works with you to find a solution to your query on any aspect of the operation, programming or applications of Rohde & Schwarz products.

Contact information

Contact our customer support center at www.rohde-schwarz.com/support, or follow this QR code:



Figure 13-1: QR code to the Rohde & Schwarz support page

14 Transporting

Lifting and carrying

See:

- ["Lifting and carrying the product"](#) on page 19
- [Chapter 3.1.1, "Lifting and Carrying"](#), on page 23.

Packing

Use the original packaging material. It consists of antistatic wrap for electrostatic protection and packing material designed for the product.

If you do not have the original packaging, use similar materials that provide the same level of protection.

Securing

When moving the R&S SMB100B in a vehicle or using transporting equipment, make sure that the R&S SMB100B is properly secured. Only use items intended for securing objects.

Transport altitude

Unless otherwise specified in the data sheet, the maximum transport altitude without pressure compensation is 4500 m above sea level.

15 Maintenance, Storage and Disposal

The product does not require regular maintenance. It only requires occasional cleaning. It is however advisable to check the nominal data from time to time.

15.1 Cleaning

How to clean the product is described in "[Cleaning the product](#)" on page 21.

Do not use any liquids for cleaning. Cleaning agents, solvents (thinners, acetone), acids and bases can damage the front panel labeling, plastic parts and display.

15.2 Storage

Protect the product against dust. Ensure that the environmental conditions, e.g. temperature range and climatic load, meet the values specified in the data sheet.

15.3 Performing Maintenance Tasks

The R&S SMB100B is accurate due to integrated adjustment procedures. Internal adjustments are integrated self-calibration routines, which you can execute directly on the instrument.

Self-calibration routines that require additional equipment are performed at an authorized Rohde & Schwarz service center. For description, see R&S SMB100B service manual.

When to start internal adjustments?

We recommend that you perform internal adjustments in the following cases:

- Before starting any application, that requires a maximum of level accuracy
- When a long period of time has passed since the last adjustments
- If the ambient temperature of the instrument significantly differs from the one of the last adjustments.

How to: See [Chapter 15.3.3.2, "How to Use the Internal Adjustments"](#), on page 551.

15.3.1 Date and Time

The R&S SMB100B uses an internal real-time clock to determine the date and time. It adjusts the time and date to the timezone of your location automatically, by providing a selection list of continents and cities.

The instrument records the time whenever you create or modify files on your instrument or you use timed licenses. By default, the instrument is set to the UTC timezone, but you can select the timezone according to your location.

Moreover, the instrument supports [NTP](#) protocol for synchronizing all connected instruments and computer systems to minimize time delays in the network.

15.3.1.1 Data and Time Settings

Access:

- ▶ Select "System Config > Setup > Maintenance > Date / Time".

The "Date / Time" dialog contains the time and data settings of the operating system.

This function is password-protected. Unlock the protection level 1 to access it.

The required remote commands are described in [Chapter 12.15, "SYSTEM Subsystem"](#), on page 475.

Settings:

Date	545
Time	545
Timezone	546
NTP Address	546
Use Time from NTP Server	546

Date

Displays the date set in the operating system in the format [dd.mm.yyyy].

Remote command:

:[SYSTEM:DATE](#) on page 495

Time

Displays the time set in the operating system in the format [hh.mm.ss].

The time setting corresponds to the selected [Use Time from NTP Server](#).

Remote command:

:SYSTem:TIME on page 496

Timezone

Selects the timezone.

You can select the timezone according to the major cities on the respective continents.

Note: By typing the first letter, you can quickly navigate through the lists to find the desired destination.

Remote command:

:SYSTem:TIME:ZONE on page 497

:SYSTem:TIME:ZONE:CATalog? on page 497

NTP Address

Sets the IP address or host name of the NTP server.

NTP is a network time protocol used for synchronizing all participating devices in a data network.

You can select a high-precision time server to reduce the impact of varying network delays.

Remote command:

:SYSTem:NTP:HOSTname on page 496

Use Time from NTP Server

Activates clock synchronization of the network via the NTP protocol.

Remote command:

:SYSTem:NTP:STATE on page 496

15.3.1.2 How To Set Data and Time

To select the timezone

1. Press the [Setup] key.
2. Select "Maintenance > Date /Time > Timezone".
3. Select continent and city of your location.
Tip: By typing the first letter, you can quickly navigate through the lists to find the desired destination.
4. Close the dialogs.

The instrument adjusts the time according to the selected location.

To set the date and time

1. Press the [Setup] key.
2. Select "Security > Protection".
3. Enable the "Protection Level 1".

The default password is 123456.

4. Select "Setup > Maintenance > Date / Time".
5. Adjust the settings.
6. Close the dialogs.

The instrument adopts the new date and time.

15.3.2 Check Front Panel

Within this dialog, you can verify the functionality of the control keys.

How To: See [Chapter 15.3.2.2, "How to Test the Front Panel"](#), on page 547

15.3.2.1 Check Front Panel Settings

Access:

- ▶ Select "System Config > Setup > Maintenance > Check Front Panel".



Reflecting the front panel, the "Check Front Panel" dialog contains all functions to test the operating elements of the instrument.

15.3.2.2 How to Test the Front Panel

See:

- ["Testing the key panel"](#) on page 548

- "Testing the touchscreen" on page 548
- "Terminating the test" on page 549
- "Debugging" on page 549

Testing the key panel

To perform the key panel test, you operate the keys at the front panel, and check the response of the instrument in the "Check Front Panel" dialog. To perform this test properly, check each key of the front panel. The test is only completed, when you have verified all keys.

During the test, the actual functions of the keys are disabled.

1. Press the [Setup] key.
2. Select "Maintenance > Check Front Panel"
The "Check Front Panel" dialog opens.
3. Press a key on the front panel.
Check if the corresponding key in the "Check Front Panel" dialog turns green.
4. Press the same key a second time.
Check that the key in the dialog turns red.
Note: Pressing the same key again has no further effect, except for the [Esc] key. Pressing this key a third time, terminates the test procedure.
5. Continue with the next key on the front panel and repeat [step 3](#) to [step 5](#) until all keys are tested.

The test is completed, when each key is verified successfully, confirmed by a "Test passed" message.

Testing the touchscreen

1. Press the [Setup] key.
2. Select "Maintenance > Check Touch Panel"
The "Finger Paint" test window opens.

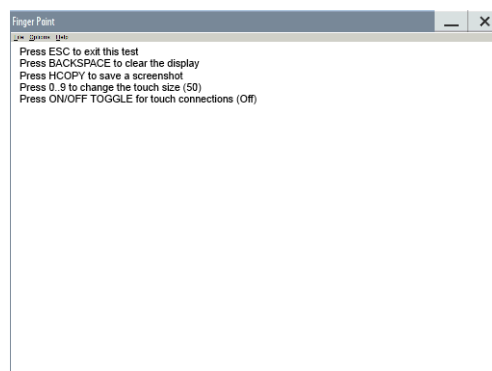

3. Drag with your finger one or more lines, for example diagonally across the screen.

The test traces the movements of your finger on the screen.

The following results are expected:

- If the lines are uninterrupted, the touchscreen works properly.

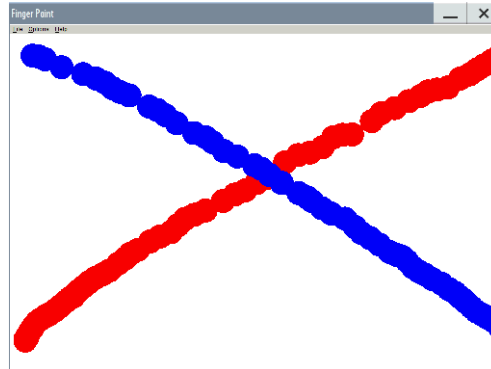

- If there are any gaps, the touch-sensitive functionality is damaged.

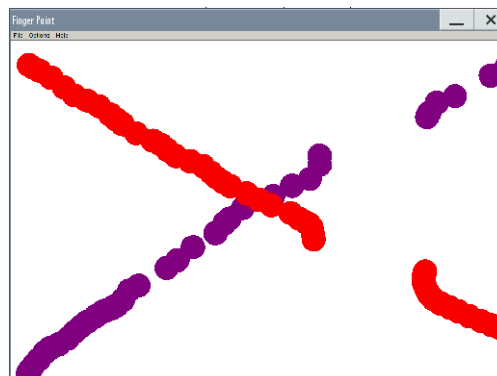

- To return to the "Check Front Panel" dialog, press [Esc].

Terminating the test

- ▶ Press the [Esc] key.

Exits the "Check Front Panel" dialog.

Debugging

1. If you detect a malfunction, for example, you press the front panel key the first time, and the color of the button in the dialog turns red (instead of green), the front panel key may be stuck.
2. Contact the Rohde & Schwarz customer support, see [Chapter 13.8, "Collecting Information for Technical Support"](#), on page 540.

15.3.3 Internal Adjustments

Internal adjustments are integrated adjustment procedures, which you can execute directly on the instrument.

15.3.3.1 Internal Adjustments Settings

Access:

- ▶ Select "System Config > Setup > General > Internal Adjustments".

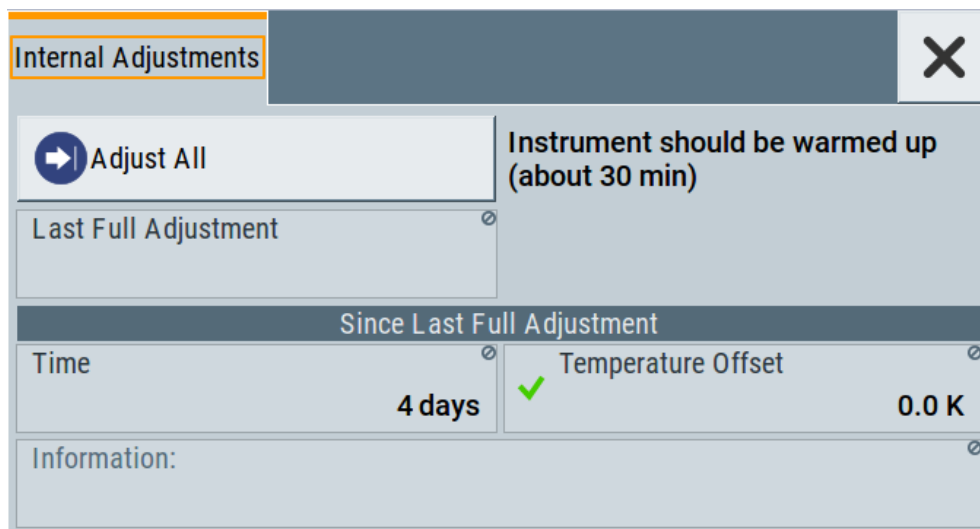

In this dialog, you can perform internal calibration routines and get information on the last performed calibration.

The "Temperature Offset" indicates the deviation of the current temperature of the instrument, compared to the temperature of the last adjustment.

The remote commands required to define these settings are described in [Chapter 12.6, "CALibration Subsystem"](#), on page 337.

How to: See [Chapter 15.3.3.2, "How to Use the Internal Adjustments"](#), on page 551.

Adjust All

Performs all available internal calibration routines of the instrument.

How to: See [Chapter 15.3.3.2, "How to Use the Internal Adjustments"](#), on page 551.

Remote command:

`:CALibration:ALL[:MEASure]?` on page 338

Last Full Adjustment

Displays the date of the last fully performed adjustment.

Remote command:

`:CALibration<hw>:ALL:DATE?` on page 338

Time

Displays the elapsed time since the last full adjustment.

Remote command:

`:CALibration<hw>:ALL:TIME?` on page 339

Temperature Offset

Displays the temperature difference, comparing the temperature of the last adjustment to the current instrument temperature.

A green checkmark indicates that the offset is within the permitted range. If the temperature deviates more than ± 5 K, the instrument indicates a warning icon.

Remote command:

`:CALibration<hw>:ALL:TEMP?` on page 339

Information

Displays information to the current adjustment state.

Remote command:

`:CALibration<hw>:ALL:INformation?` on page 338

Continue Adjustment on Error

Continues the calibration even though an error was detected. By default adjustments are aborted on error.

This function is password-protected. Unlock the protection level 1 to access it.

Remote command:

`:CALibration<hw>:CONTinueonerror` on page 340

15.3.3.2 How to Use the Internal Adjustments

Deciding whether to run internal adjustments

1. Select "System Config > Setup > Internal Adjustment".
2. Observe the status and color indication in the section "Since Last Full Adjustment".
Green: Internal adjustments are not required.
Red: Internal adjustments are required. Observe also the indication in the "Information" field.
3. We recommend that you run internal adjustments in the following cases:
 - Before starting any application, that requires a maximum of level accuracy
 - When a long period of time has passed since the last adjustments
 - If the ambient temperature of the instrument significantly differs from the one of the last adjustments.
4. Proceed as described in "[Running internal adjustments](#)" on page 551.

Running internal adjustments

1. **NOTICE!** Adjustments can be invalid if performed when the instrument is not warmed-up.
Wait until the instrument has reached its operating temperature before you start the adjustment procedure.
The warm-up time is up to 30 minutes.
2. Select "System Config > Setup > Internal Adjustment > Adjust All".

The adjustment process starts.

3. Do not interrupt the adjustment process.

The extent of the adjustments depends on the installed options.

A progress indicator shows the status of the adjustment process.

If any error occurs, the process aborts and an error message appears in the "Info" line.

If there is an error:

- Select "Info".
Observe the error message.
- Continue the process.
See "[Continuing the adjustment process if error appears](#)" on page 552.

Continuing the adjustment process if error appears

Per default, if any error occurs during the adjustment process, the process aborts. An error message appears in the "Info" line.

If you prefer to finish the adjustments also if there is an error, proceed as follows:

1. Select "System Config > Setup > Security > Protection" and unlock the protection level 1.
See "[Protection Level/Password](#)" on page 242.
2. Select "System Config > Setup > Internal Adjustment > Configuration > Continue Adjustment on Error > On".
3. Proceed as described in "[Running internal adjustments](#)" on page 551.

15.3.4 FPGA/uC Update Settings

Access:

- ▶ Select "System Config > Setup > Maintenance > FPGA/μC Update".

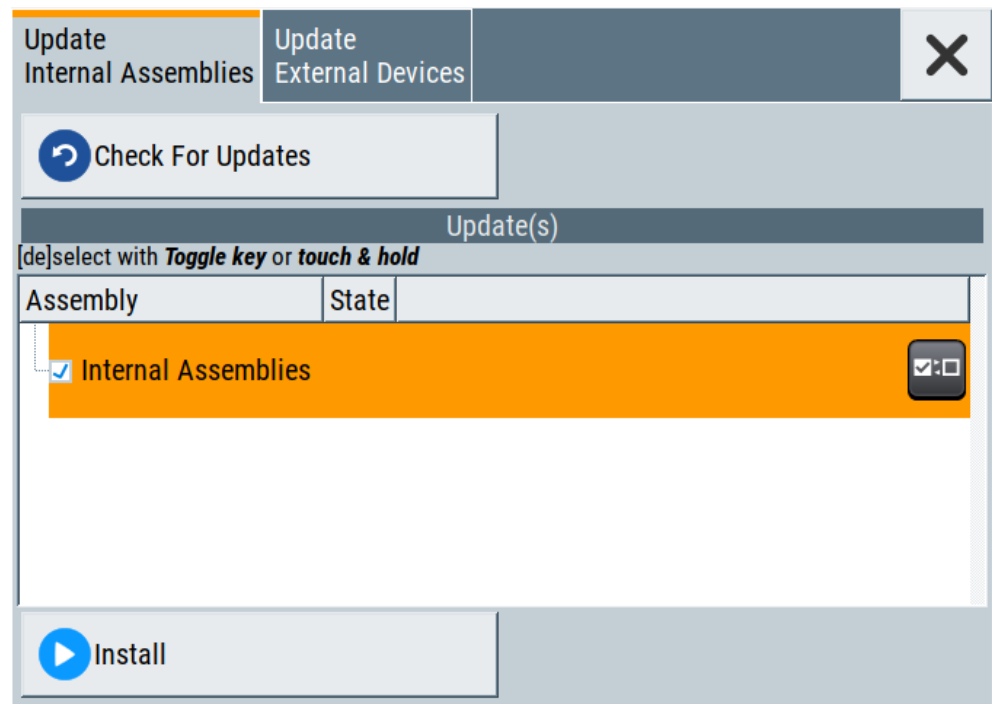

This dialog enables you to check for internal assembly updates and perform updates.

Settings:

Check For Updates.....	553
Assembly.....	553
Install.....	553
Shut down.....	554
Update External Devices.....	554
└ Check For Updates.....	554

Check For Updates

Check for updates of the FPGA/ μ C.

Remote command:

n.a.

Assembly

The table shows the installed assemblies and their states.

"Assembly" Assembly designation.

"State" Indicates the current state of installed assemblies.

Install

Install all available updates for the FPGA/ μ C.

Remote command:

n.a.

Shut down

For at least one assembly "State = Done" and no pending assemblies, shuts the instrument down to apply installed updates.

Remote command:

:SYSTem:SHUTdown on page 499

Update External Devices

This dialog shows the update options of external devices connected to the instrument.

Check For Updates ← Update External Devices

Check for updates of external devices.

Remote command:

n.a.

15.4 Disposal

Rohde & Schwarz is committed to making careful, ecologically sound use of natural resources and minimizing the environmental footprint of our products. Help us by disposing of waste in a way that causes minimum environmental impact.

Electrical and electronic equipment

A product that is labeled as follows cannot be disposed of in normal household waste after it has come to the end of its service life. Even disposal via the municipal collection points for waste electrical and electronic equipment is not permitted.



Figure 15-1: Labeling in line with EN 50419

Rohde & Schwarz has developed a disposal concept for the eco-friendly disposal or recycling of waste material. As a manufacturer, Rohde & Schwarz completely fulfills its obligation to take back and dispose of electrical and electronic waste. Contact your local service representative to dispose of the product.

Annex

A Reference Information for Remote Control

A.1 Additional Basics on Remote Control

This section provides basic information using the remote control.

A.1.1 Messages

The messages transferred on the data lines are divided into the following categories:

- **Interface messages**
Interface messages are transmitted to the instrument on the data lines, with the attention line being active (LOW). They are used to communicate between the controller and the instrument. Interface messages can only be sent by instruments that have GPIB bus functionality. For details see the sections for the required interface.
- **Instrument messages**
Instrument messages are employed in the same way for all interfaces, if not indicated otherwise in the description. Structure and syntax of the instrument messages are described in [Chapter A.1.3, "SCPI Command Structure"](#), on page 556. A detailed description of all messages available for the instrument is provided in the chapter "Remote Control Commands".
There are different types of instrument messages, depending on the direction they are sent:
 - Commands
 - Instrument responses

Commands

Commands (program messages) are messages the controller sends to the instrument. They operate the instrument functions and request information. The commands are subdivided according to two criteria:

- According to the effect they have on the instrument:
 - **Setting commands** cause instrument settings such as a reset of the instrument or setting the frequency.
 - **Queries** cause data to be provided for remote control, e.g. for identification of the instrument or polling a parameter value. Queries are formed by directly appending a question mark to the command header.
- According to their definition in standards:
 - **Common commands**: their function and syntax are precisely defined in standard IEEE 488.2. They are employed identically on all instruments (if implemented). They refer to functions such as management of the standardized status registers, reset and self-test.

- **Instrument control commands** refer to functions depending on the features of the instrument such as frequency settings. Many of these commands have also been standardized by the SCPI committee. These commands are marked as "SCPI confirmed" in the command reference chapters. Commands without this SCPI label are device-specific; however, their syntax follows SCPI rules as permitted by the standard.

Instrument responses

Instrument responses (response messages and service requests) are messages the instrument sends to the controller after a query. They can contain measurement results, instrument settings and information on the instrument status.

A.1.2 LAN Interface Messages

In the LAN connection, the interface messages are called low-level control messages. These messages can be used to emulate interface messages of the GPIB bus.

Command	Long term	Effect on the instrument
&ABO	Abort	Aborts processing of the commands just received.
&DCL	Device Clear	Aborts processing of the commands just received and sets the command processing software to a defined initial state. Does not change the instrument setting.
>L	Go to Local	Transition to the "local" state (manual control). (The instrument automatically returns to remote state when a remote command is sent UNLESS &NREN was sent before.)
>R	Go to Remote	Enables automatic transition from local state to remote state by a subsequent remote command (after &NREN was sent).
&GET	Group Execute Trigger	Triggers a previously active instrument function (e.g. a sweep). The effect of the command is the same as with that of a pulse at the external trigger signal input.
&LLO	Local Lockout	Disables transition from remote control to manual control by means of the front panel keys.
&NREN	Not Remote Enable	Disables automatic transition from local state to remote state by a subsequent remote command. (To re-activate automatic transition use >R.)
&POL	Serial Poll	Starts a serial poll.

A.1.3 SCPI Command Structure

SCPI commands consist of a header and, in most cases, one or more parameters. The header and the parameters are separated by a "white space" (ASCII code 0 to 9, 11 to 32 decimal, e.g. blank). The headers may consist of several mnemonics (keywords). Queries are formed by appending a question mark directly to the header.

The commands can be either device-specific or device-independent (common commands). Common and device-specific commands differ in their syntax.

A.1.3.1 Syntax for Common Commands

Common (= device-independent) commands consist of a header preceded by an asterisk (*), and possibly one or more parameters.

Table A-1: Examples of common commands

*RST	RESET	Resets the instrument.
*ESE	EVENT STATUS ENABLE	Sets the bits of the event status enable registers.
*ESR?	EVENT STATUS QUERY	Queries the contents of the event status register.
*IDN?	IDENTIFICATION QUERY	Queries the instrument identification string.

A.1.3.2 Syntax for Device-Specific Commands



Not all commands used in the following examples are necessarily implemented in the instrument. For demonstration purposes only, assume the existence of the following commands for this section:

- DISPLAY[:WINDow<1...4>]:MAXimize <Boolean>
- FORMat:READings:DATA <type>[,<length>]
- HCOpy:DEvice:COLor <Boolean>
- HCOpy:DEvice:CMAP:COLor:RGB <red>,<green>,<blue>
- HCOpy[:IMMediate]
- HCOpy:ITEM:ALL
- HCOpy:ITEM:LABel <string>
- HCOpy:PAGE:DIMensions:QUADrant [<N>]
- HCOpy:PAGE:ORientation LANDscape | PORTrait
- HCOpy:PAGE:SCALE <numeric value>
- MMEMory:COpy <file_source>,<file_destination>
- SENSE:BANDwidth|BWIDth[:RESolution] <numeric_value>
- SENSE:FREQuency:STOP <numeric value>
- SENSE:LIST:FREQuency <numeric_value>{,<numeric_value>}

- [Long and short form](#)..... 557
- [Numeric Suffixes](#)..... 558
- [Optional Mnemonics](#)..... 558

Long and short form

The mnemonics feature a long form and a short form. The short form is marked by upper case letters, the long form corresponds to the complete word. Either the short form or the long form can be entered; other abbreviations are not permitted.

Example:

HCOPY:DEVIce:COLor ON is equivalent to HCOP:DEV:COL ON.

**Case-insensitivity**

Upper case and lower case notation only serves to distinguish the two forms in the manual, the instrument itself is case-insensitive.

Numeric Suffixes

If a command can be applied to multiple instances of an object, e.g. specific channels or sources, the required instances can be specified by a suffix added to the command. Numeric suffixes are indicated by angular brackets (<1...4>, <n>, <i>) and are replaced by a single value in the command. Entries without a suffix are interpreted as having the suffix 1.

Example:

Definition: HCOpy:PAGE:DIMensions:QUADrant [<N>]

Command: HCOP:PAGE:DIM:QUAD2

This command refers to the quadrant 2.

**Different numbering in remote control**

For remote control, the suffix may differ from the number of the corresponding selection used in manual operation. SCPI prescribes that suffix counting starts with 1. Suffix 1 is the default state and used when no specific suffix is specified.

Some standards define a fixed numbering, starting with 0. If the numbering differs in manual operation and remote control, it is indicated for the corresponding command.

Optional Mnemonics

Some command systems permit certain mnemonics to be inserted into the header or omitted. These mnemonics are marked by square brackets in the description. The instrument must recognize the long command to comply with the SCPI standard. Some commands are considerably shortened by these optional mnemonics.

Example:

Definition: HCOpy[:IMMediate]

Command: HCOP:IMM is equivalent to HCOP



Optional mnemonics with numeric suffixes

Do not omit an optional mnemonic if it includes a numeric suffix that is relevant for the effect of the command.

Example:

Definition: `DISPlay[:WINDow<1...4>]:MAXimize <Boolean>`

Command: `DISP:MAX ON` refers to window 1.

In order to refer to a window other than 1, you must include the optional `WINDow` parameter with the suffix for the required window.

`DISP:WIND2:MAX ON` refers to window 2.

A.1.3.3 SCPI Parameters

Many commands are supplemented by a parameter or a list of parameters. The parameters must be separated from the header by a "white space" (ASCII code 0 to 9, 11 to 32 decimal, e.g. blank).

The parameters required for each command and the allowed range of values are specified in the command description.

Allowed parameters are:

• Numeric Values	559
• Special Numeric Values	560
• Boolean Parameters	560
• Text Parameters	561
• Character Strings	561
• Block Data	561

Numeric Values

Numeric values can be entered in any form, i.e. with sign, decimal point and exponent. Values exceeding the resolution of the instrument are rounded up or down. The mantissa may comprise up to 255 characters, the exponent must lie inside the value range -32000 to 32000. The exponent is introduced by an "E" or "e". Entry of the exponent alone is not allowed.

Example:

`SENS:FREQ:STOP 1500000 = SENS:FREQ:STOP 1.5E6`

Units

For physical quantities, the unit can be entered. If the unit is missing, the basic unit is used. Allowed unit prefixes are:

- G (giga)
- MA (mega), MOHM, MHZ
- K (kilo)
- M (milli)
- U (micro)

- N (nano)

Example:

```
SENSe:FREQ:STOP 1.5GHz = SENSe:FREQ:STOP 1.5E9
```

Some settings allow relative values to be stated in percent. According to SCPI, this unit is represented by the `PCT` string.

Example:

```
HCOP:PAGE:SCAL 90PCT
```

Special Numeric Values

The following mnemonics are special numeric values. In the response to a query, the numeric value is provided.

- **MIN and MAX:** denote the minimum and maximum value.
- **DEF:** denotes a preset value which has been stored in the EPROM. This value conforms to the default setting, as it is called by the `*RST` command.
- **UP and DOWN:** increases or reduces the numeric value by one step. The step width can be specified via an allocated step command for each parameter which can be set via `UP` and `DOWN`.
- **INF and NINF:** INfinity and negative INfinity (NINF) represent the numeric values $9.9E37$ or $-9.9E37$, respectively. `INF` and `NINF` are only sent as instrument responses.
- **NAN:** Not A Number (NAN) represents the value $9.91E37$. `NAN` is only sent as a instrument response. This value is not defined. Possible causes are the division of zero by zero, the subtraction of infinite from infinite and the representation of missing values.

Example:

Setting command: `SENSe:LIST:FREQ MAXimum`

Query: `SENS:LIST:FREQ?`

Response: `3.5E9`

**Queries for special numeric values**

The numeric values associated to `MAXimum`/`MINimum`/`DEFault` can be queried by adding the corresponding mnemonic after the quotation mark.

Example: `SENSe:LIST:FREQ? MAXimum`

Returns the maximum numeric value as a result.

Boolean Parameters

Boolean parameters represent two states. The "ON" state (logically true) is represented by "ON" or a numeric value 1. The "OFF" state (logically untrue) is represented by "OFF" or the numeric value 0. The numeric values are provided as the response for a query.

Example:

Setting command: `HCOPY:DEV:COL ON`

Query: `HCOPY:DEV:COL?`

Response: 1

Text Parameters

Text parameters observe the syntactic rules for mnemonics, i.e. they can be entered using a short or long form. Like any parameter, they have to be separated from the header by a white space. In the response to a query, the short form of the text is provided.

Example:

Setting command: `HCOPY:PAGE:ORIENTATION LANDscape`

Query: `HCOPY:PAGE:ORI?`

Response: LAND

Character Strings

Strings must always be entered in quotation marks (' or ").

Example:

`HCOPY:ITEM:LABEL "Test1"`

`HCOPY:ITEM:LABEL 'Test1'`

Block Data

Block data is a format which is suitable for the transmission of large amounts of data. For example, a command using a block data parameter has the following structure:

```
FORMat:READings:DATA #45168xxxxxxxx
```

The ASCII character # introduces the data block. The next number indicates how many of the following digits describe the length of the data block. In the example the 4 following digits indicate the length to be 5168 bytes. The data bytes follow. During the transmission of these data bytes all end or other control signs are ignored until all bytes are transmitted.

#0 specifies a data block of indefinite length. The use of the indefinite format requires a `NL^END` message to terminate the data block. This format is useful when the length of the transmission is not known or if speed or other considerations prevent segmentation of the data into blocks of definite length.

A.1.3.4 Overview of Syntax Elements

The following tables provide an overview of the syntax elements and special characters.

Table A-2: Syntax elements

:	The colon separates the mnemonics of a command.
;	The semicolon separates two commands of a command line. It does not alter the path.
,	The comma separates several parameters of a command.
?	The question mark forms a query.
*	The asterisk marks a common command.
' '	Quotation marks introduce a string and terminate it (both single and double quotation marks are possible).
#	The hash symbol introduces binary, octal, hexadecimal and block data. <ul style="list-style-type: none"> • Binary: #B10110 • Octal: #O7612 • Hexa: #HF3A7 • Block: #21312
	A "white space" (ASCII-Code 0 to 9, 11 to 32 decimal, e.g. blank) separates the header from the parameters.

Table A-3: Special characters

	<p>Parameters</p> <p>A vertical stroke in parameter definitions indicates alternative possibilities in the sense of "or". The effect of the command differs, depending on which parameter is used.</p> <p>Example:</p> <p>Definition:HCOPY:PAGE:ORIENTATION LANDscape PORTRait</p> <p>Command HCOP:PAGE:ORI LAND specifies landscape orientation</p> <p>Command HCOP:PAGE:ORI PORT specifies portrait orientation</p> <p>Mnemonics</p> <p>A selection of mnemonics with an identical effect exists for several commands. These mnemonics are indicated in the same line; they are separated by a vertical stroke. Only one of these mnemonics needs to be included in the header of the command. The effect of the command is independent of which of the mnemonics is used.</p> <p>Example:</p> <p>DefinitionSENSE:BANDwidth BWIDth[:RESolution] <numeric_value></p> <p>The two following commands with identical meaning can be created:</p> <p>SENS:BAND:RES 1</p> <p>SENS:BWID:RES 1</p>
[]	<p>Mnemonics in square brackets are optional and may be inserted into the header or omitted.</p> <p>Example: HCOPY[:IMMEDIATE]</p> <p>HCOP: IMM is equivalent to HCOP</p>
{ }	<p>Parameters in curly brackets are optional and can be inserted once or several times, or omitted.</p> <p>Example: SENSE:LIST:FREQUENCY <numeric_value>{,<numeric_value>}</p> <p>The following are valid commands:</p> <p>SENS:LIST:FREQ 10</p> <p>SENS:LIST:FREQ 10,20</p> <p>SENS:LIST:FREQ 10,20,30,40</p>

A.1.3.5 Structure of a Command Line

A command line may consist of one or several commands. It is terminated by one of the following:

- <New Line>
- <New Line> with EOI
- EOI together with the last data byte

Several commands in a command line must be separated by a semicolon ";".

Example:

```
MMEM:COPY "Test1", "MeasurementXY";:HCOP:ITEM ALL
```

This command line contains two commands. The first command belongs to the MMEM system, the second command belongs to the HCOP system. If the next command belongs to a different command system, the semicolon is followed by a colon.

Example:

```
HCOP:ITEM ALL;:HCOP:IMM
```

This command line contains two commands. Both commands are part of the HCOP command system, i.e. they have one level in common.

If the successive commands belong to the same system, having one or several levels in common, the command line can be abbreviated. When abbreviating the command line, the second command begins with the level below HCOP. The colon after the semicolon is omitted. The abbreviated form of the command line reads as follows:

```
HCOP:ITEM ALL;IMM
```

Example:

```
HCOP:ITEM ALL
```

```
HCOP:IMM
```

A new command line always begins with the complete path.

A.1.3.6 Responses to Queries

A query is defined for each setting command unless explicitly specified otherwise. It is formed by adding a question mark to the associated setting command. According to SCPI, the responses to queries are partly subject to stricter rules than in standard IEEE 488.2.

- The requested parameter is transmitted without a header.
Example: `HCOP:PAGE:ORI?`, **Response:** `LAND`
- Maximum values, minimum values and all other quantities that are requested via a special text parameter are returned as numeric values.
Example: `SENSe:FREQuency:STOP? MAX`, **Response:** `3.5E9`
- Numeric values are output without a unit. Physical quantities are referred to the basic units or to the units set using the `Unit` command. The response `3.5E9` in the previous example stands for 3.5 GHz.

- Truth values (Boolean values) are returned as 0 (for OFF) and 1 (for ON).

Example:

Setting command: `HCOPY:DEV:COL ON`

Query: `HCOPY:DEV:COL?`

Response: 1

- Text (character data) is returned in a short form.

Example:

Setting command: `HCOPY:PAGE:ORIENTATION LANDscape`

Query: `HCOPY:PAGE:ORI?`

Response: LAND

- Invalid numerical results
In some cases, particularly when a result consists of multiple numeric values, invalid values are returned as 9.91E37 (not a number).

A.1.4 Command Sequence and Synchronization

IEEE 488.2 defines a distinction between overlapped and sequential commands:

- A sequential command always completes executing before the next command starts. Commands that are processed quickly are defined as sequential commands. They are not implemented in the instrument. However, the execution time of most of the commands is so short that they act as sequential commands, if they are sent in separate command lines.
- An overlapping command is still running when the next command starts. Usually, an overlapping command takes a certain time to process its task, and thus allows the program to execute other tasks, while it is still running. If overlapping commands have to follow a specific order, for example to avoid incorrect measurement readings, they must be executed in sequence. This is called synchronization between the controller and the instrument.

Several setting commands within a command line are not necessarily processed in the order they are received. Even if they are implemented as sequential commands. To follow a particular sequence, send each command in a separate line.



As a rule, send commands and queries in different program messages.

A.1.4.1 Preventing Overlapping Execution

To prevent an overlapping execution of commands, one of the commands `*OPC`, `*OPC?` or `*WAI` can be used. All three commands cause a certain action only to be carried out after the hardware has been set. The controller can be forced to wait for the corresponding action to occur.

Table A-4: Synchronization using *OPC, *OPC? and *WAI

Command	Action	Programming the controller
*OPC	Sets the Operation Complete bit in the ESR after all previous commands have been executed.	<ul style="list-style-type: none"> Setting bit 0 in the ESE Setting bit 5 in the SRE Waiting for service request (SRQ)
*OPC?	Stops command processing until 1 is returned. This occurs when all pending operations are completed.	Send *OPC? directly after the command whose processing must be terminated before other commands can be executed.
*WAI	Stops further command processing until all commands sent before *WAI have been executed.	Send *WAI directly after the command whose processing must be terminated before other commands are executed.

Command synchronization using *WAI or *OPC? is a good choice if the overlapped command takes only little time to process. The two synchronization commands simply block overlapped execution of the command. Append the synchronization command to the overlapping command, for example:

```
SINGLE; *OPC?
```

For time consuming overlapped commands, you can allow the controller or the instrument to do other useful work while waiting for command execution. Use one of the following methods:

*OPC with a service request

1. Set the OPC mask bit (bit no. 0) in the ESE: *ESE 1
2. Set bit no. 5 in the SRE: *SRE 32 to enable ESB service request.
3. Send the overlapped command with *OPC .
4. Wait for a service request.

The service request indicates that the overlapped command has finished.

*OPC? with a service request

1. Set bit no. 4 in the SRE: *SRE 16 to enable MAV service request.
2. Send the overlapped command with *OPC?.
3. Wait for a service request.

The service request indicates that the overlapped command has finished.

Event status register (ESE)

1. Set the OPC mask bit (bit no. 0) in the ESE: *ESE 1
2. Send the overlapped command without *OPC, *OPC? or *WAI.

3. Poll the operation complete state periodically (with a timer) using the sequence:
*OPC; *ESR?

A return value (LSB) of 1 indicates that the overlapped command has finished.

A.1.4.2 Examples to Command Sequence and Synchronization

See the following examples to command sequences and synchronization. Some examples given illustrate possible constellations for overlapping tasks.

Example: Commands and queries in one message

The response to a query combined in a program message with commands that affect the queried value is not predictable.

The following commands always return the specified result:

```
:FREQ:STAR 1GHZ;SPAN 100 :FREQ:STAR?
```

Result:

```
1000000000 (1 GHz)
```

Whereas the result for the following commands is not specified by SCPI:

```
:FREQ:STAR 1GHz;STAR?;SPAN 1000000
```

The result could be the value of `START` before the command was sent since the instrument might defer executing the individual commands until a program message terminator is received. The result could also be 1 GHz if the instrument executes commands as they are received.

Example: Overlapping command with *OPC

The instrument implements `*RST` as an overlapped command. Assuming that `*RST` takes longer to execute than `*OPC`, sending the following command sequence results in initiating a reset and, after some time, setting the `OPC` bit in the `ESR`:

```
*RST; *OPC
```

Sending the following commands still initiates a reset:

```
*RST; *OPC; *CLS
```

However, since the operation is still pending when the instrument executes `*CLS`, forcing it into the "Operation Complete Command Idle" State (OCIS), `*OPC` is effectively skipped. The `OPC` bit is not set until the instrument executes another `*OPC` command.

Example: Overlapped command followed by non-conflicting commands

Suppose that the instrument is switched on to provide a real time test signal that requires some calculation time. At the same time, some settings for the configuration of a different signal are made which do not interact with the generated signal (for example the signal may be used later on). The signal generation and the signal configuration are independent from each other, so there is no need to synchronize the following overlapped commands:

```
SOUR:BB:3GPP:STAT ON
```

```
SOUR:BB:GSM:FORM FSK2
```

Example: Overlapped command followed by conflicting commands

Suppose that the generator is switched on to provide a real time test signal that requires some calculation time. This signal is to be added to a waveform from the second baseband generator. In this case, the application program has to make sure that the real signal is available in the added signal before further action is started. This involves an appropriate synchronization technique for the first command (the following sequence assumes an appropriate routing):

```
SOUR:BB:3GPP:STAT ON
```

The instrument waits until command has finished.

```
SOUR2:BB:GSM:STAT ON
```

Depending on the selected synchronization techniques, non-conflicting commands can be executed while waiting until the synchronized overlapped command has finished.

Example: Polling the progress of the zeroing process

Suppose that you start the zeroing for a connected power sensor via the remote control command `SENS1:ZERO`. This process blocks the processing of further tasks during execution. The query for completeness is performed with the `*OPC?` command. It returns a 1 in the output buffer when the process is completed.

```
SENS:ZERO;*OPC?
```

Instead of waiting via `*OPC?`, you can perform alternative tasks while the zeroing is running, as for example updating the GUI or adjusting other instruments. Synchronize the commands by querying the progress of the zeroing process periodically via the event status register `*ESR?`:

```
*SRE 32
```

Sets the service request enable. The bit is set when an event in the event status register occurs.

```
*ESE 1
```

Configures the mask of the event status register to "Operation Complete".

```
SENS:ZERO;*OPC
```

Sets the evaluation via the status byte query. It uses `*OPC?` as the reference.

```
*CLS
```

Clears all status registers.

Even if the instrument is busy, you can perform this procedure, since the query is executed in a subchannel.

A.1.5 Status Reporting System

The status reporting system stores all information on the current operating state of the instrument, and on errors which have occurred. This information is stored in the status registers and in the error queue.

You can query both with the commands of the [STATus Subsystem](#).

A.1.5.1 Hierarchy of the Status Registers

The [Figure A-1](#) shows the hierarchical structure of information in the status registers (ascending from left to right).

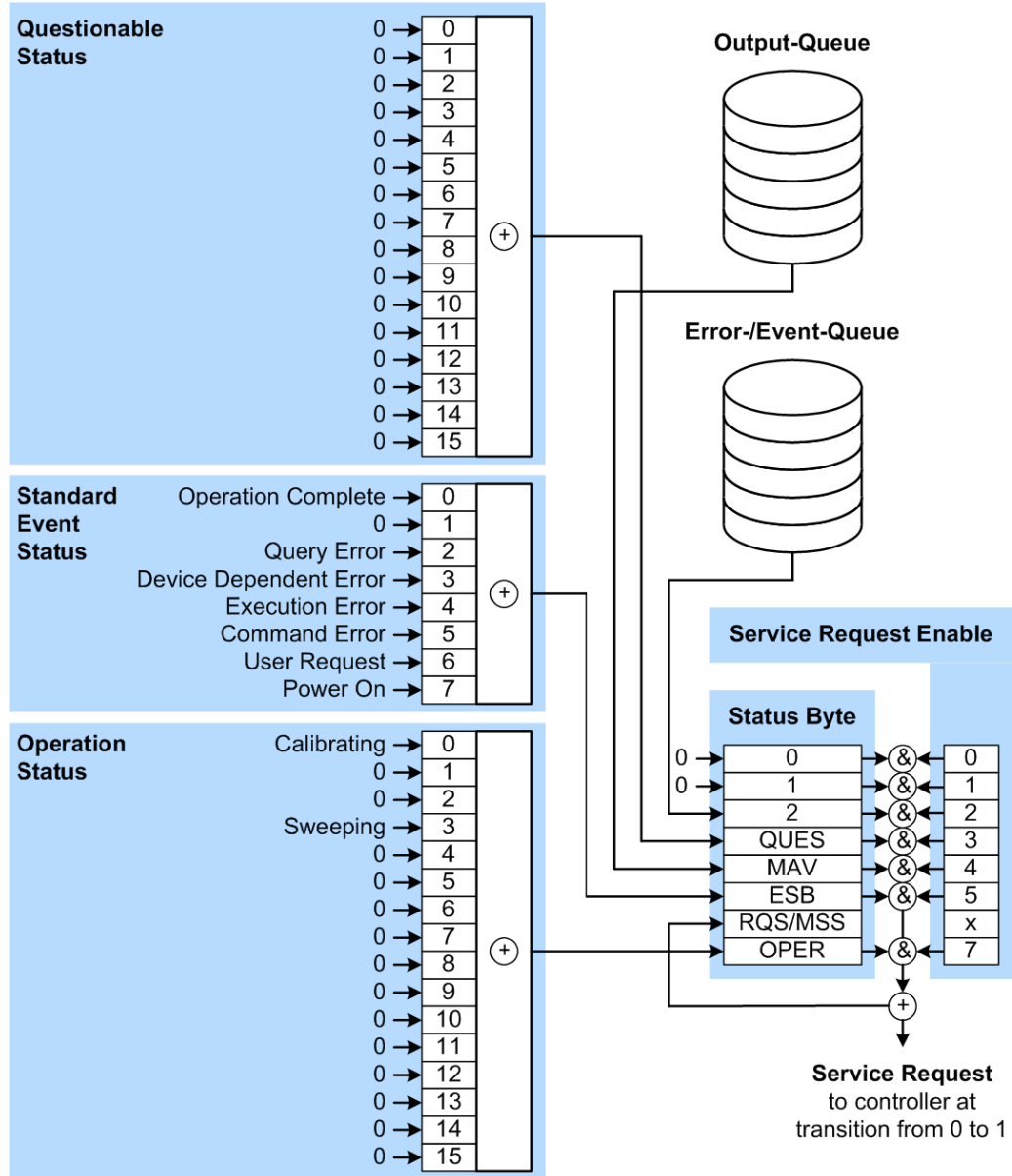

Figure A-1: Graphical overview of the status registers hierarchy

- OPER = Operation Status Summary Bit
- RQS/MSS = Service Request Generation
- ESB = Standard Event Status Summary Bit
- MAV = Message Available in Output Queue
- QUES = Questionable Status Summary Bit
- 2 = Error- /Event-Queue
- 1, 0 = not used

Note: This legend explains the abbreviations to the Status Byte Register.

The R&S SMB100B uses the following status registers:

- **Status Byte (STB)** and **Service Request Enable (SRE)**, see [Chapter A.1.5.3, "Status Byte \(STB\) and Service Request Enable Register \(SRE\)"](#), on page 571.
- **Standard Event Status**, i.e. the Event status Register (ESR) and the Event Status Enable (ESE), see [Chapter A.1.5.4, "Event Status Register \(ESR\) and Event Status Enable Register \(ESE\)"](#), on page 572.
- **Questionable Status** and **Operation Status**, the (SCPI status registers, see [Chapter A.1.5.2, "Structure of a SCPI Status Register"](#), on page 569, [Chapter A.1.5.5, "Questionable Status Register \(STATUS:QUESTIONable\)"](#), on page 573 and [Chapter A.1.5.6, "Operation Status Register \(STATUS:OPERation\)"](#), on page 573.
- **Output-Queue**
The output queue contains the messages the instrument returns to the controller. It is not part of the status reporting system but determines the value of the `MAV` bit in the `STB` and thus is represented in the overview.
- **Error- /Event-Queue**
The error-/event-queue contains all errors and events that have occurred in the past. When reading the queue, the instrument starts with the first occurred error/event.

All status registers have the same internal structure.



SRE, ESE

The service request enable register `SRE` can be used as `ENABLE` part of the `STB` if the `STB` is structured according to SCPI. By analogy, the `ESE` can be used as the `ENABLE` part of the `ESR`.

A.1.5.2 Structure of a SCPI Status Register

Each standard SCPI register consists of 5 parts. Each part has a width of 16 bits and has different functions. The individual bits are independent of each other, i.e. each hardware status is assigned a bit number which is valid for all five parts. Bit 15 (the most significant bit) is set to zero for all parts. Thus the contents of the register parts can be processed by the controller as positive integers.

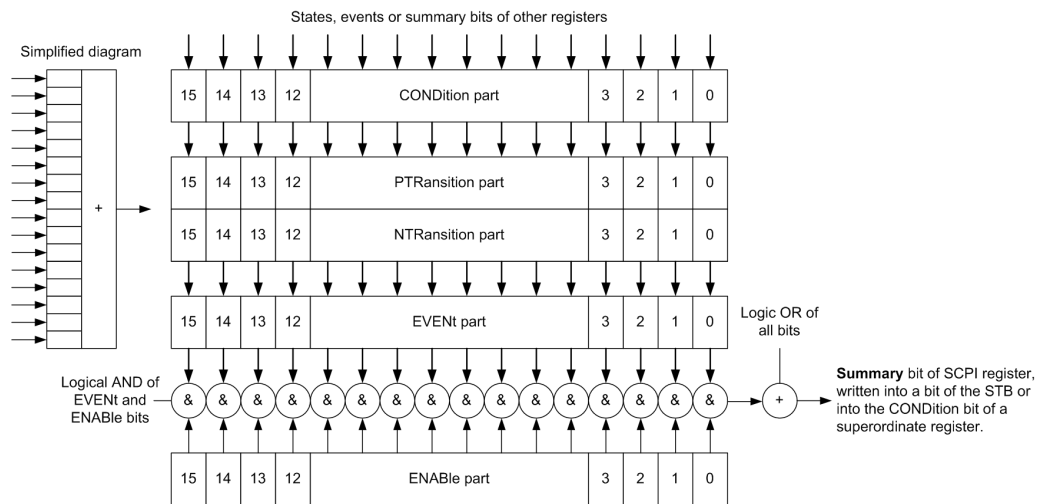

Figure A-2: The status-register model

Description of the five status register parts

The five parts of a SCPI register have different properties and functions:

- **CONDition**

The **CONDition** part is written into directly by the hardware or the sum bit of the next lower register. Its contents reflect the current instrument status. This register part can only be read, but not written into or cleared. Its contents are not affected by reading.

- **PTRansition / NTRansition**

The two transition register parts define which state transition of the **CONDition** part (none, 0 to 1, 1 to 0 or both) is stored in the **EVENT** part.

The **Positive-TRansition** part acts as a transition filter. When a bit of the **CONDition** part is changed from 0 to 1, the associated **PTR** bit decides whether the **EVENT** bit is set to 1.

- **PTR** bit =1: the **EVENT** bit is set.
- **PTR** bit =0: the **EVENT** bit is not set.

This part can be written into and read as required. Its contents are not affected by reading.

The **Negative-TRansition** part also acts as a transition filter. When a bit of the **CONDition** part is changed from 1 to 0, the associated **NTR** bit decides whether the **EVENT** bit is set to 1.

- **NTR** bit =1: the **EVENT** bit is set.
- **NTR** bit =0: the **EVENT** bit is not set.

This part can be written into and read as required. Its contents are not affected by reading.

- **EVENT**

The **EVENT** part indicates whether an event has occurred since the last reading, it is the "memory" of the condition part. It only indicates events passed on by the transition filters. It is permanently updated by the instrument. This part can only be

read by the user. Reading the register clears it. This part is often equated with the entire register.

- **ENABLE**

The `ENABLE` part determines whether the associated `EVENT` bit contributes to the sum bit (see below). Each bit of the `EVENT` part is "ANDed" with the associated `ENABLE` bit (symbol '&'). The results of all logical operations of this part are passed on to the sum bit via an "OR" function (symbol '+').

`ENABLE` bit = 0: the associated `EVENT` bit does not contribute to the sum bit

`ENABLE` bit = 1: if the associated `EVENT` bit is "1", the sum bit is set to "1" as well.

This part can be written into and read by the user as required. Its contents are not affected by reading.

Sum bit

The sum bit is obtained from the `EVENT` and `ENABLE` part for each register. The result is then entered into a bit of the `CONDition` part of the higher-order register.

The instrument automatically generates the sum bit for each register. Thus an event can lead to a service request throughout all levels of the hierarchy.

A.1.5.3 Status Byte (STB) and Service Request Enable Register (SRE)

The `Status Byte` (STB) is already defined in IEEE 488.2. It provides a rough overview of the instrument status by collecting the pieces of information of the lower registers. A special feature is that bit 6 acts as the sum bit of the remaining bits of the status byte.

The STB is read using the command `*STB?` or a serial poll.

The `Status Byte` (STB) is linked to the `Service Request Enable` (SRE) register. Each bit of the STB is assigned a bit in the SRE. Bit 6 of the SRE is ignored. If a bit is set in the SRE and the associated bit in the STB changes from 0 to 1, a service request (SRQ) is generated. The SRE can be set using the command `*SRE` and read using the command `*SRE?`.

Table A-5: Meaning of the bits used in the status byte

Bit No.	Meaning
0...1	Not used
2	Error Queue not empty The bit is set when an entry is made in the error queue. If this bit is enabled by the SRE, each entry of the error queue generates a service request. Thus an error can be recognized and specified in greater detail by polling the error queue. The poll provides an informative error message. This procedure is to be recommended since it considerably reduces the problems involved with remote control.
3	QUESTIONable status register summary bit The bit is set if an <code>EVENT</code> bit is set in the <code>QUESTIONable</code> status register and the associated <code>ENABLE</code> bit is set to 1. A set bit indicates a questionable instrument status, which can be specified in greater detail by querying the <code>STATUS:QUESTIONable</code> status register.

Bit No.	Meaning
4	MAV bit (message available) The bit is set if a message is available in the output queue which can be read. This bit can be used to enable data to be automatically read from the instrument to the controller.
5	ESB bit Sum bit of the event status register. It is set if one of the bits in the event status register is set and enabled in the event status enable register. Setting of this bit indicates a serious error which can be specified in greater detail by polling the event status register.
6	MSS bit (master status summary bit) The bit is set if the instrument triggers a service request. This is the case if one of the other bits of this registers is set together with its mask bit in the service request enable register SRE.
7	STATUS:OPERation status register summary bit The bit is set if an EVENT bit is set in the OPERATION status register and the associated ENABLE bit is set to 1. A set bit indicates that the instrument is just performing an action. The type of action can be determined by querying the STATUS:OPERation status register.

A.1.5.4 Event Status Register (ESR) and Event Status Enable Register (ESE)

The ESR is defined in IEEE 488.2. It can be compared with the EVENT part of a SCPI register. The event status register can be read out using command `*ESR?`.

The ESE corresponds to the ENABLE part of a SCPI register. If a bit is set in the ESE and the associated bit in the ESR changes from 0 to 1, the ESB bit in the STB is set. The ESE register can be set using the command `*ESE` and read using the command `*ESE?`.

Table A-6: Meaning of the bits used in the event status register

Bit No.	Meaning
0	Operation Complete This bit is set on receipt of the command <code>*OPC</code> exactly when all previous commands have been executed.
1	Not used
2	Query Error This bit is set if either the controller wants to read data from the instrument without having sent a query, or if it does not fetch requested data and sends new instructions to the instrument instead. The cause is often a query which is faulty and hence cannot be executed.
3	Device-dependent Error This bit is set if a device-dependent error occurs. An error message with a number between -300 and -399 or a positive error number, which denotes the error in greater detail, is entered into the error queue.
4	Execution Error This bit is set if a received command is syntactically correct but cannot be performed for other reasons. An error message with a number between -200 and -300, which denotes the error in greater detail, is entered into the error queue.

Bit No.	Meaning
5	Command Error This bit is set if a command is received, which is undefined or syntactically incorrect. An error message with a number between -100 and -200, which denotes the error in greater detail, is entered into the error queue.
6	User Request This bit is set when the instrument is switched over to manual control.
7	Power On (supply voltage on) This bit is set on switching on the instrument.

A.1.5.5 Questionable Status Register (STATus:QUESTionable)

This register contains information on questionable instrument states. Such states may occur when the instrument is not operated in compliance with its specifications.

To read the register, use the query commands `STAT:QUEST:COND?` or `STAT:QUEST[:EVEN]?`.

Table A-7: Meaning of the bits used in the questionable status register

Bit No.	Meaning
0–15	Not used

A.1.5.6 Operation Status Register (STATus:OPERation)

This condition part contains information on the actions currently being performed by the instrument, while the event part contains information on the actions performed by the instrument since the last readout of the register.

To read the register, use the query commands `STAT:OPER:COND?` or `STAT:OPER[:EVEN]?`.

Table A-8: Meaning of the bits used in the operation status register

Bit No.	Meaning
0	Calibrating The bit is set during the calibration phase.
1–2	Not used
3	Sweeping This bit is set during a sweep in automatic or single mode.
4–15	Not used

A.1.5.7 Application of the Status Reporting System

The purpose of the status reporting system is to monitor the status of one or several devices in a measuring system. To do this and react appropriately, the controller must

receive and evaluate the information of all devices. The following standard methods are used:

- **Service request** (SRQ) initiated by the instrument
- **Serial poll** of all devices in the bus system, initiated by the controller to find out who sent an SRQ and why
- Query of a **specific instrument status** by commands
- Query of the **error queue**

Service Request

Under certain circumstances, the instrument can send a service request (SRQ) to the controller. Usually this service request initiates an interrupt at the controller, to which the control program can react appropriately. An SRQ is always initiated if one or several of bits 2, 4 or 5 of the status byte are set and enabled in the SRE. Each of these bits combines the information of the error queue or the output buffer. To use the possibilities of the service request effectively, all bits should be set to "1" in the enable registers SRE and ESE.

Example:

Use command `*OPC` to generate an SRQ .

`*ESE 1` - set bit 0 of ESE (Operation Complete)

`*SRE 32` - set bit 5 of SRE (ESB).

After its settings have been completed, the instrument generates an SRQ.

The SRQ is the only possibility for the instrument to become active on its own. Each controller program should set the instrument such that a service request is initiated in the case of malfunction. The program should react appropriately to the service request.

Serial Poll

In a serial poll, just as with command `*STB`, the status byte of an instrument is queried. However, the query is realized via interface messages and is thus clearly faster.

The serial poll method is defined in IEEE 488.1 and used to be the only standard possibility for different instruments to poll the status byte. The method also works for instruments which do not adhere to SCPI or IEEE 488.2.

The serial poll is mainly used to obtain a fast overview of the state of several instruments connected to the controller.

Query of an instrument status

Each part of any status register can be read using queries. There are two types of commands:

- The common commands `*ESR?`, `*IDN?`, `*IST?`, `*STB?` query the higher-level registers.
- The commands of the `STATus` system query the SCPI registers (`STATus:QUEStionable...`)

The returned value is always a decimal number that represents the bit pattern of the queried register. This number is evaluated by the controller program.

Queries are usually used after an SRQ in order to obtain more detailed information on the cause of the SRQ.

Error Queue

Each error state in the instrument leads to an entry in the error queue. The entries of the error queue are detailed plain text error messages that can be looked up in the Error Log or queried via remote control using `SYSTem:ERRor[:NEXT]?`. Each call of `SYSTem:ERRor[:NEXT]?` provides one entry from the error queue. If no error messages are stored there any more, the instrument responds with 0, "No error".

The error queue should be queried after every SRQ in the controller program as the entries describe the cause of an error more precisely than the status registers. Especially in the test phase of a controller program the error queue should be queried regularly since faulty commands from the controller to the instrument are recorded there as well.

A.1.5.8 Reset Values of the Status Reporting System

The following table contains the different commands and events causing the status reporting system to be reset. None of the commands, except of `*RST` and `SYSTem:PRESet` affect the functional instrument settings. In particular, `DCL` does not change the instrument settings.

Table A-9: Resetting the status reporting system

Event	Switching on supply voltage Power-On-Status-Clear		DCL, SDC (Device Clear, Selected Device Clear)	*RST or SYSTem: PRESet	STATus: PRESet	*CLS
	0	1				
Clear STB, ESR	-	Yes	-	-	-	Yes
Clear SRE, ESE	-	Yes	-	-	-	-
Clear PPE	-	Yes	-	-	-	-
Clear error queue	Yes	Yes	-	-	-	Yes
Clear output buffer	Yes	Yes	Yes	1)	1)	1)
Clear command processing and input buffer	Yes	Yes	Yes	-	-	-

1) The first command in a command line that immediately follows a <PROGRAM MESSAGE TERMINATOR> clears the output buffer.

A.1.6 General Programming Recommendations

Initial instrument status before changing settings

Manual operation is designed for maximum possible operating convenience. In contrast, the priority of remote control is the "predictability" of the instrument status. Thus, when a command attempts to define incompatible settings, the command is ignored and the instrument status remains unchanged, i.e. other settings are not automatically adapted. Therefore, control programs should always define an initial instrument status (e.g. using the *RST command) and then implement the required settings.

Command sequence

As a general rule, send commands and queries in different program messages. Otherwise, the result of the query may vary depending on which operation is performed first (see also Preventing Overlapping Execution).

Reacting to malfunctions

The service request is the only possibility for the instrument to become active on its own. Each controller program should instruct the instrument to initiate a service request in case of malfunction. The program should react appropriately to the service request.

Error queues

The error queue should be queried after every service request in the controller program as the entries describe the cause of an error more precisely than the status registers. Especially in the test phase of a controller program the error queue should be queried regularly since faulty commands from the controller to the instrument are recorded there as well.

A.2 Telnet program examples

The following program example shows a simple `TcpClient` class that is intended to explain on how to get started with programming of sockets.

The example sets up a socket communication to R&S SMB100B and opens a simple user interface, very similar to the telnet, which allows input of commands. To enable real automation, further development of the program is required.

TcpClient.h

```
#include <string>
//defines structs for socket handling
#include <netinet/in.h>
using namespace std;
typedef struct sockaddr_in SockAddrStruct;
typedef struct hostent      HostInfoStruct;
```

```

class TcpClient
{
public:
    TcpClient();
    ~TcpClient();
    void connectToServer( string &hostname, int port );
    void disconnect( );
    void transmit( string &txString );
    void receive( string &rxString );
    string getCurrentHostName( ) const;
    int    getCurrentPort( ) const;
private:
    string      currentHostName;
    int         currentPort;
    int         currentSocketDescr;
    SockAddrStruct  serverAddress;
    HostInfoStruct * currentHostInfo;
    bool        clientIsConnected;
    int         receiveBufferSize;
};

```

TcpClient.cpp

```

#include <string>
//defines structs for socket handling
#include <netinet/in.h>
using namespace std;
typedef struct sockaddr_in SockAddrStruct;
typedef struct hostent     HostInfoStruct;
class TcpClient
{
public:
    TcpClient();
    ~TcpClient();
    void connectToServer( string &hostname, int port );
    void disconnect( );
    void transmit( string &txString );
    void receive( string &rxString );
    string getCurrentHostName( ) const;
    int    getCurrentPort( ) const;
private:
    string      currentHostName;
    int         currentPort;
    int         currentSocketDescr;
    SockAddrStruct  serverAddress;
    HostInfoStruct * currentHostInfo;
    bool        clientIsConnected;
    int         receiveBufferSize;
};

```

```

#include <netdb.h>
#include <netinet/in.h>
#include <unistd.h>
#include "TcpClient.h"
TcpClient::TcpClient()
: currentHostName( "" )
, currentPort( 0 )
, currentSocketDescr( 0 )
, serverAddress ( )
, currentHostInfo( NULL )
, clientIsConnected( false )
, receiveBufferSize( 1024 )
{
}
TcpClient::~~TcpClient()
{
    currentHostInfo = NULL;
}

void TcpClient::connectToServer( string &hostname, int port )
{
    currentHostInfo = gethostbyname( hostname.c_str( ) );
    if( currentHostInfo == NULL )
    {
        currentHostName = "";
        currentPort = 0;
        currentHostInfo = NULL;
        clientIsConnected = false;
        printf("error connecting host\n" );
    }
    currentHostName = hostname;
    currentPort = port;
    currentSocketDescr = socket(AF_INET, SOCK_STREAM, 0);
    if( currentSocketDescr == 0 )
    {
        currentHostName = "";
        currentPort = 0;
        currentHostInfo = NULL;
        clientIsConnected = false;
        printf("can't create socket\n" );
    }
    serverAddress.sin_family = currentHostInfo->h_addrtype;
    serverAddress.sin_port = htons( currentPort );
    memcpy( (char *) &serverAddress.sin_addr.s_addr,
        currentHostInfo->h_addr_list[0], currentHostInfo->h_length );
    if( connect( currentSocketDescr, ( struct sockaddr *) &serverAddress,
        sizeof( serverAddress ) ) < 0 )
    {
        throw string("can't connect server\n" );
    }
}

```

```

        clientIsConnected = true;
    }
void TcpClient::disconnect( )
{
    if( clientIsConnected )
    {
        close( currentSocketDescr );
    }
    currentSocketDescr = 0;
    currentHostName    = "";
    currentPort        = 0;
    currentHostInfo    = NULL;
    clientIsConnected  = false;
}
void TcpClient::transmit( string &txString )
{
    if( !clientIsConnected )
    {
        throw string("connection must be established before any data can be sent\n");
    }
    char * transmitBuffer = new char[txString.length() +1];
    memcpy( transmitBuffer, txString.c_str(), txString.length() );
    transmitBuffer[txString.length()] = '\n'; //newline is needed!
    if( send( currentSocketDescr, transmitBuffer, txString.length() + 1, 0 ) < 0 )
    {
        throw string("can't transmit data\n");
    }
    delete [] transmitBuffer;
}
void TcpClient::receive( string &rxString )
{
    if( !clientIsConnected )
    {
        throw string("connection must be established before any data can be received\n");
    }
    char * receiveBuffer = new char[receiveBufferSize];
    memset( receiveBuffer, 0, receiveBufferSize );
    bool receiving = true;
    while( receiving )
    {
        int receivedByteCount = recv( currentSocketDescr,
            receiveBuffer, receiveBufferSize, 0 );
        if( receivedByteCount < 0 )
        {
            throw string("error while receiving data\n");
        }
        rxString += string( receiveBuffer );
        receiving = ( receivedByteCount == receiveBufferSize );
    }
    delete [] receiveBuffer;
}

```

```

}
string TcpClient::getCurrentHostName( ) const
{
    return currentHostName;
}
int TcpClient::getCurrentPort( ) const
{
    return currentPort;
}

```

TelnetClient.cpp

```

#include <iostream>
#include "TcpClient.h"
void printUsage()
{
    cout<<"usage: EthernetRawCommand <server-ip> [scpi-command]"<<endl;
}
int main( int argc, char *argv[] )
{
    int errorCode          = 0; //no error
    bool useSingleCommand = false;
    string singleCommand  = "";
    string hostname       = "";
    int    port           = 5025;
    string input          = "";
    TcpClient client;
    switch( argc )
    {
        case 3:
            useSingleCommand = true;
            singleCommand    = argv[2];
        case 2:
            hostname         = argv[1];
            break;
        default:
            printUsage();
            return(-1);
    }
    try
    {
        client.connectToServer( hostname, port );
        bool terminate = false;
        while( !terminate )
        {
            char buffer[1024];
            if( useSingleCommand )
            {
                input = singleCommand; //send string
            }

```



```

else
{
    cin.getline( buffer, 1024 );
    input = buffer;
    if( input == "end" )
    {
        terminate = true;
    }
}
if( !terminate)
{
    client.transmit( input ); //send string
    int qPos = input.find( "?", 0 );
    //receive string only when needed
    if( qPos > 0 )
    {
        string rcStr = "";
        client.receive( rcStr );
        cout << rcStr << endl;
    }
}
if( useSingleCommand )
{
    terminate = true;
}
}
}catch( const string errorString )
{
    cout<<errorString<<endl;
}
client.disconnect( );
return errorCode;
}

```

A.3 Extensions for User Files

The [Table A-10](#) lists all available file extensions for user files. The currently available files on the instrument depend on the installed options.

Table A-10: List of the automatically assigned file extensions in the instrument

Function	List type	Contents	File suffix
Instrument State	Settings	Instrument settings	*.savrcltxt
User Menu	Settings	User-defined favorite settings	*.user_menu
License Key		License Key	*.xml
"User Correction"	List	User-defined level correction values	*.uco
"List Mode"	List	User-defined frequency/level value pairs	*.lsw

Function	List type	Contents	File suffix
	Settings	Response file	*.txt
"Pulse Train"	Settings	Pulse train data	*.pulstrn
"NRP Settings"	Settings	R&S NRP Settings	*.nrp, *.rsu
SCPI command list	List	Export file containing list of SCPIs	*.iec
SCPI command script		SCPI script file formats: Plain SCPI, MATLAB, NICVI, Python3	*.txt , *.m, *.c, *.py
R&S Support Info Archive	Support File	Automatically collected support information	*.tar.gz
Tutorials	Tutorial files	Lists containing SCPIs and explanations	*.tut

B Hardware Interfaces

This section covers hardware-related topics, like pin assignment of the IEC 625/IEEE 488 interface.

The remote control interfaces are described in details in [Chapter 11, "Network Operation and Remote Control"](#), on page 257.

All other interfaces are described in [Chapter 3.2, "Instrument Tour"](#), on page 31.

For specifications, refer to the data sheet.

B.1 GPIB-Bus Interface

Option: R&S SMBB-B86.

Pin assignment

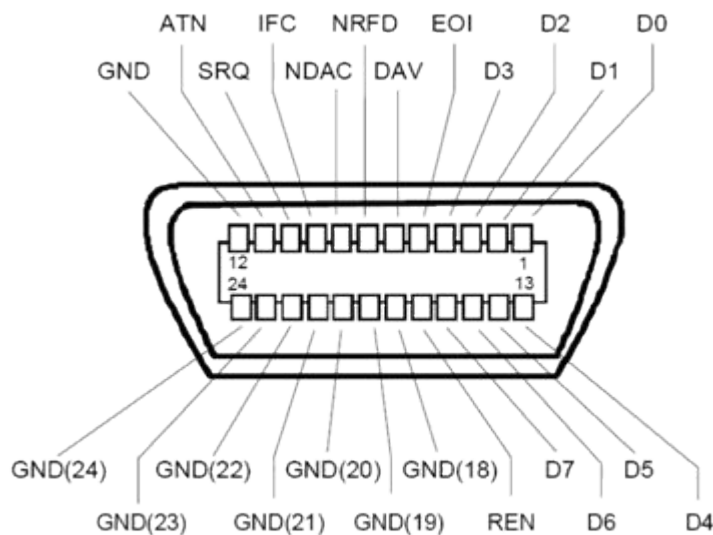

Figure B-1: Pin assignment of GPIB-bus (IEEE 488) interface

Bus lines

- Data bus with 8 lines D0 to D7:
The transmission is bit-parallel and byte-serial in the ASCII/ISO code. D0 is the least significant bit, D7 the most significant bit.
- Control bus with five lines:
IFC (Interface Clear): active LOW resets the interfaces of the instruments connected to the default setting.
ATN (Attention): active LOW signals the transmission of interface messages, inactive HIGH signals the transmission of device messages.

SRQ (Service Request): active LOW enables the connected device to send a service request to the controller.

REN (Remote Enable): active LOW permits switchover to remote control.

EOI (End or Identify): has two functions in connection with ATN:

- ATN=HIGH active LOW marks the end of data transmission.
- ATN=LOW active LOW triggers a parallel poll.

- Handshake bus with three lines:

DAV (Data Valid): active LOW signals a valid data byte on the data bus.

NRFD (Not Ready For Data): active LOW signals that one of the connected devices is not ready for data transfer.

NDAC (Not Data Accepted): active LOW signals that the instrument connected is accepting the data on the data bus.

Interface functions

Instruments which can be controlled via GPIB-bus interface can be equipped with different interface functions. [Table B-1](#) lists the interface functions for the R&S SMB100B.

Table B-1: GPIB-bus interface functions

Control character	Interface function
SH1	Handshake source function (source handshake), full capability
AH1	Handshake sink function (acceptor handshake), full capability
L4	Listener function, full capability, de-addressed by MTA.
T6	Talker function, full capability, ability to respond to serial poll, deaddressed by MLA
SR1	Service request function (Service Request), full capability
PP1	Parallel poll function, full capability
RL1	Remote/Local switch over function, full capability
DC1	Reset function (Device Clear), full capability
DT1	Trigger function (Device Trigger), full capability

Glossary: List of the Often Used Terms and Abbreviations

A

Absolute file path: [Complete file path](#)

B

Base unit: This term describes a R&S SMB100B equipped with the option R&S SMBB-B103.

C

Clock: A mandatory internal or an external reference clock signal for generating the timing pulse in the instrument.

Complete file path: The complete file path specifies the root directory and all subdirectories that contain a file or folder.

See also [Chapter 12.5.2, "Accessing Files in the Default or in a Specified Directory"](#), on page 329.

Computer name: An unambiguous indication of the instrument in a LAN that uses a [DNS](#) server.

The default computer name follows the syntax `SMB100B-<serial number>`, e.g. `SMB100B-102030`.

Synonym: [Hostname](#)

See [Serial number](#).

D

daisy chain: A connection scheme in which instruments are connected together in sequence, i.e. an output of the first one is connected to an input of the second one, etc.

DHCP: Dynamic host configuration protocol

DNS: Domain name system server

E

e.g.: For example

External mass memory: External memory, connected to the instrument via USB connector (Type A female). It can hold stored files with user data.

See also [System drive](#)

F

File transfer: The transmission of files from or to the instrument by a remote client. The instrument supports the standard methods [FTP](#) and file sharing according to [SAMBA/SMB](#).

FTP: File transfer protocol

Full file path: [Complete file path](#)

G

Glossary: List of the often used terms and abbreviations

GUI: Graphical user interface

H

Hostname: [Computer name](#)

I

i.e.: That is

L

LF: Low frequency

LSB: Least significant bit

M

MIMO: Multiple input multiple outputs

MSB: Most significant bit

N

NTP: Network Time Protocol synchronizes all connected instruments and computer systems to minimize time delays in the network.

P

PC: Personal computer

Power: A term describing the signal level of the RF signal

product page: A designation of the R&S SMB100B product page <http://www.rohde-schwarz.com/product/SMA100B.html>

R

Remote access: [Remote operation](#)

Remote control: The operation of the R&S SMB100B by remote control commands or programs to perform automated tests.

The instrument is connected to a system controller via LAN/VXI-11, GPIB or USB using [VISA](#). The instrument is controlled directly or supported by instrument drivers.

Remote device: External device controls the R&S SMB100B in remote operation mode, see [Remote operation](#).

Synonyms: External controller, client device

Remote operation: Allows you to operate the R&S SMB100B from a remote device via VNC.

Both the R&S SMB100B and the remote device are connected in a LAN.

Synonym: Remote access

Removable memory: General term describing mass memory that can be unmounted from the instrument.

RF: Radio frequency

S

SAMBA/SMB: Server message protocol

Serial number: Unique instrument identification, provided on the rear panel of the instrument and required to build the [Computer name](#).

The serial number are the last 6 digits in the string <stock no.>-<serial number>, e.g. SMB100B-102030

Smart device: A mobile, cordless device, such as a smartphone or tablet, capable of Internet browsing.

Synonyms: Smartphone, tablet

System drive: The system drive is a built-in internal memory that holds the operating system, the firmware, and the stored user data.

Throughout this description, the system drive is referred as an internal memory.

See also [Removable memory](#)

T

Trigger: Internally generated or externally supplied signal which starts signal generation at a particular point in time.

Trigger event: A trigger event is caused by the received trigger signal or executed manual trigger.

U

UE: User equipment

USBTMC: (USB test & measurement class)

A protocol built on top of USB for communication with USB devices. Using [VISA](#) library, it supports service request, triggers, and other specific operations, similar to GPIB.

User directory: Describes the default file storage location for user data.

Depending on the installed options, the user directory is physically located on the [System drive](#) or on the [Removable memory](#)

In the file system, user directory is always indicated as `/var/user`

V

VISA: Virtual instrument software architecture

List of Commands

:CALibration:ALL[:MEASure]?	338
:CALibration:DATA:FACTory:DATE?	339
:CALibration<hw>:ALL:DATE?	338
:CALibration<hw>:ALL:INformation?	338
:CALibration<hw>:ALL:TEMP?	339
:CALibration<hw>:ALL:TIME?	339
:CALibration<hw>:CONTInueonerror	340
:DEvice:PRESet	326
:DIAGnostic:INFO:OTIME?	342
:DIAGnostic:INFO:POCount?	342
:DIAGnostic<hw>:BGInfo:CATalog?	341
:DIAGnostic<hw>:BGInfo?	341
:DIAGnostic<hw>:POINT:CATalog?	343
:DIAGnostic<hw>[:MEASure]:POINT?	343
:DISPlay:ANNotation:AMPLitude	346
:DISPlay:ANNotation:FREQuency	346
:DISPlay:ANNotation[:ALL]	346
:DISPlay:BRIGhtness	345
:DISPlay:BUtTon:BRIGhtness	345
:DISPlay:DIALog:CLOSe	347
:DISPlay:DIALog:CLOSe:ALL	348
:DISPlay:DIALog:ID?	346
:DISPlay:DIALog:OPEN	347
:DISPlay:PSAVe:HOLDoff	344
:DISPlay:PSAVe[:STATe]	345
:DISPlay:UPDate	345
:FORMat:BORDER	348
:FORMat:SREGister	349
:FORMat[:DATA]	349
:HCOPY:DATA?	351
:HCOPY:DEvice:LANGuage	351
:HCOPY:FILE[:NAME]	351
:HCOPY:FILE[:NAME]:AUTO:DIRectory	352
:HCOPY:FILE[:NAME]:AUTO:DIRectory:CLEar	353
:HCOPY:FILE[:NAME]:AUTO:FILE?	353
:HCOPY:FILE[:NAME]:AUTO:STATe	353
:HCOPY:FILE[:NAME]:AUTO?	352
:HCOPY:FILE[:NAME]:AUTO[:FILE]:DAY:STATe	353
:HCOPY:FILE[:NAME]:AUTO[:FILE]:MONTh:STATe	353
:HCOPY:FILE[:NAME]:AUTO[:FILE]:NUMBer?	354
:HCOPY:FILE[:NAME]:AUTO[:FILE]:PREFix	354
:HCOPY:FILE[:NAME]:AUTO[:FILE]:PREFix:STATe	354
:HCOPY:FILE[:NAME]:AUTO[:FILE]:YEAR:STATe	353
:HCOPY:IMAGe:FORMat	351
:HCOPY:REGion	351
:HCOPY[:EXECute]	352
:INITiate<hw>[:POWER]:CONTInuous	362

:KBOard:LAYout.....	355
:MEMory:HFRee?.....	337
:MMEMory:CATalog:LENGth?.....	333
:MMEMory:CATalog?.....	332
:MMEMory:CDIRectory.....	333
:MMEMory:COPIY.....	333
:MMEMory:DATA.....	334
:MMEMory:DCATalog:LENGth?.....	335
:MMEMory:DCATalog?.....	334
:MMEMory:DELeTe.....	335
:MMEMory:LOAD:STATe.....	335
:MMEMory:MDIRectory.....	336
:MMEMory:MOVE.....	336
:MMEMory:MSIS.....	336
:MMEMory:RDIRectory.....	336
:MMEMory:STORe:STATe.....	337
:OUTPut:ALL[:STATe].....	355
:OUTPut<hw>:AFIXed:RANGe:LOWer?.....	357
:OUTPut<hw>:AFIXed:RANGe:UPPer?.....	357
:OUTPut<hw>:AMode.....	356
:OUTPut<hw>:IMPedance?.....	356
:OUTPut<hw>:PROTection:CLear.....	357
:OUTPut<hw>:PROTection:TRIPped?.....	357
:OUTPut<hw>[:STATe].....	356
:OUTPut<hw>[:STATe]:PON.....	356
:READ<ch>[:POWer]?.....	362
:SENSe<ch>:UNIT[:POWer].....	363
:SENSe<ch>[:POWer]:APERture:DEFault:STATe.....	363
:SENSe<ch>[:POWer]:APERture:TIME.....	364
:SENSe<ch>[:POWer]:CORRection:SPDevice:LIST?.....	365
:SENSe<ch>[:POWer]:CORRection:SPDevice:SElect.....	364
:SENSe<ch>[:POWer]:CORRection:SPDevice:STATe.....	364
:SENSe<ch>[:POWer]:DISPlay:PERManent:STATe.....	365
:SENSe<ch>[:POWer]:FILTer:LENGth:AUTO?.....	365
:SENSe<ch>[:POWer]:FILTer:LENGth[:USER].....	365
:SENSe<ch>[:POWer]:FILTer:NSRatio.....	366
:SENSe<ch>[:POWer]:FILTer:NSRatio:MTIME.....	366
:SENSe<ch>[:POWer]:FILTer:SONCe.....	367
:SENSe<ch>[:POWer]:FILTer:TYPE.....	367
:SENSe<ch>[:POWer]:FREQuency.....	368
:SENSe<ch>[:POWer]:LOGGing:STATe.....	368
:SENSe<ch>[:POWer]:OFFSet.....	368
:SENSe<ch>[:POWer]:OFFSet:STATe.....	368
:SENSe<ch>[:POWer]:SNUMber?.....	369
:SENSe<ch>[:POWer]:SOURce.....	369
:SENSe<ch>[:POWer]:STATus[:DEVice]?.....	369
:SENSe<ch>[:POWer]:TYPE?.....	370
:SENSe<ch>[:POWer]:ZERO.....	370
:SLISt:ELEMent<ch>:MAPPING.....	361
:SLISt:SCAN[:STATe].....	361

:SLIST:SENSor:MAP.....	362
:SLIST[:LIST]?.....	361
:SOURce<hw>:PRESet.....	326
:STATus:OPERation:CONDition?.....	500
:STATus:OPERation:ENABle.....	500
:STATus:OPERation:NTRansition.....	501
:STATus:OPERation:PTRansition.....	501
:STATus:OPERation[:EVENT].....	501
:STATus:PRESet.....	501
:STATus:QUEStionable:CONDition.....	502
:STATus:QUEStionable:ENABle.....	502
:STATus:QUEStionable:NTRansition.....	502
:STATus:QUEStionable:PTRansition.....	503
:STATus:QUEStionable[:EVENT].....	502
:STATus:QUEue[:NEXT]?.....	503
:SYSTem:BIOS:VERsion?.....	497
:SYSTem:COMMunicate:GPIB:LTERminator.....	484
:SYSTem:COMMunicate:GPIB:RESource?.....	485
:SYSTem:COMMunicate:GPIB[:SELF]:ADDResS.....	485
:SYSTem:COMMunicate:HISLip:RESource?.....	485
:SYSTem:COMMunicate:NETWork:IPADdress.....	485
:SYSTem:COMMunicate:NETWork:IPADdress:MODE.....	486
:SYSTem:COMMunicate:NETWork:MACAddress.....	486
:SYSTem:COMMunicate:NETWork:RESource?.....	486
:SYSTem:COMMunicate:NETWork:REStart.....	487
:SYSTem:COMMunicate:NETWork:STATus?.....	487
:SYSTem:COMMunicate:NETWork[:COMMON]:DOMain.....	487
:SYSTem:COMMunicate:NETWork[:COMMON]:HOSTname.....	487
:SYSTem:COMMunicate:NETWork[:COMMON]:WORKgrouP.....	488
:SYSTem:COMMunicate:NETWork[:IPADdress]:DNS.....	488
:SYSTem:COMMunicate:NETWork[:IPADdress]:GATeway.....	488
:SYSTem:COMMunicate:NETWork[:IPADdress]:SUBNet:MASK.....	488
:SYSTem:COMMunicate:SERial:BAUD.....	488
:SYSTem:COMMunicate:SERial:PARity.....	489
:SYSTem:COMMunicate:SERial:RESource?.....	489
:SYSTem:COMMunicate:SERial:SBITs.....	489
:SYSTem:COMMunicate:SOCKet:RESource?.....	489
:SYSTem:COMMunicate:USB:RESource?.....	490
:SYSTem:DATE.....	495
:SYSTem:DFPR?.....	498
:SYSTem:DLOCK.....	481
:SYSTem:ERRor:ALL?.....	478
:SYSTem:ERRor:CODE:ALL?.....	478
:SYSTem:ERRor:CODE[:NEXT]?.....	479
:SYSTem:ERRor:COUNT?.....	479
:SYSTem:ERRor:GNEXt?.....	480
:SYSTem:ERRor:HISTory:CLEar.....	480
:SYSTem:ERRor:STATic?.....	480
:SYSTem:ERRor[:NEXT]?.....	479
:SYSTem:FILEs:TEMPorary:DELeTe.....	499

:SYSTem:FPReset.....	327
:SYSTem:HELP:EXPort.....	490
:SYSTem:IDENtification.....	490
:SYSTem:IDENtification:PRESet.....	491
:SYSTem:INFormaTion:SCPI.....	492
:SYSTem:IRESpOse.....	491
:SYSTem:KLOCK.....	481
:SYSTem:LANGUage.....	492
:SYSTem:LOCK:OWNer?.....	482
:SYSTem:LOCK:RELease:ALL.....	482
:SYSTem:LOCK:REQUest[:EXCLusive]?.....	483
:SYSTem:MMEMory:PATH:USER?.....	498
:SYSTem:NINFormaTion?.....	481
:SYSTem:NTP:HOSTname.....	496
:SYSTem:NTP:STATe.....	496
:SYSTem:ORESpOse.....	491
:SYSTem:OSYStem?.....	498
:SYSTem:PRESet.....	327
:SYSTem:PROTect<ch>[:STATe].....	483
:SYSTem:RCL.....	483
:SYSTem:REBoot.....	499
:SYSTem:REStart.....	499
:SYSTem:SAV.....	483
:SYSTem:SECurity:SANitize[:STATe].....	492
:SYSTem:SECurity:SUPolicy.....	492
:SYSTem:SECurity:VOLMode[:STATe].....	484
:SYSTem:SHUTdown.....	499
:SYSTem:SPECification:IDENtification:CATalog?.....	494
:SYSTem:SPECification:PARAmeter?.....	494
:SYSTem:SPECification:VERSion.....	493
:SYSTem:SPECification:VERSion:CATalog?.....	494
:SYSTem:SPECification:VERSion:FACTory?.....	495
:SYSTem:SPECification?.....	492
:SYSTem:SRData?.....	495
:SYSTem:STARtup:COMPLete?.....	495
:SYSTem:TIME.....	496
:SYSTem:TIME:ZONE.....	497
:SYSTem:TIME:ZONE:CATalog?.....	497
:SYSTem:ULOCK.....	482
:SYSTem:UPTime?.....	497
:SYSTem:VERSion?.....	498
:SYSTem:WAIT.....	499
:TEST<hw>:ALL:RESult?.....	504
:TEST<hw>:ALL:STARt.....	504
:TRIGger<hw>:FPSWeep:SOURce.....	506
:TRIGger<hw>:FSWeep:SOURce.....	505
:TRIGger<hw>:FSWeep[:IMMediate].....	507
:TRIGger<hw>:LFFSweep.....	507
:TRIGger<hw>:LFFSweep:IMMediate.....	507
:TRIGger<hw>:LFFSweep:SOURce.....	505

:TRIGger<hw>:PSWeep:SOURce.....	505
:TRIGger<hw>:PSWeep[:IMMediate].....	507
:TRIGger<hw>[:SWEep]:SOURce.....	505
:TRIGger<hw>[:SWEep][:IMMediate].....	507
:UNIT:ANGLE.....	508
:UNIT:POWer.....	508
[:SOURce]:CORRection:CSET:CATalog?.....	409
[:SOURce]:CORRection:CSET:DELeTe.....	410
[:SOURce]:INPut:TRIGger:SLOPe.....	419
[:SOURce]:LFOutput:OFFSet.....	425
[:SOURce]:LFOutput:SIMPedance.....	425
[:SOURce]:LFOutput:VOLTagE.....	426
[:SOURce]:LFOutput<ch>:BANDwidth?.....	422
[:SOURce]:LFOutput<ch>:FREQuency.....	422
[:SOURce]:LFOutput<ch>:INTernal:VOLTagE.....	424
[:SOURce]:LFOutput<ch>:SOURce.....	425
[:SOURce]:LFOutput<ch>:SOURce:PATH.....	426
[:SOURce]:LFOutput<ch>[:STATe].....	424
[:SOURce]:PM<ch>[:DEViation].....	385
[:SOURce]:POWer:WIGNore.....	458
[:SOURce]:PULM[:INTernal][:TRAin]:TRIGger:IMMediate.....	388
[:SOURce]:ROSCillator:EXTernal:FREQuency.....	460
[:SOURce]:ROSCillator:EXTernal:FREQuency:VARiable.....	460
[:SOURce]:ROSCillator:EXTernal:MLRange?.....	461
[:SOURce]:ROSCillator:EXTernal:NSBandwidth?.....	462
[:SOURce]:ROSCillator:EXTernal:RFOF[:STATe].....	460
[:SOURce]:ROSCillator:EXTernal:SBANDwidth.....	461
[:SOURce]:ROSCillator:OUTPut:ALTerate:FREQuency:MODE.....	462
[:SOURce]:ROSCillator:OUTPut:FREQuency:MODE.....	462
[:SOURce]:ROSCillator:PRESet.....	460
[:SOURce]:ROSCillator:SOURce.....	460
[:SOURce]:ROSCillator[:INTernal]:ADJust:VALue.....	463
[:SOURce]:ROSCillator[:INTernal]:ADJust[:STATe].....	463
[:SOURce]:STEReo:ARI:BK[:CODE].....	403
[:SOURce]:STEReo:ARI:STATe.....	402
[:SOURce]:STEReo:ARI:TYPE.....	402
[:SOURce]:STEReo:ARI:TYPE:STATe.....	402
[:SOURce]:STEReo:ARI[:DEViation].....	402
[:SOURce]:STEReo:AUDio:MODE.....	399
[:SOURce]:STEReo:AUDio:PREEmphasis.....	400
[:SOURce]:STEReo:AUDio:PREEmphasis:STATe.....	401
[:SOURce]:STEReo:DIRect.....	398
[:SOURce]:STEReo:EXTernal:IMPedance.....	400
[:SOURce]:STEReo:MMF.....	400
[:SOURce]:STEReo:PILot:PHASe.....	401
[:SOURce]:STEReo:PILot:STATe.....	401
[:SOURce]:STEReo:PILot[:DEViation].....	401
[:SOURce]:STEReo:RDS:DATaset.....	404
[:SOURce]:STEReo:RDS:STATe.....	403
[:SOURce]:STEReo:RDS:TRAFfic:ANNouncement[:STATe].....	404

[[:SOURce]:STEReo:RDS:TRAFfic:PROGram[:STATe].....	404
[[:SOURce]:STEReo:RDS[:DEViation].....	403
[[:SOURce]:STEReo:SOURce.....	399
[[:SOURce]:STEReo:STATe.....	398
[[:SOURce]:STEReo[:DEViation].....	398
[[:SOURce<hw>]:AM:DEPTTh:SUM.....	375
[[:SOURce<hw>]:AM:DEViation:MODE.....	375
[[:SOURce<hw>]:AM:RATio.....	376
[[:SOURce<hw>]:AM<ch>:SENSitivity.....	376
[[:SOURce<hw>]:AM<ch>:SOURce.....	374
[[:SOURce<hw>]:AM<ch>:STATe.....	374
[[:SOURce<hw>]:AM<ch>[:DEPTTh].....	375
[[:SOURce<hw>]:COMBined:FREQuency:START.....	471
[[:SOURce<hw>]:COMBined:FREQuency:STOP.....	472
[[:SOURce<hw>]:COMBined:POWer:START.....	472
[[:SOURce<hw>]:COMBined:POWer:STOP.....	472
[[:SOURce<hw>]:CORRection:CSET:DATA:FREQuency.....	407
[[:SOURce<hw>]:CORRection:CSET:DATA:FREQuency:POINts?.....	408
[[:SOURce<hw>]:CORRection:CSET:DATA:POWer.....	407
[[:SOURce<hw>]:CORRection:CSET:DATA:POWer:POINts?.....	408
[[:SOURce<hw>]:CORRection:CSET:DATA[:SENSor<ch>][:POWer]:SONCe.....	408
[[:SOURce<hw>]:CORRection:CSET:DATA[:SENSor<ch>][:POWer]:SONCe.....	409
[[:SOURce<hw>]:CORRection:CSET[:SELEct].....	408
[[:SOURce<hw>]:CORRection:DEXChange:AFILe:CATalog?.....	410
[[:SOURce<hw>]:CORRection:DEXChange:AFILe:EXTension.....	410
[[:SOURce<hw>]:CORRection:DEXChange:AFILe:SELEct.....	411
[[:SOURce<hw>]:CORRection:DEXChange:AFILe:SEParator:COLumn.....	411
[[:SOURce<hw>]:CORRection:DEXChange:AFILe:SEParator:DECimal.....	411
[[:SOURce<hw>]:CORRection:DEXChange:EXECute.....	411
[[:SOURce<hw>]:CORRection:DEXChange:MODE.....	412
[[:SOURce<hw>]:CORRection:DEXChange:SELEct.....	412
[[:SOURce<hw>]:CORRection:VALue?.....	408
[[:SOURce<hw>]:CORRection:ZERoing:STATe.....	409
[[:SOURce<hw>]:CORRection[:STATe].....	409
[[:SOURce<hw>]:FM:DEViation:MODE.....	380
[[:SOURce<hw>]:FM:DEViation:SUM.....	380
[[:SOURce<hw>]:FM:MODE.....	381
[[:SOURce<hw>]:FM:RATio.....	380
[[:SOURce<hw>]:FM:SENSitivity?.....	381
[[:SOURce<hw>]:FM<ch>:SOURce.....	379
[[:SOURce<hw>]:FM<ch>:STATe.....	378
[[:SOURce<hw>]:FM<ch>[:DEViation].....	379
[[:SOURce<hw>]:FREQuency:CENTer.....	416
[[:SOURce<hw>]:FREQuency:MANual.....	415
[[:SOURce<hw>]:FREQuency:MODE.....	413
[[:SOURce<hw>]:FREQuency:MUlTiplier.....	415
[[:SOURce<hw>]:FREQuency:OFFSet.....	415
[[:SOURce<hw>]:FREQuency:SPAN.....	416
[[:SOURce<hw>]:FREQuency:START.....	417
[[:SOURce<hw>]:FREQuency:STEP:MODE.....	417

[:SOURce<hw>]:FREQuency:STEP[:INCRement]	418
[:SOURce<hw>]:FREQuency:STOP	417
[:SOURce<hw>]:FREQuency[:CW FIXed]	414
[:SOURce<hw>]:FREQuency[:CW FIXed]:RCL	414
[:SOURce<hw>]:INPut:MODext:COUPling	418
[:SOURce<hw>]:INPut:MODext:IMPedance<ch>	419
[:SOURce<hw>]:LFOutput:FREQuency:MANual	423
[:SOURce<hw>]:LFOutput:FREQuency:MODE	423
[:SOURce<hw>]:LFOutput:FREQuency:START	424
[:SOURce<hw>]:LFOutput:FREQuency:STOP	424
[:SOURce<hw>]:LFOutput:SWEep[:FREQuency]:DWELl	429
[:SOURce<hw>]:LFOutput:SWEep[:FREQuency]:EXECute	429
[:SOURce<hw>]:LFOutput:SWEep[:FREQuency]:MODE	430
[:SOURce<hw>]:LFOutput:SWEep[:FREQuency]:POINts	430
[:SOURce<hw>]:LFOutput:SWEep[:FREQuency]:RETRace	430
[:SOURce<hw>]:LFOutput:SWEep[:FREQuency]:RUNNing?	431
[:SOURce<hw>]:LFOutput:SWEep[:FREQuency]:SHAPE	431
[:SOURce<hw>]:LFOutput:SWEep[:FREQuency]:SPACing	431
[:SOURce<hw>]:LFOutput:SWEep[:FREQuency]:STEP:LOGarithmic	431
[:SOURce<hw>]:LFOutput:SWEep[:FREQuency]:STEP[:LINear]	432
[:SOURce<hw>]:LFOutput<ch>:PERiod?	422
[:SOURce<hw>]:LFOutput<ch>:SHAPE	426
[:SOURce<hw>]:LFOutput<ch>:SHAPE:PULSe:DCYCLE	426
[:SOURce<hw>]:LFOutput<ch>:SHAPE:PULSe:PERiod	427
[:SOURce<hw>]:LFOutput<ch>:SHAPE:PULSe:WIDTh	427
[:SOURce<hw>]:LFOutput<ch>:SHAPE:TRAPeZe:FALL	427
[:SOURce<hw>]:LFOutput<ch>:SHAPE:TRAPeZe:HIGH	427
[:SOURce<hw>]:LFOutput<ch>:SHAPE:TRAPeZe:PERiod	428
[:SOURce<hw>]:LFOutput<ch>:SHAPE:TRAPeZe:RISE	428
[:SOURce<hw>]:LFOutput<ch>:SHAPE:TRlangle:PERiod	428
[:SOURce<hw>]:LFOutput<ch>:SHAPE:TRlangle:RISE	428
[:SOURce<hw>]:LIST:CATalog?	441
[:SOURce<hw>]:LIST:DELete	441
[:SOURce<hw>]:LIST:DELete:ALL	441
[:SOURce<hw>]:LIST:DEXChange:AFILe:CATalog?	443
[:SOURce<hw>]:LIST:DEXChange:AFILe:EXTension	444
[:SOURce<hw>]:LIST:DEXChange:AFILe:SELect	444
[:SOURce<hw>]:LIST:DEXChange:AFILe:SEParator:COLumn	444
[:SOURce<hw>]:LIST:DEXChange:AFILe:SEParator:DECimal	444
[:SOURce<hw>]:LIST:DEXChange:EXECute	443
[:SOURce<hw>]:LIST:DEXChange:MODE	445
[:SOURce<hw>]:LIST:DEXChange:SELect	445
[:SOURce<hw>]:LIST:DWELl	435
[:SOURce<hw>]:LIST:DWELl:LIST	436
[:SOURce<hw>]:LIST:DWELl:LIST:POINts?	436
[:SOURce<hw>]:LIST:DWELl:MODE	436
[:SOURce<hw>]:LIST:FREE?	442
[:SOURce<hw>]:LIST:FREQuency	437
[:SOURce<hw>]:LIST:FREQuency:POINts?	437
[:SOURce<hw>]:LIST:INDex	437

[:SOURce<hw>]:LIST:INDEX:START.....	438
[:SOURce<hw>]:LIST:INDEX:STOP.....	438
[:SOURce<hw>]:LIST:MODE.....	438
[:SOURce<hw>]:LIST:POWER.....	438
[:SOURce<hw>]:LIST:POWER:POINTS?.....	439
[:SOURce<hw>]:LIST:RESET.....	442
[:SOURce<hw>]:LIST:RUNNING?.....	440
[:SOURce<hw>]:LIST:SELECT.....	442
[:SOURce<hw>]:LIST:TRIGGER:EXECUTE.....	439
[:SOURce<hw>]:LIST:TRIGGER:SOURCE.....	439
[:SOURce<hw>]:MODULATION[:ALL][:STATE].....	371
[:SOURce<hw>]:NOISE:BANDWIDTH BWIDTh.....	446
[:SOURce<hw>]:NOISE:BWIDTh:STATE.....	446
[:SOURce<hw>]:NOISE:DISTRIBUTION.....	446
[:SOURce<hw>]:NOISE:LEVEL:RELATIVE?.....	446
[:SOURce<hw>]:NOISE:LEVEL[:ABSOLUTE]?.....	447
[:SOURce<hw>]:PGENERATOR:OUTPUT:POLARITY.....	448
[:SOURce<hw>]:PGENERATOR:OUTPUT[:STATE].....	448
[:SOURce<hw>]:PGENERATOR:STATE.....	448
[:SOURce<hw>]:PHASE.....	449
[:SOURce<hw>]:PHASE:REFERENCE.....	449
[:SOURce<hw>]:PM:DEVIATION:MODE.....	384
[:SOURce<hw>]:PM:DEVIATION:SUM.....	385
[:SOURce<hw>]:PM:MODE.....	384
[:SOURce<hw>]:PM:RATIO.....	385
[:SOURce<hw>]:PM:SENSITIVITY?.....	385
[:SOURce<hw>]:PM<ch>:SOURCE.....	383
[:SOURce<hw>]:PM<ch>:STATE.....	383
[:SOURce<hw>]:POWER:ALC:DESENSITIVITY.....	451
[:SOURce<hw>]:POWER:ALC:MODE?.....	450
[:SOURce<hw>]:POWER:ALC:SONCE.....	451
[:SOURce<hw>]:POWER:ALC[:STATE].....	450
[:SOURce<hw>]:POWER:ATTENUATION:RFOFF:MODE.....	451
[:SOURce<hw>]:POWER:EMF:STATE.....	452
[:SOURce<hw>]:POWER:LBEHAVIOUR.....	452
[:SOURce<hw>]:POWER:LIMIT[:AMPLITUDE].....	452
[:SOURce<hw>]:POWER:LMODE.....	453
[:SOURce<hw>]:POWER:MANUAL.....	453
[:SOURce<hw>]:POWER:MODE.....	454
[:SOURce<hw>]:POWER:POWER.....	454
[:SOURce<hw>]:POWER:RANGE:LOWER?.....	457
[:SOURce<hw>]:POWER:RANGE:UPPER?.....	457
[:SOURce<hw>]:POWER:START.....	455
[:SOURce<hw>]:POWER:STEP:MODE.....	455
[:SOURce<hw>]:POWER:STEP[:INCREMENT].....	455
[:SOURce<hw>]:POWER:STOP.....	455
[:SOURce<hw>]:POWER[:LEVEL][:IMMEDIATE]:OFFSET.....	456
[:SOURce<hw>]:POWER[:LEVEL][:IMMEDIATE]:RCL.....	456
[:SOURce<hw>]:POWER[:LEVEL][:IMMEDIATE][:AMPLITUDE].....	457
[:SOURce<hw>]:PULM:DELAY.....	389

[:SOURce<hw>]:PULM:DOUBle:DElAY.....	389
[:SOURce<hw>]:PULM:DOUBle:STATe.....	390
[:SOURce<hw>]:PULM:DOUBle:WIDTh.....	389
[:SOURce<hw>]:PULM:IMPedance.....	391
[:SOURce<hw>]:PULM:MODE.....	387
[:SOURce<hw>]:PULM:PERiod.....	388
[:SOURce<hw>]:PULM:POLarity.....	391
[:SOURce<hw>]:PULM:SOURce.....	390
[:SOURce<hw>]:PULM:STATe.....	390
[:SOURce<hw>]:PULM:TRAI:n:CATalog?.....	392
[:SOURce<hw>]:PULM:TRAI:n:DELeTe.....	393
[:SOURce<hw>]:PULM:TRAI:n:DEXChange:AFILe:CATalog?.....	396
[:SOURce<hw>]:PULM:TRAI:n:DEXChange:AFILe:EXTension.....	395
[:SOURce<hw>]:PULM:TRAI:n:DEXChange:AFILe:SELect.....	396
[:SOURce<hw>]:PULM:TRAI:n:DEXChange:AFILe:SEPARator:COLumn.....	395
[:SOURce<hw>]:PULM:TRAI:n:DEXChange:AFILe:SEPARator:DECimal.....	395
[:SOURce<hw>]:PULM:TRAI:n:DEXChange:EXECute.....	396
[:SOURce<hw>]:PULM:TRAI:n:DEXChange:MODE.....	395
[:SOURce<hw>]:PULM:TRAI:n:DEXChange:SELect.....	396
[:SOURce<hw>]:PULM:TRAI:n:OFFTime.....	393
[:SOURce<hw>]:PULM:TRAI:n:OFFTime:POINts?.....	393
[:SOURce<hw>]:PULM:TRAI:n:ONTime.....	393
[:SOURce<hw>]:PULM:TRAI:n:ONTime:POINts?.....	393
[:SOURce<hw>]:PULM:TRAI:n:REPetition.....	393
[:SOURce<hw>]:PULM:TRAI:n:REPetition:POINts?.....	393
[:SOURce<hw>]:PULM:TRAI:n:SELect.....	394
[:SOURce<hw>]:PULM:TRIGger:MODE.....	388
[:SOURce<hw>]:PULM:TTYPe.....	390
[:SOURce<hw>]:PULM:WIDTh.....	389
[:SOURce<hw>]:SWEep:COMBined:COUNT.....	473
[:SOURce<hw>]:SWEep:COMBined:DWELl.....	473
[:SOURce<hw>]:SWEep:COMBined:EXECute.....	473
[:SOURce<hw>]:SWEep:COMBined:MODE.....	474
[:SOURce<hw>]:SWEep:COMBined:RETRace.....	474
[:SOURce<hw>]:SWEep:COMBined:SHAPE.....	474
[:SOURce<hw>]:SWEep:POWER:DWELl.....	466
[:SOURce<hw>]:SWEep:POWER:EXECute.....	470
[:SOURce<hw>]:SWEep:POWER:MODE.....	467
[:SOURce<hw>]:SWEep:POWER:POINts.....	467
[:SOURce<hw>]:SWEep:POWER:RETRace.....	470
[:SOURce<hw>]:SWEep:POWER:RUNNING?.....	471
[:SOURce<hw>]:SWEep:POWER:SHAPE.....	470
[:SOURce<hw>]:SWEep:POWER:SPACing:MODE?.....	467
[:SOURce<hw>]:SWEep:POWER:STEP[:LOGarithmic].....	468
[:SOURce<hw>]:SWEep:RESet[:ALL].....	475
[:SOURce<hw>]:SWEep[:FREQUency]:DWELl.....	468
[:SOURce<hw>]:SWEep[:FREQUency]:EXECute.....	470
[:SOURce<hw>]:SWEep[:FREQUency]:MODE.....	468
[:SOURce<hw>]:SWEep[:FREQUency]:POINts.....	469
[:SOURce<hw>]:SWEep[:FREQUency]:RETRace.....	470

[:SOURce<hw>]:SWEep[:FREQuency]:RUNNing?.....	471
[:SOURce<hw>]:SWEep[:FREQuency]:SHAPE.....	470
[:SOURce<hw>]:SWEep[:FREQuency]:SPACing.....	469
[:SOURce<hw>]:SWEep[:FREQuency]:STEP:LOGarithmic.....	471
[:SOURce<hw>]:SWEep[:FREQuency]:STEP[:LINear].....	471
*CLS.....	322
*ESE.....	322
*ESR?.....	322
*IDN?.....	322
*IST?.....	323
*OPC.....	323
*OPT?.....	323
*PRE.....	323
*PSC.....	323
*RCL.....	324
*RST.....	324
*SAV.....	324
*SRE.....	325
*STB?.....	325
*TRG.....	325
*TST?.....	325
*WAI.....	325
STEReo:DIRect.....	511
STEReo:DIRect.....	512
STEReo:DIRect.....	512
STEReo:DIRect.....	513
STEReo:DIRect.....	513
STEReo:DIRect.....	514
STEReo:DIRect.....	514
STEReo:DIRect.....	514
STEReo:DIRect.....	515
STEReo:DIRect.....	515
STEReo:DIRect.....	515
STEReo:DIRect.....	516
STEReo:DIRect.....	516
STEReo:DIRect.....	517
STEReo:DIRect.....	517
STEReo:DIRect.....	518
STEReo:DIRect.....	518
STEReo:DIRect.....	518
STEReo:DIRect.....	519
STEReo:DIRect.....	519
STEReo:DIRect.....	519
STEReo:DIRect.....	520
STEReo:DIRect.....	520
STEReo:DIRect.....	521
STEReo:DIRect.....	521
STEReo:DIRect.....	522
STEReo:DIRect.....	522
STEReo:DIRect.....	522

STEReo:DIReCt.....	523
STEReo:DIReCt.....	523
STEReo:DIReCt.....	523
STEReo:DIReCt.....	524
STEReo:DIReCt.....	524
STEReo:DIReCt.....	524
STEReo:DIReCt.....	525
STEReo:DIReCt.....	525
STEReo:DIReCt.....	525
STEReo:DIReCt.....	526
STEReo:DIReCt.....	526
STEReo:DIReCt.....	526
STEReo:DIReCt.....	526
STEReo:DIReCt.....	527
STEReo:DIReCt.....	527
STEReo:DIReCt.....	528
STEReo:DIReCt.....	528
STEReo:DIReCt.....	529
STEReo:DIReCt.....	529
STEReo:DIReCt?.....	528

Index

Symbols

*OPC	565
*OPC?	565
*RST	576
*WAI	565
/var/user directory	327
/var/volatile directory	327
>L	299
&LLO	299
&NREN	299
9.91E37	
Remote control	564
50 - Extern reference out of range or disconnected	531
140 - This modulation forces other modulations off	531
180 - Adjustment failed	531
182 - Adjustment data missing	531
183 - Adjustment data invalid	532
200 - Cannot access hardware	532
201 - Hardware revision out of date	532
202 - Cannot access the EEPROM	532
203 - Invalid EEPROM data	532
204 - river initialization failed	532
241 - No current list	532
242 - Unknown list type specified	532
460 - Cannot open the file	532
461 - Cannot write file	532
462 - Cannot read file	532
463 - Filename missing	532
464 - Invalid filename extension	532
465 - File contains invalid data	532

A

About	
Attenuator	148
Internal adjustments	544
Power-On/EMF	227
Reference oscillator	180
Selftests	544
UCOR	153
Accept	
Security settings	249
Active connections	
Remote access	275
Active elements	49
Add, change, delete	
User key action	234
Adjust	
Display and keyboard	225
Display settings	224
Keyboard settings	224
Adjustment frequency	
Reference oscillator	185
Adjustments	
All	550
Continue	551
Information	551
Last full adjustment	550
Settings	550
Advanced configuration	
LXI	282

ALC	
Detector sensitivity	152
Settings	152
State	152
All packages	
Secure update policy	243
Alphanumeric parameters	52
AM	67
Deviation mode	76
Overview	106
Ratio	76
Subsystem	372
Total deviation	76
Amplitude modulation	75
Depth	75
Deviation mode	76
Ratio	76
Sensitivity	76
Subsystem	372
Analog modulation	
Options	67
Overview	104
Signal source	67
Annotation	
Disable amplitude display	246
Disable frequency display	246
Disable level	246
Aperture time	
Power sensors	175
Application cards	18
Application notes	18
ARI	
BK code	82
Deviation	82
Enabling	82
Identification of ARI signal	82
ATN	583
Attention	583
Attenuator	
About	148
RF signal	148
Settings	149
Attenuator settings	
Level range	150
Mode	149
RF OFF mode	150
Auto once	
Power sensors	174
Power viewer	174
Automatic level control	
Detector sensitivity	152
Readjust internal switch position	65
Settings	152
State	152
Automation	257
Autonegotiation	
Failed	534
Avahi	
LAN services	248
Average level	
Power viewer	172

- B**
- Bandwidth
 - Modulation input 101
 - Noise generator 102
 - Basics
 - Editor 90, 144, 159
 - Export list files 91, 162
 - Fill with sensor list files 161
 - Import list files 91, 162
 - Baud rate
 - RS232 interface 273
 - Bench top, placing 24
 - Block data 561
 - Boolean parameters 560
 - Brackets 561
 - Brochures 17
 - Browser settings
 - LXI 280
 - Bytes order
 - Definition 348
- C**
- CALibration subsystem 337
 - Carrying the instrument 23
 - Case-sensitivity
 - SCPI 557
 - Central storage
 - Accessing 217
 - Change
 - GPIO address 289, 297
 - Change password
 - Setup (security) 252
 - Change user password
 - Setup (security) 251
 - Check front panel
 - Key panel test 548
 - Performing 547
 - Settings 547
 - Check touch panel
 - Touchscreen test 548
 - Checking the instrument 23
 - Clear
 - RF output protection 150
 - User menu 230
 - Clear history
 - Undo/Redo 255
 - Clear status
 - Remote 322
 - Close
 - Show SCPI command 303
 - Colon 561
 - Combined RF frequency / level sweep
 - Step count 134
 - Combined sweep
 - Spacing 130, 132
 - Comma 561
 - Command sequence
 - recommendation 576
 - Remote 325
 - Commands 555
 - Brackets 561
 - Colon 561
 - Comma 561
 - Command line structure 563
 - Common 555
 - Double dagger 561
 - Instrument control 555
 - Overlapping 564
 - Question mark 561
 - Quotation mark 561
 - SCPI confirmed 555
 - Sequential 564
 - Syntax elements 561
 - Vertical stroke 561
 - White space 561
 - Commands of all settings
 - SCPI list 200
 - Common commands
 - Syntax 557
 - Computer name
 - Changing 287
 - Syntax 287
 - Use instead of IP address 287
 - CONDition 570
 - Configuration
 - Restoring 201
 - Restoring instrument settings 197
 - Configuring LAN services 248
 - Confirm unsigned
 - Secure update policy 243
 - Confirm user password
 - Setup (security) 251, 252
 - Connecting
 - Keyboard 27
 - LAN 27
 - Memory stick 27
 - Mouse 27
 - Power 26
 - To Ref In/Ref Out 28
 - To RF 28
 - USB devices 27
 - Connection fault
 - 169.254.*.* 534
 - Connector
 - AC power supply 37
 - GPIB 36
 - IEC/IEEE 36
 - Inst Trig 37
 - LAN 36
 - Mod. Ext. 37
 - Pulse Ext. 37
 - Pulse Video 37
 - Ref In 37
 - Ref Out 37
 - RF 35
 - S/P Dif 37
 - Signal Valid 37
 - Stereo L/R 37
 - USB 35, 36
 - USB In 36
 - Context-sensitive menu 49
 - Continue
 - Internal adjustments 551
 - Control bus 583
 - Copy
 - Instrument settings 207
 - Several files 205, 214, 215
 - Show SCPI command 303
 - Counter 537
 - Coupling mode
 - AM, FM, PhiM 100
 - External modulation input 100

- Create
 - New directory 207
- Current frequency
 - Sweep 127
- Current index
 - List mode 137
- Current level
 - Sweep 127
- Customer support 542
- Cut
 - Instrument settings 207
- CW
 - Frequency 60
- CW mode
 - Output level 63
- CW signal
 - Settings 57
- D**
- Data entry 51
- Data format
 - Definition 349
- Data list
 - Access 202
 - How to access 329
 - Select, edit, new 204
- Data sheets 17
- Data valid 583
- Datasheet
 - LXI 285
- Date 545
- DAV 583
- Deactivate RF output 182
- Deactivated licenses 238
- Declassification 245
- DEF 560
- Default directory
 - Mass memory 327
 - User data 190, 328
- Default values
 - Remote 324
- Define
 - User key action 234
- Delay
 - Double pulse (PULM) 87
 - PULM 87
- Delete
 - Instrument settings 207
 - List mode file 139
- Delete instrument settings 335
- Delta phase
 - RF frequency 66
- Detector sensitivity
 - Automatic level control 152
- Deviation
 - Fixed total deviation 73, 75
 - PhiM 74
- Deviation mode
 - AM 76
 - Amplitude modulation 76
 - FM 73
 - Frequency modulation 73
 - Phase modulation 74
 - PhiM 74
- Device ID 237, 498
- Device reset 326
- Device-specific commands 555
- Device-specific error messages 531
- DHCP 286
- Dialog boxes 50
- Directory
 - Temporary data 327
 - User data 327
- Disable
 - Frequency display 246
 - Level display 246
- Display
 - Active elements 49
 - Brightness 226
 - Context-sensitive menu 49
 - Info line 49
 - Information 47
 - Keyboard layout 226
 - Lock 246
 - On-screen keypad 49
 - Overview 32
 - Power sensors 173
 - SCPI list 303
 - Screen saver 226
 - Settings 225
 - Setup 225
 - Status bar 48
 - Tab labels 49
 - Taskbar 48
 - Tile diagram 48
 - Wait time (screen saver) 226
- Display correction value
 - UCOR 157
- DISPlay subsystem 343
- Disposal 544
- Distribution
 - Noise generator 101
- DNS server 271
- DNS suffix 271
- Documentation overview 16
- Double dagger 561
- Double pulse delay
 - PULM 87
- Double pulse width
 - PULM 87
- DOWN 560
- Downgrade information 538
 - Factory version 538
 - Min. version 538
- Dwell time
 - Sweep 130
- Dwell time mode
 - List mode 137
- E**
- Edit
 - Editor 90, 144, 160
 - List mode data 139
 - UCOR data 157
- Editor
 - Basics 90, 144, 159
 - Edit 90, 144, 160
 - Fill with sensor 144, 160
 - Goto 90, 144, 160
 - Save 90, 144, 160
 - Save as 90, 144, 160

- EMF display
 - RF level 228
- Emulating front panel keys 55
- Emulation
 - IDN string 275
 - Language 274
 - Mode 274
 - Set IDN and OPT to default 274
- Enable
 - LAN interface 248
- ENABLE 570
- Enable registers
 - Remote 323
- Enter license key 238
- Enter password
 - Setup (security) 249
- EOI 583
- Error log 540
- Error messages 532
 - Adjustment data invalid (183) 532
 - Adjustment data missing (182) 531
 - Adjustment failed (180) 531
 - Cannot access hardware (200) 532
 - Cannot access the EEPROM (202) 532
 - Cannot open file (460) 532
 - Cannot read file (462) 532
 - Cannot write file (461) 532
 - Driver initialization failed (204) 532
 - Extern reference out of range or disconnected (50) . 531
 - File contains invalid data (465) 532
 - Filename missing (463) 532
 - Hardware revision out of date (201) 532
 - Invalid EEPROM data (203) 532
 - Invalid filename extension (464) 532
 - No current list (241) 532
 - This modulation forces other modulations off (140) .. 531
 - Unknown list type specified (242) 532
- Error Messages 530
 - device-specific 531
 - SCPI 531
- Error queue 571
- Error queue query 478, 479
- Error queues
 - recommendations 576
- ESE (event status enable register) 572
- ESR 569
- ESR (event status register) 572
- EVENT 570
- Event status enable register (ESE) 572
 - Remote 322
- Event status register (ESR) 572
 - Remote 322
- Exclude frequency 200
- Exclude level 201
- Execute
 - Single sweep 131
 - Trigger (list mode) 138
- Expiration date of option 538
- Export
 - Execute 93, 141, 164
 - SCPI 204
 - SCPI export 305
 - SCPI list 304
 - SCPI settings 304
- Export deactivation response 238
- Export license key 238
- Export list files
 - Basics 91, 162
- Express level in
 - Volts 449
- External frequency
 - Reference oscillator 182
- F**
- Factory
 - Preset 194
- Factory preset
 - Change GPIB address 289
 - GPIB address 297
- Factory version
 - Firmware 538
- File
 - SCPI export 305
- File catalog
 - List mode 139
- File handling 191
- File list 332
- File manager 205
- File name 219
- File select
 - Dialog 202
- File server
 - Data exchange 217
- File sharing 212
- File storage location 327
- File system 189
 - Accessing 212
- File transfer 191
 - From file server 217
 - FTP/SAMBA 257
 - How to 212
- File type selection 207
- Filename
 - Pulse graph 94
- Files
 - User data 189
- Fill
 - User correction data 90, 144, 160
- Fill table
 - Automatically 90, 144, 160
 - UCOR 157
- Fill with sensor
 - Basics 161
 - Editor 144, 160
- Filter
 - Power sensors 174
- Filter length
 - Auto 174
 - User-defiend 174
- Finding out the default directory 190, 328
- Firmware
 - Factory version 538
 - Min. version 538
 - Version 538
- Fixed
 - Frequency 60
- Floating licenses 538
- FM 67
 - Deviation 73
 - Deviation mode 73
 - Ratio 73

- Subsystem 376
- Total deviation 73
- FM deviation
 - Stereo modulation 78
- Format
 - SCPI Export 304
- FORMat subsystem 348
- FPGA/μC
 - Check for updates 553
 - Check for updates of external 554
 - Shut down after update internal 554
 - Update installation internal assembly 553
 - Update table 553
- Frequency
 - Annotation disable 246
 - CW, fixed 60
 - LF gen frequency 79
 - LF generator 99
 - LF sweep 99
 - Multiplier 60
 - Offset 60
 - Power sensors 173
 - RF signal 59
 - UCOR 157
- Frequency modulation 73
 - Deviation mode 73
 - Ratio 73
 - Subsystem 376
- Frequency, internal
 - AM 99
 - FM 99
- Front panel
 - Checking 547
- Front panel test
 - Performing 547
- Front panel tour 31
- ftp
 - How to access the instrument 212
- FTP
 - LAN services 248
- Function keys
 - Overview 33
- G**
 - Gateway 271
 - General configuration of instrument 224
 - General instrument functions
 - User key 229
 - User menu 229
 - General instrument settings 224
 - Generating an unmodulated signal 57
 - Getting started 17
 - Global dwell time
 - List mode 138
 - Goto
 - Editor 90, 144, 160
 - GPIO
 - Bus address 272
 - Change address 289, 297
 - Characteristics 263
 - Set up remote control 297
 - GPIO address 272
 - Factory preset 297
 - GUI
 - Setting 228
- GUI update
 - Setup 224
- H**
 - Hard copy
 - Create, how to 222
 - File format 219, 220
 - Print, how to 222
 - Hardcopy 218
 - Options 219
 - Help 17, 53
 - HiSLIP
 - Protocol 262
 - Resource string 260
 - History
 - Undo/Redo 255
 - Host name
 - see computer name 287
 - Hostname 269
 - LXI 279
 - see computer name 287
 - How to
 - Change the default directory 329
 - Query hardware options 539
 - Query RF assembly 539
 - Use an absolute file path 329
 - User key 235
 - User menu 231
 - HTTP
 - LAN services 248
- I**
 - Identification
 - Emulation mode 274
 - Remote 322
 - IDN string
 - Emulation mode 275
 - IFC 583
 - Impedance
 - External modulation source 101
 - Impedance audio signal 79
 - Import
 - Execute 93, 141, 164
 - Import license key 238
 - Import list files
 - Basics 91, 162
 - Import/Export
 - Lists 139
 - Select file 93, 141, 164
 - Inactive licenses 238
 - Index
 - List mode 137
 - INF 560
 - Info line 49, 532
 - Information
 - Internal adjustments 551
 - Input
 - Impedance external modulations 101
 - Pulse polarity 95
 - Stereo modulation 77
 - Trigger impedance 95
 - Input connector 37

- Input connectors
 - Mod. Ext. 37
 - S/P Dif 37
 - Stereo L/R 37
- Installed assembly 536
- Instrument
 - Carrying 23
 - Checking 23
 - Lifting 23
 - Operating site 23, 24
 - Unpacking 23
- Instrument control 45
- Instrument emulations 268, 274
- Instrument help 17
- Instrument messages 555
- Instrument security procedures 17
- Instrument settings
 - Recall 324, 335
 - Save 324, 337
- Instrument tour 31
- Interface
 - functions (GPIB bus) 584
- Interface clear 583
- Interface messages 555, 556
- Interfaces
 - GPIB 263
 - USB 263
- Internal adjustments
 - About 544
- Interrupt 574
- Invalid results
 - Remote control 564
- IP address
 - Changing 286
 - Dynamic 270
 - LXI 279
 - Not recognized 534
 - Zeroconf 270
- IP address Mode 270
- IP configuration
 - LXI 281
- IST 569
- IST flag
 - Remote 323
- K**
- Key
 - ★ (User) 35
 - Access on a remote computer 55
 - Arrow 34
 - Backspace 34
 - Down 34
 - Emulation 55
 - Enter 34
 - Esc 34
 - Freq 33
 - Help 33
 - Home 35
 - Left 34
 - Level 33
 - Local 33
 - Mod on/off 33, 69
 - Next window 35
 - On/Off 35
 - On/Standby 33
 - Preset 33
 - Resize window 35
 - RF on/off 33
 - Right 34
 - Setup 33
 - Up 34
- Key panel test
 - Check front panel 548
- Keyboard
 - On-screen 51
 - Setting 228
 - Settings 225
 - Setup 225
 - Subsystem 354
 - Usage 46
- Keypad
 - On-screen 51
 - Overview 33
- Keywords
 - see Mnemonics 556
- L**
- LAN
 - Connecting 27
 - Interface 260
 - IP address 260
 - Reset 279
 - Services 248
 - VXI protocol 262
- LAN configuration 285
 - LXI 281
- LAN interface
 - Avahi 248
 - Enable 248
 - FTP 248
 - HTTP 248
 - LAN over SCPI 248
 - SMB (Samba) 248
 - SSH 248
 - VNC 248
- LAN status
 - LXI 279
- Language
 - Emulation 274
- Last factory calibration 537
- Last full adjustment
 - Internal adjustments 550
- Layout
 - Keyboard 226
- Level
 - Annotation disable 246
 - Behavior (RF) 64, 134
 - Noise generator 104
- Level default unit
 - Change 449
- Level in SCPI in V 449
- Level limit 63
- Level offset
 - Power sensors 173
 - RF level 63
 - State (power sensors) 173
- Level range
 - Attenuator settings 150
- Level settings
 - On start-up 227
- LF frequency sweep
 - State 97, 127

- LF generator
 - Shape 97
- LF Out
 - Overview 105
- LF output 102
 - Load impedance 104
 - Offset 103
 - Period 99
 - Pulse duty cycle 99
 - Pulse width 99
 - Shape 97
 - Source 103, 106
 - Source impedance 103
 - Sweep reset 131
 - Trapezoid high 100
 - Trapezoid rise, fall 100
 - Triangle rise 99
 - Voltage 103
- LF sweep
 - Frequency 99
- License for software option 538
 - Infos 538
- Lifting the instrument 23
- Limit
 - RF level 63
- List
 - Define 139
 - Range 139
 - State 137
 - Values, defining 143, 159
- List file
 - Catalog 139
- List mode
 - Create list automatically 90, 144, 160
 - Current index 137
 - Dwell time mode 137
 - Edit 139
 - Execute trigger 138
 - Export user data 93, 141, 164
 - File settings, import/export 92, 140, 163
 - Global dwell time 138
 - Import/export 92, 139, 140, 163
 - Load from file 93, 141, 164
 - Load user data 139
 - Reset 138
 - Select file 139
 - Settings 135
 - State 137
 - Trigger execute 138
 - Trigger source 137
- Load
 - Impedance 104
 - See recall 198
- Load instrument settings 324, 335
- Loading
 - Trying out 43
- Local to remote switch over 299
- Lock
 - Display 246
- LSB/MSB order
 - Definition 348
- LXI
 - Advanced configuration 282
 - Browser settings 280
 - Configuration 316
 - Datasheet 285
 - Hostname 279
 - IP address 279
 - IP configuration 281
 - LAN configuration 281
 - LAN status 279
 - MAC address 279
 - Ping 283
 - Remote trace (SCPI) 283
 - Reset (LCI) 279
 - Status settings 278
 - Traicing 299
- LXI settings 278
- M**
 - Mac address 271
 - MAC address
 - LXI 279
 - Maintenance 544
 - Malfunctions
 - reacting 576
 - Manual interaction 46
 - Map network share
 - Settings 207
 - Mapping network drives/folders
 - How to 209
 - Mass storage location 327
 - MAX 560
 - Maximal deviation
 - Frequency modulation 73
 - PhiM 74
 - Maximal modulation frequency 80
 - Messages
 - Commands 555
 - Instrument 555
 - Instrument responses 556
 - Interface 555
 - MIN 560
 - Min. version
 - Firmware 538
 - Minimum locking range 183
 - Mnemonics 556
 - Optional 558
 - Mod. Ext. connector 37
 - Mode
 - Attenuator settings 149
 - Emulation 274
 - Frequency modulation 74
 - IP address 270
 - List 137
 - PhiM 75
 - PULM 86
 - Pulse modulation 86
 - RF level 64
 - Sweep 127
 - User variation 61, 65
 - Modulation
 - AM 69
 - Analog 67
 - Bandwidth, external input 101
 - External coupling 100
 - FM 69
 - Input impedance 101
 - Overview 104
 - Phase 69
 - PhiM 69
 - PM 69, 70
 - Pulse 69

- Source 72
- State 72
- Stereo modulation 69, 77
- Modulation depth
 - AM 75
- Modulation sensitivity
 - AM 76
- Modulations state
 - Toggle 69
- Mount network drive
 - How to 209
- Mounting, in a rack 25
- Mouse
 - Usage 46
- Multiple files
 - Copy 205, 214, 215
- Multiplier
 - Frequency 60
- N**
- Naming conventions
 - Allowed file names 189
- NAN 560
- NAN (not a number)
 - Remote control 564
- Navigation
 - Keys 34
- Navigation controls
 - Overview 34
- NDAC 583
- Network
 - Connection fails 534
 - Settings 268
- Network share
 - Mapping 207
 - Mapping, how to 209
- Network status 269
- New password
 - Setup (security) 252
- New user password
 - Setup (security) 251
- NINF 560
- Noise
 - Distribution 101
- Noise bandwidth limitation
 - System bandwidth 102
- Noise generator
 - Bandwidth 102
- Noise level
 - Absolute system bandwidth 104
 - Relative system bandwidth 104
- Noise ratio
 - Power sensors 174
- NRFD 583
- NRP power viewer
 - Settings 170
 - Use S-Parameter 175
- NRP sensor mapping
 - Connector 167
 - Protocol 167
 - Scan 167
 - Sensor name 167
 - Settings 167
- NTP
 - Address 546
- NTransition 570
- Number of licenses 538
- Numeric data entry 51
- Numeric parameters 52, 559
- Numeric values
 - Special 560
- O**
- Offset
 - Frequency 60
- Old password
 - Setup (security) 251
- Old user password
 - Setup 251
- On-screen keyboard 52
- On-screen keypad 49
- Open source acknowledgment (OSA) 18
- Open-source acknowledgments 538
- Operating site
 - Choosing 23
 - Setting up the instrument 24
- Operation
 - Manual 46
- Operation complete
 - Remote 323
- Operation hours 537
- Operation mode 198
- Option
 - Expiration date 538
- Option: expiration date 538
- Options
 - Analog modulation 67
 - Identification (remote) 323
- Oscillator
 - Reference 180
- Output
 - LF 103
 - SCPI list (select file) 305
 - Source (LF output) 106
- OUTPut
 - Subsystem 355
- Output connector 37
- Output connectors
 - RF 35
- Output queue 569
- Output, LF
 - Offset 103
 - Voltage 103
- Overlapping commands 564
 - Preventing 565
- Overview
 - AM 106
 - LF Out 105
- P**
- Parallel poll register enable
 - Remote 323
- Parameters
 - Block data 561
 - Boolean 560
 - Entering 52
 - Numeric values 559
 - SCPI 559
 - Special numeric values 560
 - String 561
 - Text 561

- Parity
 - RS232 interface 273
- Password
 - Change (security password) 252
 - Change (user password (security)) 251
 - Confirm (security password) 252
 - Confirm (user password (security)) 251
 - Enter (security password) 249
 - New (security password) 252
 - New (user password (security)) 251
 - Old (security password) 251
 - Old user password 251
 - Protection level 242
- Password management
 - Security 250
- Paste
 - Instrument settings 207
- PCI bus 536
- Phase
 - Subsystem 449
- Phase modulation 74
 - Deviation 74
 - Deviation mode 74
 - Mode 75
 - Ratio 75
 - Subsystem 381
- Phase reference 66
- PhiM
 - Deviation mode 74
 - Mode 75
 - Ratio 75
 - Settings 74
 - Total deviation 75
- Pilot tone
 - Enabling 81
 - Pilot deviation 81
 - Pilot phase 81
- Ping
 - LXI 283
- Placing, on a bench top 24
- PM 67
 - Subsystem 381
- Polarity
 - Pulse generator output 87
 - Pulse modulation 95
- Power
 - Connecting the instrument 26
 - UCOR 157
- Power On 33
- Power sensors
 - Activation 172
 - Aperture time 175
 - Auto once 174
 - Filter 174
 - Filter length 174
 - Frequency 173
 - Level (average) 172
 - Level (peak) 172
 - Level offset 173
 - Noise ratio 174
 - Serial number 172
 - Source 173
 - State 172
 - State (level offset) 173
 - Timeout 175
 - Unit 172
 - Update 170
 - Use default aperture time 175
 - Zero 172
- Power Sensors
 - Display 173
- Power supply
 - Connector 37
- Power viewer
 - Auto once 174
- Power-On
 - Settings 227
- Power-On count 537
- Power-On state
 - RF level 227
- Power-On/EMF
 - About 227
 - RF signal 227
- PPE 569
- Preemphasis 80
- Prefix, year, month, Day 221
- Preparing for use 23
- Preset
 - Factory preset 194
- Print
 - Hard copy 222
- Protection
 - Settings 241
 - Setup 240
- Protection level
 - 1 240
 - 2 241
 - 3, 4, 5 241
 - Adjustments 240
 - Calibration 241
 - Factory only 241
 - Protection level 242
 - Service department 241
- Protocol
 - VXI 262
- PTRansition 570
- PULM
 - Delay 87
 - Double pulse delay 87
 - Double pulse width 87
 - Impedance (trigger input) 95
 - Mode 86
 - Period 87
 - Pulse polarity (input) 95
 - see PM 70
 - Source 70
 - State 70
 - Subsystem 386
 - Transition type 71
 - Width 87
- Pulse
 - Duty cycle 99
 - Length (PULM) 87
 - Period 99
 - Width 99
 - Width (PULM) 87
- Pulse generator
 - Delay 87
 - Output polarity 87
 - Output state 87
 - Single Trigger 87
 - Subsystem 447
 - Width 87

- Pulse graph
 - Filename 94
 - Zoom In/Out 94
 - Zoom position 94
 - Zooming 94
- Pulse modulation 70
 - Double pulse delay 87
 - Double pulse width 87
 - Mode 86
 - Period 87
 - Pulse polarity (input) 95
 - Repetition frequency 87
 - see PM 70
 - Select pulse train file 89
 - Source 70
 - State 70, 71
 - Subsystem 386
 - Trigger input impedance 95
 - Trigger mode 86
- Pulse train
 - File catalog 89
 - Import/export 92, 140, 163
 - On/off time 90
 - Repetition 90
 - Select 89
- Q**
- QR code 277
- Queries 555, 563
 - Status 574
- Question mark 561, 563
- Questionable status register 573
- Quotation mark 561
- R**
- R&S signed packages
 - Secure update policy 243
- Rack, mounting 25
- Ratio
 - AM 76
 - Amplitude modulation 76
 - FM 73
 - Frequency modulation 73
 - Phase modulation 75
 - PhiM 75
- RDS
 - Data set 84
 - Deviation 83
 - Enable identification of program 84
 - Enable traffic announcement function 85
 - Enable traffic program function 84
 - Enabling 83
 - Show program service name 84
- Readjust
 - Automatic level control 65
- Recall
 - Instrument settings 201
 - User menu 231
- Recall instrument settings 324, 335
- Recall intermediate 201, 324
- Recommendations
 - remote control programming 576
- Recorded SCPI commands
 - SCPI list 304
- Redo 254
 - Clear history 255
 - History 255
 - Settings 255
 - State 255
- Reference frequency output
 - 1 GHz 184
 - 10 MHz, 100 MHz 184
 - Loop through 184
- Reference oscillator 180
 - Adjustment 185
 - Adjustment frequency 185
 - External frequency 182
 - Output frequency 184
 - Preset 182
 - Reference frequency, variable 183
 - RF off state 182
 - Source 182
 - Synchronization bandwidth 183
- Registers 569
- Release notes 18
- Reload
 - SCPI list 305
- Remote access 257
 - Active connections 275
 - DNS server 271
 - DNS suffix 271
 - GPIB address 272
 - GPIB resource (Visa resource string) 271
 - HISLIP resource (Visa resource string) 271
 - Identification 274
 - IDN string 275
 - Instrument emulations 274
 - IP address mode 270
 - Language 274
 - Network gateway 271
 - Network hostname 269
 - Network IP address 270
 - Network Mac address 271
 - Network resource (Ethernet resource string) 271
 - Network settings 268
 - Network status 269
 - OPT string 275
 - QR code 277
 - RS232 273
 - see Remote operation from a computer 46
 - Serial 271
 - Set IDN and OPT to default 274
 - Settings 267
 - Socket resource (Visa resource string) 271
 - Subnet mask 270
 - USB Visa resource string 271
 - Visa resource strings 271
 - Workgroup name 270
- Remote control 54
 - Basics 555
 - GPIB 297
 - Programming examples 321
 - SCPI 257
 - Source subsystem 370
- Remote operation 55
 - VNC 257
- Remote trace
 - LXI 283
- Removing sensitive data 540
- REN 583

Rename	
File	336
Instrument settings	207
Reset	
List mode	138
RF frequency (delta phase)	66
Sweep	131
Reset device parameters	326
Reset values	
Remote	324
Resource string	
VISA	260
Restoring configuration	193
Resulting file name	221
Retrace	
Sweep	128
RF combined sweep	
State	127
RF connector	35
RF frequency	
Configuring	57
RF frequency sweep	
State	126
RF level	
Configuring	57
EMF display	228
Mode	64
Offset	63
Power-On state	227
Setting characteristics	64, 134
Settings	61
RF level sweep	
State	126
RF OFF mode	
Attenuator settings	150
RF off state	
Reference oscillator	182
RF ON, RF OFF, RF ON/OFF	57
RF output	
Amplitude	63
Impedance	57
Protection	150
State	57
RF Output	
Level range	64, 135
RF output signal	
Phase	66
Phase reference	66
RF phase	
Configuring	57
RF signal	
Analog modulation	67
Attenuator	148
Frequency	59
Power-On/EMF	227
User correction	153
Rotary knob	34
User variation	61, 65
RS232	
Baud rate	273
Parity	273
Remote access	273
Stop bits	273
S	
S-Parameter	
Activate corrections	175
S/P Dif connector	37
Safety instructions	17
SAMBA/SMB	
How to access the instrument	212
Sanitize	245
Save	
Editor	90, 144, 160
Instrument settings	200
User menu	230
Save and load	197
Save as	
Editor	90, 144, 160
Save hard copy as	
bmp, jpg, png	219, 220
Save immediate	200
Save instrument settings	324, 337
Save intermediate	324
Save/Recall	197
Dialog	198
How to	201
SCPI-Export	306
Saving	43
Scan	
NRP sensor mapping	167
SCPI	
Error messages	531
Export	204
Export settings	304
LAN services	248
Output file	305
Parameters	559
Syntax	557
Version	260
SCPI confirmed commands	555
SCPI export	305
Select file	305
Show file content	305
SCPI Export	
Format	304
SCPI list	
Commands of all settings	200
Display	303
Export	304
Recorded SCPI commands	304
Show all commands	200
SCPI remote trace	
LXI	283
SCPI script	
Select	234
SCPI-Export	
Save/Recall	306
Screen saver	
Activate	228
State	226
Wait time	226
Secure update policy	
All packages	243
Confirm unsigned	243
R&S signed packages	243
Security	
Accept settings	249
Change password (setup)	252
Change user password (setup)	251

- Confirm password (setup) 252
- Confirm user password (setup) 251
- Display lock 246
- Enter password (setup) 249
- New password (setup) 252
- New user password (setup) 251
- Old password (setup) 251
- Old user password 251
- Password management 250
- Sanitize 245
- Secure update policy 243
- Security password 251
- Settings 242
- Setup 240
- USB storage (setup) 244
- User name (setup) 251
- User password 251
- Volatile memory 245
- Security password
 - Security 251
 - Setup 251
- Security settings 240
- Select
 - List mode data file 139
 - Setup file 234
 - User correction data file 157
- Select file 204
- Self-test
 - Remote 325
- Selftests
 - About 544
- Sensitive information
 - Protecting 190, 197
- Sequential commands 564
- Serial bus 536
- Serial number 288
 - Power sensors 172
- Service manual 17
- Service request (SRQ) 571, 574
- Service request enable register (SRE) 571
 - Remote 325
- Services
 - LAN 248
- Set IDN and OPT to default
 - Emulation mode 274
- Set up remote control
 - GPIB 297
- Setting commands 555
- Settings
 - Active connections 275
 - ALC 152
 - AM 75
 - Attenuator 149
 - Automatic level control 152
 - Check front panel 547
 - Display 225
 - Instrument emulations 274
 - Internal adjustments 550
 - Keyboard 225
 - List mode 135
 - Managing 189
 - NRP power viewer 170
 - NRP sensor mapping 167
 - On power-on 227
 - Protection 241
 - Remote access 267
 - RF level 61
 - SCPI export 304
 - Security 242
 - UCOR 156
 - Undo/Redo 255
 - User key 233
- Setup
 - Accept security settings 249
 - Adjusting display 224
 - Adjusting keyboard 224
 - Annotation frequency 246
 - Annotation level 246
 - Change password 251
 - Change password (security) 252
 - Confirm password 251
 - Confirm password (security) 252
 - Display lock 246
 - Enter password (security) 249
 - GUI update 224
 - Keyboard settings 225
 - Layout (keyboard) 226
 - New password 251
 - New password (security) 252
 - Old password (security) 251
 - Password (protection) 242
 - Performing the front panel test 547
 - Protection level 242
 - Screen saver 226
 - Secure update policy 243
 - Security password 251
 - USB storage (security) 244
 - User name (security) 251
 - User password 251
 - Wait time 226
- Setup files
 - Data exchange 217
- Setup key 224
- Shape
 - LF gen shape 79
 - LF generator 97
 - LF output 97
 - Period 99
 - Pulse duty cycle 99
 - Pulse width 99
 - Sweep 128
 - Trapeze high 100
 - Trapezoid rise, fall 100
 - Triangle rise 99
- Shortcut to a network drives
 - How to 209
- Show
 - SCPI list 200
- Show file content
 - SCPI export 305
- Show SCPI command
 - Close 303
 - Copy 303
- Signal output
 - LF 102
- Signal source
 - Analog modulation 67
- Single
 - Execute (list mode) 138
- SMB (Samba)
 - LAN services 248
- Softkey bar
 - see Taskbar 48

- Source
 - AM, FM, Φ M 72
 - Analog modulation 67
 - Impedance 103
 - LF output 103, 106
 - Power sensors 173
 - Pulse modulation 70
 - Reference oscillator 182
 - Sweep trigger 127
- Source subsystem
 - Remote control commands 370
- Spacing
 - Frequency sweep 130, 132
 - RF frequency / level sweep 130, 132
 - RF level sweep 134
- Span
 - Frequency sweep 132
- SRE 569
- SRE (service request enable register) 571
- SRQ 583
- SRQ (service request) 571, 574
- SSH
 - LAN services 248
- Standby 33
- Start
 - Frequency sweep 132
 - RF level sweep 134
- State
 - Adjustment (reference oscillator) 185
 - AM, FM, Φ M 72
 - Automatic level control 152
 - LF frequency sweep 97, 127
 - List mode 137
 - Power sensors 172
 - Pulse generator output 87
 - Pulse modulation 70
 - RF frequency / level sweep 127
 - RF frequency sweep 126
 - RF level sweep 126
 - RF output 57
 - RF output protection 150
 - Screen saver 226
 - Stereo modulation 78
 - UCOR 157
 - Undo/Redo 255
- Status
 - Queries 574
- Status bar
 - Display 48
- Status byte
 - Remote 322, 325
- Status byte (STB) 571
- Status information 238
- Status register
 - Response format definition 349
- Status registers 569
 - CONDition 570
 - ENABLE 570
 - EVENT 570
 - model 570
 - NTRansition 570
 - parts 570
 - PTRansition 570
- Status reporting system 567
 - Application 574
 - Common commands 321
- Status settings
 - LXI 278
- STB 569
- Step
 - Frequency sweep 133
 - Linear (frequency sweep) 133
 - Logarithmic (frequency sweep) 133
 - RF level sweep 134
- Step count
 - Combined RF frequency / level sweep 134
- Step width
 - User variation 61, 65
- Stereo L/R connector 37
- Stereo modulation 67, 77
 - Change modes 79
 - Enabling 78
 - Frequency of LF generator signal 79
 - Impedance of external analog audio signal 79
 - Maximal modulation frequency 80
 - MPX deviation 78
 - Preemphasis 80
 - Shape of LF generator signal 79
 - Source of audio signal 79
- Stop
 - Frequency sweep 132
 - RF level sweep 134
- Stop bits
 - RS232 interface 273
- Storage 544
- Storage location
 - /usb/ 189
 - /var/user 189
 - /var/volatile 189
 - Mass memory 327
- Store
 - Save 198
- Storing files 329
- String in remote commands 561
- Subnet mask 270
- Subsystem
 - AM 372
 - FM 376
 - Keyboard 354
 - Phase 449
 - PM 381
 - Power 449
 - PULM 386
 - Pulse generator 447
 - Stereo modulation 397
- Suffixes 558
- Support 540
- Sweep
 - Center frequency 132
 - Current frequency 127
 - Current level 127
 - Dwell time 130
 - Execute single 131
 - Frequency span 132
 - Mode 127
 - Reset 131
 - Retrace 128
 - Shape 128
 - Spacing 130, 132, 134
 - Start/stop frequency 132
 - Start/stop level 134
 - State (LF frequency) 97, 127
 - State (RF combined) 127

- State (RF frequency) 126
- State (RF level) 126
- Step 133, 134
- Trigger manually 131
- Switching
 - On or off 30
- Synchronization bandwidth
 - Reference oscillator 183
- Syntax elements
 - SCPI 561
- System
 - Factory preset 194
- System bandwidth
 - Noise level (absolute) 104
 - Noise level (relative) 104
- T**
- Tab labels 49
- Temperature offset
 - Internal adjustments 551
- Temporary files 190, 197
- Test
 - Check front panel 547
- Text entry 51
- Text parameters in remote commands 561
- Tile diagram
 - Display 48
- Time
 - UTC 545
- Timeout
 - Filter (power sensors) 175
- Tooltips
 - Show 53
- Touchscreen 32
 - Compared with mouse 46
 - Usage 46
- Touchscreen test
 - Perform 548
- Traicing
 - Messages 299
 - SCPI commands 299
- Transition
 - PULM 71
 - Pulse modulation 71
- Trapezoid
 - High (LF generator) 100
 - Rise, fall 100
- Triangle
 - Rise 99
- Trigger
 - Event (remote) 325
 - Execute (list mode) 138
 - Sweep, manually 131
- Trigger source
 - List mode 137
 - Sweep 127
- Tripped
 - RF output protection 150
- U**
- UCOR
 - About 153
 - Data 157
 - Display correction value 157
 - Edit data 157
- Export user data 93, 141, 164
- File catalog 157
- File settings, import/export 92, 140, 163
- Fill with sensor 161
- Import/export 92, 139, 140, 163
- Load from file 93, 141, 164
- RF signal 153
- Select file 157
- Settings 156
- State 157
- Values, defining 143, 159
- Undo 254
 - Clear history 255
 - History 255
 - Settings 255
 - State 255
- Unpacking the instrument 23
- UP 560
- USB
 - Interfaces 263
 - Storage (security) 244
- Use default aperture time
 - Power sensors 175
- User correction
 - see UCOR 153
- User data
 - Access 202
 - Load from a specific directory 329
- User files 189
- User interface
 - Lock 246
- User key 229
 - Action name 233
 - Add, change, delete action 234
 - Assign actions 235
 - Define action 234
 - SCPI command 234
 - Select dialog ID 234
 - Settings 233
 - Toggle between define and execute mode 234
- User manual 17
- User menu 229
 - Access 231
 - Clear 230
 - Create 231
 - Recall 231
 - Save 230
 - Settings 230
- User name
 - Setup (security) 251
- User password
 - Security 251
 - Setup 251
- User preset 193
- User variation
 - Activating 61, 65
 - Level 61, 65
 - RF 61, 65
- User-definable preset
 - Recall 230
- Utility keys
 - Overview 32
- V**
- Variable reference frequency 183

Varying	
RF frequency and level	61, 65
Version	
Firmware	538
Vertical stroke	561
VISA	260
Libraries	265
Resource string	260
Visa resource string	
Ethernet	271
GPIB	271
HISLIP	271
Serial	271
Socket	271
USB	271
Visa resource strings	271
VNC	
LAN services	248
Using in a LAN	55
Volatile memory	190, 197
Volatile mode	
Activate	245
VXI protocol	262
W	
Wait	
Remote	325
Wait time	
Screen saver	226
Warnings	530, 532
White papers	18
White space	561
Wi-Fi	
WLAN	313
Width	
Double pulse (PULM)	87
PULM	87
Pulse modulation	87
Workgroup name	270
Z	
Zero	
Power Sensors	172
Zeroconf	
IP address	534
Zeroconf (APIPA) protocol	286
Zoom In/Out	
Pulse graph	94
Zoom position	
Pulse graph	94
Zooming	
Pulse graph	94