

SP3025A	
SP3050A	●

SP3025A/SP3050A Passive Probe Instruction Manual

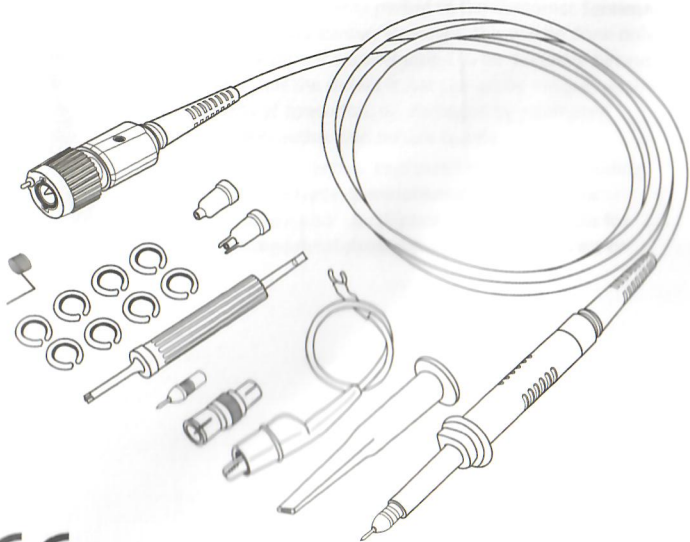

CE



Add: 3/F, Bldg No.4, Antongda Industrial Zone, 3rd Liuxian Road,

Bao'an District, Shenzhen, 518101,

ChinaTel: 800-999-0807

E-mail: support@siglent.com

SP3025A/SP3050A Instruction Manual

Instruction Manual Version 1.2

© 2016 Siglent, Inc. All rights reserved.

Information in this publication supersedes all earlier versions. Specifications are subject to change without notice.

Warranty

NOTE: THE WARRANTY BELOW REPLACES ALL OTHER WARRANTIES, EXPRESSED OR IMPLIED, INCLUDING BUT NOT LIMITED TO ANY IMPLIED WARRANTY OF MERCHANTABILITY, FITNESS, OR ADEQUACY FOR ANY PARTICULAR PURPOSE OR USE. SIGLENT SHALL NOT BE LIABLE FOR ANY SPECIAL, INCIDENTAL, OR CONSEQUENTIAL DAMAGES, WHETHER IN CONTRACT OR OTHERWISE.

Siglent warrants this oscilloscope accessory for normal use and operation within specification for a period of one year from the date of shipment. Spare parts, replacement parts and repairs are warranted for 90 days.

In exercising its warranty, Siglent, at its option, will either repair or replace any assembly returned within the warranty period to the Customer Service Department of an authorized service center. However, this will be done only if the product is determined by Siglent's examination to be defective because of workmanship or materials, and the defect is not caused by misuse, neglect, accident, abnormal conditions of operation; or, damaged by attempted repair or modifications by a non-authorized service facility.

This warranty replaces all other warranties, expressed or implied, including, but not limited to, any implied warranty of merchantability, fitness, or adequacy for any particular purposes or use. Siglent shall not be liable for any special, incidental, or consequential damages, whether in contract or otherwise.

Terms and Symbols

The following terms appear in this manual:



CAUTION of potential damage to equipment, or **WARNING** of potential for bodily injury. Attend to the accompanying information to protect against personal injury or damage. Do not proceed until conditions are fully understood and met.

The following symbols may appear on the product:



DANGER High Voltage, risk of electric shock or burn.



ATTENTION Refer to Manual



DOUBLE INSULATION



PROTECTIVE (EARTH) TERMINAL

Introduction

The Siglent SP3025A and SP3050A are passive high impedance voltage oscilloscope probes designed and calibrated for use with general purpose oscilloscopes having an input impedance of 1 MΩ shunted by 16 pF. However, they may be compensated for use with instruments having an input capacitance between 10 to 30 pF for SP3025A, and 8 to 20 pF for SP3050A. They are compatible with oscilloscopes that automatically detect probe attenuation and adjust their readout accordingly.

Specifications

Model	Attn.	Input Imped.		B/W (MHz)	Rise Time (ns)	Length (m)	Compensation Range (pF)
		R(MΩ)	C(pF)				
SP3025A	10x	10	12	250	1.4	1.2	10 - 30
SP3050A	10x	10	11	500	0.7	1.2	8 - 20

Attenuation Ratio10:1 ± 1%

Max. Input VoltageMeasurement Category I: 500 Vrms CAT I
1500 V transient overvoltage
(see voltage derating curve on page 10)
Measurement Category II: 400 Vrms CAT II

Pollution DegreePollution Degree 2 (as defined in EN 61010-031)

Operating AltitudeUP to 3000 meters

Max. Operating Temp0° C to +50° C

Humidity5% to 95% RH (10° C to 30° C)
5% to 75% RH (30° C to 40° C)
5% to 50% RH (above 40° C)
RH not controlled below 10° C

Definitions:

Measurement Category I (CAT I): measurements performed on circuits not directly connected to mains.

Measurement Category II (CAT II): measurements performed on circuits directly connected to the low-voltage installation.

Pollution Degree 2: operating environment where normally only dry, non-conductive pollution occurs. Temporary conductivity caused by condensation must be expected.

EC Declaration of Conformity



The product is marked with this symbol to indicate that it conforms to the applicable European Union requirements per Low Voltage Directive (LVD) 2006/95/EC. Compliance was demonstrated to the following specification as listed in the Official Journal of the European Communities:

EN 61010-031/A1:2008 Safety requirements for electrical equipment for measurement, control and laboratory use – Part 031: Safety requirements for handheld probe assemblies for electrical measurement and test.

EU RoHS Compliance

The probe and its accessories conform to the 2011/65/EU RoHS2 Directive, as they have been classified as Industrial Monitoring and Control Equipment (per Article 3, Paragraph 24) and are exempt from RoHS compliance until 22 July 2017 (per Article 4, Paragraph 3).

General Safety Information



Observe generally accepted safety procedures in addition to those listed here to avoid personal injury or damage to equipment. **The overall safety of any system incorporating this accessory is the responsibility of the assembler of the system.**

Connect only to grounded instruments. Use only with compatible Teledyne LeCroy oscilloscopes that have their BNC input connected to an earth ground. Do not connect the probe reference lead to any point which is at a potential other than earth ground.

Connect and disconnect properly. Connect probe to the oscilloscope before connecting it to the test circuit. Disconnect the probe input and reference lead from the test circuit before disconnecting from the oscilloscope. Do not connect or disconnect probes while they are connected to a voltage source.

Do not overload. Do not apply any potential to the probe leads that exceeds the maximum rating of the probe. **Always comply with the Voltage vs. Frequency Derating Curve.**

Observe all terminal ratings. Observe all markings on the oscilloscope before connecting. Consult the oscilloscope product manual for further ratings information.

Do not remove probe casing. Touching exposed connections may result in electric shock.

Use indoors only within operational environment listed. Do not use in wet or explosive atmospheres. Keep product surfaces clean and dry.

Handle with care. Probe tips are extremely sharp and may puncture skin or cause other bodily injury if not handled properly.

Keep fingers behind the finger guard of probe body and accessories.

Do not operate with suspected failures. Before each use, inspect the probe and accessories for any potential damage such as tears or other defects in the probe body, cable jacket, accessories, etc. If any part is damaged, cease operation immediately and sequester the probe from inadvertent use.

Cleaning

- Clean only the exterior of the probe, cables, and accessories. Use a soft cotton cloth moistened with a mild detergent and water solution. Do not allow any portion of the probe to be submerged at any time.
- Dry the probe and accessory thoroughly before attempting to make any voltage measurement.
- Do not subject the probe to solvents or solvent fumes as these can cause deterioration of the probe body, cables, and accessories.

Disposal



The probe is marked with this symbol to indicate that it complies with the applicable European Union requirements to Directives 2002/96/EC and 2006/66/EC on Waste Electrical and Electronic Equipment (WEEE) and Batteries.

This electronic product is subject to disposal and recycling regulations that vary by country and region.

Probe Compensation

Proper compensation of the probe is required to assure amplitude accuracy of the waveform being measured by matching the probe to the oscilloscope's input capacitance. Compensation should be adjusted whenever the probe is connected to or transferred between oscilloscopes.

Low Frequency (SP3025A and SP3050A)

1. Apply a 1 kHz square wave to the probe or connect to the oscilloscope's calibrator output.
2. Adjust the low-frequency trimmer located on the SP3025A/SP3050A BNC Compensation Box until you achieve a flat-topped square wave like the center illustration in the second figure below.

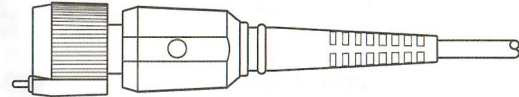

Single, low-frequency trimmer on SP3025A and SP3050A



Over-compensated, correct, and under-compensated waveforms

SP3025A/SP3050A Passive Probe

High Frequency (SP3050A only)

High frequency should rarely require adjustment. However, if adjustment is required:

1. Apply a 1 MHz square wave to the probe (< 0.7 ns rise-time).
2. Remove the plastic caps from the two, high-frequency trimmers on the SP3050A BNC Compensation Box.
3. Adjust HF2 then HF1 until you achieve a flat-topped square wave like the center illustration in the second figure below.

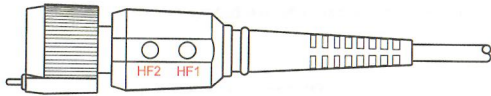

Dual, high-frequency trimmers on SP3050A

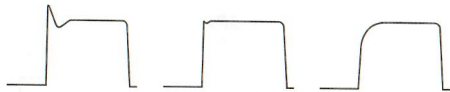

Over-compensated, correct, and under-compensated waveforms

SP3025A Input Impedance Profile

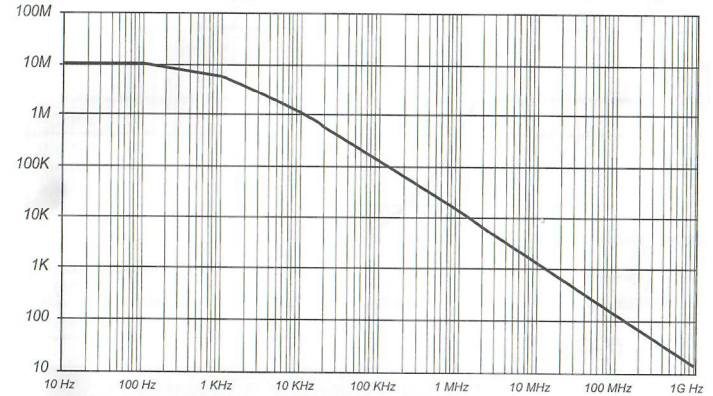

SP3050A Input Impedance Profile

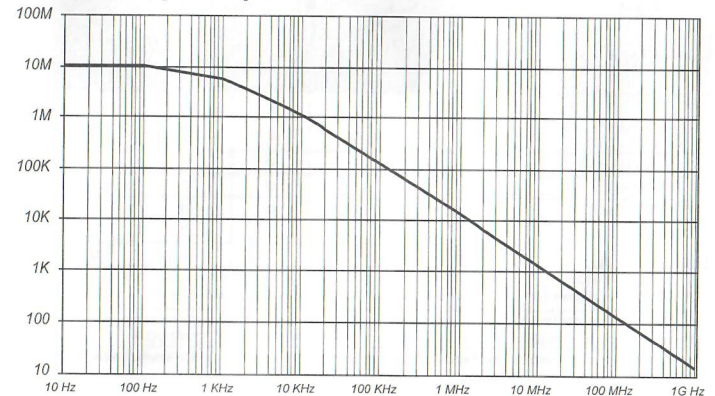

Voltage vs. Frequency Derating Curve

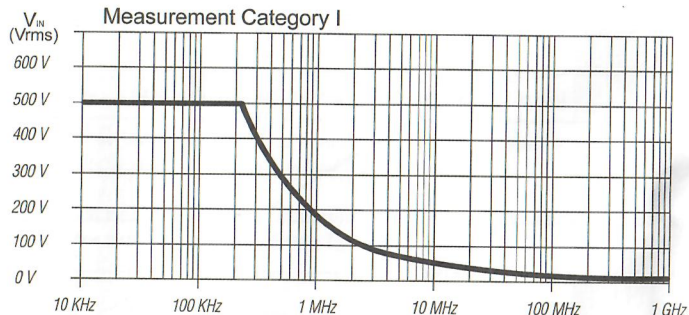

China RoHS Compliance

Part Name	Toxic or Hazardous Substances and Elements						
	Lead (Pb)	Mercury (Hg)	Cadmium (Cd)	Hexavalent Chromium (Cr ⁶⁺)	Polybrominated Biphenyls (PBB)	Polybrominated Diphenyl Ethers (PBDE)	
PCBAs	X	O	O	O	O	O	
Mechanical Hardware	X	O	O	O	O	O	
Sheet Metal	O	O	O	O	O	O	
Plastic Parts	O	O	O	O	O	O	
Protective Case	O	O	O	O	O	O	
Cable Assemblies	X	O	O	O	O	O	
Probe Tips	X	O	O	O	O	O	

O: Indicates that this toxic or hazardous substance contained in all of the homogeneous materials for this part is below the limit requirement specified in SJ/T11363-2006.

X: Indicates that this toxic or hazardous substance contained in at least one of the homogenous materials used for this part is above the limit requirement specified in SJ/T11363-2006.

EFUP (Environmental Friendly Use Period): 30 Years. Use Conditions: refer to the environmental conditions stated in the Specifications section of this Manual.

部件名称	有毒有害物质和元素					
	铅 (Pb)	汞 (Hg)	镉 (Cd)	六价铬 (Cr ⁶⁺)	多溴联苯 (PBB)	多溴苯醚 (PBDE)
PCBAs	X	O	O	O	O	O
机械硬件	X	O	O	O	O	O
金属片	O	O	O	O	O	O
塑料部件	O	O	O	O	O	O
保护外壳	O	O	O	O	O	O
电缆组件	X	O	O	O	O	O
探头端部	X	O	O	O	O	O

O:表明该有毒有害物质在该部件所有物质材料中的含量均在SJ/T11363-2006标准规定的限量要求之下。

X:表明该有毒有害物质至少在该部件的某一均质材料中的含量超出SJ/T11363-2006标准规定的限量要求。

EFUP(对环境友好的使用时间)使用条件: 参阅本手册“规范”部分规定的环境条件。

Replaceable Parts

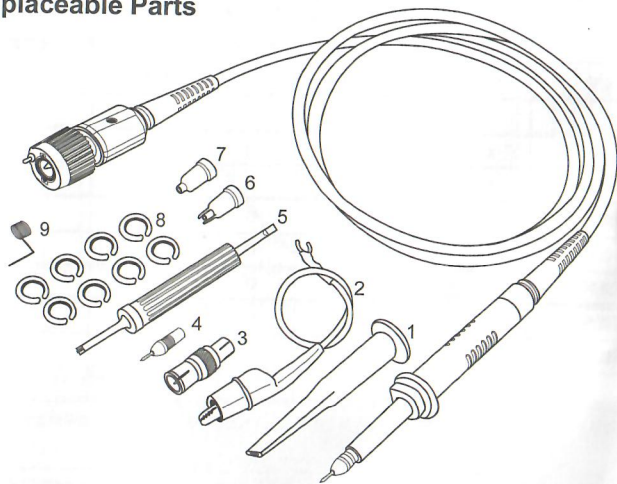

Item	Description	Quantity
1	Sprung Hook, 5 mm, Black	1
2	GND Lead w/Alligator Clip	1
3	BNC Adapter, 5 mm	1
4	Replacement Tip, Black	1
5	Deluxe Trimmer Tool	1
6	IC Tip Insulator, 5 mm, Black	1
7	Tip Insulator, 5 mm, Black	1
8	Identifier Rings	1
9	Probe Tip GND	1

Contact Siglent

Siglent Office

If you need any technical support or other help, you can contact SIGLENT service department directly.

Siglent Technologies Co., Ltd

Add: 3/F, Bldg No.4, Antongda Industrial Zone, 3rd Liuxian Road, Bao'an District, Shenzhen, 518101, China.

Tel: 800-999-0807

E-mail: support@siglent.com

To get latest product and service information please log in <http://www.siglent.com>