

SP746P

SMARTMOUNT.

Pivoting Wall Mount For 22" -47" Displays

Touchboards

205 Westwood Ave, Long Branch, NJ 07740
Phone: 866-94 BOARDS (26273) / (732)-222-1511
Fax: (732)-222-7088 | E-mail: sales@touchboards.com

As the signature brand by Peerless-AV®, the SmartMount® series wall mounts reflect remarkable form and function with superior design aesthetics. The pivoting wall mounts feature versatile display positioning and one-person, Hook-and-Hang™ easy installation. The pivoting arm allows you to extend the display up 11.99" (304mm) from the wall, and can retract to just 2.61" (66mm) from the wall. The internal cable management provides a clean, professional finish. One-Touch™ tilt of ±15°, ±5° of roll for post-installation leveling, and ±90° of pivot means the display will be perfectly positioned for the optimum viewing angle.



FEATURES

- Fits 22"-47" (56-117cm) displays weighing up to 70lb (32kg)
- Extends display 11.99" (304mm) from the wall
- Retracts to hold display 2.61" (66mm) from the wall
- ±90° of pivot allows for perfect display positioning
- Easy leveling ±5° after display installation
- Internal cable management provides clean, professional installation finish
- Landscape or portrait mounting options increases display versatility
- Quick and easy, Hook-and-Hang™ one-person installation
- ±15° of One-Touch™ tilt for smooth viewing angle adjustment
- VESA® 75, 100, 100 x 200, 200 x 100, 200 x 200, 300 x 200, 300 x 300, 400 x 300 and 400 x 400mm compliant
- Mounts to wood studs, concrete, cinder or breeze block
- Installation hardware included
- UL listed
- Five-year warranty



Display size: 22"-47"



Max load: 70lb (32kg)

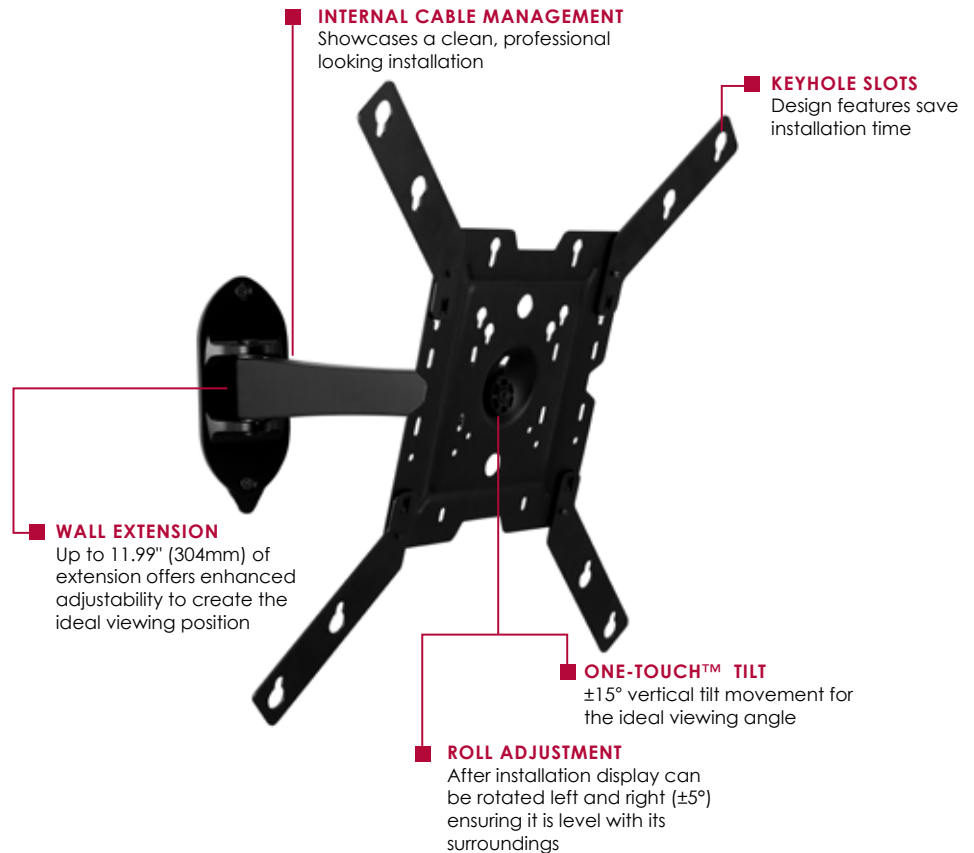

Internal Cable Management



±15° of viewing angle adjustment

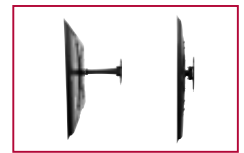

Arm retracts to just 2.61" (66mm) and extends up to 11.99" (304mm) from the wall



CLICK: peerless-av.com

CALL: 800.865.2112

FAX: 800.359.6500

peerless-AV®

SP746P	SmartMount® Pivoting Wall Mount for 22"-47" Displays
---------------	--

Product Specifications

	DIMENSIONS (W x H x D)	PRODUCT WEIGHT	LOAD CAPACITY	FINISH	AVAILABLE COLORS
SP746P	19.75" x 18.38" x 2.61"-11.99" (502 x 467 x 66-304mm)	4.98lb (2.26kg)	70lb (32kg)	Matte	Black

Package Specifications

	PACKAGE SIZE (W x H x D)	PACKAGE SHIP WEIGHT	PACKAGE UPC CODE	PACKAGE CONTENTS	UNITS IN PACKAGE
SP746P	16.5" x 10.25" x 2.60" (419 x 260 x 66mm)	5.44lb (2.47kg)	735029294634	Wall mount, attachment hardware, installation instructions	1

Accessories

ACC976:	Security Fasteners	ESHV10:	Single AV Wall Shelf
WSP700/701:	Metal Stud Wall Plate	ESHV20:	Single AV Wall Shelf with Glass
IBA4-W:	Easy Mount Recessed Low Voltage Cable Plate	ESHV30:	Dual AV Wall Shelf with Glass
IBA5-W:	In-Wall Accessories Box with 125V Duplex Power		

All dimensions = inch (mm)

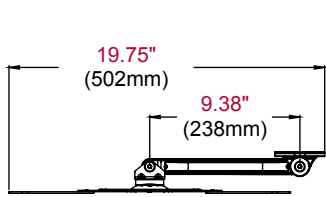

TOP VIEW

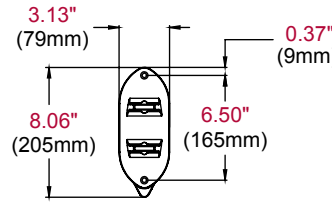

WALL PLATE

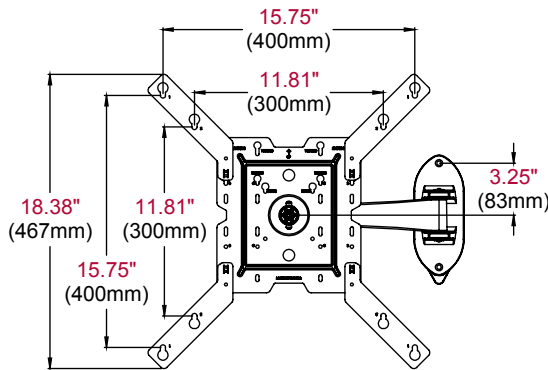

FRONT VIEW

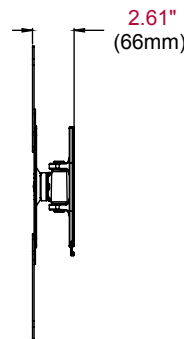

SIDE VIEW

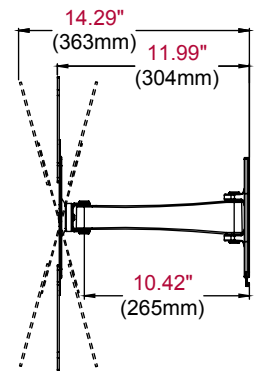

SIDE VIEW EXTENDED +/- 15° TILT

ARCHITECTS SPECIFICATIONS

The SmartMount® Pivoting Wall Mount shall be a Peerless-AV model SP746P and shall be located where indicated on the plans. Assembly and installation shall be done according to instructions provided by the manufacturer.

Peerless Industries, Inc. ■ 2300 White Oak Circle ■ Aurora, IL 60502 ■ (800) 865-2112 ■ (630) 375-5100 ■ Fax: (800) 359-6500 ■ peerless-av.com

Visit peerless-av.com to see the complete line of AV solutions from Peerless-AV, including flat panel mounts, projector mounts, carts/stands, furniture, cables, display cleaners and a full assortment of accessories.