

# LEONOVA<sup>®</sup> EMERALD



# User guide



# User guide

## General instrument functions

Instrument data and functions, general settings, files and upgrades

A

## General measurement functions

Measuring modes, recording, measuring rounds, display windows, spectrum functions and order tracking

B

## Measurement techniques always included

RPM, temperature, ISO 2372 vibration and stethoscope

C

## Shock pulse measurement

SPM HD, SPM dBm/dBc, SPM HR/LR, SPM LR/HR HD and SPM Spectrum

D

## Vibration measurement

ISO 10816 vibration, HD ENV, EVAM vibration analysis, FFT with symptoms

E

## Rotor balancing

Single plane balancing

F

## Safety notes

- The instrument is intended for professional, industrial process, and educational use only while taking into consideration the technical specifications. The accessories may only be used for their respective intended use as defined in this manual.
- The instrument and accessories must be connected only to voltages NOT exceeding 16 Vrms, 22.6 Vpeak or 35 Vdc.
- **Warning!** Do not use within measurement categories CAT II, III, or IV (SS-EN 61010-031/61010-2-030). The instrument must NOT be connected to MAINS circuits.
- This instrument is CAT I, with a transient overvoltage rating of 500 V, and it is intended for low energy applications.

An external overcurrent protection device of maximum 10 A (suitable breaking capacity) must be used if the measurement application is high energy (e.g. a high power battery used for standby sources).

- All installations shall be in accordance with national regulations. Please observe the risk of earth potential differences when using long cables.
- When measuring on machines in operation, ensure that no cables etc. can be caught in rotating parts which can cause injury.
- For safety reasons, the measurement device must only be operated and maintained by properly trained personnel.
- Service and repairs of the measurement device may only be performed by SPM authorized service technician.
- When not in use, always keep the protective caps on the connector sockets to keep them clean.



### Warning!

This manual must be consulted in all cases involving equipment marked with this symbol.

## Trademarks

CondID, Condmaster, DuoTech, EVAM, HD ENV, Intellinova, Leonova, Leonova Diamond, Leonova Emerald, SPM and SPM HD are trademarks of SPM Instrument AB.

All other trademarks are the property of their respective owners.

© Copyright SPM Instrument AB. ISO 9001 certified. Technical data are subject to change without notice.

Patents: DE#60304328.3 - US#7,054,761 - US#7,167,814 - US#7,200,519 - US#7,301,616 - US#7,313,484 - US#7,324,919 - US#7,711,519 - US#7,774,166 - DE#60336383.0 - US#7,949,496 - DE#60337804.8 - GB#1474662 - GB#1474663 - DE#60338365.3 - ZA#2011/04946 - SE#0951017-3 - DE#60341502.4 - GB#1474659 - SE#1000631-0 - US#8,762,104 - US#8,812,265 - US#8,810,396 - CN#ZL200980155994.1 - CN#ZL201080019737.8 - KZ#020791 - RU#020791 - AU#2009330744 - RU#021908 - KZ#021908 - US#9,200,980 - US#9,213,671 - CN#ZL201180006321.7 - KZ#022630 - RU#022630 - US#9,279,715 - US#9,304,033 - KZ#024339 - RU#024339 - CN#ZL201380007381.X - AU#2015203801 - AU#2013215672 - RU#201491377 - CN#ZL2012800347548 - US#6,873,931 - DE#602013021988.5 - DK/FI/FR/IT/NL/NO/ES/GB#2810027 - SE#13744257.0 - AU#2015203361 - RU#027452 - GB#2505984 - US#9,772,219



This product must be disposed of as electronic waste and is marked with a crossed-out wheeled bin symbol in order to indicate that it must not be discarded with household waste.

When the life cycle of the product is over you can return it to your local SPM representative for proper management, or dispose of it together with your other electronic waste.

Made in Sweden by

**SPM Instrument AB**

Box 504, SE-645 25 Strängnäs, Sweden, Tel +46 152 22500 Telefax +46 152 15075, info@spminstrument.se  
www.spminstrument.com | www.leonovabyspm.com

# General instrument functions

## Contents

Leonova Emerald <sup>®</sup> .....	3
Instrument overview.....	4
Charge the battery pack .....	5
Start / Check battery status .....	6
About Leonova.....	6
Navigation .....	7
Defining shortcut keys and menu options .....	8
Reset.....	9
Instrument calibration .....	9
Main functions .....	9
Instrument settings .....	10
General settings.....	11
Set date/time .....	13
Register transducers .....	14
Default transducers .....	15
User defined transducers .....	16
Edit text and numbers.....	17
Select language .....	18
Change font, size and style .....	18
Create measurement files .....	19
Function and use.....	19
Order functions.....	20
Maintenance and repair .....	21
Replacement of Protection foil 16686 .....	21
Procedure for replacing or moving wrist strap .....	21
Communication with the PC.....	22
Leonova service program.....	22
Upgrade Leonova software .....	23
Safety copies of Leonova files.....	24
Reload safety copies of Leonova files .....	25
Upload and download files to PC.....	25
File management in Leonova .....	26
List of icons.....	27
Technical specifications.....	28

A

# Leonova Emerald<sup>®</sup>

Leonova Emerald is a multi-function, hand-held data collector/signal analyzer for monitoring and diagnosing machine condition. The instrument is operated via keypad and programmable function keys. Basic data for the measurement set-up can be input manually or downloaded from Condmaster<sup>®</sup>Ruby.

Leonova Emerald is always programmed for the measuring techniques described in chapter C. Other diagnostic and analytic functions, for shock pulse measurement, vibration measurement and rotor balancing, are user selected.

This instruction describes the general instrument settings and basic operations.

## Supplied accessories

- 14661 Wrist strap
- PRO52 Leonova Service Program

## Optional accessories

- 16573 Optional battery pack
- 16644 Battery adapter unit, 100–240 V AC
- CHA01 Battery charger incl. AC adapter, Euro-plug
- CHA02 Battery charger incl. AC adapter, UK-plug
- CHA03 Battery charger incl. AC adapter, US-plug
- CHA04 Battery charger incl. AC adapter, AU-plug
- 93484 Car charger cable, 12 V
- CAB94 Communication cable, USB - mini USB, 1 m
- 16646 Shoulder strap with safety buckle
- 16675 Belt clip
- 16686 Protection foil for display
- CAS25 Carrying case, plastic with foam insert
- CAS28 Carrying case, soft, with modular insert
- 81468 Code lock, TSA approved, for CAS25
- 81469 Silica gel (moisture absorbent) spare for CAS25

The equipment listed above is part of the Leonova instrument. In addition, transducers and measuring cables are needed for the measurements. These are bought separately, depending on which of the available measurement functions are implemented.



14661



16675



CHA01/CHA02/  
CHA03/CHA04



CAS28



CAS25

# Instrument overview

A



Rechargeable battery pack



Hold and pull end of rubber sleeve to detach Lemo connectors.

VIB: Vibration transducer input, 8 pin Lemo connector

SPM: Shock pulse transducer input, mini coax

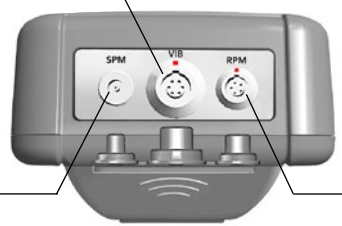

RPM: Input for RPM/temp probe, NPN/PNP sensors incl. 12 VDC power supply and stroboscope control, 5 pin Lemo connector

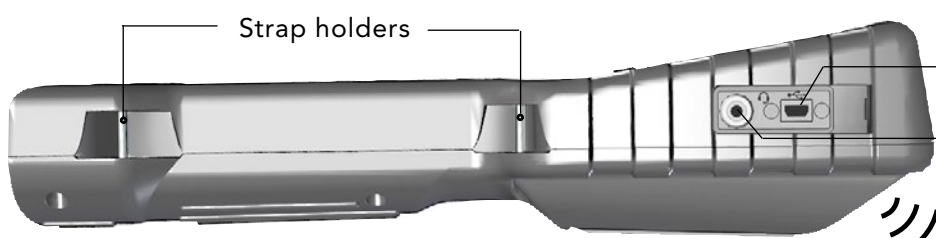

Strap holders

Communication port, mini USB

Headphones / headset, 3.5 mm stereo mini plug

Position of RF transponder for CondID memory tags



# Charge the battery pack

Leonova is powered by a rechargeable lithium-ion battery pack which is easily replaceable during measurement work. A warning for low battery comes up before the instrument turns off. No data is lost, all data is stored in the flash memory. Leonova has a built-in backup battery that lasts >15 years.

The battery pack in a new instrument has to be charged before use. To release the battery pack, lift and turn the locking screw (A), then pull out the battery pack from the instrument.

**NOTE:** It is recommended to charge the battery pack at least once a month. The reason for this is that the cells can not withstand being fully discharged completely.

## Battery Charger

The battery charger unit with AC adapter, CHA01/02/03/04, provides 9.3V/1.33A. The AC adapter is specified for 100 to 240 VAC, 50 to 60 Hz. Do not use any other type of charger or AC adapter.

Connect the AC adapter (100 - 240 V AC) to the charger unit (B) and place the battery pack in the charger unit.

The charger unit can also be connected to 12V power in a car via the car charger cable 93484.

A green LED on front of the charger indicates that power is connected. CHARGE (red LED) lights up during charging. READY (green LED) lights up when the battery is fully recharged.

A full recharge can take up to 4 hours. The maximum battery capacity is 5200 mAh. 'Power low' warning is given at 25%.

Measuring results are default stored in the flash memory and will not be erased if battery is low.

## Battery Adapter 16644

Leonova can be connected to 100 - 240 VAC via an optional battery adapter, SPM 16644, when using i.g. long time recording. Replace the battery pack in Leonova with the battery adapter and connect it to the AC adapter.

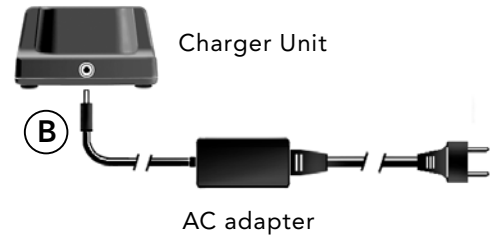

- POWER ●
- CHARGE ●
- READY ●

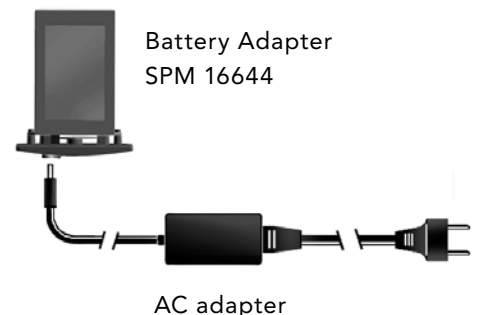
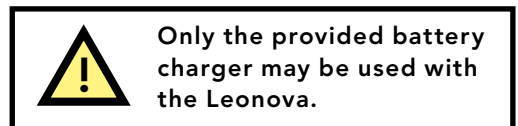

## Start / Check battery status

Leonova is started with the ON/OFF key. The display will shut down when not used within 10 minutes (default setting) and the Leonova goes to "sleep mode". By pressing the ON/OFF key the Leonova immediately will go to "sleep mode". To leave sleep mode and resume work in the last position, press the ON/OFF key.

**A** POWER OFF is automatic when not used within 30 minutes (default setting).

Times for "power off" and "sleep mode" can be changed under MENU 'Settings' (see later in this chapter).

A battery status icon is placed in the upper right corner.

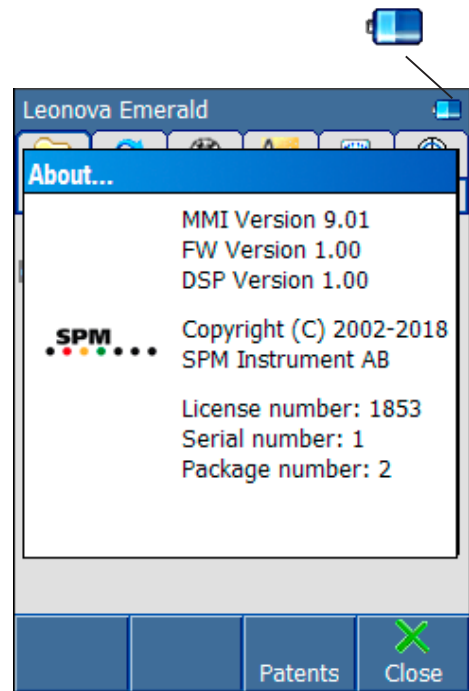

## About Leonova

The file 'About Leonova' contains important information on the software status.

The license number and serial number belongs to the instrument. All upgrades concerning program versions and functions are connected with it. The package number is a running number of update operations.

When ordering new functions, these are delivered as a text file 'Leonova.txt'. Each such order has a running package number and is individual for the instrument. The files can only be loaded in package order, see 'Leonova Service program'.

To open the 'About Leonova' file, press MENU, select 'About Leonova' (1) with UP/DOWN arrow keys and press ENTER.

Press BACK or ENTER to close the 'About' window.

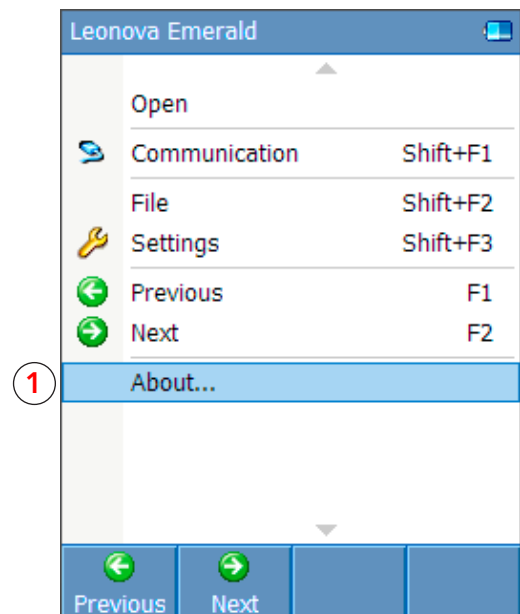
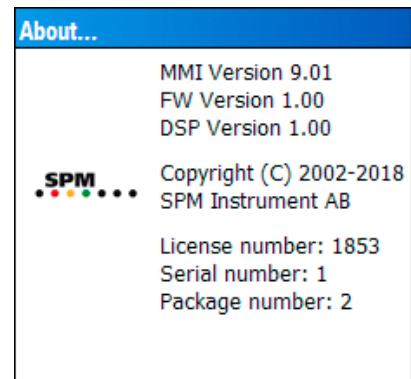

# Navigation

The Leonova main screen is divided into three areas:

- the menu bar (1)
- the display window (2)
- the function bar (3).

The function bar shows actions controlled by the function keys F1 to F4.

The functionality of the keys F1 to F4 can be changed to your personal settings (see next side).

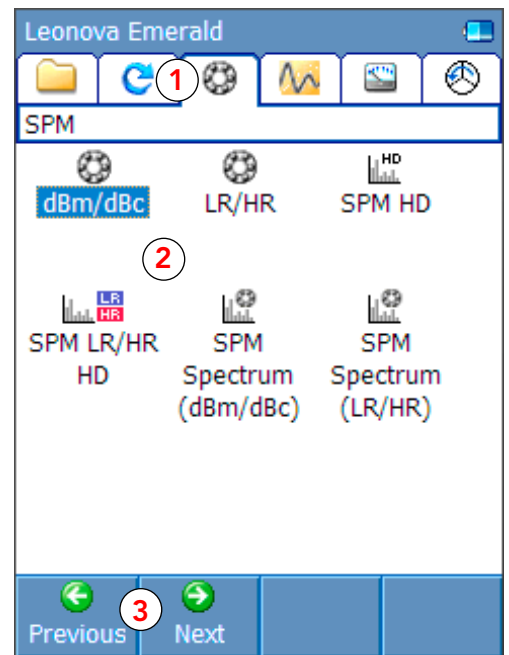

The navigation keys are:

- F1 to F4 are function keys used to select functions displayed on the screen above the keys. The functions change in various modes.
- MENU is used to access more functions and settings. The menu changes in various modes.
- M/S is used to start measurement and to save the result after measurement.
- The ARROW keys move within the display window or in a popup window.
- ENTER opens/activates a highlighted item. It also closes functions and confirms changes.
- BACK switches back to previous window.
- SHIFT is used to provide alternate functions in the function bar.

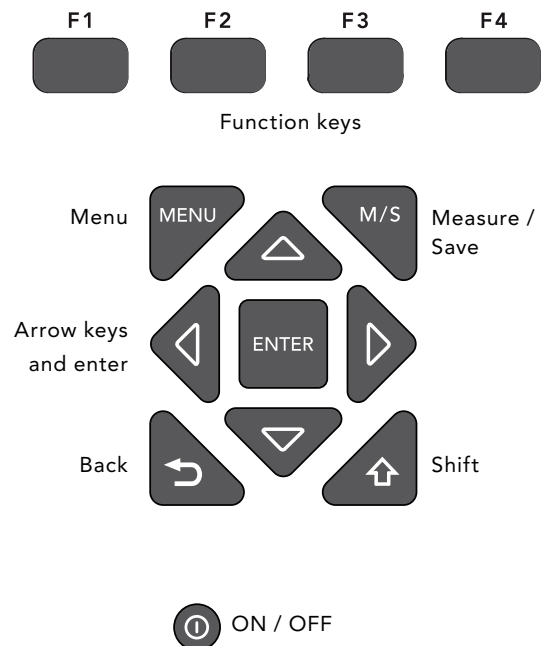

This is the general rule. Details are explained under the function description.

# Defining shortcut keys and menu options

The functionality of the keys F1 to F4 can be modified to personal shortcuts. These settings apply to all measurement modes.

- Open a measurement function and press MENU.
- Press the MENU key and hold down for 3 seconds to enter the 'Modify mode' (1).
- Mark a line in the list with UP/DOWN and open the shortcut key list (2) with F1.
- Select a suitable shortcut key in the list and press OK.

You can change order and make the options in the MENU window visible/unvisible and insert separators between them.

To make a menu option visible/unvisible, mark the option with UP/DOWN and press F2.

To move a menu option in the list, mark the line with UP/DOWN and press F3. Move the option with F1/F2.

Pressing MENU in the 'Modify menu' (1) will open a window (3) where you can place a separator between the menu options.

Select 'Undo changes' to return to the default instrument settings.

Pressing BACK switches back to previous window and will save your settings.

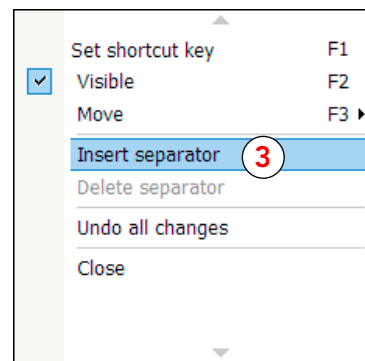
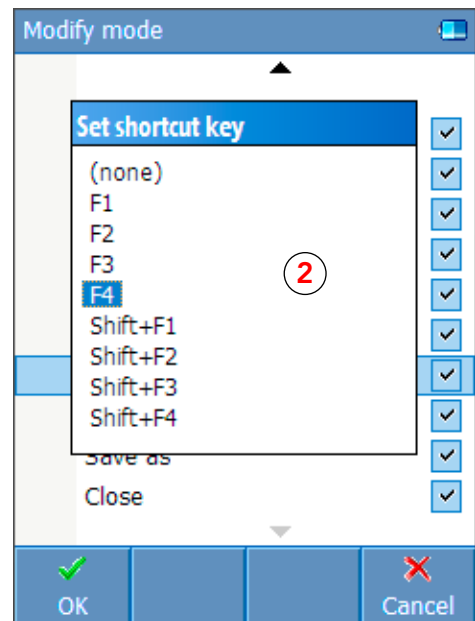
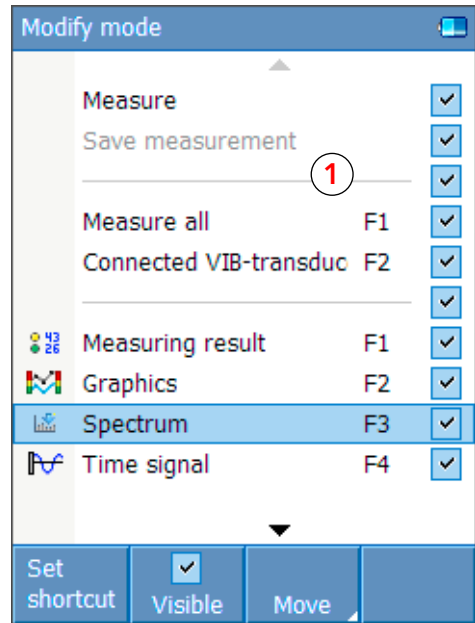

## Reset

In case of instrument malfunction, you should remove the battery pack to perform a hardware reset. This will erase all data in the RAM memory.

Do not open the instrument casing. Service on Leonova may only be carried out by specially trained personnel authorized by SPM.

## Instrument calibration

An instrument calibration, e. g. for the purpose of compliance with ISO quality standard requirements, is recommended once per year. The calibration is made at the Authorized Service Establishments.

The calibration reminder icon (1) in the upper right corner of the display shows when the Leonova is used for the recommended period and is to be sent to a by SPM authorized service establishment in your local area.

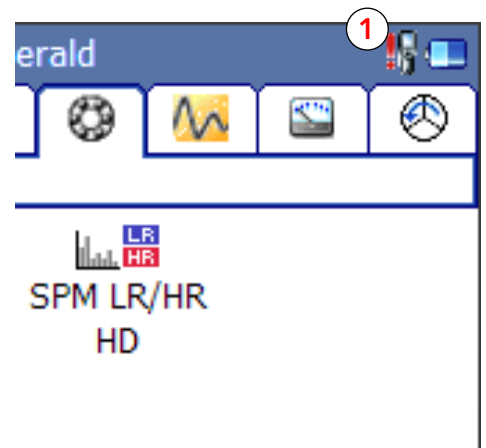

## Main functions

The menu bar at the top of the screen opens six display windows, each containing a number of files. Functions marked grey are not implemented in your Leonova version and can not be opened.

Navigate in the menu bar with F1 (previous) and F2 (next).

Select function in the display window with the ARROW keys and open with ENTER.

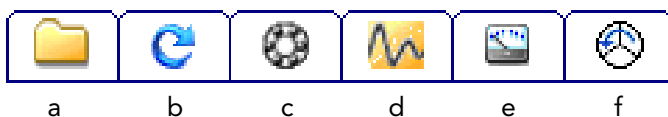

- a. FILE: Communication, measurement files saved by the user.
- b. RPM: RPM measurement.
- c. SPM: All shock pulse measurement techniques.
- d. VIBRATION: All vibration measurement techniques.
- e. USER DEFINED: Temperature measurement, User defined (manual input)
- f. BALANCING: Single plain rotor balancing.

## Instrument settings

The seven files in the 'Settings' window contain the general instrument settings. With a new Leonova, the first task is to check the available functions and to adjust the instrument.

Press SHIFT+F3 to open the instrument settings window, or press the MENU key and select 'Settings' with the UP/DOWN arrow keys. Open with ENTER.

In the 'Settings' window, select file with the UP/DOWN arrow keys, open with ENTER or F1.

When the appropriate settings are made, press the MENU key. Select 'Previous' or 'Next' with F1/F2 to make additional settings. Press the BACK key to save the instrument settings and quit settings mode.

These are the files:

- General settings, a menu for several functions.
  - Select units: the default is mm, °C, Hz.
  - dB mode: scale in dB for the y-scale in spectrum.
  - Icons: show large/small icons.
  - Layout: measuring point tree layout, preview live spectrum, show theoretical symptoms.
  - Automatic save: Prompt to save after measurement.
  - Balancing: select ounce, counter rotational degrees and output unit (ACC, VEL, DISP).
  - Screen: Adjust brightness.
  - Power saving: Adjust time for 'sleep mode' and automatic 'power off'.
- Date/time: Adjust when needed.
- Transducers: Register your transducer(s). Attention! All values must be taken from the transducer's calibration card.
- Language: Choose among available languages.
- Fonts: Select text presentation.
- Create default files: Creates the initial files needed to use the measuring functions.
- Function and use: Shows available functions.

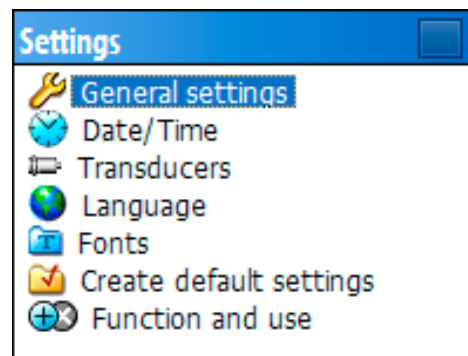
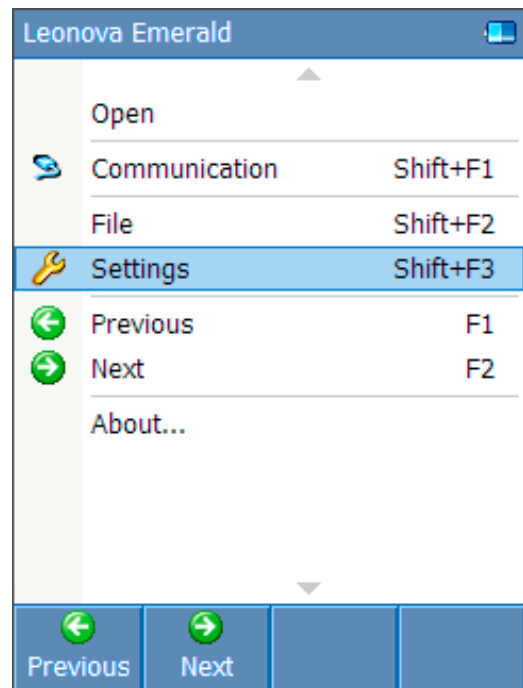

# General settings

The files under 'Settings' cannot be moved, re-named or deleted. Select with UP/DOWN arrow keys, open with ENTER.

'General settings' has its own menu bar (1).

Select tab (1) with F1/F2. Move in the list with the UP/DOWN arrow keys, mark/unmark with ENTER.



Marking the box (2) changes from mm to inch, acceleration in g, from °C to °F and from Hz (Hertz = cycles per second) to CPM (cycles per minute, similar to rpm). Marking a dB mode (3) will change the y-scale to decibell.

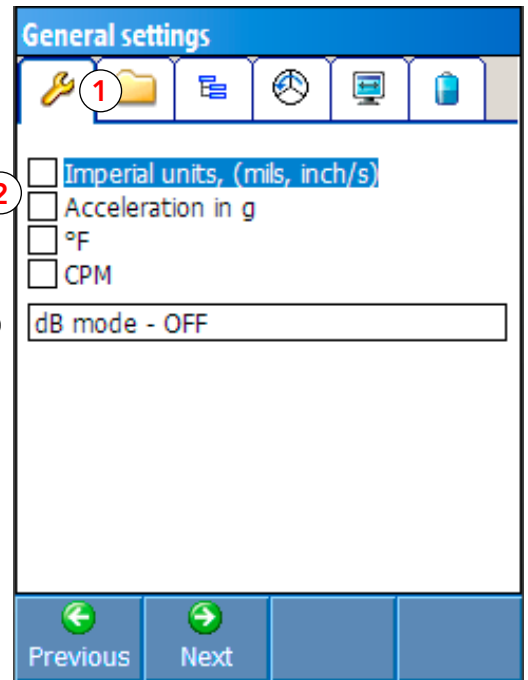
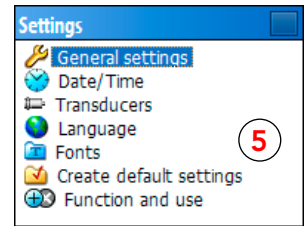
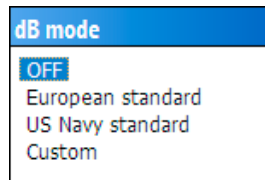

When 'Large icons' (4) is not marked, files are listed as shown above (5).

'Use temporary file' will save the round temporary while saving.

'Preview live spectrum' will show spectrum in real time.

'Low resolution warning' when the resolution is too low for an accurate result.

'Possible to determine rpm from spectrum' makes it possible to get the rpm by setting out a marker in the spectrum.

'Default FFT calculation for SPM HD' is normally selected. If turned off it affects all SPM HD and LR/HR HD assignments.

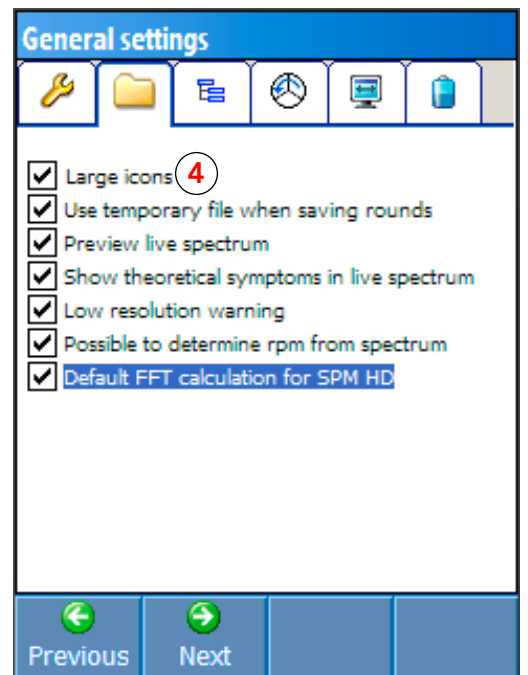



This selection (1) affects the measurement window.

'Measuring point name . .' repeats the name on a separate line.

Settings for the 'Measure All' function: Show 'Measure All' on separate line, show 'Measure All' information dialog and open summary view after 'Measure All' measurement.

'Display colours . .' displays the evaluation icon for each listed measuring technique.

'Automatic save . .' opens a 'Save yes - no' window immediately after a measurement.

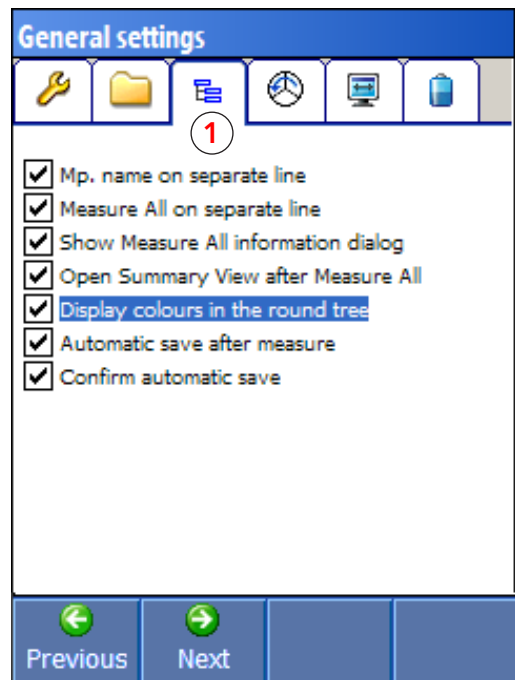

These selections concern 'Balancing'.

'Lagging Phase' means that the phase angle increase opposite to the direction of rotation (see *General settings* in the *Rotor Balancing* chapter for details).

'Ounce' changes weights from grams to ounces.

'Output unit', selected from a list (2), is the unit of the vibration measurement (acceleration, velocity or displacement).

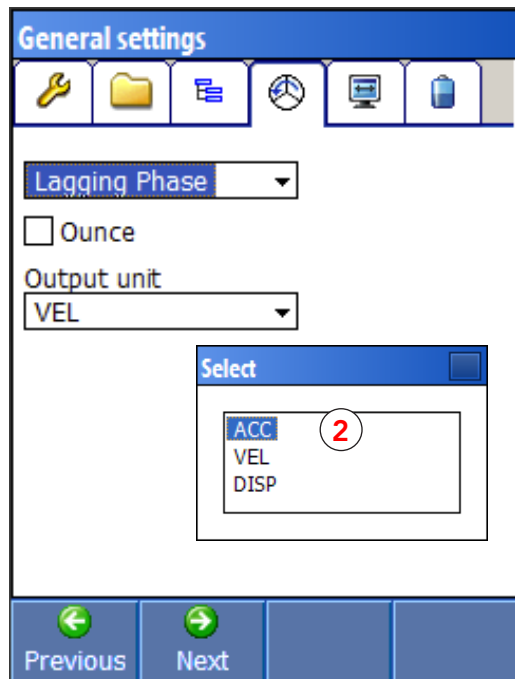





### Display setting.

You can change the backlight brightness (1). Increase or decrease with LEFT/RIGHT arrow keys.

You can name your instrument (2). The name appears when communicating with the computer. If you have not named the instrument the instrument serial number will be displayed.

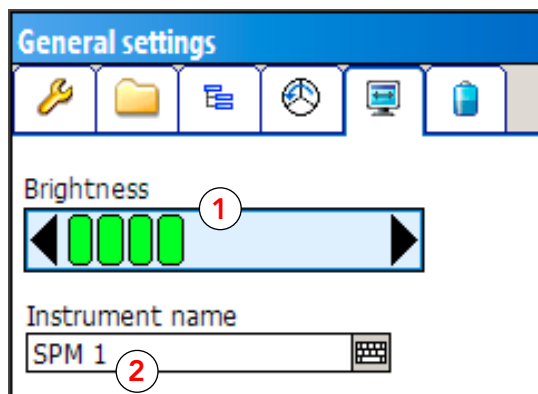

### Power saving.

You can adjust the time for 'sleep mode' (3). The display will shut down when not used within this setting. 'Power off' (4) will shut down the instrument completely when not used within this time.

Select with UP/DOWN and confirm with ENTER.

To disable the automatic power off, leave it blank (none). Remember to reset a value in order to turn off the instrument.

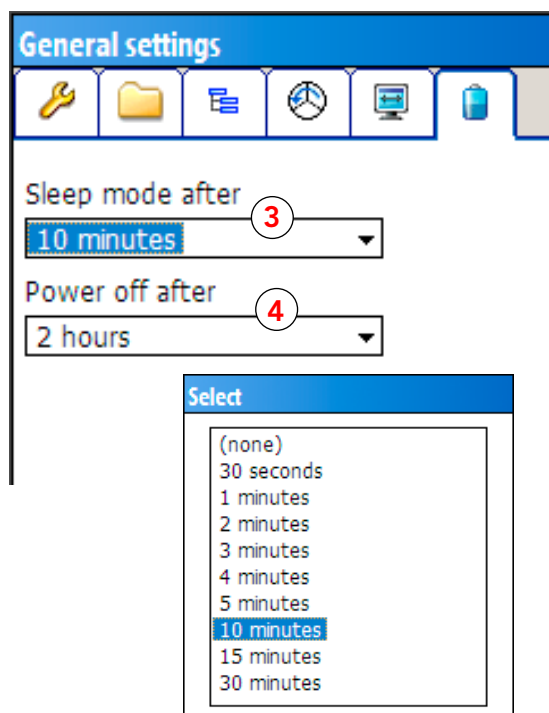

## Set date/time

Before measuring with Leonova, update the internal clock. The measurements time data is of great importance when transferred to Condmaster.

To make the update, open 'Date/Time' (4) under 'MENU/Settings'. Select the date field and press ENTER. Select month with F2/F3 and navigate with the arrow keys to select date (5). Press F1 to save.

To set the time (6), select the time field and press ENTER. Use LEFT/RIGHT arrow keys to change field and UP/DOWN to change value. Press F1 (OK) to save.

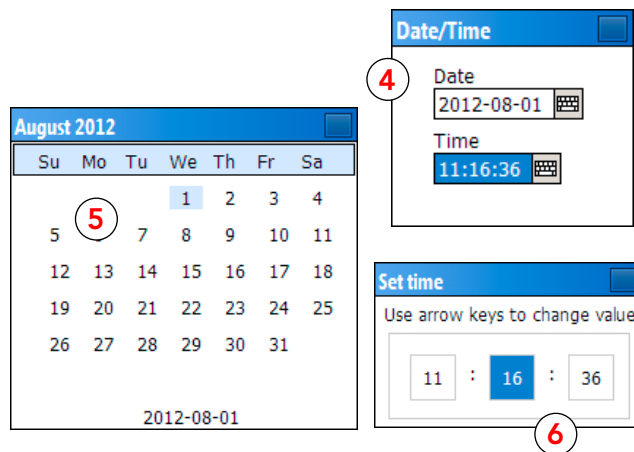

# Register transducers

Transducer type SPM 40000/42000/44000 is added automatically in the register and can not be edited or deleted. The instrument can also work with SPM DuoTech transducers and any other transducer of IEPE (integrated electronic piezoelectric) type with voltage output. Transducers of not IEPE type which do not require power supply, like velocimeters, can also be used. The 'IEPE type' has then to be set to 'No'.

To register a new transducer, open 'Settings' with SHIFT+F3. Select 'Transducers' (1) to open the register (2).

Select 'New' (3) with the F1 key, then input the following data. Press F1 to save the settings and close with the BACK key.

- Name: A descriptive name. It will be shown on the list of transducers.
- Input type: Type of transducer; vibration transducer, DuoTech or user defined. Setup of user defined (4), see page A:16.
- Type: The measured vibration parameter, either ACC (acceleration), VEL (velocity) or DISP (displacement).
- Sensitivity: The transducer's nominal sensitivity in the displayed unit (which depends on the input under 'Type'). Select 'User defined' (4) for other types of transducers, eg. current clamp.
- Max. frequency: The transducer's upper frequency range.
- IEPE type: YES or NO. 'Yes' opens the next three lines.
- Min. bias range: The lower working voltage.
- Max. bias range: The upper working voltage.
- Settling time: Stabilizing time for the transducer after 'power on'.

The min. and max. bias voltage (5) is needed for the TLQ test (Transducer Line Quality test, returning 'TLT error. Bias value out of range' when the measured voltage is above the max. bias voltage or below the min. bias voltage).

The actual sensitivity of the individual transducer is written on its calibration card. This data should always be input in the transducer register. When several transducers are in use, they should be marked to assure that the readings are calibrated.

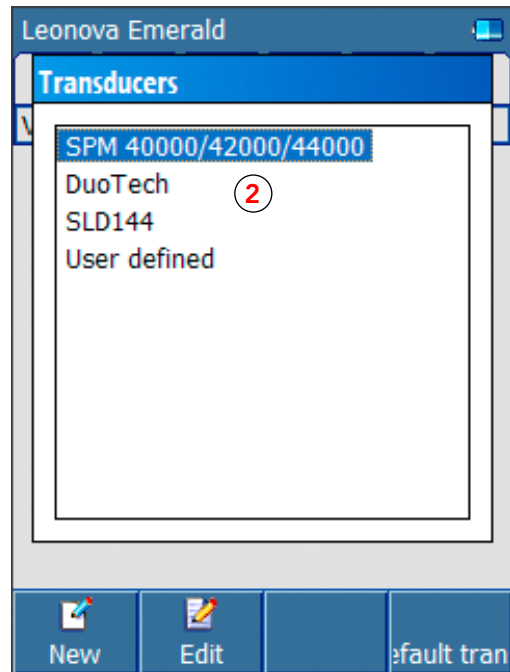
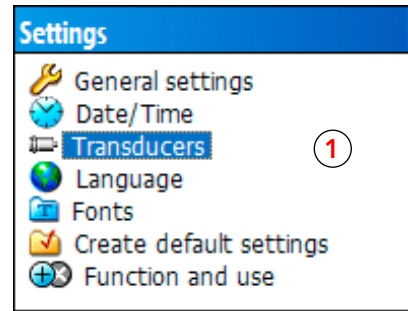

3

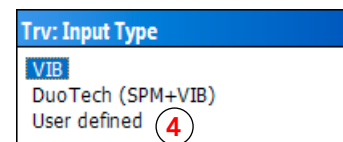
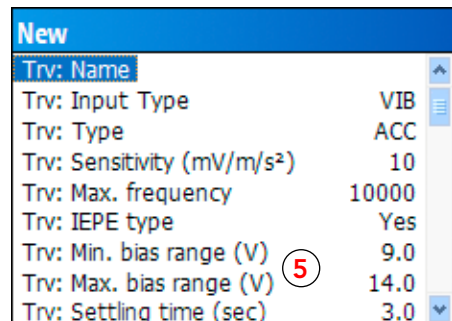

## Default transducers

Default transducers for shock pulse and vibration measuring techniques are set up via the transducer register. Default transducer is the active transducer when 'Portable' transducer is selected under 'Measuring point data'.

Press SHIFT+F3 to open 'Settings'. Select 'Transducers' and press F1 (OK) to open the transducer register (1).

Press F4 (2) to open the window 'Default transducers' (3). To select a default transducer for a measuring technique, mark a technique and press F1 (OK). Active transducer will be shown (4).

To change transducer, press ENTER to open the list of registered transducers (5). Mark a name on the list and press F1 (OK) to confirm. The new transducer is shown in the window (4). Press F1 (OK) to confirm and close with the BACK key.

To select default transducers for the balancing function, mark 'Balancing' in the window 'Default transducers' (3). Press ENTER and register the transducer (6) to be used.

To see or edit transducer data, mark its name in the transducer register (1) and press F2 'Edit' (7). You can edit the transducer's data and change the transducer name. Mark a line in the register with the arrow keys, open the keyboard with ENTER and edit the data. Press F1 to save the settings and close with the BACK key.

When standing in a measuring round, you can press SHIFT+F4 to jump to the default transducer setting which can be useful if you need to change default transducer for a measuring point.

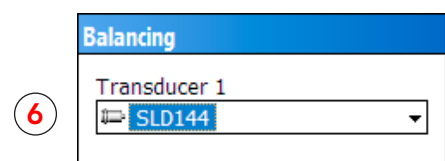
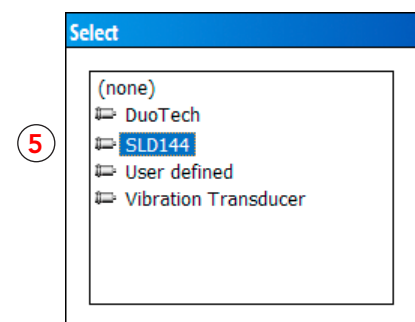
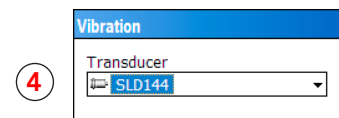
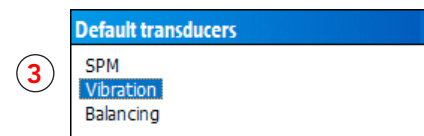
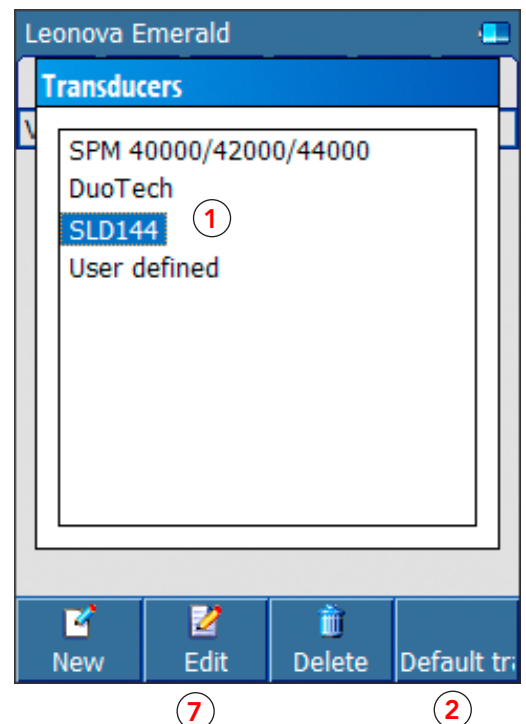

# User defined transducers

Other types than vibration transducers can be used, e.g. amp clamp, pressure and flow sensors, that connects to the VIB input. These are set up in the transducer register as 'User defined' transducers.

To register a user defined transducer, open 'Settings' with SHIFT+F3. Select 'Transducers' to open the register (1).

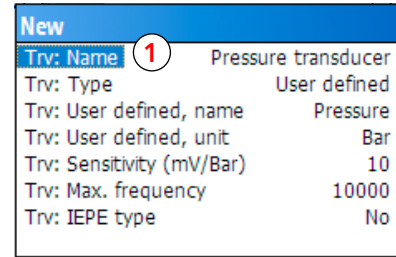

Select 'New' with the F1 key, then input the following data:

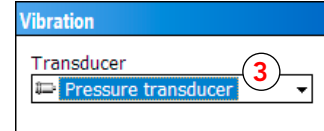
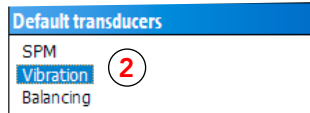

Name: A descriptive name. It will be shown on the list of transducers.

Type: Select 'User defined'.

User defined, name: The measured parameter.

User defined, unit: The measured unit.

Sensitivity: The transducer's nominal sensitivity in mV/measured unit.

IEPE type: Select 'No'.

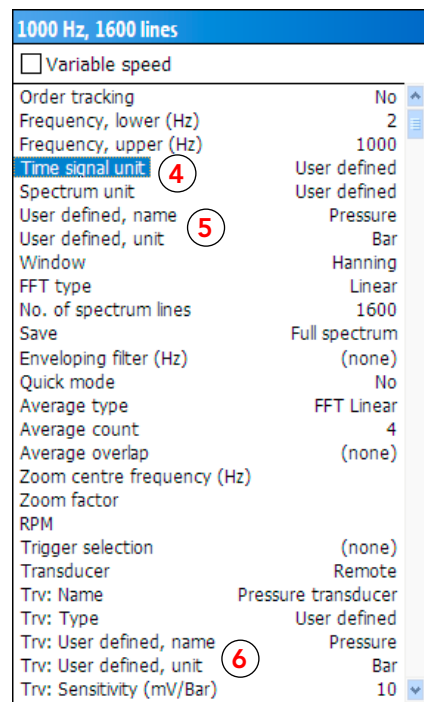

Press F1 to save the settings and close with the BACK key.

To select the 'User defined' transducer as default transducer, press F4 and select 'Vibration' (2). Press ENTER and select 'Pressure transducer', as in the example (3).

For EVAM assignments, both 'Time signal unit' and 'Spectrum unit' have to be set to "User defined" (4).

**Note!** When 'Time signal unit' is set to 'User defined', the "User defined, name" and "User defined, unit" must be exactly the same as the corresponding parameters for the transducer in order to be able to perform a measurement. In the example beside, the name "Pressure" and the unit "Bar" (5) are the same as for the transducer (6).

To edit the transducer data, press F3 to open the transducer register.

When using a 'User defined' transducer the 'RMS', 'Peak' and 'Peak to peak' values are shown in the result window (7). The graphs are displayed in the selected units.

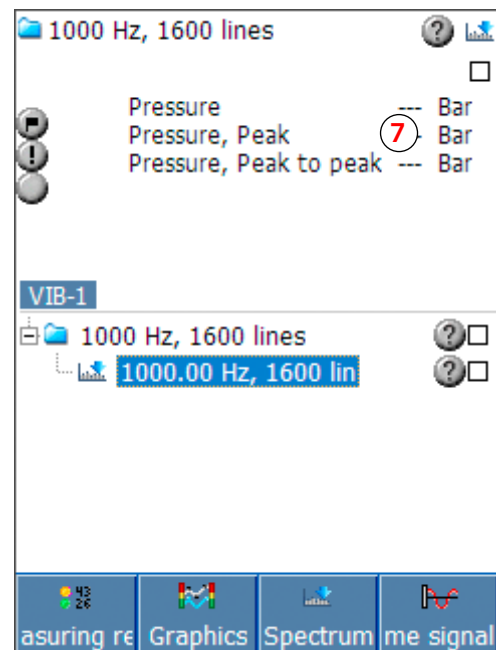

A

## Edit text and numbers

Change TAB (1) = SHIFT + LEFT/RIGHT

Change character line (2) = UP/DOWN

Capitals = hold down SHIFT

Delete = press F4

Confirm = press ENTER

Select tab (1) with SHIFT + LEFT/RIGHT arrow keys. The tabs corresponds to a set of numbers or alphabetical letters.

Navigate to the desired character line (2) with UP/DOWN arrow keys.

Press F1-F3 a number of times to obtain the desired character, one by one. Pressing a function key will type out the first character that it corresponds with (e.g., F1 accesses 'abc', so pressing the F1 key once will type out an 'a'). To type a 'b' or 'c', you have to press the F1 key twice quickly or three times quickly, respectively.

To obtain capital letters, hold down the SHIFT key.

Navigate in the input field (3) with LEFT/RIGHT arrow keys. You can delete character with F4. To finish, press ENTER.

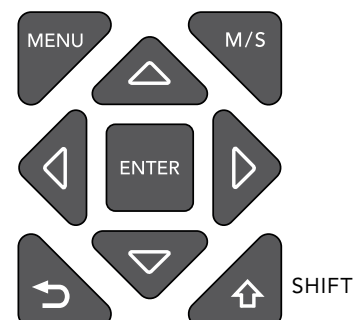
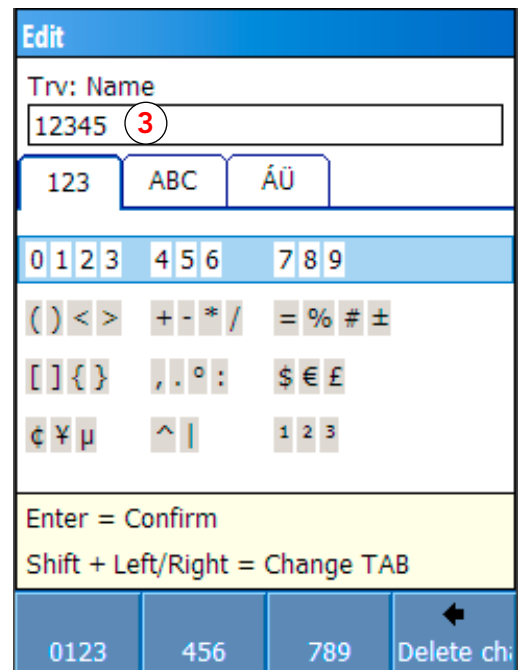
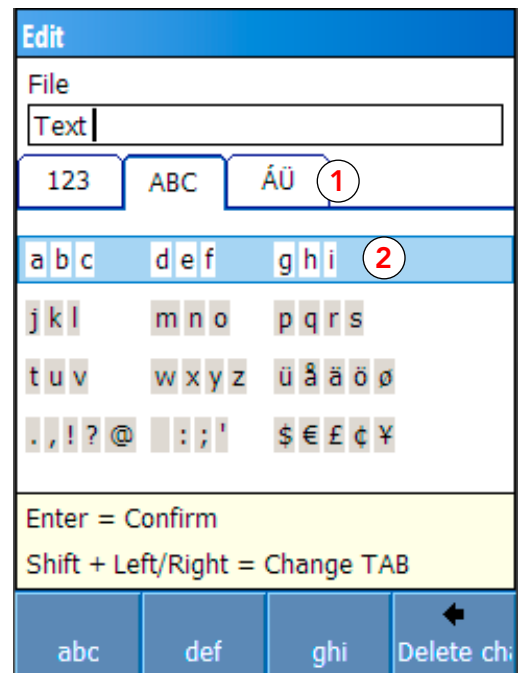

## Select language

The file 'Language' under 'MENU/Settings' allows you to choose Leonova screen language (1). To change to another language, change with UP/DOWN arrow keys and select with F1. Press OK (F1) or ENTER to restart the instrument with the new language.

English is always included. If an additional language is desired, please contact your local SPM representative.

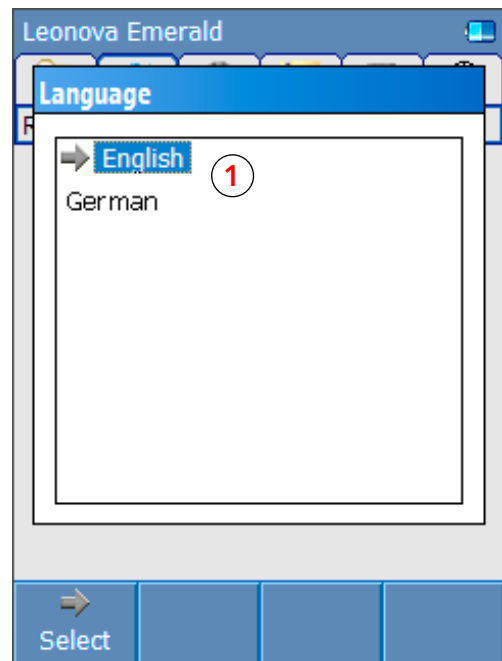

## Change font, size and style

The 'Fonts' menu under 'MENU/Settings' allows you to make individual changes of font, style and size for any of the listed alternatives (2).

When showing file names, Leonova uses the largest text that fits into the available space, going from 'Normal' (16 points) via 'Medium' (14 points) to 'Small' (12 points). Thus, if you have difficulties reading 'Small' text, you can change the text size of 'Small' from 12 to 14 points.

Leonova will truncate file names that are too large to fit on one line. Using several words or hyphens in the name will put it on two or more lines.

Marking an item on the list and pressing F1 (Edit) opens the window (3) where you can set character size and/or select another font (4) for the item. Mark the font name, press ENTER to open the font list (5). Please note that this will not affect the other items.

Press MENU and select 'Close' to save settings. 'Reset fonts to factory default' (6) will reset all items to default values.

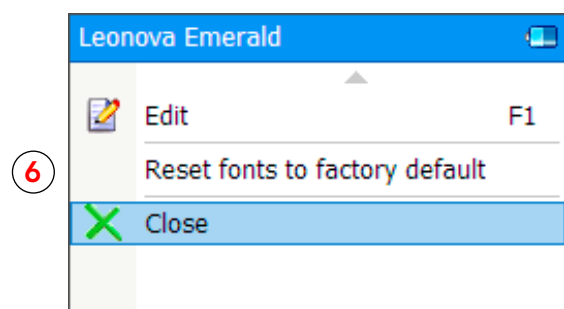
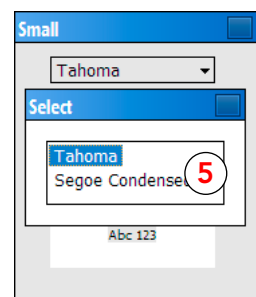
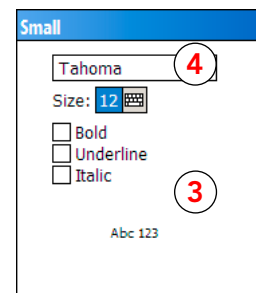
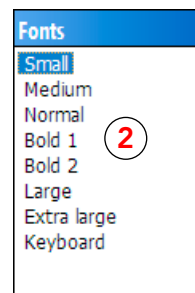

## Create measurement files

The file 'Create default settings' (1) under 'Settings' is very important. It creates measurement files for all measuring techniques and places them under the measuring technique windows. You cannot use Leonova as a stand-alone measuring instrument without these files.

The installation is simple: Press MENU and open 'Settings'. Select 'Create default settings' and press F1 (OK).

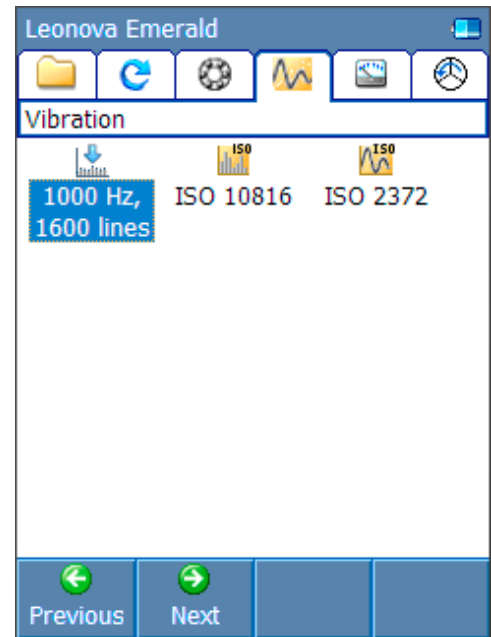
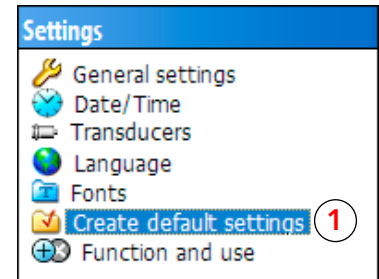

The example shows the measurement files created in the vibration technique window: a file for vibration '1000Hz/1600 lines' and a file each for vibration measurement according to ISO 10816 and ISO 2372.



## Function and use

Leonova has a number of 'platform' functions which are always available. Other functions are user selectable and can be bought in retrospect when needed.

'Function and use' under 'MENU/Settings' shows a list of all functions (2), each followed by an icon showing its status:

-  Available functions.
-  Not available in this instrument.

Loaded measuring rounds are shown at the bottom of the list.

The loading of new functions is described under 'Leonova service program'.

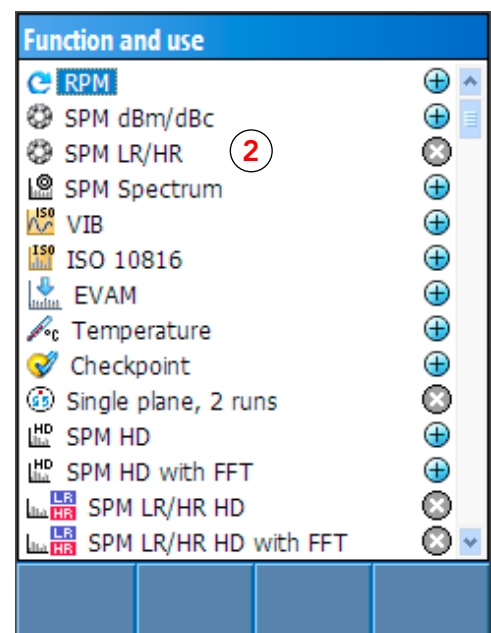

# Order functions

After buying Leonova Emerald, optional functions can be ordered from your SPM supplier.

You will receive the text file **Leonova.txt**. It is coded to the instrument's license and also contains a running package number. The files have to be loaded in package number order.

Connect Leonova to the PC and use 'Load function to instrument' to transfer the file contents.

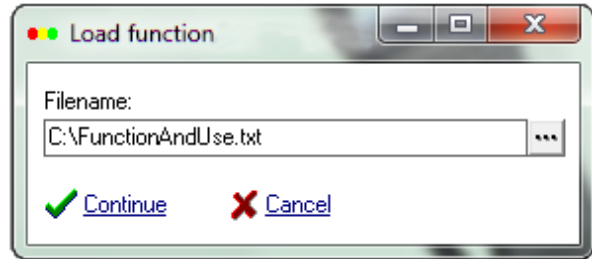

A

## Platform functions (always included)

- SPM HDm/HDc and/or SPM LR/HR
- 1 channel vibration
- RMS vibration , ISO 2372
- Speed measurement
- Temperature measurement
- Stethoscope function
- Measuring point identification using CondID® memory tags
- Recording
- Manual recording, free quantity
- Check points, free text
- Recording of vocal comments

## Optional functions

- EME195** SPM HD Expert, frequency and time domain analysis
- EME197** Shock pulse method HDm/HDc
- EME130** Shock pulse method dBm/dBc
- EME131** Shock pulse method LR/HR
- EME132** SPM Spectrum
- EME133** Vibration ISO 10816 with spectrum
- EME134** Vibration Premium, including:
  - HD ENV
  - FFT spectrum with symptoms
  - 6400 lines, 10 kHz
  - HD Order tracking
  - Time signal
  - Post trigger
- EME193** Vibration Supreme, including:
  - HD ENV
  - EVAM evaluated vibration analysis
  - 12800 lines, 20 kHz
  - HD Order tracking
  - Time signal
  - Post trigger
- EME140** HD Analysis
  - Vibration Supreme
  - SPM HD Expert
- EME109** Balancing, single plane



## Maintenance and repair

Replacement of the protection foil, wrist wrap and and exchange of battery pack are the only repair actions allowed. All other repair actions are not allowed. Send the instrument to a by SPM authorized service establishment in your local area.

To clean the external surfaces of the product, wipe the casing with a damp cloth and mild detergent.

## Replacement of Protection foil 16686

1. Wash your hands thoroughly before applying the film. Clean the Leonova carefully from dust and grease.
2. Spray the tips of your fingers before handling the protection foil, in order to avoid leaving fingerprints. Separate the foil from its backing.
3. Hold up the protection foil with the sticky side pointing upwards.
4. Spray liberally on the sticky side and lightly on the top side of the foil. Run a moist finger over the sticky side, and spread the liquid evenly over the entire surface.
5. Apply the protection foil to the instrument with the sticky side down and drag the protection foil into the right position.
6. Use the plastic squeegee to remove possible bubbles and moisture, work outwards from the middle. It is advisable to hold the foil in place with a finger while doing this so that it doesn't move.
7. Dry off any excess moisture with a cloth. Small bubbles and unevenness will disappear of their own accord within a few days.
8. Let the protection foil dry 12 hour before use.

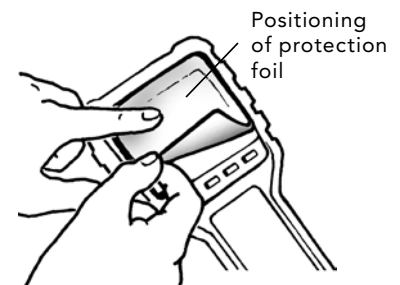

## Procedure for replacing or moving wrist strap

The wrist strap is easily loosened by unbutton the handle, then loosen the Velcro in the end of the strap. Loosen the strap from the metal buckle at the other end. Install the wrist strap in the opposite manner and adjust the strap length by moving the metal buckle.

## Communication with the PC

Leonova connects to the PC via the USB cable CAB94. Leonova communicates with

- Leonova Service Program.
- Condmaster®Ruby

Place both programs into the same folder on your PC.

To start communication, press SHIFT+F1 to open the communication mode, or select 'Communication' (3) under the 'File' menu and press ENTER.

Connect the USB cable between instrument and computer. Control the communication from the computer. Press F4 (Close) to exit the communication mode.

On the PC, open 'Data transfer' or 'Planning' in Condmaster.

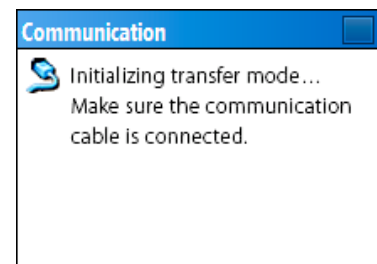
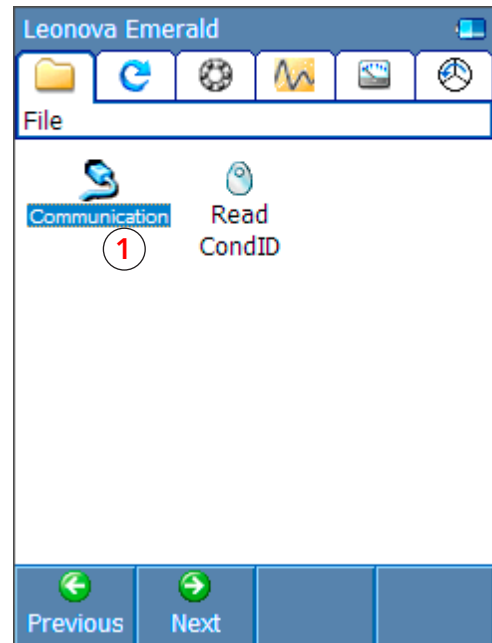

## Leonova service program

The Service Program is used to

- print and save balancing reports.
- load additional functions from the file 'Leonova.txt'.
- check for updates of Leonova Service Program. This function requires that your computer is connected to the Internet. Shows version info, available and current versions.
- upgrade the Leonova software from the file 'LeonovaDiamondAndEmerald.swp'.
- transfer language files from file '\*.llf'.
- upload and download Leonova files to/from the PC (file extension .LRF).
- make and reload safety copies of the Leonova files (file extension .lsc).

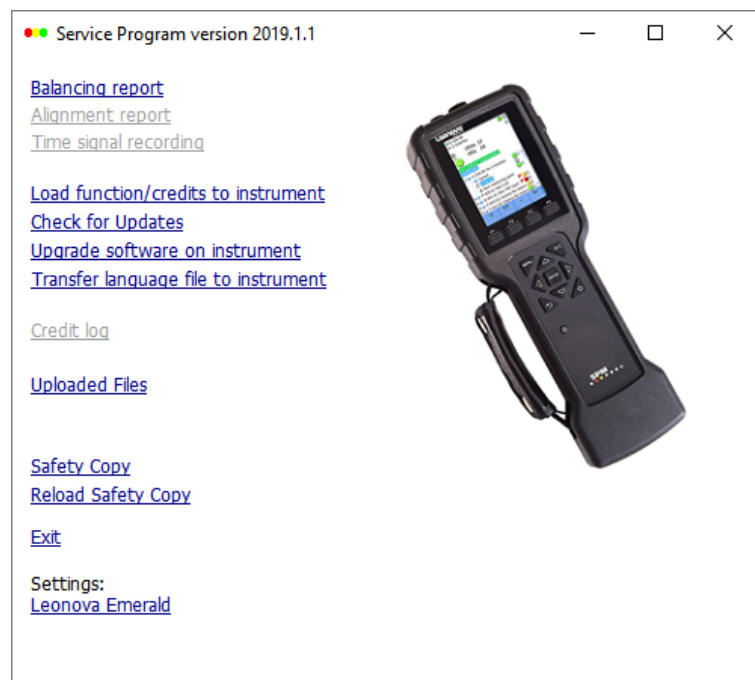

# Upgrade Leonova software

**IMPORTANT!** Always upgrade the Service Program and Condmaster to the latest version when upgrading the Leonova MMI software. It is critical that the software are in sync with each other. The Service program version numbers will always follow Condmaster version numbers and the two will always be released together.

The latest versions of the Service Program and Leonova MMI software can be downloaded from the SPM homepage:

- [www.spminstrument.com](http://www.spminstrument.com)

Under 'Downloads', open 'SPM Software', and 'Leonova Diamond/Emerald'. Download the file 'LeonovaDiamondAndEmerald.swp' to your PC.

To upgrade the Leonova software,

- Open 'Communication' on the instrument.
- Connect Leonova to the PC.
- Start the Leonova Service program on the PC.
- Select 'Upgrade software on instrument'.
- Input the path to the file 'LeonovaDiamondAndEmerald.swp' and click CONTINUE.

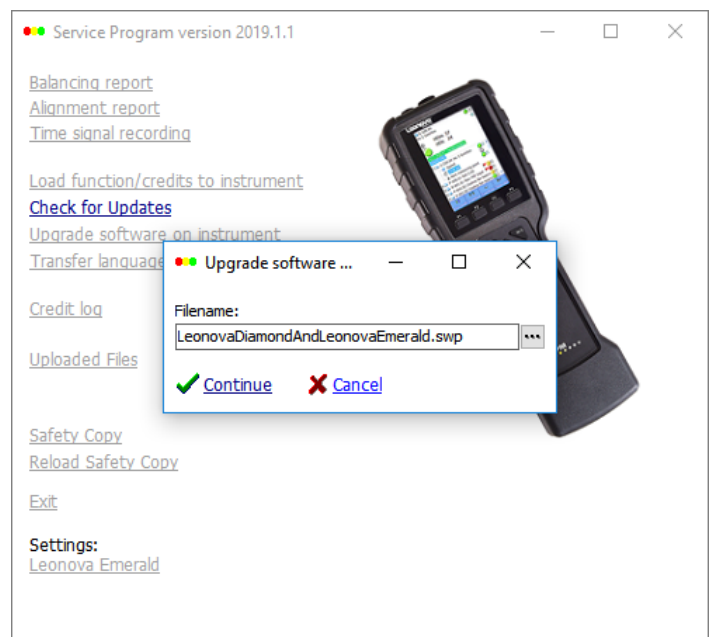

To load a new or updated language file, select 'Transfer language file to instrument'.

Language files translated for an older software version may cause some text elements in the program to fall back to english language. Please contact your local SPM representative for an updated language file (\*.lff).

# Safety copies of Leonova files

The Leonova Service program is also used to make safety copies of all measurement files saved in Leonova, and to reload these files to Leonova when needed. Leonova safety copies must have the extension 'lsc'; the rest of the file name is your choice.

A

To make a safety copy,

- Connect Leonova to the PC.
- Open 'Communication' on the instrument.
- Start the Leonova Service program on the PC.
- Select 'Safety copy', click CONTINUE.
- Select a folder on your PC, e.g. your Condmaster folder, and click SAVE.

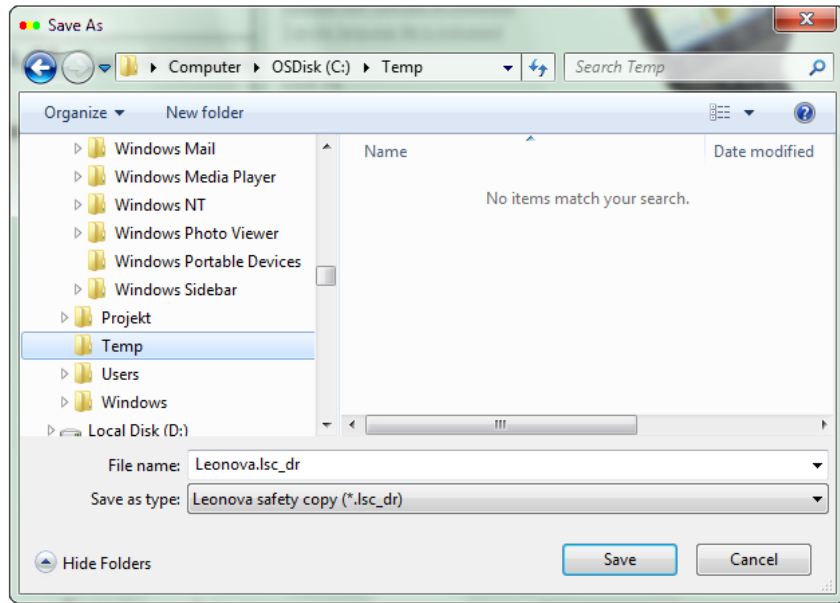

When reloading from a safety copy, there are two alternatives, all files or a single file. The single file option can be used to transfer a measurement file from one Leonova to another, and from there to Condmaster.

Select 'View file information' to see instrument data, licenses, etc. Select 'View log file' to see the instrument's log file.

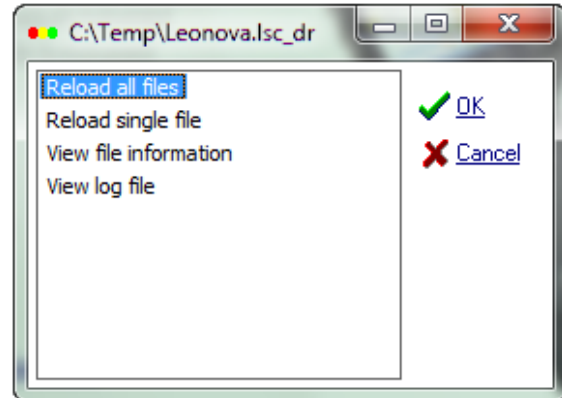

## Reload safety copies of Leonova files

To reload a safety copy,

- Connect Leonova to the PC.
- Open 'Communication' on the instrument.
- Start the Leonova Service program on the PC.
- Select 'Reload safety copy'.
- Select the file to be loaded, click OPEN.
- Select 'Reload all files' or 'Reload single file'. 'All files' will erase the present files on Leonova. Continue with YES when you get the warning. For 'Single file' you get a file list where you make your selection and click OK.

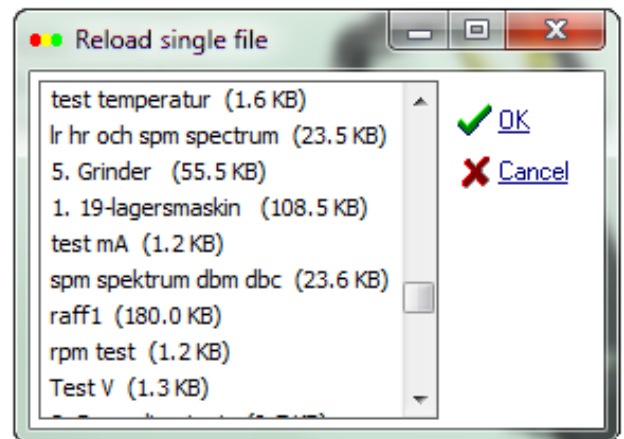
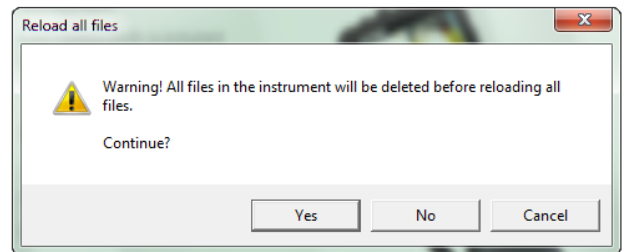

## Upload and download files to PC

Files are uploaded/downloaded to PC usually when Condmaster not is available.

To upload a file from Leonova;

- Connect Leonova to the PC and set the instrument in 'Communication' mode.
- Start the Service Program on the PC.
- Select 'Uploaded Files' and press 'Upload From Instrument'.
- Mark a file in the 'Select Round File' window and press OK to transfer the file (.LRF) to the PC.
- You can organize the uploaded files by moving them into folders.
- Press 'Windows Explorer' or 'Copy File To Clipboard' to make a copy of the file.
- To download a file to Leonova, select file and press 'Download To Instrument'.

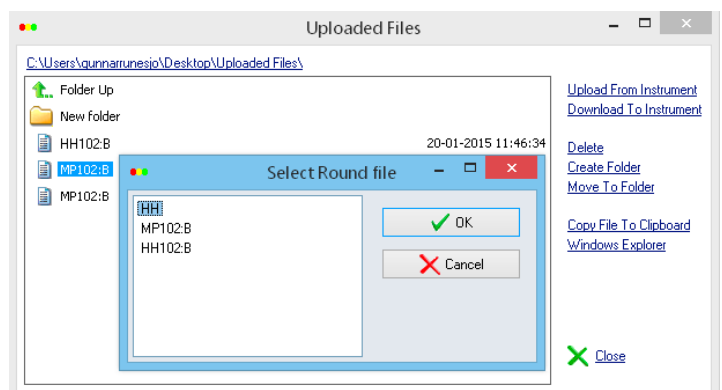

# File management in Leonova

The 'File' menu contains all user created measurement files, with one exception. The file 'Communication' (1) is a system file which cannot be renamed or deleted.

The default files for single measurement functions remain on their function menu unless you save them as a user created file under another name. This puts them as new files (2) onto the 'File' menu.

Files downloaded from Condmaster also get onto the 'File' menu. They are marked with a 'measuring round' icon (3).







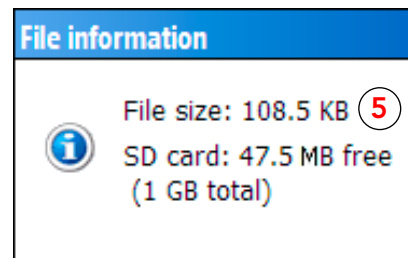
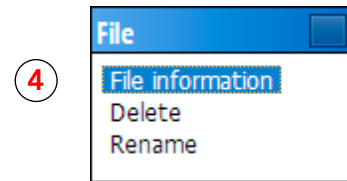
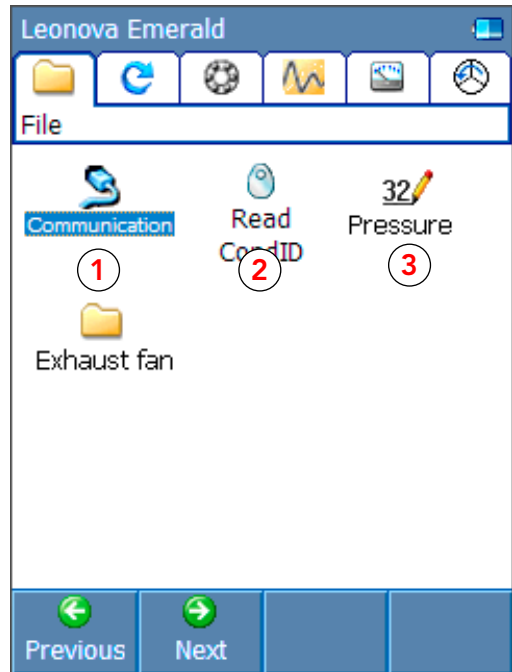







To open a file, select the file with the arrow keys and press ENTER.

For file management, mark the file and press SHIFT+F2. This opens a menu from where you can delete or rename the marked file and see the file information (4). Select 'File information'. Press ENTER to open the info window.

All user created files are stored on Leonova's built-in SD card. 'File information' allows you to check the file size (5) and free memory on the SD card.



## List of icons

	1. Go to main function FILE. 2. A file, e.g. a measuring round.		HD ENV measurement.
	1. Go to main function SPEED. 2. A speed measurement.		SPM HD measurement.
	1. Go to main function SPM. 2. SPM dBm/dBc and LR/HR measurement.		SPM LR/HR HD measurement.
	Go to main function VIBRATION.		SPM Spectrum measurement.
	Go to main function USER DEFINED.		Transducer Line Test.
	Go to main function BALANCING.		Vibration measurement, EVAM/FFT.
	Go to instrument SETTINGS.		Show measuring point data.
	Language selection for Leonova screen texts.		Browse through measurements.
	Transducer register.		Show measuring results.
	Open default files for measuring techniques.		Show measuring result diagram.
	Available functions.		Show spectrum.
	Set display brightness.		Show time record.
	Set time for sleep mode and power off.		Good condition (green).
	Communication with PC.		Condition warning (yellow).
	CondID measuring point identification.		Bad condition (red).
	Create new.		Good condition, but above alarm limit.
	Edit.		Condition not evaluated.
	Keyboard for input of text and numbers.		Alarm limit exceeded.
	Manual input of measuring results.		Measurement completed.
	Vibration measurement, ISO 10816.		Earphone connected. Change volume.
	Vibration measurement, ISO 2372.		Balancing, single plane, 2 runs and 4 runs.
	Quick mode.		Calibration reminder.
	Component.		Information.
	Measuring point.		

# Technical specifications

## Instrument, general

Housing:	ABS/PC/TPE
Protection class:	IP65
Dimensions:	306 x 108 x 71 mm (12.4" x 4.3" x 2.8")
Weight:	860 g (30.3 oz.)
Keypad:	sealed, snap action
Display:	TFT colour, 240x320 pixels, 3.5 inch, adjustable backlight
Main processor:	400 MHz ARM®
Memory:	256 MB RAM, 512 MB Flash
SD memory card:	1 GB
Operating system:	Microsoft Windows® CE
DSP processor:	375 MHz floating point
Dynamic range:	up to 120 dB, 24 bit A/D converter
Communication:	USB 2.0
Input channels:	1 x VIB, 1 x SPM, 1 x rpm, 1 x temperature
Input/output, headset:	3.5 mm stereo plug
Input/output, communication:	Mini USB
Power supply:	rechargeable Lithium-Ion battery pack 5200 mAh or power adapter
Battery power:	for min. 18 hours normal use (at 20°C)
Charge time:	< 4 hours
Operating temperature:	-20 to 55 °C (-4 to 122 °F) non condensing
Charging temperature:	0 to 45 °C (32 to 113 °F)
General features:	language selection, customized view, voice recording, battery status indication, transducer line test, metric or imperial units
Meas. point identification:	NFC transponder for communication with CondiD™ tags, read distance max. 50 mm (2 inch)

## SPM input

Shock pulse channels:	1
Measuring techniques:	SPM HD, dBm/dBc, LR/HR and LR/HR HD
Transducer line test:	TLQ test
Transducer types:	SPM 40000, 42000, 44000, probe transducer and quick con- nector transducer

## VIB input

Vibration channels:	1
Frequency range:	0 (DC) to 20 kHz
Resolution:	max. 12 800 lines
Transducer line test:	bias voltage check
Transducer types:	SPM SLD or IEPE* (ICP) type with voltage output < 24 Vpp, or DuoTech accelerometer. Trans- ducer supply of 2.5 mA can be set On/Off
User defined transd.:	e.g. current clamp, pressure and flow sensors with voltage output
Measuring techniques:	ISO 2372, ISO 10816, FFT with symptoms, EVAM vibration analysis, HD Enveloping, balancing

## RPM input

Channels:	1, RPM or temperature
Measuring range:	1 to 150 000 pulses/min.
Resolution:	1 pulse
Accuracy:	± (1 pulse + 0.1% of reading)
Transducer type:	SPM TTP10, TTL-pulses, Key phasor®, proximity switch NPN/PNP
Output:	TTL signal for controlling stroboscope and 12 VDC supply

## Temperature measurement

Temp. range (TTP10):	-20 to 300 °C (-4 to 572 °F)
Accuracy (TTP10):	± 2.5 °C
Transducer type:	SPM TTP10

## Stethoscope

Settings:	Filter, volume and gain
Transducer types:	Shock pulse and vibration transducers





### Shock pulse method SPM HDm/HDc

Measuring range:	-30 to 110 dBsv (with transducer type 44000)
Resolution:	0.2 dB
Accuracy:	± 1 dB
Input data:	rpm, plus bearing type and shaft diameter (or ISO bearing number)
Output quantity:	maximum value HDm, carpet value HDc, evaluated green/yellow/red

### Shock pulse method SPM HD Expert

Additional function to:	HDm/HDc, LR/HR
Output quantity:	Time signal HD, SPM HD Spectrum, HD Order tracking
Spectrum lines:	400, 800, 1600, 3200, 6400, 12800
Measuring time:	1 to 10000 rev (default same as FFT)
Symptom enhancement factor:	Off, 1-10 (Default = off)
Symptom recognition:	bearing frequencies and optional patterns highlighted in the spectrum. Automatic config.of bearing symptoms linked to ISO bearing no.

### Shock pulse method dBm/dBc

Measuring range:	-9 to 99 dBsv
Resolution:	1 dB
Accuracy:	± 1 dB
Measuring time:	1,5 sek
Input data:	rpm, shaft diameter (or ISO bearing number)
Output:	maximum value dBm, carpet value dBc, evaluated green - yellow - red, peak value, audible shock pulse signal (earphones).

### Shock pulse method LR/HR

Measuring range:	-19 to 99 dBsv
Resolution:	1 dB
Accuracy:	± 1 dB
Measuring time:	1,5 sek
Input data:	rpm, plus bearing type and mean diameter (or ISO bearing number)
Output:	LR and HR (raw shock values), CODE A to D, evaluated green-yellow -red. LUB no. for oil film condition, COND no. for surface condition.

### SPM Spectrum

Additional function to:	dBm/dBc, LR/HR
Frequency range:	0 to 20 000 Hz, order tracking
Spectrum lines:	400, 800, 1600, 3200, 6400, 12800
Meas. windows:	Rectangle, Hanning, Hamming, Flat Top
Spectrum types displayed:	linear, power
Averages:	FFT linear, FFT peak-hold
Frequency units:	Hz, CPM, orders
Saving options for spectrum:	full spectrum, peaks only
Amplitude unit:	S <sub>D</sub> (Shock Distribution), S <sub>L</sub> (Shock Level)
Scaling:	linear or logarithmic X and Y axis
Zoom:	true FFT zoom, visual zoom
Symptom recognition:	bearing frequencies and optional patterns highlighted in the spectrum. Automatic config.of bearing symptoms linked to ISO bearing no.

## Vibration severity ISO 2372

Measurement quantities:	velocity, RMS value in mm/s over 10 to 1000 Hz
Evaluation table selection:	menu guided, ISO 2372
Transducer line test:	bias voltage test

## Vibration severity ISO 10816 with spectrum

Measurement quantity:	velocity, acceleration, and displacement according to individual parts in the standard
Spectrum,	linear, 1600 lines, Hanning window.
Quick mode:	yes (can be set ON/OFF)
Transducer line test:	bias voltage test

## HD ENV

Spectrum lines, frequency and envelope filter limits are regulated by what is included in the vibration package.

Frequency limit, upper:	stated in orders
Envelope high pass filters:	100, 200, 500, 1000, 2000, 5000, 10 000 Hz
Envelope band pass filters:	Filter 1 = 5 -100 Hz Filter 2 = 50 -1000 Hz Filter 3 = 500 -10 000 Hz Filter 4 = 5000 - 40 000 Hz*
Averages:	Time synch
Spectrum lines:	400, 800, 1600, 3200, 6400, 12800
Frequency units:	Hz, CPM, orders
Saving options:	full spectrum, time signal and FFT, condition parameters

## Vibration analysis, EVAM/FFT with symptoms

Frequency limit, lower:	0 (DC) to 200 Hz
Frequency limit, upper:	8 to 20 000Hz (EVAM) 8 to 10 000 Hz (FFT) order tracking
Envelope high pass filters:	100, 200, 500, 1000, 2000, 5000, 10 000 Hz
Envelope band pass filters:	5-100, 50-1000, 500-10000, 5000-40 000 Hz
Measurement windows:	Rectangle, Hanning, Hamming, Flat Top
Averages:	time synchronous, FFT linear, FFT peak-hold
Spectrum lines, EVAM:	400, 800, 1600, 3200, 6400, 12800
Spectrum lines, FFT:	400, 800, 1600, 3200, 6400
Saving options:	time signal (FFT calculated), full spectrum, time signal and FFT, condition parameters
Spectrum types displayed:	linear, power, PSD
Zoom, EVAM:	true FFT zoom, visual zoom
Zoom, FFT:	visual zoom
Quick mode:	yes (can be set ON/OFF)
Frequency units:	Hz, CPM, orders
Trigger selection:	RPM trigger, post trigger
Transducer line test:	bias voltage test

\* Integral Electronic PiezoElectric

Specifications are subject to change without notice.

# General measurement functions

## Contents

Leonova measurement functions.....	3
Measuring modes.....	3
Transducer Line Quality, TLQ.....	4
Measurement with default files.....	5
Measurement with edited default files.....	6
Single measurement user files.....	7
Multi-measurement user files.....	8
Recording .....	9
Measuring rounds from Condmaster.....	10
Measuring rounds for CondID.....	13
The measuring sequence .....	14
Measurement window before measuring .....	15
Measurement window before saving.....	16
The 'Measure all' function.....	17
Conditional measurements .....	19
Comments.....	20
Graphics window.....	21
Measuring result window .....	22
Measuring point images.....	22
Live spectrum window .....	23
Spectrum window .....	24
Spectrum functions.....	25
Highlighted symptoms in the spectrum .....	29
Multi-line symptoms with harmonics.....	31
Waterfall diagram .....	33
Phase spectrum.....	34
The time signal.....	35
Determine RPM from spectrum.....	37
HD Order Tracking .....	38



## Leonova measurement functions

Leonova Emerald® always has the following measurement functions with unlimited use:

- HDm/HDc and/or SPM LR/HR
- RMS vibration measurement according to ISO 2372
- Speed measurement, rpm and peripheral
- Temperature measurement
- User defined (manual input)
- Stethoscope
- Vocal comments
- CondID, NFC measuring point identification
- Automatic recording of measuring results

The remaining measurement functions are user selected:

- Shock pulse measurement SPM HD, time and frequency domain analysis
- Shock pulse measurement LR/HR with SPM Spectrum and time signal
- Shock pulse measurement dBm/dBc and SPM Spectrum
- Vibration measurement according to ISO 10816, with spectrum
- Vibration Premium or Vibration Supreme for evaluated vibration analysis
- HD Analysis
- Balancing, single plane



B

For each measurement, the user can input a comment as text or voice recording.

## Measuring modes

Leonova is primarily designed as a data logger. Measuring rounds, complete with all input data for evaluated measurements, are downloaded from a PC running the SPM software Condmaster®Ruby. After measurement, the results are uploaded to the PC.

When data logging, the operator works along a predetermined route and measures 'in measuring round order'. As an alternative, CondID memory tags can be attached to the machines. A measuring point, belonging to a downloaded measuring round, is identified by reading its tag. Leonova displays that point and its data, ready for measurement.

For unprepared measurement, Leonova contains a 'default file' for each measuring technique. When required, the input data are entered manually by editing the default values. Edited default files can be saved as new default files, or as user files which retain both the input data and the measuring results.

## Transducer Line Quality, TLQ

The instrument can be set up to perform a transducer line quality test (TLQ) before measurement. Testing the quality of signal transmission between transducer and instrument is essential because, in a poor transducer line, part of the signal will be lost. This in turn means that measuring results will be lower than they should be.

The overall term for the concept of transducer line quality testing is TLQ. Depending on the transducer used, the following applies regarding units of measure and accepted values:

<b>Transducer type</b>	<b>40000, 42000</b>	<b>44000</b>	<b>Vibration transducers, IEPE</b>
<i>TLQ type</i>	TLT	TLR	Bias voltage
<i>Unit of measure</i>	No unit	k $\Omega$	Volt
<i>Accepted values</i>	15–25	26–40 k $\Omega$	According to transducer settings

If the TLQ value is outside the accepted level(s), the measuring result cannot be saved.

Further information regarding TLQ is found in the respective measuring technique chapters in this manual.

## Measurement with default files

Measurement with default files is used for a 'once only' check, where you do not need to save the measuring result. Default files are available for all measuring techniques and are activated with the menu option 'Create default settings' under MENU > Settings.

- Select a measurement function from one of the tabs. In this example, 'User defined' is selected (1). On the selected tab, pick one of the default files (2).
- Mark the file and press the ENTER key to open the measurement function. Press the MENU key > 'Measuring point data' > ENTER to display the available settings.
- In this example (temperature measurement), the only setting available is 'Variable speed' (3). This can be activated if you want to measure RPM in conjunction with the temperature measurement. Use the UP/DOWN arrow keys to mark this setting and press enter to activate it.
- Close 'Measuring point data'. Connect the probe, measure and check the result. If you choose to save the measuring result, you can view it under 'Graphics' while the file is still open.

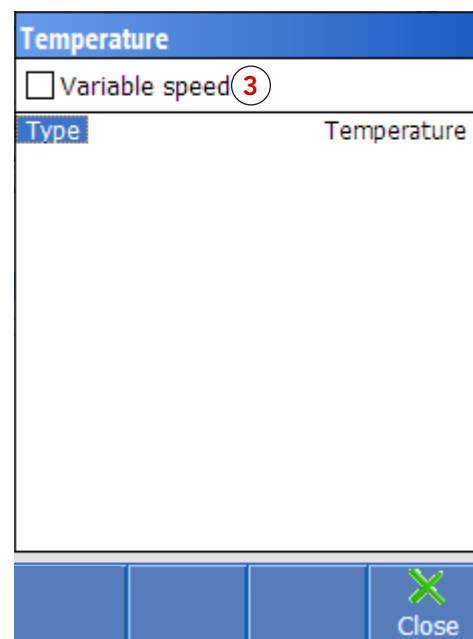
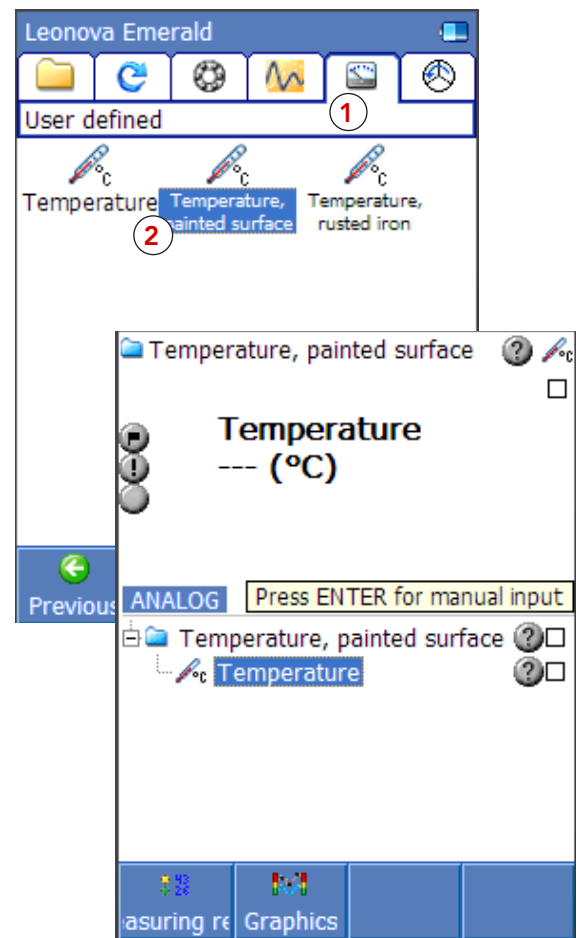

Measuring point data settings

# Measurement with edited default files

Editing the measuring point data only temporarily modifies the default file. Depending on the measuring technique selected, different settings are available for editing. In the example on the previous page, only one parameter can be edited for temperature measurement, namely 'Variable speed'.

To the right is an example showing the default settings for SPM HD measurement (1), all of which can be edited. In the second screen shot (2), shaft diameter and RPM have been input, and the measuring time set to equal 10 revolutions.

After editing measuring point data, you can do one of three things:

- 'Close' (3) simply closes the default file, without saving the edited measuring point data or the measuring results.
- To keep the edited measuring point data permanently, use 'Save as file' (4) before closing the file.
- The choice 'Save as new default settings' (5) creates a new default file which you have to name (6). For further information, see overleaf.

The name of the new default file is shown in the measurement window (7).

SPM HD	
<input checked="" type="checkbox"/> Variable speed	
Shaft diameter (mm)	
Measure RPM simultaneously	Yes
Measuring time	Same as FFT
FFT measurement	Yes
Frequency, upper (Orders)	100
No. of spectrum lines	1600
Symptom enhancement factor	(Off)

SPM HD	
<input type="checkbox"/> Variable speed	
Shaft diameter (mm)	1200.0
RPM	118
HDI	Calculated
Measuring time	10 revolutions
FFT measurement	Yes
Frequency, upper (Orders)	100
No. of spectrum lines	1600
Symptom enhancement factor	(Off)
Save	Time signal and FFT
Trigger selection	(none)

B

Leonova Emerald

Write to CondID

Alarms

Set comment

All comments

Recording

Stethoscope

Measuring point data

Save as

3 Close

4 Save as file

5 Save as new default settings

Save as new default settings

Enter name:

Temperature, painted surface 6

123 ABC ÁÜ

abc def ghi

jkl mno pqr s

ä ö ø

£ ¢ ¥

Enter = Confirm

Shift + Left/Right = Change TAB

abc def ghi Delete ch

Measuring result

Temperature, painted surface 7

Temperature

2013-01-16 15:39:15

Temperature (°C) 22.5

Delete result



## Single measurement user files

When closing a default file with the 'Save as file' option (1) you will be prompted to input a file name via the keyboard window (2). The file will then be accessible from the FILE window (3).

The file thus saved keeps both the edited measuring point data and the measuring results. It can be opened to add more measurements.

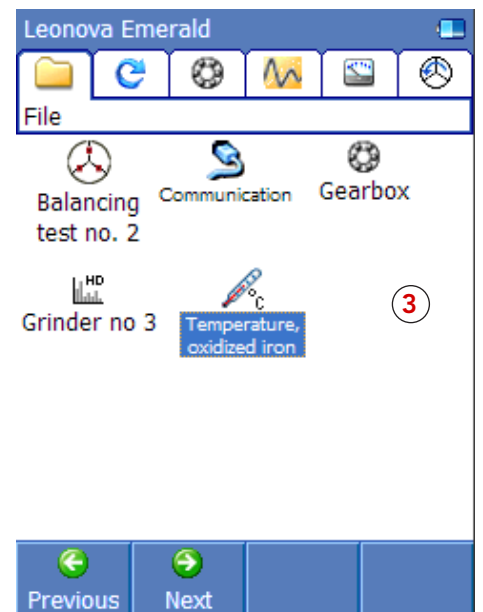
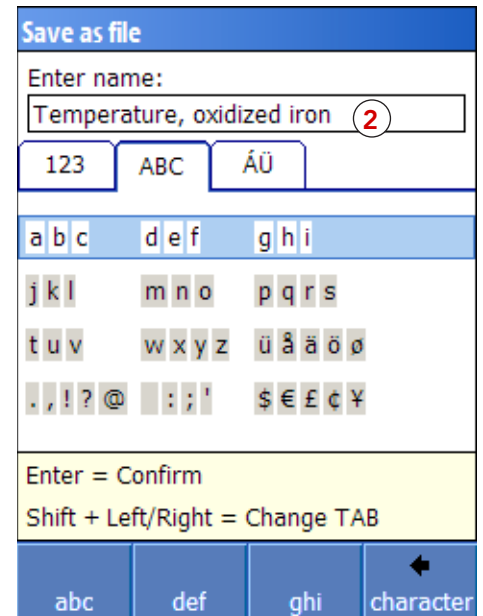
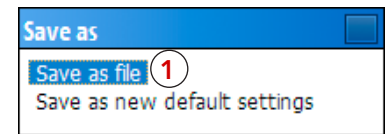

B

# Multi-measurement user files

Further measuring techniques can be added to a single measurement user file after it has been saved under a name and appears in the FILE window.

Press ENTER to open the file. Press the MENU key and select 'Add technique' (1). This opens the 'Add technique' window (2), listing every default file saved on the various measuring technique tabs.

Mark a measuring technique and press the ENTER (or F1) key to select it. The name of the new measuring technique will be added below the existing ones in the measuring window (3).

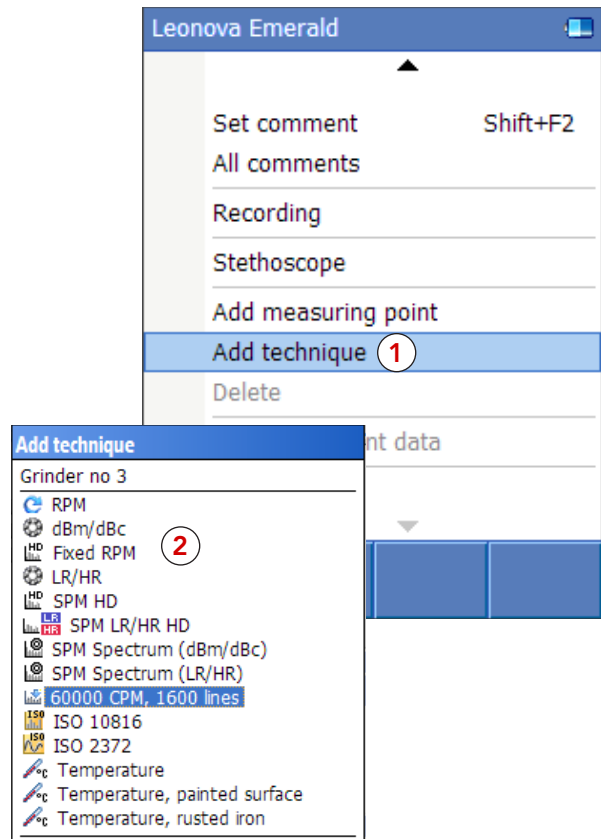
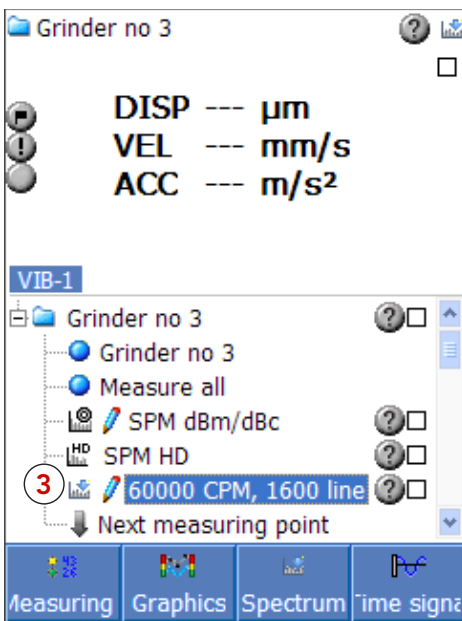

To get the correct measuring point data for all measuring techniques under the same measuring point, you can configure and save the default file before you add more techniques. Alternatively, edit the measuring point data for each technique in the new user file. Save it under a new name if you want to keep the original user file.

To measure vibration or shock pulses with variable speed, select the speed technique and do not input an rpm value with the measuring point data for the others.

# Recording

'Recording' on the measurement menu (1) is a function for taking a stated number of readings at stated intervals, or measure for a stated number of minutes.

Default files and single measurement user files can be used when recording a single quantity, e. g. shock pulses or a certain type of vibration.

However, the 'Recording' feature is consecutive measurement of different quantities, using up to three different transducers simultaneously connected to Leonova:

- a shock pulse transducer on the SPM input
- one vibration transducer on the vib input
- a tachometer or temperature probe on the tachometer/temperature input

To set up a consecutive recording of a shock pulse measurement, a vibration or rpm measurement and possibly temperature (or any combination of these), one needs a measuring point where all wanted measuring techniques are active. This measuring point is either downloaded from Condmaster, or it is a multi-measurement user file (see previous page).

Define the number of measurements or minutes (2) and the time interval (3) between measurements (0 minutes = as fast as possible). Use the F1 key (NEW, 4) to select measuring techniques from the list (5) and put them into the measuring sequence (6). A selected technique can be replaced by another with EDIT (7) or be deleted with (8). Connect the transducer(s) and press the MEASURE/SAVE (M/S) key to start.

The results can be seen on the graphics display and can be uploaded to Condmaster.

For SPM and vibration measurements with **variable speed**, select 'Speed' as a technique and do not input an rpm under 'Measuring point data'.

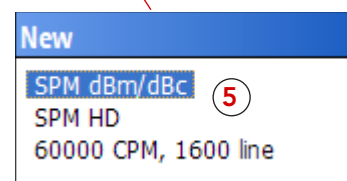
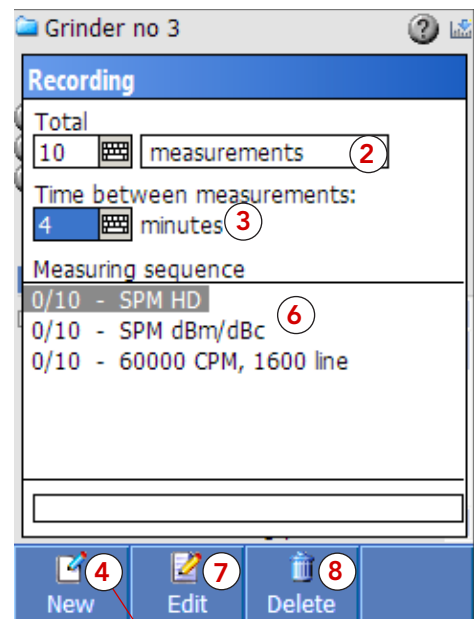
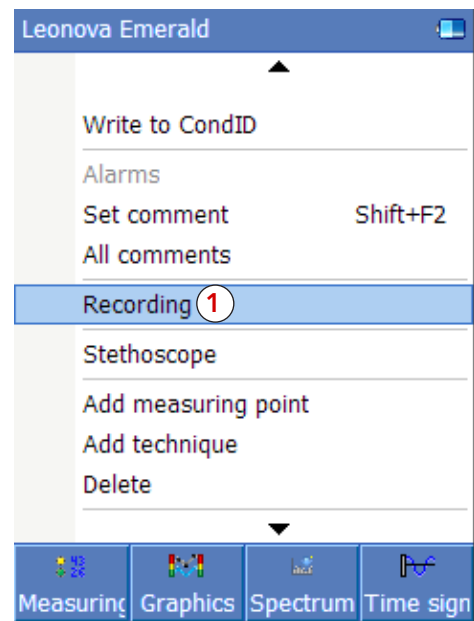

B

# Measuring rounds from Condmaster

For efficient, systematic condition monitoring, Leonova is used as a data logger. Measuring points are set up in Condmaster and downloaded to Leonova, complete with all input data for any or all of the supported measuring techniques. For instructions, see the 'Working with Condmaster Ruby' user guide.

Downloaded measuring rounds are placed in the FILE window (1). To measure, mark the file and press the ENTER key to open (or press MENU > 'Open' (2)).

Measuring rounds cannot be renamed in Leonova, because Condmaster needs the original round name as an identifier.

B

After uploading a measuring round back to Condmaster, it can be deleted from Leonova (3). If you keep it in the instrument, it will be overwritten next time you download the same measuring round from the PC.

Components and measuring points in downloaded measuring rounds are shown in the order they were arranged in Condmaster. All the operator has to do is connect the appropriate transducer and use the Leonova MEASURE/SAVE (M/S) key to obtain and save the measurements.

In Condmaster, the components and measuring points contained in a measuring round can be organized under labels (4) to create a logical structure and improve measuring route efficiency.

Mark a component and press SHIFT+UP/DOWN to move between components (5) and mark a measuring point or label to jump to next view.

To add a technique to a measuring point, press MENU > 'Add technique' (6). This technique will be automatically saved as part of the measuring point in Condmaster.

A new measuring point can also be added to a measuring round (7). It is sufficient to name the measuring point temporarily and select at least one measuring technique. On uploading the round, the new measuring point can be properly named and numbered.

Please note that the new measuring point will not remain in the measuring round to which it was added. To make it a permanent part of the measuring round, go to the measuring round register in Condmaster and add it.

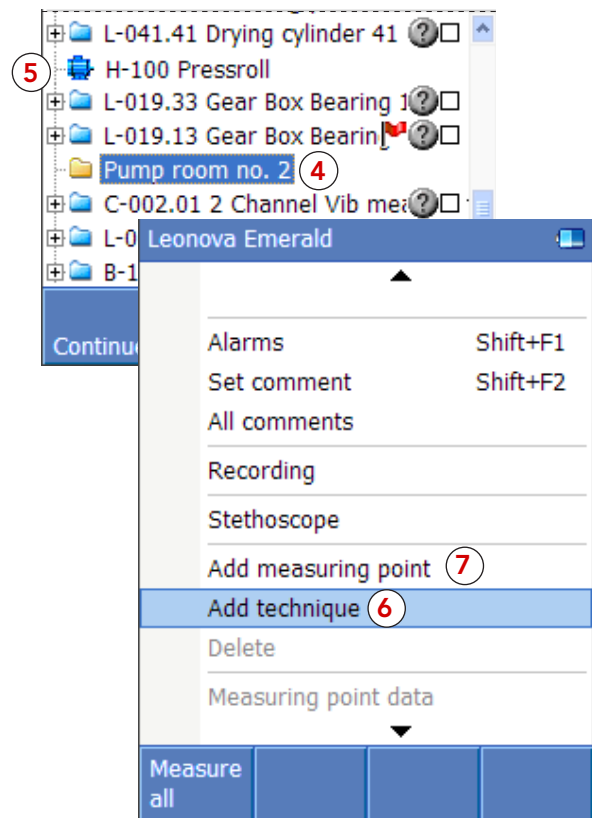
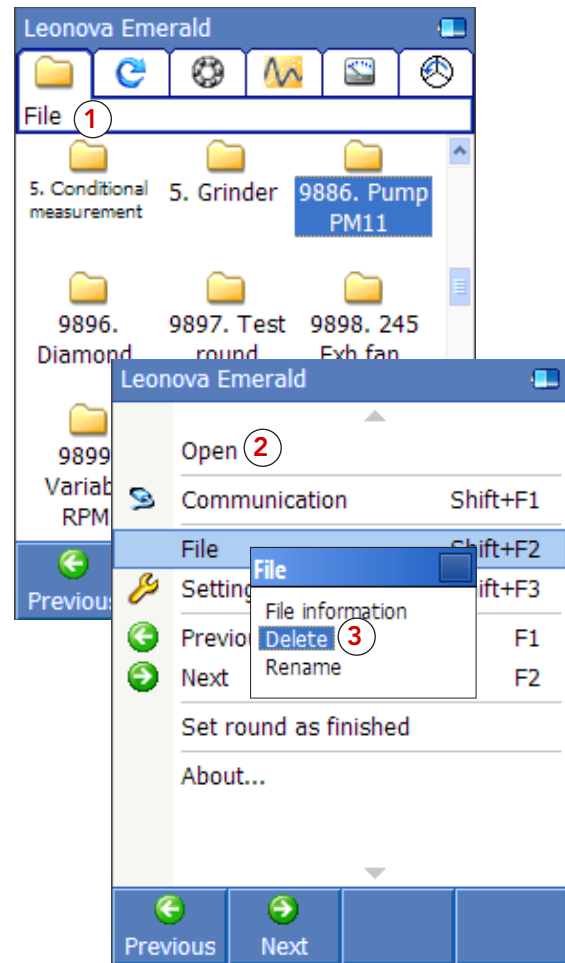

The function 'Download all round data' under *Data Transfer > Settings* in Condmaster is activated by default and means that all measuring rounds and their measuring points for the current database is downloaded to the instrument, but without measurement results. This function is the basis for the functions 'Add downloaded measuring point' and 'Add downloaded round' in Leonova, see below.

When you are in the middle of a measuring round and remember that you need to measure something on a particular machine that belongs to another round, you can use the 'Add downloaded measuring point' function. Go to MENU > Add measuring point, then choose 'Add downloaded measuring point' (8), select a measuring point from a list of all downloaded measuring points and complete the measurements. The measuring point is added to the round, but when uploading the round to Condmaster, the results are transferred but the measuring point is not added to the measuring round.

Another option is to create a new round and add some of the downloaded measuring points. Go to MENU > Add round, select Create new round (9) and then choose measuring points from a list containing all downloaded measuring points from Condmaster.

If you have forgotten to load a certain measuring round in the instrument, it is possible to temporary add a downloaded round. Go to MENU > Add round, select Add downloaded round (10) and then choose a round.

Under MENU > Settings > General settings, the alternative 'Automatically set round as finished' is available (default off). If it is ticked, a round will automatically be marked as finished when all its assignments have been measured. A finished round is shown by a folder symbol with a green checkmark (11). It is possible to mark a round as finished even though it is not (and vice versa). Use the alternatives 'Set round as finished' and 'Set the round as unfinished' as required found from the MENU.

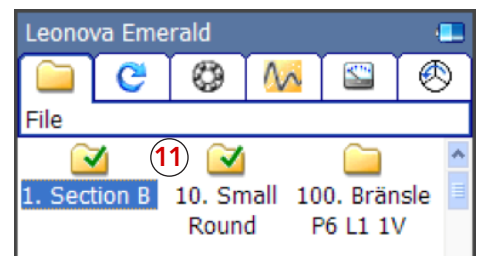
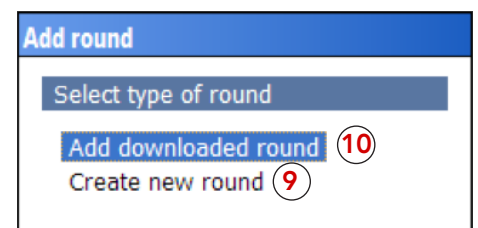
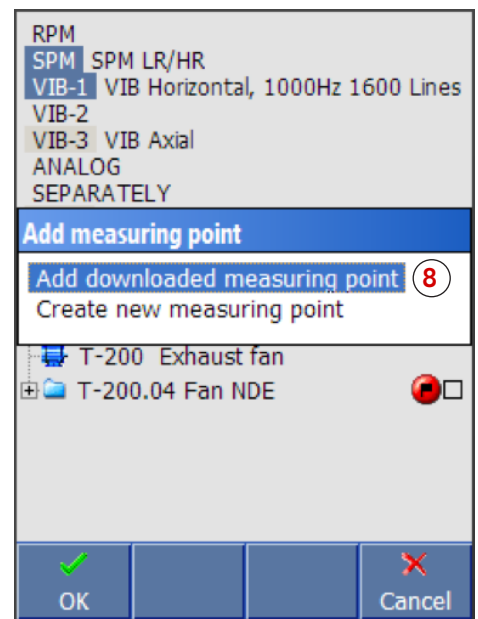

B

*TIP:* When standing in a measuring round, you can press SHIFT+F4 to jump to the default transducer setting (12) which can be useful if you need to change default transducer for a measuring point.

*TIP:* When standing on a measuring point, you can press MENU and select 'View details' to view more of the information that was input in Condmaster. This can be useful if you for example need to know the location of the measuring point which is shown under 'General' (13).

At the bottom, Work description (14) is shown if the measuring point has a work description connected to it in Condmaster, press F2 to access it. Lubrication data is shown if the measuring point has lubrication data set up in Condmaster, press F3 to access it.

*TIP:* It is possible to view a Work description for a measuring round from the file menu when standing on a round (if the round has a Work description connected to it). Press MENU and select 'Show Work description' (15).

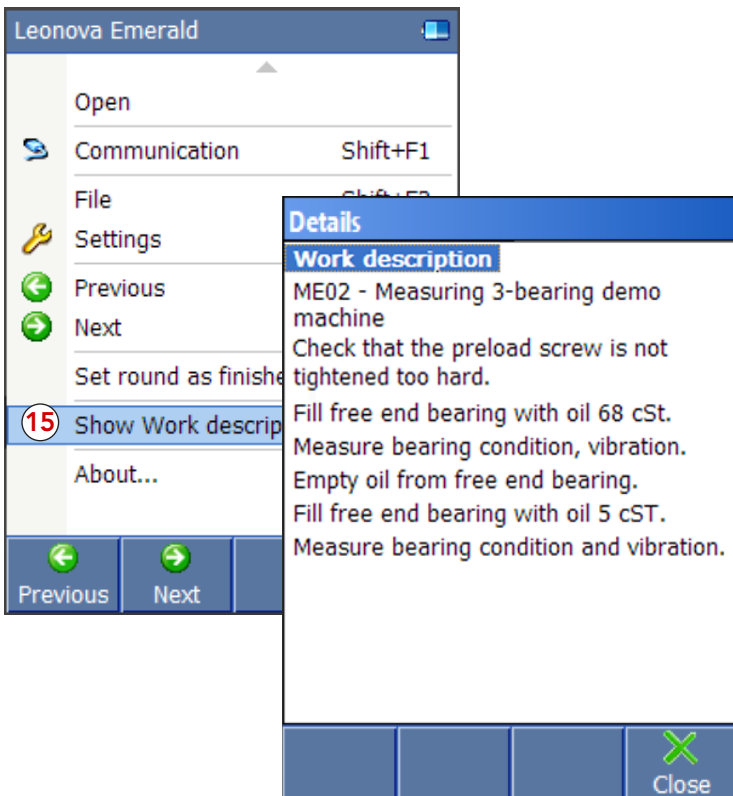
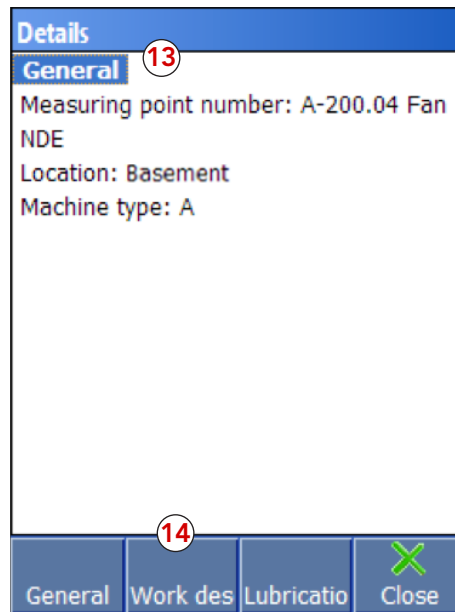
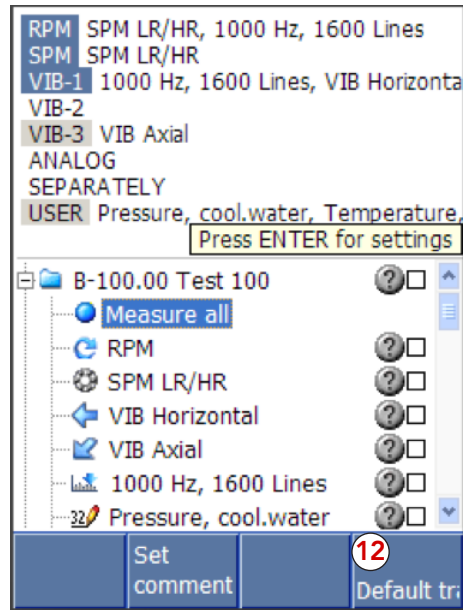

## Measuring rounds for CondID

CondID is a contact free memory tag used for measuring point recognition. It is hung on the adapter cap or strapped in a suitable place on the machine. It should not be mounted flat against a metal surface. A distance of min. 3 mm between metal surfaces and CondID is recommended. The tag responds to a recognition signal when Leonova is held close to the tag.

To connect a CondID tag to measuring point, select the measuring point in the round, press MENU and select 'Connect CondID to measuring point' (1).

In a downloaded measuring round, the measuring points linked to CondID tags will be marked with a memory tag symbol (2).

After opening the round, hold Leonova close to the memory tag, press the MENU key and select 'Read CondID' (3).

The information on the tag will open the right measuring point in the round and Leonova is ready for measurement.

To break the link, press MENU and select 'Disconnect CondID from measuring point' (4). Press 'Yes' to confirm.

When standing in a measuring round and reading a CondID that does not belong to the round but to the database, the instrument asks if the measuring point should be added to the round so it can be measured (5). If 'YES', the measuring point will be temporary added to the round. When uploading the round to Condmaster, the results are transferred but the measuring point is not added to the measuring round.

NOTE: This functionality requires that the 'Download all round data' is enabled under *Data transfer > Settings* in Condmaster.

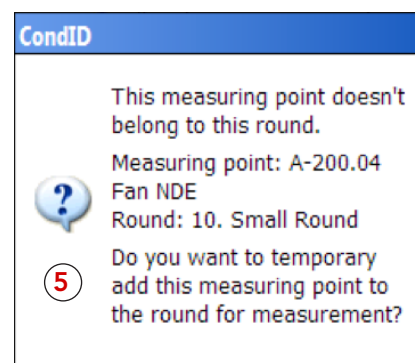
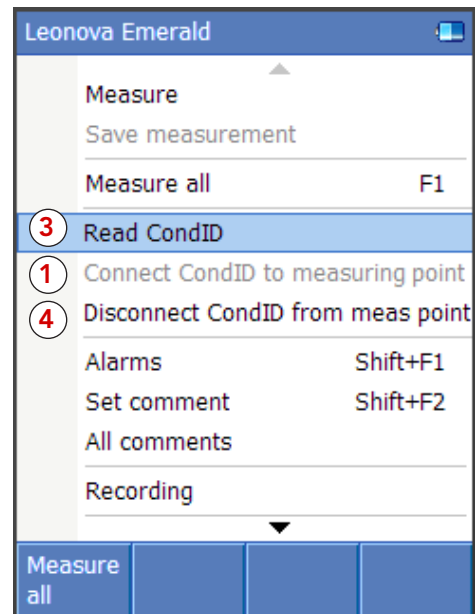
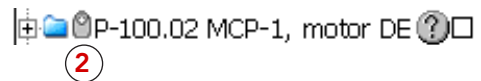

## The measuring sequence

Measuring with Leonova, especially data logging with downloaded, fully configured files, is very easy.

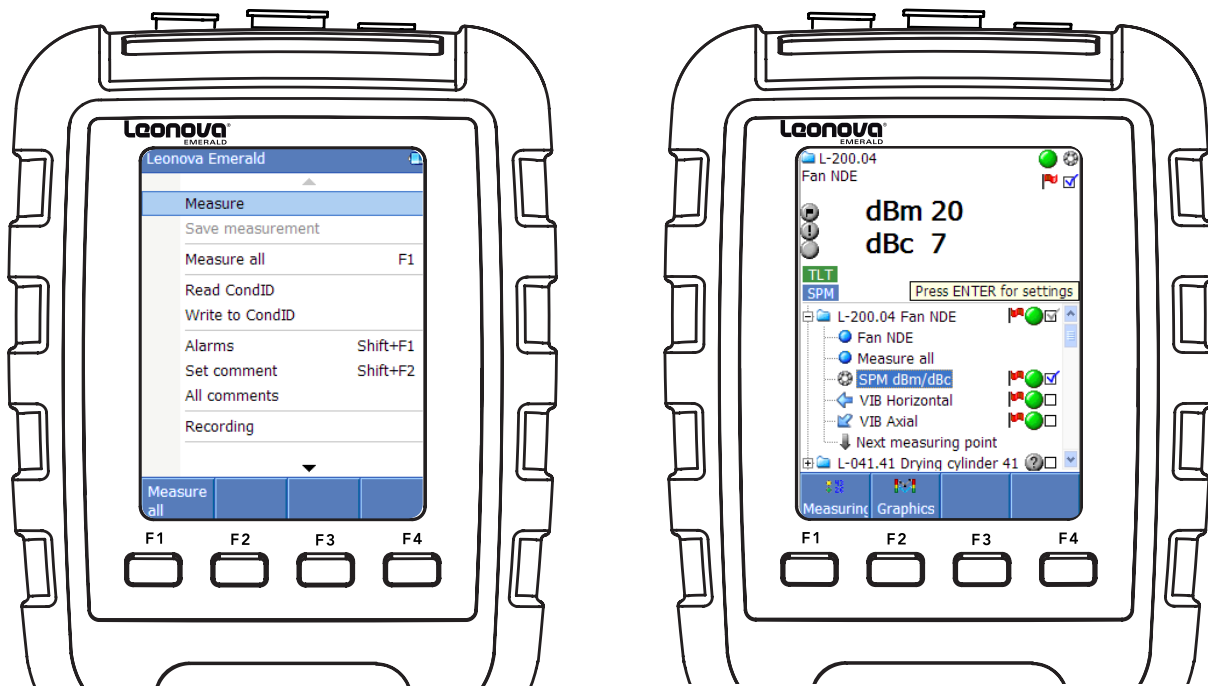

### Default files

- 1 Select a file (technique menu).
- 2 Open the file.
  - Open 'Measuring point data'.
  - Edit 'Measuring point data', all parameters.
  - Close 'Measuring point data'.
- 3 Connect the transducer.
- 4 Press the MEASURE/SAVE (M/S) key to start the measurement. Press MEASURE/SAVE (M/S) again to save the measuring result. To measure repeatedly without saving in between, press the M/S key down for 2 seconds. Set a comment if needed.
5. To remove unwanted results, go to MENU > 'Measuring results' > Delete result (F3).
- 6 Close the file with MENU > 'Close' (which closes the default file without saving), or use 'Save as' to save it as a user/new default file.

### Files configured in Condmaster

- 1 Select a file (FILE menu).
- 2 Open the file and select a measuring point.
- 3 Connect the transducer.
- 4 Press the MEASURE/SAVE (M/S) key to start the measurement. Press MEASURE/SAVE (M/S) again to save the measuring result. To measure repeatedly without saving in between, press the M/S key down for 2 seconds. Set a comment if needed.
5. To remove unwanted results, go to MENU > 'Measuring results' > Delete result (F3).
- 6 Close the file with MENU > 'Close' with or without saving.

### RPM measurements in measuring rounds

In rounds containing several measuring points, the RPM value of the preceding measuring point is automatically suggested for the next measuring point if the settings match each other (Min/ Max RPM must match, or Min/Max Speed and Unit for speed must match).



## Measurement window before measuring

The measurement window has three parts, the result field (A), the measuring point field (B) and the function bar (C). Their contents differ, depending on the type of measurement file and measuring technique used. The figure below shows a downloaded round with the dBm/dBc technique active, before pushing the MEAS key.

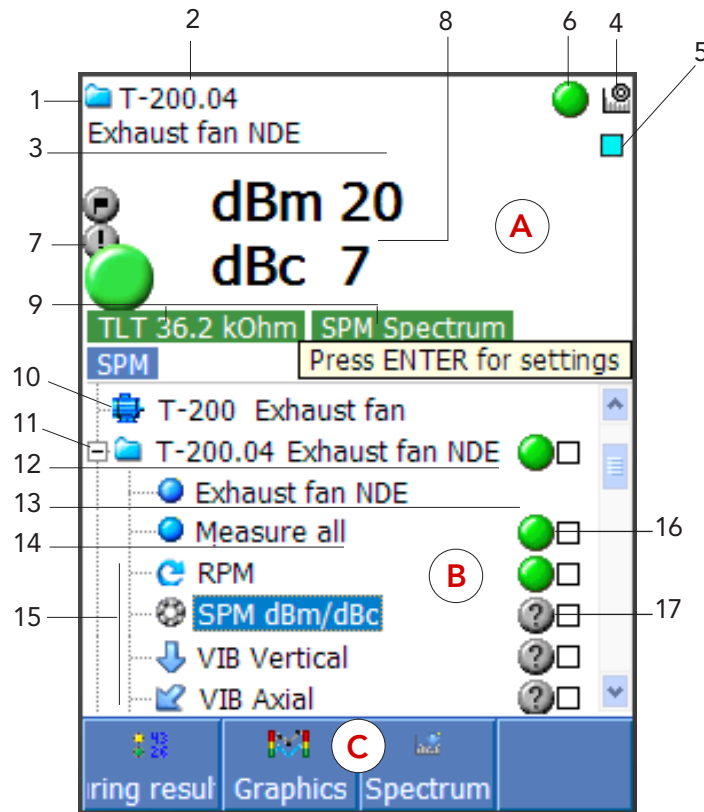

### A Measuring result field

- 1 Measuring point icon
- 2 Measuring point number
- 3 Measuring point name
- 4 Active measuring technique
- 5 Measuring result saved for this technique; No = blue box, yes = blue check mark , not measured = white box, measurement aborted = grey check mark
- 6 Measuring point status when last measured
- 7 Alternatives for measuring point status after measurement
- 8 Unit of main measuring result
- 9 Additional measurements yes - no, e.g. transducer line quality, spectrum etc.

### B Measuring point field

- 10 Component
- 11 Measuring point open (measuring assignments are visible)
- 12 Measuring point number and name, (marked = active)
- 13 Measuring point name 'on separate line' (remove under 'General settings')
- 14 Measure all measuring assignments (measuring techniques) with one command
- 15 Measuring assignments (techniques)
- 16 Measuring assignment; measured and uploaded at least once, present status in Condmaster
- 17 Measuring assignment, measured and uploaded at least once, no condition status or no alarm limit defined in Condmaster

Open/close measuring point folders with RIGHT/LEFT arrow keys.

### C Function bar

The function bar shows actions controlled through the function keys F1 to F4. The functions available will vary with different modes. The SHIFT key is used to provide alternate functions in the function bar.

# Measurement window before saving

The measurement is started by connecting the transducer and pressing the MEASURE/SAVE (M/S) key, or selecting the 'Measure all' command (press function key F1).

The measuring result (1) is displayed in the measurement field (A) and the status is shown by a larger status icon (2) on top of the alternatives.

At this stage, the measuring result is not yet saved; a fact indicated by a small blue box. The alternatives are to save it now or repeat the measurement. To measure repeatedly without saving in between, press the M/S key down for 2 seconds.

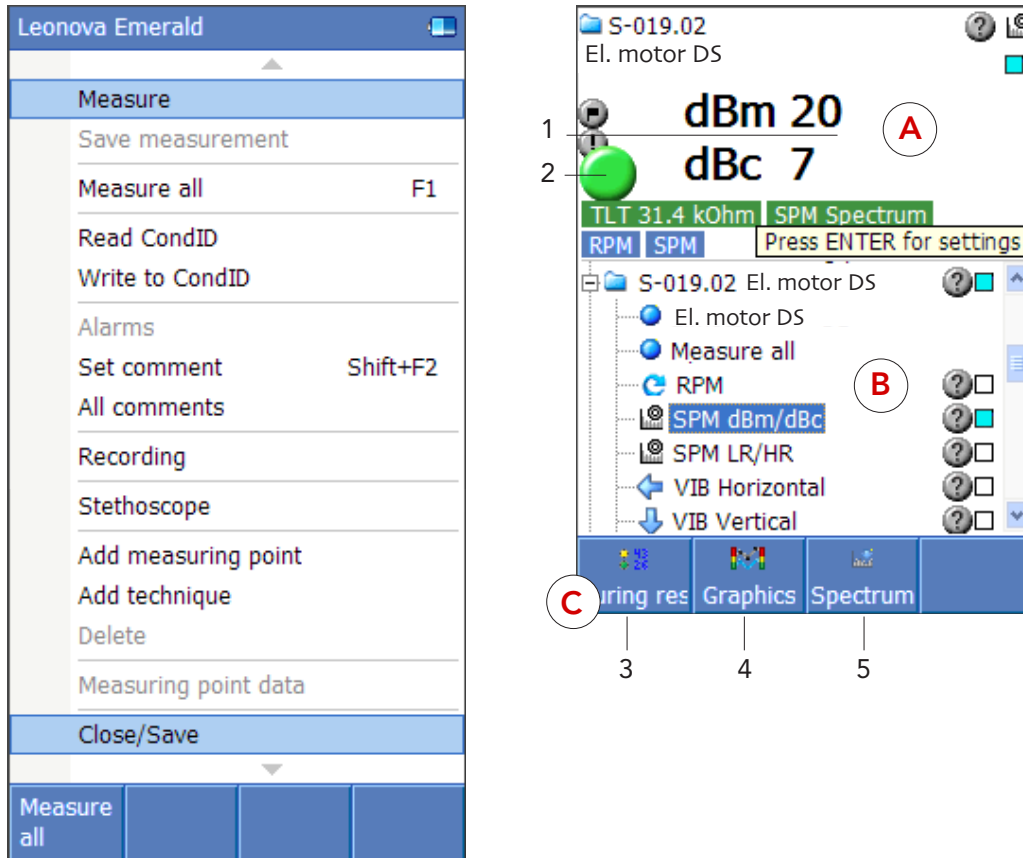

## C Function keys and menu options

All options reached via the function keys (F1-F4) are linked to the measuring point and measuring assignment selected in the measurement window (B).

- 3 F1: Opens the measuring results window. In this window, use the F1 and F2 function keys **before saving** to toggle between measuring results from the active measuring assignment, and F3 to delete any results you do not want to save.
- 4 F2: Opens the Graphics window to display trend graphs for the selected measuring assignment. This window shows a) the selected measurement taken before saving, or b) all downloaded and saved measurements after saving, for the selected measuring point and measuring assignment.
- 5 F3: Spectrum display (if any).

Pressing the MENU key on the instrument displays a menu of further options.

## The 'Measure all' function

Under all measuring points in Leonova, the 'Measure all' command appears above the list of measuring assignments (1). The purpose of this function is to speed up the execution of measuring rounds.

All types of assignments under a measuring point are measured simultaneously with exception of RPM measurements, user defined measurements, assignments triggered by RPM and assignments with post triggers.

Settings for 'Measure all' are made in the instrument only, but are uploaded to Condmaster along with the measuring round and saved for the next download to Leonova.

The 'Measure all' function is disabled by default. It can be activated under MENU > 'Settings' > 'General settings' in the FILE window.

In the top section of the measurement window, a list of measuring techniques and the current channel configuration for the measuring point is shown (2). Measurement using remote transducers is always carried out separately, i.e. not concurrent with any of the other measurements in the list.

When using a Duotech accelerometer the shock pulse measurement occurs on channel VIB-1.

To change the channel configuration, mark the 'Measure all' line (1) and press the ENTER key. The 'Channel settings' window (3) is displayed, showing all measuring techniques on the measuring point; press F1 ('Change channel') (4) to change channels.

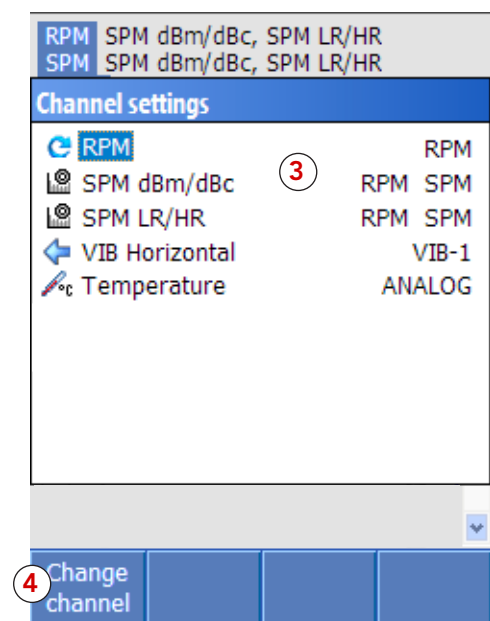
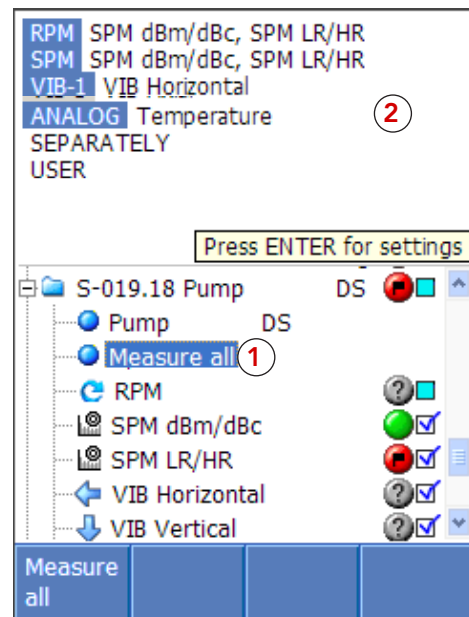

Press F1 'Measure all' to start measuring. You will be prompted to connect transducers and/or input manual data.

When a RPM result is saved the value will be transferred to the subsequent measurement points under the same component. If a measuring point under the component has a different 'Max RPM' value this RPM value will be recalculated on the basis of the measured measurement point.

Conditions to enable this feature:

- RPM is available as technique
- There is a saved RPM value (may be a downloaded preset value from Condmaster or a measured value)
- None of the other measuring techniques have "Measure RPM simultaneously" enabled
- RPM can not be set as USER (user input) in the channel settings for 'Measure all'.

To use the RPM from the previous measuring point, untick 'Measure RPM' (1) by pressing F3 in the first 'Measure all' dialog box.

Press 'Edit' (F1) in the 'Measuring point data' window to change the RPM settings if values are outside the limits. New settings will be transferred to Condmaster when uploading the round.

All measured assignments are displayed during measurement (2). When a measurement is completed for a particular assignment its status bar is green for a few seconds before the assignment disappears from the list. If an error occurs during the measurement of an assignment its status bar becomes red (e.g. TLQ error).

When a measuring assignment is completed it disappears from the list. When all assignments on the list are completed the measuring window closes automatically and the display will show 'All techniques measured!'. Press ENTER to go to next measuring point.

Press F2 'View summary' to see the results of all measurements just carried out (3).

To toggle between measurement results, use the UP/DOWN arrow keys. From 'View summary', measurement results can be erased and measured again.

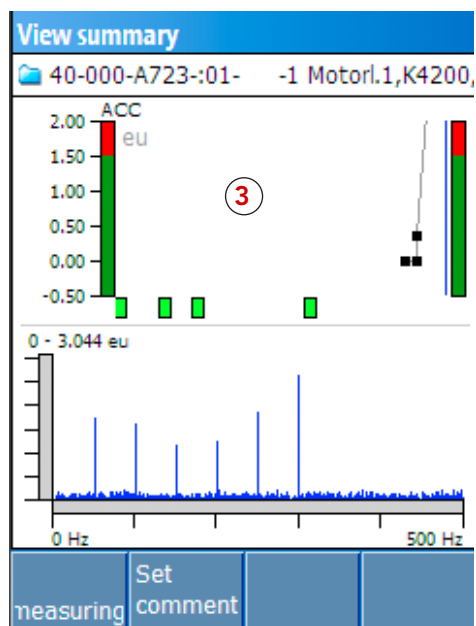
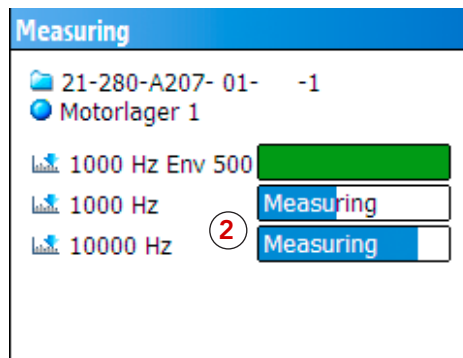
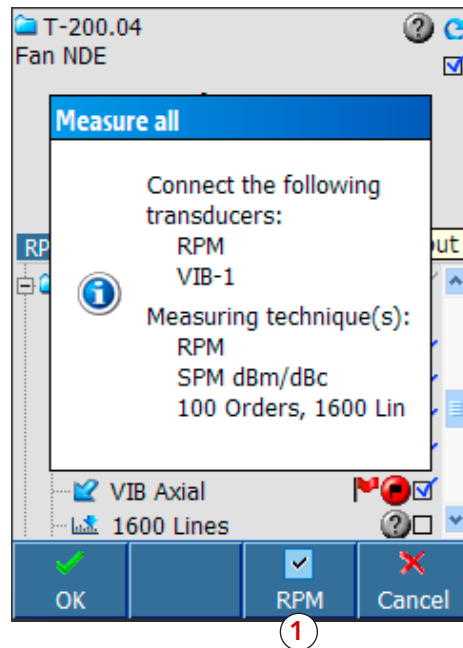

## Conditional measurements

In conjunction with SPM HD measurements, conditions can be set up in Condmaster (see the Condmaster User Guide).

Conditions are used to ensure that measurement is completed only if the HDm reading was above a user defined limit.

If an SPM HD measuring assignment has a condition associated with it, the hint 'FFT on limit >=... ' (1) is displayed. This condition means that a full SPM HD measurement including FFT will only be completed if the initial HDm reading equals or exceeds the limit value.

After measurement, a blue box (2) signifies a successfully completed measurement (although not yet saved), whereas a grey check mark (3) indicates that the condition for this measuring assignment was not met and the measurement therefore aborted.

To override conditions for an SPM HD measurement, mark the measuring assignment and press ENTER. Under 'FFT calculation', press ENTER and select 'OFF' (4).

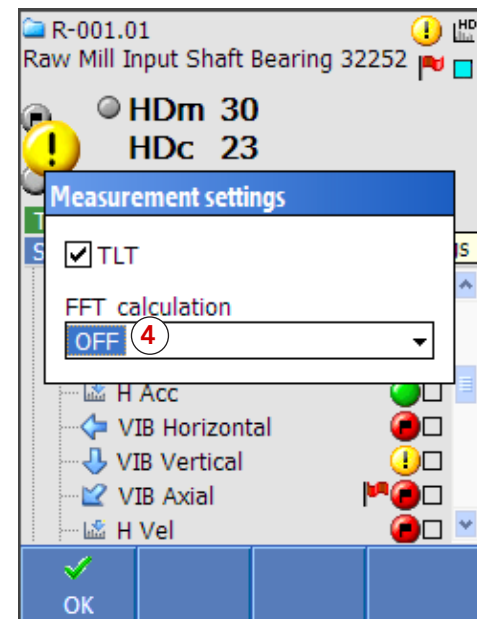
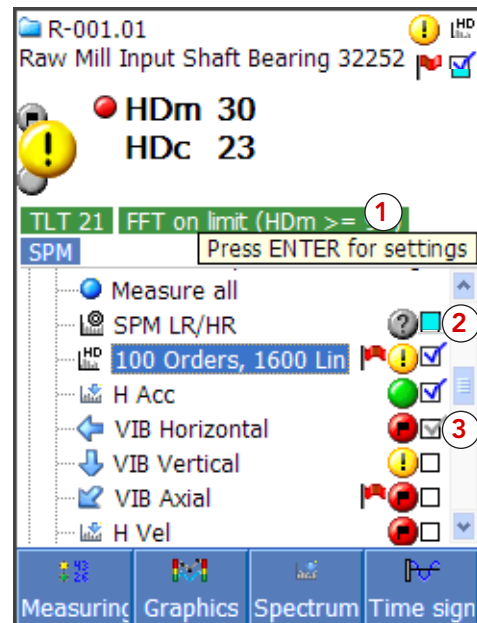

B

# Comments

The MENU option 'Set comment' (1) is open for all types of measurements.

Comments are made up of a 'standard comment' (2) and an optional free text (3) of up to four lines. The present date and time are set automatically in the field 'From date/time' (4). They can be edited. Leonova is also capable of recording and playing back audio files, so using a headset with microphone, you can add vocal comments as well. These are uploaded to Condmaster with the measuring round and can be played back from there.

As an option, a future date and time can be input in the field 'To date and time' (5). This turns the square on the time line of the graphics display into a bar that covers the time interval between the two dates and times.

To record a vocal comment, press the F3 function key ('Voice recording') (6), then press F1 ('Start') to begin recording. Maximum recording time is 30 seconds. Standard comments having a vocal recording attached to them are marked with a speaker symbol (7). Mark the comment and press F4 ('Play') to listen to a recording.

The complete list of standard comments contained in Condmaster is downloaded with the measuring rounds and is available when data logging. Before downloading, the user can select what comments should be downloaded to the instrument and the order in which to show them.

When measuring with the Leonova default files, there are sixteen 'Default comments' (8) to which you can add free text. The text 'Default comment' can not be edited.

In the graphics display, comments appear as small squares (colour coded in Condmaster) on the time line.

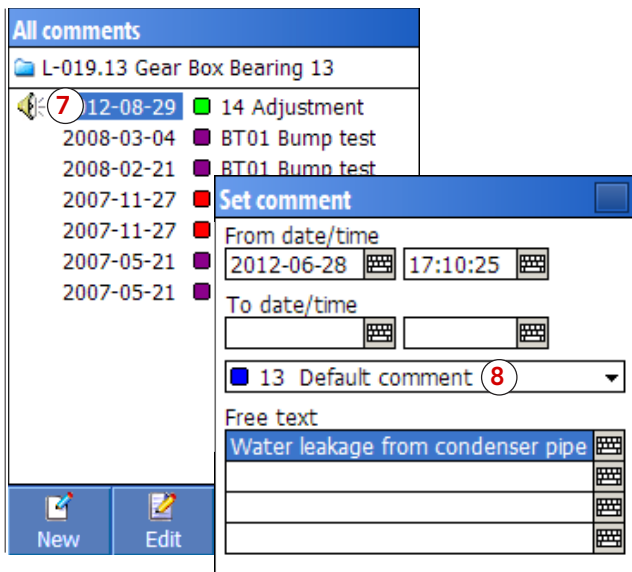
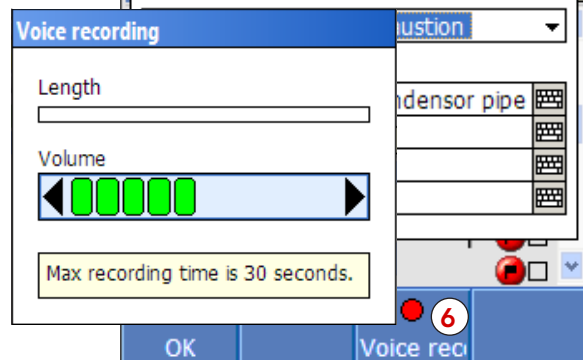
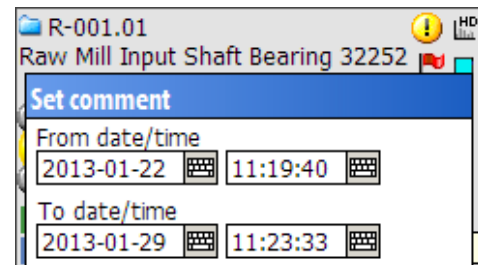
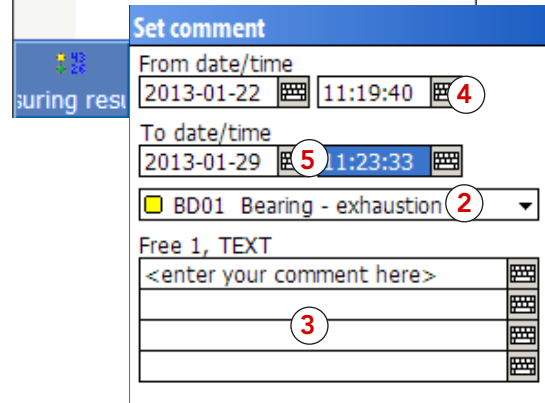
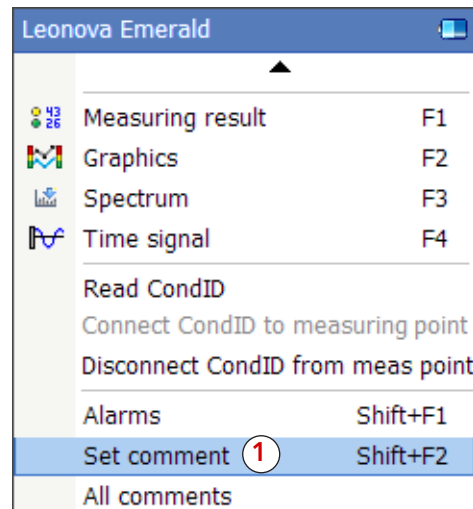

B

## Graphics window

The graphics window shows measuring results as dots (1) against a neutral scale or, in case of evaluated measuring results, a condition scale (2). Alarm limits defined in Condmaster are marked by thin horizontal lines (3). The type of measuring result (4) is selected in the measuring result window.

Up to 100 measuring results can be downloaded with a measuring round from Condmaster. The setting is made under System > Measuring system when Leonova is activated as a measuring device. Downloading 5 to 10 measuring results is quite sufficient to see the trend when the new reading is taken. The new result is shown before it is saved.

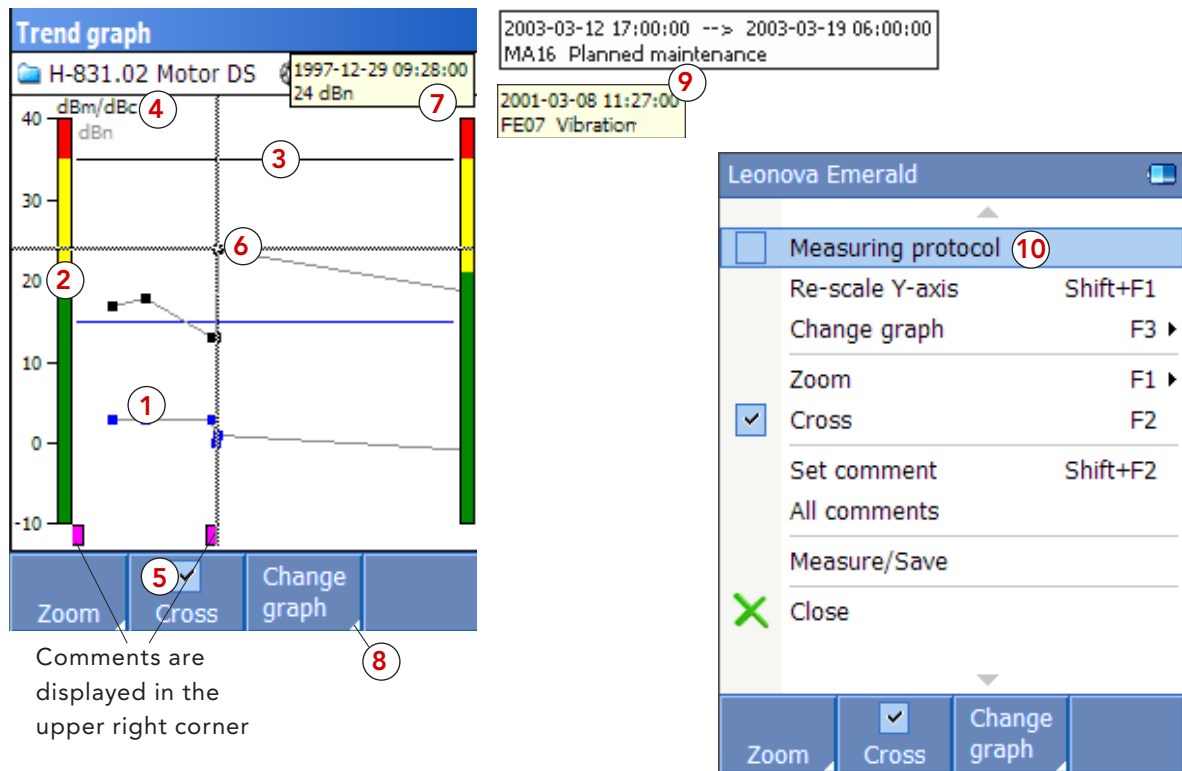

Comments are displayed in the upper right corner

To select a measuring result dot for further examination, use the F2 function key ('Cross') (5). This action displays a "crosshair" (6) which can be moved between individual measuring results using the instrument arrow keys. The measuring result and time of measurement is displayed in the upper right corner of the display (7).

A white corner on a function (8) indicates that more options are available when pressing the corresponding function key (F1 - F4). Pressing and holding the SHIFT instrument key offers further options still.

'Zoom' > 'Zoom X' zooms the display around the center of the current view, while 'Zoom to cross' zooms in on the crosshair. 'Zoom back' reverts the last zoom step, while 'Zoom back all' returns to the original time span.

The amplitude range can be changed by pressing SHIFT + F1. The 'Rescale Y-axis' function sets the scale to the min. - max. range of the measuring results.

Comments are placed along the time line and displayed in the upper right corner (9) (replacing the measuring result information) when put in focus by means of the crosshair. To add a new comment, press MENU > 'Set comment'.

Pressing MENU offers more functions, such as 'Measuring protocol' (10), which spaces the measuring result dots evenly, regardless of the time intervals between measurements.

## Measuring result window

In the upper part of the measuring result window (1), the current measuring assignment data is displayed. Saved measuring results from that measurement are displayed in the lower part of the display (2). The scroll bar (3) indicates that there are more parameters than those visible on the screen.

The measuring results are shown in this window both before and after saving the current measurement. When several readings have been taken and saved, the F1 ('Previous result') and F2 ('Next result') keys can be used to toggle between them (4). Press the SHIFT key + F1 or F2 to skip to the first or last measuring result.

The measuring result window also shows the units of measurement (5), if any.

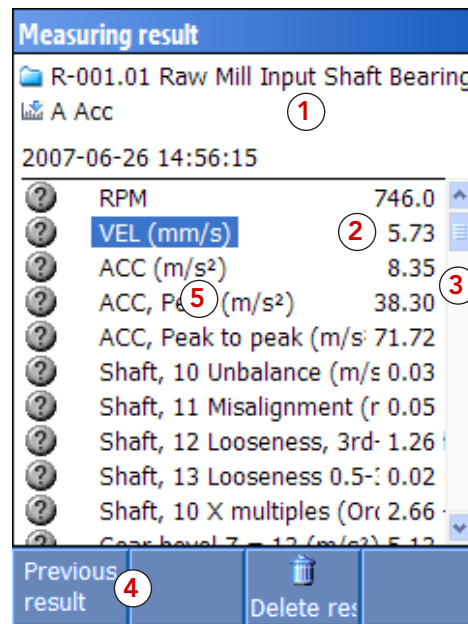
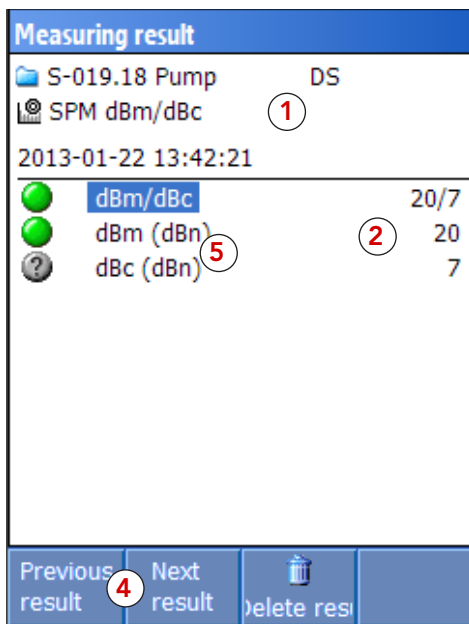

## Measuring point images

Using the **Measuring Point Imaging** function in Condmaster, images or photographs can be connected to measuring points. If a measuring point has an image associated with it, the image can be viewed in Leonova Emerald (1).

Images are accessed from the measurement window. With the measuring point name marked (2), press the F4 key ('View image') (3).

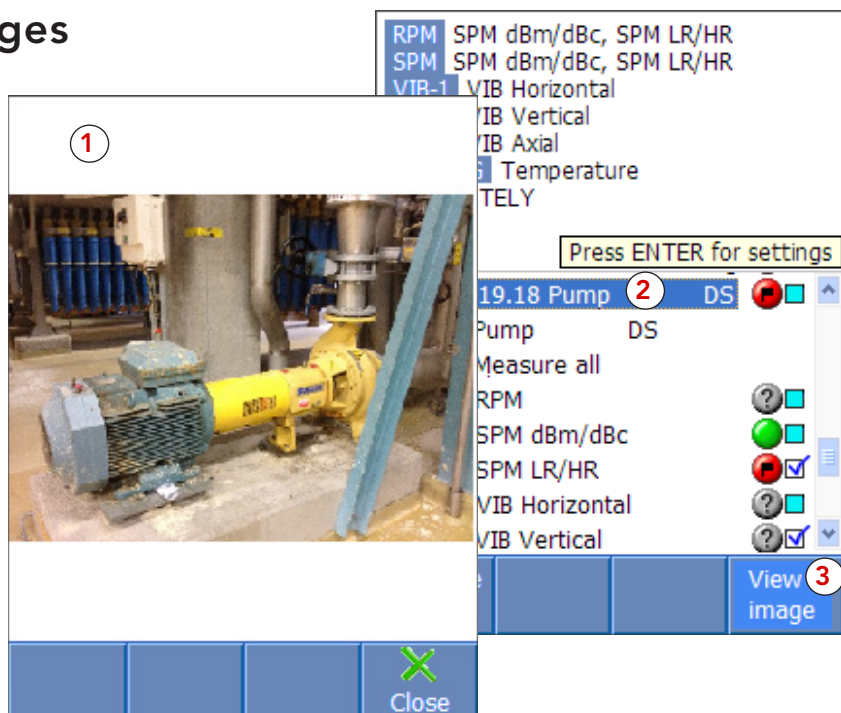



## Live spectrum window

The live spectrum window (1) shows a continuously updated spectrum with 200 lines, irrespective of other settings. The window will come up before measuring with the vibration measuring techniques and rotor balancing.

This function is activated MENU > 'Settings' > 'General settings' (2). On the 'File' tab, mark 'Preview live spectrum' (3).

'Re-scale' (4) will adjust the Y scale to fit the highest value and 'Lock scale' (5) will lock the Y scale.

Temporary settings can be made in the live spectrum window; use the instrument arrow keys to navigate to the arrows button (6), then press ENTER.

When pressing 'Measure' the pre-set assignment will be performed.

In the live spectrum window (7), you can temporarily change the upper frequency, spectrum unit and FFT type.

Select parameter with the UP/DOWN arrow keys and change value with LEFT/RIGHT. Pre-set values for the measuring point are shown in blue, changed values in black. Changes will not affect settings made under 'Measuring point data'.

It is possible to display time signal (8) in the live spectrum window. First start the measurement with 'Preview live spectrum' enabled under 'Settings', then press Shift+F1 to switch to the display of time signal.

After changing the display setting to time signal, the time signal display is default for all new measurements until the user switches back to display spectrum with Shift+F1.

At a reset of the instrument it will return to show live spectrum.

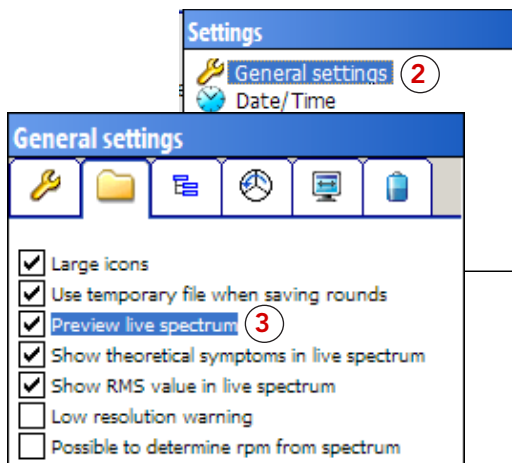
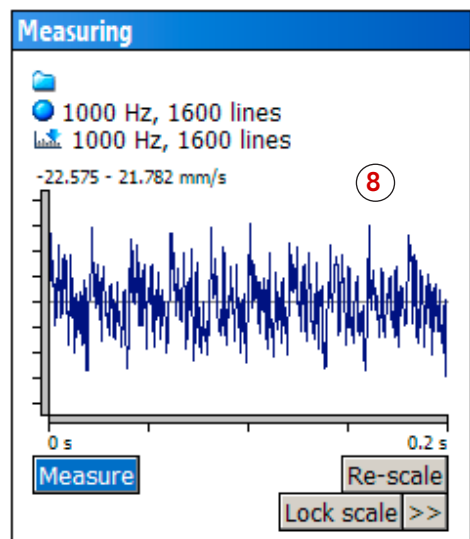
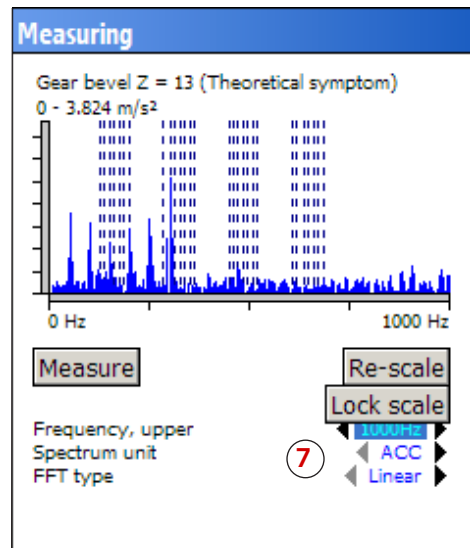
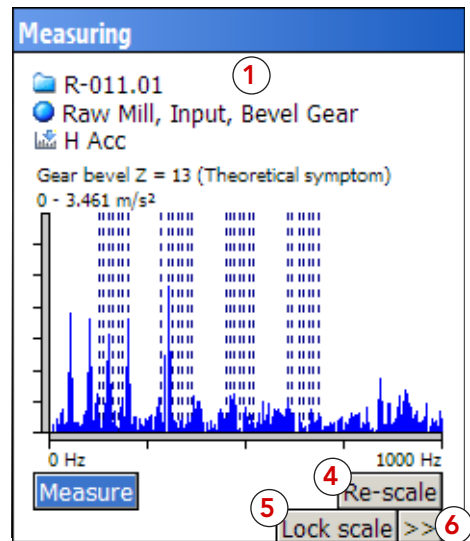

B

# Spectrum window

Below the spectrum field (A) are functions (B) which are reached using the instrument function keys in combination with the SHIFT key.

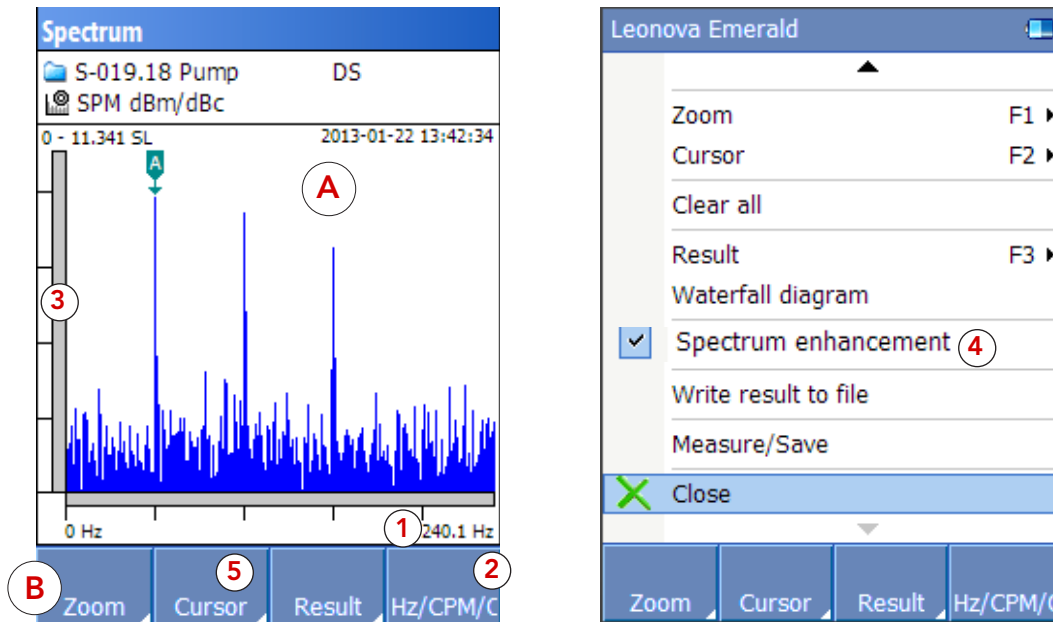

The spectrum diagram is marked with the (displayed) range (1) in Hz, CPM or Orders, depending on the default setting made under 'General settings'. The unit may be changed by pressing F4, 'Hz/CPM/Orders' (2). All spectrum lines below the lower frequency will be shown in grey.

The Y axis (3) is marked with the measuring unit for spectrum line amplitude and with the range. For default measuring assignments (which are not part of a measuring round downloaded from Condmaster), the spectrum type unit can be changed by pressing the MENU key while *in the measurement window* and selecting 'Measuring point data'.

If there are known disturbances, e.g. from surrounding equipment, the 'Spectrum enhancement' function can be activated in Condmaster in order to obtain a clearer view of the relevant signals in the spectrum. Using this function, spectrum lines related to a certain source of disturbance can be excluded, or interesting spectrum areas highlighted. When 'Spectrum enhancement' is activated in Condmaster, it can be turned on or off in the Leonova spectrum window under MENU > 'Spectrum enhancement' (4).

Zoom options become available by pressing F1, 'Zoom'. While in zoom mode, use MENU or SHIFT to select a suitable zoom option. The spectrum can be zoomed along its X axis with the LEFT/RIGHT arrow keys.

Pressing F2 ('Cursor', (5)) displays options for cursors, harmonics and stroboscope. Holding down the SHIFT key while in the cursor menu displays sideband options.

To display symptoms, press SHIFT + F4 in the spectrum window.

# Spectrum functions

Regarding display and available functions, there is no difference between a vibration spectrum and an SPM spectrum. The spectrum type is recognised from the measurement unit and the amplitude unit.

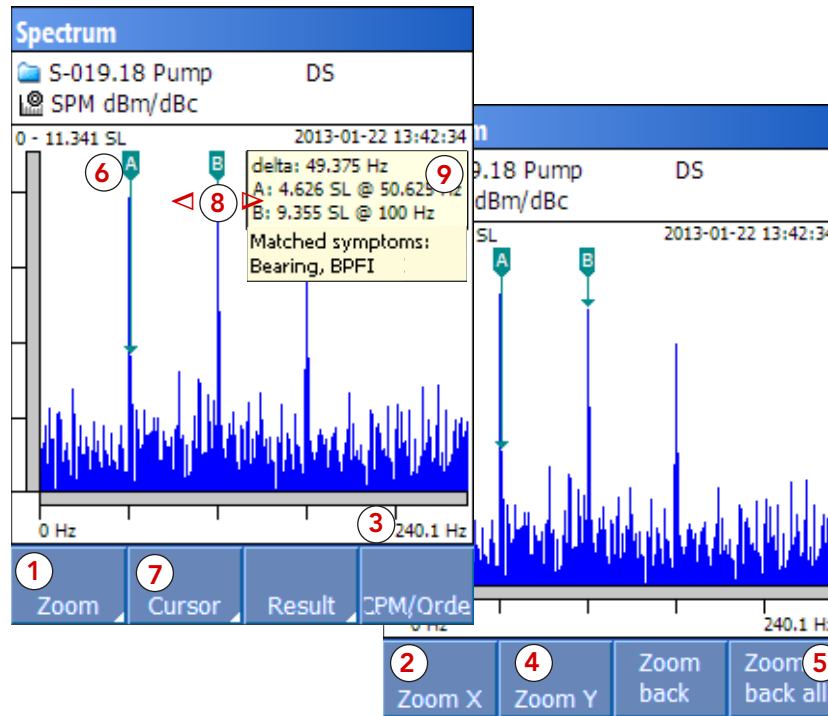

## Zoom

To zoom in on the X axis of the spectrum, press the F1 key ('Zoom') (1) > F1 ('Zoom X') (2). This zooms the display around the center of the current view. To zoom sideways, press SHIFT + F1 (left) or F2 (right).

The displayed frequency range is shown below the diagram (3).

To zoom in on the Y axis, press the F1 key ('Zoom') (1) > F2 ('Zoom Y') (4). The amplitude scale changes.

You can undo the last zoom step with 'Zoom back' or restore the original diagram with 'Zoom back all' (5).

## Cursors

By default, cursor A (6) is already in the spectrum when you open it. To display a second cursor, B, press F2 ('Cursor') (7) > F2 ('Cursor B'). To remove it, press F2 again.

For fine work, move cursor A sideways with the LEFT/RIGHT arrow keys and cursor B with SHIFT + LEFT/RIGHT (8). One step corresponds to spectrum resolution (minimum distance between two spectrum lines).

For each step, the cursor skips to the top of the spectrum line or, if there is none, to the base line (amplitude = 0). Frequency and amplitude of the cursor position are briefly displayed in the upper right corner (9).

When the arrow coincides with a position belonging to a symptom, the name of the symptom is displayed (9). In case several symptoms share the same position, all relevant symptom names are displayed.

B

The purpose of a spectrum is to reveal line patterns associated with machine or bearing faults. Characteristic for many fault patterns is the presence of 'multiples' or 'harmonics', which means that the line (or group of lines) is repeated two, three or more times further up in the spectrum. The spacing is  $1Z$ ,  $2Z$ ,  $3Z$ , ...  $nZ$ , where  $1Z$  = the frequency of the first harmonic.

With the cursor (1) positioned on a spectrum line that has a significant amplitude, press F2 ('Cursor') > F3 ('Harmonics') (2).

A series of numbered, green arrows (3) now show up in the spectrum. Number 1 is in the cursor position. Numbers 2, 3, etc. are the harmonics. They are evenly spaced along the frequency axis at  $Z$  intervals. Moving the cursor one step and back will again display its position and thus  $Z$ .

To remove the arrows from the spectrum, press F3 ('Harmonics') (2) again.

In the second screen shot (right), the cursor is positioned on a different spectrum line in the pattern and the harmonics shown. This spectrum line has one harmonic within the displayed frequency range.  $Z$  in this case is doubled.

Please note that cursor number 1 in the lower figure also matches the symptom 'Bearing, BPF1'. This shows that the symptom is configured to look for multiples of the basic pattern. More about symptoms overleaf.

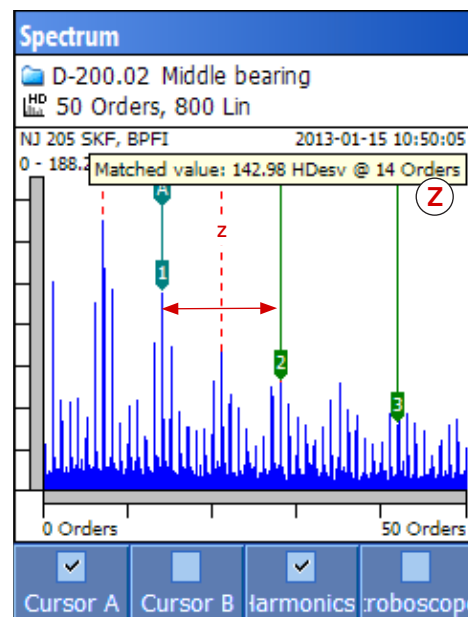
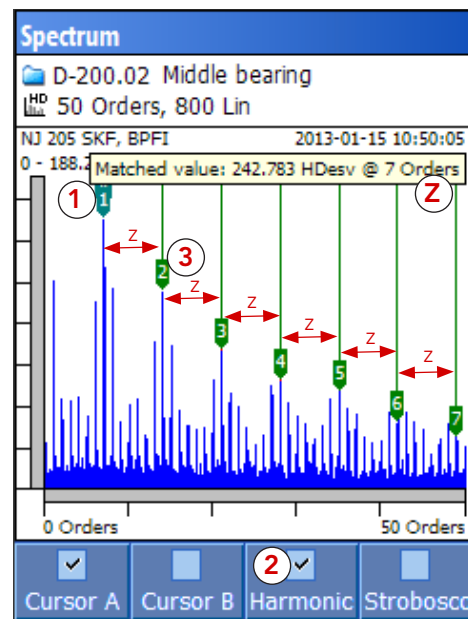

The F1 ('Measuring result') key opens a window with further options for the spectrum window; use the UP/DOWN arrow keys to select a symptom (1) for display, and the function keys F1 ('Previous result') and F2 ('Next result') to toggle between measuring results.

'Symptoms' are instructions to search for and highlight spectrum lines or groups of spectrum lines that are typical for certain machine faults. Their purpose is to point out the significant data contained in the spectrum.

Symptoms are selected and configured when the measuring point is created in Condmaster. They are downloaded with the measuring round. The only factor added in Leonova is normally the machine speed (unless the measuring point is configured with a fixed rpm, which it should not be when spectra are measured).

For a spectrum, the list of symptoms shows the symptom value, i. e. the RMS value of the included symptom lines (1). When the spectrum is measured with an appropriate resolution and over a frequency range large enough to accommodate the pattern, the number of matches will normally equal the number of lines in the symptom.

Pressing the MENU function key in the spectrum window opens further functions for the spectrum (2).

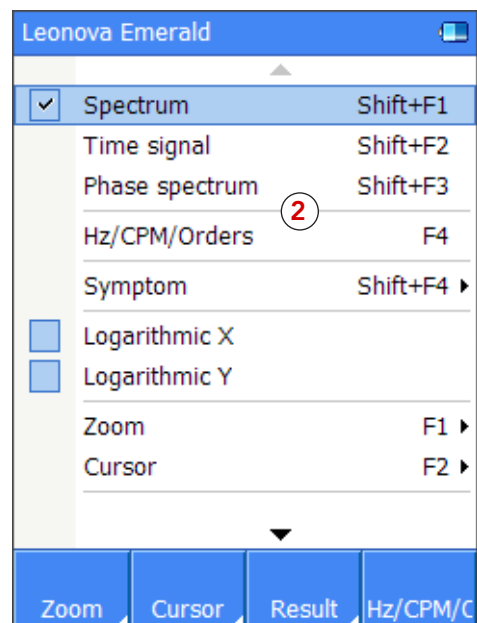
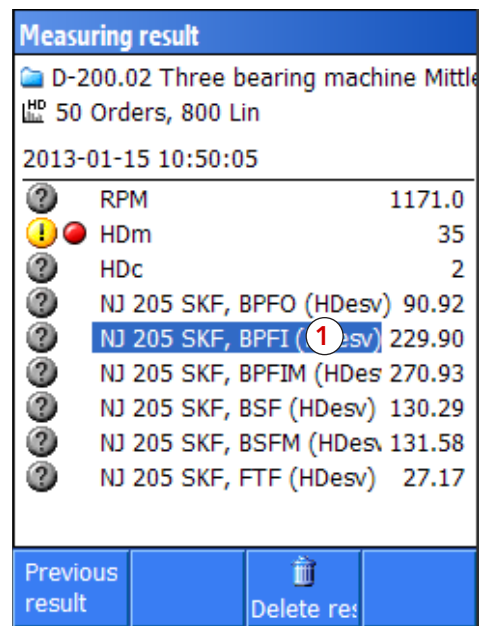

B

The effect of a logarithmic Y-scale is illustrated to the right, using a downloaded vibration spectrum.

The amplitude scale of a spectrum is automatically scaled to accommodate the largest spectrum line (1). Thus, a dominant line will make most others invisible, which is desirable, because the lines containing very little energy are insignificant for the evaluation of machine condition. In this example, the amplitude scale is approx. 6 mm/s, so even the largest spectrum line is fairly small.

Switching to a logarithmic scale amplifies the low amplitude values (2). The amplitude unit gets the addition 'LOG' (3). This display form clearly shows that the FFT calculation produces spectrum lines in almost every position, most with amplitudes well below 0.002 mm/s.

The two lower screen shots show the same spectrum with the Y scale in dB; (4) is scaled according to European standard and (5) according to US Navy standard.

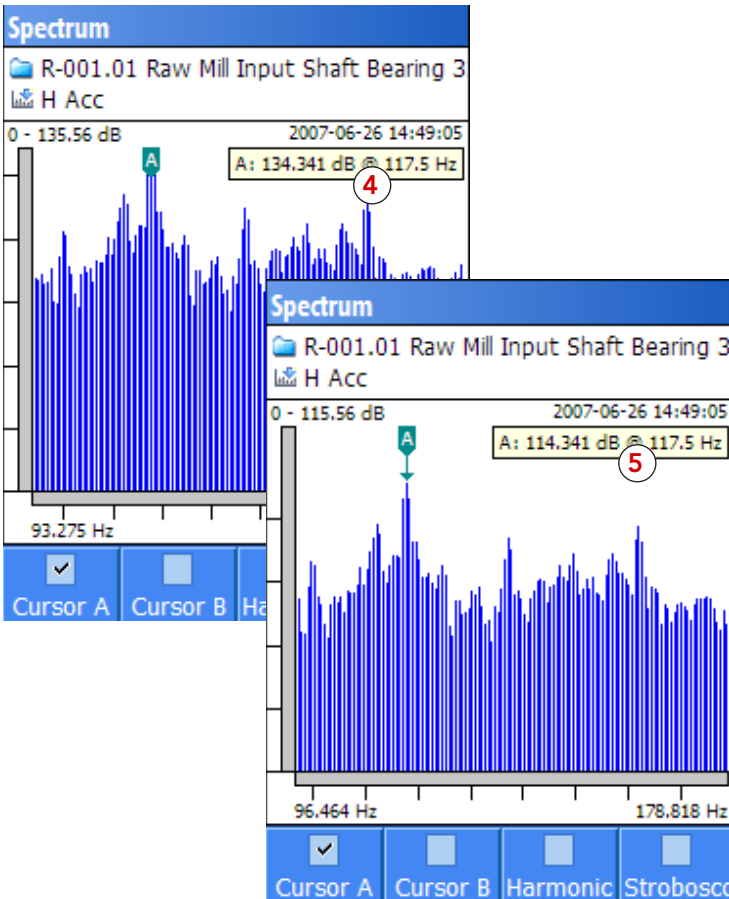
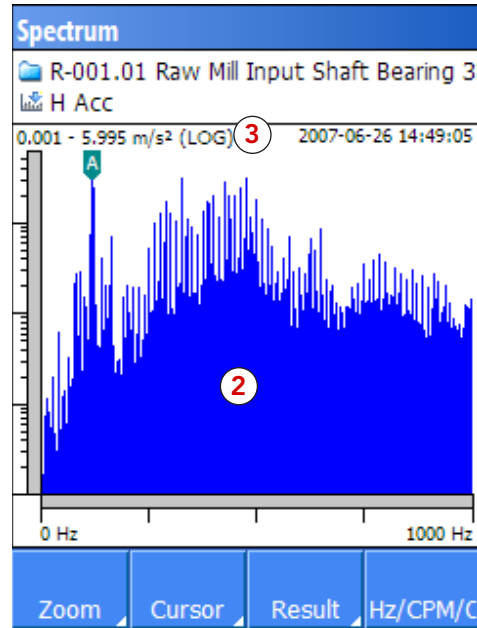
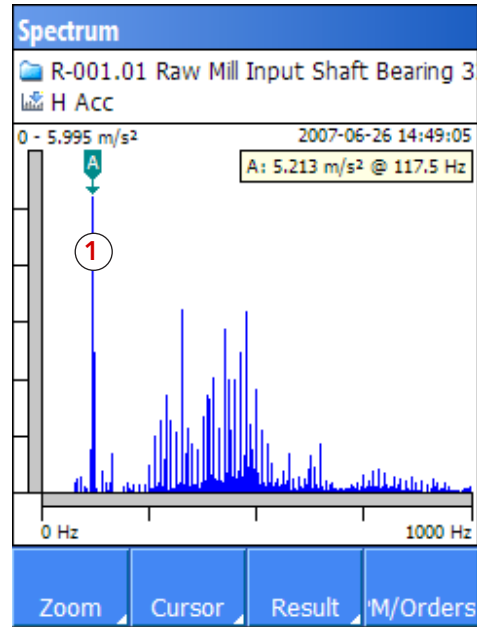

B

# Highlighted symptoms in the spectrum

The following examples show different options on the 'Settings' menu and their effect on the spectrum display.

A. Symptoms are not marked in the spectrum.

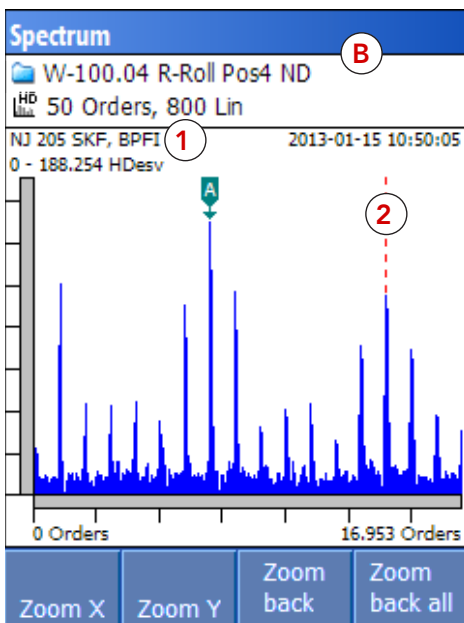
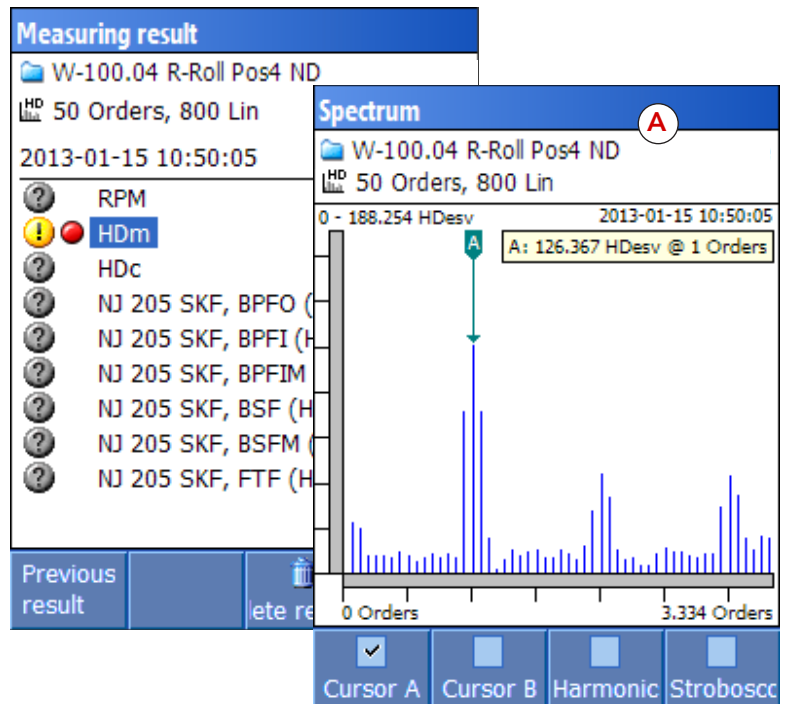

B. The symptom name is shown (1). The symptom line is marked with a red dashed line (2) if a match is found in the spectrum. To find the match, Leonova searches for the closest peak line within the tolerances programmed in Condmaster.

C. The symptom name is shown, plus the text 'Theoretical symptom' (3). The line in the calculated symptom position is marked with a blue dashed line (4). Leonova does not search for the closest peak.

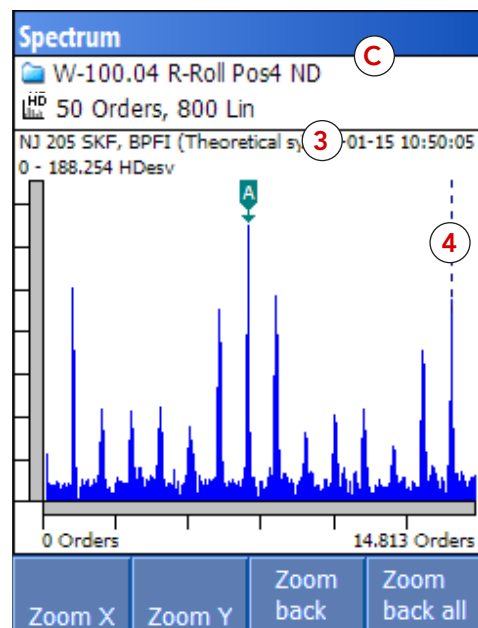

The previous page illustrated the three basic alternatives on the 'Settings' menu with single line symptoms. Below are examples of multi-line symptoms.

D. Same as B, but containing the first harmonic at BPF1 plus three harmonics, altogether four possible matches (5). In this example, the match found by Leonova agrees with the obvious peaks in the spectrum: all dashed lines are on top of the largest lines (5).

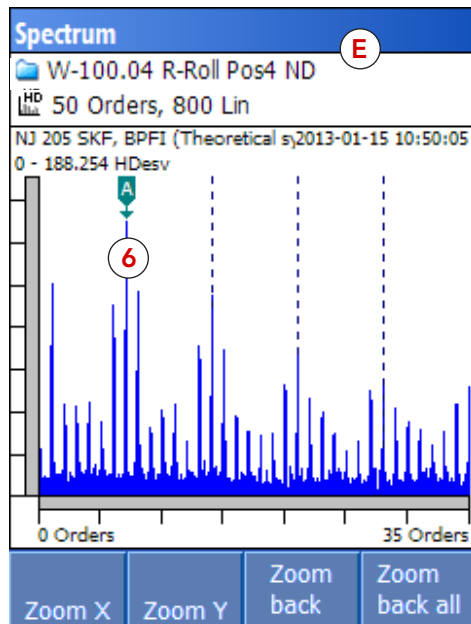
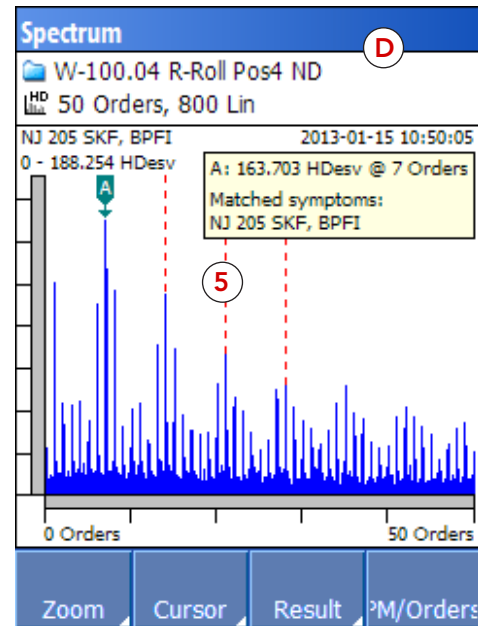

E. Same as C, marking the positions where BPF1 and its three harmonics **should be** according to the calculations. In case of the first line (6), reality as reproduced by the FFT agrees with the calculation. However, the next three lines in the pattern are not quite in their calculated positions: they are beside the dashed lines (7).

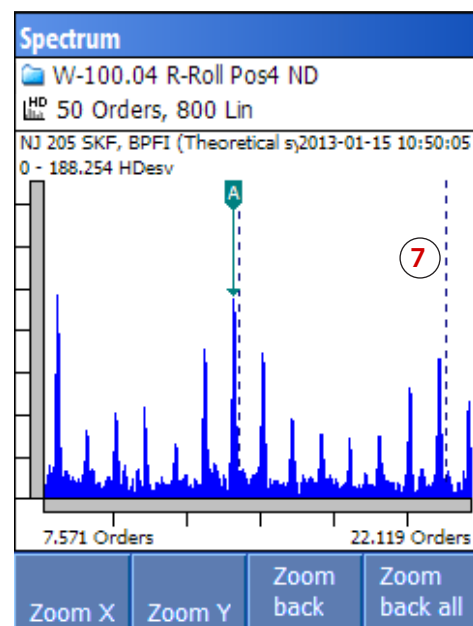

Please note that such near misses are normal, especially for the more rigid 'Theoretical symptom'. Vibration itself is a continuous event, which is first digitalized during measurement and the subjected to mathematical manipulations to get the spectrum. At every step, there are tolerances, so an offset must be expected.

The resolution of this spectrum is  $\approx 1$  Hz, so the line is offset by a single digital step.



## Multi-line symptoms with harmonics

The symptom register in Condmaster contains a number of symptoms searching for groups of lines. These are of three kinds:

- a harmonics of a single frequency line
- b side bands to a single frequency line
- c harmonics of a side band pattern.

Note that 'harmonics' are also called 'multiples' and 'orders'. Alternative a) is illustrated on the previous page.

Damage on the rotating inner race of a bearing typically affects the line at the ball pass frequency over the inner race (BPFI). Quite often it also produces side bands to this frequency line. In Condmaster, the symptom BPFIM (M = modulation) is configured to show two sidebands on either side of the centre line BPFI, which is not highlighted (F).

Adding the marker to the centre line of the pattern displays the position of BPFI and shows that it is covered by its own symptom (G).

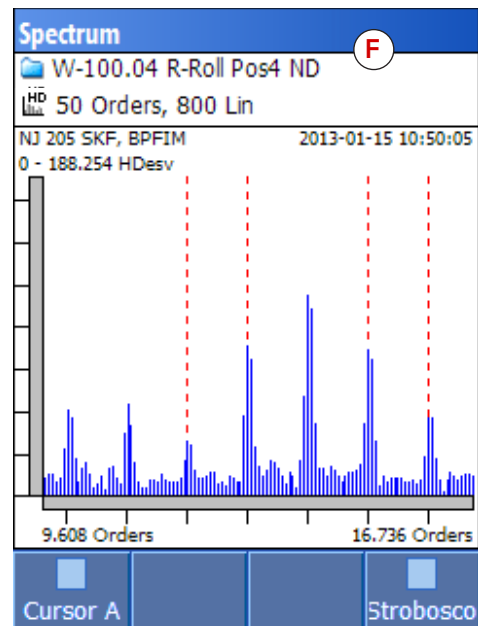
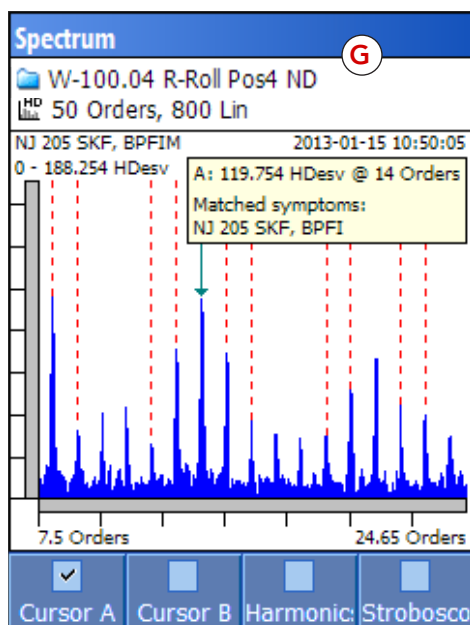

B

Harmonics of a side band pattern tend to put a lot of highlighters into the spectrum, which can be confusing. There is also a strong possibility that the multiples of the basic pattern overlap.

In the symptom shown below (H, I), the number of side bands has therefore been reduced to two on either side of the center line.

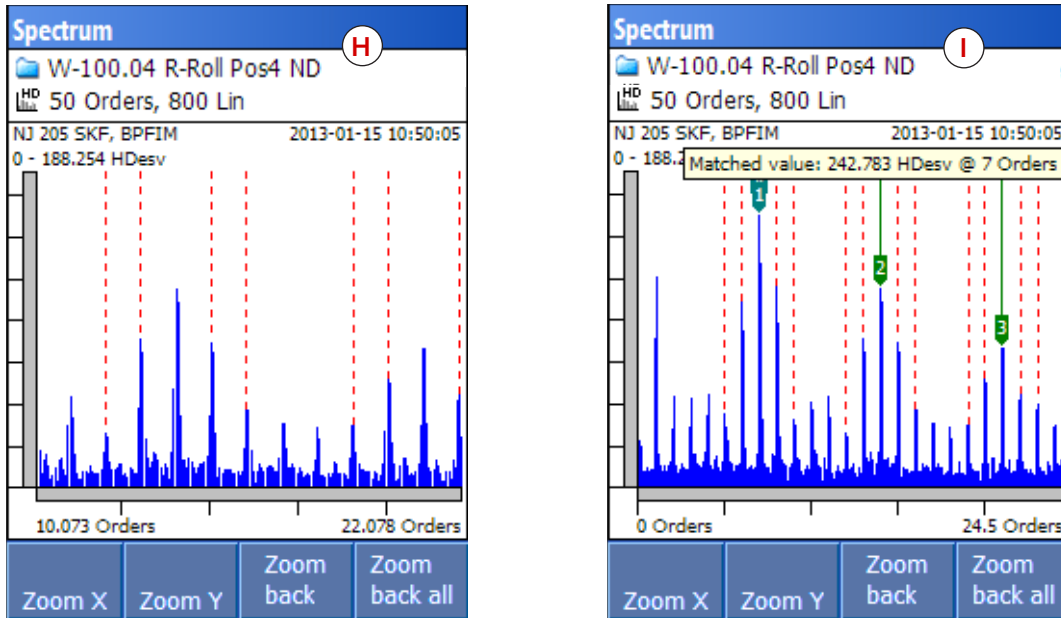

The pattern in (H) is made clearer by placing marker on top of the BPF line and selecting 'Show harmonics' (I).

Please note: While the **presence** of side bands and multiples in a spectrum is significant, the **actual number of such elements is not important**. The job of a symptom is to point out relevant data, not to find 'everything'.

Zooming in on the spectrum and sweeping a cluster of lines reveals how close together significant lines can be.

The BPF factor of this bearing is 7.75, so the harmonics of BPF are spaced  $7.75 * \text{RPM} / 60$  apart. The symptom 'Bearing, BPFIM' looks for four harmonics but only two side bands.

## Waterfall diagram

The waterfall diagram is a three dimensional display of up to 99 vibration spectra. The different readings are displayed along the Z coordinate, with the latest reading in the front.

To display a waterfall diagram, press the F3 key ('Spectrum') in the measurement window. In the spectrum window, press MENU > 'Waterfall diagram' (1).

You are prompted to select a number of diagrams to show (2). In this screen shot example, three diagrams are shown.

Cursors only apply to the spectrum in the front. For the cursor position in the spectrum, the frequency, amplitude and phase angle are shown (3).

Settings and other graphical functions are the same as for spectrum, see 'Spectrum functions' earlier in this part of the manual.

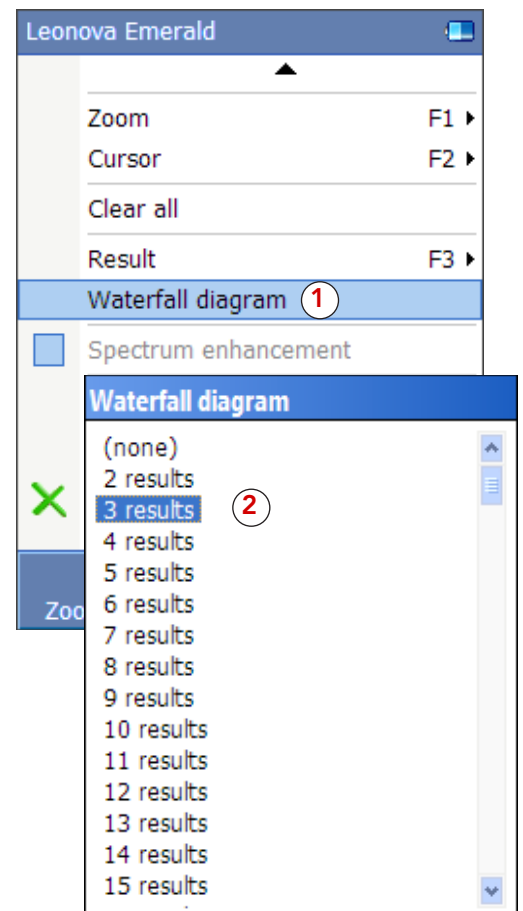
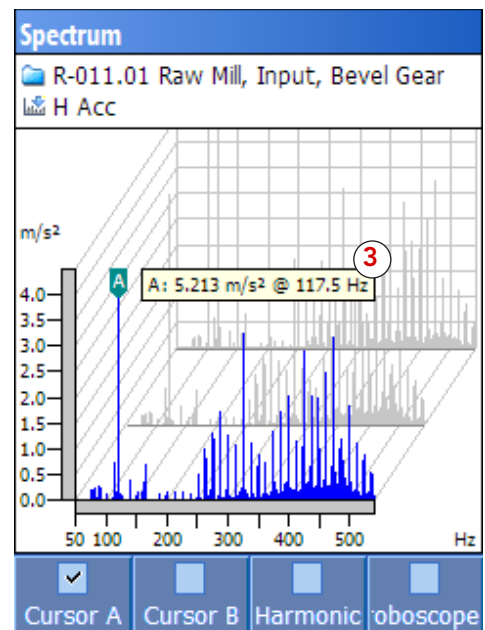

B

# Phase spectrum

If a time signal is measured together with a tachometer pulse, a phase spectrum can be displayed.

To view a phase spectrum, go to the Spectrum window and press MENU > 'Phase spectrum' (1).

The blue cursor (3) is displayed by default. It can be removed with F2 ('Cursor') > F1 ('Cursor A'). For the marker position in the spectra, frequency, amplitude and phase angle are shown (4).

Move the blue marker with the LEFT/RIGHT arrow keys.

In the Phase spectrum window, you can select MENU > 'Show phase noise' (2) to see the phase angle for each line included in the spectra.

All other settings and graphical functions are the same as for spectrum, see 'Spectrum functions' earlier in this part of the manual.

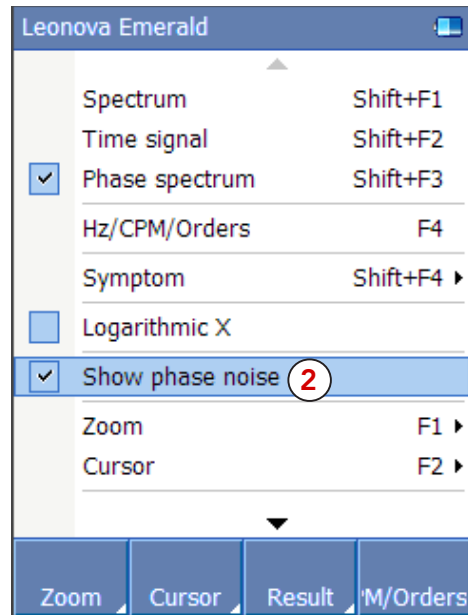
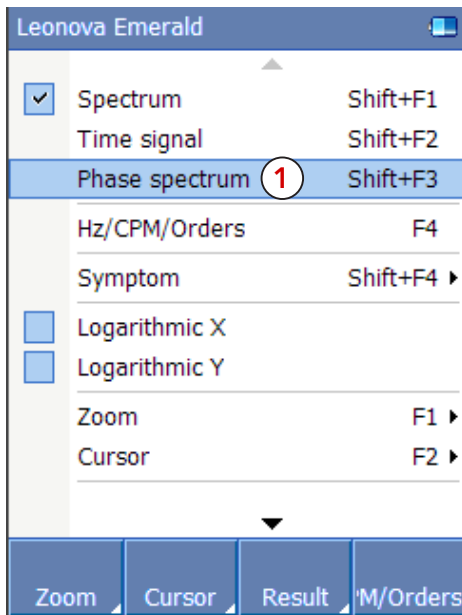
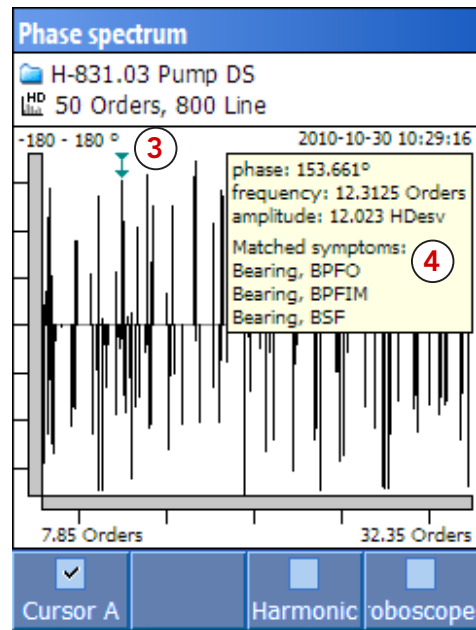

B

## The time signal

For vibration and SPM HD measurements, the time signal can be saved. It can be seen directly after measuring and before saving, or by calling up any stored measurement for the active measuring point.

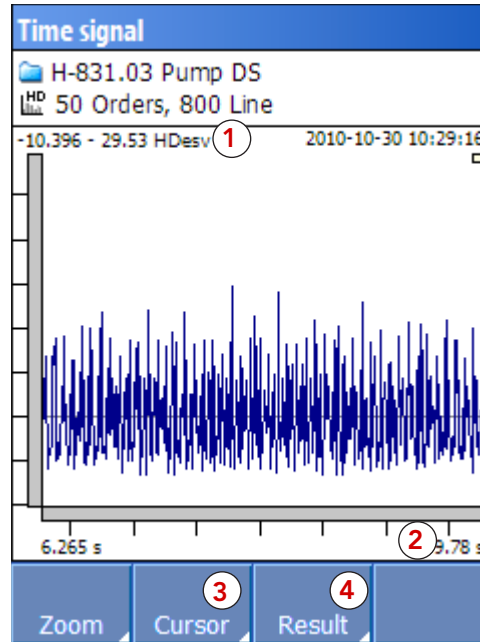

The measuring unit (1) is always the signal unit. The diagram is scaled peak to peak (Y axis) and shows the total sample time (2) along the X axis.

In the time signal there is no default cursor; you can add them to the graph with F2 ('Cursor') (3) > F1 and F2. See further information overleaf.

Using the F3 function key ('Result') (4), you can toggle between measurement results and lock the Y axis scale.

The MENU key option 'Clear all' removes markers and other indicators, and also removes a time signal that was selected from the list of saved time signals.

To zoom in on a time range, press the F1 key ('Zoom') (1) > F1 ('Zoom X'). This zooms the display around the center of the current view. To zoom sideways while in zoom mode, press SHIFT + F1 (zoom left) or F2 (zoom right).

To zoom in on a part of the amplitude scale, press the F1 key ('Zoom') (1) > F2 ('Zoom Y'). The amplitude scale changes.

To put a **cursor** (2) into the spectrum, press F2 ('Cursor') (3). With cursor A inserted, you can add a second cursor, B (4).

The frequency for the period between the cursors (5) is shown in Hertz, together with delta values (6):

- Delta time = time between the two cursors
- Delta amplitude = difference in amplitude between the two cursors.
- Delta phase = difference in phase angle between the two cursors.

**Note:** Phase angle is shown only if rpm is measured.

When two cursors are in place, you can activate periods by pressing F3 ('Periods') (7). This creates multiples with the same distance as that between cursors A and B (8). This feature is a useful aid for identifying fault symptoms.

While in cursor mode, the cursors can be moved sideways; move cursor A with the LEFT/RIGHT arrow keys and cursor B with SHIFT + LEFT/RIGHT. For each step, the time and amplitude of the spot beneath the marker are briefly displayed.

To mark a different period, use MENU > 'Clear all' and start again.

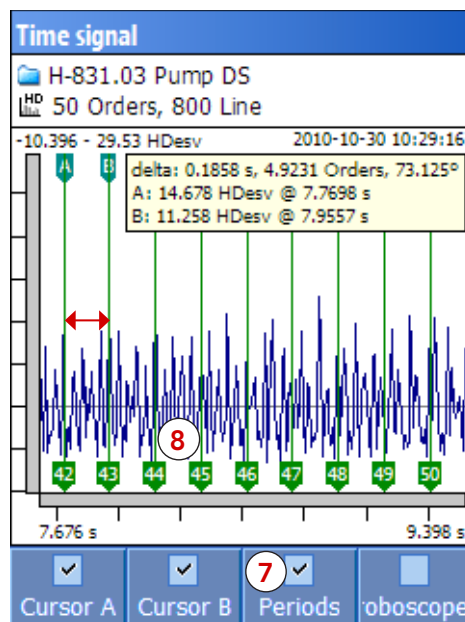
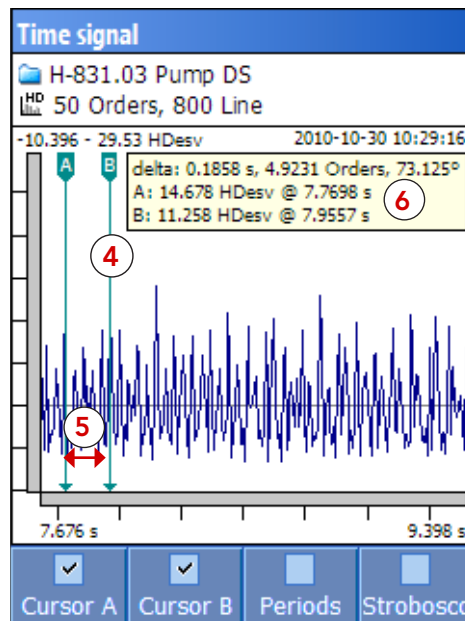
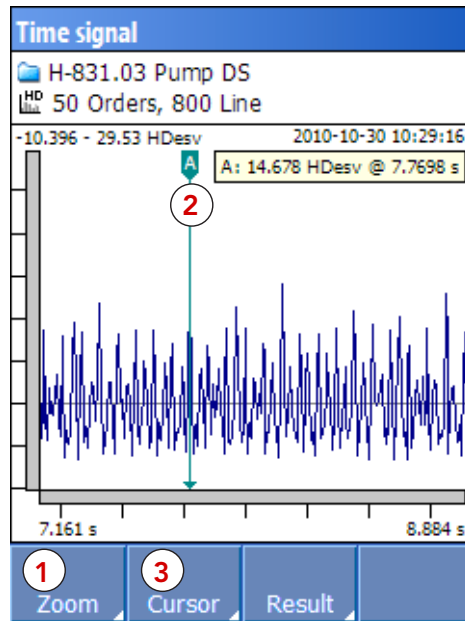

## Determine RPM from spectrum

It is possible to determine rpm from a vibration spectrum when the measurement is performed without specifying the rpm.

To activate this function, go to MENU > 'Settings' > 'General Settings' > 'File' tab (1) and mark 'Possible to determine rpm from spectrum' (2).

Under 'Measuring point data' for the measuring assignment, the following settings are required:

- 'Variable speed' enabled (3)
- 'Measure RPM simultaneously' set to 'No' (4)

When you press the MEASURE/SAVE (M/S) key, you are prompted to select how to determine rpm. Select 'Determine rpm from spectrum' (5).

When the measurement is completed, press F3 ('Spectrum') to go to the Spectrum window. Use the LEFT/RIGHT arrow keys to move Cursor A (6) to the assumed rpm (1X) in the spectrum.

In the spectrum window, press the MENU key and select 'Set RPM from cursor' (7). A window (8) opens where you can verify the selected peak and the corresponding rpm value before saving with the ENTER key.

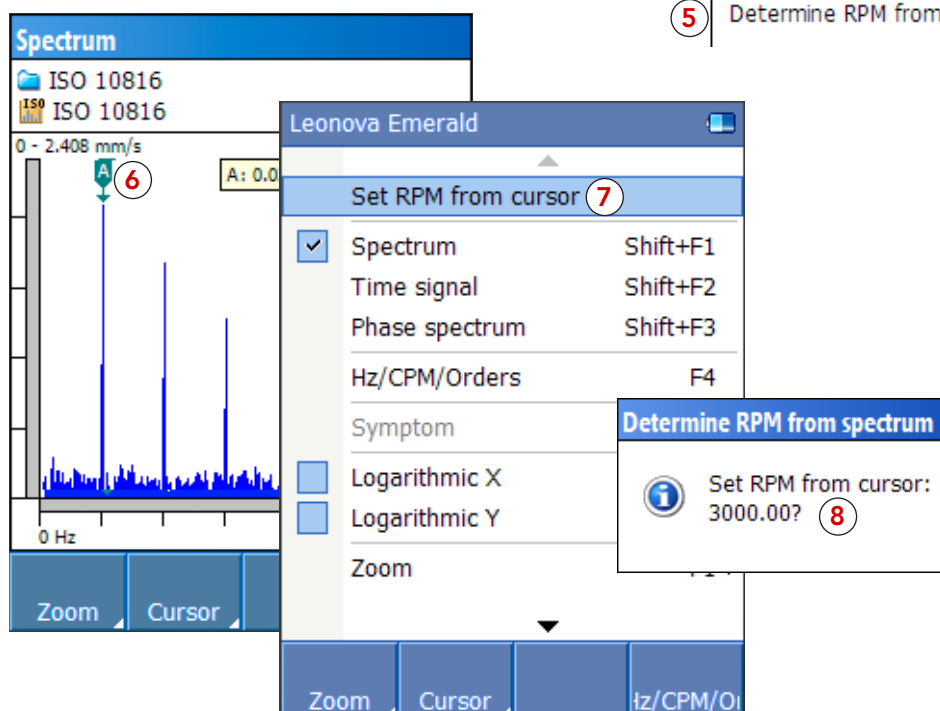
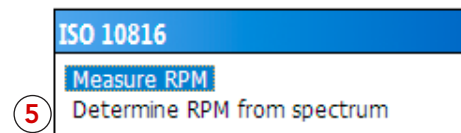
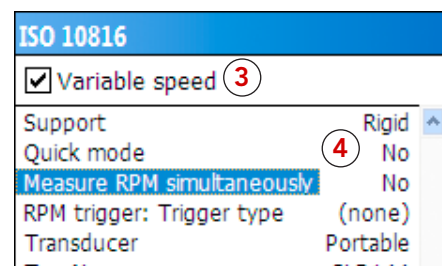
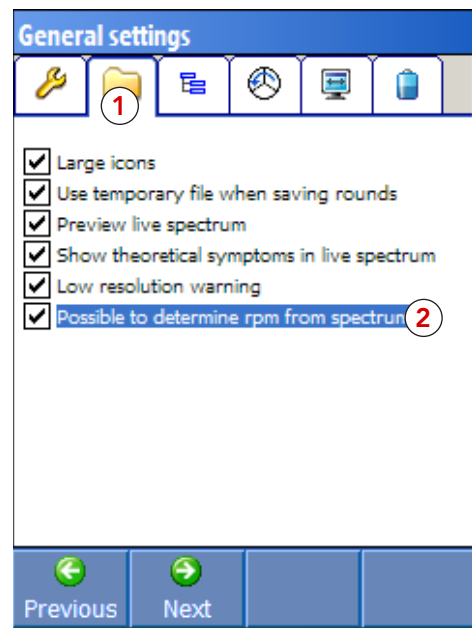

B

## HD Order Tracking

HD Order tracking is an optional Leonova function primarily used for SPM HD and vibration analysis on variable speed machines.

The method uses multiples of rotational speed (orders), rather than absolute frequency (Hz). The number of orders to be shown is input by the user. Leonova will then automatically set the sampling frequency to an exact multiple of the measured rpm. Order tracking will also minimise the risk of smearing when using FFT averaging.

The purpose of using orders is to lock the display to the rotational speed (1X) and its multiples, which means that the ordered components in the spectrum always remain in the same position in the display, even if the rotational speed varies between the measurements.

Two or several spectra from the same machine with variable speed can therefore more easily be compared if they are expressed in orders. Using order tracking, the frequency range will always cover the symptoms of interest, regardless of the rotational speed of the machine.

To activate Order Tracking, go to MENU in the measurement window > 'Measuring point data' (1) and select 'Order tracking' (2). Press ENTER to mark the 'Order tracking' checkbox (3). Enter the desired number of orders (4) and press F1 to save and BACK to return to the measurement window.

The lower frequency is input in Hz or CPM under 'Measuring point data'. The upper frequency is shown in orders. 'Variable speed' must be marked and rpm has to be measured.

Other graphical functions and settings are the same as for spectrum, see 'Spectrum functions' earlier in this chapter of the manual.

Setup of order tracking assignments in Condmaster requires one of the following optional software modules:

- MOD134 (FFT with symptoms)
- MOD135 (EVAM)
- MOD193 (Vibration Expert)
- MOD197 (Vibration Supreme)
- MOD195 (SPM HD Expert)
- MOD140 (HD Analysis)

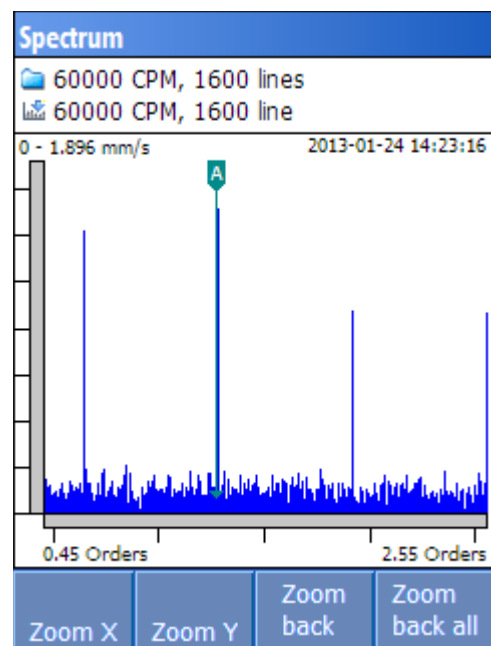
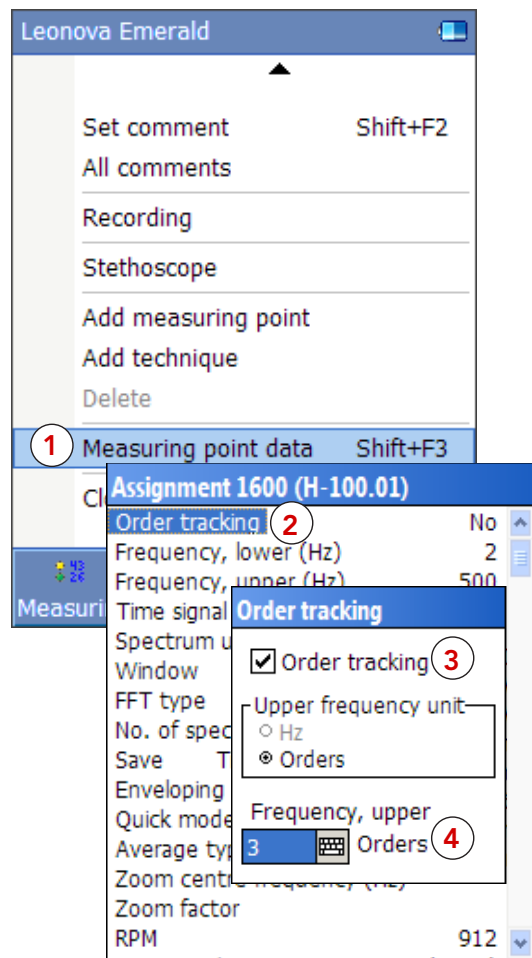



# Measurement techniques always included

## Contents

Measurement techniques always included .....	3
RPM measurement .....	4
RPM measurement with default file .....	5
Temperature measurement .....	7
Temperature measurement with default file.....	8
User defined (manual input) .....	9
User defined (manual input) with default file .....	9
Vibration severity measurement .....	10
Definition of machine classes according to ISO 2372.....	11
Measuring points for vibration.....	12
Measuring point data for ISO 2372 .....	13
Using the stethoscope function .....	14



## Measurement techniques always included

Leonova is always programmed for an unlimited use of the measurement techniques listed below. Other diagnostic and analytic functions, for shock pulse measurement, vibration measurement, and rotor balancing, are user selected.

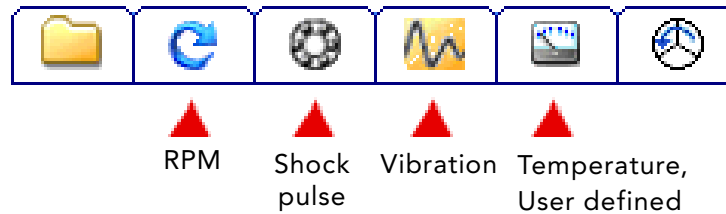

Measurement techniques always included are:

- RPM measurement
- Shock pulse measurement HDm/HDc and/or LR/HR
- RMS vibration, ISO 2372
- Temperature measurement, User defined (manual input)
- Stethoscope (available function under Speed, Shock pulse, Vibration, Temperature)

These measurement techniques and the equipment needed to use them are described in this chapter with the exception of the SPM HDm/HDc and LR/HR technique described in Chapter D.

Measuring points containing the free techniques can be downloaded from Condmaster Ruby, fully configured and ready for measurement.

When the default files under the technique windows are used, the analog measurements and the vibration measurement normally require a configuration under 'Measuring point data'.

# RPM measurement

The SPM laser tachometer/IR temperature probe TTP10 is used for both optical and contact RPM measurement. It is connected to the transducer input marked RPM on Leonova.

A blue LED indicator on the Tachometer and Temperature probe TTP10 lights when reflected light hits the sensor.

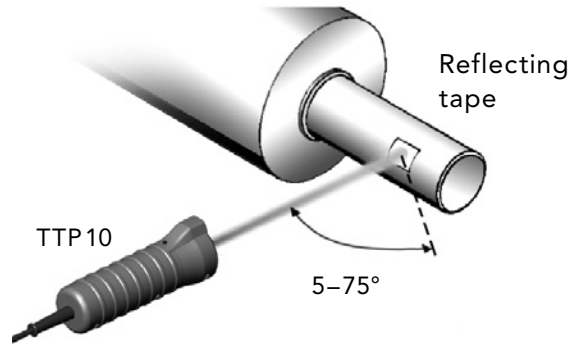
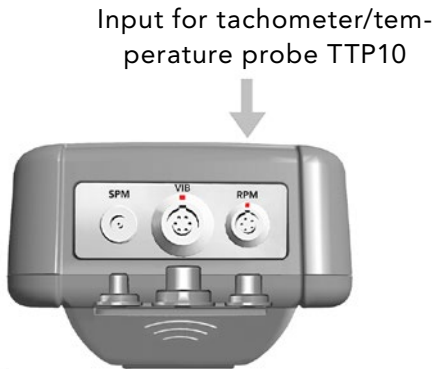

**RPM, optical:**  
Distance 30 to 2000 mm.  
Measuring angle 5 to 75°



**CAB90** Stroboscope cable, 1.5 m spiral, 3.5 mm phones connector

**CAB92** Proximity switch cable, 1.5 m spiral, M12 connector

**CAB95** Keyphasor cable, 1.5 m spiral, BNC connector

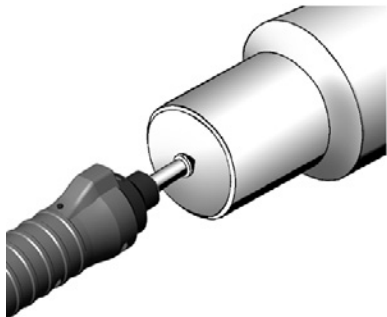

**RPM, contact centre**  
Hold it against the shaft centre

- TAD-11 Short, 30 mm
- TAD-15 Long, 60 mm
- TAD-19 Extra long, 170 mm



**Peripheral, contact wheels**  
Multiply the reading by the wheel factor:

- TAD-12 0.1 m/min. (factor 10)
- TAD-13 0.1 yd./min. (factor 10)
- TAD-17 0.5 ft./min. (factor 2)

## RPM measurement with default file

Please note: to evaluate bearing condition and to make sense of a vibration spectrum, one has to know the rpm of the shaft. This type of RPM measurement is made as part of the shock pulse or vibration measurement, where the RPM technique is automatically included when the point is configured for 'variable speed'.

The RPM measure with the default file (1) is **not** available for other measurements. Press ENTER to open RPM measurement.

Settings (2) are made under 'Measuring point data' (SHIFT+F3). It is possible to change RPM and speed range via the keyboard window. Values outside the range will not be registered. To edit, mark a line in the list with the UP/DOWN arrow keys and open with ENTER.

'Number of pulses' are set to correspond to the number of reflecting tape bits. Leonova will always count the number of pulses (1 rpm for each received light reflex/pulse). The maximum is 150 000 pulses per minute. On slowly rotating parts you can use several reflexes at even intervals.

It is possible to convert RPM to other unit. Specify 'Unit of speed' to desired unit and activate 'Use factor'. Input the conversion factor via the keyboard.

When using a factor or gear ratios, the measured RPM from the tachometer is shown in the lower right corner and the converted RPM value in the middle of the display

'Factor' is also used with contact measurement to convert RPM to peripheral speed.

'Max. fluctuation' is used only for variable speed.

When measuring with the Tachometer and Temperature probe TTP10, select 'Portable' (3) as transducer.

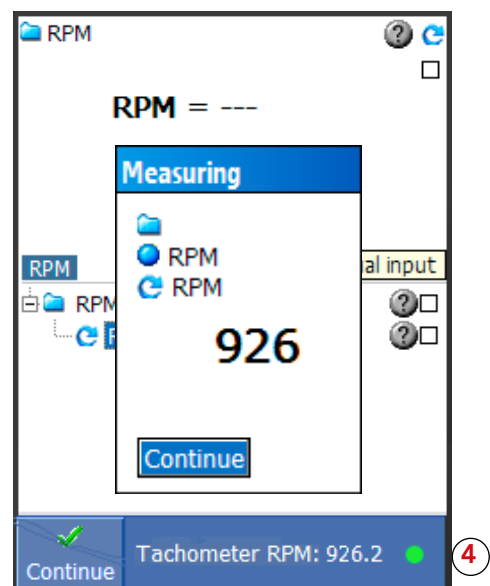
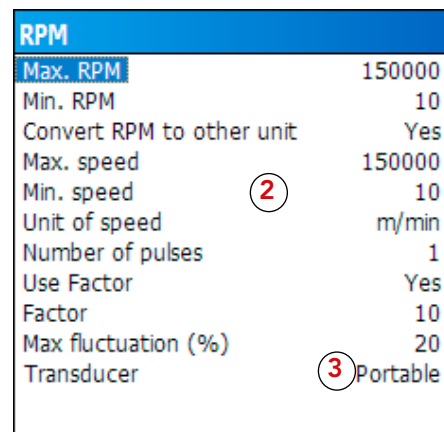
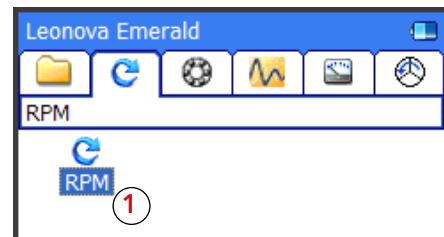

### Optical speed measurement

Easiest is the optical speed measurement. The preparations are simple: paste a bit of adhesive reflecting tape on the rotating part. It has to be reasonably clean.

Direct the laser beam at the reflecting tape and press the M/S key. When measuring on short distance the reflections from the shaft can register false readings. Then try to angle the laser beam towards the reflection tape to achieve a stable result. A blue LED on the Tachometer and Temperature probe shows that the light beam is reflected back to its sensor. A green dot (4) on the display indicates signal from the probe sensor. Red measuring values indicates values out of range. When the count stabilizes, press F1 to continue or save the measurement with the M/S key.

To see or delete measurement(s) before saving, press F1 to see the result window. Press SHIFT+F2 to set a default comment or link a voice recording to the result. See Chapter B, Comments.

To save the result, press MENU and select 'Save as'. Select 'Save a file' and input a name via the keyboard window. Press ENTER to save.

### Contact measurement

For contact measurement, you place the contact adapter over the lens and fix a contact centre or a wheel. The shaft in the adapter has a reflecting surface, and each revolution sends one light reflex to the counter. The contact centre is pressed firmly into the cavity at the centre of the shaft, and the probe is aligned with the shaft's centre line.

The wheels are used to measure peripheral speed. One turn corresponds to 0.1 m, 0.1 yards, or 0.5 feet, depending on the wheel type.

Settings (1) are made under 'Measuring point data' (SHIFT+F3). Mark 'Use Factor' and select 'Yes'. Then mark 'Factor' on the list and press F1 to edit. For meters or yards per minute, set 'Factor' (1) = 10. For feet per minute the factor = 2. Number of pulses = 1.

RPM	
Max. RPM	150000
Min. RPM	10
Convert to speed	No
Number of pulses	1
Use Factor	1 Yes
Factor	10
Max fluctuation (%)	20
Transducer	Portable

### Remote transducer

Other types of transducers can be used by switching the setting of 'Transducer' to 'Remote' (2).

When using a proximity switch the setting of 'Transducer type' is 'PNP' or 'NPN' (3). The setting of '12V Supply' should be 'ON' (4).

RPM	
Max. RPM	150000
Min. RPM	10
Convert to speed	No
Number of pulses	1
Use Factor	Yes
Factor	10
Max fluctuation (%)	20
Transducer	2 Remote
Transducer type	PNP
12V Supply	OFF

Transducer type	
PNP	3
NPN	
Key Phasor	

When Leonova is connected to a stroboscope, the setting of 'Transducer type' (3) is normally set to 'NPN'. Some types of stroboscopes require the setting 'PNP'. The setting of '12V Supply' should be 'OFF' (4).

When Leonova is connected to a Key Phasor for rpm measurements, the setting of 'Transducer type' is 'Key Phasor'. '12V Supply' (4) should be 'OFF' (4).

### Manual input

For manual input of speed, press ENTER and input the speed via the keyboard window.

RPM	
Max. RPM	150000
Min. RPM	10
Convert to speed	No
Number of pulses	1
Use Factor	Yes
Factor	10
Max fluctuation (%)	20
Transducer	Remote
Transducer type	PNP
12V Supply	OFF

12V Supply

ON

OFF 4

## Temperature measurement

The SPM laser tachometer/IR temperature probe TTP10 is used for temperature measurements in the range of  $-20$  to  $+300$  °C ( $-4$  to  $+572$  °F). Measuring accuracy is  $\pm 2.5$  °C.

The probe has an infrared sensor that allows you to accurately measure the temperature of a surface without having to come in contact with it.

The probe is connected via the spiral cable to the RPM input on Leonova. It is power supplied by the instrument.

Keep the protective adapter on the probe when the probe is not used.

To measure, move the laser point so that it is on the area to be measured and press the M/S key. Make sure that the target is larger than the unit's spot size. The smaller the target, the closer you should be to it.

**Caution:** Never point the sighting laser in somebody's eye.

The laser tachometer/IR temperature probe has distance to spot size (D/S) 8:1, meaning that if the probe is 800 mm from the target, the diameter of the object must be at least 100 mm (see the diagram beside). When accuracy is critical, make sure the target is at least twice as large as the spot size.

Input for tachometer/temperature probe TTP10



Distance (D) to Spot size (S) = 8:1

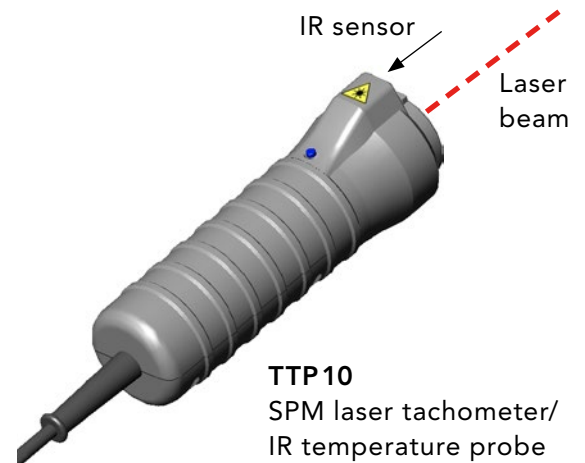
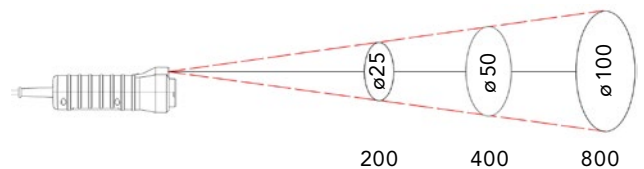

## Temperature measurement with default file

The default file for temperature measurements is located in the 'User defined' window (1). There are no settings under 'Measuring point data'.

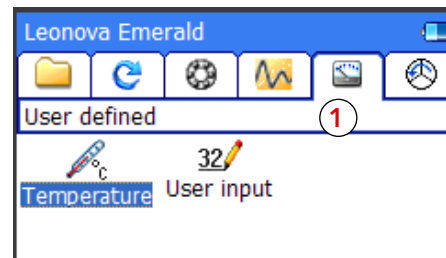

The result is displayed with a decimal, but please note that the accuracy of the SPM laser tachometer/IR temperature probe is  $\pm 2.5^{\circ}\text{C}$ .

The change from  $^{\circ}\text{C}$  to  $^{\circ}\text{F}$  is made under 'General settings' (2) in the SETTINGS window. Switching from one unit to the other will re-calculate all saved results and display them in the active unit.

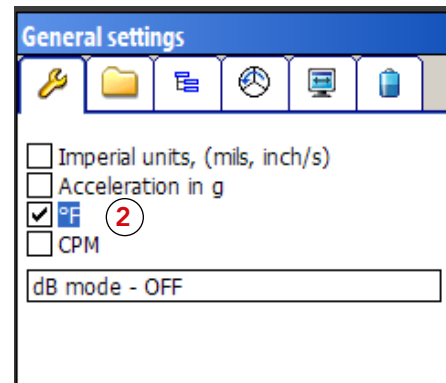

After pressing the measure key (M/S) you can select type of material (3) to obtain as accurate readings as possible.

Select material to be measured (emissivity) with RIGHT/LEFT arrow keys:

- Paint
- Black body
- Iron rusted
- Iron oxidized
- Aluminium unoxidized
- Aluminium oxidized
- Lead oxidized
- Brass polished
- Brass oxidized
- Copper rough polished
- Copper black oxidized

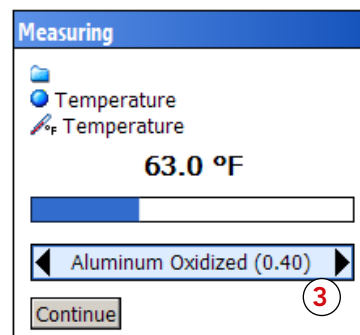

Press F1 'Continue' or ENTER to stop reading. Save the result with the M/S key.

To see or delete measurement(s) before saving, press F1 'Measuring result' (4) to see the result window. Press SHIFT+F2 to set a default comment or link a voice recording to the result. See Chapter B, Comments. Press F2 to go to graphics (see Chapter B, Graphics)

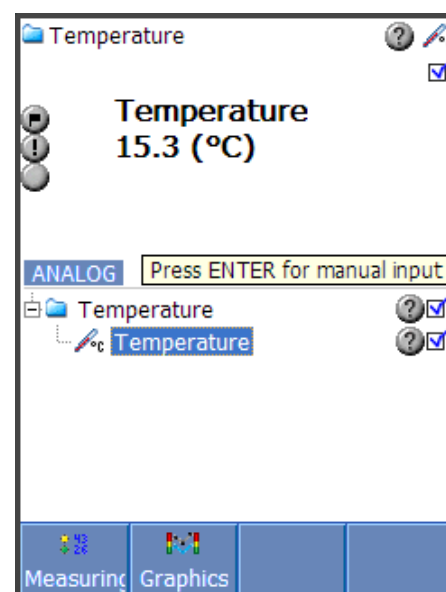

To save the result, press MENU and select 'Save as'. Select 'Save a file' and input a name via the keyboard window. Press ENTER to save.

For manual input of temperature, press ENTER and input the temperature via the keyboard window.



## User defined (manual input)

During a measuring round, a reference value of preferred quantity can be saved in relation to the other measuring values. Leonova Emerald is missing the option for analog signals, but there is a possibility to manually input a user defined measuring value such as current, flow, pressure, etc.

While in a measuring round with 'User defined' values (1), press ENTER and input the value manually via the keyboard window.

Usually, user defined units for manual input is set up within a round in Condmaster. If you want to manually input values outside a measuring round, an icon for user input is located in the 'User defined' window (2). (See below for more information.)

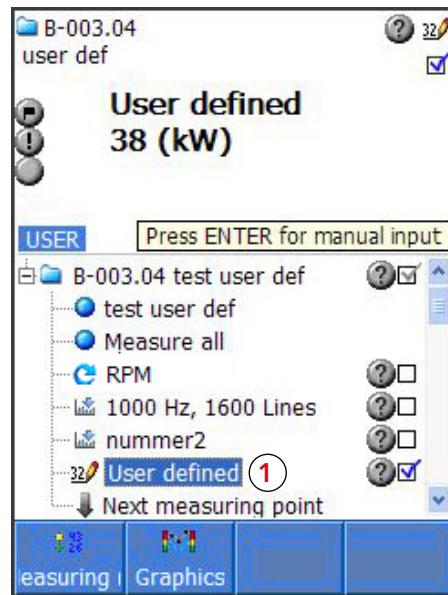

## User defined (manual input) with default file

For manual input of values outside a measuring round, an icon for user input is located in the 'User defined' window (2). Press ENTER to open the measuring window (bottom picture). Configure files for manual input measurements by pressing SHIFT+F3 to open 'Measuring point data'.

'Type' is always set to User input and can not be changed. 'Type' is shown as the measuring point name in the measurement window (3). 'Quantity' is what the manual input represents, e. g. power, flow, pressure. Mark this line and press 'Edit' (F1). Write the new name in the keyboard window and save with ENTER. It will be displayed above the result in the measurement window (4).

'Unit' is the measurement unit for the new quantity, here 'bar' for oil pressure. It is displayed in brackets above the result field (5). 'Format' defines the number of digits and the position of the decimal point in the result (6). Write a '#' for each digit.

To save the result, press MENU and select 'Save as'. Select 'Save a file' and input a name via the keyboard window. Press ENTER to save.

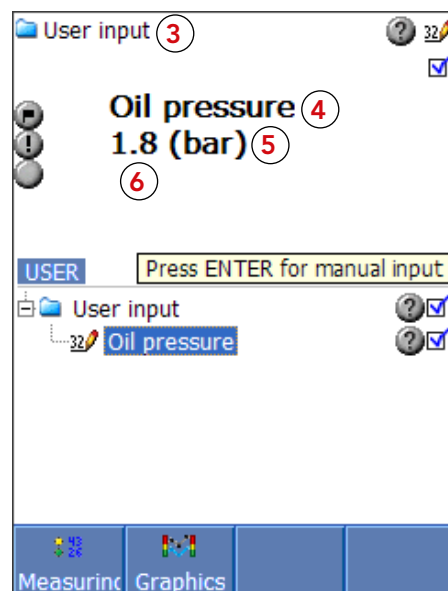
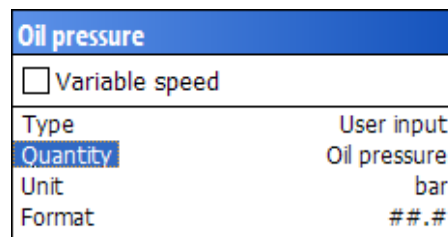
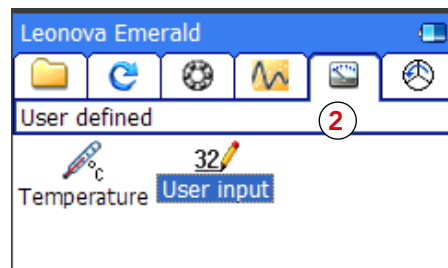

# Vibration severity measurement

Vibration severity measurement according to ISO 2372 is a broad band measurement over the frequency range 10 to 1000 Hz. It returns the RMS value of vibration velocity in mm/s (or inch/s). This value is representative of the energy contents of machine vibration, and thus of the destructive forces acting on the machine. It is still widely regarded as a good and easy to obtain indicator of general machine condition.

## Evaluation of machine condition

The evaluation consists of a comparison of the measured value with the ISO limit values recommended for 6 different classes (see definition on the next page).

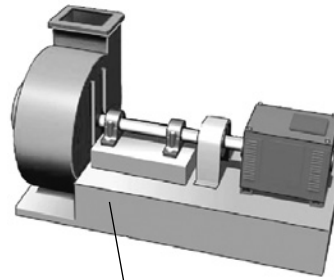

The majority of industrial machinery belongs to the vibration classes 2, 3, and 4:

Class 2: Medium size machines without special foundations

Class 3: Large machines on rigid foundations

Class 4: Large machines on soft foundations.

RMS mm/s	ISO2372						RMS in/s
	I	II	III	IV	V	VI	
71	Red	Red	Red	Red	Red	Red	2.80
45	Red	Red	Red	Red	Red	Yellow	1.77
28	Red	Red	Red	Yellow	Yellow	Green	1.10
18	Red	Yellow	Yellow	Green	Green	Green	0.71
11	Yellow	Green	Green	Green	Green	Green	0.44
7.1	Green	Green	Green	Green	Green	Green	0.28
4.5	Green	Green	Green	Green	Green	Green	0.18
2.8	Green	Green	Green	Green	Green	Green	0.11
1.8	Green	Green	Green	Green	Green	Green	0.071
1.1	Green	Green	Green	Green	Green	Green	0.044
0.71	Green	Green	Green	Green	Green	Green	0.028
0.45	Green	Green	Green	Green	Green	Green	0.018
0.28	Green	Green	Green	Green	Green	Green	0.011

For example, most smaller process pumps in a chemical plant would be Class 2. A 100 kW fan on a concrete foundation would be Class 3. However, the same fan fastened to the less rigid metal deck of a ship could be considered as Class 4.

Class 1 refers to independent parts of machines, for example electric motors up to 15 kW. Classes 5 and 6 are used for heavy reciprocating prime movers and machines which are intended to vibrate, such as vibrating screens.

Leonova is programmed with the ISO limit values and will evaluate the measuring result, provided the ISO machine class number is input under 'Measuring point data'. On the instrument, the ISO values for good and acceptable are shown as green. Just tolerable is yellow, unacceptable is red.

# Definition of machine classes according to ISO 2372

The following text is a quotation from ISO 2372 (1974, E, page 6, Annex A). This ISO Recommendation has also been published as British Standard (BS 4675, part I). A similar vibration classification of industrial machinery can be found in VDI 2056.

In order to show how the recommended method of classification may be applied, examples of specific classes of machines are given below. It should be emphasized, however, that they are simply examples and it is recognized that other classifications are possible and may be substituted in accordance with the circumstances concerned. As and when circumstances permit, recommendations for acceptable levels of vibration severity for particular types of machines will be prepared. At present, experience suggests that the following classes are appropriate for most applications.

## Class I

Individual parts of engines and machines, integrally connected with the complete machine in its normal operating condition. (Production electrical motors of up to 15 kW are typical examples of machines in this category.)

## Class II

Medium-sized machines, (typically electrical motors with 15 to 75 kW output) without special foundations, rigidly mounted engines or machines (up to 300 kW) on special foundations.

## Class III

Large prime movers and other large machines with rotating masses on rigid and heavy foundations which are relatively stiff in the direction of vibration measurement.

## Class IV

Large prime movers and other large machines with rotating masses on foundations which are relatively soft in the direction of vibration measurement (for example turbogenerator sets, especially those with lightweight substructures).

## Class V

Machines and mechanical drive systems with unbalanceable inertia effects (due to reciprocating parts), mounted on foundations which are relatively stiff in the direction of vibration measurement.

## Class VI

Machines and mechanical drive systems with unbalanceable inertia effects (due to reciprocating parts), mounted on foundations which are relatively soft in the direction of vibration measurements; machines with rotating slackcoupled masses such as beater shafts in grinding mills; machines, like centrifugal machines, with varying unbalances capable of operating as self-contained units without connecting components; vibrating screens, dynamic fatigue-testing machines and vibration exciters used in processing plants.

## Measuring points for vibration

Vibration severity is primarily a measure for general machine condition. Vibration at the measuring point should be representative for the overall vibration of the machine. Typical measuring points are the bearing housings. By measuring in three directions, one can get an indication of the causes for increased vibration.

- Horizontal vibration (H) in the plane of rotation is most representative of balance condition.
- Vertical vibration (V) in the plane of rotation is most representative of structural weakness.
- Axial vibration (A) along the line of the shaft is most representative of faulty alignment and bent shafts.

To get comparable results, the measuring points should be clearly marked, so that the measurements can always be taken in the same spots and important, at the same speed. SPM vibration transducers can be used

- as a hand-held probe, with or without the probe tip attached. Not recommended above 1000 Hz.
- with a magnet for attachment to ferrous metal parts. Not recommended above 2000 Hz.
- with the M8 (UNC 1/4"-28) mounting screw.

The firmer the contact with the machine, the better the measuring result. Plain, clean metal makes the best contact surface for the vibration transducer.

The vibration transducer is connected via a twisted pair cable to the VIB input on Leonova. Transducers of type IEPE\* (ICP) with voltage output (<24 Vpp) can be used.

Only one vibration transducer can be connected to Leonova when measuring according to ISO2372. Move the transducer between the three directions (H, V, A) and perform three measurements.

### DuoTech® accelerometers (Dual Technology)

The DuoTech® accelerometer is a single transducer solution used for vibration or shock pulse measurements or both in combination.

- DuoTech with quick connector, TRC100, for use with permanently installed measuring adapters. Connect the DuoTech via the measuring cable CAB82.
- DuoTech for permanent installation, SLC144.

Permanently installed DuoTech accelerometers are mounted in a countersunk mounting holes identical to holes normally used by shock pulse transducers. The accelerometer has 2-pin connector and is connected to Leonova or a measuring terminal via twisted pair cable. DuoTech is connected to the VIB input on Leonova.

### Transducer line quality, TLQ

Leonova is automatically testing the quality of signal transmission between transducers of type IEPE and instrument before measurement. The unit of measure is voltage (Bias). Accepted values depends on transducer settings. Not acceptable values generates an error message.

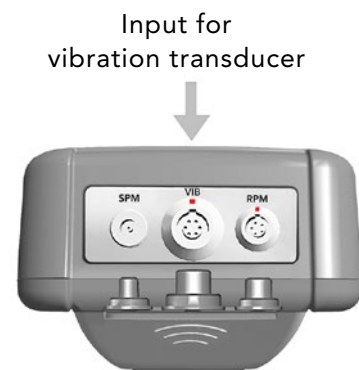
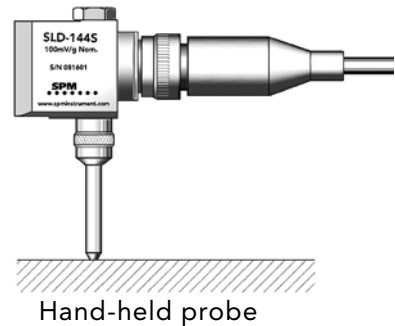
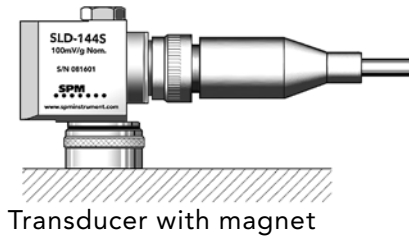
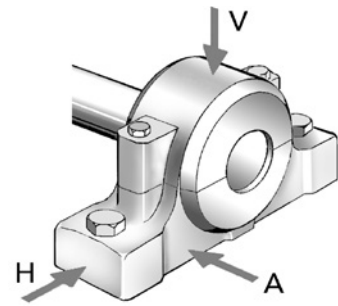

## Measuring point data for ISO 2372

The only measuring point data that should be edited are 'Direction' and 'Class' (1). Press SHIFT+F3 to open 'Measuring point data'. For both, the alternatives are selected from lists after marking the line and pressing F1 'Edit'.

The selected measuring direction appears as measuring point name in the measurement window (2). The selected machine class effects the evaluation of the measuring result (3). Readings in the yellow and red zone are indicated with an alarm flag and a flashing red dot (4) before the value.

'Portable' on the transducer line (5) means that the default transducer for vibration measurements is active. Set up of default transducers is described in Chapter A page 13.

To temporarily use another transducer, press SHIFT+F3 to open 'Measuring point data' and mark 'Transducer' on the list. Press F1 'Edit' and select 'Remote'.

The transducer data become editable after you switch 'Transducer' from 'Portable' to 'Remote'. Provided you know the transducer's frequency range, sensitivity and its upper and lower bias range, you can input the data here.

This temporarily transducer data will be lost when closing the measuring technique but will be saved in the measuring result file.

To measure, connect the transducer and press the M/S key. Save the measurement with M/S. If you do not accept the reading, press SHIFT+M/S to collect a new reading without saving the previous.

To see or delete measurement(s) before saving, press F1 to go to the result window.

Press SHIFT+F1 to see the alarm list. Press SHIFT+F2 to set a default comment or voice recording to the result (see Chapter B, Comments). Press F2 to go to graphics (see Chapter B, Graphics).

To save the result as a file, press MENU and select 'Save as'. Select 'Save a file' and input a name via the keyboard window. Press ENTER to save.

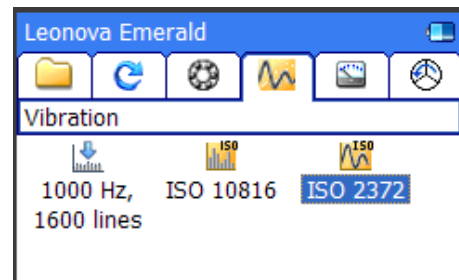

VIB	
<input type="checkbox"/> Variable speed	
Direction	Horizontal
Class	3
Transducer	Portable
Trv: Name	SLD144
Trv: Type	ACC
Trv: Sensitivity (mV/m/s <sup>2</sup> )	10
Trv: Max. frequency	10000
Trv: IEPE type	Yes
Trv: Min. bias range (V)	9.0
Trv: Max. bias range (V)	14.0
Trv: Settling time (sec)	3.0



# Using the stethoscope function

The stethoscope function is useful for detecting machine sound irregularities, such as load shocks and scraping. It is recommended to use a shock pulse transducer with probe or a vibration transducer with probe tip or magnetic foot. Installed transducers can also be used.

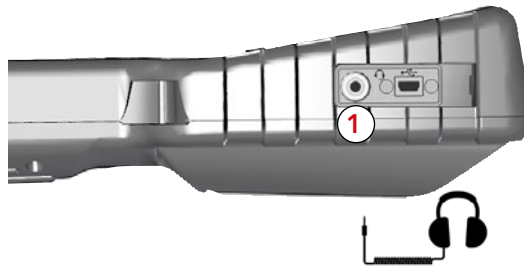

Connect your headphones to the output connector (1). Open one of the measuring techniques under Speed, Shock Pulse, Vibration or Temperature. Press MENU, select 'Stethoscope' (2) and press ENTER.

Source is the transducer input you intend to use. Select with the UP/DOWN arrow keys and press F1 (or ENTER) to confirm.

Hold the transducer against the object. Use LEFT/RIGHT arrow keys to adjust the volume (4).

NOTE! Setting the volume to the maximum level may harm your hearing.

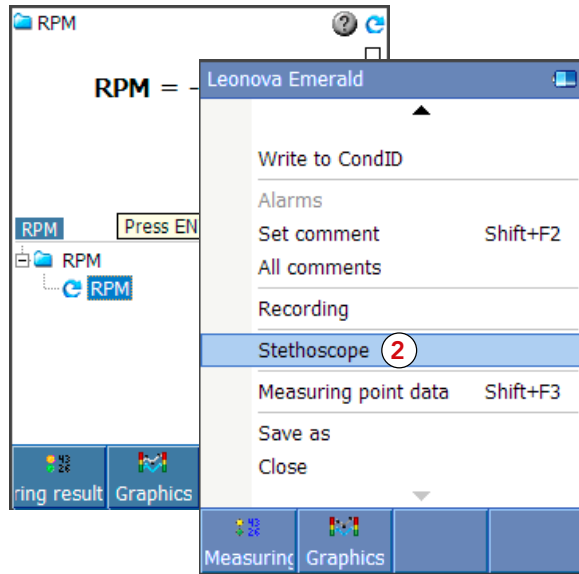

You can filter out high or low frequencies with the high pass/low pass filter (5) at 500, 1000 or 2000 Hz. Press the DOWN arrow key and select filter with the LEFT/RIGHT arrow keys.

When a shock pulse transducer of type 40000 is used, you can select 'High frequency mode' (6). 'High frequency mode' moves frequencies above the audible down to the audible frequency range. Activate/deactivate 'High frequency mode' with the ENTER key. Adjust the amplification (7) with the LEFT/RIGHT arrow keys.

The 'High frequency mode' is always activated when using transducers of type 42000 and 44000. Vibration transducers are working in the audible frequency range and 'High frequency mode' (6) can not be used.

To select source (3), press F1. To return to the measuring technique window, press the BACK key.

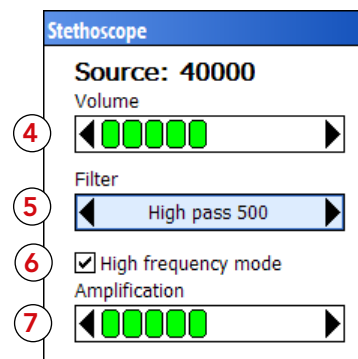
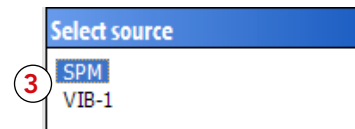

SPM 40000 and 42000 transducers

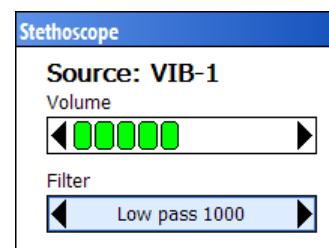

Vibration and SPM 44000 transducers



# Shock pulse measurement

## Contents

Shock pulse techniques.....	3
Rules for SPM measuring points.....	4
Examples of SPM measuring points .....	6
Equipment for shock pulse measurement .....	8
Equipment for shock pulse measurement .....	9
Transducer with quick connector .....	10
Permanently installed transducers/terminal .....	11
Shock pulse transducer with probe .....	12
The SPM HD measuring technique .....	13
Normalized condition readings .....	14
Input data for SPM HD.....	15
Transducer line quality .....	17
Measuring SPM HD .....	18
The dBm/dBc measuring technique.....	19
Input data for SPM dBm/dBc.....	20
Measuring SPM dBm/dBc.....	22
Using the earphones .....	23
The LR/HR and SPM LR/HR HD techniques .....	24
Input data for LR/HR and LR/HR HD .....	25
Accumulation and compensation .....	26
LR/HR values and CODE .....	27
The LUB number .....	28
The COND number and error codes .....	29
Input data for LR/HR and LR/HR HD .....	30
Measuring LR/HR and LR/HR HD.....	32
Measuring an SPM Spectrum .....	33
Editing spectrum data.....	34





# Shock pulse techniques

## SPM HD

Shock pulse magnitude is quantified on a decibel scale by two values, the maximum value **HDm** and the carpet value **HDc**. The input data are very simple: the rpm and the bearing's shaft diameter. The maximum value HDm is evaluated on a green - yellow - red condition scale. It indicates the bearing's operating conditions in terms of good - caution - bad. Operating condition includes factors like installation quality, load, lubrication and the mechanical state of the bearing surfaces.

In Time signal HD, repetitive shocks are enhanced and random signals suppressed using advanced digital algorithms. The Time Signal HD is extremely useful to determine the location of a possible bearing damage. The SPM Spectrum HD, obtained by applying FFT algorithms on the Time Signal HD, is useful for trending purposes (applying symptom and band values).

## SPM dBm/dBc

With the dBm/dBc technique, the shock pulse magnitude is quantified on a decibel scale by the maximum value **dBm** and the carpet value **dBc**.

## SPM LR/HR and LR/HR HD

Shock pulse magnitude is quantified on a decibel scale by the values **LR** (low rate of occurrence, corresponding to the HDm) and **HR** (high rate of occurrence, similar to the HDc). In addition to these 'raw values', the bearing's operating condition is indicated by the evaluation results **CODE** (overall condition), **LUB** (oil film thickness) and **COND** (mechanical state of the surfaces). Thus, condition information is more detailed, with emphasis on bearing lubrication. The basic principles for LR/HR and LR/HR HD are the same; however LR/HR HD utilizes the SPM HD algorithms for time signals and spectrums. Both methods are most advantageous for RPMs above 500.

The required input data are also more detailed: the rpm, the bearing's mean diameter and its type number. The type number defines the bearing geometry and thus the evaluation box with its green - yellow - red condition zones.

For all three techniques, measuring results indicating bad bearing condition should be verified. By comparing shock values on and around the bearing housing and through lubrication tests, the operator can make sure that the measured shock pulses originate from the bearing before taking corrective action. This verification process is greatly simplified with the SPM Spectrum technique.

## SPM Spectrum

A time record of the shock signal is subjected to an FFT. Prominent bearing patterns in the resulting spectrum are conclusive evidence that the measured shocks are generated by the bearing. Thus, the bearing condition data obtained with either the dBm/dBc or the LR/HR method are valid.

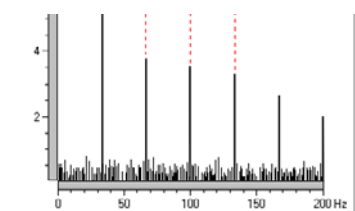
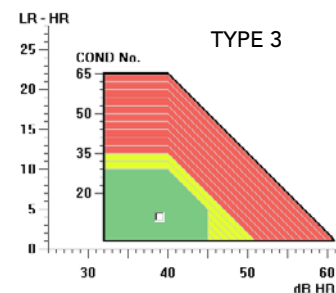
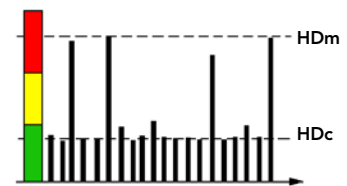
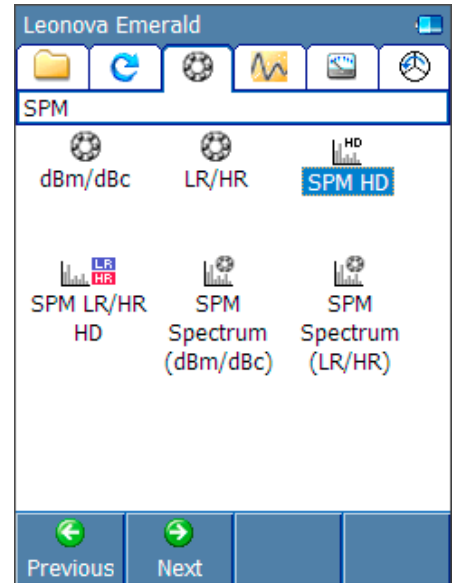

## Rules for SPM measuring points

The rules for the selection of SPM measuring points have a very practical purpose.

We are trying to catch low energy signals which are getting weaker the farther they travel and the more they are bounced about inside a piece of metal.

We know that they lose strength when they cross over from one piece of metal to another (oil between the pieces reduces signal losses).

We cannot know, for all bearing applications, how much of the strength of the bearing signal will reach the measuring point.

However, by necessity we try to apply general evaluation rules, i. e. treat all measured signals as if they were of the same quality.

The rules for SPM measuring points try to assure that most signals are comparable, with sufficient accuracy, and that the green-yellow-red condition zones are valid.

- 1 The signal path between bearing and measuring point shall be as short and straight as possible.
- 2 The signal path must contain only one mechanical interface, that between bearing and bearing housing.
- 3 The measuring point shall be located in the load zone of the bearing.

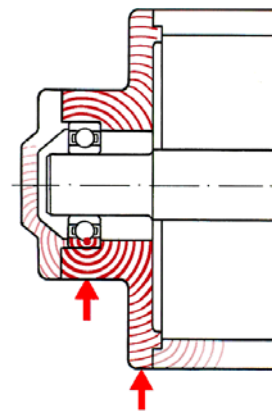

1 – Straight and short path

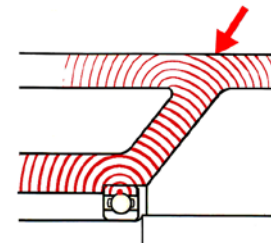

2 – No interface!

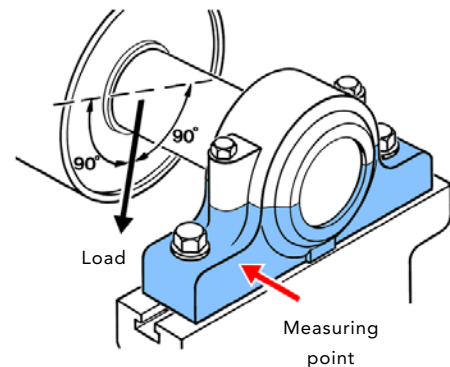

3 – In the load zone of the bearing

Measuring points should be located directly on the bearing housing, i. e. the metal that is touching the outer race.

SPM supplies long adapters and transducers that allow you to reach measuring points beneath covers, shields and brackets.

The signal losses in the two unavoidable interfaces (bearing – bearing housing and housing – adapter) have been taken into account in SPM's evaluation of bearing condition.

The load zone is defined as the load carrying part of the bearing housing. It is normally determined by the weight of the supported machine part, i.e. the load is mostly on the lower half of the bearing housing.

Consider also the direction of the force acting on the shaft when the machine is running. Thus, belt tension can determine the load on the bearings. The fan shaft in point 3 is pulled down towards the motor. The drive end of the motor shaft is pulled up towards the fan (2), the non-drive end (1) is pressed down and away from the fan. In point 4 the weight of the rotor normally determines the measuring direction. The arrows show the measuring points, numbered in the direction of power transmission.

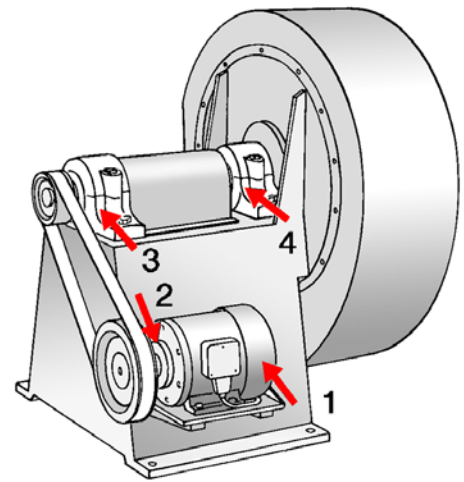
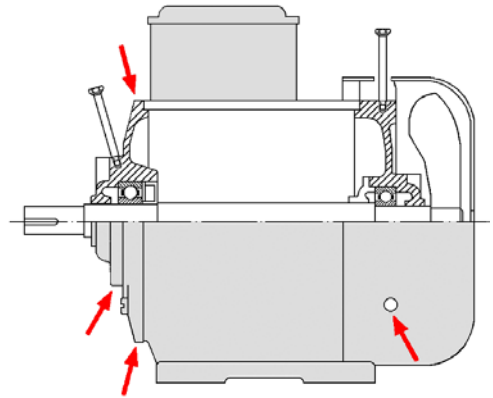

### Finding the strongest signal

Use the shock pulse transducer with probe to find the spot on the bearing housing where the signal is strongest. If there are several points yielding the same signal, select the point where it is easiest to take readings.

When a measuring point cannot conform to the rules (because an ideal spot cannot be reached), make allowance for a weaker signal. If you use SPM LR/HR, you have a COMP no. to compensate for weak signals, but must still try to find a good point.



# Examples of SPM measuring points

The following pages show measuring points and possible adapter or transducer installations. How to install measuring equipment is described in the SPM installation manual.

## Through hole for long adapter

A measuring point beneath a fan cover (1) can be reached with a long adapter, through a hole in the cover.

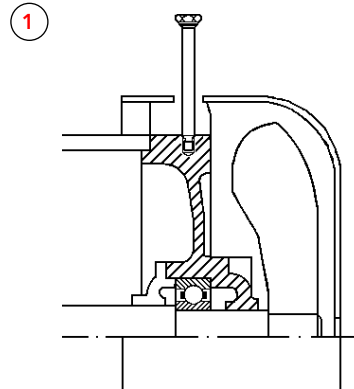

## Adapter with lock nut

The fan cover is fastened directly to the motor shield, which is also the bearing housing (2). One of the cover's holding screws can be replaced by an adapter with lock nut.

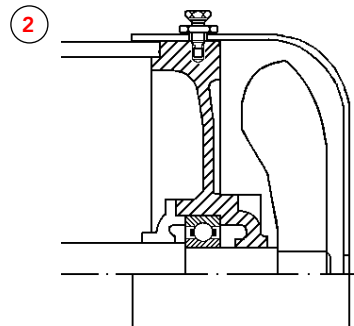

## Bearing housings beneath brackets

Consult machine drawings and identify the bearing housing before selecting a measuring point.

In a pump, the bearings can be placed in two separate housings inside the bearing bracket (3).

Measuring point **B**, placed below and opposite to the pump outlet (because of the load direction) can be reached with a long adapter through an opening in the pump shield.

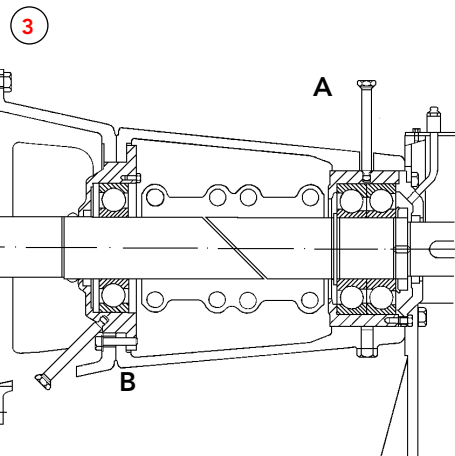

D

The bearing pair at measuring point **A** can be reached with a long adapter through a clearance hole in the bracket. The hole must be large enough to allow bearing adjustment and still prevent metallic contact between bracket and adapter.

### Multiple bearings in one housing

If there are several bearings in the same housing, they are normally treated as a single bearing. In the bearing arrangement for a vertical pump (4), it is not possible to distinguish between the shock pulses from the paired bearings in point 1.

There is also a risk for cross talk between point 1 and point 2, which means that the shock pulses from the bearing in worst condition are picked up in both points.

Check signal strength with the probe. Use one measuring point only if readings are identical in both points. This point (x) can be placed halfway between points 1 and 2.

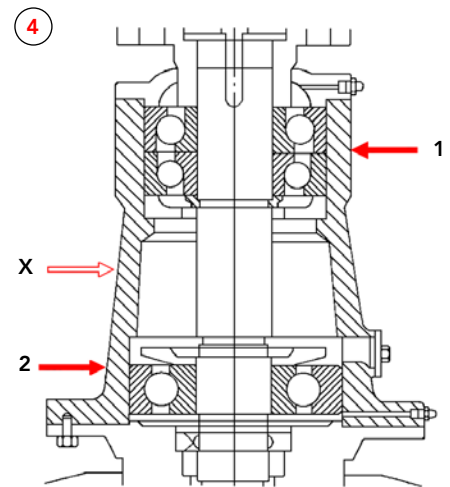

### Installed transducer

On large electric motors (5), the bearings are often mounted in bushings which are welded or bolted to the motor shields. Because of the damping in the interface between the bushing and the shield, the measuring point should be on the bushing.

The bearing bushing at the drive end (A) is usually within reach. A long adapter is installed at an angle to the shield, so that there is enough space for connecting the transducer.

The bearing at the fan end (B) requires a permanent transducer installation. The transducer is installed in the bushing. The coaxial cable is run through a slit in the fan cover to a measuring terminal on the stator frame.

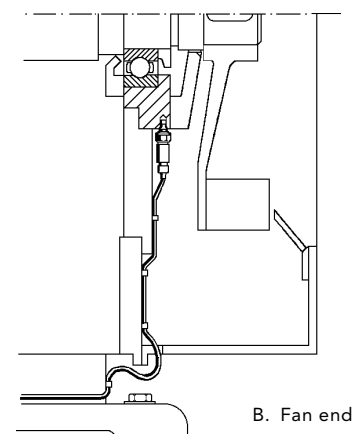
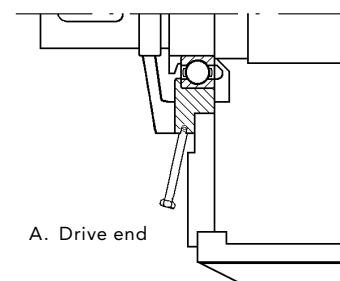
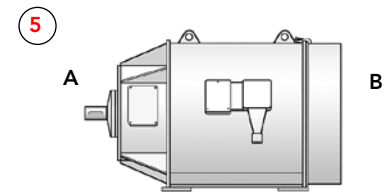

D

# Equipment for shock pulse measurement

## Handheld transducers

Two types of handheld transducers are available for shock pulse measurement with Leonova:

- Shock pulse transducer with quick connector, TRA79, for use with permanently installed measuring adapters.
- Shock pulse transducer with probe, TRA78.

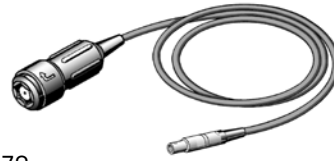

TRA79  
Shock pulse transducer with quick connector

## Permanently installed transducers

Permanently installed transducers can be used in narrow spaces or when the bearing cannot be reached directly. The transducer is connected to a measuring terminal via a coaxial cable. Connect Leonova to the measuring terminal with a slip-on measuring cable.

- Standard transducer series 44000, used with Leonova Diamond and online system Intellinova Compact. Max. cable length is 100 metres and max. temperature 150° C.
- Standard transducer, type 40000, for cable length up to 4 metres. Max. temperature 150° C.
- Transducer with TMU, type 42000, for cable length up to 100 metres. Max. temperature 100° C.
- Measuring cable, CAB80, BNC/TNC slip-on, 1.5 meter.



44000 Shock pulse transducer



TRA78  
Shock pulse transducer with probe

Standard transducers and measuring cables are connected to Leonova's rightmost input connector in the front of the instrument.

## DuoTech® accelerometers (Dual Technology)

The DuoTech® accelerometer is a single transducer solution used for vibration or shock pulse measurements or both in combination.

- DuoTech with quick connector, TRC100, for use with permanently installed measuring adapters. Connect the DuoTech via the measuring cable CAB82.
- DuoTech for permanent installation, SLC144.

Permanently installed DuoTech accelerometers are mounted in a countersunk mounting holes identical to holes normally used by shock pulse transducers. The accelerometer has 2-pin connector and is connected to Leonova or a measuring terminal via twisted pair cable. DuoTech is connected to the VIB input on Leonova.

**Note:** For measurements with low dB<sub>i</sub>/HD<sub>i</sub> (low rpm or small bearings) the quick connector or permanently installed transducer is recommended.

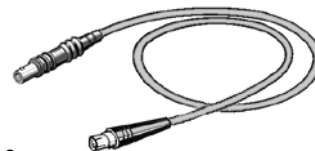

CAB80  
Measuring cable, BNC/TNC slip-on, 1.5 m



TRC100  
DuoTech accelerometer with quick connector



SLC144  
DuoTech accelerometer for permanent installation

# Equipment for shock pulse measurement

## Headphones

The headphones allow you to listen to the shock pulse pattern and is helpful for verifying and tracing the shock pulse sources. Three types of earphones are available:

- Headphone in ear defenders, EAR12, headset, with cable.
- Headphone in ear defenders for helmet, EAR13, with cable.
- Headphone in ear defenders with neck band, EAR15 with cable.

Headphones are connected to Leonova's input/output connector on the right hand side of the instrument.

## Headset

Headset with microphone for recording of vocal comments, EAR16, are connected to Leonova's input/output connector on the right hand side of the instrument.

- Headset in ear defenders with microphone, EAR16, with cable.
- Headset in ear defenders with microphone for helmet, EAR17, with cable.
- Headset in ear defenders with microphone and neck band, EAR18 with cable.

EAR12

Headphones with fixed cable



EAR16

Headset with fixed cable



EAR17

Headset with fixed cable



EAR18

Headset with fixed cable



## Transducer with quick connector

The choice of transducer type depends on how the measuring point is prepared. For systematic shock pulse monitoring, SPM recommends the use of installed adapters and the quick connect transducer wherever possible.

All three types of shock pulse transducers are connected to Leonova's 'SPM' connector (1).

### DuoTech® accelerometer with quick connector

The DuoTech® accelerometer with quick connector TRC10 is connected to Leonova's 'VIB' connector (B) via measuring cable CAB82. The accelerometer fits all standard SPM measuring adapters and measures shock pulse and vibration in combination.

Adapters are solid metal bolts of different lengths and thread sizes, tuned for correct signal transmission. They are installed in threaded, countersunk mounting holes on the bearing housings. Glue-on adapters are available.

To attach a transducer with quick connector, press it against the adapter and twist clockwise. Twist counter-clockwise to remove it.

Check that installed transducers and adapters are properly mounted according to the SPM installation instructions and in good condition. You cannot expect a useful signal by attaching the quick connect transducer to a rusty lump of metal, or from a transducer that is rolling on the floor on the other side of a partition.

Adapter surfaces must be clean and plane. Use an adapter cap to protect them.

A CondiD® tag (an RFID identification tag) can be hung on the adapter cap. CondiD® is a contact free memory tag used for measuring point recognition. It should not be mounted flat against a metal surface. A distance of min. 3 mm between metal surfaces and CondiD® is recommended.

CondiD® responds to a recognition signal when Leonova is held close to the tag. It contains all basic data for its measuring point. If the measuring point is already loaded in Leonova, it will be displayed, else it will be added to those in the data logger memory.

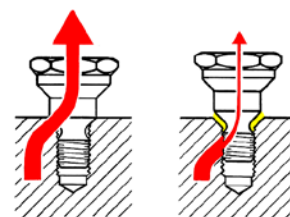
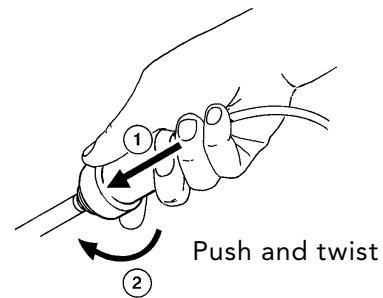
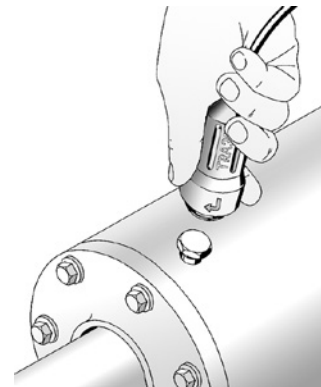

Signal transmission

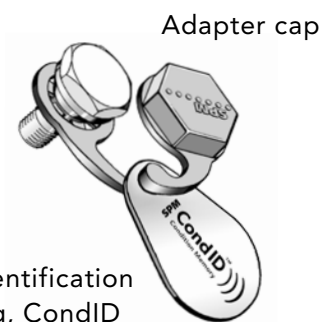

Identification tag, CondiD



## Permanently installed transducers/terminal

A permanently installed transducer and a measuring terminal (BNC or TNC connector) are used when the bearing cannot be reached directly. Use a measuring cable to connect Leonova to the terminal.

The terminal cabinet, SPM 14318, can receive up to 16 coaxial cables from shock pulse and vibration transducers. The cabinet is made of stainless steel and has protection class IP66.

Transducers for permanent installation are available with different thread sizes and in three types:

- *Series 44000* for cable length max. 100 m and temperature max. 150° C
- *Series 40000* for cable length max. 4 m and temperature max. 150° C
- *Series 42000* for cable length max. 100 m and temperature max. 100° C

### DuoTech® for permanent installation

DuoTech® accelerometers series SLC for permanent installation are available with different thread sizes. They are used for shock pulse and vibration measurements in combination and when the measuring point cannot be reached directly. Connect the accelerometer via twisted pair cable to the VIB input on Leonova.

The permanently installed transducers are installed in threaded, countersunk mounting holes on the bearing housings. The cable between transducer and terminal should be firmly attached to the machine with cable clamps and, where necessary, be protected against damage.

SPM supplies high temperature cables and moisture proof connectors.

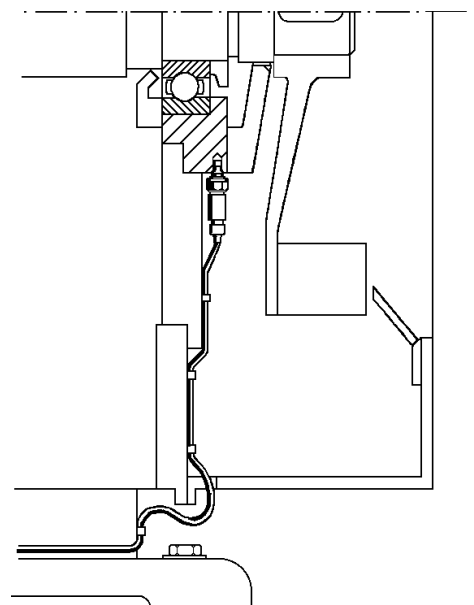

Installed transducer, cable to terminal

D

## Shock pulse transducer with probe

The handheld probe is mainly used to locate the strongest shock signal on and around the bearing housing, in order to find the best measuring point or to verify the shock pulse source after getting a measuring result which indicates bad bearing condition.

If it is used for regular condition monitoring, the measuring points for the handheld probe should be clearly marked. Always measure in the same spot.

The probe tip is spring loaded and moves within a sleeve of hard rubber. To maintain a steady pressure on the tip, press the probe tip against the measuring point until the rubber sleeve is in contact with the surface.

Hold the probe steady to avoid rubbing between probe tip and surface.

The probe is directionally sensitive. It must be pointed straight at the bearing.

The centre of the probe tip should touch the surface. Avoid pressing the probe tip against cavities and fillets which are smaller than the probe tip.

The only part likely to wear out is the rubber sleeve for the probe tip. It is made of chloroprene rubber (neoprene) and tolerates 110° C (230° F). Spare sleeves have part number 13108.

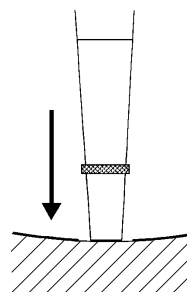
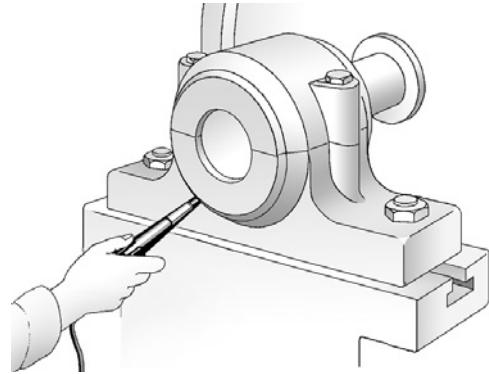

Rubber sleeve  
in contact with  
the surface

Point at the  
bearing

Hold steady

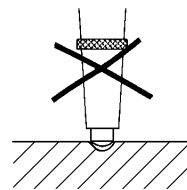

Avoid small  
cavities and  
fillets

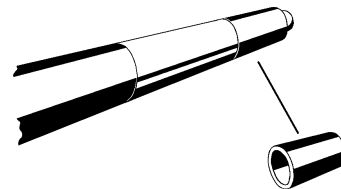
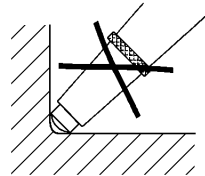

SPM 13108

Neoprene, 110° C (230° F)

## The SPM HD measuring technique

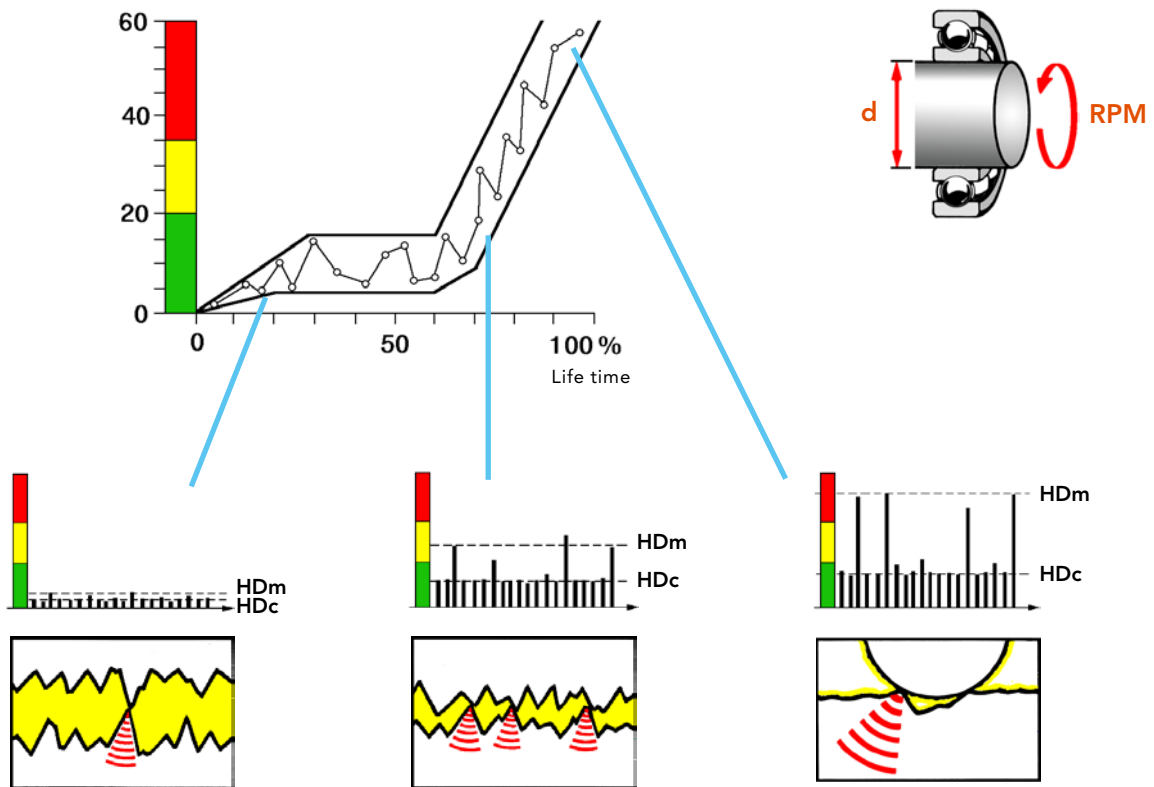

The SPM HD measuring technique is a refinement of the original dBm/dBc measuring technique (see page D:18), which has been successfully applied for more than 40 years. It is well suited for industrial condition monitoring, because it works with few, easy to understand in- and output data and with 'reasonable accuracy'.

Even on a logarithmic scale, there is normally a large, distinct difference between the maximum values from good and bad bearings. Thus, minor inaccuracies in the input data (rpm and shaft diameter) have little effect on the evaluated measuring result.

Lubrication condition is indicated by the delta value, i.e. the difference between HDm and HDc. High readings and a small delta value indicate poor lubrication or dry running. This is sufficient for maintenance purposes.

HDm and HDc are measured during a predefined number of revolutions and automatically displayed.



## Normalized condition readings

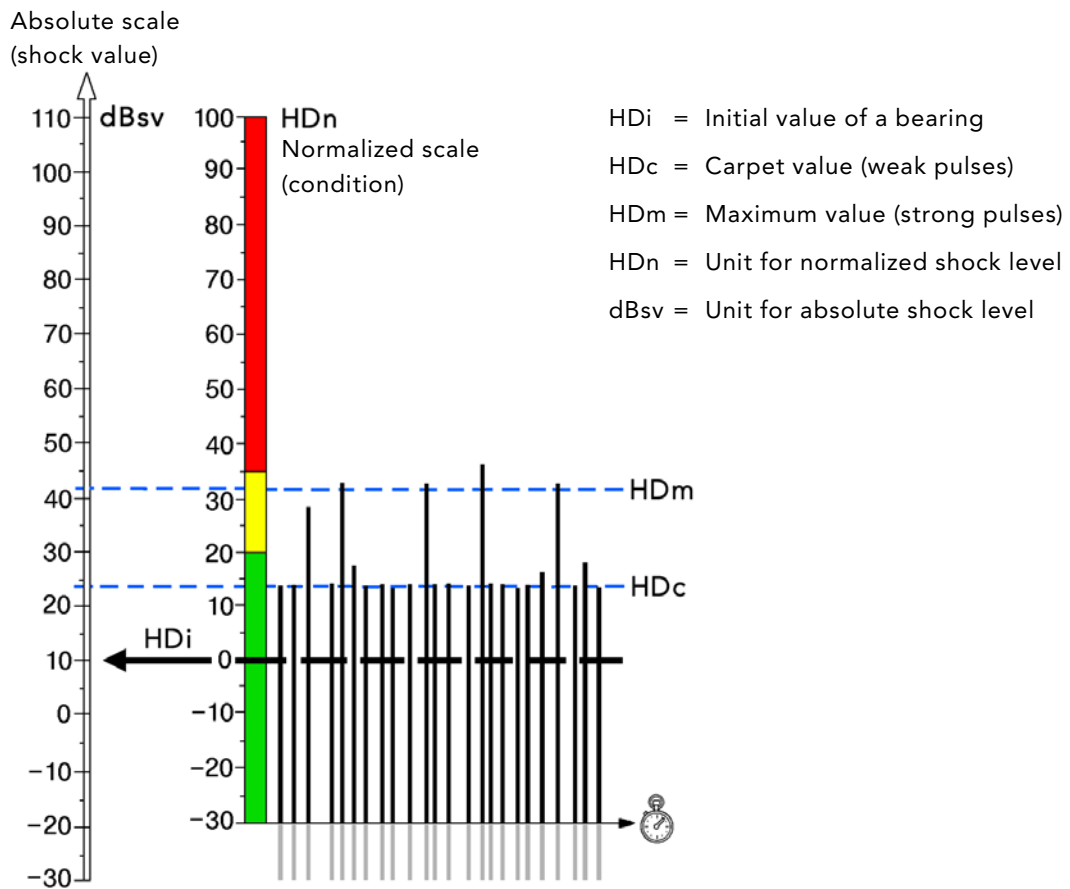

The absolute shock pulse level of a bearing, measured in dBsv (decibel shock value), is both a function of rolling velocity and of bearing condition. To neutralize the effect of rolling velocity on the measured value, Leonova must be programmed with shaft diameter (in millimetre or inch) and rotational speed (in rpm).

The instrument will then calculate the **initial value HDi**, the starting point of the condition scale for a particular bearing. The HDi can also be input directly or via the ISO bearing number. The condition scale is graded in **normalized** shock values, HDn.

Leonova samples the shock pulse amplitude over a period of time and displays:

- the **maximum value HDm** for the small number of strong shock pulses.
- the **carpet value HDc** for the large number of weaker shock pulses.
- the status dot which is green for HDm up to 20 HDn = good condition, yellow for 21-34 HDn = caution, red for 35 HDn and more = bad operating condition.

The maximum value HDm defines the bearing's position on the condition scale. The difference between HDm and HDc is used for a finer analysis of the causes for reduced or bad condition.

When you set the HDi to '0', Leonova will take an **unnormalized** reading in dBsv (absolute shock values). The condition zones do not apply. This method is used for comparative reading on different bearings and/or other shock pulse sources.

## Input data for SPM HD

Measuring points for the SPM techniques are normally set up in Condmaster and then downloaded to Leonova. However, it is possible to open the Leonova default file in the SPM window (1) and configurate all measuring parameters. Select 'SPM HD' and open with ENTER.

### Transducer

Before starting measurements, make sure that the shock pulse transducer you are using with your Leonova is properly selected.

Default transducers for the shock pulse techniques are set up via the transducer register. Default transducer is the active transducer when 'Portable' transducer is selected under 'Measuring point data'. To select a default transducer, see Chapter A page 15.

You can select other shock pulse transducers from the transducer register (2) if you switch 'Transducer' from 'Portable' to 'Remote'.

When using a DuoTech sensor all fields displays (3) that normally apply to a vibration transducer. The actual data for the individual transducer is written on its calibration card. This data should always be input in the transducer register. When several transducers are in use, they should be marked to assure that the readings are calibrated. Note that measurements with DuoTech will be performed at channel VIB-1.

### HDi

For a normalized reading of bearing condition with the Leonova default file, go to **MENU** > 'Measuring point data' and set the initial value HDi. The default setting is HDi = 'Calculated', which produces the normalized shock values with condition status display.

If known, the HDi can be input directly via the keyboard. Mark the 'HDi' row, then press the F1 key ('Edit').

If the HDi is not known, input the rotational speed (rpm) and the shaft diameter, and Leonova will calculate and display the HDi for you.

There are two alternatives for entering the shaft diameter. 'Input ISO bearing number' (4) opens a window (5) where you set the **last two digits** of the ISO number using the **UP/DOWN** arrow keys on the Leonova keypad.

'Input diameter' (6) opens the Leonova keyboard. Write the shaft diameter, then edit RPM and input the rpm on the keyboard.

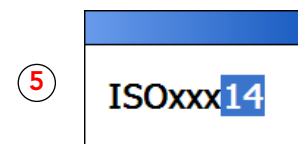
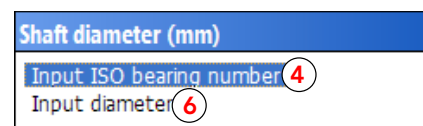
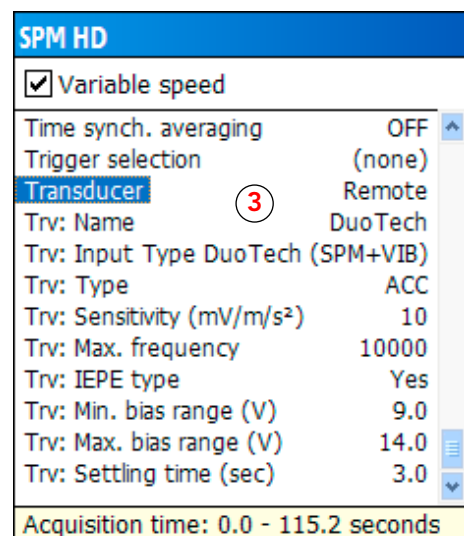
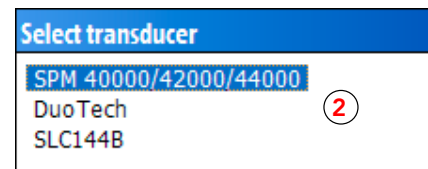
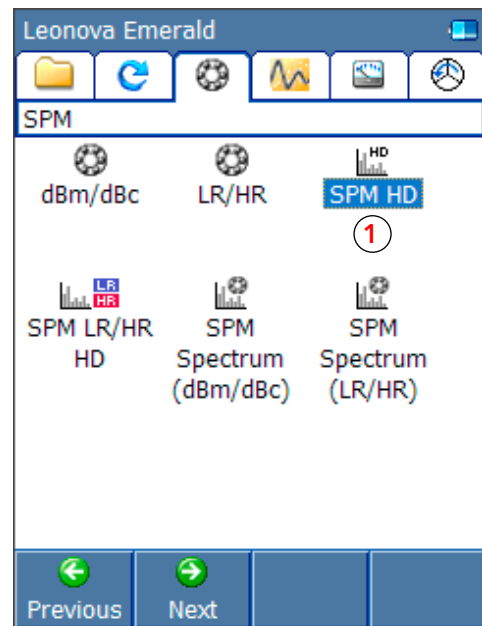

## Variable speed

The alternative 'Variable speed' (1) implies that the shock pulse measurement is preceded by a measurement of the rpm.

## Measure RPM simultaneously

'Measure RPM simultaneously' (2) is normally not used. With this setting on, you are forced to measure the rpm simultaneously with the shock pulse measurement

## Measuring time

Depending on the rpm of your application, the Measuring time (3) setting has a significant impact on the length of a measuring cycle. Empirical studies have shown that in order to achieve reliable measurements of bearing condition, measurement should cover at least 10 shaft revolutions and preferably 50 revolutions, which is the default setting. The time required to complete a measuring cycle can be calculated as  $50 \times (60/\text{RPM})$ .

## FFT calculation

This setting means that a full SPM HD measurement including FFT will be saved. Input upper frequency in orders and number of spectrum lines. Under 'Save', select 'Time signal and FFT', 'Full spectrum' or 'Condition parameters' to be saved with the measurement.

## Symptom enhancement factor

The 'Symptom enhancement factor' (4) is used to improve the signal-to-noise ratio. For applications with little electronic noise and few mechanical shock phenomena, this factor can be kept low (0-5). Where noise and random shocks are frequently occurring, it is recommended that the 'Symptom enhancement factor' be set to 5-10. However, you should be aware that the higher this factor, the longer the measurement cycle. The Y axis unit in spectrum and time signal is HDesv when symptom enhancement is used.

## Time synchronous averaging

To achieve greater accuracy when measuring gear damages, one can order the average result from a stated number measurements. To get a time synchronous average, a tachometer must be connected which supplies a trigger pulse. This starts each measurement with the shaft in the same position.

## Trigger selection

When measuring on variable speed machines, an 'RPM trigger' can be used to determine when to start a measurement, ensuring that it is carried out at an appropriate speed. The RPM trigger can be used on applications where useful readings can be obtained only within a limited RPM range, such as in cranes.

The purpose of the 'Post trigger' is to avoid the recording of irrelevant signals that may ultimately cause false alarms. It can be used where strong signals can be expected which are process related and not attributed to machine damage.

'RPM trigger' can be set to 'RPM run up' or 'RPM run down'. 'RPM run up' means Leonova will initiate the measurement, then wait for the machine to speed up to the level input under 'Trigger level' before it starts recording the signals. With 'RPM run down', Leonova waits for RPM to slow down to the 'Trigger level' setting.

When using 'Post trigger', input a value (HDesv) under 'Trigger level'. In the above example (5), Leonova will initiate an SPM HD measurement and wait for the signal's HDesv level to reach 25 before it starts a complete measurement including time signal and FFT. Make sure you input a viable trigger level; if the level is never reached, the measurement must be aborted manually.

SPM HD	
<input checked="" type="checkbox"/> Variable speed (1)	
Shaft diameter (mm)	
Measure RPM simultaneously (2)	Yes
Measuring time (3)	50 revolutions
FFT calculation	Yes
Frequency, upper (Orders)	100
No. of spectrum lines	1600
Symptom enhancement factor (4)	10
Save	Time signal and FFT
Trigger selection	Post trigger
P.Trigger: Trigger level (HDesv) (5)	25
P.Trigger: Delay time (sec)	0
Acquisition time: 0.0 - 115.2 seconds	

Under 'Delay time', you can specify a number of seconds during which Leonova will delay the start of measurement. This setting is optional.

### Acquisition time

The 'Acquisition time' is automatically updated when parameters are changed that affect the time.

## Transducer line quality

### Transducer line quality test, TLQ

From the measurement window, the instrument can be set up to perform a transducer line quality test (TLQ) before measurement. Press the ENTER key to enable or disable the TLQ test (1).

When TLQ is enabled, the instrument will display the result of the transducer line quality test in the result window, so you can check the quality of signal transmission between transducer and instrument. Part of your signal will be lost in a poor transducer line, so your measuring results will be lower than they should be.

For shock pulse transducers, the following applies:

- 40000, 42000 type transducers: the result of the TLQ test is a 'TLT' (Transducer Line Test) value. TLT is dimensionless, with accepted values between 15 and 25.
- 44000 type transducers: the result of the TLQ test is a 'TLR' (Transducer Line Resistance) value in kohm (resistance). Accepted values are between 26 and 40 k $\Omega$ .

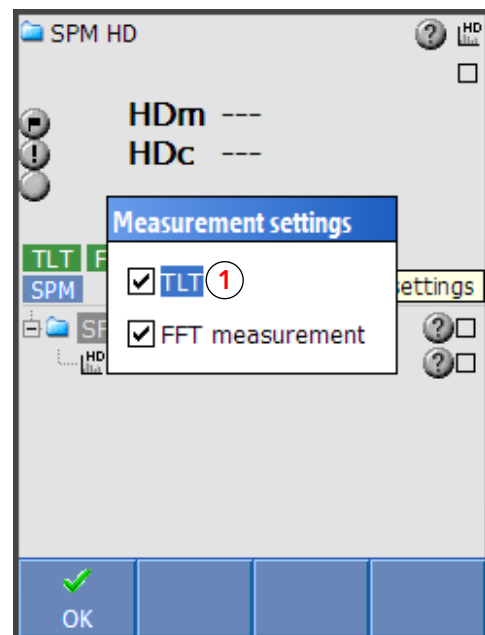

The TLQ test should always be made when you measure with permanently installed transducers. Normal TLT/TLR values for transducer types 40000 and 42000 are around 20 and for 44000 approx. 32 kOhm.

For 40000 and 42000 type transducers, TLT values below 15 are not acceptable, so you have to check cables and connectors for bad connections and moisture.

If the TLQ value is below the accepted level, the measuring result cannot be saved.

# Measuring SPM HD

When the MEASURE/SAVE (M/S) key is pressed, Leonova samples the transducer signal for two seconds. A preliminary result is displayed in the measurement window. The HDm shown is the amplitude value of the strongest shock pulse registered during the measuring time.

To accept the displayed result, press the ENTER key. The measurement window shows the two shock values (1), the status dot (2) and, if transducer line quality test is enabled, the TLQ value (3).

Save the result by pressing the MEASURE/SAVE (M/S) key, or measure again with SHIFT + M/S.

When 'Variable speed' is active, the rpm must be measured before measuring the shock values.

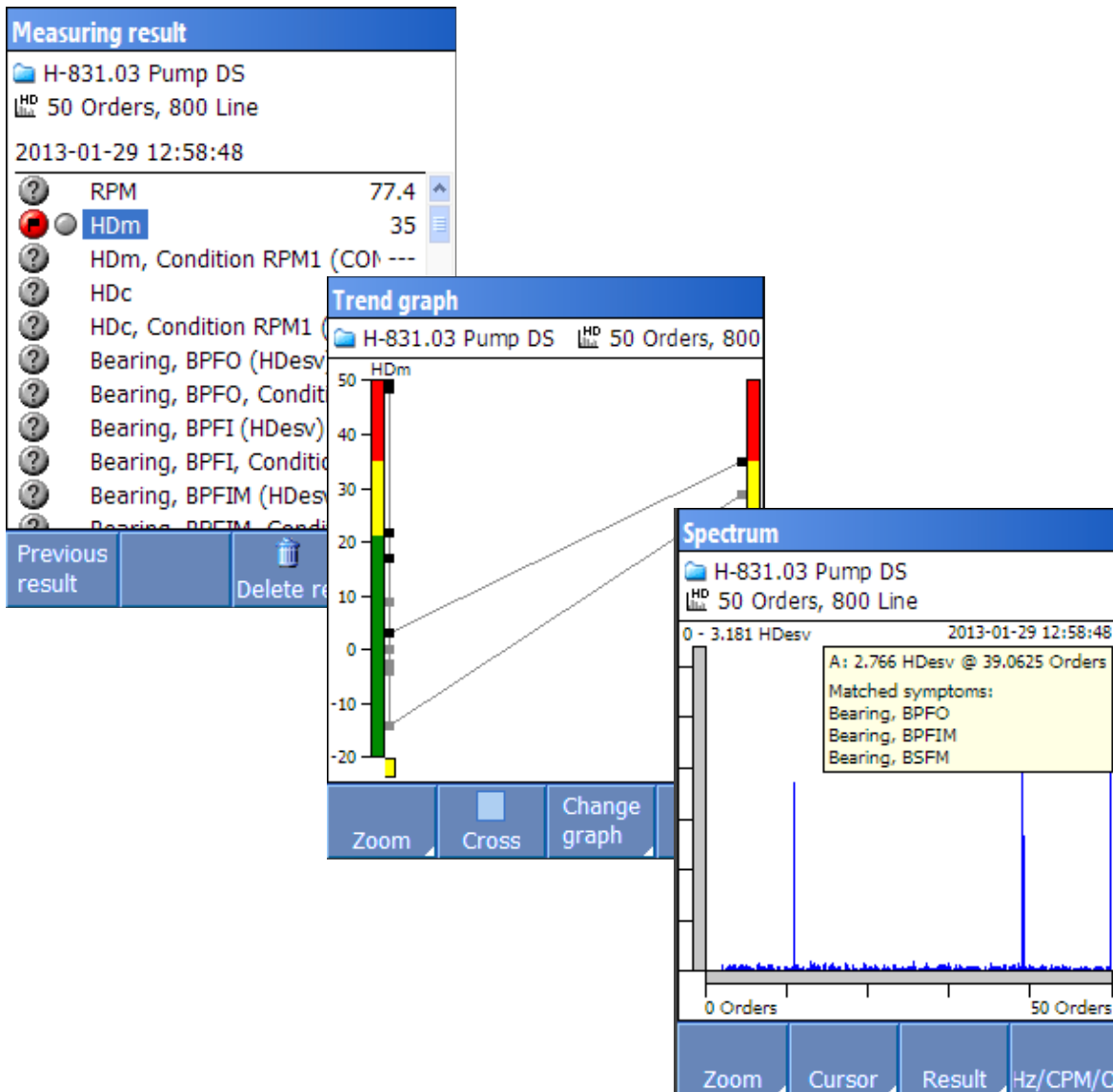
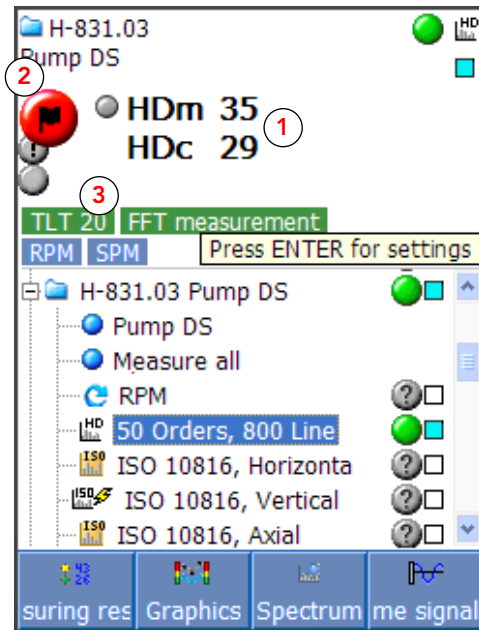



## The dBm/dBc measuring technique

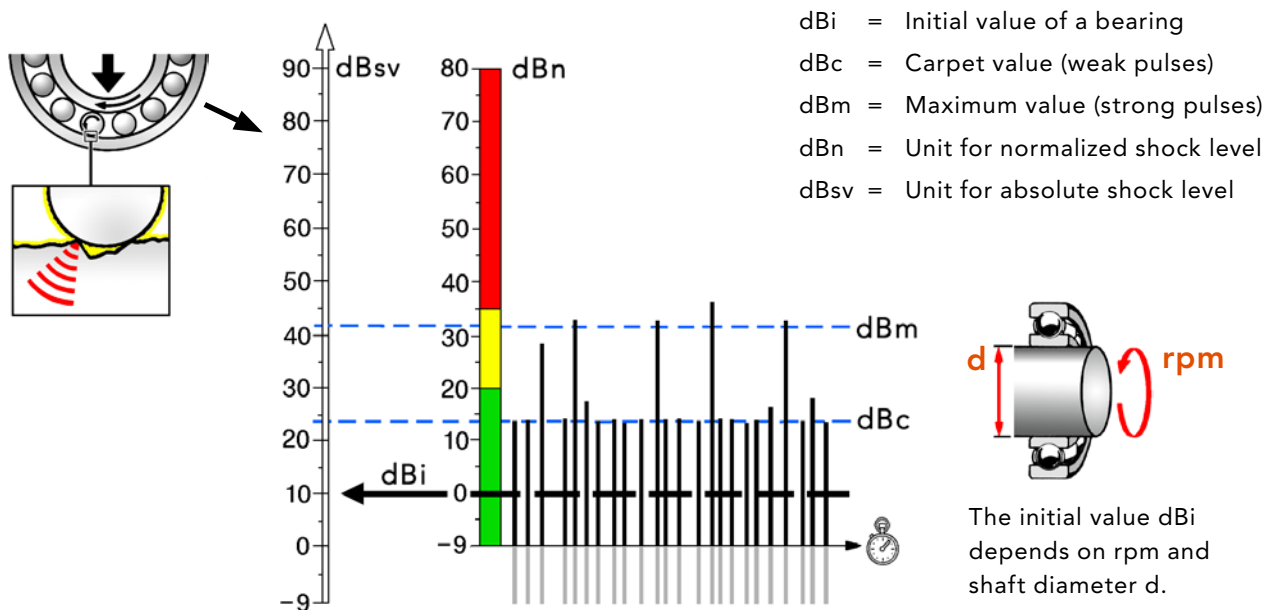

The original SPM dBm/dBc measuring technique has been successfully applied for over 40 years and continues to be widely used. Like its successor the SPM HD measuring technique, dBm/dBc is well suited for industrial condition monitoring and requires only few, easy to understand in- and output data.

With the dBm/dBc technique, lubrication condition is indicated by the delta value, i.e. the difference between dBm and dBc. High readings and a small delta value indicate poor lubrication or dry running. This is sufficient for maintenance purposes.

dBm and dBc are measured in a fixed time window and automatically displayed. After that, the instrument continues to measure while the transducer is connected. The peak indicator blinks when pulses stronger than the displayed dBm value are detected. If earphones are connected, a "pinging" sound can be heard with each blink from the peak indicator. For more information, see 'Using the earphones'.

The stethoscope function (see 'Using the stethoscope function' in section C of this manual) can be used to listen to machine sounds. With the stethoscope, machine sound irregularities from various rotating parts can be detected.

# Input data for SPM dBm/dBc

Measuring points for the SPM techniques are normally set up in Condmaster and then downloaded to Leonova. However, it is possible to open the Leonova default file in the SPM window and configure all measuring parameters. Select 'dBm/dBc' and open with ENTER.

## Transducer

Before starting measurements, make sure that the shock pulse transducer you are using with your Leonova is properly selected.

Default transducers for the shock pulse techniques are set up via the transducer register. Default transducer is the active transducer when 'Portable' transducer is selected under 'Measuring point data'. To select a default transducer, see Chapter A page 15.

You can select other shock pulse transducers from the transducer register (1) if you switch 'Transducer' from 'Portable' to 'Remote'.

When using a DuoTech sensor all fields displays (2) that normally apply to a vibration transducer. The actual data for the individual transducer is written on its calibration card. This data should always be input in the transducer register. When several transducers are in use, they should be marked to assure that the readings are calibrated. Note that measurements with DuoTech will be performed at channel VIB-1.

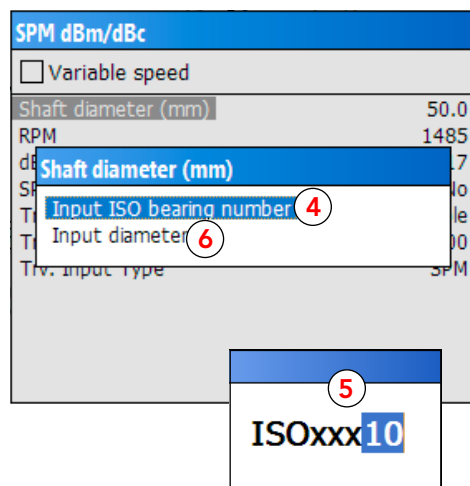
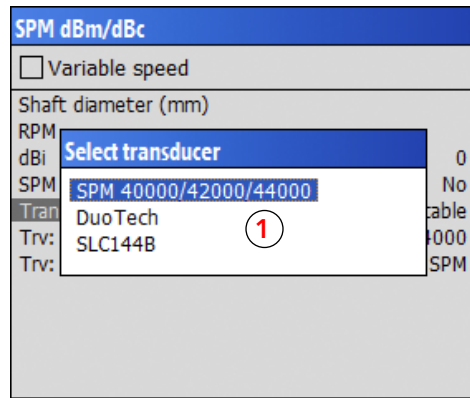
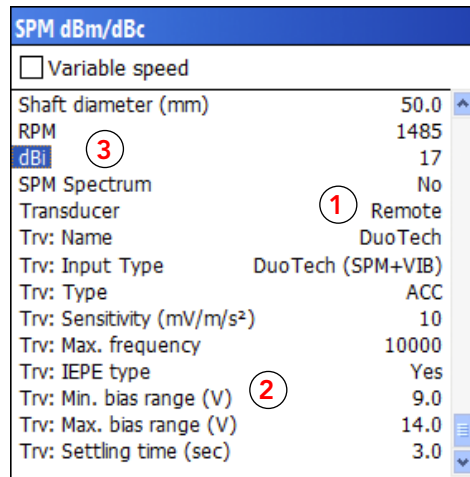

## dB<sub>i</sub>

For a normalized reading of bearing condition with the Leonova default file, go to **MENU** > 'Measuring point data' and set the initial value dBi. The default setting is dBi = 0, which produces the normalized shock values with condition status display.

If known, the dBi can be input directly via the keyboard. Mark the 'dBi' row (3), then press the F1 key ('Edit').

If dBi is not known, input the rotational speed (rpm) and the shaft diameter, and Leonova will calculate and display the dBi for you.

There are two alternatives for shaft diameter. 'Input ISO bearing number' (4) opens a window (5) where you set the **last two digits** of the ISO number using the **UP/DOWN** arrow keys on the Leonova keypad.

'Input diameter' (6) opens the keyboard. Write the shaft diameter, then edit RPM and write the rpm on the keyboard.

The dBi will be displayed when the data input is complete (3).



### Variable speed

The alternative 'Variable speed' (1) implies that the shock pulse measurement is preceded by a measurement of the rpm.

### Measure RPM simultaneously

'Measure RPM simultaneously' (2) is normally not used. With this setting on, you are forced to measure the rpm simultaneously with the shock pulse measurement.

### RPM Trigger

When measuring on variable speed machines, an 'RPM trigger' can be used to determine when to start a measurement, ensuring that it is carried out at an appropriate speed. The RPM trigger can be used on applications where useful readings can be obtained only within a limited RPM range, such as in cranes.

'RPM trigger' (3) can be set to 'RPM run up' or 'RPM run down'. 'RPM run up' means Leonova will initiate the measurement, then wait for the machine to speed up to the level input under 'Trigger level' before it starts recording the signals. With 'RPM run down', Leonova waits for RPM to slow down to the 'Trigger level' setting.

Under 'Delay time', you can specify a number of seconds during which Leonova will delay the start of measurement. This setting is optional.

### SPM Spectrum

An SPM spectrum measurement can be carried out along with the dBm/dBc measurement. It is measured in addition to the ordinary shock values.

Mark the 'SPM Spectrum' row (4). Press **ENTER** and set 'SPM Spectrum' to 'Yes'.

Settings for SPM Spectrum are described on page D:33.

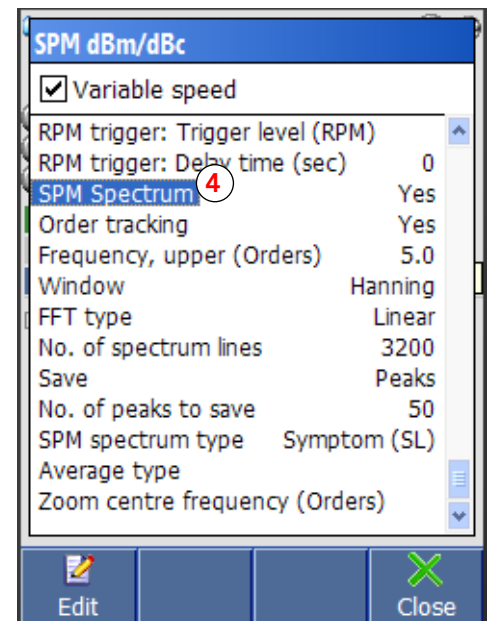
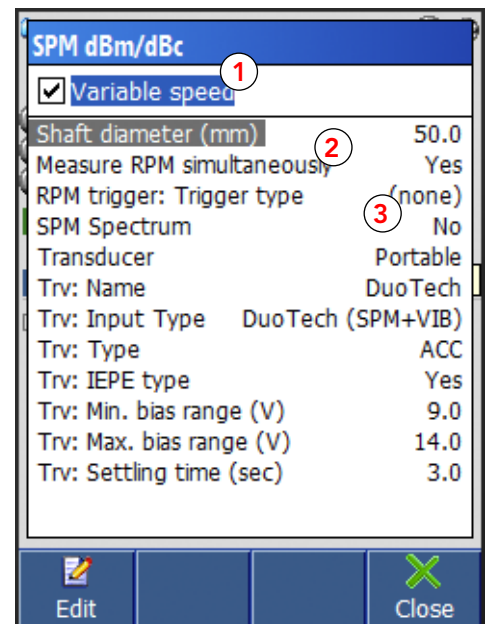

# Measuring SPM dBm/dBc

From the measurement window, the instrument can be set up to perform a transducer quality line test (TLQ) before measurement. Press the ENTER key to enable or disable the TLQ test (1). TLQ (Transducer Line Quality) is described on page D:17.

When the MEASURE/SAVE (M/S) key is pressed, Leonova samples the transducer signal for two seconds. A preliminary result is displayed in the measurement window. The dBm shown is the amplitude value of the strongest shock pulse registered during the measuring time.

Meanwhile, Leonova keeps measuring. If it registers stronger pulses, the peak indicator (1) will blink.

Watching the peak indicator is very important, especially when the preliminary result indicates poor or bad bearing condition. The lower the rpm, the longer it can take for damaged parts to move into the load zone and reveal their presence by strong shock pulses.

When the peak indicator blinks, press the UP key on the Leonova keypad. This increases the dBm in steps of one dB. The original value is displayed in brackets (2). Stop adjusting the dBm value when the peak indicator stops blinking. The DOWN key decreases the value.

When earphones are connected in order to listen to machine sounds, use the LEFT/RIGHT keys to adjust earphone volume (3).

To accept the displayed result, press the ENTER or the MEASURE/SAVE (M/S) key. The measurement window shows the two shock values (4), the status dot (5) and, if transducer line quality test is enabled, the TLQ value (6). If a default measurement file was used, the dBi value is also shown. For measuring assignments downloaded from Condmaster in a measuring round, the dBi is not displayed.

Save the result by pressing the M/S key, or measure again with SHIFT + M/S.

When 'Variable speed' is active, the rpm must be measured before measuring the shock values.

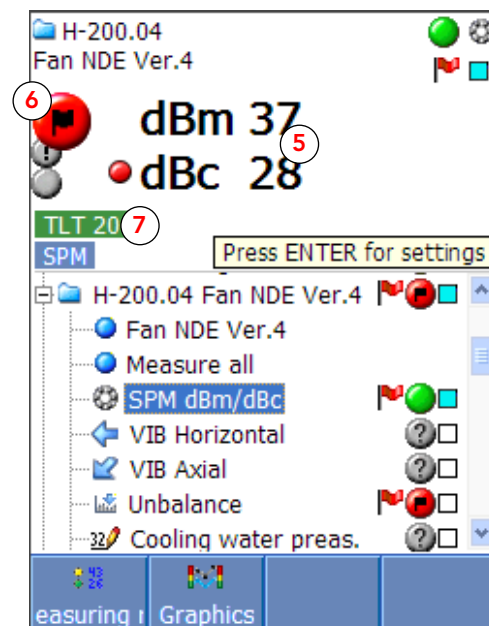
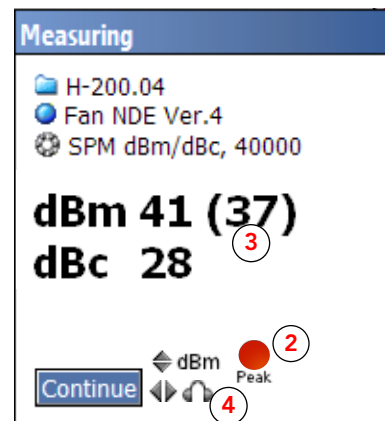
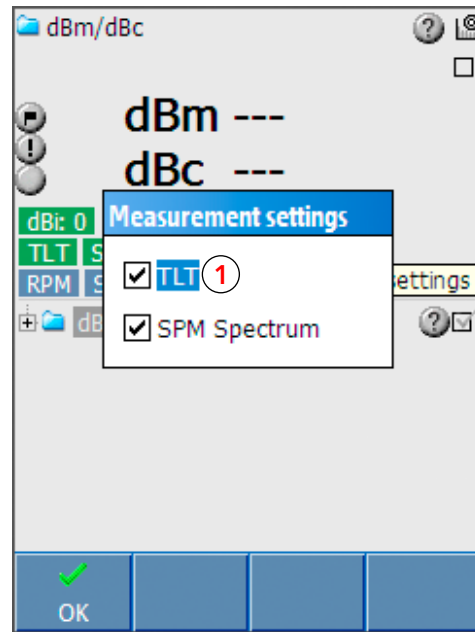

D

## Using the earphones

For dBm/dBc, earphones can be used to listen to the shock pulse pattern in case of suspect or high readings. Listening to the shock pulse signal can help to pinpoint the cause for high values. This, and the possibility to search for shock pulse sources with the probe transducer, is a means to verify the measuring result and its cause.



Earphone listening does not work with the LR/HR and SPM HD technique.

The measuring threshold is changed with the UP/DOWN arrow keys on the Leonova keypad. At a low level, Leonova will emit a continuous tone. As the threshold is raised, this changes to very rapid pulses at the dBc level. At the dBm level, only a few pulses should occur at irregular intervals.

Significant are

- the dBm level
- the rhythm of the pulses immediately below the dBm level
- the delta value, which is the difference between the dBm and the dBc.

Shock pulses from a bearing normally occur at irregular interval, while strong, rhythmic shocks are a sign of disturbance. The diagrams below show typical patterns.

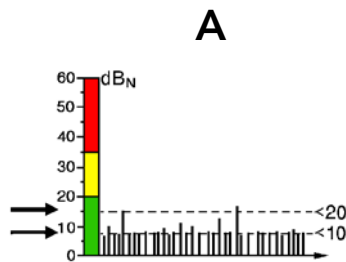

A. Good bearing  
Shock values are low.

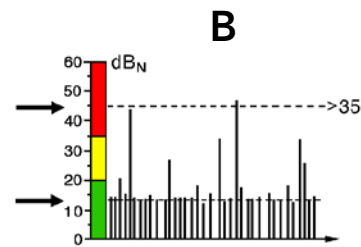

B. Bad bearing  
High values, large delta,  
irregular pattern.

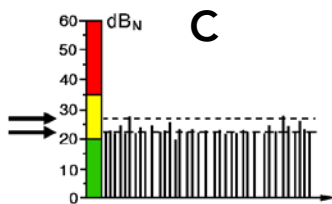

C. Pump cavitation  
Very small delta, fairly high  
shock level.

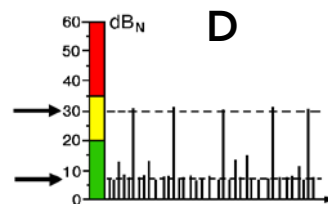

D. Load shocks, valves, etc.  
Regular patterns mean often  
disturbance

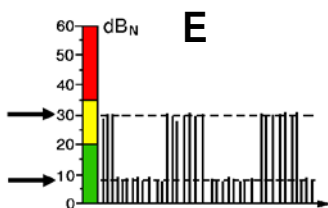

E. Regular showers  
Scraping machine parts.

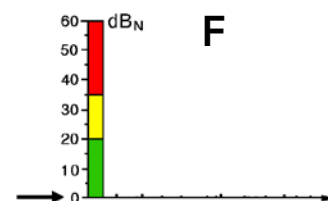

F. Measured value drops sharply  
A danger signal, the bearing is sliding.

D

## The LR/HR and SPM LR/HR HD techniques

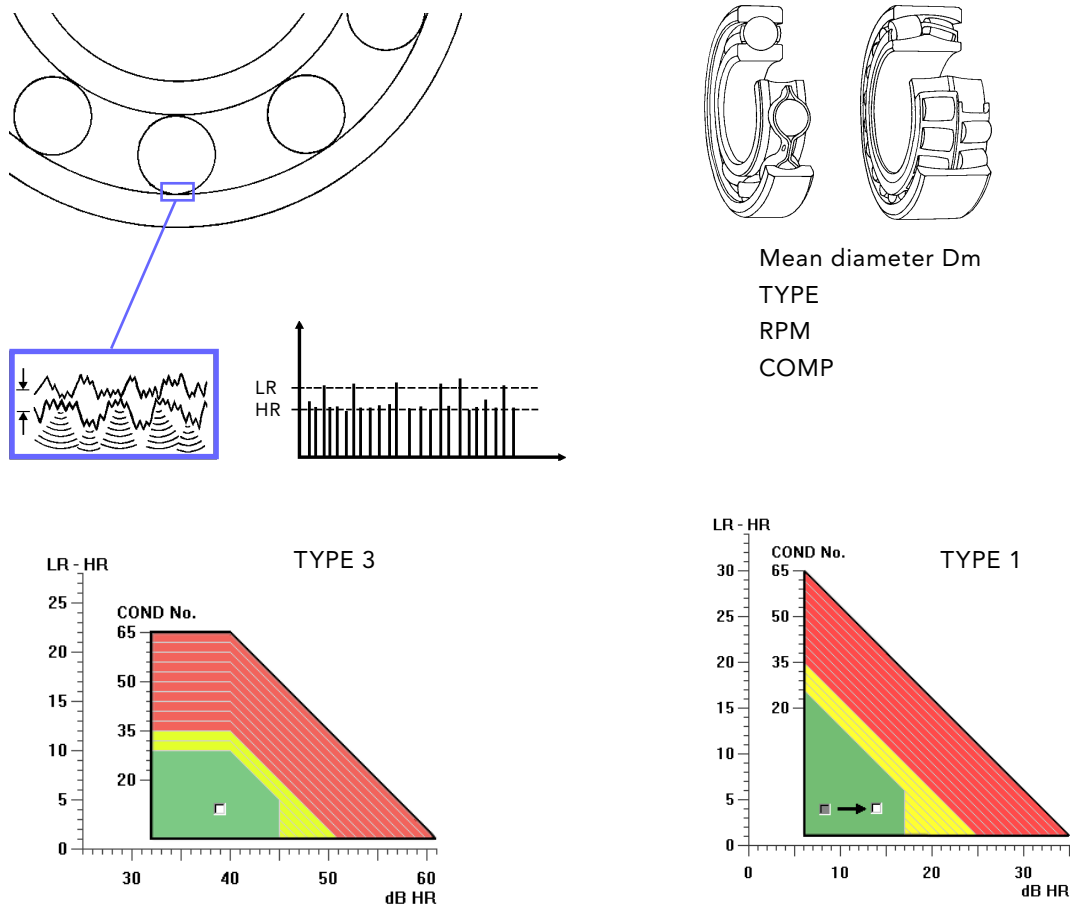



The LR/HR technique was originally developed for a continuous, automatic monitoring system (CMS). An automatic system cannot, like a human operator, vary measuring time, use earphones or make "further tests" to verify suspect readings. It works with fixed settings and is dependent on accurate input data. This, together with new research results, programmable chips, and the desire to get more detailed information from the shock pulse signal, lead to a change in the threshold values, plus a more diverse and detailed output.

The value for the noise carpet (HR) is read at an occurrence rate of approx. 1000 pulses/second and the value for the strong shock pulses (LR) at approx. 40 pulses/second. This makes LR an average value of the strong pulses, lower than the maximum, and thus reduces the dynamic range. To increase accuracy, the mean diameter of the bearing is used, the SPM TYPE no. is input to define bearing geometry, and the COMP no. to calibrate the individual measuring points.

The extra output information concerns mainly lubrication condition, allowing the user to attack a mayor maintenance problem (most bearings fail too soon because of inadequate lubrication) at the root. With SPM's LUBMASTER® (part of Condmaster® versions for this technique) and LR/HR readings, it is possible to accurately measure lubrication condition, calculate the resulting  $L_{10a}$  life, and work out feasible improvements by simulating changes in the lubricant parameters.

The basic principles for LR/HR and LR/HR HD are the same; however LR/HR HD utilizes the SPM HD algorithms for time signals and spectrums. Both methods are most advantageous for RPMs above 500.

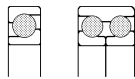
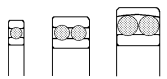
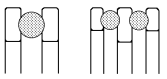
## Input data for LR/HR and LR/HR HD

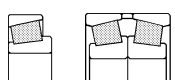
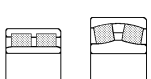
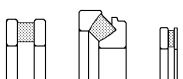
	1	Deep groove ball bearings, series 62, 63, 64
	2	Angular contact bearings, all series
	3	Deep groove ball series 60, 160, 618, double row and self-aligning ball bearings
	4	Thrust ball bearings, all types
	5	Cylindrical roller bearings, single row
	6	Taper roller bearings, all radial types
	7	Spherical roller bearings Double row cylindrical roller bearings
	8	Thrust roller bearings

One part of the input data, the rpm and the size of the bearing, is needed to allow for the effect of bearing speed on the shock level when evaluating bearing condition. The mean diameter  $D_m$  is more exact than the shaft diameter, because the height of bearings with the same shaft diameter can vary considerably. Together, rpm and  $D_m$  are used to calculate the NORM no. of the bearing (range 10 to 58).

The HR level shock pulses vary with the shape and number of the rolling elements in the bearing. This becomes important when estimating the oil film thickness in the rolling interface. The largest influencing factor is the shape of the contact area. In ball bearings, the rolling element has point contact with the raceways. In roller bearings, there is line contact, which means that the area under pressure, where the shock pulses occur, is much larger.

For SPM purposes, bearings are grouped into 8 different types, each with a **TYPE** number 1 through 8. The types are described in the table above.

Bearing manufacturers, though not all, follow ISO standards when numbering their bearings. The number code contains the information on mean diameter and bearing type. Thus, when you use an ISO bearing number as input in Condmaster®, the program will give you  $D_m$  and TYPE no. As manual input for Leonova, you can use the last three digits of the ISO number, which will produce  $D_m$  but not the TYPE no.

## Accumulation and compensation

In addition to the basic input data, one can set values for COMP and ACCUM.

**ACCUM** (accumulation) determines the number of measuring cycles before the Leonova displays the average value as result. ACCUM can be set from 1 to 9. Especially on bearings with a low rpm, set ACCUM to at least 3.

**COMP** (compensation number) is used to calibrate the measuring point, normally to compensate for a somewhat weaker signal from a measuring point that does not quite comply with the SPM rules. To find the correct COMP no., use the LUBMASTER function in Condmaster®.

A normal signal from a good bearing should be near the centre of the green part of the evaluation frame. If it is far to the left, you can "push it forward" by setting a COMP no. If the signal is outside of the left side of evaluation frame, Leonova will display the error code E3 = signal too low. The COMP no. is added to the measuring result before it is evaluated. Thus, it will influence the evaluation results CODE, LUB, and COND, but not the displayed values for HR and LR.

It is possible to set negative COMP nos., but you should avoid that. With a positive COMP no., you make the evaluation results worse than apparent from the measured LR/HR values. With a negative COND. no., you 'improve' bearing condition, which can have unpleasant consequences if you are wrong in assuming that the signal from this bearing is stronger than normal. To avoid alarm from a stable bearing with high readings, it is better to change the alarm levels.

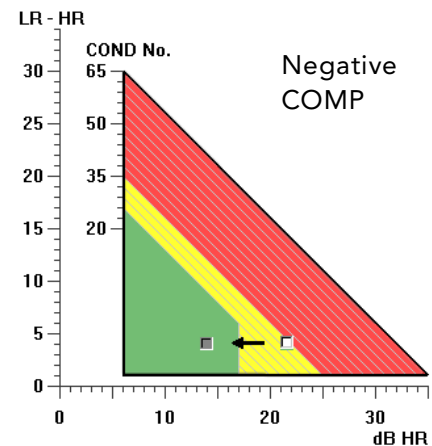
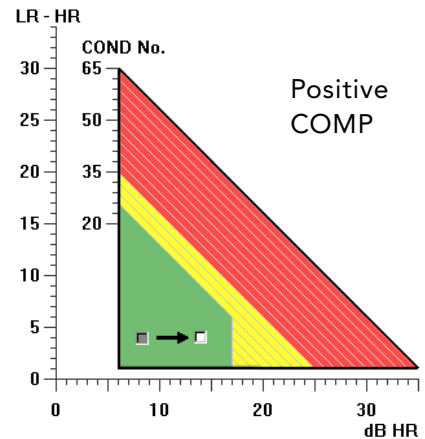



# LR/HR values and CODE

For LR/HR values, the measuring unit is dBsv, i.e. these values are measured on the absolute shock pulse scale and do not, by themselves, express operating condition.

The term delta value simply means the difference between LR and HR.

The operating condition of the bearing is expressed by the CODE letter, the LUB no., and the COND. no., all of them not measuring but evaluation results.

**CODE A** means that the bearing is in good condition. There is no detectable damage to the surfaces of the load carrying parts, and no extreme lack of lubricant in the rolling interface.

**CODE B** indicates dry running. The lubricant is not reaching the rolling interface. This can have several causes, e.g. lack of lubricant supply to the bearing, low temperature in a grease lubricated bearing, or a heavy overload due to misalignment, tight fit, deformed housing, etc.

**CODE C** is displayed when the instrument detects an increased shock pulse level with a large delta value. This points to beginning surface damage.

**CODE D** is displayed when the signal is typical for bearing damage: a high shock level with a large delta value. Contamination of the lubricant by hard particles causes a similar signal.

The message of the codes is supported by the status dot: green for CODE A, yellow for B and C, red for D.

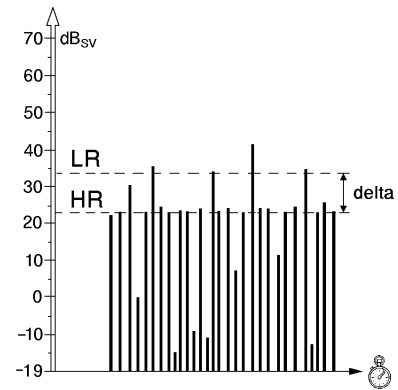

- LR** Measured value for strong shock pulses.
- HR** Measured value for weak shock pulses.
- LR-HR** Delta value.
- dBsv** Unit for absolute shock pulse value.

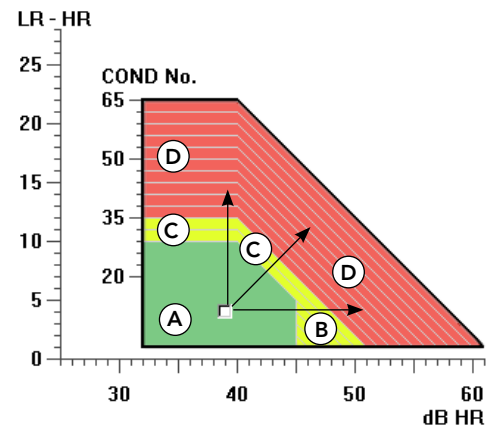

- CODE A** Good condition
- CODE B** Caution, dry running
- CODE C** Caution, damage developing
- CODE D** Bad condition



## The LUB number

The most important influence on the service life of a bearing is the lubricant film between the load carrying rolling elements and the raceway.

By preventing or inhibiting metallic contact between the loaded bearing parts, the lubricant film reduces the local peak stress in the rolling interface. The greater the lubricant film thickness, the more even the load distribution in the contact area, and the better the fatigue life of the bearing.

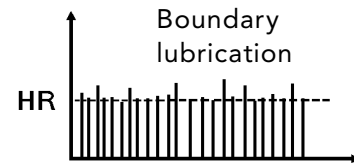
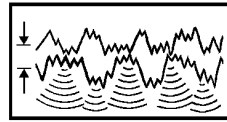
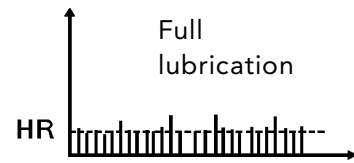
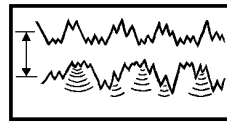

Irregularities in the bearing surfaces will always cause pressure variations in the contact area, and thus shock pulses, even when metallic contact is prevented by a separating lubricant film. A thinner film will result in an increase of the bearing's HR value.

The LUB No., displayed with CODE A and B, is directly proportional to oil film thickness. LUB No. 0 means dry running condition. The interpretation of LUB Nos. between 1 and 4 depends on the bearing type. For ball bearings, LUB Nos. greater than 2 mean full lubrication (a load carrying oil film). For roller bearings, a LUB No. greater than 4 indicates full lubrication.

The term boundary lubrication implies that part of the load is carried by metal to metal contact. The amount of lubricant in or supplied to the bearing is only one of the many factors that determine lubricant film thickness. Lubricant type and the bearing's rpm are of great importance, but also the geometry of bearing parts and housing, as well as the load put on the bearing by alignment and fitting.

LUB	Ball bearing
0	Dry running
1 to 2	Boundary lubrication
3 to 4	Full lubrication

LUB	Roller bearing
0	Dry running
1 to 4	Boundary lubrication
> 4	Full lubrication

# The COND number and error codes

The COND No. (condition number) is displayed with CODE B, C, and D, i.e. for all bearings with reduced or bad condition. It indicates the degree of surface deterioration or damage in the rolling interface.

Large (visible) surface damage typically leads to a very marked increase in the bearing's LR readings and a high delta value. Thus, it is easily detected and will give Code D and high COND numbers.

When a COND number is displayed, the bearing should be watched very carefully. Once damage has started, it cannot be reversed. Temporary improvements of the COND No. only mean that the edges of fresh spallings or imprints have been rounded off. Soon, there will be new spallings. The time left to plan a bearing replacement depends on the trend of the COND No. As a rule, COND Nos. should be interpreted as follows:

COND No. < 30	Minor damage
COND No. 30 to 40	Increasing damage
COND No. > 40	Severe damage

## ERROR CODES

- E2 Disturbance
- E3 Signal too low

When the measured signal is not within the evaluation frame, the Leonova will display error codes. E2 is displayed when  $HR > LR$ , which normally means a high, even disturbance signal such as pump cavitation or a screaming steam box. E3 = signal too low can often be remedied by setting a COMP no.

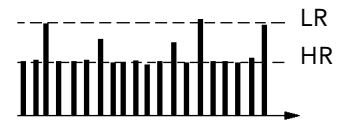
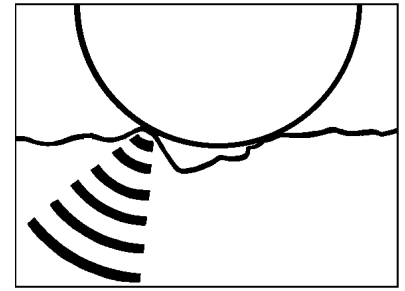

**CODE C**  
COND 28 to 32  
Beginning bearing damage

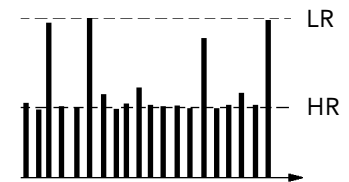

**CODE C**  
COND >32  
Minor to severe bearing damage



# Input data for LR/HR and LR/HR HD

Measuring points for the SPM techniques are normally set up in Condmaster and then downloaded to Leonova. However, it is possible to open the Leonova default file in the SPM window and configurate all measuring parameters. Select 'LR/HR' or 'LR/HR HD' and open with ENTER.

## Transducer

Before starting measurements, make sure that the shock pulse transducer you are using with your Leonova is properly selected.

Default transducers for the shock pulse techniques are set up via the transducer register. Default transducer is the active transducer when 'Portable' transducer is selected under 'Measuring point data'. To select a default transducer, see Chapter A page 15.

You can select other shock pulse transducers from the transducer register (1) if you switch 'Transducer' from 'Portable' to 'Remote'.

When using a DuoTech sensor all fields displays (2) that normally apply to a vibration transducer. The actual data for the individual transducer is written on its calibration card. This data should always be input in the transducer register. When several transducers are in use, they should be marked to assure that the readings are calibrated. Note that measurements with DuoTech will be performed at channel VIB-1.

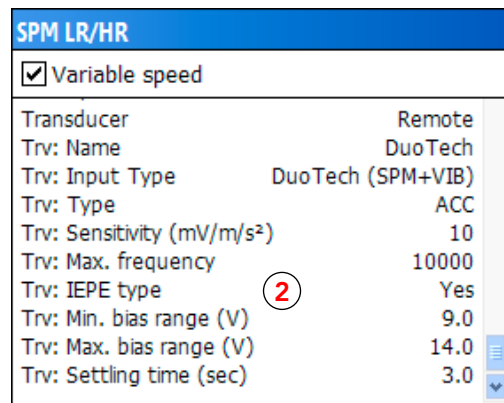
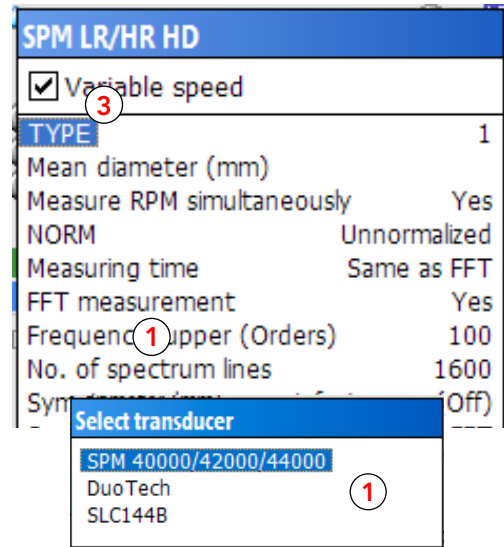

For a normalized reading of bearing condition with the Leonova default file, go to **MENU** > 'Measuring point data' and set the 'TYPE' and the 'NORM' number.

## TYPE number

For 'TYPE' no. definition, see the table on page D:25. Mark the line 'TYPE' (3), open it with the ENTER key, set the number on the keyboard.

## NORM number

The default setting for NORM is UNNORMALIZED, which produces the shock values LR and HR only.

If known, the NORM number can be input directly. Mark the line and open it with the ENTER key, then select the number from the displayed list (4). The first choice on the list (---) also produces an unnormalized measurement.

Given the rotational speed (rpm) and the **mean** bearing diameter, Leonova will calculate and display the NORM number.

There are two alternatives for mean diameter. 'Input ISO bearing number' (5) opens a window (6) where you set the **last three digits** of the ISO number using the **UP/DOWN** arrow keys on the Leonova keypad.

'Input diameter' (7) opens the keyboard. Write the mean diameter, then edit RPM and write the rpm on the keyboard.

The NORM no. will be displayed when the data input is complete.

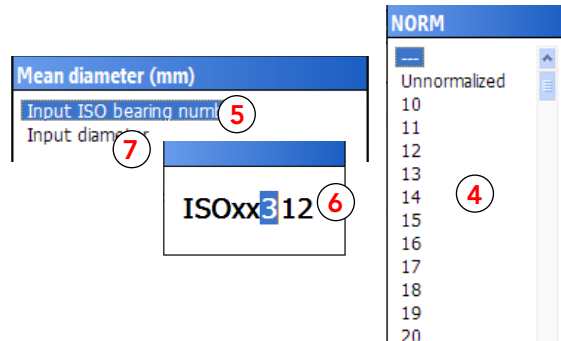

### Variable speed

The alternative 'Variable speed' implies that the shock pulse measurement is preceded by a measurement of the rpm. The NORM no. will be shown in the measurement window after the speed measurement.

### Measure RPM simultaneously

'Measure RPM simultaneously' (8) is normally not used. With this setting on, you are forced to first measure the rpm again before you can repeat the shock pulse measurement.

**ACCUM** (accumulation) is set to 3 or higher on low speed bearings (rpm < 600) and in all cases where extra accuracy is required. Leonova will measure as many times as stated here and then return an average value.

**COMP** means compensation number, see page D:26. This number, if used at all, can first be set after studying the measuring result in Condmaster.

To calculate a new COMP number, select COMP, press Edit (F1) and select "Calculate on next reading". Perform a new measurement. When saving, both the new and the old number is displayed. When transferring to Condmaster you have the option to accept the new or retain the previous COMP number.

### RPM Trigger

When measuring on variable speed machines, an 'RPM trigger' can be used to determine when to start a measurement, ensuring that it is carried out at an appropriate speed. The RPM trigger can be used on applications where useful readings can be obtained only within a limited RPM range, such as in cranes.

'RPM trigger' (9) can be set to 'RPM run up' or 'RPM run down'. 'RPM run up' means Leonova will initiate the measurement, then wait for the machine to speed up to the level input under 'Trigger level' before it starts recording the signals. With 'RPM run down', Leonova waits for RPM to slow down to the 'Trigger level' setting.

Under 'Delay time', you can specify a number of seconds during which Leonova will delay the start of measurement. This setting is optional.

### SPM Spectrum

An SPM spectrum measurement can be carried out along with the LR/HR measurement. It is measured in addition to the ordinary shock values.

Mark the 'SPM Spectrum' row (10). Press **ENTER** and set 'SPM Spectrum' to 'Yes'. Settings for SPM Spectrum are described on page D:33.

### LR/HR HD

The LR/HR technique takes advantages from the SPM HD technique provided that both techniques are active in the Leonova. The LR/HR HD technique utilizes the SPM HD algorithms for time signals and spectrums. Input data for the FFT calculation is the same as for SPM HD.

SPM LR/HR	
<input checked="" type="checkbox"/> Variable speed	
<b>TYPE</b>	8
Mean diameter (mm)	85.0
Measure RPM simultaneously (8)	Yes
NORM	Unnormalized
ACCUM	1
RPM trigger: Trigger type (9)	(none)
SPM Spectrum (10)	No
Transducer	Remote
Trv: Name	SLD2445
Trv: Input Type	SPM

# Measuring LR/HR and LR/HR HD

From the measurement window, the instrument can be set up to perform a transducer quality line test (TLQ) before measurement. Press the ENTER key to enable or disable the TLQ test (1). TLQ (Transducer Line Quality) is described on page D:17.

When the MEASURE/SAVE (M/S) key is pressed, Leonova samples the transducer signal for two seconds if ACCUM is set to 1. When ACCUM is higher, it will continue to measure for the stated number of times and return an average of all measurements taken. The resulting LR and HR value is displayed in the 'Measuring' window, together with the status dot.

For a normalized measurement, LUB, COND and CODE are shown to the right (2).

When 'Variable speed' is active, the rpm must be measured before measuring the shock values.

Please note that LR and HR values are always raw values, measured in dBsv, the unit for unnormalized shock values.

For normalized measurements, LUB is displayed with CODE A and B, COND is displayed with CODE B, C and D.

The 'Measuring result' window (3) shows the results. In the 'Graphics' window (4), press 'Change graph' and select the desired alternative. The 'Lubmaster' graph (5) is displayed only when LR/HR HD is used. The LUB and COND graphs will not be shown for unnormalized readings.

When using the LR/HR HD technique, the produced 'SPM Spectrum HD' and 'Time signal HD' are shown by pressing the function keys (6).

Save the result by pressing the MEASURE/SAVE (M/S) key, or measure again with SHIFT + M/S.

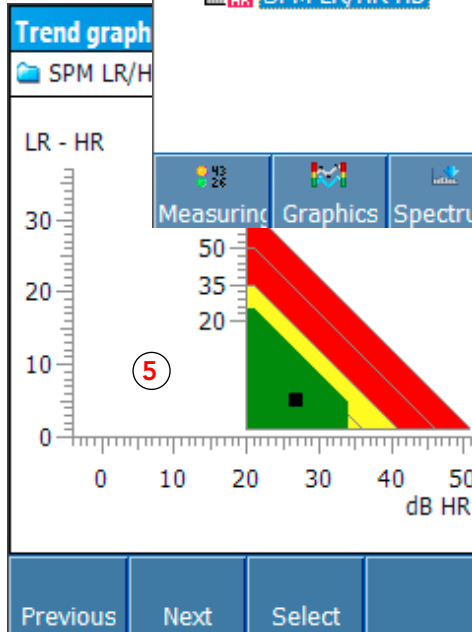
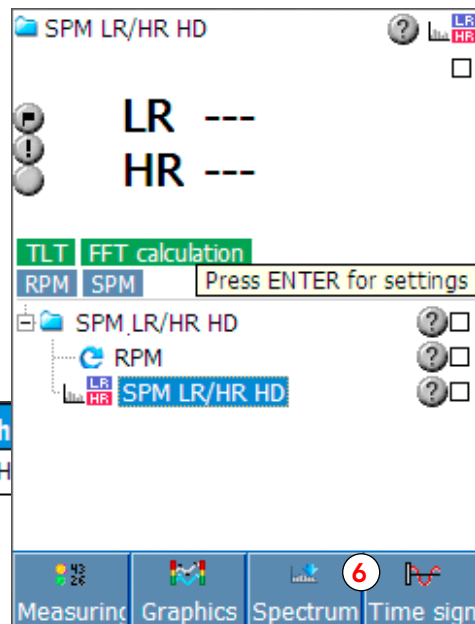
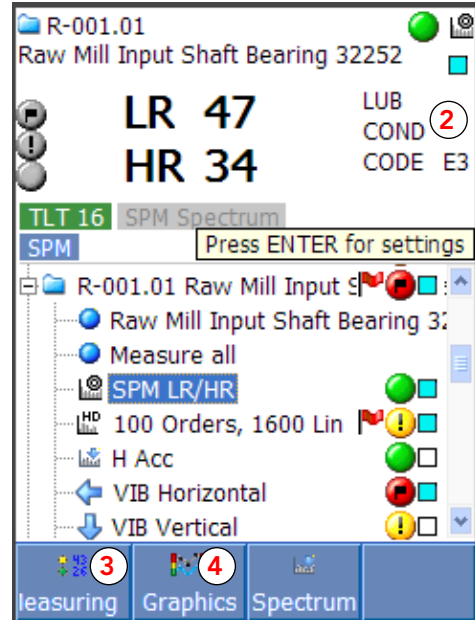
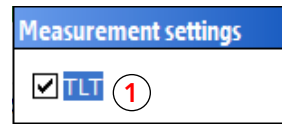

D

## Measuring an SPM Spectrum

An SPM spectrum measurement can be carried out along with either SPM dBm/dBc or SPM LR/HR. It is measured in addition to the ordinary shock values.

Please note that the spectrum has a secondary role in bearing condition evaluation. The primary measure for bearing condition is the evaluated shock pulse measurement.

In cases where the spectrum shows a good match for one or more of the bearing patterns, it is a confirmation that the measured shock pulses are coming from the bearing and not from other possible shock sources on the machine. Thus, the spectrum can make it unnecessary to verify by lubrication test or signal strength comparison (searching for the strongest signal source with the handheld probe).

To obtain a spectrum, go to **MENU** > 'Measuring point data'. Mark the 'SPM Spectrum' row (1). Press the **ENTER** key and set SPM Spectrum to 'Yes' (2).

The default setting is a power spectrum over the range 0 to 1000 Hz. It has 1600 lines of which 800 peaks are saved. The standard window Hanning is used. All these settings can be edited.

Please note that it is not necessary to have an exact rpm reading in order to **measure** a spectrum. However, the exact rpm is very important when you want to interpret the spectrum, especially when you upload it to Condmaster and search for bearing patterns with the help of the bearing symptoms.

All bearing symptoms use the rpm as a variable. If the stored rpm data does not agree with the actual rpm at the time the shock signal was measured, Condmaster cannot find the bearing patterns correctly. Thus, by working with rough estimates of the rpm instead of fresh measurements, the symptom search and especially the symptom value calculation is made worthless.

For measurements intended for saving in Condmaster, it is therefore highly recommended to mark 'Variable speed' (3).

For spectrum functions in Leonova, see part B of this manual.

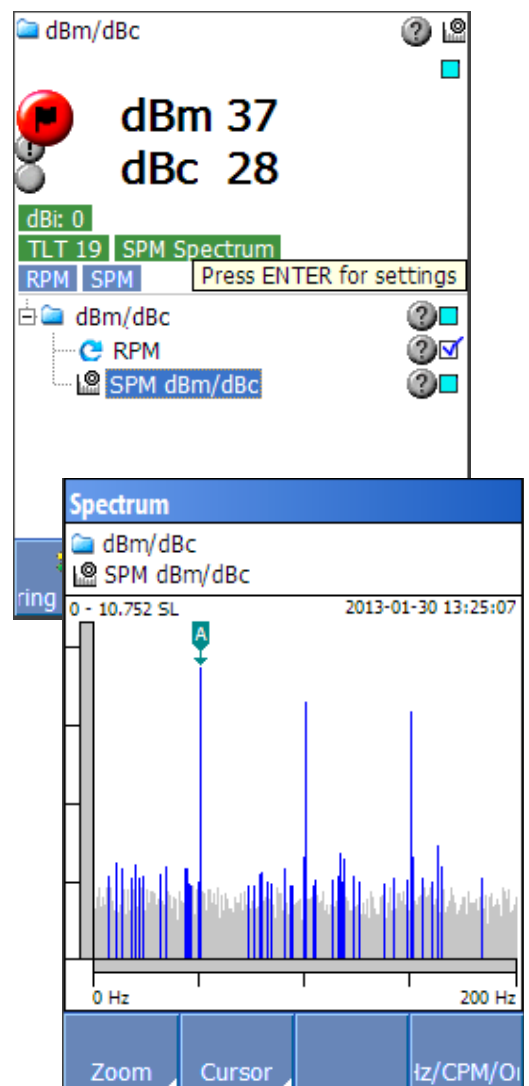
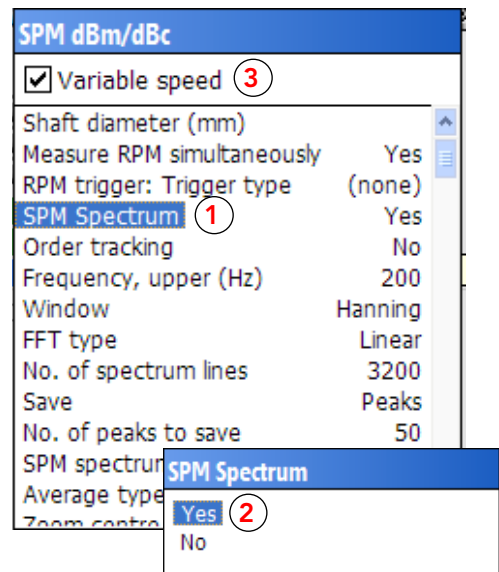

# Editing spectrum data

An SPM Spectrum is based on the amplitude modulation of a high frequency signal. It shows periodic pulses as frequency lines. Thus, if the signal contains a strong pulse that is repeated at one second intervals, there will be a high amplitude line at 1 Hz.

To change any of the spectrum parameters, mark the line, touch 'Edit' and select the value from a list.

## Order tracking

'Order tracking' is described on page B:36.

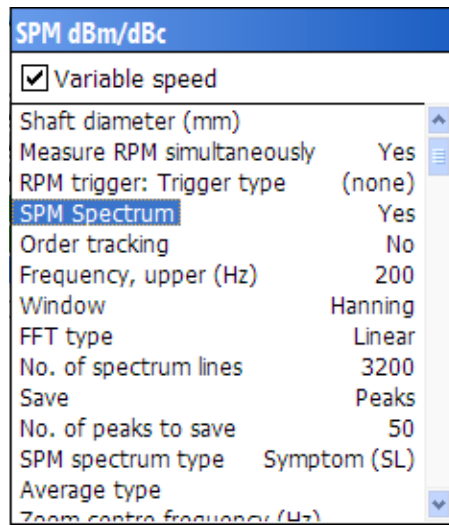

## Frequency range

The frequency range (1) is always from 0 to 'upper frequency'. Set 'Upper frequency' to include 3 or 4 multiples of BPFO (ball pass frequency, outer race). The narrower the range, the better the resolution.

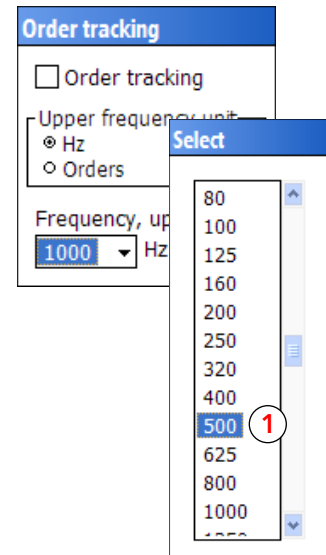

## Window

The choice of 'Window' (2) somewhat affects the spectrum line amplitudes. 'Hanning' (default setting) and Hamming are the window types most commonly used to calculate spectra. The difference is often marginal and should not affect pattern recognition.

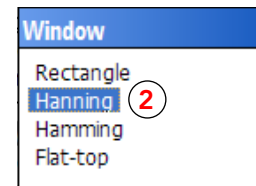

## FFT type

The spectrum type (3) can be 'linear' or 'power'. In a power spectrum, the line amplitudes are squared. Thus, high amplitude lines become more prominent while low amplitude lines are suppressed.

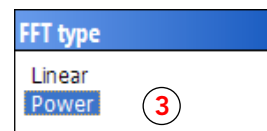



### Number of spectrum lines

The number of spectrum lines (4) affects the resolution and the measuring time. Doubling the number of lines also doubles the measuring time. In cases where different fault symptoms, such as bearing frequencies and multiples of 1X, are close together, a high resolution spectrum is preferred.

Saving a full spectrum requires much memory space and is seldom necessary. Unless the spectrum lines in damage patterns have fairly high amplitudes, the pattern is not visible. Thus, saving only peaks (5) will preserve the essential data while reducing the amount of redundant data. A peak is a spectrum line that has a line with a lower amplitude on either side. If you select 'Save peaks', Leonova will display the full spectrum before saving, with peaks as black lines while the lines to be deleted are grey. The maximum number of peaks that can be saved is half the number of spectrum lines. The number of peaks to be saved is input on the number pad.

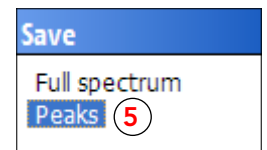
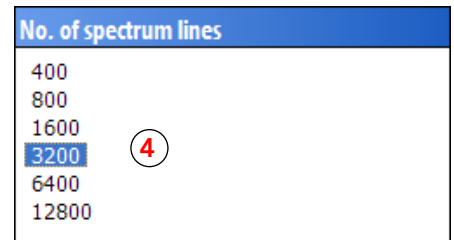

### SPM spectrum type

One unit for amplitude in an SPM Spectrum (6) is SD (Shock Distribution unit), where each spectrum is scaled so that the total RMS value of all spectrum lines = 100 SD = the RMS value of the time record. The alternative unit is SL (Shock Level unit), the RMS value of the frequency component in decibel.

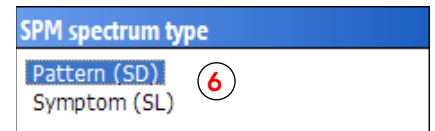

### Average type

To achieve greater accuracy, one can order the average result from a stated number measurements (average count, set on the number pad). To get a time synchronous average, a tachometer must be connected which supplies a trigger pulse. This starts each measurement with the shaft in the same position. 'FFT linear' (7) gives the mean value of the measurements, while FFT peak hold gives the maximum value.

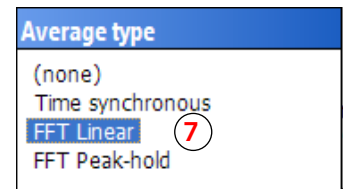

### Zoom factor

True zoom is selected to get a high resolution around a selected 'centre frequency'. This frequency must be within the selected frequency range. Thus, to zoom in on 600 Hz, the minimum range is 0 to 1000 Hz. The range covered by the zoom is 'upper frequency range/zoom factor'. Thus, with a zoom factor of 10, the spectrum will cover the range 550 - 650 Hz.

The highest possible zoom corresponds to a 12800 line spectrum. For this, combine the lowest number of spectrum lines, 400, with a zoom factor of 32 (32 x 400 = 12800). With a centre frequency of 600 Hz, you will get a spectrum over the range 584.375 to 615.625 Hz, with a resolution of 0.078125 Hz.

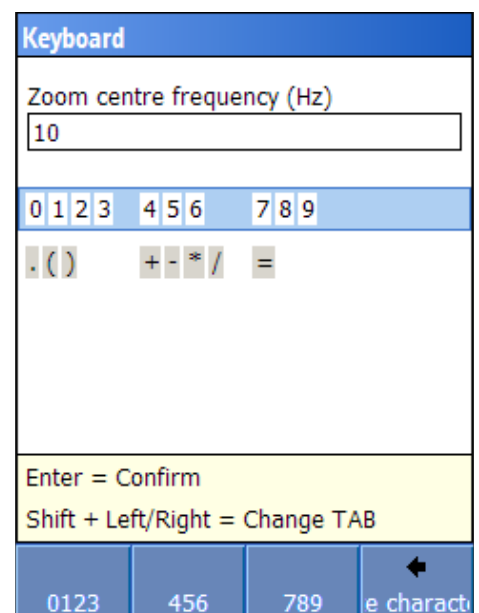



# Vibration measurement

## Contents

Vibration analysis techniques .....	3
Measuring points for vibration .....	4
Measuring point configuration, ISO 10816 .....	5
Guide for machine classification .....	7
Data for ISO 10816 part 2 .....	8
Data for ISO 10816 part 3 .....	9
Data for ISO 10816 part 4 .....	10
Data for ISO 10816 part 5 .....	10
Data for ISO 10816 part 6 .....	11
Measurement results, ISO 10816 .....	12
Making a vibration assignment .....	13
Defining the assignment .....	14
Measurement results .....	19
Making HD ENV assignments .....	21
Defining the assignment .....	22
Measurement results .....	24
Motor current analysis .....	26



## Vibration analysis techniques

Leonova can be programmed with the following vibration measurement techniques with either limited or unlimited use.

**ISO 10816** is the measuring technique based on the ISO standard with this number. ISO 10816 consists of several parts, each stating measurement conditions and a table of limit values for a defined machine type. Like ISO 2372, the evaluation of machine condition is based on the RMS values obtained by broad band measurement over a frequency range up to 1000 Hz. Depending on machine type, one or more of three measured quantities are used to determine vibration severity:

- VEL: the RMS value of vibration velocity in mm/s
- ACC: the RMS value of vibration acceleration in  $m/s^2$
- DISP: the RMS value of vibration displacement in  $\mu m$ .

Please note that spectrum analysis is not part of the requirements set up by ISO 10816 but an extra function provided by the Leonova.

**EVAM** includes all advanced vibration measurement and analysis methods and gives the user a wide range of choices to adapt the condition measurement to a specific machine. EVAM returns three distinct sets of data:

Condition parameters: peak, peak-to-peak, the RMS values of vibration velocity, acceleration and displacement plus values for crest, kurtosis, skewness and noise levels.

Fault symptom values: the amplitude values of selected spectrum line patterns connected with typical machine faults like unbalance, misalignment, gear damage, motor faults, bearing damage, etc.

COND numbers: dimensionless condition numbers, obtained by a statistical evaluation of all selected condition parameters and fault symptom values. Condition numbers are displayed against a green - yellow - red machine condition scale.

**FFT with symptoms** is reduced form of EVAM, lacking the statistical evaluation by means of criteria and possibility to display and save time signal.

**Common features** for ISO 10816, EVAM and FFT with symptoms are the condition parameters VEL, ACC, DISP and the spectrum. For an ISO 10816 measuring point, only one spectrum is saved, while an EVAM/FFT measuring point can have many. **This means that a measuring point set up for ISO 10816 can at any time be converted into an EVAM or FFT with symptoms measuring point.**

**HD ENV<sup>®</sup>** is an ideal complement to conventional vibration techniques, capable of detecting at a very early stage such machine problems which are generally difficult to find in good time with non-enveloping techniques, for example bearing and gear damages. HD ENV requires that the measuring technique 'Vibration Premium' or 'Vibration Supreme' is active.

# Measuring points for vibration

Common for all vibration measurement is that the vibration at the measuring point has to be representative for the overall vibration of the machine. Please study ISO 10816, it shows examples for various machine types.

Typical measuring points are the bearing housings. ISO 10816 states the required measuring directions.

- Horizontal vibration (H) in the plane of rotation is most representative of balance condition.
- Vertical vibration (V) in the plane of rotation is most representative of structural weakness.
- Axial vibration (A) along the line of the shaft is most representative of faulty alignment and bent shafts.

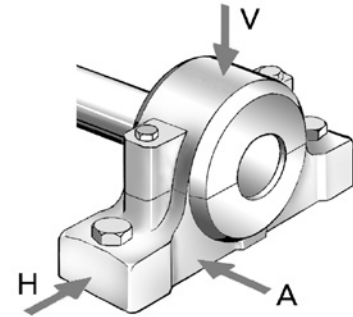

As the cause for excessive vibration will usually show up in the spectrum, measuring in the direction that returns the highest RMS value can be quite sufficient to accurately establish machine condition. To get comparable results, measuring points should be clearly marked, so that the measurements can always be taken in the same spots.

SPM vibration transducers can be used

- as a hand-held probe, with or without the probe tip attached. Not recommended above 1000 Hz.
- with a magnet for attachment to ferrous metal parts. Not recommended above 2000 Hz.
- with the M8 (UNC 1/4"-28) mounting screw.

The firmer the contact with the machine, the better the measuring result. Plain, clean metal makes the best contact surface for the vibration transducer.

When using a hand-held probe it is important to press the transducer with the same strength every time to get comparable readings.

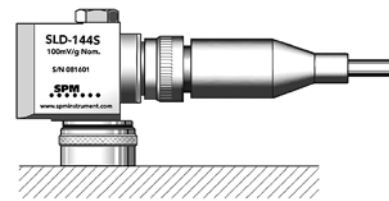

Transducer with magnet

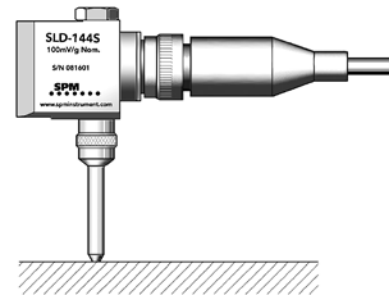

Hand-held probe

## DuoTech® accelerometers (Dual Technology)

The DuoTech® accelerometer is a single transducer solution used for vibration or shock pulse measurements or both in combination.

- DuoTech with quick connector, TRC100, for use with permanently installed measuring adapters. Connect the DuoTech via the measuring cable CAB82.
- DuoTech for permanent installation, SLC144.

Permanently installed DuoTech accelerometers are mounted in a countersunk mounting holes identical to holes normally used by shock pulse transducers. The accelerometer has 2-pin connector and is connected to Leonova or a measuring terminal via twisted pair cable. DuoTech is connected to the VIB input on Leonova.



DuoTech with quick connector

## Transducer line quality, TLQ

Leonova is automatically testing the quality of signal transmission between transducers of type IEPE and instrument before measurement. The unit of measure is voltage (Bias). Accepted values depends on transducer settings. Not acceptable values generates an error message.

E

## Measuring point configuration, ISO 10816

Measuring points for ISO 10816, EVAM and FFT with symptoms are normally set up in Condmaster and then downloaded to Leonova.

However, it is possible to open the Leonova default file in the vibration window (1) and configure all measuring parameters. Please note that most of the settings become locked once the measurement has been made.

Fault symptoms cannot be attached to the measuring point in Leonova but can be added after the measuring point has been uploaded to Condmaster.

Select 'ISO10816' with the arrow keys and open with ENTER. Open 'Measuring point data' with SHIFT+F3. Mark the lines in the configuration window one by one with UP/DOWN. Open them with ENTER.

Before starting vibration measurements, make sure that the vibration transducer you are using with your Leonova is properly selected.

Default vibration transducers for the vibration techniques are set up via the transducer register. Default transducer is the active transducer when 'Portable' transducer is selected under 'Measuring point data'. To select a default transducer, see Chapter A page 13.

The transducer data become editable after you switch 'Transducer' (2) from 'Portable' to 'Remote'. Provided you know the transducer's frequency range and its upper and lower bias range, you can input the data here.

The nominal sensitivity of a vibration transducer SLD144S is 10.0 mV/m/s<sup>2</sup>. The actual sensitivity of the individual transducer is written on its calibration card. This data should always be input in the transducer register. When several transducers are in use, they should be marked to assure that the readings are calibrated.

The acquisition time (3) is automatically updated when the parameters that affect the time changes.

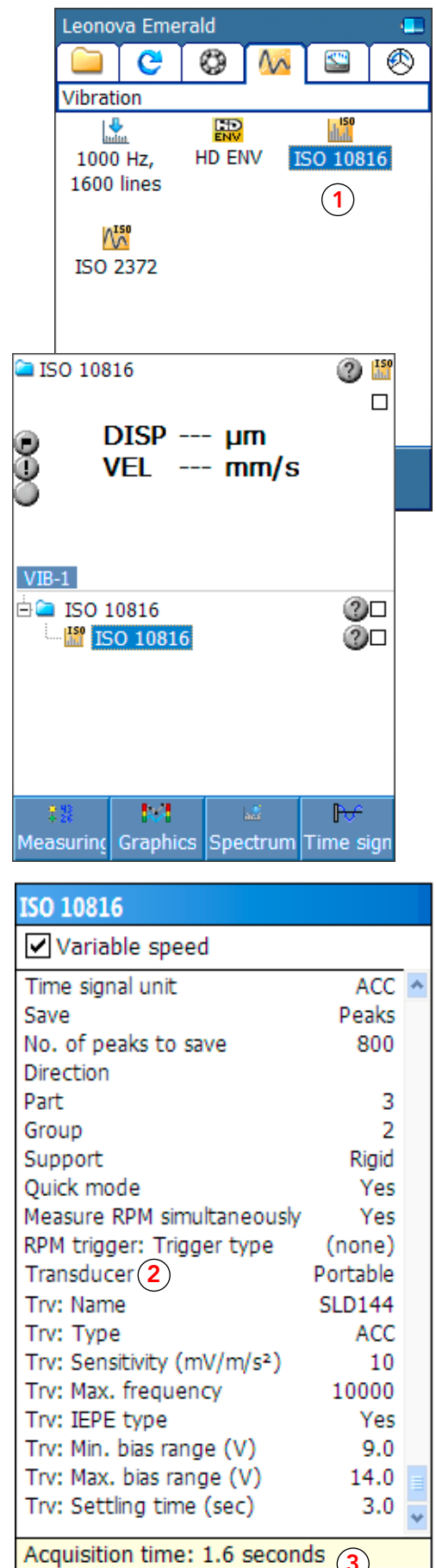

To evaluate a spectrum, you need to know the RPM of the shaft at the time of vibration measurement. Mark 'Variable speed' (1). This forces a speed measurement before you can measure the vibration.

'Time signal unit' (2) can be ACC, VEL or DISP.

On the line 'Save' (3) you determine the type of measuring results you want. There are five alternatives.

'Time signal (FFT calculated)' saves the time signal and calculates the FFT.

'Full spectrum' returns a 1600 line velocity spectrum. By default, the range is 2 to 1000 Hz.

'Peaks' will save the number of peaks you input under 'No. of peaks to save' (4). A peak is a spectrum line with a higher amplitude than the lines on either side of it. Thus, a 1600 line spectrum can contain max. 800 peaks.

'Condition parameters' selects the RMS vibration values and excludes the spectrum.

'Time signal and FFT' saves the time signal and the calculated FFT.

The line 'Direction' (5) lets you select one of the three measurement directions. Your choice is then displayed in the measurement window.

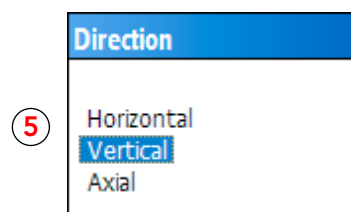
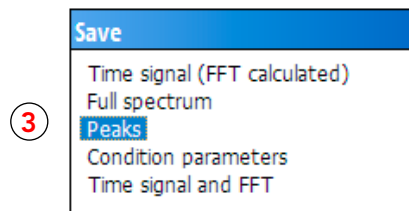
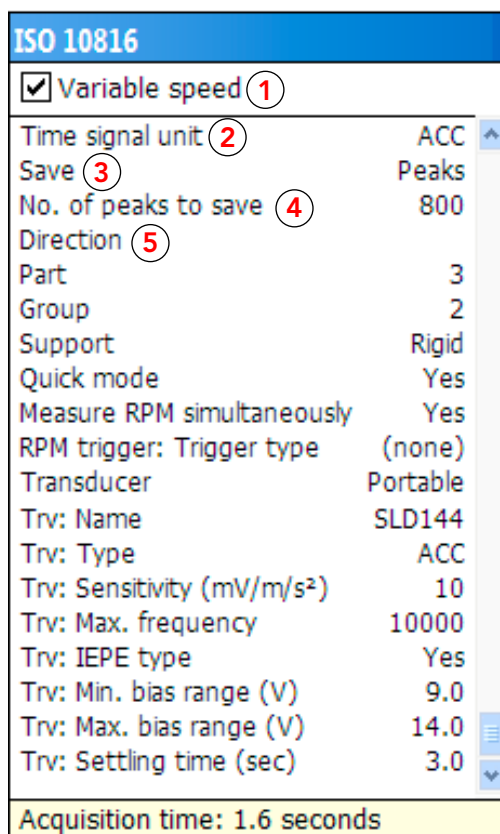



# Guide for machine classification

Machine condition evaluation according to the ISO 10816 standard requires a correct classification of the monitored machine.

So far, ISO 10816 consists of six parts. Part 1 contains general guide lines.

Parts 2 to 6 describe 5 different machine types. Most of these have sub divisions, each with its own set of limit values defining acceptable and unacceptable vibration levels.

The lines 'Part', 'Group' and 'Support' (1) contain the data defining a specific set of limit values in ISO 10816. Opening the line 'Part' leads to a step-by-step guide that helps you to input all necessary data.

'Quick mode' (2) is used to speed up the measurement. The measurement calculations will be based on the FFT instead of the time signal, resulting in faster settling time.

ISO 10816	
<input checked="" type="checkbox"/> Variable speed	
Time signal unit	ACC
Save	Peaks
No. of peaks to save	800
Direction	
Part	3
Group (1)	2
Support	Rigid
Quick mode (2)	Yes
Measure RPM simultaneously	Yes
RPM trigger: Trigger type	(none)
Transducer	Portable
Trv: Name	SLD144
Trv: Type	ACC
Trv: Sensitivity (mV/m/s <sup>2</sup> )	10
Trv: Max. frequency	10000
Trv: IEPE type	Yes
Trv: Min. bias range (V)	9.0
Trv: Max. bias range (V)	14.0
Trv: Settling time (sec)	3.0
Acquisition time: 1.6 seconds	

## Data for ISO 10816 part 2

'Part' refers to a sub division of the ISO standard. So far, parts 2 to 6 have been published.

Marking a part number displays the definition of the machine type treated in the part.

In case the machine you want to monitor is a 'large land-based steam turbine generator set in excess of 50 MW', part 2 is your obvious choice.

This machine class has no sub group. Instead, the choice of limit value table depends on machine speed, either '1500/1800 r/min' or '3000/3600 r/min'.

Marking the appropriate speed range leads to the final window which shows the ISO recommended frequency range (10 to 500 Hz), the recommended measurement quantity (vibration velocity = VEL) and the limit values or 'zone boundaries'.

Vibration zones A and B are acceptable, so any measurement result below the B/C boundary of 5.30 mm/s RMS will be marked green. Results from 5.30 mm/s to below 8,50 mm/s will be yellow and 8.50 mm/s and higher will be red.

**ISO 10816 guide**

Part

- 2
- 3
- 4
- 5
- 6

Large land-based steam turbine generator sets in excess of 50 MW.

**ISO 10816 guide**

Shaft rotational speed

- 1500/1800 r/min
- 3000/3600 r/min

**ISO 10816 guide**

Frequency, upper

500 Hz

Frequency, lower

10 Hz

VEL (RMS)

- A/B - 2.80
- B/C - 5.30
- C/D - 8.50

E

# Data for ISO 10816 part 3

Part 3 treats most of the common industrial machines.

They are divided into 4 groups:

## Group 1

Large machines with rated power above 300 kW and not more than 50 MW; electrical machines with shaft height above 315 mm.

## Group 2

Medium machines with rated power above 15 kW up to and including 300 kW; electrical machines with shaft height from 160 mm to 315 mm.

## Group 3

Pumps with multivane impeller with **separate** driver (centrifugal, mixed flow or axial flow) with rated power above 15 kW.

## Group 4

Pumps with multivane impeller with **integrated** driver (centrifugal, mixed flow or axial flow) with rated power above 15 kW.

Further criteria for Part 3 are the rigidity of the foundation and the rotational speed.

Concrete foundations are rigid, every thing else falls under flexible.

The RPM affects the lower measuring range as well as the limit values.

Please note that correct measurement of very low frequency vibration demands a transducer that is linear down to the stated frequency. Abnormally high displacement values can occur when selecting a lower frequency limit that is outside of the transducer's range.

For machines under Part 3, Leonova returns both VEL and DISP. Machine condition is determined by the quantity that has the relatively highest measurement results.

Press F3 to confirm the settings.

**ISO 10816 guide**

Group

1  
2  
3  
4

Medium machines with rated power above 15 kW up to and including 300 kW; electrical machines with shaft height 160 mm =< H < 315 mm.

**ISO 10816 guide**

Group

1  
2  
3  
4

Large machine with rated power above 300 kW and not more than 50 MW; electrical machines with shaft height H >= 315 mm.

**ISO 10816 guide**

Support

Rigid  
Flexible

**ISO 10816 guide**

Shaft rotational speed

Lower than 600 r/min  
600 r/min or higher

**ISO 10816 guide**

Frequency, upper  
1000 Hz

Frequency, lower  
10 Hz

DISP (RMS)  
A/B - 29.00  
B/C - 57.00  
C/D - 90.00

VEL (RMS)  
A/B - 2.30  
B/C - 4.50  
C/D - 7.10



## Data for ISO 10816 part 4

Part 4 is limited to 'Gas turbine driven sets excluding aircraft derivatives'. The standard also states a power output of at least 3 MW.

For this part, input the RPM of the turbine. This does not affect the vibration limit values but the upper frequency limit of the measurement, up to 5000 Hz for a turbine speed of 20000 RPM.

ISO 10816 guide	
Part	
2	
3	
<b>4</b>	
5	
6	
Gas turbine driven sets excluding aircraft derivatives.	

## Data for ISO 10816 part 5

Part 5 is for 'Machine sets in hydraulic power generating and pumping plants', divided into 4 groups. Please study the definitions and drawings provided in the standard.

ISO 10816 guide	
Part	
2	
3	
4	
<b>5</b>	
6	
Machine sets in hydraulic power generating and pumping plants.	

ISO 10816 guide	
Group	
1	
<b>2</b>	
3	
4	
Horizontal machine sets with bearing housing which is only braced against the casing of the hydraulic machine, usually with operational speed of less than 300 r/min.	

ISO 10816 guide	
Frequency, upper	1000 Hz
Frequency, lower	10 Hz
DISP (RMS)	
A/B	29.00
B/C	57.00
C/D	90.00
VEL (RMS)	
A/B	2.30
B/C	4.50
C/D	7.10

## Data for ISO 10816 part 6

Part 6 is for 'Reciprocating machines with power rating above 100 kW'.

For this type of machinery, the standard provides 7 tables with limit values. Depending on the vibration level when the machine is new and in good condition, the user is supposed to select one of these tables as a norm for the machine.

If you know your table, you simply select its classification number.

When you mark 'Measure', Leonova will select the appropriate table and display its number. Please note that this requires a machine in 'new and good condition', with low vibration values. You then edit the measuring point data and input the proposed table number instead of 'Measure'.

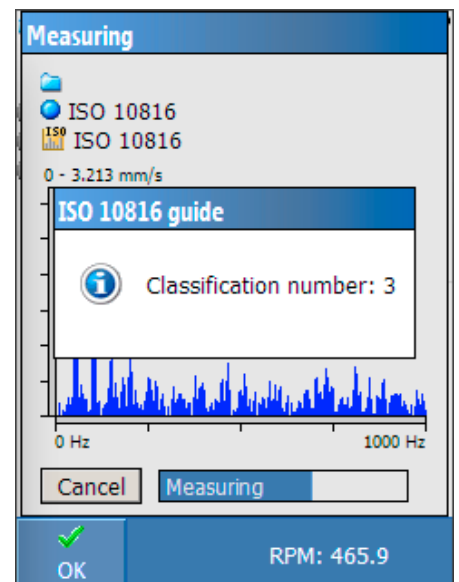
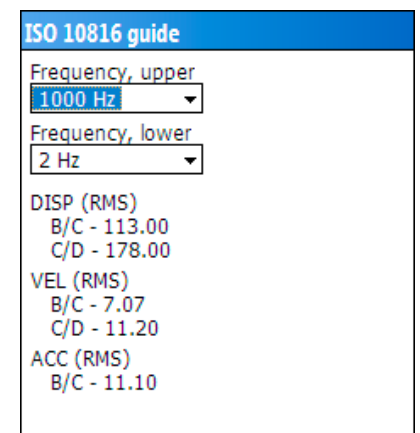
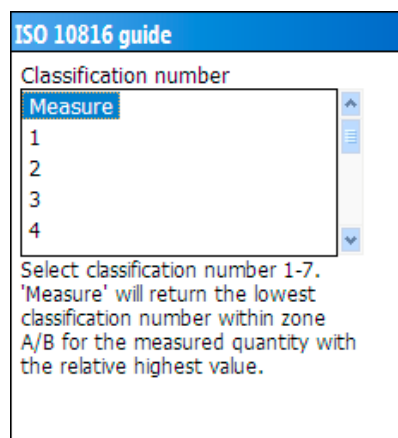
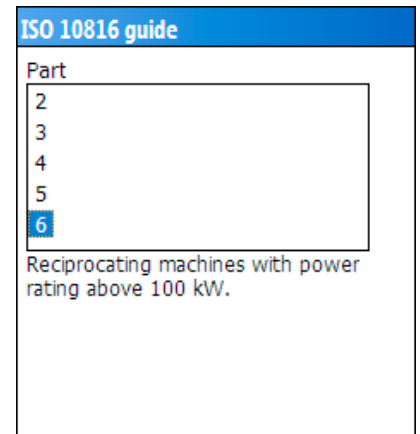

# Measurement results, ISO 10816

Depending on the part of the standard and the machine group, ISO 10816 gives limit values for displacement (DISP) and either velocity (VEL) or acceleration (ACC). Leonova automatically adjusts the measurement quantity display to the selected part and group.

In this case, Leonova will display the evaluated result in DISP, VEL and ACC, because all three parameters are returned when Part 6 is selected.

In case the different parameters fall into different evaluation zones, the large status dot (1) will show the worst case, while the small status dots (2) show the individual evaluation. Press F1 to see the 'Measuring result' window.

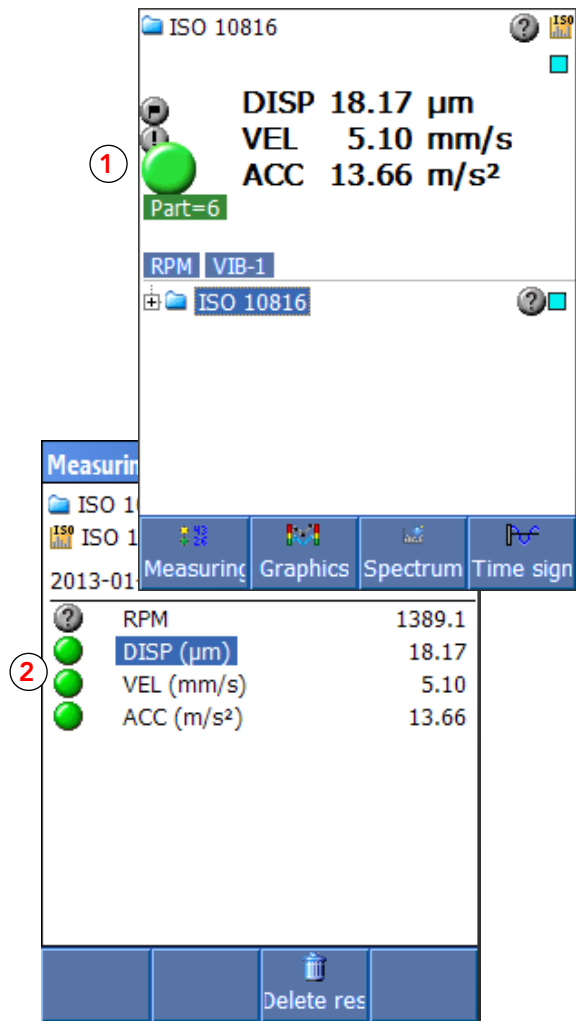

The spectrum (3) is always a velocity spectrum. For spectrum functions in Leonova, see part B of this manual.

E

Pressing F4 (4) toggles between Hz, CPM and, if rpm is measured, orders.

To save the measuring result, press MENU and select 'Save as'. The measurement can be saved as a result file or as a file with default settings.

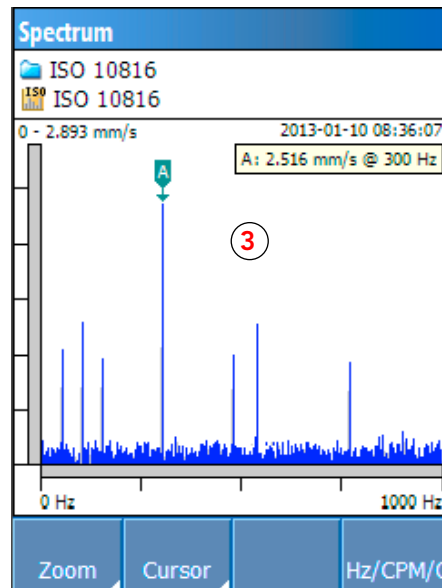

4

## Making a vibration assignment

A proper measuring point for FFT with symptoms or EVAM has to be made in Condmaster using the Condition Manager.

In Leonova, you can set up a vibration assignment, returning a set of condition parameters and single spectrum measured in accordance with the parameters you input under 'Measuring point data'.

You can rename the file with a descriptive name. Mark the vibration default file (1) with the LEFT/RIGHT arrow keys. Press SHIFT+F2 and select 'Rename' (2). Input a name via the keyboard window and save with ENTER. The new name will show up in the measurement window. The default file (1) will have the new name after restarting the instrument.

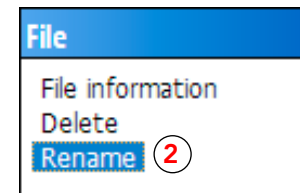
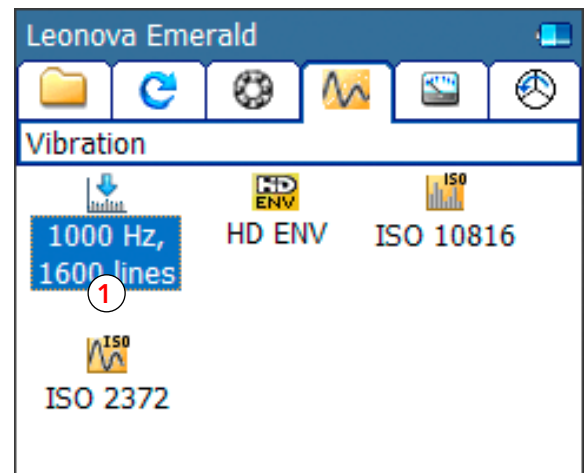

Press ENTER to open the vibration default file (1).

Press SHIFT+F3 to open 'Measuring point data'.

Before starting vibration measurements, make sure that the vibration transducer you are using with your Leonova is properly selected.

Default transducers for the vibration techniques are set up via the transducer register. Default transducer is the active transducer when 'Portable' transducer is selected under 'Measuring point data'. To select a default transducer, see Chapter A page 15.

The transducer data become editable after you switch 'Transducer' (3) from 'Portable' to 'Remote'. Provided you know the transducer's frequency range and its upper and lower bias range, you can input the data here.

The nominal sensitivity of a vibration transducer SLD144 is 10.0 mV/m/s<sup>2</sup>. The actual sensitivity of the individual transducer is written on its calibration card. This data should always be input in the transducer register. When several transducers are in use, they should be marked to assure that the readings are calibrated.

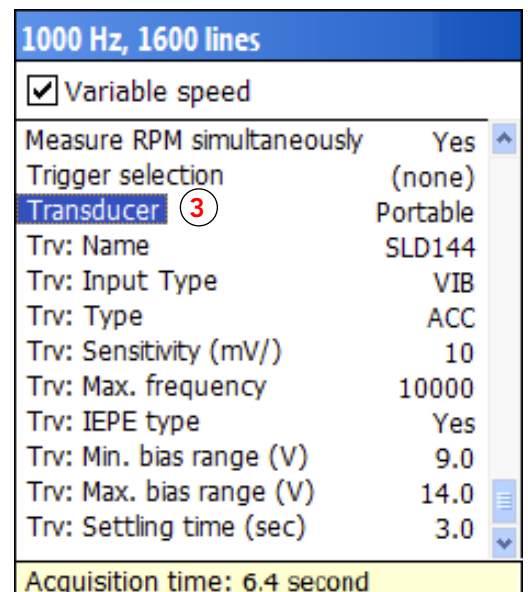

# Defining the assignment

To evaluate a spectrum, you need to know the RPM of the shaft at the time of vibration measurement. Mark 'Variable speed' (1). This forces a speed measurement before you can measure the vibration.

With 'Measuring point data' you can edit the measuring parameters. Open with SHIFT+F3 and mark the lines in the configuration window one by one with the UP/DOWN keys. Open them with F1, 'Edit'.

The transducer setting 'Portable' selects the default transducer. 'Time signal unit' is the unit for the time signal, while 'Spectrum unit' is the measuring unit for the spectrum (e. g. VEL for a velocity spectrum).

The acquisition time (2) is automatically updated when the parameters that affect the time changes.

## Frequency range

The frequency range (3) is defined by selecting a lower and an upper limit (4). Both are menu selected. When using the optional function 'Order tracking' (5) the upper frequency is set in orders.

Please note that correct measurement demands a transducer that is linear over the stated frequency range.

Abnormally high displacement values can occur when selecting a lower frequency limit that is outside of the transducer's range.

You can exceed the upper frequency range of the transducer when measuring an envelope spectrum.

## Time signal unit

As time signal unit you can select VEL, ACC or DISP (6).

The 'Display' setting (7) effects the presentation of measuring results displayed in the result field (upper part of the Leonova display). Select display units for the three result lines. You can choose ACC, VEL and DISP as RMS, Peak or Peak to peak (8).

## Spectrum unit

As spectrum unit (9) you can select VEL, ACC or DISP. Normally you would choose a velocity spectrum, i. e. VEL.

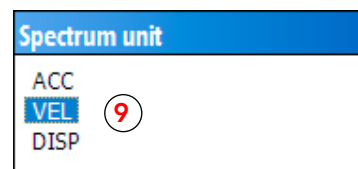
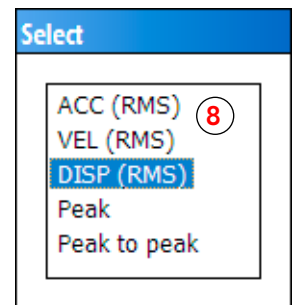
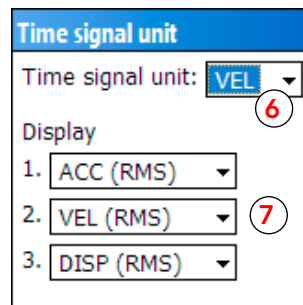
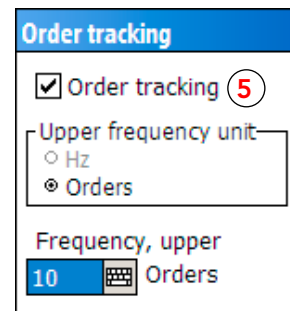
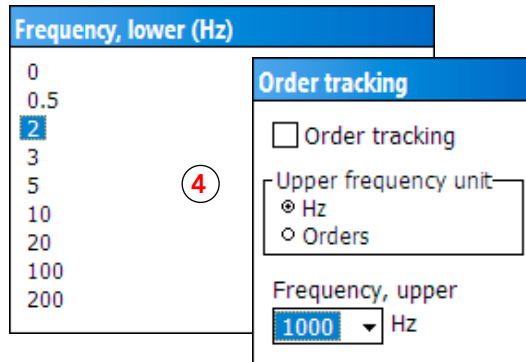
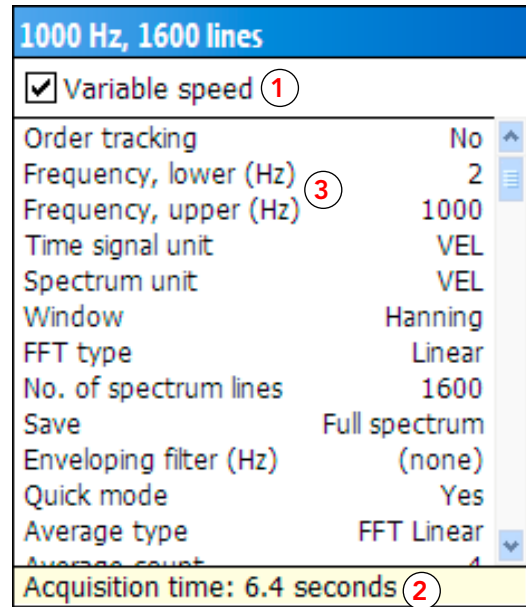

E



## Window

To compensate for the leakage effect introduced by the FFT process, a window function is usually applied. The user should choose the appropriate window (1) function for the specific application. If the windowing is not applied correctly, errors may be introduced in the FFT effecting amplitude, frequency or even the overall shape of the spectrum.

- Rectangle. The Rectangle (None, Uniform) window is the one to choose for transient signals. The Rectangle window has the best frequency resolution but poor amplitude accuracy and high spectral leakage.
- Hanning/Hamming. The Hanning and Hamming windows are best for random signals. These windows have good frequency resolution and also rather fair amplitude accuracy. Since the Hanning window also has somewhat lower spectral leakage, this window is usually the one to prefer.
- Flat-top. The Flat-top window should be applied on sinusoidal signals. This window has the best amplitude accuracy, but poor frequency resolution.

As general advice, use:

- Hanning window for frequency accuracy (this is the most common window to use).
- Rectangle window only on transient signals.
- Flat-top window for amplitude accuracy.

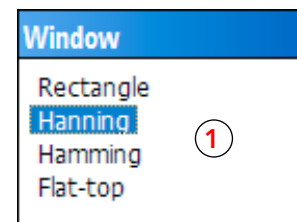
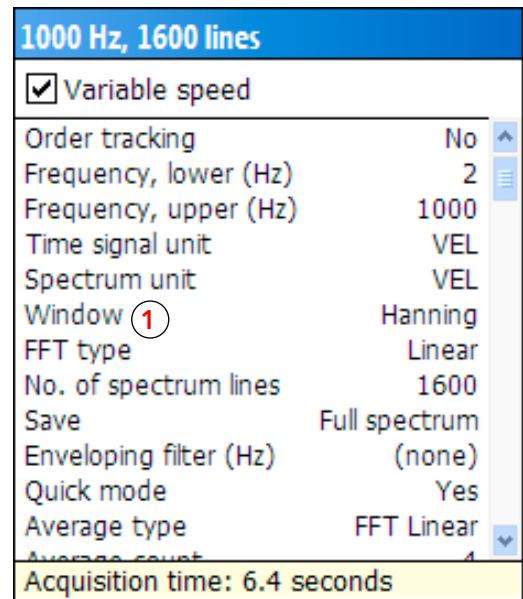

**FFT type**

Four different FFT types (1) can be selected:

'Linear spectrum' consists of RMS values on a linear scale. Each value is the equivalent of the RMS value of a sinusoidal signal of the correspondent frequency. If the spectrum unit is velocity,  $v$ , the amplitude scale is accordingly:  $v_{rms}$ .

'Amplitude spectrum' is closely related to the Linear spectrum scale. The Amplitude spectrum shows the peak value instead of the RMS value. If the spectrum unit is velocity,  $v$ , the amplitude scale is accordingly:

$v_{peak}$ .

'Power spectrum' (Autopower). Each value is the equivalent of the RMS square value of a sinusoidal signal of the correspondent frequency. If the spectrum unit is velocity,  $v$ , the amplitude scale is accordingly:  $v^2_{rms}$ .

'Power Spectral Density' (PSD). This is a power spectrum where each amplitude value is divided by the FFT line width times the used window's equivalent noise band width. If the spectrum unit is velocity,  $v$ , the amplitude scale is accordingly:  $v^2_{rms}/Hz$ .

As general advice, use:

- Linear or Power spectrum on periodic signals.
- PSD spectrum on non-periodic (noise) signals.

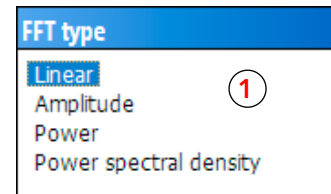
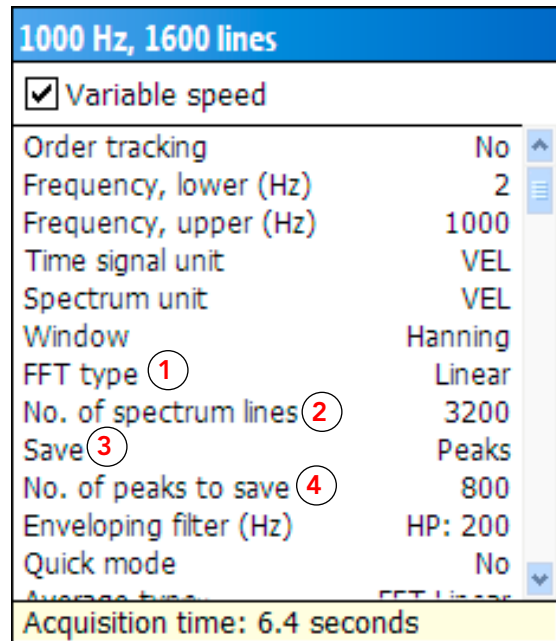

**Number of spectrum lines**

The number of spectrum lines (2) affects the resolution and the measuring time. Doubling the number of lines also doubles the measuring time. In cases where different fault symptoms, such as bearing frequencies and multiples of 1X, are close together, a high resolution spectrum is preferred.

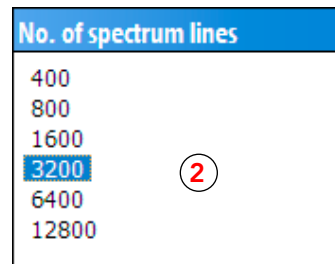

**Spectrum to save**

Saving a time record or a full spectrum requires more memory. Unless the spectrum lines in damage patterns have fairly high amplitudes, the pattern is not visible.

Thus, saving only peaks will preserve the essential data while reducing the amount of redundant data. A peak is a spectrum line that has a line with a lower amplitude on either side.

If you select 'Peaks' under 'Save' (3), Leonova will display the full spectrum before saving, with the peaks as black lines while the lines to be deleted are grey. The maximum number of peaks that can be saved is half the number of spectrum lines. The number of peaks to be saved (4) is input on the number pad.

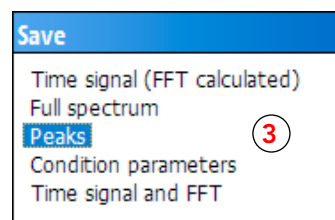

E

### Enveloping filter

Enveloping is a technique used to detect low energy vibration typically caused by gear and bearing damage. This type of damage tends to modulate the amplitude of high frequency vibration, e. g. at the natural frequency of the transducer.

To suppress all vibration in the lower frequency ranges, a high pass (HP) filter is set at 1000 or 2000 Hz (1). To suppress vibrations in both the lower and the higher frequency ranges, select one of the band pass filters (Filter 1-4).

### Quick mode

'Quick mode' (2) is used to speed up the measurement. The measurement calculations will be based on the FFT instead of the time signal, resulting in faster data acquisition time.

Quick mode can not be combined with enveloping, time signal or condition parameters (Crest, Kurt, Skew, NL1 to NL4).

### Average type

To achieve greater accuracy, one can order the average result (3) from a stated number measurements (average count, set on the number pad). To get a time synchronous average, a tachometer must be connected which supplies a trigger pulse. This starts each measurement with the shaft in the same position. 'FFT linear' gives the mean value of the measurements, while FFT peak hold gives the maximum value.

### Average overlap

To achieve faster collection of measuring values, one can set 'Average overlap' (4) to 25% or 50%. This function reduces the measuring time by using less time waveform data to produce the spectrum.

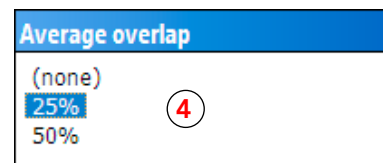
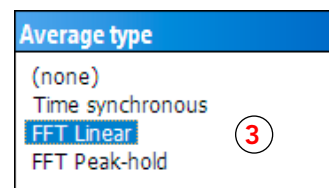
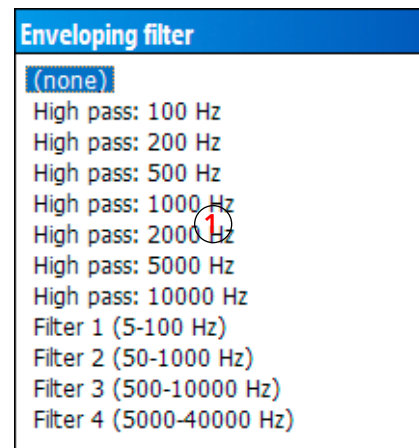
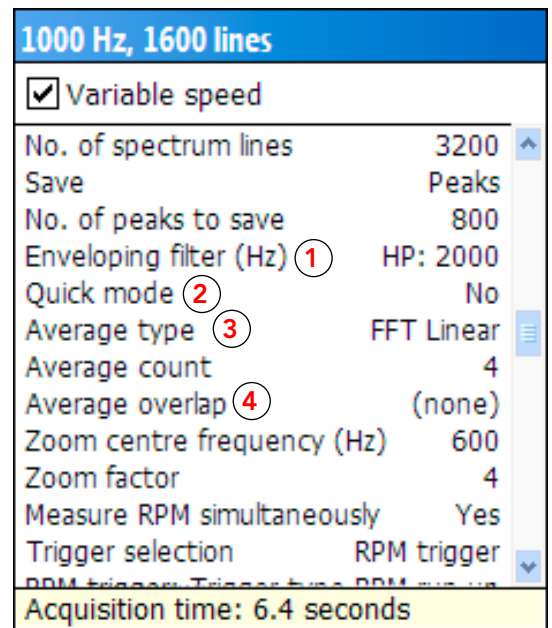

### Zoom centre and zoom factor

True zoom (1) is selected to get a high resolution around a selected 'centre frequency'. This frequency must be within the selected frequency range. Thus, to zoom in on 600 Hz, the minimum range is 0 to 1000 Hz. The zoom factor can be set to 2, 4, 8, 16, 32 or 64. The range covered by the zoom is 'upper frequency range/zoom factor'. Thus, with a zoom factor of 8, the spectrum will cover the range 537.5 - 662.5 Hz.

The highest possible zoom corresponds to a 12800 line spectrum. For this, combine the lowest number of spectrum lines, 400, with a zoom factor of 32 (32 x 400 = 12800). With a centre frequency of 600 Hz, you will get a spectrum over the range 584.375 to 615.625 Hz, with a resolution of 0.078125 Hz.

When using the optional function 'Order tracking' the zoom centre frequency is set in orders.

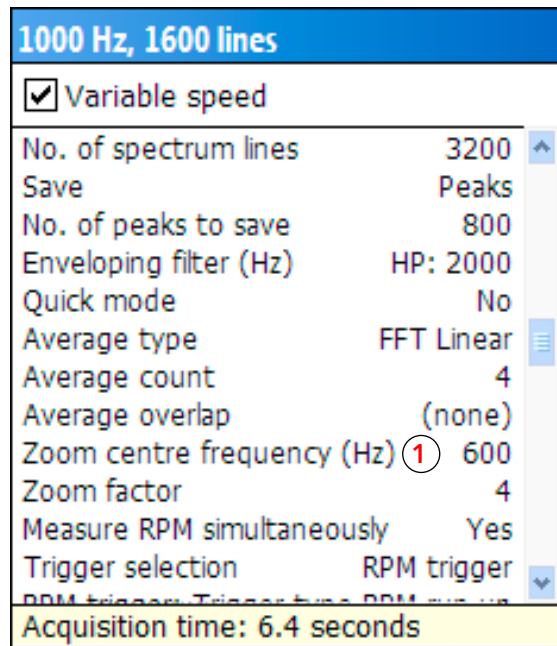

### Trigger selection

The trigger function (2) can be set 'Post trigger' or 'RPM trigger'. 'Post trigger' is primarily used for measuring in rolling mills.

- 'Trigger Level' (3) is set to activate measurement when the vibration/rpm level exceeds/falls below the set value.
- "Delay time" (4) is a delay in seconds before the measurement begins after the 'Trigger level' is exceeded.
- "RPM trigger type" (5) can be set to 'RPM run up' or 'RPM run down' (6). The measurement begins when the rpm exceeds respectively falls below the set trigger level.

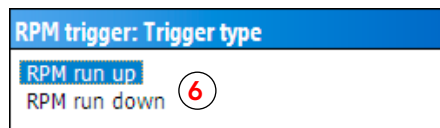
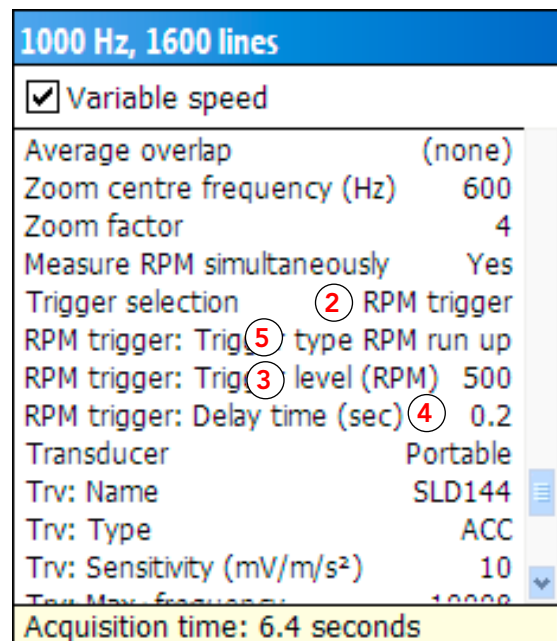

E

## Measurement results

Press the M/S key to measure or F1 'Measure all' for a measurement in a round. If the rpm assignment is set up with 'Pseudo Tac' in Condmaster, this will automatically be activated and indicated together with the rpm (1). The 'Pseudo Tac' function is described in the CondmasterUser Guide.

The live spectrum display (2) in the 'Measuring' window can be changed to show time signal by pressing Shift+F1.

After measuring vibration, Leonova will display three main condition parameters: DISP, VEL and ACC as (RMS), (Peak) or (Peak to Peak). Units for the displayed parameters are selected under 'Time signal unit' when defining the assignment under 'Measuring point data' (SHIFT+F3).

The status dots (3) are grey because there are no evaluation criteria for EVAM assignments set up in Leonova.

Press F1 to see the full list of condition parameters (4) in the measuring result window.

To delete a measuring result, press F1 (previous) or F2 (next) to select result and then press F3 to delete.

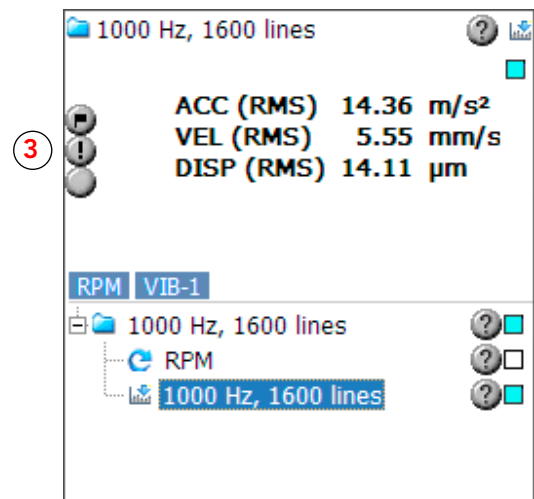
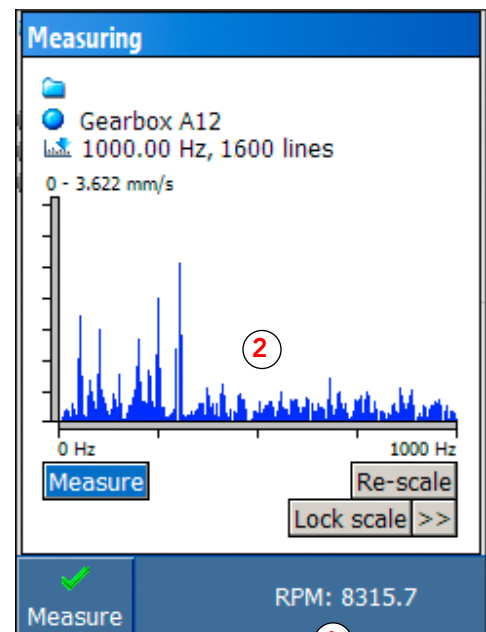

Parameter	Value
CREST	3.096
KURT	-0.023
SKEW	0.015
NL1 (µm/s)	62.41
NL2 (µm/s)	31.77
NL3 (µm/s)	19.20
NL4 (µm/s)	15.97
VEL, Peak (mm/s)	18.57
VEL, Peak to peak (mm/s)	36.93
10 Unbalance (mm/s)	0.52

'Peak' and 'Peak to peak' values are displayed in the selected time signal unit.

Press F2 to see the full scale graphics where you can re-scale the axis, set comments etc. (see part B of this manual).

Change graph by pressing F3 in the graphics window. Pressing F1 (Previous) and F2 (Next) toggles between the different graphs.

The spectrum is displayed in the selected spectrum unit, here velocity (1).

Pressing F4 (2) toggles between Hz, CPM and, if rpm is measured, orders.

You can choose spectrum type, zoom functions, time signal and other graphical functions with the function keys. See 'Spectrum functions' in part B of this manual.

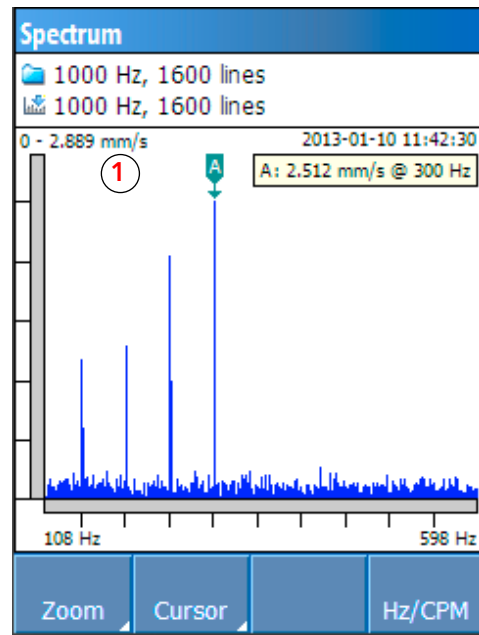

## Making HD ENV assignments

HD ENV is an ideal complement to conventional vibration techniques. Capable of detecting at a very early stage such machine problems which are generally difficult to find in good time with non-enveloping techniques, for example bearing damages and gear damage, the method utilizes cleverly engineered algorithms for digital signal processing to obtain optimal data for trending purposes.

To follow an impact related damage throughout its development in all stages, from initial crack to loose parts and spalling, it is recommended to set up three vibration measuring assignments:

- one HD ENV assignment with filter 4 for detection of early faults
- one HD ENV assignment with filter 3 for detection of more developed faults
- one velocity vibration assignment for detection of far advanced faults

A proper measuring point for HD ENV has to be made in Condmaster and downloaded to Leonova. However, it is possible to open the 'HD ENV' default file in the Vibration window (1) and configurate all measuring parameters.

You can rename the file with a descriptive name. Mark the vibration default file (1) with the LEFT/RIGHT arrow keys. Press SHIFT+F2 and select 'Rename' (2). Input as name via the keyboard window and save with ENTER. The new name will show up in the measurement window. The default file (1) will have the new name after restarting the instrument.

Select the 'HD ENV' default file (1) and press ENTER to open.

Press SHIFT+F3 to open 'Measuring point data'.

Before starting vibration measurements, make sure that the vibration transducer you are using with your Leonova is properly selected.

### Default transducer

Default vibration transducers for the vibration techniques are set up via the transducer register. Default transducer is the active transducer when 'Portable' transducer is selected under 'Measuring point data'. To select a default transducer, see Chapter A page 15.

The transducer data become editable after you switch 'Transducer' (3) from 'Portable' to 'Remote'. Provided you know the transducer's frequency range and its upper and lower bias range, you can input the data here.

The actual sensitivity of the individual transducer is written on its calibration card. This data should always be input in the transducer register. When several transducers are in use, they should be marked to assure that the readings are calibrated.

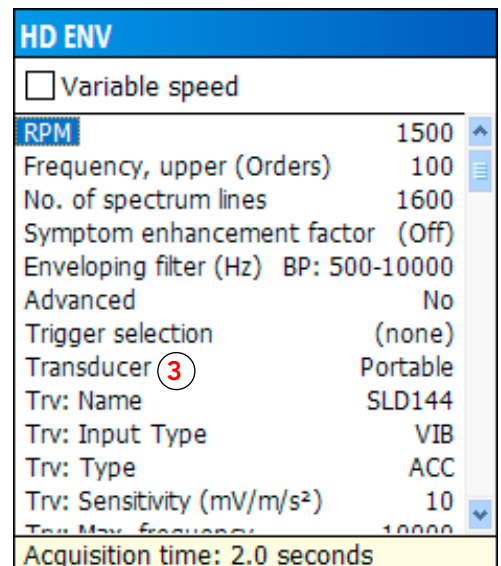
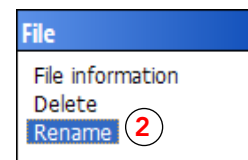
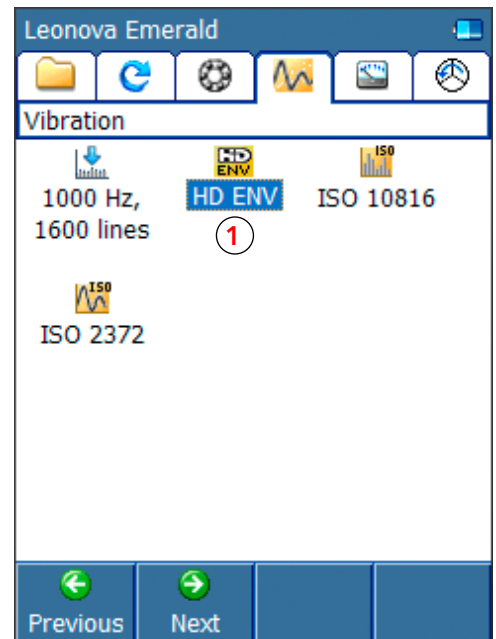

# Defining the assignment

With 'Measuring point data' you can edit the measuring parameters. Open with SHIFT+F3 and mark the lines in the configuration window one by one with the UP/DOWN keys. Open them with F1, 'Edit'.

## Variable speed

The alternative 'Variable speed' (1) implies that the vibration measurement is preceded by a measurement of the rpm. HD Order Tracking is always on when measuring HD ENV.

## Measure RPM simultaneously

'Measure RPM simultaneously' (2) is normally not used. With this setting on, you are forced to measure the rpm simultaneously with the vibration measurement. This must be activated when using 'Time synchronous averaging'.

## Frequency, upper (Orders)

The frequency range is defined by selecting an upper limit in orders (3).

Please note that correct measurements with the higher BP and HP filters an SLD144, or similar, must be used.

You can exceed the upper frequency range of the transducer when measuring an envelope spectrum.

## Number of spectrum lines

The number of spectrum lines (4) affects the resolution and the measuring time. Doubling the number of lines also doubles the measuring time. In cases where different fault symptoms, such as bearing frequencies and multiples of 1X, are close together, a high resolution spectrum is preferred.

## Symptom enhancement factor

The 'Symptom enhancement factor' (5) is used to improve the signal-to-noise ratio. For applications with little electronic noise and few mechanical shock phenomena, this factor can be kept low (0 - 5). Where noise and random shocks are frequently occurring, it is recommended that the 'Symptom enhancement factor' is set to 5-10. However, you should be aware that the higher this factor, the longer the measurement cycle.

The Y axis unit in spectrum is HDeuE (HD enveloping units Enhanced) and in time signal is HD<sup>2</sup>euE when a symptom enhancement factor is used.

## Acquisition time

The acquisition time (6) is automatically updated when the parameters that affect the time changes.

HD ENV	
<input checked="" type="checkbox"/> Variable speed	1
Measure RPM simultaneously	2 Yes
Frequency, upper (Orders)	3 100
No. of spectrum lines	4 1600
Symptom enhancement factor	5 (Off)
Enveloping filter (Hz)	BP: 500-10000
Advanced	Yes
Time synch. averaging	OFF
Trigger selection	Post trigger
P. Trigger: Trigger level (HDeu)	24
P. Trigger: Delay time (sec)	5
Transducer	Portable
Trv: Name	SLD144
Trv: Input Type	VIB
Trv: Type	ACC
Trv: Sensitivity (mV/m/s <sup>2</sup> )	10
Trv: Max. frequency	10000
Trv: IEPE type	Yes
Trv: Min. bias range (V)	9.0
Trv: Max. bias range (V)	14.0
Trv: Settling time (sec)	3.0
Acquisition time: 3.1 seconds 6	

No. of spectrum lines

- 400
- 800
- 1600 4
- 3200
- 6400
- 12800

Symptom enhancement factor

- (Off)
- 1
- 2
- 3
- 4
- 5 5
- 6
- 7
- 8
- 9
- 10

E



### Enveloping filter (Hz)

To detect damages or anomalies in different stages, a number of predefined high pass and band pass filters are available. The band pass filters are named filter 1-4. Filter 1 and 2 are normally used for special applications and filter 3 and 4 for gear and bearing damage.

Filter 1 = 5–100 Hz

Filter 2 = 50–1000 Hz

Filter 3 = 500–10000 Hz

Filter 4 = 5000–40000 Hz

### Advanced

Advanced (Yes/No) opens the option 'Time synch. averaging'.

### Time synch. averaging (TSA)

To achieve greater accuracy, one can order the average result from a stated number measurements. To get a time synchronous average, a tachometer must be connected which supplies a trigger pulse. This starts each measurement with the shaft in the same position. Time synchronous averaging requires variable speed. Please note that TSA is recommended for detection of gear faults only, not for bearing faults.

### Trigger selection

When measuring on variable speed machines, an 'RPM trigger' can be used to determine when to start a measurement, ensuring that it is carried out at an appropriate speed. The purpose of 'Post trigger' is to avoid the recording of irrelevant signals that may ultimately cause false alarms. It can be used where strong signals can be expected which are process related and not attributed to machine damage.

'RPM trigger' will initiate the measurement, then wait for the machine to speed up to the level input under 'Trigger level' before it starts recording the signals. 'Trigger type' is 'none' for RPM trigger.

When using 'Post trigger', input a value (HDeu) under 'Trigger level'. In the above example (3), Leonova will initiate an HD ENV measurement and wait for the signal's HDeu level to reach 24 before it starts a complete measurement including time signal and FFT. Make sure you input a viable trigger level; if the level is never reached, the measurement must be aborted manually. 'Symptom enhancement factor' must be off when using post trigger.

Under 'Delay time', you can specify a number of seconds during which Leonova will delay the start of measurement. This setting is optional.

HD ENV	
<input checked="" type="checkbox"/> Variable speed	
Measure RPM simultaneously	Yes
Frequency, upper (Orders)	100
No. of spectrum lines	1600
Symptom enhancement factor	(Off)
Enveloping filter (Hz) ①	BP: 500-10000
Advanced	Yes
Time synch. averaging	OFF
Trigger selection ②	Post trigger
P.Trigger: Trigger level (HDeu)	24
P.Trigger: Delay time (sec) ③	5
Transducer	Portable
Trv: Name	SLD144
Trv: Input Type	VIB
Trv: Type	ACC
Trv: Sensitivity (mV/m/s <sup>2</sup> )	10
Trv: Max. frequency	10000
Trv: IEPE type	Yes
Trv: Min. bias range (V)	9.0
Trv: Max. bias range (V)	14.0
Trv: Settling time (sec)	3.0
Acquisition time: 3.1 seconds	

Enveloping filter
(none)
High pass: 100 Hz
High pass: 200 Hz
High pass: 500 Hz
High pass: 1000 Hz
High pass: 2000 Hz ①
High pass: 5000 Hz
High pass: 10000 Hz
Filter 1 (5-100 Hz)
Filter 2 (50-1000 Hz)
Filter 3 (500-10000 Hz)
Filter 4 (5000-40000 Hz)

Trigger selection
(none)
RPM trigger ②
Post trigger

## Measurement results

Press the M/S key to measure or F1 'Measure all' for a measurement in a round. If the rpm assignment is set up with 'Pseudo Tach' in Condmaster, this will automatically be activated and indicated together with the rpm (1). The 'Pseudo Tach' function is described in the Condmaster User Guide.

After measuring, Leonova will display the result in HDrp (HD real peak), a scalar value expressed in decibels. Representing the true highest peak found in the enveloped signal, HDrp is the primary value to use for determining the severity of a bearing or gear damage. It is also used for triggering alarms in Condmaster.

In the example two assignments are setup with different filter settings, 500-10000Hz (filter 3) and 5000-40000Hz (filter 4). Both assignments are measured parallel when pressing 'Measure all' (2).

The status dots (3) are grey because there are no evaluation criteria for the HD ENV assignments set up in Leonova.

To delete a measuring result, press F1 (Measuring result), select result and then press F3 to delete. Selected result is marked with a blue vertical line.

Press F2 to see the HDrp trend in full scale where you can re-scale the axis, set comments etc. (see part B of this manual).

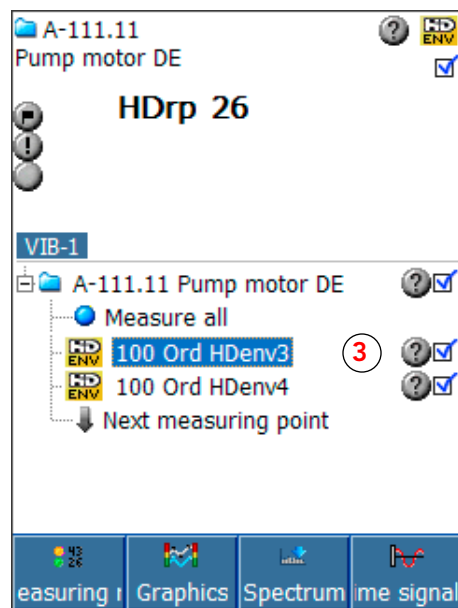
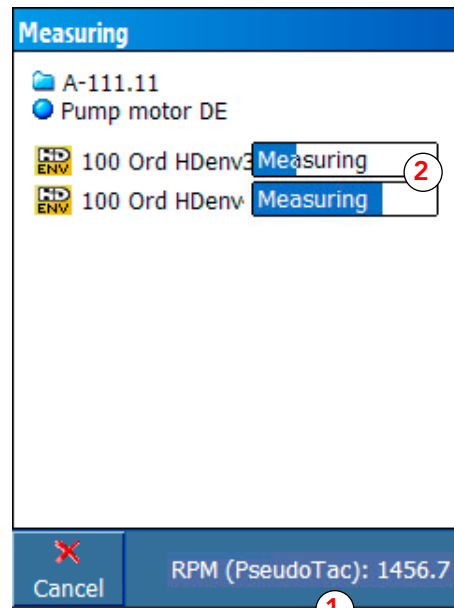

E

Press F3 to see the HD ENV Spectrum (1). This is useful to determine where a possible bearing damage is located. It is also useful for trending purposes (applying symptom and band values). The spectrum is displayed in HDeu or HDeuE when an enhancement factor is used. Pressing F4 (2) toggles between Hz, CPM and, if rpm is measured, orders.

Press F4 to see the HD ENV Time Signal (3). This is extremely useful to locate where in the bearing a possible damage is located. In many cases it is also possible to determine the nature of the damage (a single crack or spalling all around etc.). The scale on the y-axis is displayed in HD<sup>2</sup>euE when an enhancement factor is used and HDeu when the factor is off.

You can choose zoom functions, cursors and other graphical functions with the function keys. See 'Spectrum functions' in part B of this manual.

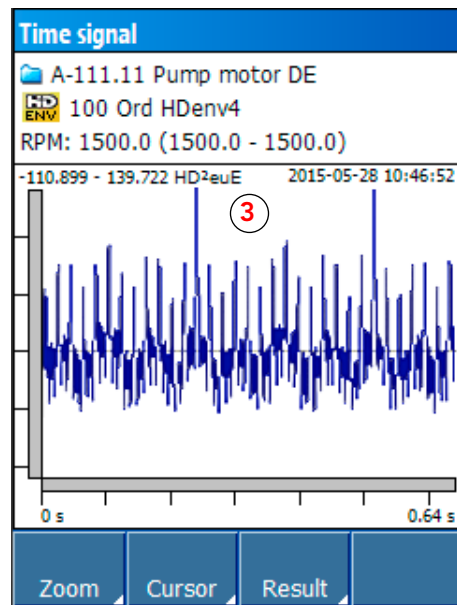
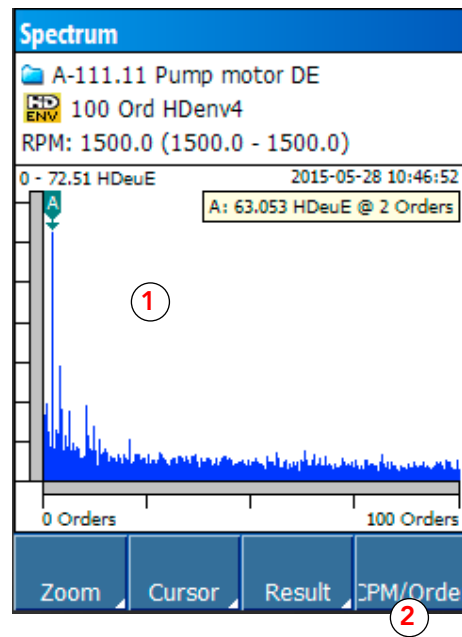

E

# Motor current analysis

Motor current analysis can be performed with the EVAM vibration analysis technique using a current clamp (e.g. Fluke i1000s) or a permanently installed current transformer connected to the VIB input. This feature is used for troubleshooting, primarily on electrical motors with at least 70% workload.

**NOTE: It is important to follow safety precautions and that the measurement is performed by authorized personnel.**

In order to use a current clamp, a user defined transducer is to be set up. Fluke i1000s is the type of current clamp used in this example.

To register a user defined vibration, press MENU and open 'Settings' (SHIFT+F3). Select 'Vibration transducers' and press F1 (OK) to open the transducer register (1).

Select 'New' (2) with the F1 key, then input the following data. Press F1 to save the settings and close with the BACK key.

- Name: A descriptive name. It will be shown on the list of transducers.
- Type: Select 'User defined'
- User defined name: Is the name shown in the measurement window
- Sensitivity: The transducer's nominal sensitivity in mV/displayed unit
- Max. frequency: The transducer's upper frequency range.
- IEPE type: Select 'No'

Information about 'Sensitivity' (depends on which range is measured) and 'Max. frequency' is marked on the clamp and/or found in the technical specification belonging to the device).

Press F4 'Default transducers', select 'Vibration' and press F1. Open the register with ENTER and select the current clamp to be used with UP/DOWN. Press F1 to save the settings and close with the BACK key.

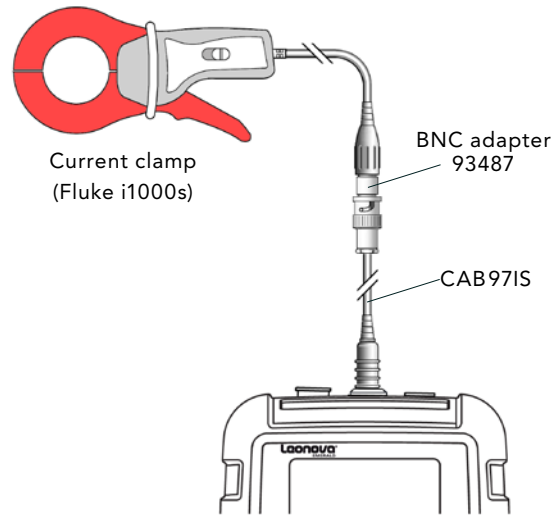

**Vibration transducers**

SLD144 1

Fluke i1000s

**New**

Trv: Name 2 Fluke i1000s

Trv: Type User defined

Trv: User defined, name Current clamp

Trv: User defined, unit A

Trv: Sensitivity (mV/A) 100

Trv: Max. frequency 10000

Trv: IEPE type No

**Default transducers**

Vibration 3

Balancing

**Select**

(none)

Fluke i1000s 4

SLD144

**Vibration**

Transducer

Fluke i1000s

E

To start measurement, open an existing measurement under 'File' or make a new EVAM assignment. Assignments can be set up in Condmaster for downloading in measuring rounds.

Select the EVAM technique and press ENTER to make a new assignment. Press SHIFT+F3 to open 'Measuring point data'.

Set 'Frequency, lower' to 20 Hz and 'Frequency, upper' to 80 Hz (common area for motor current analysis) (1). Press F1 'Edit' to change the values. Press F1 'OK' to save the setting.

'Time signal unit' and 'Spectrum unit' must be set to 'User defined' (2)

Input 'User defined, name' and 'User defined, unit' (3). **NB. The name and unit must be exactly the same as the name and unit set in the transducer register.** You will find the name and unit in the lower part of the window (4).

Recommended settings for the spectrum parameters (5) are Hanning 'Window', Linear 'FFT type', 1600 'Spectrum lines', 'Average count' 4 and 'Save' time signal and FFT.

The transducer setting 'Portable' selects the default transducer. The transducer data become editable after you switch 'Transducer' (6) from 'Portable' to 'Remote'.

Save and close the settings window with F4.

Press the M/S key and then F1 to start the measurement.

After measuring, Leonova will display the measuring results in ampere, peak and peak-to-peak values (7). You can choose spectrum type, zoom functions, time signal and other graphical functions with the funktion keys. See 'Spectrum functions' in part B of this manual.

To save the measuring result, press MENU and select 'Save measurement'. The measurement can be saved as a result file or as a file with default settings.

After the file or measuring round is uploaded to Condmaster, measuring results available for analysis are time signal (in ampere) and spectrum (y-axis is always ampere).

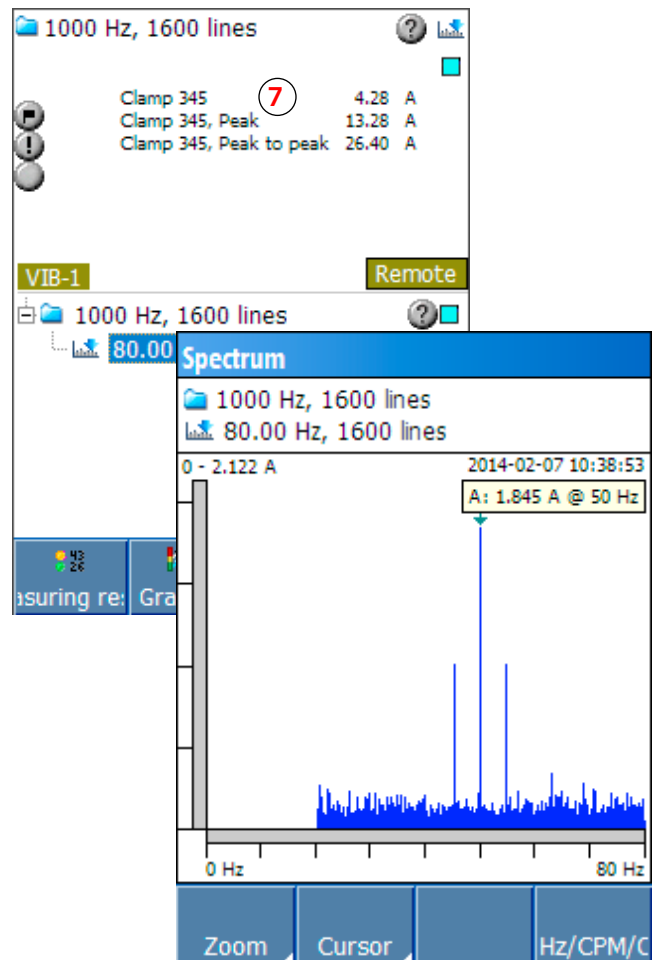
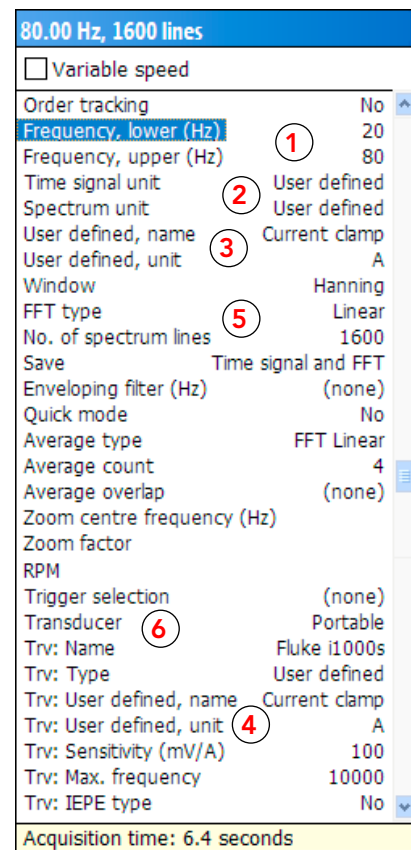



# Rotor balancing

## Contents

Balancing methods.....	3
Balancing equipment .....	4
General settings.....	5
Default transducer for balancing measurement .....	6
Unbalance .....	7
Measuring unbalance .....	8
Four run method .....	9
Two run method.....	9
Transducer selection and speed measurement .....	10
Run without trial weight .....	11
Run without trial weight (cont.) .....	12
Trial weight calculation .....	13
Run(s) with trial weight.....	14
Display of results.....	15
Alternatives for balancing weights .....	16
Trial run and log.....	17
Finish the balancing job .....	18
Create report .....	19
ISO balancing standard 1940-1 .....	20





## Balancing methods

Single plane balancing is an optional Leonova function with unlimited use.

### Single plane balancing, 4 runs

This method uses one measurement without trial weight to determine the vibration severity (mm/s RMS) of the rotor, followed by three measurements with trial weights at 0°, 120° and 240° to calculate the weight and position of the correction mass. No rpm measurement is needed but all measurements must be done at the same rpm.

### Single plane balancing, 2 runs

This method uses one measurement without trial weight to determine the vibration severity (mm/s RMS) of the rotor, followed by one measurements with a trial weight to calculate the weight and position of the correction mass. It requires time synchronised vibration measurement (trigger pulse supplied by a pulse from the SPM tachometer probe or a proximity switch) to find the relative phase angle between the two vibration measurements.

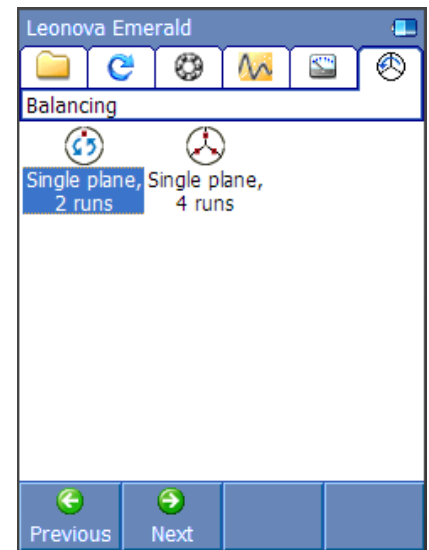

Please note: To get a good result fast, the static unbalance must be corrected before starting the balancing procedure with Leonova.

For all methods, a final run can be made to check the balancing results and, if needed, get the data for further adjustments. Leonova then saves a balancing log file.

Leonova guides step-by-step through the balancing procedure. One can shift the rotation direction and change the measured parameter from velocity to acceleration or displacement.

In addition to the RMS value, a spectrum is shown to help find the part of vibration that is due to unbalance. For the 2-run methods, the number of 'synchronized readings' for obtaining a time average is set to min. 5. The recommendation is 10-20 readings.

## Balancing equipment

For single plane balancing with four runs, the only equipment needed is a vibration transducer type SLD144 or other IEPE (ICP®) type transducers with voltage output.

The transducer is mounted with a magnetic foot (TRX29) or with an M8 (UNC 1/4") screw. It is connected with the spiral cable CAB82 or a straight 10 meter cable CAB83.

For the 2-run methods, a trigger pulse is needed which is either supplied by a proximity switch or by the SPM tachometer probe TTP10.

The laser dot from the tachometer probe is directed towards a piece of reflecting tape pasted on the shaft. The tape must have a sharp edge.

NOTE: It is very important that the tachometer probe is firmly attached and not moved during the balancing procedure. The laser is sensitive to reflections from the shaft, especially during measurement at short distance. Do not direct the tachometer probe straight at the shaft, slightly angle the direction in order to avoid misreadings.

SPM supplies a tachometer probe holder with a magnetic base (SPM 81319) and a clamp for the probe (SPM 14765).



Transducer SLD144 with magnetic foot

TTP10

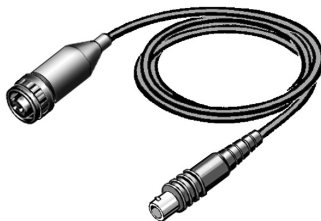

CAB83 (10 m)



CAB82

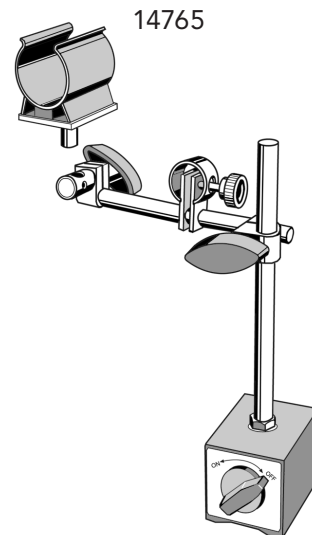

14765

81319

## General settings

To make general settings for the balancing function, press the MENU key and select 'Settings' > 'General settings', then use the F2 key to select the 'Balancing' tab.

Your selection of 'Lagging phase' or 'Leading phase' affects the way the angles are displayed in relation to the direction of rotation while balancing.

Leonova measures 'true phase' from the reference pulse (RPM trigger pulse). When using the 'Lagging phase' convention, the phase angle increase opposite to the direction of rotation. Using the 'Lagging phase' convention is default and is to be considered as industry standard.

When 'Lagging phase' is used, angles are displayed as shown in figure A.

When 'Leading phase' is used, angles are displayed as shown in figure B.

Marking 'Ounce' will show all weights in ounces instead of grams.

'Output unit' is the transducer output, ACC VEL or DISP.

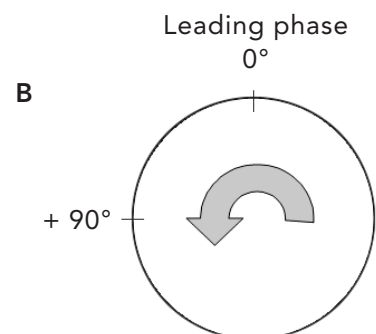
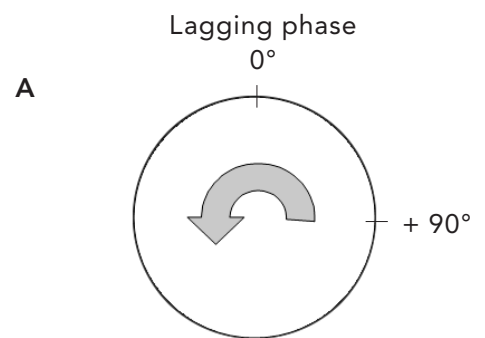
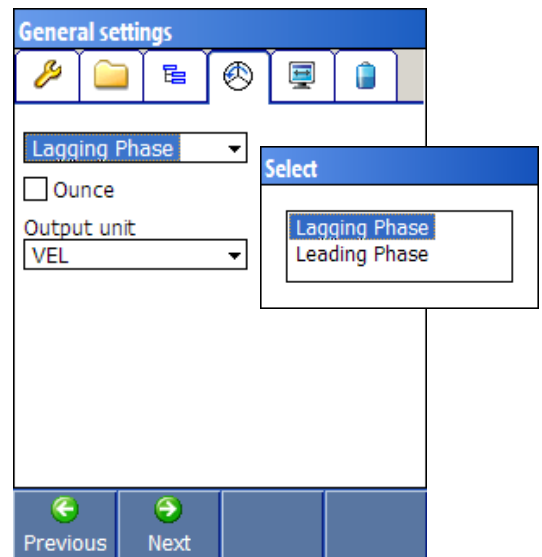

# Default transducer for balancing measurement

The 'Registration of vibration transducers' procedure is described in Part A of this manual. Before starting vibration measurements, make sure that the vibration transducer you are using with your Leonova is properly registered, configured and selected.

To select and edit a transducer, press the MENU key and select 'Settings' > 'Vibration transducers'. Use the arrow keys to mark a transducer on the list (1) and press F2 ('Edit') (2) to open and view its data.

To edit transducer data, mark the setting you want to change and press F2 ('Edit').

The nominal sensitivity of a vibration transducer SLD144 is 10 mV/m/s<sup>2</sup>. The actual sensitivity of the individual transducer is written on its calibration card. This data should always be input in the transducer register (3). When several transducers are in use, they should be marked (e.g. with serial number) to assure that the readings are calibrated.

While in the 'Vibration transducers' menu, press the F4 key ('Default transducers') (4), then select 'Balancing' (5) and press 'ENTER'. Choose which transducer to be used as default transducer for balancing measurements by pressing 'ENTER' to get to the list (6). Use arrow keys to choose from the list and press 'ENTER' when ready. Finish the selection of default transducer by pressing 'BACK' (Leonova automatically updates the choice of default transducer).

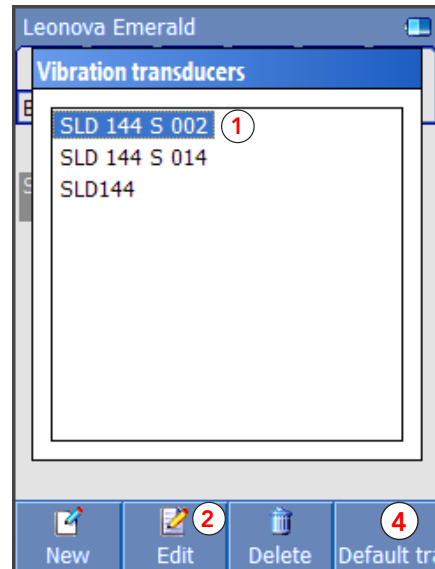

Edit	
Trv: Name	SLD 144 S 002
Trv: Type	ACC
Trv: Sensitivity (mV/m/s <sup>2</sup> ) (3)	9.87
Trv: Max. frequency	10000
Trv: IEPE type	Yes
Trv: Min. bias range (V)	9.0
Trv: Max. bias range (V)	14.0
Trv: Settling time (sec)	3.0

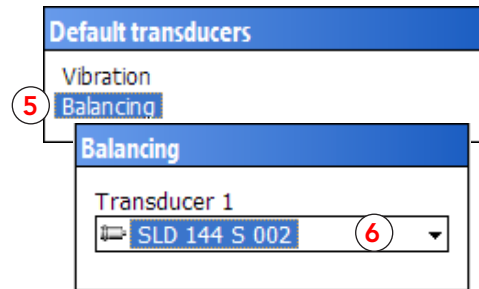

## Transducer line quality, TLQ

Leonova is automatically testing the quality of signal transmission between transducers of type IEPE and instrument before measurement. The unit of measure is voltage (Bias). Accepted values depends on transducer settings. Not acceptable values generates an error message.

## Unbalance

A rotor is unbalanced when the centre of its mass does not co-incide with the shaft centre.

This condition can be described as the rotor having a 'heavy spot' somewhere along its circumference.

If we know the position and weight of this heavy spot, we can reduce it by taking away mass or, more often, put a counterweight on the opposite side of the rotor.

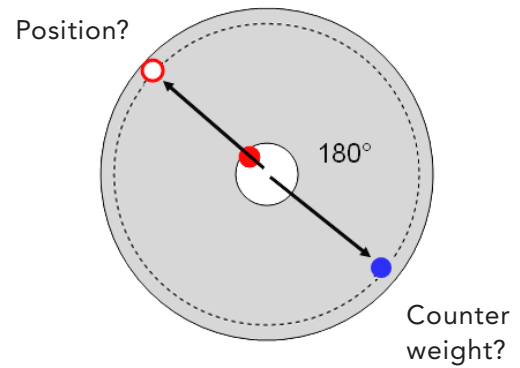

For one plane balancing, it is assumed that the heavy spot is on the centre line of a narrow rotor or near enough, so that it does not matter on which side of the centre line the counter weight is place.

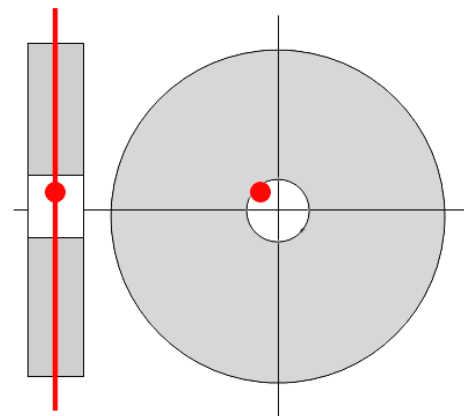

# Measuring unbalance

Unbalance causes excessive vibration. However, excessive vibration can have any number of other causes. Thus, before attempting to balance a rotor, we must first check that there is in fact an unbalance problem and make sure that other vibration causes, such as loose parts and misalignment, are eliminated.

As the 'heavy spot' rotates in the radial plane, the vibration values measured in the horizontal (H) and vertical (V) directions should be higher than the vibration measured in the axial direction (A).

Check all three directions. For balancing, measure in direction H or V, whichever yields the highest value.

Unbalance causes vibration with a frequency of 1X, which is the shaft frequency in Hz ( $\text{rpm}/60$ ), also called the first order.

Check that the vibration spectrum has a clearly dominant line at 1X. This line is marked in the Leonova balancing spectrum.

All balancing methods use a first run to establish the vibration behaviour of the rotor.

The following run is made with a trial weight fastened at a convenient spot along the rotor. Thus, we add a known unbalance factor, which allows us to calculate the position and weight of the unknown 'heavy spot' from the change in vibration behaviour.

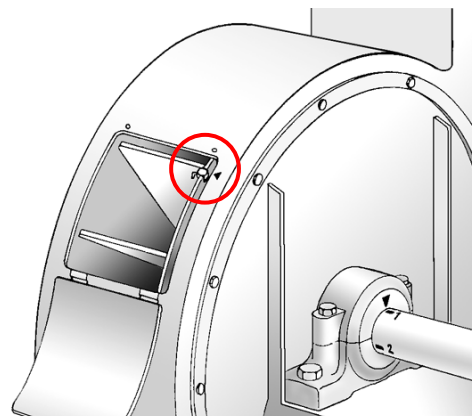
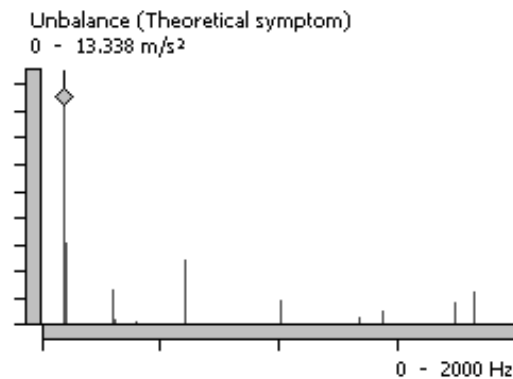
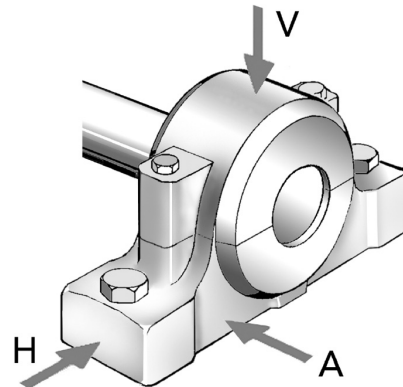

## Four run method

Using four runs, three of them with the same trial weight fixed first at  $0^\circ$ , then at  $120^\circ$  and  $240^\circ$  along the rotor circumference, is the traditional balancing method.

It is important to run the machine at the same speed at all measurements.

Traditionally, the position and weight of the balancing weight were calculated by drawing a graph of the vibration vectors. This part of the work is now done by Leonova: after the last run, the instrument displays the balancing weight in grams (ounces) and its position in degrees (measured from the point where the first trial weight was placed).

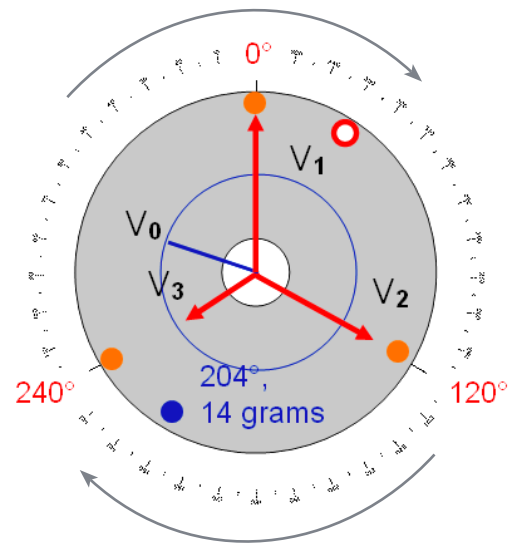

## Two run method

The two run method work with synchronized vibration measurement. This requires a trigger pulse from a tachometer. Each measurement starts in exactly the same shaft position.

The tachometer position becomes part of the reference system needed to calculate the angles between  $0^\circ$  (the position of the trial weight), the position of the 'heavy spot' and the position of the artificial unbalance created by the trial weight.

The tachometer must not be moved between measurements.

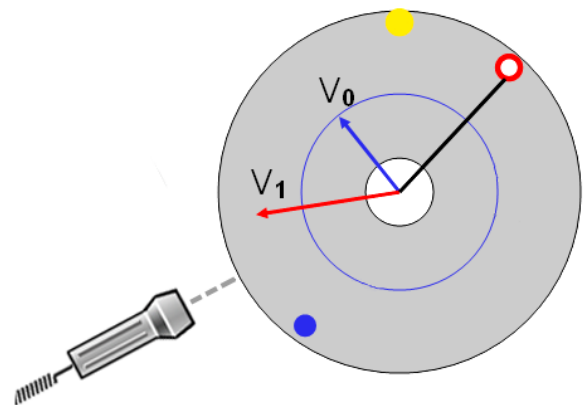
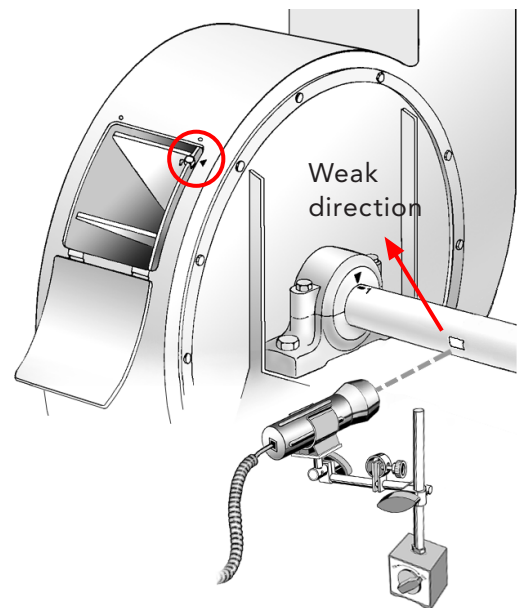

F

## Transducer selection and speed measurement

The balancing procedure is menu guided. Select the method, then simply follow the instructions on the instrument screen.

The first steps are common for all methods. Start with selection of transducer. The transducer selected under 'Transducer register' will be displayed as default.

Follow the setup guide by pressing the F2 function key (Next).

For the '4-run' method, the RPM data are only needed to find the 1X position in the spectrum and thus check on the amount of unbalance. You can do balancing work in three ways (1); without the RPM, input it via the numbers pad (Preset), or measure it.

Select 'Portable' RPM transducer when using the Tachometer probe TTP10 or 'Remote' for transducers of type PNP, NPN or Keyphasor. When Leonova is connected to a stroboscope, the setting is normally set to NPN. Some types of stroboscopes require the setting of '12V Supply'.

RPM can be measured with two methods (2); synchronized (recommended) or asynchronized. 'RPM synchronized' means that each measurement starts in exactly the same shaft position. 'Asynchronized' only require one reading and is a quicker way of measuring RPM.

The '2-run' method is automatically set for synchronous RPM measurements (see previous page), and the setting for RPM uncertainty is not available. You can input the number of synchronized readings (3), recommended are 10-20. If the machine is severely unbalanced you might increase the number of synchronized readings even more.

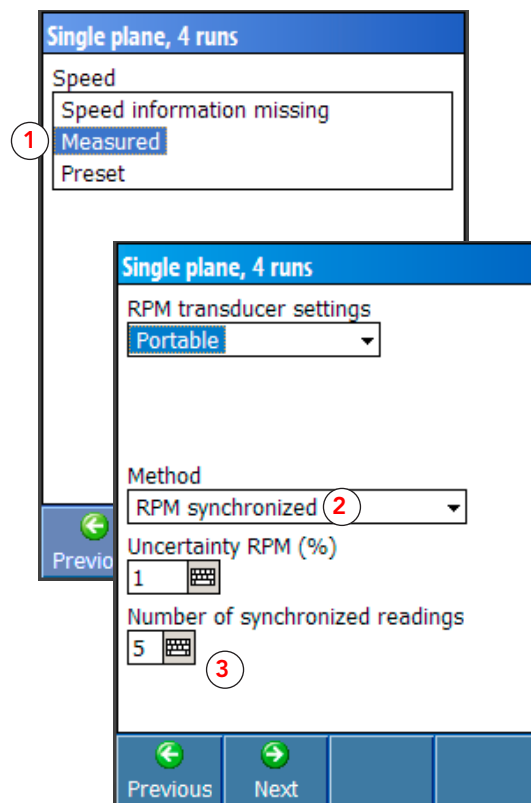
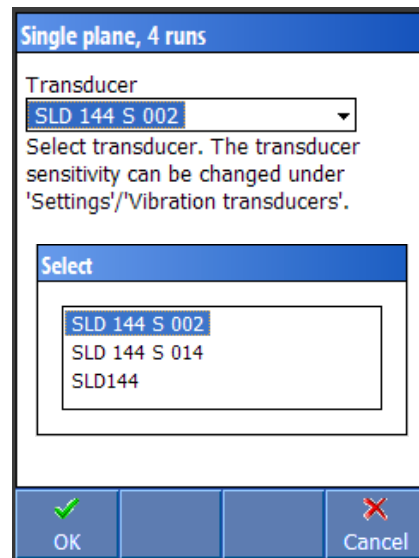



## Run without trial weight

For the '4-run' method, set the frequency range for the spectrum to 'Automatic'. Leonova will calculate the suitable range from the RPM data up to approx. 5x. If the machine is running at low speed < 600 RPM, the frequency range should be set to 500 or 1000 Hz to save time during measuring. Then select a number of lines to display in the spectrum, recommended are 400 lines.

For the '2-run' method, frequency range and number of lines to display in the spectrum are set automatically and cannot be changed.

With the tachometer and the vibration transducer connected, press the MEASURE/SAVE (M/S) key.

Note: If preferred, the display of the rotation direction (clockwise, counterclockwise) can be changed by pressing the MENU key and then choose 'Shift rotation direction'.

Press the F3 function key ('Spectrum') (1) to display the spectrum.

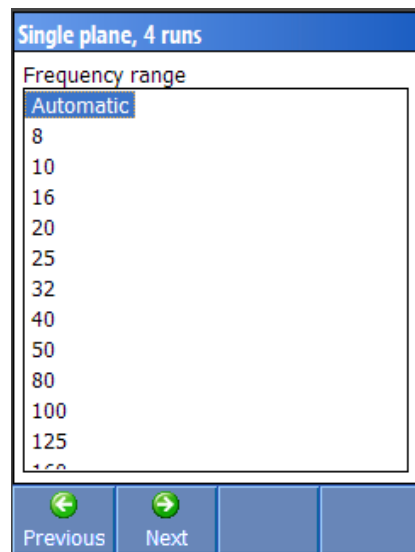

Frequency range settings, 4-run method

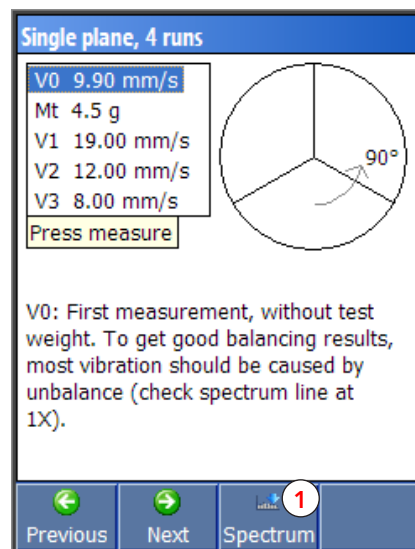

First measure without trial weight, 4-run method

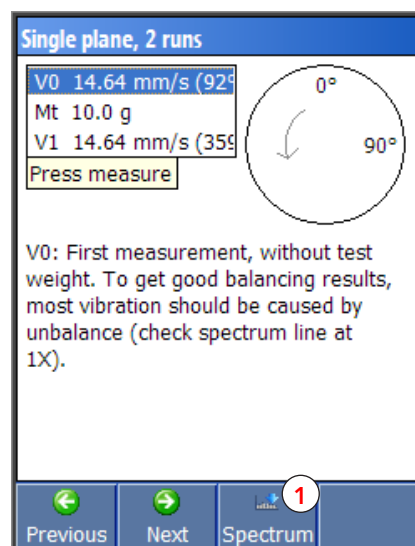

First measure without trial weight, 2-run method



## Run without trial weight (cont.)

To set a cursor (2) on the spectrum line at 1X (which shows the amount of unbalance), press F2 ('Cursor') > F1 ('Cursor A'), then use the LEFT/RIGHT arrow keys to move the cursor to the desired position.

To display machine fault symptoms, press SHIFT + F4 ('Symptom'), then SHIFT + F1 for all symptoms or SHIFT + F2 for theoretical symptoms only.

In case the 1X line is relatively small, abort balancing and first check the machine for other vibration causes (misalignment, loose bolts, etc.).

For all methods, the run without trial weight supplies the value for  $V_0$ , the initial machine vibration.

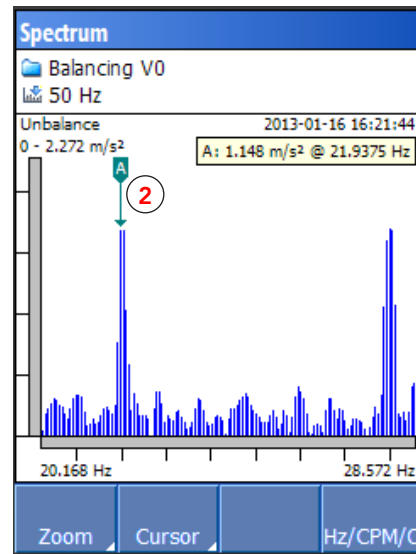

## Trial weight calculation

The trial weight must be large enough to create an unbalance but not so heavy as to create dangerous vibrations.

To edit the test weight, press the F3 function key ('Edit test weight') and use Leonova to calculate a suitable weight (1). The input data are the approximate weight of the rotor and its diameter.

Input the mass of the trial weight with the number pad (2).

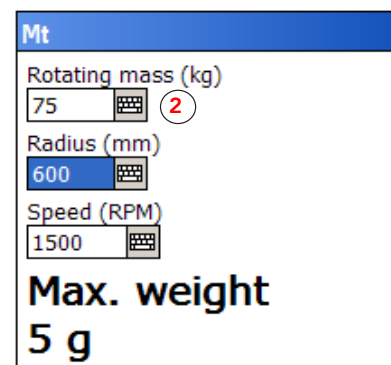
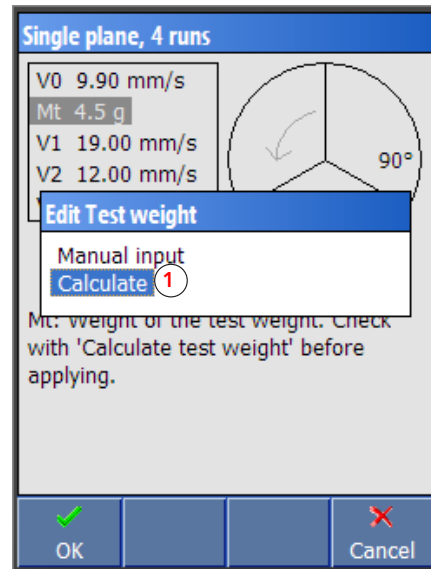

## Run(s) with trial weight

The position where the trial weight is attached automatically becomes the  $0^\circ$  position on the rotor. All angles are given with this point as a reference.

For the 4-run method, you first measure  $V_1$  with the trial weight at  $0^\circ$ , then  $V_2$  with the weight at  $120^\circ$  and finally  $V_3$  with the weight at  $240^\circ$ .

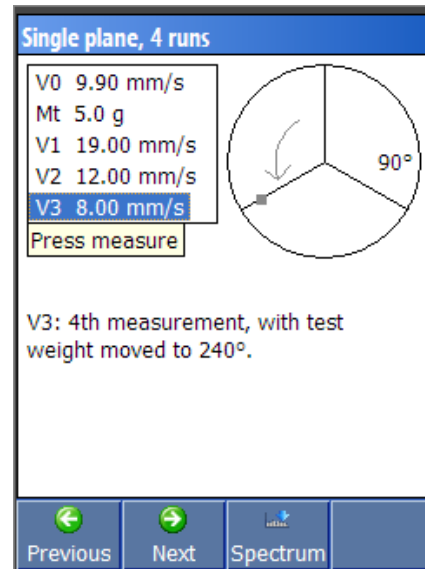

4-run method, menu during third run with trial weight

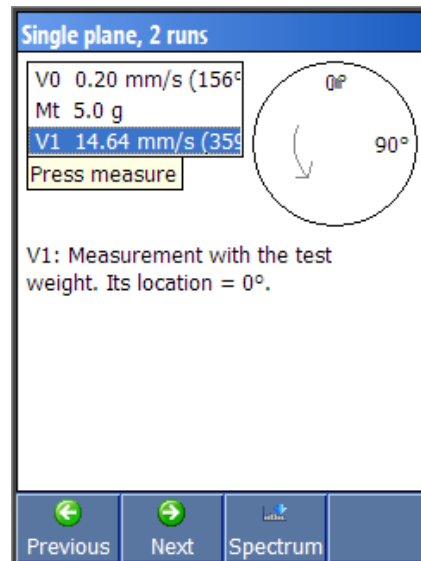

2-run method, menu during run with weight

## Display of results

The calculation results are the mass of the balancing weight and the angle defining the position where it has to be attached.

The display shows the direction of rotation and the position of  $90^\circ$ .

On the side of the display (1) there is a row of function keys that allow you to select alternatives to adding mass at the indicated spot (see next page).

After completion of a balancing operation, the balance quality can be compared to the ISO 1940-1 standard, specifying permissible residual balance for rigid rotors. Press the F4 ('ISO 1940-1') (2) key to open the function. This function is only available for Single plane, 2 runs (RPM is always measured in this method, which is a requirement for the comparison with 'ISO 1940-1').

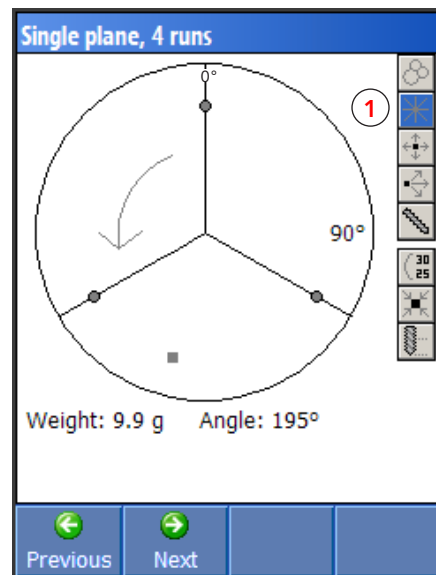

Calculation results, 4-run method

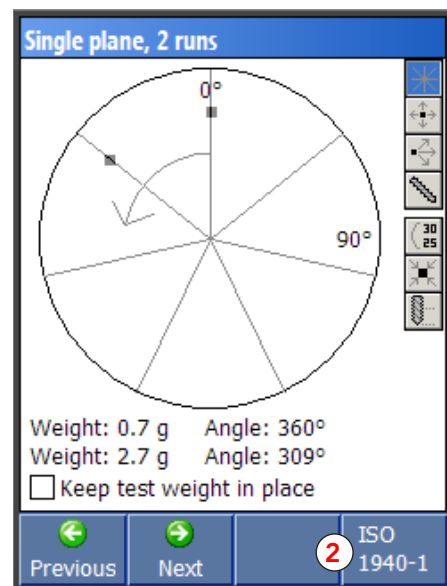

Calculation results, 2-run method

## Alternatives for balancing weights

Leonova calculates a number of alternatives for correcting the unbalance:



Graphical check of calculation results.



Split the correction mass: Input the number of rotor partitions to distribute the correction mass between two of them.



Radial displacement: Input the change in radial distance to recalculate the weight.



Calculate radial position of smaller/larger balancing weight (known weight).



Weight removal: Show drill hole position.



Degrees to length: change from angle to length measured along the rotor circumference.



Sum up weights: Replace all correction masses on the rotor by one.



Weight removal: Drill hole diameter and depth calculated for various materials.

## Trial run and log

After balancing weight application, a trial run can be made to measure vibration after balancing. If balancing was successful, the vibration at 1X should be considerably lower.

The information in the 'Applied balancing weight' window is optional. It will appear in the balancing log file.

In case you used the proposed weight and position, press 'Copy to log' (1) to input the data.

In the 'Verification measurement' window, click 'Measure' to check vibration after balancing.

Single plane, 4 runs

**Applied balancing weight**

Weight (g)	Angle (°)
5.5	195

Copy to log

Information for the log, optional input.

Previous Next

Single plane, 4 runs

**Verification measurement**

2.54 m/s<sup>2</sup>

Measure

'Verification measurement' returns the vibration value (no weight calculation) for the log file.

Previous Spectrum

# Finish the balancing job

To close and save a balancing job, press BACK (1).

The display shows three alternatives (2):

- 'Save changes and close' - after entering a file name (3), this function saves the balancing work in a file which will be stored in the 'File' menu (4), see below.
- 'Save changes' - if you are working in an existing file and have done additional readings on the machine, this alternative will save the result, but not close the file.
- 'Close without saving' closes the function without saving any data.

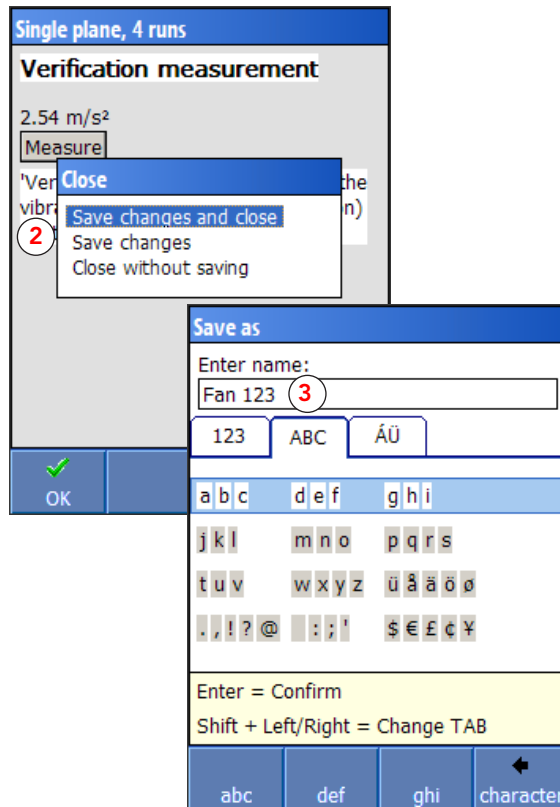
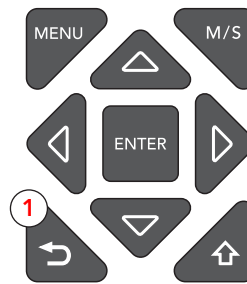

Open an existing file from the 'File' menu by choosing it and press ENTER. The display shows two alternatives (5):

- 'Open existing measurement' makes it possible to edit data in the file. The changes will be stored in the same file.
- 'New verification measurement' opens the file and when a new measurement is done, this will be saved in a new file.

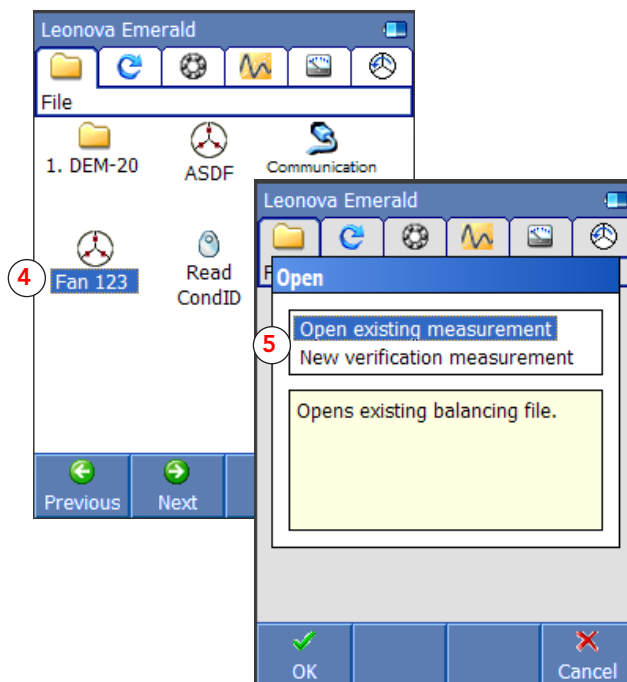

F



## Create report

To print out or save a balancing report, do the following:

- Connect Leonova to the PC.
- Start the Leonova Service Program and select 'Balancing report' (1).
- Select a balancing file saved under the 'FILE' menu and press OK.
- To print out the report, select printer, number of copies, etc under the 'Print out' menu. You can write comments and a header to be added on the report (2).
- To save the report as a document, select Excel file or Word file (3).
- Write your own comments (4) to be printed in the report.

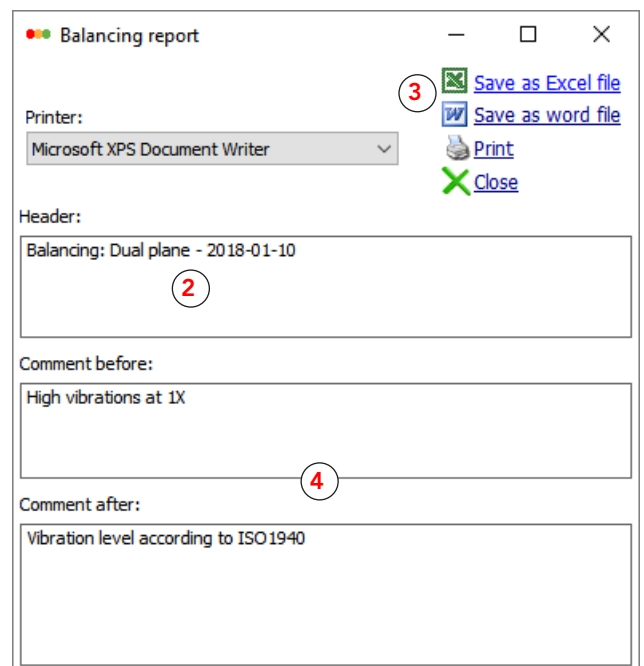
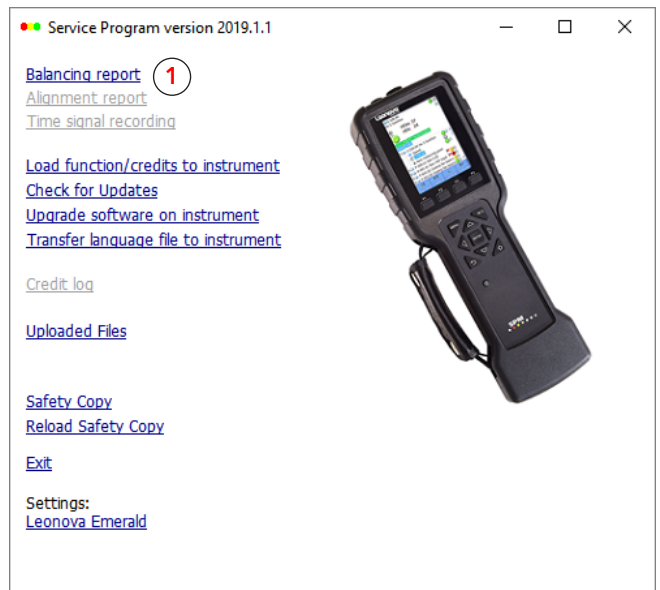

# ISO balancing standard 1940-1

## Determination of permissible residual unbalance

The recommendations are given based on experience concerning the balance quality requirements of rigid rotors, according to type, mass and service speed.

There are three methods used to determine the permissible residual unbalance ( $U_{per}$ ):

- Empirical quality grades derived from long term practical experience from a large number of rigid rotors
- One experimental method often used in mass production balancing
- Method based on specific permissible bearing forces, calculated by defining  $U_{per}$  as a sum of the permissible residual unbalances in the bearing planes.

The result from the measurements (mm/s) will be recalculated into values that can be compared to the graph described in ISO 1940-1.

The balancing result for single plane, 2 runs and the result after applying the balancing weight and the trim weight will be plotted into a graph for the selected balance quality grade (G1, G2.5, G6.3 or G16) (1).

The residual unbalance is depending on the actual rotational weight, the distance of the balancing weight from the centre of rotation and the speed of the application.

The result is described as a value that is independent of speed and the rotational weight  $U_{per} / \text{gr.mm}$ . In the example, the residual unbalance is 321 gr/mm compared with the limit 700 gr/mm valid at 150 kg, rotating at 2000 rpm and the position of the weight at 500 mm from centre of rotation.

The limit is depending on the weight of the rotational mass and the RPM.

The residual unbalance value is depending on the position from the centre of rotation of the balancing weight.

For more detailed information, please see ISO standard 1940-1.

ISO 1940-1

Max RPM  
2000

Rotating mass (kg)  
150

Test weight distance (mm)  
500

Next

ISO 1940-1

Balance quality grade 1

G1 G2.5 G6.3 G16

Grinding-machine drives.  
Small electric armatures with special requirements.

Previous Next

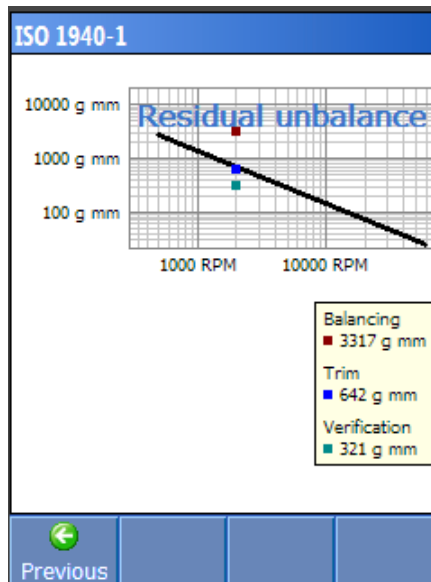

F



