

SSG5000X

Signal Generator

User Manual

UM0805X -E01A

Guaranty and Declaration

Copyright

SIGLENT TECHNOLOGIES CO., LTD All Rights Reserved.

Trademark Information

SIGLENT is the registered trademark of **SIGLENT TECHNOLOGIES CO., LTD**

Declaration

- ◆ **SIGLENT** products are protected by patent law worldwide
- ◆ **SIGLENT** reserves the right to modify or change parts of or all the specifications or pricing policies at company's sole decision.
- ◆ Information in this publication replaces all previously corresponding material.
- ◆ Any way of copying, extracting or translating the contents of this manual is not allowed without the permission of **SIGLENT**.
- ◆ **SIGLENT** will not be responsible for losses caused by either incidental or consequential in connection with the furnishing, use or performance of this manual as well as any information contained.

Product Certification

SIGLENT guarantees this product conforms to the national and industrial standards in

China as well as the ISO9001: 2008 standard and the ISO14001: 2004 standard. Other international standard conformance certification is in progress.

General Safety Summary

Carefully read the following safety precautions to avoid any personal injury or damage to the instrument and any products connected to it. To avoid potential hazards, please use the instrument as specified.

Use Proper AC Power Line

Only the power cord designed for the instrument and authorized by local country should be used.

Ground the Instrument

The instrument is grounded through the protective earth conductor of the power line. To avoid electric shock, please make sure the instrument is grounded correctly before connecting its input or output terminals.

Connect the Probe Correctly.

If a probe is used, do not connect the ground lead to high voltage since it has isobaric electric potential as the ground.

Look Over All Terminals' Ratings

To avoid fire or electric shock, please look over all ratings and sign instruction of the instrument. Before connecting the instrument, please read the manual carefully to gain more information about the ratings.

Use Proper Overvoltage Protection

Make sure that no overvoltage (such as that caused by a thunderstorm) can reach the product, or else the operator might be exposed to danger of electrical shock.

Electrostatic Prevention

Operate the instrument in an electrostatic discharge protective area environment to avoid damages induced by static discharge. Always ground both the internal and external conductors of the cable to release static before connecting.

Maintain Proper Ventilation

Inadequate ventilation may cause increasing of the instrument's temperature, which will eventually damage the instrument. So keep well ventilated and inspect the intake and fan regularly.

Avoid Exposed Circuit or Components

Do not touch exposed contacts or components when the power is on.

Do Not Operate Without Covers

Do not operate the instrument with covers or panels removed.

Use Only the Specified Fuse.**Keep Product Surfaces Clean and Dry.**

To avoid the influence of dust and/or moisture in the air, please keep the surface of the device clean and dry.

Do Not Operate in Wet Conditions.

In order to avoid short circuiting to the interior of the device or electric shock, please do not operate the instrument in a humid environment.

Do Not Operate in an Explosive Atmosphere.

In order to avoid damage to the device or personal injury, it is important to operate the device away from an explosive atmosphere.

Safety Terms and Symbols

Terms used in this manual:

DANGER: Indicates an injury or hazard that may immediately happen.

WARNING: Indicates an injury or hazard that may not immediately happen.

CAUTION: Indicates that a potential damage to the instrument or other property might occur.

Symbols used on the instrument. Symbols may appear on the instrument:



Hazardous

Voltage



Protective

Earth Ground



Warning



Chassis

Ground

SSG5000X Overview

The SIGLENT SSG5000X series is a bench top RF signal source, with an output frequency range from 9 kHz to 6 GHz. It features light weight, small size, and convenient interface make it ideal for R&D, education, production, and maintenance.

Features and Benefits

- ◆ Frequency range from 9 kHz up to 4 GHz/6 GHz
- ◆ 0.001 Hz frequency resolution
- ◆ Level output from -140 dBm to +26 dBm.
- ◆ 0.01 dB level resolution
- ◆ Level accuracy ≤ 0.7 dB(typ.)
- ◆ Phase noise < -120 dBc/Hz @1 GHz, offset 20 kHz(typ.)
- ◆ Standard AM, FM, and PM analog modulation with internal, external and Int+Ext source
- ◆ Pulse modulation, on/off ratio ≥ 0.7 dB (typ.)
- ◆ Pulse train generator(option)
- ◆ USB-power meter measurement
- ◆ Support IQ modulation, output QAM, FSK, ASK, PSK, multitone and other

modulation signals, support data source playback generated by MATLAB

- ◆ Support the playback of protocol files and can generate 5G_NR, LTE, WLAN, WCDMA, GSM, BLUETOOTH and other communication protocol signals
- ◆ Support the generation and playback of waveform sequence
- ◆ Web remote control is supported, which is convenient for users to control devices remotely
- ◆ Equipped with a 5-inch (800x480) with display and a capacitive touch screen for easy and convenient operation.
- ◆ Rich communication interfaces. Standard USB-Host, USB Device (USB-TMC), LAN (VXI-11, Socket, Telnet), optional GPIB

Contents

Guaranty and Declaration	II
General Safety Summary	IV
Safety Terms and Symbols.....	VI
SSG5000X Overview.....	VII
Chapter 1 Quick Start.....	1
1.1 Appearance size	2
1.2 Preparing for Use.....	3
1.2.1 Adjust the Supporting Legs.....	3
1.2.2 Connect to AC Power Supply.....	3
1.3 The Front Panel	4
1.3.1 Front Panel Function Keys	5
1.3.2 Front Panel Key Backlight	6
1.3.3 Digital keyboard	7
1.3.4 Front Panel Connectors	9
1.4 Rear Panel.....	10
1.5 User interface.....	16
1.6 Touch operation	19
1.7 Parameter setting	20
1.8 Help information	21
Chapter 2 Front Panel Operation.....	22
2.1 Frequency Setting	23

2.1.1	RF output Frequency.....	23
2.1.2	Freq Offset	24
2.1.3	Phase Offset.....	26
2.2	Level Setting	28
2.2.1	Level setting.....	29
2.2.2	Level Offset	30
2.2.3	ALC State	31
2.2.4	Flatness	33
2.3	Sweep Setting.....	37
2.3.1	Sweep State	37
2.3.2	Step Sweep	38
2.3.3	List sweep	39
2.3.4	Direction	40
2.3.5	Sweep Mode.....	41
2.3.6	Trigger Mode	41
2.3.7	Point Trigger.....	43
2.3.8	Trigger Slope.....	44
2.4	Analog Modulation	46
2.4.1	Amplitude Modulation (AM).....	46
2.4.2	Frequency Modulation (FM).....	49
2.4.3	Phase Modulation (PM).....	53
2.4.4	Pulse Modulation (PULSE)	57

2.5	LF Setting	69
2.5.1	LF Source	69
2.5.2	LF Sweep.....	70
2.6	Utility.....	74
2.6.1	System.....	74
2.6.2	Store/Recall.....	85
2.7	Power Sensor	88
2.7.1	Power meter setting.....	88
2.7.2	Level Control	93
2.8	I/Q Modulation	96
2.8.1	Custom.....	96
2.8.2	Multitone	103
2.8.3	ARB.....	105
2.8.4	AWGN.....	143
2.8.5	I/Q Control	143
2.9	Shortcut Keys.....	148
2.9.1	PRESET.....	148
2.9.2	Home	156
2.9.3	Trigger.....	156
2.9.4	ESC/Close	156
2.9.5	MOD ON/OFF.....	157
2.9.6	RF ON/OFF	157

Chapter 3	Application Examples	158
3.1	Output RF signal	158
3.2	Correcting Line Loss.....	159
3.3	Output a modulated signal.....	160
3.4	Output a pulse train.....	162
3.5	Output IQ modulated signal in Custom Mode.....	164
3.6	Test OIP3 of Active Devices in Multitone Mode	167
3.7	Play waveform sequence Using ARB Mode.....	169
3.8	Add AWGN to Modulated Signal Using ARB Mode	171
Chapter 4	Programming Overview.....	174
4.1	Remote Operation.....	174
4.1.1	Connecting via the USB Device port.....	174
4.1.2	Connecting via the LAN port	175
4.1.3	GPIB: Connecting via the USB-Host port.....	176
4.2	Build Communications	178
4.2.1	Build Communications Using VISA.....	178
4.2.2	Build Communications Using Sockets/Telnet	180
4.3	Remote Control Capabilities.....	182
4.3.1	User-defined Programming	182
4.3.2	Send SCPI Commands via NI MAX.....	182
4.3.1	Web Control	186
Chapter 5	Service and Support	187

5.1	General Inspection	187
5.2	Troubleshooting	188
Chapter 6	Service and Support	193
6.1	Service Summary	193
6.2	Contact Us	194

Chapter 1 Quick Start

Subjects in this chapter:

- ◆ Appearance size
- ◆ Preparing for Use
- ◆ The Front Panel
- ◆ Rear Panel
- ◆ User interface
- ◆ Touch operation
- ◆ Parameter setting
- ◆ Help information

1.1 Appearance size

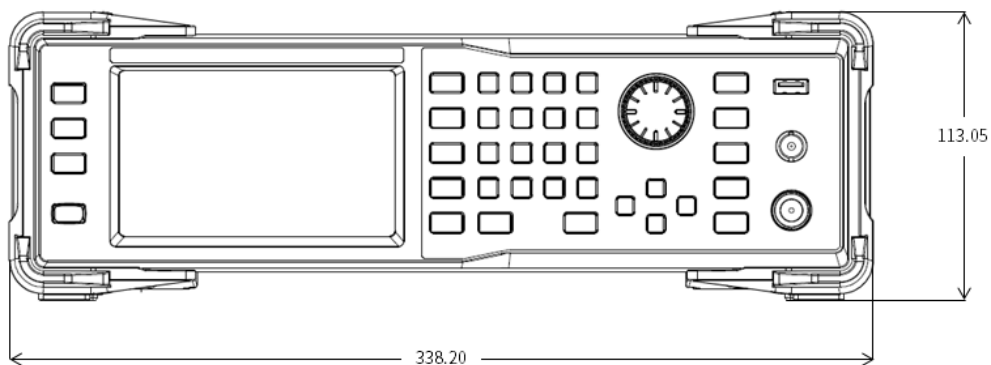

Figure 1-1 Front View

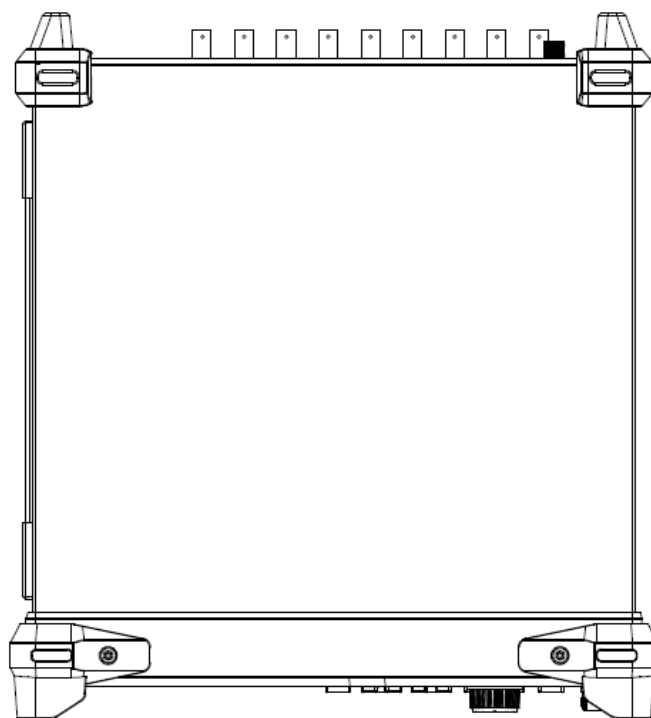

Figure 1-2 Top View

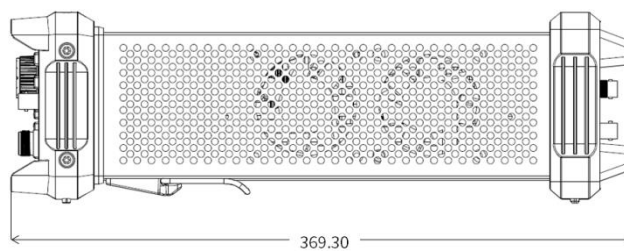

Figure 1-3 Side View

1.2 Preparing for Use

1.2.1 Adjust the Supporting Legs

For benchtop operation, you may want to use the supporting legs. Adjust the supporting feet appropriately to tilt the RF signal source upwards.

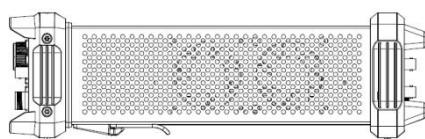

Figure 1-4 before adjusting

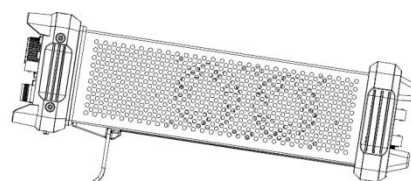

Figure 1-5 after adjusting

1.2.2 Connect to AC Power Supply

The RF signal source accepts 100-240V, 50/60/440Hz AC power supply. Please use the power cord provided to connect the instrument to the power source as shown in the figure below.

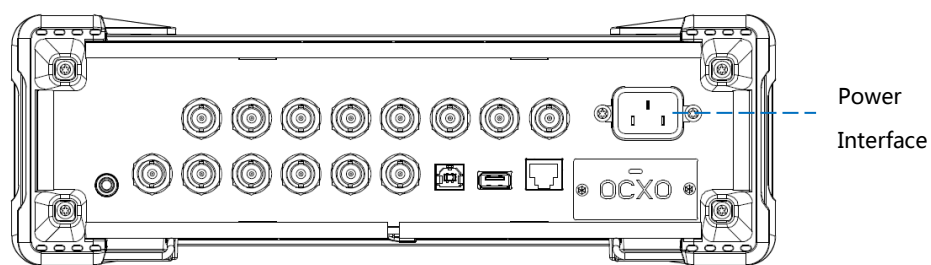

Figure 1-6 Power Interface

1.3 The Front Panel

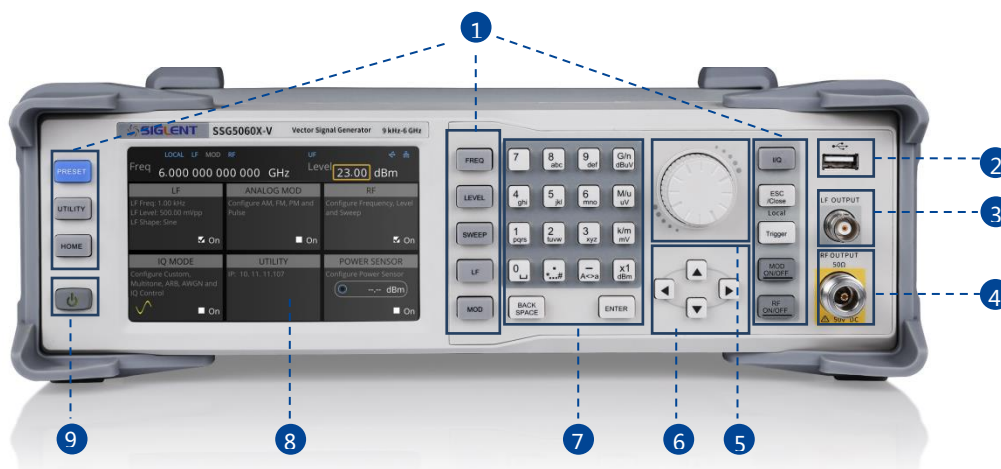

Figure 1-7 the Front Panel

Table 1-1 Front Panel Description

NO.	Description	NO.	Description
1	Function key	2	USB Host
3	LF output	4	RF output
5	Knob	6	Direction key
7	Digital keyboard	8	Touch screen display area
9	Power button		

1.3.1 Front Panel Function Keys

Table 1-2 Function keys description

Control Keys	Description
FREQ	Set frequency, frequency offset, phase offset and other related parameters.
LEVEL	Set level, level offset, ALC state, flatness and other parameters, power sensor display and control functions.
SWEEP	Set sweep state, step sweep, list sweep, direction and other related parameters.
LF	Set LF state, LF level, LF frequency and other related parameters.
MOD	Set various modulation parameters (AM, FM, PM and PULSE).
I/Q	Set IQ related parameters.
ESC/Close	<p>During the parameter editing process, pressing this key will clear the input of the active function area and exit the parameter input state.</p> <p>Press this button to return to local control of previously operating the instrument remotely.</p>
Trigger	When the trigger type is set to Key, press this button to perform one operation.
MOD	The main switch of various modulation modes.

ON/OFF	
RF ON/OFF	RF signal output switch
PRESET	Press this button to revert to the default parameter. The default parameters refer to the default parameter table.
UTILITY	System and file related operations
HOME	You can get back to the main interface quickly

1.3.2 Front Panel Key Backlight

The on/off state and the color of the backlights of some keys at the front panel

indicate the working state of the SSG. The states are as listed below.

1. Power Switch 

Orange light constantly on indicates the unit is in stand-by state.

Green light constantly on indicates the instrument is in the normal operated state.

2. MOD ON/OFF

When the MOD ON/OFF is set to turn on the modulation, the light will turn on, turn off the modulation, and the lights will turn off.

3. RF ON/OFF

When the RF signal is turned on, the back light is on, and the radio signal is turned off.

1.3.3 Digital keyboard

The front panel of the RF signal source provides a numeric keypad (as shown below). The keyboard supports English uppercase and lowercase characters, numbers, and common symbols (including decimal points, blanks, spaces, and + /), mainly for editing the name of files or folders and setting parameters (refer to the "parameter setting" section).



Figure 1-8 Digital keyboard

1. 

Digit 0 and space bar switch.

2. 

In the English state, enter the special symbol (!, @, #, \$, %, ^, &, *). In the digital state, enter the decimal point.

3. 

In the digital state, enter the "-" number, in the English state input for case switching.

4. 

When setting the amplitude, press this key to set the units as dBuV. When setting the frequency, press this key to set the units as GHz, if the input is a time-related parameter, press this key to set the unit as ns.

5. 

When setting the amplitude, press this key to set the units as uV. When setting the frequency, press this key to set the units as MHz, if the input is a time-related parameter, press this key to set the unit as us.

6. 

When setting the amplitude, press this key to set the units as mV. When setting the frequency, press this key to set kHz. If the input is a time-related parameter, press this key to set the units as ms.

7. 

When setting the amplitude, press this key to set the units as dBm, when setting the frequency, the unit is Hz, if the input is a time correlation parameter, press this key to set the units as s.

8. 

During the parameter editing process, pressing this key will clear the input of the active function area and exit the parameter input state.

9. 

In the parameter input process, pressing this key will end the parameter input and

add the currently set units for the parameter.

1.3.4 Front Panel Connectors

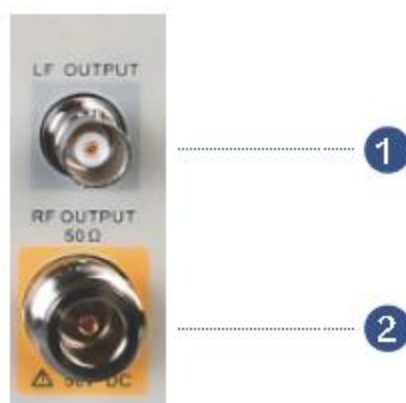

Figure 1-9 front panel connectors

1. LF (low frequency) output

Output the low frequency signal. This is a BNC connection. The output can also be configured to source the modulation waveform for FM and PM modulation types.

2. RF(Radio frequency) output terminal

RF signal output N-type connector with an impedance of 50 ohms.

1.4 Rear Panel

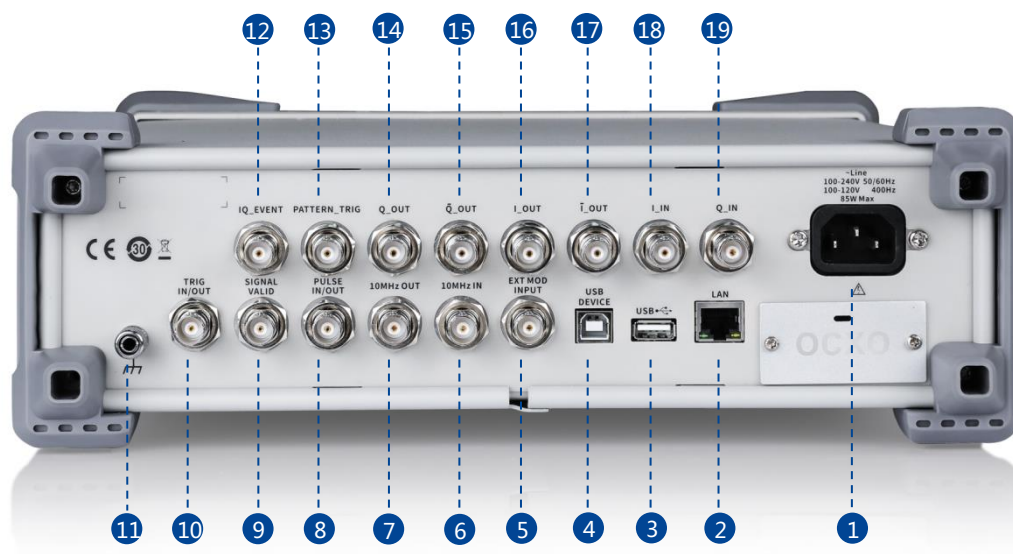

Figure 1-10 Rear Panel

1. AC power input terminal

The RF signal source can operate with AC power from specifications of the AC power supply supported by RF signal source are 100 V - 240 V at 45 Hz - 440 Hz.

Please connect the RF signal source to the AC power supply with the supplied power cord.

2. LAN interface

Used to link the RF signal source to the computer or computer network, the SSG5000X is VXI-11 compliant, supports remote commands based on Socket and

Telnet, and uses WEB for remote control. It can quickly build test systems with other standard equipment.

3. USB host

The RF signal source can be used as the "main device" to connect to the external USB device. The interface reads the trace or state file from the U disk, or stores the current instrument state or trace to the U disk, and can also save the content displayed on the current screen in .BMP format to the U disk.

4. USB Device interface

The interface can be connected to a compatible computer and controlled by software on the host computer

5. EXT MOD INPUT

Input BNC connection for an external modulation.

6. 10MHz IN

The [10MHz IN] and [10MHz OUT] connectors are commonly used to establish synchronization between multiple instruments. The RF source can use an internal reference source or an external reference source.

If the instrument detects that there is a valid 10MHz IN signal at the 10MHz In connector, it will use it as an external reference source. At this point the user interface status bar shows "Ext Ref". When an external reference is lost, exceeded, or disconnected, the instrument automatically switches to the internal reference, and the screen status bar will no longer display "Ext Ref".

7. 10MHz OUT

The [10MHz IN] and [10MHz OUT] connectors are commonly used to establish synchronization between multiple instruments. The RF source can use an internal reference source or an external reference source.

If the instrument uses an internal reference source, the [10MHz OUT] connector can output a 10MHz clock signal generated by the instrument and can be used to synchronize other devices.

8. PULSE IN/OUT

The function of the connector is determined by the current mode of pulse modulation.

1) PULSE IN:

When the pulse source is "Ext", it is used to input external pulse signals.

2) PULSE OUT:

When the Pulse modulation source is "Int" and the pulse output switch is turned on, it is used to output the pulse signal generated by the internal generator. The output signal is related to "Pulse Mode", and can be set to "Single", "Double" or "Train".

9. SIGNAL VALID

When the RF output frequency or amplitude is modified, the RF output connector of the front panel outputs the RF signal at the specified frequency and amplitude after a certain response and processing time in the internal circuit of the instrument. In this process, the **[SIGNAL VALID]** connector outputs an impulse synchronization signal to indicate the validity of the RF output signal:

- High level (3.3 V): Indicates that the RF signal is being configured;
- Low level (0 V): Indicates that the RF signal is stable (effective).

10. TRIG IN/OUT

When PULSE trigger mode is "Int ", the connector can be used to output the trigger signal.

When the RF Sweep, LF Sweep, or PULSE trigger mode is "Ext", the connector is used to input the external trigger signal.

11. Ground

System ground terminal.

12. IQ_EVENT

Output on this connector occurs whenever Marker is on in an Arb-based waveform.

Marker level \approx 3.3 V (positive polarity selected),

Marker level = 0 V (negative polarity selected).

13. PATTERN_TRIG

When the IQ Arb trigger source is "Ext", the connector is used to input the external trigger signal.

14. Q_OUT

Output the analog, in-phase component of I/Q modulation from the internal baseband generator when the internal IQ modulation mode is on.

15. \bar{Q} _OUT

Used in conjunction with the Q_OUT connector to provide a balanced baseband stimulus.

16. I_OUT

Output the analog, quadrature-phase component of I/Q modulation from the internal baseband generator when the internal IQ modulation mode is on.

17. \bar{I} _OUT

Used in conjunction with the I_OUT connector to provide a balanced baseband stimulus.

18. I INPUT

Used to input an external modulated I baseband signal when the external IQ modulation mode is on.

19. Q INPUT

Use to input an external modulated Q baseband signal when the external IQ modulation mode is on.

Note: [I INPUT] and [Q INPUT] connectors are only available on models equipped with IQ modulation.

1.5 User interface

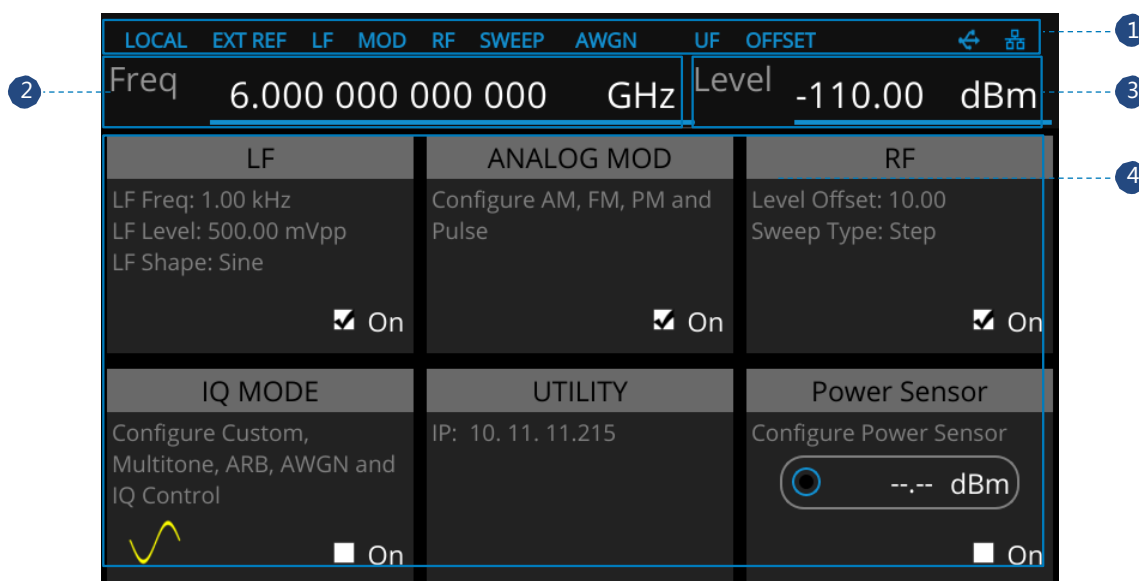





Figure 1-11 User Interface

1. Prompt status bar

- Display LOCAL (local) or REMOTE (remote). When REMOTE is displayed, the instrument is being controlled by a remote computer and the front panel input will be locked. To unlock the front panel (enter LOCAL mode), press Esc/Close to quit.
- EXT REF: EXT REF shows that the SSG is using an external 10 MHz reference.
- LF: Low frequency signal generator state.
- MOD: The modulation state mode is turned off, the blue is turned on, and the gray is closed.
- RF: The RF output state.

-
- SWEEP: The status of the sweep state.
 - AWGN: The status of the Additive White Gaussian Noise (AWGN) to a carrier when IQ Modulation.
 - UF: Amplitude flatness function enabled.
 - OFFSET: Amplitude offset enable.
 - : The identification is displayed when a USB disk is inserted
 - LAN: LAN state.  indicates that LAN is successfully connected.  indicates that there is no network connection or network connection failed

2. RF frequency

RF output frequency setting. When the scan type is "frequency" or "frequency & amplitude", the frequency scanning progress bar is displayed.

3. RF level

RF output level setting. When the scan type is "amplitude" or "frequency & amplitude", the level scanning progress bar is displayed.

4. Touch screen display area: Display the settings under each menu

- LF: LF output state and LF waveform displayed. Sine, Square, Sawtooth, Triangle and DC can be set up.
- ANALOG MOD: Modulation state. Amplitude modulation, frequency

modulation, phase modulation, or pulse can be set.

- RF: RF output state. Frequency, level or RF Sweep can be set.
- I/Q MOD: I/Q output state. IQ modulation can be set.
- UTILITY: System and file related parameters can be set.
- Power Sensor: Display the current reading of the power sensor after accessing the power sensor.

1.6 Touch operation

The RF signal source provides a 5 inch capacitive touch screen to support various gesture operations. Including:

- ◆ Click on the screen parameters or menu to edit the parameters.
- ◆ Left or right slide switches menus.
- ◆ Up and down slides the display menu

Note: Only when you click on the screen, the scrollbar appears on the right to slide down the menu. If there is no scrollbar, it means that only the current page exists.

1.7 Parameter setting

Parameter input can be performed through touch screen, keypad and digital keys, knob or direction keys. This section introduces an example of three parameter setting methods by setting the center frequency to 100 MHz.

1. Using the digital keyboard

- 1) Press **FREQ**;
- 2) Use the numeric key to input the value "100";
- 3) Then press  to select unit MHz;

2. Using the touch screen

- 1) Click the **Freq** input box on the screen to display the keypad.
- 2) Enter 100 on the keypad, then select unit MHz on the keypad.

3. Using the knob and the direction key

- 1) Bring the Focus Cursor on the **Freq** input box by using the knob.
- 2) Press the knob and adjust the left and right arrow keys to select the digit you wish to adjust.
- 3) Then turn the knob or press the up and down arrow keys to change the parameters until the desired value is obtained.

1.8 Help information

The built-in help system of RF signal source provides help information for each function and menu option on the front panel.

- ◆ Press **UTILITY** button and select help. The center of the screen will pop up to help.
- ◆ Click to enter the corresponding directory.

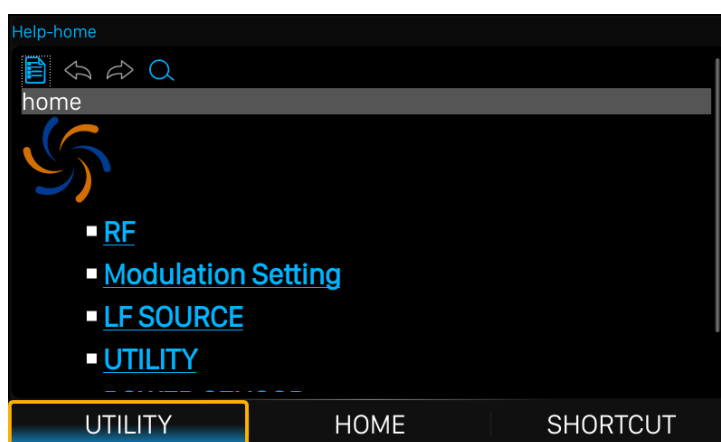

Figure 1-12 help information

Chapter 2 Front Panel Operation

This chapter describes in detail the function keys at the front panel and the associated functions.

Subjects in this chapter:

- ◆ Frequency Setting
- ◆ Level Setting
- ◆ Sweep Setting
- ◆ Analog Modulation
- ◆ LF Setting
- ◆ Utility
- ◆ Power Sensor
- ◆ I/Q Modulation
- ◆ Shortcut Keys

2.1 Frequency Setting

The value of the RF frequency is displayed in the header of the display ("Freq").

This field provides the direct input of the RF frequency. Alternatively, you can enter the RF frequency in the "Freq" dialog.

Note that the displayed RF frequency in the header and the RF output frequency, entered in the "FREQ" dialog can be different, as explained in the following section.

If you working with a downstream instrument, e.g. a mixer, you can enter related parameter value in the frequency settings dialog ("Offset").

The correlation between the RF frequency, the RF output frequency and the frequency offset is as follows:

"FREQ" (in header) = "RF output frequency" (frequency in dialog) + "Freq offset" (offset in dialog)

2.1.1 RF output Frequency

Setting the RF output frequency

1. Keypad operation

Press **FREQ**->**Frequency** to make the focus fall on this parameter item.

- Use the numeric keypad to input the desired value and press the unit button to select the desired unit. Optional units are GHz, MHz, kHz, and Hz. Press **ENTER** to select the current unit.
- Press **ENTER** or press the knob to enter the parameter editing state, and then use the left and right direction keys to move the cursor to the desired position. Press the up and down direction keys, rotate the knob or press the numeric keypad to modify the value. Press **ENTER**, knob or **ESC** to exit the editing mode.

2. Touch screen operation

Click on **SHORTCUT**->**FREQ**->**Frequency** to enter the interface of RF output frequency setting.

- Click the frequency parameter, then pop up the keypad interface, then click the number symbol in the keypad to change the value. Click the unit to modify the unit. Click the tick to confirm the modified value and selected unit.
- Long press edit box to enter the edit mode. Press the up and down direction keys, rotate the knob or press the numeric keypad to modify the value, and press the **ENTER** key, knob or **ESC** key to exit the edit mode.

Note: The maximum RF output frequency is 6 GHz, and 9 kHz is the minimum.

2.1.2 Freq Offset

This setting the displayed frequency offset from the RF output signal.

This can be useful if the circuit or device shifts or alters the output frequency .such as an external mixer, by setting an offset; you can read the mixer signal's frequency directly on the RF generator front panel.

1. Keypad operation

Press **FREQ**->**Freq Offset** to make the focus fall on this parameter item.

- Use the numeric keypad to input the desired value and press the unit button to select the desired unit. Optional units are GHz, MHz, kHz, and Hz. Press **ENTER** to select the current unit.
- Press **ENTER** or press the knob to enter the parameter editing state, and then use the left and right direction keys to move the cursor to the desired position. Press the up and down direction keys, rotate the knob or press the numeric keypad to modify the value. Press **ENTER**, knob or **ESC** to exit the editing mode.

2. Touch screen operation

Click **SHORTCUT**->**FREQ**-> **Freq Offset** to enter the interface of frequency offset setting.

- Click the frequency offset parameter, and then pop up the keypad interface, then click the number symbol in the keypad to change the value. Click the unit to modify the unit. Click the check mark to confirm the modified value and selected unit.

- Long press the edit box to enter the edit mode. Press the up and down direction keys, rotate the knob or press the numeric keypad to modify the value, and press the **ENTER** key, knob or **ESC** key to exit the edit mode.

Note:

- The relationship between the RF output frequency, the display frequency and frequency offset is:

$$\text{Display frequency} = \text{RF output Frequency} + \text{Frequency offset}$$

- The difference value between the display frequency and the frequency offset is the actual RF output frequency, which must not exceed the instrument frequency output range.

2.1.3 Phase Offset

Setting the phase offset from the RF signal

Application: When multiple RF sources are outputting RF signals at the same time, multiple signals can be output to the same phase or a fixed phase offset by adjusting this parameter.

Also you should set the devices the same frequency and synchronous them.

1. Keypad operation

Press **FREQ** -> **Phase Offset** to make the focus fall on this parameter item.

- Use the numeric keypad to input the desired value and press the unit button to

select the desired unit. Press **ENTER** to select the current unit.

- Press **ENTER** or press the knob to enter the parameter editing state, and then use the left and right direction keys to move the cursor to the desired position. Press the up and down direction keys, rotate the knob or press the numeric keypad to modify the value. Press **ENTER**, knob or **ESC** to exit the editing mode.

2. Touch screen operation

Click on **SHORTCUT->FREQ->Phase Offset** to enter the interface of phase offset setting.

- Click the phase offset parameter, then pop up the keypad interface, then click the number symbol in the keypad to change the value. Click the unit to modify the unit. Click the check mark to confirm the modified value and selected unit.
- Long press the edit box to enter the edit mode. Press the up and down direction keys, rotate the knob or press the numeric keypad to modify the value, and press the **ENTER** key, knob or **ESC** key to exit the edit mode.

Click on **SHORTCUT->FREQ->Reset phase delta display** to reset the display phase offset to 0 deg.

2.2 Level Setting

The value of the RF level is displayed in the level text field located in the header of the display (labeled “Level”).This field provides the direct input of the RF level value .Alternatively, you can enter the level in the level dialog.

Note that the displayed RF level in the header, and the RF output level, set in the “Level” dialog can be different, as explained in the following section.

If you working with a downstream instrument, e.g. an attenuator or amplifier, you can enter the level offset value in the settings dialog (labeled “Level Offset”).

The generator includes these parameters and displays the result in the “Level” field in the status bar, as if the downstream source and the generator were one unit. This displayed level value corresponds to the value at the RF output of the instrument and any downstream sources. . However, the level provided at the RF output of the signal generator corresponds to the level value set in the “Level Setting” dialog.

When a level offset is enabled, the instrument display changes the color of “OFFSET” from grey to blue.

Level (in header) = RF output level (level in the Level menu) + Level offset (Offset in Level menu)

2.2.1 Level setting

Setting the RF signal level

1. Keypad operation:

Press the **LEVEL** -> **Level** to make the focus fall on this parameter item

- Use the numeric keypad to input the desired value and press the unit button to select the desired unit. Optional units are dBm, dBuV, uV, mV, V, nW, uW, mW and W. Press **ENTER** to select the current unit by default.
- Press **ENTER** or press the knob to enter the parameter editing state, and then use the left and right direction keys to move the cursor to the desired position. Press the up and down direction keys, rotate the knob or press the numeric keypad to modify the value. Press **ENTER**, knob or **ESC** to exit the editing mode.

2. Touch screen operation

Click on **SHORTCUT** -> **LEVEL** -> **Level** to enter the interface of RF output level setting.

- Click the level parameter, then pop up the keypad interface, then click the number symbol in the keypad to change the value. Click the unit to modify the unit. Click the check mark to confirm the modified value and selected unit.

- Long press edit box to enter the edit mode. Press the up and down direction keys, rotate the knob or press the numeric keypad to modify the value, and press the **ENTER** key, knob or **ESC** key to exit the edit mode.

2.2.2 Level Offset

Setting the level offset from the RF signal's level

Application: When connecting a fixed attenuation or gain, the level value after attenuation or amplification can be directly read and set on the RF source by setting a level offset.

When level offset is not zero, the status bar will display OFFSET in blue.

1. Keypad operation

Press **LEVEL**-> **Level Offset** to make the focus fall on this parameter item.

- Use the numeric keypad to input the desired value. Press **ENTER** or click the check mark to confirm.
- Press **ENTER** or press the knob to enter the parameter editing state, and then use the left and right direction keys to move the cursor to the desired position. Press the up and down direction keys, rotate the knob or press the numeric keypad to modify the value. Press **ENTER**, knob or **ESC** to exit the editing mode.

2. Touch operation

Click on **SHORTCUT**->**LEVEL**->**Level Offset** to enter the interface of level offset setting.

- Click the level parameter, then pop up the keypad interface, then click the number symbol in the keypad to change the value. Click the check mark to confirm the modified value.
- Long press edit box to enter the edit mode. Press the up and down direction keys, rotate the knob or press the numeric keypad to modify the value, and press the **ENTER** key, knob or **ESC** key to exit the edit mode.

Note:

- The difference value between the display level and the level offset is the actual RF output level, which must not exceed the instrument level output range.

2.2.3 ALC State

Setting the ALC's working state

ALC is Automatic Level Control .It is an adaptive control system to stabilize the RF output level.

It continuously monitors the current level and adjusts it to keep a steady state over

temperature and time.

1. Keypad operation

Press **LEVEL**-> **ALC State** to expand the drop-down box, then rotate the knob or press the up and down direction keys to select ALC state.

2. Touch operation

Click on **SHORTCUT**->**LEVEL**->**ALC state** to select ALC state.

ALC has three functions: "Off", "On" and "Auto" :

- **AUTO**

Automatically turn on or off the ALC function according to the equipment state.

- **On**

Enable ALC permanently, regardless of the currently selected mode.

- **ALC Off (S&H)**

Deactivate ALC. The instrument switches to Sample & Hold (S&H) state, which still allows maintaining a constant output level .In "S&H" mode, the signal generator switches for a short period of time into CW mode and activates ALC. The ALC adjusts the level to the set value and the generator holds the value .Then, the generator switches ALC off again and back to the previous operating mode.

2.2.4 Flatness

The "Flatness" function adjusts the amplitude at specific frequencies by mathematically adjusting the output by applying user-defined level correction lists. Correction is performed by the user-defined table values being added to the output level for the respective RF frequency. With frequencies which are not contained in the list, the level correction is determined by interpolation of the closest correction values. If there is only one point, it will not perform correction.

The flatness correction function can adjust the RF output amplitude corresponding to the frequency point within the frequency range of the instrument to compensate for losses in the cable, or losses caused by other equipment.

1. Flatness Menu

- Keypad operation

Press **LEVEL**->**Flatness** to make the focus fall on the flatness menu, then press the knob or **ENTER** key to switch flatness status. When opened, the status bar displays the blue UF letters.

- Touch operation

Click on **SHORTCUT**->**LEVEL** ->**Flatness** to make the focus fall on flatness switch.

Then click on the switch button to switch the flatness status.

Note: Flatness correct is enabled when the indicator shows the blue colored "I" and the status bar will display blue "UF" . When disabled, the Flatness indicator will display a grey "0" .

2. Flatness settings

Press **LEVEL** -> **Flatness**, and then click the gear icon to enter the flatness list edit page.

Table 2-1 Flatness correction list

ROW	Frequency	correction (dB)
1		
2		

1) Insert

Press  to insert a new row after the last row.

2) Delete

Press  to delete the selected row.

3) Empty

Press  to empty any number of rows.

4) Load

Press  to enter the file save/call page, select and load existing flatness correction files, see "file management" for details.

5) Save

Press  to enter the file save/call page, save the correction data in the list, see "file management" for details.

6) Return

Press  return to the previous menu.

7) Set

Press  to enter the set of flatness list filling.

After entered into the set of flatness list filling, you can choose one of the following three methods to fill flatness list with power sensor.

- Flatness List

In the flatness list edit page, insert the frequency list. Then enter the set of flatness list filling, choose "Flatness" method, and click "Fill Flatness With Sensor" . The amplitude correction values in the flatness list will be generated.

- Manual Step

Choose "Manual Step" method, several hidden options will be enabled. Edit these options to generate frequency list, and then click "Fill Flatness with Sensor" ; amplitude correction values in the flatness list will be generated.

- Sweep List

"Sweep List" method will generate frequency list according to the sweep list you have edited in the RF Sweep function. And then you can click "Fill Flatness

with Sensor” , amplitude correction values in the flatness list will be generated.

Note:

- You should connect a power sensor with the Signal Generator you use. Before you fill the flatness list with sensor, there’s no need for you to turn on the RF state or sensor state. Before or after “Fill Flatness with Sensor” executed, the RF state and sensor state will be turned on or turned off automatically.
- During filling the flatness list, the pop-up message will be shown as below.

You should not remove the power sensor until the process is finished.

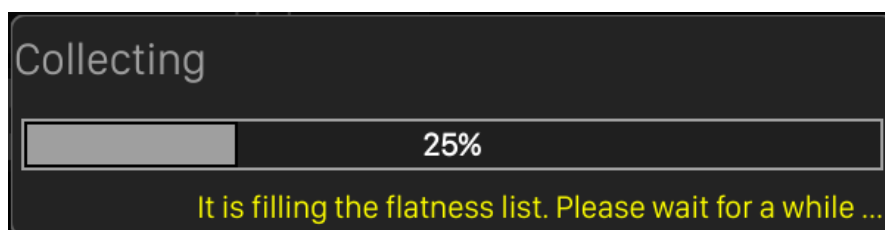

2.3 Sweep Setting

When the RF sweep function is enabled, the RF signal is output from the N-type connector of [RF OUTPUT 50Ω] on the front panel.

Note: The RF signal will be on only when the RF switch is on.

Press **SWEEP** to enter RF sweep setting.

2.3.1 Sweep State

The sweep state is off by default. The signal generator SSG5000X offers three different RF sweep types: Freq, Level, and Freq& Level.

Clicking the drop-down box of the sweep state to choose a sweep type:

- Off: Default state. The sweep disabled Close RF sweep function.
- Freq: Enable frequency sweep. The frequency parameter bar refreshes the current frequency value in real time and the current sweep progress can be observed on the frequency sweep progress bar.
- Level: Enable level sweep. The frequency parameter bar refreshes the current level value in real time and the current sweep progress can be observed on the level sweep progress bar.
- Freq& Level: Enable frequency sweep and level sweep function. The frequency and level parameter bar refreshes the current frequency and level value in real time and the current sweep progress can be observed on the frequency and

level sweep progress bar.

2.3.2 Step Sweep

The step sweep state is on by default. Click the slide to switch the on-off state. Click



to enter the parameter setting menu of step sweep.

Note: The step sweep and list sweep are mutually exclusive. One will shut off automatically when the other is on.

- 1) Start Freq: Initial frequency set point of the sweep.
- 2) Stop Freq: Final frequency set point of the sweep.
- 3) Start Level: Initial amplitude level set point of the sweep.
- 4) Stop Level: Final amplitude level set point of the sweep.
- 5) Dwell time: The interval time between two sweep points.
- 6) Sweep points: The number of points in a sweep .Every point is interpolated between the start parameter and stop parameter.
- 7) Sweep shape: Click the drop-down box, Sawtooth and Triangle can be selected
 - Sawtooth: Sweep period is always from the start frequency or start level to the stop frequency or stop level. The sweep sequence is similar to a "Sawtooth wave".
 - Triangle: Sweep period is always from the start frequency or start level to the stop frequency or stop level, and then return back to the start frequency or start level. The sweep sequence is similar to a "triangle wave".

8) Sweep Space: Click the drop-down box, linear and log can be selected.

Note: Level sweep only support the line sweep mode. List Sweep



2.3.3 List sweep



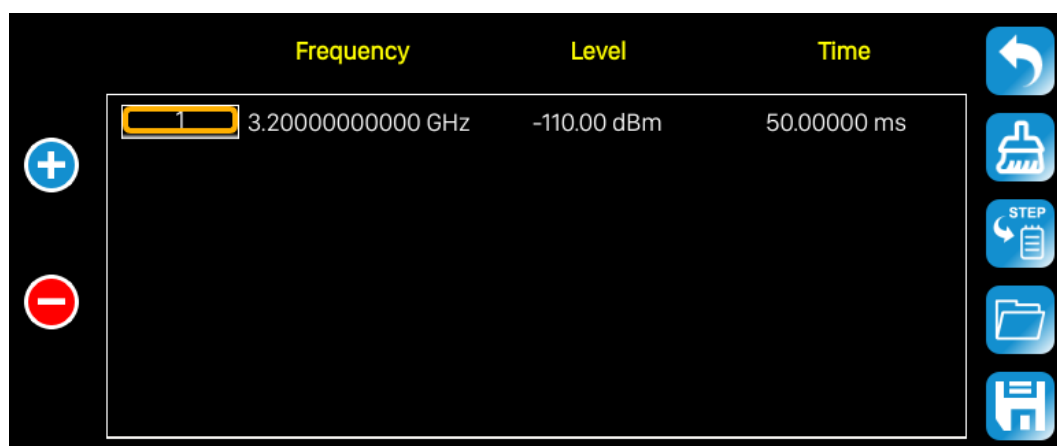

The list sweep state is off by default. Click the slide to switch the on-off state. Click the "more setting" to enter the table edit page of list sweep.

Note: The List sweep and step sweep are mutually exclusive. One will shut off automatically when the other is on.



As show in the figure, the table edit page consists of the operating button on the left of page, the table on the middle of the page and the menu button on the right side.

- 1) Inset line: Click the  to inset a new line under the current cursor.
- 2) Delete line: Click the  to delete the line under the current cursor.
- 3) Parameter edit: Click each parameter in the table to set it through the touch screen keyboard or the keypad of the front panel.
- 3) Return to previous page: Click  to return to the previous menu.

- 4) Cleaning list: Click  to clean and preset current list.
- 5) Default step sweep list: Click  to generate a new list according to the step sweep setting.
- 6) Loading list: Click  button to enter the file system directory. At this time, the sweep list file previously saved in the device can be selected to read, and the parameter can be modified.
- 7) Save list: Click the  button to enter the file system directory. At this time, enter the file name, then save the sweep list file.

Note: Please refer to the related introduction in “File Management” for detailed operation of Loading/Saving files.

Each line parameter represents the setting of each sweep point:

- 1) Number: Indicates the row number of the sweep point.
- 2) Frequency: Indicates the frequency of the sweep point.
- 3) Level: Indicates the level of the sweep point.
- 4) Time: Indicates the dwell time of the sweep point.

2.3.4 Direction

Sweep direction state is “up” by default. The SSG5000X provides two types: “up” or “down” . Click the drop-down box to enable the corresponding sweep

direction.

- UP: The signal generator sweeps from the start frequency or start level to the stop frequency or stop level. The progress bar displayed in the parameter bar is swept from left to right.
- DOWN: The signal generator sweeps from the stop frequency or stop level to the start frequency or start level. The progress bar displayed in the parameter bar is swept from right to left.

2.3.5 Sweep Mode

Default Sweep mode is “continuous” . The SSG5000X offers “continuous” or “single” sweep modes. Click the drop-down box to enable the desired mode.

- Continuous: When the trigger condition is met, the signal generator is continuously swept with the current settings.
- Single: When **Execute single sweep** is clicked, the signal generator executes a single sweep with the current settings.

2.3.6 Trigger Mode

The default trigger mode is “Auto” . The SSG5000X provides four types of trigger mode: “Auto” , “Key” , “Bus” and “Ext” .

Click the drop-down box of the trigger mode to select the desired type:

- **Auto:** The default mode. If the sweep mode is “continuous” , just select one sweep type to start a sweep. If the sweep mode is “single” , then click the **Execute single sweep** button to start a one-time sweep.
- **Key:** If the sweep mode is “continuous” , the device will start a one-time sweep after you press the **Trigger** button on the front panel or click **Click to trigger** button on the touch screen. If the sweep mode is “single” , first click the **Execute single sweep** button, then a one-time sweep will be started after you press the **Trigger** button on the front panel or click **Click to trigger** button on the touch screen.
- **Bus:** If the sweep mode is “continuous” , the device will start a one-time sweep after receiving a “*TRG” command over the communications bus (USB or LAN) from a controlling computer. If the sweep mode is “single” , click the **Execute single sweep** button first, then send a “*TRG” command to start a one-time sweep.
- **External:** The device receives the trigger signal input from the **[TRIGGER IN]** connector on the back panel. If the sweep mode is “continuous” , the device will start a one-time sweep after receiving a specified polarity TTL pulse. If the sweep mode is “single” , click the **Execute single sweep** button firstly and

then the device will start one time sweep after receiving a specified polarity TTL pulse.

2.3.7 Point Trigger

The default point trigger mode is "Auto". The SSG5000X provides four types of point trigger: "Auto", "Key", "Bus" and "Ext".

Click the drop-down box of point trigger mode to select the desired type:

- Auto: The default mode. If the sweep mode is "continuous", just select one sweep type to start and sweep through each point continuously in one sweep cycle. If the sweep mode is "single", first click **Execute single sweep** button to sweep through each point in one sweep cycle.
- Key: If the sweep mode is "continuous", the device will sweep one point at a time after every press of the **Trigger** button on the front panel or click **Click to trigger** button on the touch screen. If the sweep mode is "single", you will need to click **Execute single sweep** button first, and then press the **Trigger** button once for every point in the sweep. The sweep will stop when finish one sweep cycle.
- Bus: If the sweep mode is "continuous", the device will start a sweep after you send a "*TRG" command. If the sweep mode is "single", you will need

to click **Execute single sweep** button first and then send a “*TRG” command to start sweep a point. The sweep will stop when finish one sweep cycle.

- External: The device receives the trigger signal input from the **[TRIGGER IN]** connector on the back panel. If the sweep mode is “continuous” , the device will sweep one point when receiving a specified polarity TTL pulse. If the sweep mode is “single” , you will need to click the single sweep button first and then the device will start sweep one point when receiving a specified polarity TTL pulse. The sweep will stop when finish one sweep cycle.

2.3.8 Trigger Slope

When the trigger mode or the point trigger mode is “Ext” , you can select “Positive” or “Negative” as the trigger type. The default trigger type is “Positive” . Click the drop-down box to select the desired trigger edge:

- Positive: A sweep is triggered when the rising edge of the external trigger signal arrives.
- Negative: A sweep is triggered when the falling edge of the external trigger signal arrives.

Note: The trigger edge control is displayed only when the trigger mode or point trigger mode is “Ext” , and is hidden in other cases.

When performing a sweep operation, the order of priority that satisfies the required conditions from high to low is: Single sweep -> trigger mode -> point trigger mode.

For example, when the “trigger mode ” and “point trigger mode” are both selected as “key” : In the “continuous sweep” , first press the **Trigger** key to satisfy the trigger mode, and then press the **Trigger** key again to meet the point trigger sweep mode to begin sweep. In the “single sweep” , you need to press **Execute single sweep** first to meet the single sweep conditions, and then press the **Trigger** key two times to meet the sweep cycle trigger and point trigger conditions to begin sweep.

2.4 Analog Modulation

2.4.1 Amplitude Modulation (AM)

Amplitude Modulation (AM) is a technique for delivering information by linearly varying the amplitude of an RF carrier signal.

AM source can be selected as an internal source, external source or internal source + external source. To source dual tone level modulation, configure the source for internal source + external source. The internal source is shared with the LF. When the LF is turned on, the internal source can't be used as a modulation source.

Select **MOD**->**AM**, to enter the level modulation parameter setting state. The setting instructions are as follows:

Function Menu	Instructions
AM State	Turn on or off the level modulation function
AM Source	Select the modulation source, which can be Int, Ext, Int + Ext
AM Shape	Select modulation wave type
AM Rate	Frequency range: 0.01Hz~100kHz
AM Depth	Modulation depth range is from 0.01% to 100%
AM Sensitivity	Show the sensitivity of the external modulation

	source level to the modulation depth is 50%/V
--	---

2.4.1.1 AM State

Select **MOD**->**AM**->**AM State**, and then turn on or off the level modulation.

2.4.1.2 AM Source

An internal and/or external source can be selected for amplitude modulation.

Press **MOD**->**AM**->**AM Source** to set "Int" or "Ext" or "Int + Ext" . The default is "Int" .

1. Int

When internal modulation is selected, the AM Shape, AM frequency, and AM depth are controlled by the instrument. The internal modulation setting uses the LF generator as the modulation signal source. When modulation is activated, the LF output will be disabled, if it was previously activated.

2. Ext

Use an externally applied modulation signal. The external signal is input via the **[EXT MOD INPUT]** connector on the rear panel of the instrument. The modulated signal can be an arbitrary waveform. At this time, the modulation depth is controlled by the level of the externally modulated signal, and the sensitivity of the

external modulation source level to the modulation depth is 50%/V.

3. Int + Ext

Use both the internal and externally applied modulation signals, this technique can be used to source dual tone AM.

2.4.1.3 AM Shape

The SSG5000X supports modulation waveforms for internal “sine” and “square” modulation sources. Select **MOD**->**AM**-> **AM Shape**, after setting to “Int” or “Int+Ext” , you can select AM waveform as “Sine” or “Square” .

2.4.1.4 AM Rate

Select **MOD**->**AM**-> **AM Rate**, and set the AM rate.

1. Sine wave modulation frequency range is 0.01Hz~100kHz
2. Square wave modulation frequency range is 0.01Hz~20kHz

2.4.1.5 AM Depth

Set the modulation depth in percent. Select **MOD**->**AM**->**AM Depth**, and then set AM depth.

When the “Int” modulation source is selected, the AM modulation depth is set

from 0.01% to 100%. The relationship between the modulation depth m and the carrier sideband level difference ΔP is satisfied: $\Delta P = 6.02 - 20 \cdot \log(m)$

When the "Ext" modulation source is selected, the sensitivity of the external modulation source level amplitude to the modulation depth is 50%/V. For example, the modulation depth is 100% when the external modulation signal is 2Vpp (offset is 0V), and the modulation depth is 50% when the external modulation signal is 1Vpp (offset is 0V).

When selecting the "Int+Ext" modulation source, the modulation depth set is the internal source modulation depth + the external source modulation depth, and the internal source modulation depth is assigned = the external source modulation depth. For example, if the modulation depth is set to 100%, the modulation depth assigned to the internal source is 50%, the external source modulation depth is 50%, and the external modulation sensitivity is 25%/V. If the external modulation signal is 2Vpp (the offset is 0V), then the modulation depth is 100%.

2.4.2 Frequency Modulation (FM)

Enter the FM interface

1. Click the MOD icon in the main interface to enter the MOD interface. The MOD interface displays the AM page by default. Then switch to the FM modulation

page by clicking or sliding left.

2. Enter the FM modulation page directly through the shortcut menu.
3. Enter the MOD interface via the **MOD** button and switch to the FM page.

2.4.2.1 FM State

Select **MOD** -> **FM**-> **FM State**, to turn FM on or off.

2.4.2.2 FM Source

Select **MOD** -> **FM**-> **FM Source** to set "Int" or "Ext" or "Int + Ext" . The default is "Int" .

1. Int

Use the internal LF generator as the modulation signal source for FM. The FM Shape, FM deviation, and FM rate can be set.

When LF and FM mod is **simultaneous** on, their frequency and shape is changed according to who was changed.

2. Ext

Use an externally applied modulation signal. The external signal is input via the MOD EXT connector with an impedance matching of 50 ohms and the amplitude is up to +-3V.

3. Int + Ext

Use both, the internal and externally applied modulation signal; this technique can be used to perform two-tone FM.

2.4.2.3 FM Shape

Select **MOD**->**FM**-> **FM Shape**. After setting to "Int" or "Int+Ext" , you can select FM waveform as "Sine" or "Square" .

2.4.2.4 FM Rate

Select **MOD**->**FM**-> **FM Rate**, you can set the FM rate.

1. The sine wave modulation frequency range is 0.01Hz~100kHz
2. The square wave modulation frequency range is 0.01Hz~20kHz

2.4.2.5 FM Deviation

Corresponding to different carrier frequencies, the frequency offset range may be different; the setting range is governed by the following equation: $0.01\text{Hz} \sim N \times 1\text{MHz}$.

For the definition of N, refer to the data sheet.

- When the modulation source is set to "Int" , the set value is actually the

frequency offset of the RF output.

- When the modulation source is set to “Ext” , it is related to the amplitude of the external input modulation signal. The offset of RF output = amplitude of input signal × external modulation sensitivity.

- When the modulation source selects “Int+Ext” , the set value is the maximum value of the total offset, the internal source accounts for 50%, and the external source accounts for 50%. RF output offset = set value × 0.5 + external input signal amplitude × external modulation sensitivity.

External modulation sensitivity

The display shows the unit offset quantized by the amplitude of the externally modulated signal, which is equal to the maximum offset when the external modulation input is full scale. When the “Int+Ext” modulation source is enabled, the internal and external each account for 50% of the maximum offset, so when the external source inputs a full scale signal, it only accounts for 50% of the maximum output offset.

Note: The modulation function must be activated to modulate the output signal.

You can turn it on or off by pressing the **MOD ON/OFF** button or you can open it by checking the ANALOG MOD module on the home page, as shown in the figure:

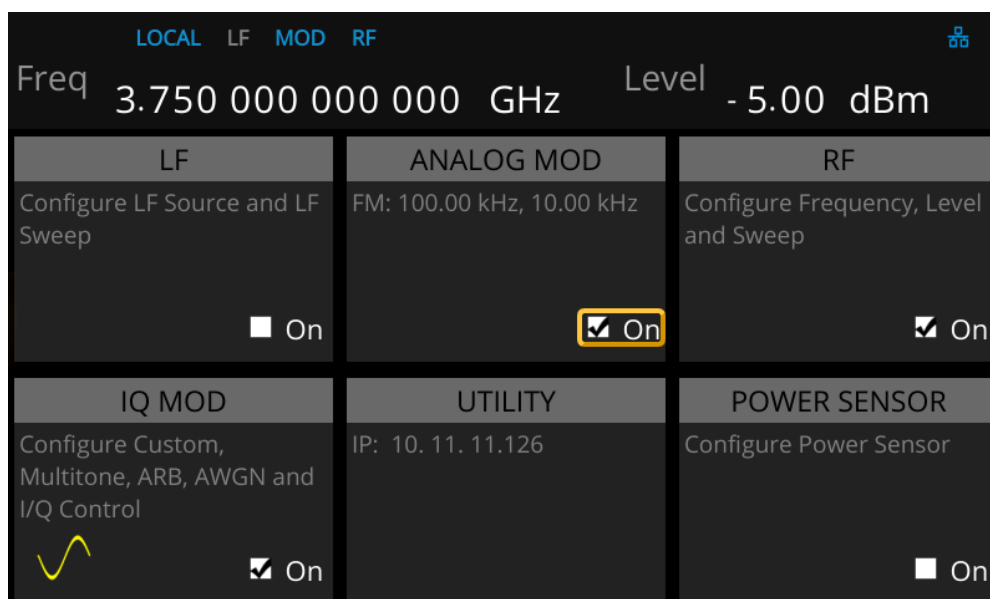

2.4.3 Phase Modulation (PM)

Enter the PM interface

1. Click the MOD icon in the main interface to enter the MOD interface. The MOD interface displays the PM page by default. You can switch to the PM modulation page by clicking or sliding left.
2. Enter the PM modulation page directly through the shortcut menu.
3. Enter the MOD interface via the **MOD** button and switch to the PM modulation page.

2.4.3.1 PM State

Select **MOD** -> **PM** -> **PM State** to turn PM on or off.

2.4.3.2 PM Source

Select **MOD** -> **PM**-> **PM Source** to set "Int" or "Ext" or "Int + Ext" . The default is "Int" .

1. Int

Use the internal LF generator as the modulation signal source for PM. The PM Shape, PM deviation, and PM rate can be set.

2. Ext

Use an externally applied modulation signal. The external signal is input via the EXT MOD INPUT connector with an impedance of 50 ohms

3. Int + Ext

Use both, the internal and externally applied modulation signal; this technique can be used to perform two-tone PM.

2.4.3.3 PM Shape

Select **MOD** -> **PM**-> **PM Shape**. After setting the source to "Int" or "Int+Ext" , you can select PM waveform as "Sine" or "Square" .

2.4.3.4 PM Rate

Select **MOD** -> **PM**-> **PM Rate**, then you can set the PM rate.

1. The sine wave modulation frequency range is 0.01Hz~100kHz
2. The square wave modulation frequency range is 0.01Hz~20kHz

2.4.3.5 PM Deviation

The setting range is $0.00001\text{rad} \sim N \times 5\text{rad}$. For the definition of N, refer to the data sheet.

- When the modulation source is set to "Int", the set value is actually the frequency offset of the RF output.
- When the modulation source is set to "Ext", it is related to the amplitude of the external input modulation signal. Offset of RF output = amplitude of input signal \times external modulation sensitivity.
- When the modulation source selects "Int+Ext", the set value is the maximum value of the total offset, the internal source accounts for 50%, and the external source accounts for 50%. RF output offset = set value \times 0.5 + external input signal amplitude \times external modulation sensitivity.

External modulation sensitivity

The display shows the unit offset quantized by the amplitude of the externally modulated signal, which is equal to the maximum offset when the external modulation input is full scale. When the “Int+Ext” modulation source is enabled, the internal and external each account for 50% of the maximum offset, so when the external source inputs a full scale signal, it only accounts for 50% of the maximum output offset.

Note: The modulation function must be activated to modulate the output signal.

You can turn it on or off by pressing the **MOD ON/OFF** button or you can open it by checking the MOD module on the home page, as shown in the figure:

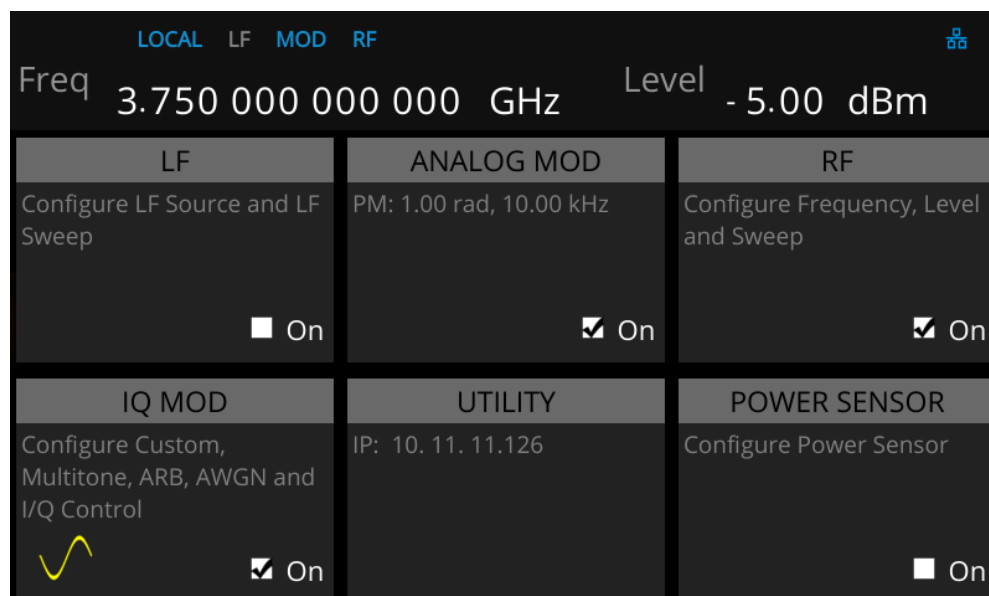

2.4.4 Pulse Modulation (PULSE)

Pulse Modulation represents the process of modulating an RF carrier signal with a pulse signal as a modulated signal.

2.4.4.1 Pulse State

Select **MOD**->**PULSE**->**Pulse State** to turn Pulse on or off.

2.4.4.2 Pulse Out

Select **MOD**->**PULSE**->**Pulse Out** to turn Pulse Out on or off. The default is off.

- On: Turn on the pulse output function. At this time, the signal source outputs the pulse signal generated by the internal pulse generator from the **[PULSE IN/OUT]** connector on the rear panel.

- Off: Turn off the pulse output function.

Note: When the modulation source is "Ext" , the pulse output function will be turned off automatically.

2.4.4.3 Pulse Source

Select **MOD**->**PULSE**->**Pulse Source** to set "Int" or "Ext" . The default is "Int" .

1. Int

Use the internal LF generator as the modulation signal source for PM. You can set

Pulse Mode, Pulse Period, and Pulse Width and so on.

2. Ext

Use an externally applied modulation signal. The external signal is input via the **[PULSE IN/OUT]** connector.

At this time, setting items such as pulse type, pulse period, pulse width, trigger mode, and pulse output are hidden.

2.4.4.4 Pulse Polarity

The default is "Normal" . Click the drop down box to switch the pulse polarity type

- Normal: Perform pulse modulation when the pulse modulation signal is high.
- Inverse: Do not perform pulse modulation when the pulse modulation signal is high.

2.4.4.5 Pulse Mode

When the modulation source is "Int" , the SSG5000X provides three pulse modes:

"Single" , "Double" and "Train" . The default is "Single" . Click the drop down box to select the pulse mode.

- Single: A pulse signal is generated during one pulse period. At this time, the two settings "Double Pulse Delay" and "#2 Width" are hidden.

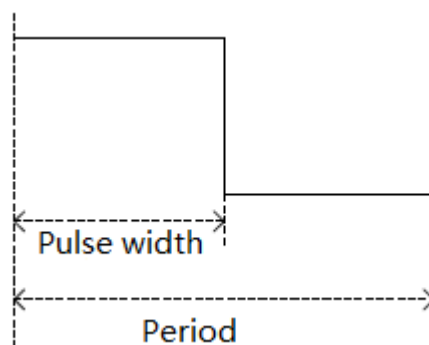

- Double: Generate two pulse signals in one pulse period. At this time, the two settings “Double Pulse Delay” and “#2 Width” are shown.

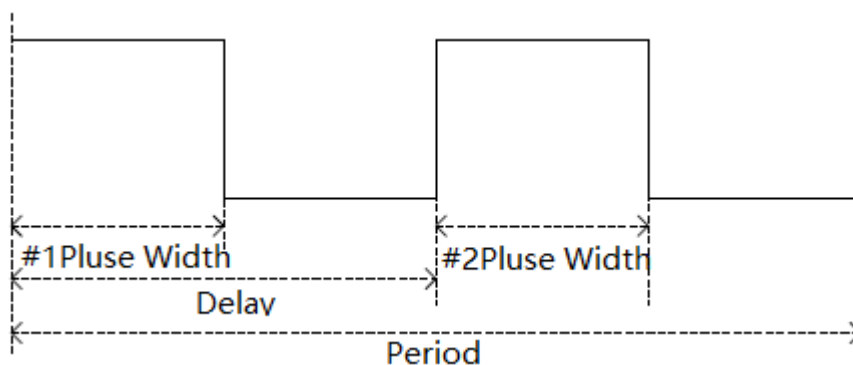

- Train: Multiple pulse signals in one pulse period. At this time, the pulse sequence setting item appears, and the two settings “Double Pulse Delay” and “#2 Width” are hidden.

Note: This setting item will be hidden when the modulation source is “Ext” .

2.4.4.6 Pulse Period

The pulse period represents the time interval between two adjacent periodic pulses, and the period of the single pulse or double pulse modulated signal can be set by

touching the screen keyboard or pressing the front panel keypad.

Note: This setting item will be hidden when the modulation source is “Ext” or the pulse mode is “Single” or “Double” .

2.4.4.7 Pulse Width

The pulse width indicates the duration when the pulse signal is at a high level. The width of the first pulse of the single pulse modulated signal or the double pulse modulated signal can be set by touching screen keyboard or pressing the front panel keypad.

Note: This setting item will be hidden when the modulation source is “Ext” or the pulse mode is “Train” .

2.4.4.8 Double Pulse Delay

The double pulse delay indicates the delay from the start of the first pulse to the start of the second pulse in a single cycle of the double pulse modulated signal. This parameter can be set by touching screen keyboard or pressing the front panel keypad.

Note: This setting item will be hidden when the modulation source is “Ext” or the pulse mode is “Train” .

2.4.4.9 #2 Pulse Width

#2 Pulse Width represents the width of the second pulse of the double pulse modulated signal. This parameter can be set by touching screen keyboard or pressing the front panel keypad.

Note: This setting item will be hidden when the modulation source is “Ext” or the pulse mode is “Train” .

2.4.4.10 Trigger Out

The default is “off” , Click the slide switch to switch the trigger output switch status.

- On: Turn on the trigger output function. At this time, the signal source outputs the trigger signal generated by the internal pulse generator from the [TRIG IN/OUT] connector on the rear panel.
- Off: Turn off the trigger output function.

Note: When the trigger mode is “Ext Trig” or “Ext Gate” , the trigger output function will be automatically turned off. And only the trigger signal of the PULSE

modulation signal is output, and the trigger signals of the LF SWEEP and the RF SWEEP are not output.

2.4.4.11 Pulse Trigger

The trigger mode defaults to "Auto" . The SSG5000X offers four pulse trigger types:

"Auto" , "Key" , "Ext Trig" and "Ext Gate" .

Click the drop-down box corresponding to the trigger mode to select the desired type.

- Auto: The default trigger method. The signal source satisfies the trigger condition at any time. At this time, the two settings "Trig Slope" and "Trig Polarity" are hidden.
- Key: Each time the "Trigger" key is pressed, the signal source initiates a pulse modulation. At this time, the two settings "Trig Slope" and "Trig Polarity" are hidden.
- Ext Trig: The source receives the trigger signal from the [PULSE IN/OUT] connector on the rear panel. Each time a TTL pulse signal of the specified polarity is received, the source initiates a pulse modulation. At this point, the "Trig Slope" setting will be displayed and the "Trig Polarity" setting will be hidden.

- Ext Gate: The source receives the trigger signal from the [PULSE IN/OUT] connector on the rear panel. Each time a TTL pulse signal of the specified polarity is received, the source initiates a pulse modulation within its active level. At this point, the “Trig Polarity” setting will be displayed and the “Trig Slope” setting will be hidden.

2.4.4.12 Trigger Delay

The trigger delay indicates the delay from the receipt of the external trigger signal to the start of the first pulse. This parameter can be set by touching screen keyboard or pressing the front panel keypad.

Note: This setting item will be hidden when the modulation source is “Ext” or the pulse trigger is not “Ext Trig” .

2.4.4.13 Trigger Slope

The default is “Positive” , click the drop-down box to switch the trigger slope.

- Positive: Trigger a pulse when the positive slope of the external trigger signal arrives.
- Negative: Trigger a pulse when the negative slope of the external trigger signal arrives.

Note: This setting item will be hidden when the modulation source is “Ext” or the pulse trigger is not “Ext Trig” .

2.4.4.14 Trigger Polarity

The default is “Normal” ; click the drop-down box to switch the trigger polarity type.

- Normal: Trigger a pulse modulation during the effective time when the external gate signal is high.
- Inverse: Trigger a pulse modulation during the effective time when the external gate signal is not high.

Note: This setting item will be hidden when the modulation source is “Ext” or the pulse trigger is not “Ext Gate” .





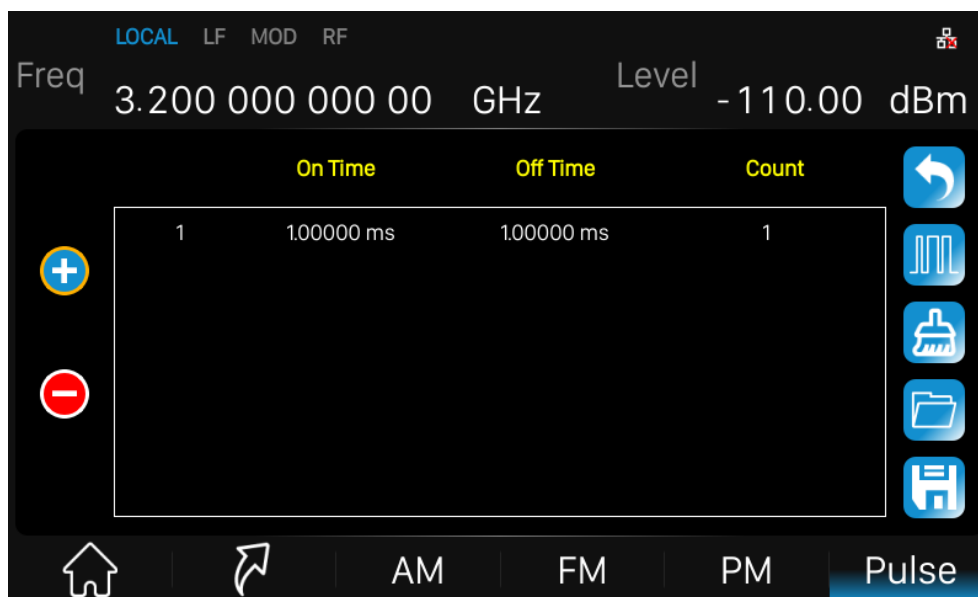

2.4.4.15 Pulse Train

When the Pulse Mode is set to Train, the Pulse Train option appears.

Click Pulse Train to enter the table edit page for the pulse sequence.



As shown, the list edit page consists of the left action button, the middle table area, and the right menu button:

- 1) Insert line: Click the button  to automatically insert a new line on the next line where the current cursor is located.
- 2) Delete line: Click the button  to delete the line where the current cursor is located.
- 3) Parameter editing: Click each parameter in the table area and set it through the touch screen keyboard or the front panel keypad.
- 4) Return to the previous level: Click the  button to return to the previous menu.
- 5) Clear list: Click the  button to clear and reset the current list.
- 6) View the pulse sequence diagram: Click the  button to enter the pulse sequence diagram page.
- 7) Load list: Click the  button to enter the file system directory. At this time,

you can select and read the scan list file previously saved in the device, and you can edit and modify the next step.

8) Save the list: Click the  button to enter the file system directory. At this time, you need to enter the file name to save the scan list file.

Note: For details on loading/saving files, please refer to the related introduction in “File Management” .

The parameters in each row represent the settings for each pulse signal in a single pulse period:

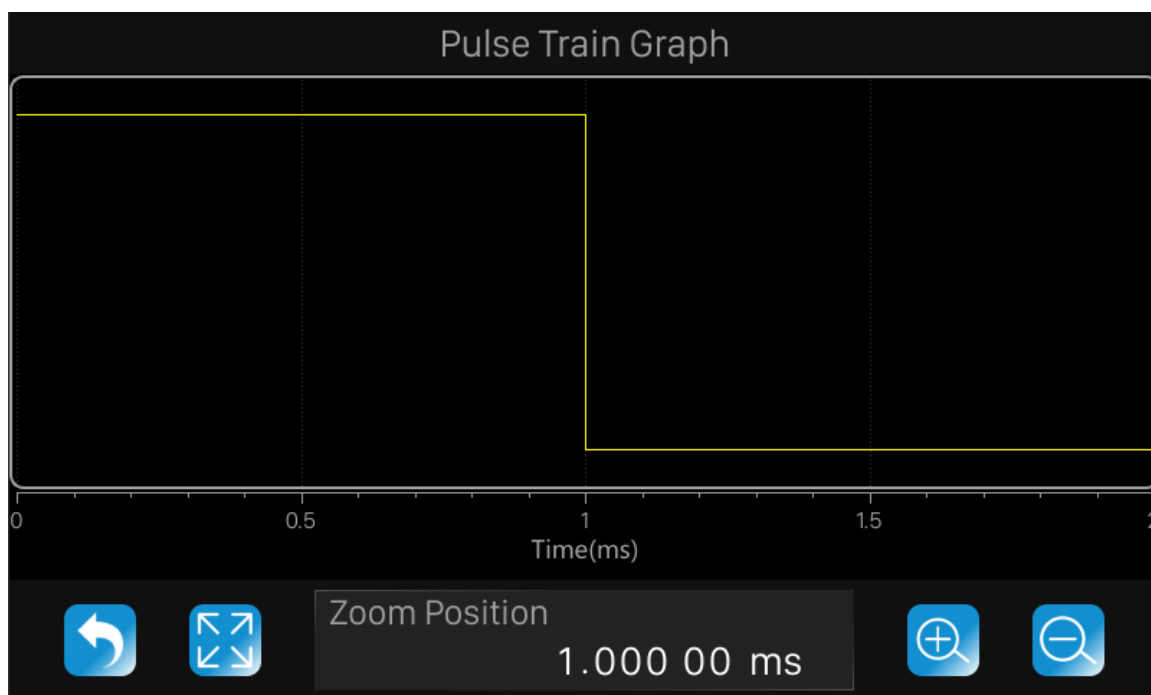

- 1) Serial number: indicates the serial number of the pulse signal corresponding to this line.
- 2) Positive pulse time: Indicates the duration of the pulse signal being high.
- 3) Negative pulse time: Indicates the duration of the pulse signal being low.
- 4) Quantity: Indicates the number of repetitions of this pulse signal.

The pulse sequence schematic page is shown below:





As shown, the page consists of the upper drawing area and the lower control area:

1) Plot area: A schematic diagram of the waveform generated from the data entered in the current pulse sequence table. The vertical direction represents the high and low level changes of each pulse signal in the pulse sequence, and the position of the high and low levels in the direction is unchanged; The horizontal direction represents the high and low level duration of each pulse signal in the pulse sequence. You can use the zoom feature to observe different details of the waveform.

2) Control area: Click the  button to return to the previous pulse sequence table edit page; Click the  button to restore the waveform to the initial state; Click the  button to zoom in the center position of the current waveform; Click

the  button to zoom out the center position of the current waveform; The “Zoom Position” parameter control displays the center position of the current waveform, and the operations of the “Zoom In” and “Zoom Out” buttons are based on this position. It can be set by touching screen keyboard or pressing the front panel keypad to shift the current waveform to the corresponding position.

The scaling operation for the drawing area can be achieved in the following ways:

- Zoom in, zoom out, restore and pan through the Control Area's , ,  button, and Zoom Position parameter controls.
- From the web interface, you can press the left mouse button, select the area to be enlarged, and then release the left button to complete the zoom operation. You can also use the finger or touch directly to zoom in on the touch screen; click the right mouse button to undo the previous step.
- From the web interface, you can use the mouse wheel, roll down to zoom in and roll up to zoom out. The zoom position of the wheel is the same as the zoom position of the control area.

2.5 LF Setting

2.5.1 LF Source

The SSG5000X has an internal low-frequency signal generator that can be used as an internal source for low-frequency signal output or analog modulation. When output as a low-frequency signal, the LF output supports several common waveforms, and the frequency and amplitude of the low-frequency signal can be set. Press **LF** to enter the LF parameter settings. Setting description is as follows:

2.5.1.1 LF State

Select **LF** -> **LF Source** -> **LF State** to turn LF on or off.

2.5.1.2 LF Frequency

Select the **LF** -> **LF Source** -> **LF Frequency** to set the frequency of the LF output signal, the setting range is 0.01Hz ~ 1MHz.

2.5.1.3 LF Level

Select the **LF** -> **LF Source** -> **LF Level** to set the LF output amplitude, the range is from 1mV ~ 3V, and supports a number of unit types.

2.5.1.4 LF Offset

Select **LF**-> **LF Source**->**LF Offset** to set the amplitude offset of the LF output. The setting range is. $|LF_{offset}| \leq 2.5 - \frac{1}{2} LEVEL$

2.5.1.5 LF Shape

Select **LF**-> **LF Source**->**LF Shape**, you can select the LF output signal waveform. Current waveform types are “sine wave” , “square wave” , “Sawtooth wave” , “triangle wave” , and “DC” . The default LF output signal is the “sine wave” waveform.

2.5.1.6 LF Phase

Select the **LF**-> **LF Source** ->**LF Phase** you can set the LF phase, the setting range is -360° ~ 360°, and supports degrees or radian units.

2.5.2 LF Sweep

2.5.2.1 Sweep State

Select **LF**->**LF Sweep**->**Sweep State** to activate the LF frequency sweep signal

generation.

2.5.2.2 Start Freq

Select **LF** -> **LF Sweep** -> **Start Freq** to set the start frequency.

2.5.2.3 Stop Freq

Select **LF** -> **LF Sweep** -> **Stop Freq** to set the stop frequency.

2.5.2.4 Center Freq

Select **LF** -> **LF Sweep** -> **Center Freq** to set the center frequency.

2.5.2.5 Freq Span

Select **LF** -> **LF Sweep** -> **Freq Span** to set the frequency Span.

2.5.2.6 Direction

Select **LF** -> **LF Sweep** -> **Sweep Direction** to set the sweep direction.

2.5.2.7 Sweep Times

Select **LF**->**LF Sweep** ->**Sweep Time** to define the duration of the individual sweep steps. The “Dwell Time” set by the user is used as the step time of the sweep.

2.5.2.8 Trigger Mode

Select **LF**->**LF Sweep**->**Trigger Mode** to select the LF frequency sweep mode. If you change the sweep mode during the execution, the signal generator stops the sweep and starts with the next trigger event at the initial value.

1. Auto

Generate a continuously repeating sweep signal immediately after activating the sweep mode.

2. Key

Generate a single sweep cycle after a trigger event. The sweep steps within the cycle are performed automatically, controlled by the dwell time. If one cycle is completed, the instrument waits for the next trigger event.

3. Ext

Generate a single sweep cycle when an external trigger event occurs.

2.5.2.9 Sweep Shape

Select **LF**->**LF Sweep**->**Sweep Shape** to select the waveform shape of the sweep

signal.

1. Sawtooth

The sweep runs from the start to the stop frequency. Each subsequent sweep starts at the start frequency that means the shape of the sweep sequence resembling a Sawtooth.

2. Triangle

The sweep runs from start to stop frequency and back, that means the shape of the sweep resembles a triangle. Subsequent sweep starts at the initial start frequency.

2.5.2.10 Sweep Space

Select **LF** → **LF Sweep** → **Sweep Space** to select the mode for the calculation of the frequency sweep intervals.

1. Linear

Take the frequency value entered as an absolute value in Hz

2. Logarithmic

Takes the value entered as a logarithmic value that means as a constant fraction of current frequency in %.

2.6 Utility

2.6.1 System

2.6.1.1 Setting

1. Language

Set the display language of SSG5000X. SSG5000X supports Chinese/English menus, help and interface display.

Press **UTILITY**->**Setting**->**Language** to expand drop down list, and then select the desired language.

2. Screen Saver

Set the state of screen saver. When screen saver is switched on, screen saver will be enabled if no action is taken within the specified time. Click the touch screen or press any key to resume.

Press **UTILITY**->**Setting**->**Screen Saver** to expand drop down list, and then select "off" , "10 s" , "1 min" , "5 min" , "15 min" , "30 min" , "1 hour" or "2 hour"

3. Power On

Set the type of parameter configuration to be loaded when the instrument startup.

Press **UTILITY**->**Setting** ->**Power On** to expand drop down list, and then select "Default" or "Last" .

Default: The factory defined default settings will be loaded at power on. For more details please refer to [错误!未找到引用源。](#) .

Last: The system setting before the last power-off will be loaded automatically at power-on.

4. Preset Type

Set the parameters for the Preset configuration of the instrument.

Press **UTILITY**->**Setting**->**Preset Type** to expand drop down list, and then select "Default" or "User" .

- Default: The default settings will be loaded when **PRESET** is pressed. For more details please refer to Table 2-3.
- User: The user specified configuration will be loaded when **PRESET** is pressed. After "User" is selected, click  button to load the configuration file. For detailed operation procedure please refer to "Store/Recall" .

5. Factory Reset

Restore the instrument configuration to factory settings.

Press **UTILITY**->**Settings**->**Factory Reset**, set the instrument parameters and status to factory defaults.

To restore factory settings, in addition to loading the default settings, the following functions and parameters will also be configured.

Table 2-2 Factory default

Parameter	Default
Setting	
Language	Chinese/English(depend on factory config)
Preset Type	Default
Beeper	On
Screen Saver	Off
Power On	Default
Power On Line	Off
10M Adjustment	Off
Interface	
DHCP State	Off
IP Address	10.11.13.220
Subnet Mask	255.255.255.0
Gateway	10.11.13.1

VNC Operable	On
GPIB Address	18
Level	
Flatness	null
Sweep	
List sweep	Keep only one default scan point
Mode	
Pulse Train	Keep only one default pulse

6. Reset & Clear

Set “Reset & Clear” will restore the instrument configuration to factory settings, as well as clean up files stored by users in “Local” folder.

Press **UTILITY**->**Settings**->**Reset & Clear** to set the instrument parameters and status to factory defaults and clean up local files.

7. Beeper

Set whether the beeper make a sound when clicking any button, input box or check box.

Press **UTILITY**->**Setting** ->**Beeper** to switch the beeper state.

8. Power On Line

Set the instrument power on sequence. In some situations, you may want the instrument to automatically restart if the line power is restored.

- Off: If line power is available, you need to manually press the power key on the front panel to start the instrument.
- On: If line power is available, the instrument starts automatically. This is an idea feature for automatic or remote tests that may be difficult to physically reach.

Press **UTILITY** -> **Setting** -> **Power on Line** to switch the state

9. 10M Adjustment

Modifying the Reference Oscillator Code will change the reference frequency. You can externally connect a frequency counter from the 10MHz OUT connector on the rear panel and adjust the 10MHz reference by modifying the code.

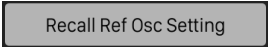
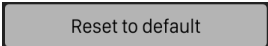
- Press  to save "*.dac" file to store the Ref Oscillator Code you currently set.
- Press  to recall the Ref Oscillator Code you have stored.
- Press  to set the Ref Oscillator Code to default value, and the reference frequency will reset to the original value, too.

Press **UTILITY** -> **Setting** -> **10M Adjustment** to switch the state.

10. Time Setting

Set the display time of the instrument.

Press **UTILITY**->**Setting** ->**Time Setting**, then move the cursor to specified location and change the time by inputting the value.

2.6.1.2 System Info

Press **UTILITY**->**System Info** to view the instrument's system information, including:

- Startup Times
- Model
- Software Version
- Hardware Version
- Host ID
- Serial Number

2.6.1.3 Interface

Press **Utility** ->**Interface** to view the instrument's remote control interface information, including:

1. LAN Setting

1) DHCP

Set the state of DHCP.

Press **UTILITY**->**Interface** ->**DHCP State**, then press **ENTER** or knob to change the state.

When the DHCP state is on, the network DHCP server will configure the IP address, subnet mask and gateway automatically according to the current network condition.

When the DHCP state is off, the IP address, subnet mask and gateway will be configured by the user.

2) IP Address

Configure the network IP address.

Press **UTILITY**->**Interface** ->**IP Address**, then move the cursor to specified location and press number keys to input value, finally press **ENTER** to make the setup effective.

3) Subnet Mask

Configure the network subnet mask.

Press **UTILITY**->**Interface** ->**Subnet Mask**, then move the cursor to specified location and press number keys to input value, finally press **ENTER** to make the setup effective.

4) Gateway

Configure the network subnet mask.

Press **UTILITY**->**Interface** ->**Gateway**, then move the cursor to specified location and press number keys to input value, finally press **ENTER** to make the setup effective.

2. Web Setting

Set the web login password.

Press **UTILITY**->**Interface** ->**Web Password Setting**, to enter the current password.

After correctly entering the password, a new password can be set in New Password.

Then make the setup effective by entering the new password again in Confirm

Password. If the password needs to be reset to default, just click the Reset to default button. (The default pass word is "siglent" .)

3. GPIB Setting

Set the GPIB address from 1 to 30. SSG5000X must use the SIGLENT USB-GPIB

interface (optional) connected to the USB Host port located on the rear panel.

Press **UTILITY**->**Interface** ->**GPIB Address**, and then press number keys to input value, finally press **ENTER** to make the setup effective.

2.6.1.4 Self Test

1. LCD Test

Press **UTILITY** -> **Self Test** -> **LCD Test** to enter the screen detection.

SSG5000X cycles through the red, green and blue pixels of the display to verify whether there are dot defects on the screen.

Press **7** to change the color and press **8** to exit.

2. Key Test

Press **UTILITY** -> **Self Test** -> **Key Test** to enter the keyboard test interface. Press the function keys at the front panel one by one and observe whether the corresponding key is checked. If not, an error may have occurred in that key. To exit the test, press **8** three times or click the screen.

3. LED Test

Press **UTILITY** -> **Self Test** -> **LED Test** to enter the LED test interface. Press **7** to light or extinguish the key light of the button **MOD ON/OFF** and **RF ON/OFF** and press **8** to exit the test.

4. Board Test

Press **UTILITY** -> **Self Test** -> **Board Test** to enter the board test interface. Test whether writing and reading are normal for CPLD and FPGA.

5. Touch Screen Test

Press **UTILITY**-> **Self Test** -> **Touch Screen Test** to enter the touch screen test interface.

Click the marks on the interface to test the touch screen and press **8** to exit the test.

2.6.1.5 Shutdown

Press **UTILITY**-> **Shutdown** to power off the instrument according to operating hints on the interface.

2.6.1.6 Preset

Reset parameter settings according to the type of preset selected.

Press **UTILITY**-> **Preset**, to reset the parameters.

2.6.1.7 Update

Press **UTILITY**-> **Update**, and select the update file. Then click **Recall** to update the system software. The progress bar will appear on the screen while updating and the instrument will restart automatically if updates succeed or pop-up prompt box if updates fail.

2.6.1.8 Option



Press **Utility** -> **Option**, to enter the option interface. Click the drop-down box under the “Install” to choose the license type that you wish to install. Then, click on the text field below the install type and use the touchscreen keypad to enter the license information. Click **Install** to finish the license installing.

If the installations succeed, the prompt message “license was successfully installed” will be pop-up. If not, the prompt message “license was entered incorrectly” will be displayed.

Note: The SSG comes with trial time for available options. The remaining number of trial use is displayed for each option at top of the option interface. When the remaining time of a certain function is zero, the function will be disabled. When a license is successfully installed for a certain function, the remaining times will be shown as “--” and the type of the license is permanent, which means users have unrestricted access to the function.

2.6.1.9 Help

Press **UTILITY** -> **Help**, to enter help interface and select the help items you need to

view. You can jump to the related page by clicking underline texts, return to the help list by clicking the icon , return to the last page by clicking the icon . And after returning to last page, you can return to the original page by clicking the icon .

2.6.1.10 Contact Us

Press **UTILITY**->**Contact Us** to view the contact information for SIGLENT. You can contact us to solve the problems meet in practical use. You can also write info@siglent.com or call your local SIGLENT sales office for support.

2.6.2 Store/Recall

Press **UTILITY**->**Store/Recall** to enter file management page. Then you can select file by knob and fold or expand folders by left and right direction key.

1. View Type

Click **View Type** to change the type of files to show, including "All", "Data", "State" and "Update" .

1) Data file:

- .lsw file: Sweep list data file;
- .uflt file: Flatness correction file;

- .pulstrn file: Pulse train file;
- .arb file: IQ waveform segment file;
- .header file: IQ waveform segment header file;
- .marker file: IQ waveform segment marker file;
- .SEQ file: IQ waveform sequence file;
- .sheader file: IQ waveform sequence header file;
- .mulstate file: Multitone file;
- .map file: constellation diagram file of I/Q modulation;
- .dac file: reference oscillator code file of 10M Adjustment function.

2) State file:

- .xml file: State saving file.

3) Update file:

- .CFG file: Configuration update file;
- .ADS file: System update file.

2. New Dir

Click **NewDir** to create new folders. Press  to switch the case of letter when entering the name of a new file.

3. Rename

Click **Rename** to rename a file or folder.

4. Delete

Click **Delete** to delete the selected file.

5. Copy

Click **Copy** to copy the selected file or folder.

6. Paste

Click **Paste** to paste the copied file or folder to specified location.

7. Recall

Click **Recall** to load the selected file.

8. Save

Click **Save** to save the file with corresponding type according to the type of data.

2.7 Power Sensor

The SSG5000X can be connected to a USB power sensor via the USB Host interface.

First connect the USB power sensor to the USB Host connector on the rear panel. If the “Power sensor has been connected!” message pops up on the screen, the signal source has successfully activated the power meter control option, and you can always use the power sensor function.

The power sensors currently supported by the SSG5000X are shown in the following table:

Manufacturer	Model
R&S (Rohde and Schwarz)	NRP6A USB Power Sensor
Keysight	U2000A Series USB Power Sensor

2.7.1 Power meter setting

The power sensor menu can be accessed in one of three ways:

- ◆ Click the power meter button on the shortcut menu.
- ◆ Click on the power meter measurement control on the home page.
- ◆ Switch menus by clicking the menu button or swiping in the Frequency, Level, or Sweep menu.

2.7.1.1 Sensor Info

Indicate the type of a connected power sensor. The sensor type is automatically detected.

2.7.1.2 Sensor State

The default is "off" . Activate/deactivate level measurement by the power sensor.

- On: Turn on the power sensor measurement function, and the measurement control refreshes the power sensor measurement value in real time.
- Off: Turn off the power sensor measurement function.

2.7.1.3 Measurement

Indicate the current reading of the sensor.

Select the unit used for result display. You can change the unit for the result display:

dBm, dB μ V, μ V, mV, V, nW, μ W, mW, W.

2.7.1.4 Level Control

With the Level Control function, you can achieve very stable and accurate RF power your DUT. With the aid of a downstream control circuit, a CLPC (Closed Loop Power Control), you can detect frequency response characteristics of the components: such as losses due to cables, modules or components and compensate these

effects accordingly.

2.7.1.5 Statistics

The default is "off" . When activated, statistics indicate the measured mean, maximum, minimum and the count of each measurement...

- On: Turn on the statistics function. Each statistical parameter is displayed on the parameter bar. Statistical parameters include average, minimum, maximum, and statistics. Click the "Clear" button to clear all current statistics and start new statistics.
- Off: Turn off statistics. Statistical parameters will be hidden

2.7.1.6 Auto Zero

When the power meter is zeroed, the zero measurement deviation and noise influence can be reduced, and the accuracy of the RF power measurement can be improved.

- Disable: The zero buttons will be hidden.
- Internal Zeroing: In this way, the power sensor remains connected to the RF signal during the zeroing process. Zero buttons is displayed.
- External Zeroing: When this mode is selected, you must remove the RF signal to be measured before the power sensor can be zeroed. Otherwise it will affect

the zeroing result. Zero buttons is displayed.

Press the “Click to perform zeroing” button, and the instrument performs the zero calibration operation of the power meter according to the “zero calibration type” you selected. This feature can be used to reduce the effects of noise and zero offset on the measurement results. And the button name will change from “Click to perform zeroing” to “Zero In Progress...” After the zero adjustment is completed, the button name will be restored to the word “Click to perform zeroing” .

Note: If the power meter does not have an internal or external zeroing option, the “internal” and “external” in the drop-down boxes are replaced by the “Enable” option.

2.7.1.7 Measure Frequency

The default is “Auto” . Click the drop down box to switch the mode.

- Auto: In this mode, the instrument configures the frequency value based on the output frequency of the RF.
- Manual: In this mode, the measurement frequency can be set by the touch screen keyboard or the front panel keypad.

2.7.1.8 Level Offset

The default is "Off" . Click the slide switch to switch the power offset switch status.

- On: The values can be set by the touch screen keyboard or front panel keypad.

The displayed value will be the actual measurement plus the offset. This feature makes measurements easier when there are amplifiers and attenuators in the middle of the signal chain.

- Off: The display is consistent with the actual reading of the power sensor.

2.7.1.9 Averaging Mode

The default is "Auto" . Click the slide switch to switch the averaging mode.

- Auto: Automatically configure the average number of times based on the current parameters. Fixed noise parameter settings will be automatically hidden.
- Manual: Manually set the average number times, with the parameter are behind.
- Fixed Noise: The power sensor will control the internal noise that does not exceed the set value of the fixed noise parameter. Fixed noise parameter settings will be displayed. It can be set by the touch screen keyboard or the front panel keypad.

Note: If the power sensor does not have a "fixed noise" mode, this option will

not be displayed in the drop down box.

2.7.1.10 Logging

The default is "Off" . Click the slide switch to switch the logging.

- On: The source will record the measurements and save it in a log file.
- Off: The signal source does not record the measurements.

2.7.2 Level Control



As shown in the example, the sensor measures a proportional power in defined time intervals, derived from a coupler. It considers optionally the given S-parameters and returns the results to the generator. The signal generator compares the measured level with the set value and adjusts its output level accordingly. This allows you to control the external signal level continuously and reliably reach a constant input level at the DUT in real time.

In practice, an RF splitter is needed to split the RF signal. One of them is connected to the DUT and the other is connected to the power meter. The signal source is for

acquisition and compensation. Power compensation can be used to minimize cable losses, the attenuation of passive networks, and the amplification of the signal by a power amplifier and the frequency response of each device in the link as the frequency changes.

Note: When the function is turned on, the frequency or level sweep and the power sensor measurement function will be turned off, and vice versa.

2.7.2.1 Sensor State

The default is "off" . Activate/deactivate level measurement by the power sensor.

- On: Turn on the power sensor level control function, and the measurement control refreshes the power sensor measurement value in real time.
- Off: Turn off the power sensor measurement function.

2.7.2.2 Measurement

Indicate the current reading of the sensor. Select the unit used for result display.

You can change the unit for the results display: dBm, dB μ V, μ V, mV, V, nW, μ W, mW, W.

2.7.2.3 Target Level

Specify the nominal level expected at the input of the sensor. The signal generator adjusts the output power accordingly, in order to meet the target value at the sensor input, and thus the power required at the DUT.

The value can be set by the touch screen keyboard or the front panel keypad.

2.7.2.4 Level Limit

Set an upper limit for the RF output power to protect your DUT from damage due to high input power. If the input RF signal power exceeds the limit, the set value will not take effect and the source will pop up a warning message.

2.7.2.5 Capture Range

The capture range means that if the power sensor reading is within the effective capture range, it is a valid reading and the RF signal is adjusted and compensated.

Set the capture range of the control system. If the power sensor reading exceeds this range, the reading will be ignored.

Effective Capture Range = Target Level +/- Catch Range

2.8 I/Q Modulation

I/Q modulation, i.e. two orthogonal signals (carriers with the same frequency, phase difference of 90°, generally expressed by Sin and Cos) and I (In-Phase, in-phase component) and Q (Quadrature Phase) signals are respectively modulated by carrier and transmitted together, thereby improving spectrum utilization.

Note: Only some models are equipped with IQ modulation function. For specific models, please refer to the SSG5000X data sheet.

2.8.1 Custom

Press **I/Q**-> **Custom** to set the Custom modulation.

2.8.1.1 Custom State

Turn on or off the Custom modulation.

2.8.1.2 Data Source

Data Source panel sets parameters for symbol data that to be modulated.

1. Data Setup

Select a data source type for modulation.

Choices: PN7 | PN9 | PN15 | PN23 | User. Default: PN7.





- PN7 | PN9 | PN15 | PN23

When selecting “PN7 | PN9 | PN15 | PN23” as data source type, software generates data source bit automatically.

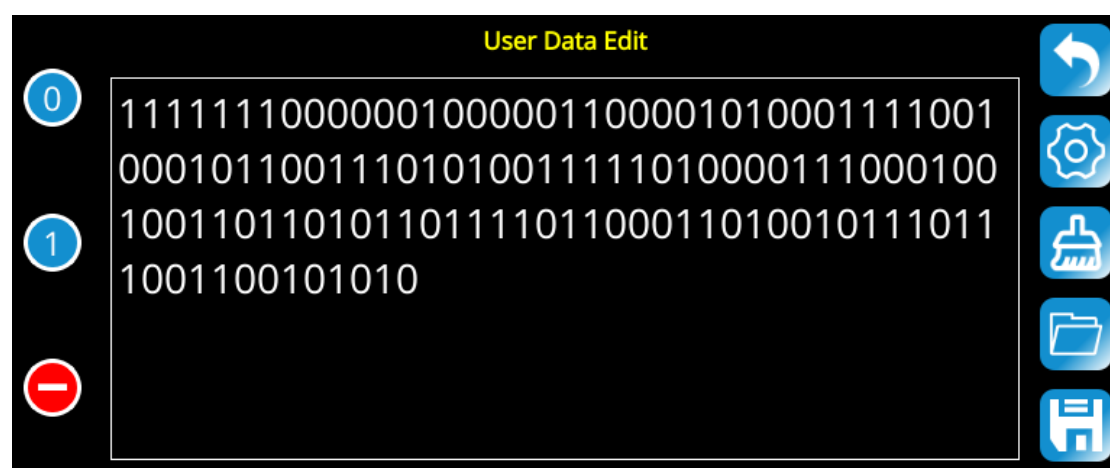
- User

When selecting “User” as data source type, the “User Data” button appears for data bits editing.



You can input 0|1 in the input box manually or insert PN7|PN9|PN15 data bits by pressing  button. And you can also save the data to a new file by pressing  button and recall data from an existing file by pressing  button. Use  button to clear the data edit box.

2. Symbol Rate

Set the symbol rate (symbols per second) of the waveform.

Range: (1000/Oversampling) to (240000000/Oversampling) Symbols/second.

Default: 1000000 Symbols/second.

3. Symbol Length

Set the length of modulated symbols.

Range: 100 to 100000.

Default: 512.

4. Bits/Symbol

Display the number of bits contained in one modulated symbol. It is read only, not settable.

2.8.1.3 Modulation

Modulation panel sets parameters for user selected modulation type.

Choices: QAM | ASK | PSK | MFSK | User.

Default: QAM.

- **QAM**

Select a type in QAM category for modulation.

Choices: 16QAM | 32QAM | 64QAM | 128QAM | 256QAM | 512QAM. Default: 16QAM.

- **ASK**

Select a type in ASK category for modulation.

Choices: 2ASK | 4ASK | 8ASK | 16ASK. Default: 2ASK.

- **PSK**

Select a type in PSK category for modulation.

Choices: BPSK | QPSK | 8PSK | DBPSK | DQPSK | D8PSK | OQPSK | PI/4-DQPSK | PI/8-D8PSK. Default: BPSK.

- **MFSK**

Select a type in MFSK category for modulation.

Choices: 2FSK | 4FSK | 8FSK | 16FSK | MSK. Default: 2FSK.

FSK Deviation

When selecting 2FSK | 4FSK | 8FSK | 16FSK as current modulation type, FSK Deviation setting is displayed.

Set frequency deviation for FSK modulation in Hz.





Range: 0 to (0.8 * Symbol Rate * Oversampling) Hz.

Default: 600000 Hz.

- **User**

When selecting “User” as modulation type, the “Custom” button appears for custom constellation editing.



- In the custom constellation editing window, you can insert or delete constellation points and edit the IQ data for each constellation point manually.
- You can also recall constellation data from an existing file by pressing  button and save the edited constellation data to a new file by pressing  button. Use  button to restore the default I/Q value (2ASK modulation type).
- You can press  button to display the constellation graphically. And preset the constellation data to a known modulation type first by setting the “Mod Type” , as shown in below picture.

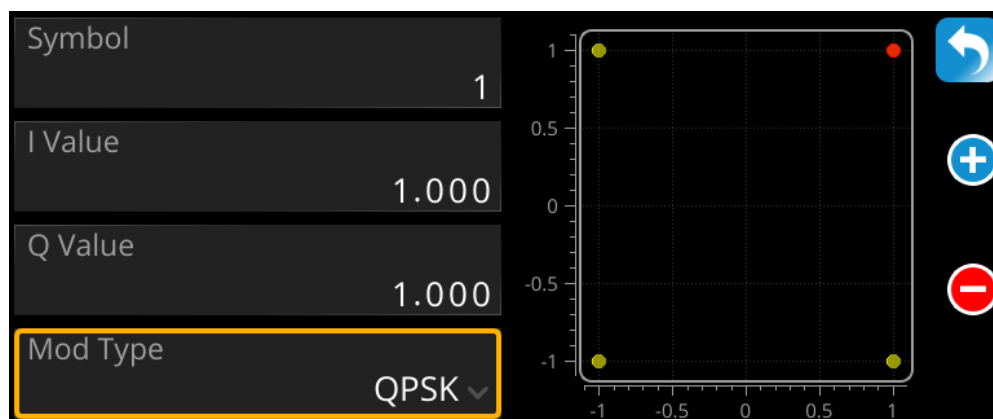

On the left side of the window, it shows the constellation display of current editing.

Note: When editing the constellation points, the number of points must be a value of power of 2, otherwise there will be error message when you click “Update” button.

Gray

Turn ON or OFF the Gray code for the constellation data.

Default: OFF.

2.8.1.4 Filter

Set the filter parameters for current modulation.

1. Filter Type

Set filter type for current modulation.

Choices: RaisedCosine | RootCosine | Gaussian | HalfSine | None.

Default: RootCosine.

Note: For HalfSine filter, only OQPSK modulation type is supported.

2. Filter Alpha/BT

Set the Alpha factor of the filter (BT of Gaussian filter).

Range: 0.01~1.

Default: 0.35.

3. Filter Length

Set length of filter in symbols.

Range: 1~512.

Default: 128.

4. OverSampling

Set the oversampling ratio of the waveform. The waveform Sample Rate is determined based on Symbol Rate and Oversampling ratio.

Range: 2 - 32.

Default: 2.

Note:

For OQPSK modulation, the oversampling must be even.

For HalfSine filter, the oversampling must be more than 8.

2.8.1.5 Update

Regenerate the waveform data based on the current settings.

2.8.1.6 Save Waveform

Save the current settings to a "*.arb" file.

2.8.2 Multitone

Press **I/Q**->**Multitone** to enter multitone mode. Multitone mode supports up to 20 tones.

The highest sampling rate is 300 MHz, and the maximum spectral spacing can be up to 120MHz. Both unilateral spectrum and bilateral spectrum modes are supported.

2.8.2.1 Multitone State

Press **I/Q**->**Multitone**->**Multitone State**, to turn Multitone on or off.

2.8.2.2 Setting Tone Number

Press **I/Q**->**Multitone**->**Tone Number**, to set tone number. The maximum support is 20. The multitone spectrum defaults to exist in pairs. The number set here refers to

the meaning of how many pairs, and is a bilateral spectrum symmetrically distributed on both sides of the center frequency.

2.8.2.3 Sample Rate

Press **I/Q**->**Multitone** ->**Sample Rate** to set multitone sample rate. Support up to 300MHz sampling rate.

2.8.2.4 Freq Spacing

Press **I/Q**->**Multitone**->**Freq Spacing** to set frequency spacing. The frequency spacing here refers to the frequency spacing from the leftmost spectrum to the rightmost spectrum.

2.8.2.5 Single Side

Press **I/Q**->**Multitone**->**Single Side** to turn the unilateral spectrum mode on or off. If the unilateral spectrum mode is turned on, the spectrum of the left half of the multi-tone (left of the center frequency) will be removed.

2.8.2.6 Save State

Press **I/Q**->**Multitone**->**Save State** to save the current settings to a file (The file

extension is '.mulstate') for the next loading.

2.8.2.7 Load State

Press **I/Q**->**Multitone**->**Load State** to load the '.mulstate' file from the hard disk as the current setting parameters.

2.8.3 ARB

2.8.3.1 ARB State

Press **I/Q**->**ARB**->**ARB State** to turn ARB on or off.

2.8.3.2 Select Waveform

Press **I/Q**->**ARB**->**Select Waveform**, to enter the waveform segment and waveform sequence directory, select the waveform segment or sequence that you want to play, and the selected waveform segment or sequence will be highlighted.

- Volatile memory, baseband generator (BBG) media, where waveform files are played from or edited.
- Non-volatile memory, either internal (int) or external(USB) media, where waveform files are stored. However, waveform files stored in non-volatile memory cannot be played directly.

2.8.3.3 Waveform Segment

Press **I/Q**->**ARB**->**Waveform Segment**, to enter the volatile waveform file directory, Waveform segment must reside in volatile storage media before they can be played, edited, or included in a sequence.

1. Load

Load the waveform segment file (*.arb) from the non-volatile memory into the volatile memory, then add the name and point of the waveform segment in the list of waveform segments.

Select waveform segment in **Select Waveform**

- 1) Press **I/Q**->**ARB**->**Select Waveform**, and select a waveform segment.
- 2) Set **ARB State** to on.
- 3) Turn on the I/Q MOD module switch on the main page, or set **MOD ON/OFF** to on.
- 4) Configure the RF OUTPUT.

The waveform segment is now available at the signal generator's **[RF OUTPUT 50Ω]** connector.

2. Save

Save waveform segment, saving waveform file in volatile memory into non-volatile memory. Optionally rename the waveform segment.

3. Delete

Remove the waveform segment from volatile memory. Then you cannot choose to play the waveform segment in **Select Waveform**.

4. Rename

Rename the selected waveform segment.

5. Clear

Clear the files in the waveform segment.

2.8.3.4 Waveform Sequence

Press **I/Q** ->**ARB**->**Waveform Sequence**, to enter the waveform sequence directory, and the current page displays the list of existing waveform sequences.

2.8.3.4.1 About Waveform Sequence

A waveform sequence can contain one or more waveform segments or other waveform sequences, or both. This allows SSG5000X to play multiple waveform segments or sequences continuously without stopping.

A waveform sequence can contain up to 1024 segments, and can also include both segments and other sequences (nested sequences). The signal generator can let you

set the number of times the segments and nested sequences repeat in a waveform

sequence:

- Each segment can repeat up to 65535 times, but only counted as one segment;
- However the repetition of a nested sequence counts as additional segments.

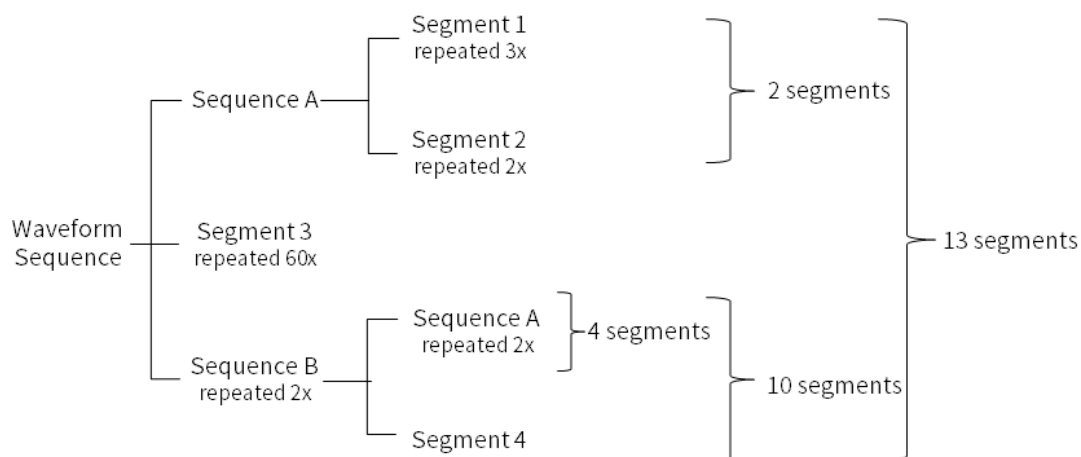

For example, if a waveform sequence contains 24 segments and one nested sequence with 10 segments, the nested sequence can only repeat $(1024-24) / 10 = 100$ times at most.

2.8.3.4.2 Creating a Sequence

In the waveform sequence file directory, the created waveform sequence will be displayed. Users can edit the existing waveform sequence or create a new waveform sequence.

Catalog of SEQ Files

Sequence	Size	Modified
SEQ_TMP	70 B	2018-10-04 06:43:54
test_tmp	72 B	2018-10-04 06:42:54

Build Rename Delete Edit Return >

Press **Build** to create a sequence. All operations of creating a waveform sequence can be realized through the touch screen of the signal generator:

- On the left side, click to add the segment or sequence to the new sequence;
- On the right side, click the "Reps#" value of the segment or sequence to change its repetitions;
- On the right side, click the "Marker" value of the segment or sequence to turn on or off its markers;

Note: only waveform segments in BBG media (volatile memory) will be displayed on the left segment list.

After editing the waveform sequence, click **Save** and then name it to complete the creation of the waveform sequence.

FileName: UNTITLED

Segment	Sequence	Waveform	Reps#	Marker
RAMP_WAVE	SEQ_TMP	WFM:SINE_WAVE	3	1 2 4
SINE_WAVE	test_tmp	WFM:RAMP_WAVE	2	1 4

Delete Insert Clear Save Return >

2.8.3.4.3 Playing a Sequence

After creating a sequence, we can select the sequence to play:

- 1) Press **I/Q** -> **ARB**-> **Select Waveform**, and select a waveform sequence.
- 2) Set **ARB State** to on.
- 3) Turn on the I/Q MOD module switch on the main page, or set **MOD ON/OFF** to on.
- 4) Configure the RF OUTPUT.

The waveform sequence is now available at the signal generator's **[RF OUTPUT 50Ω]** connector.

2.8.3.5 ARB Setup

Press **I/Q** -> **ARB**-> **ARB Setup** to enter the arbitrary waveforms setting interface. The

waveform generator supports a variety of settings for arbitrary waveforms to meet the needs of a wider range of applications.

2.8.3.5.1 Sample Clock

Set the sampling rate of arbitrary waveforms. Range 0.002 Hz ~ 240 MHz, and default is 2 MHz.

2.8.3.5.2 Modulation Atten

Users can adjust the amplitude of I and Q signals before entering the IQ modulator. When the modulator attenuation type is set to manual, the waveform generator can set the appropriate modulator attenuation value to obtain the best ACPR characteristics.

2.8.3.5.3 Real Time AWGN

Press **I/Q** -> **ARB**-> **ARB Setup**-> **Real Time AWGN** to enter the AWGN (Additive White Gaussian Noise) setting interface. Turn on this function, and the built-in internal noise generator will generate an AWGN signal with selectable bandwidth and add it to the baseband signal.

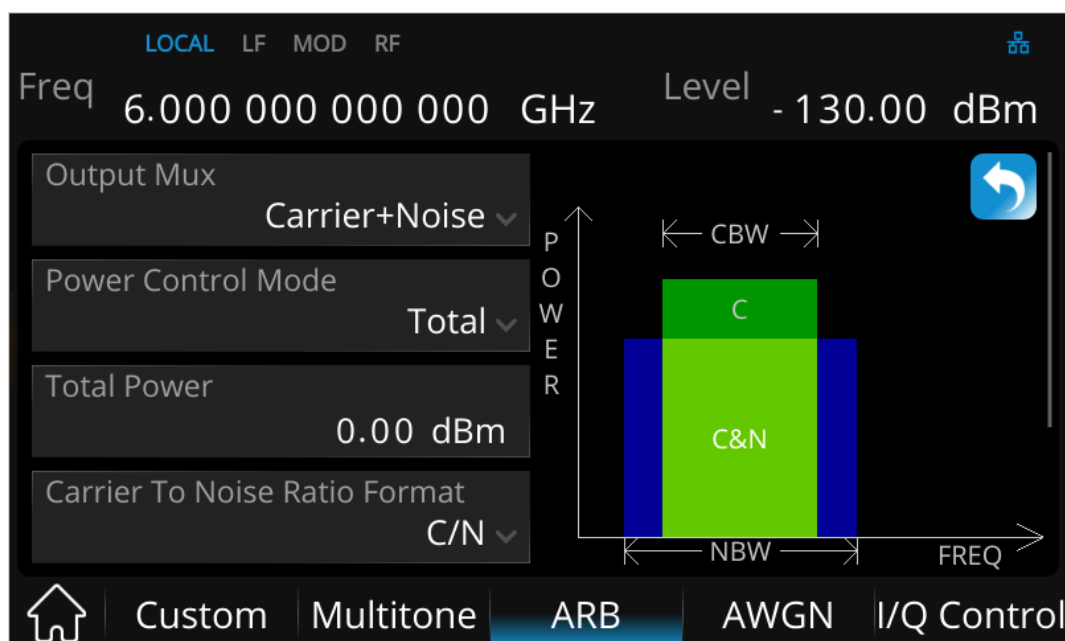

1. Output Mux

Set the RF Output types, including

- Carrier + Noise: both the noise and the carrier are output from the internal baseband generator.
- Carrier: only the Carrier is output from the internal baseband generator.
- Noise: only the additive noise is output from the internal baseband generator.

With the ALC off, this feature enables direct measurement of the carrier or the noise contributions independently from the total power.

2. Power Control

Users can set the power of carrier and noise through the power control menu.

- Total: set the total power, namely the sum of the carrier power and total noise power. The carrier power and total noise power change as any noise parameter is adjusted to keep the total power and the C/N at their last

specified values.

- Carrier: set the carrier power. The total power and total noise power change as any noise parameter is adjusted to keep the carrier power and the C/N at their last specified values.
- Total Noise: set the total noise power. The total power and carrier power change as any noise parameter is adjusted to keep the total noise power and the C/N at their last specified values.
- Channel Noise: set the channel noise power, namely integral power of noise in carrier bandwidth. The total power, carrier power and total noise power change as any noise parameter is adjusted to keep the total noise power and the C/N at their last specified values.

3. Carrier to Noise Ratio Format

This feature allows the AWGN C/N to be set using the Eb/No (energy per bit over noise power density at the receiver or signal to noise ratio per bit) form.

Eb/No Carrier Bit Equation:

$$C/N = Eb/No + 10 \log_{10} \frac{\text{bitRate}}{\text{CBW}}$$

4. Carrier Bandwidth

For the selected carrier to noise ratio, the carrier power and the channel noise power are integrated over the carrier bandwidth. Typically, Carrier Bandwidth (CBW)

is the occupied bandwidth of the carrier.

5. Flat Noise Bandwidth

The actual flat noise bandwidth (NBW) should be slightly wider than the carrier bandwidth (typically 1.2 times wider). The occupied bandwidth = (1.25 * the Flat Noise Bandwidth).

2.8.3.5.4 Modulation filter

Set whether the ARB waveform passes through the filter. The optional filter types are RaisedCosine, RootCosine, Gaussian, HalfSine and None, and the default value is None.

This filter is applied as the ARB waveform plays, rather than in the waveform data itself.

2.8.3.5.5 Baseband offset

A frequency offset can be set for the baseband spectrum, and the range is ± 60 MHz.

Common uses for the offset include:

- offset the carrier from any LO feedthrough (carrier signal spur at the carrier frequency)
- sum the baseband signal with external I and Q inputs to create a multicarrier signal

- use the signal generator's I/Q signal as an IF

2.8.3.6 Multi Carrier

This chapter provides the background information on the ARB functionality for generating multi carrier signals and the impact of the settings provided.

Press **IQ**->**ARB**->**Multi Carrier** to enter multi carrier setting.

2.8.3.6.1 About the Multi Carrier

To simulate complex multi carrier scenarios with different baseband signals, the SSG5000X provides the possibility to generate multi carrier waveforms. These waveforms can consist of up to 512 carriers, each modulated by the same or by different user-selectable baseband signal. Complex multi carrier scenarios composed of signals from different digital standards can be created by this function.

Because the multi carrier files are processed by the ARB generator, the composed waveform file must be created before it is loaded to and played by the ARB. The SSG5000X stores the created multi carrier waveform file under user definable name; as with the single carrier waveforms, the used file extension is *.arb, same as the signal carrier waveform. The instrument appends additional information to the

header of the composed waveform file.

While creating a multi carrier waveform, the carrier spacing is adjustable within the total available bandwidth. The total RF bandwidth of the composed multicarrier signal should not exceed the available RF bandwidth (please reference to the data sheet). Each carrier can be separately defined in terms of power, phase and modulated input signal. After all multi carrier processing steps are completed, the instrument calculates the resulting peak and RMS power over the total signal. This value is then written in the waveform file.

2.8.3.6.2 Waveform Name

Click this item to input the current multi carrier name. The default value is "MULTICARRIER".

2.8.3.6.3 Power Reference

Defines the way the individual carriers in a composed multi carrier signal are leveled.

- **Peak:** The individual carriers are leveled based on their peak power and the configured Carrier Gain.

For example a multi carrier signal is composed of two waveform files,

First carrier "Gain" = 0 dB,

Second carrier "Gain" = -3 dB,

In the resulting multi carrier signal, the peak power of the second carrier signal will be 3 dB lower than the peak power of the first carrier signal.

- RMS: The individual carriers are leveled based on their RMS power and the configured Carrier Gain.

For example a multi carrier signal is composed of two waveform files,

First carrier "Gain" = 0 dB

Second carrier "Gain" = -3 dB

In the resulting multi carrier signal, the RMS power of the second carrier signal will be 3 dB lower than the RMS power of the first carrier signal.

2.8.3.6.4 Carrier Table

Click this item to enter the multi carrier table setting interface

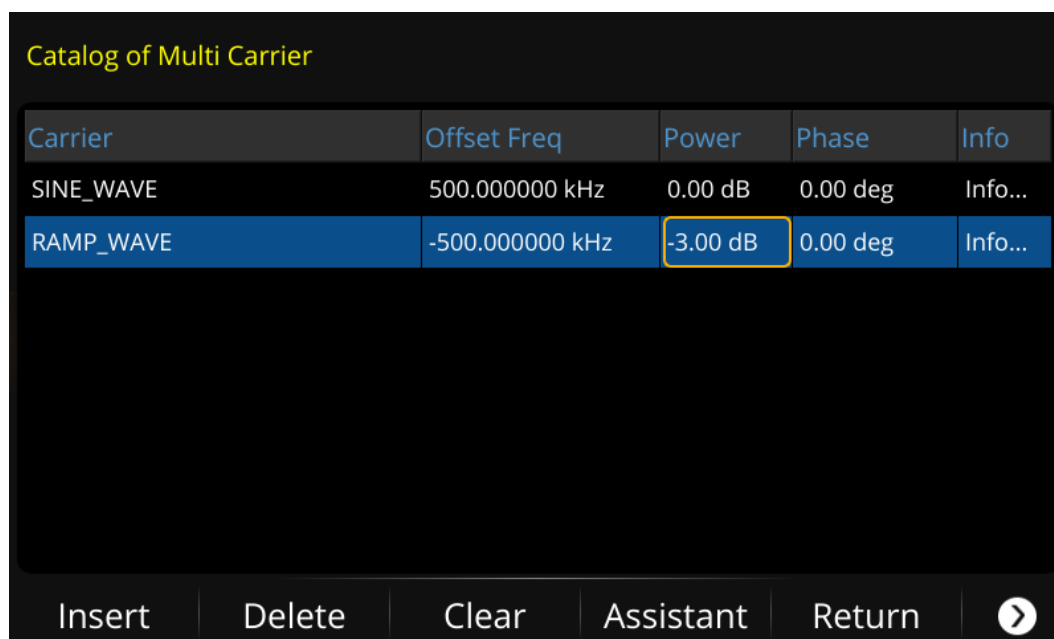

Catalog of Multi Carrier

Carrier	Offset Freq	Power	Phase	Info
SINE_WAVE	500.000000 kHz	0.00 dB	0.00 deg	Info...
RAMP_WAVE	-500.000000 kHz	-3.00 dB	0.00 deg	Info...

Insert Delete Clear Assistant Return >

This page comprises the settings of each carrier, and all the carriers are displayed in table form. The number of rows corresponds to the number of carriers.

Each row of parameters in the table represents the settings of a single carrier:

- 1) Carrier: Set the carrier signal by selecting the corresponding file from the volatile memory
- 2) Offset Freq: Set the offset frequency of the carrier relative to the center frequency
- 3) Power: Set the carrier power gain.
- 4) Phase: Set the carrier phase.
- 5) Info: Indicates the name, sample rate, number of samples, and signal period of the selected carrier.

Functions of each item in the menu bar at the bottom of the page:

- 1) Insert: Insert a carrier file in the next line of the current cursor

-
- 2) Delete: Delete the carrier signal in the line where the current cursor is located from the carrier list.
 - 3) Assistant: Enter the assistant setting menu of carrier list, which is used to generate a list of carriers with fixed carrier signal and equal frequency spacing.
The menu contains the following settings:
 - Select Waveform: Set the carrier signal applied in the carrier list by selecting the corresponding file from the volatile memory.
 - Freq Space: Set the frequency spacing of adjacent carriers.
 - # of Carrier: Set the number of carriers, up to 100.
 - Done: Generate the carrier list according to the setting above, and return to the carrier list setting interface.
 - Return: Press  to return to the previous menu, i.e. carrier table setting interface.
 - 4) Load: Enter the file system directory, select and read the carrier list setting file with the suffix of *. ml previously saved in the device.
 - 5) Save: Enter the file system directory, input the file name, and save the current carrier list setting, so as to read it again when necessary.
 - 6) Return: Return to the previous menu.

2.8.3.6.5 Signal Period Mode

Defines the way the resulting signal period of the multicarrier waveform is calculated. The resulting period is always calculated for all carriers in the carrier table. Use the "Carrier Table > Info" function to obtain information on the sample rate and file length data of each carrier.

- Longest File Wins: The longest I/Q file in the carrier table defines the resulting signal period. Shorter I/Q files are periodically repeated.
- Shortest File Wins: The shortest I/Q file in the carrier table defines the resulting signal period. Only the first part of longer I/Q files is used.
- "LCM": The signal period is defined by the least common multiple of the periods of all waveform files in the carrier table.
- "User": The signal period is set manually (Signal Period). Shorter I/Q files are repeated periodically, and only the first part of longer I/Q files is used.

2.8.3.6.6 Signal Period

This item is only displayed when the "Signal Period Mode" is set to "User". Click this item to manually set the signal period of current multi carrier.

2.8.3.6.7 Sampling Rate

The item displays the sampling rate of the current multi carrier signal according to the waveform setting in the carrier table.

2.8.3.6.8 Create and Load

Click this item, the current multicarrier will be created and loaded into the volatile memory according to the set waveform name, and the multicarrier will be played automatically.

2.8.3.6.9 Multi carrier creation process

To create a multicarrier waveform file, follow these steps:

- 1) Enter the "Carrier Table", add each carrier as required, and configure the frequency, power, phase and other parameters of carriers. You can also use the "Assistant" settings function to add multiple carriers to the carrier list at a time.
- 2) Set the "signal period" and "power reference" of the multicarrier signal to be generated.
- 3) Name the new multicarrier in "waveform name".
- 4) Finally, click "Create and Load" to add the new multi carrier to the volatile

memory and start playing.

2.8.3.7 Marker Utilities

This chapter introduces the concept and usage of waveform marker.

Press **I/Q**->**ARB**->**Marker Utilities** to enter marker setting menu.

2.8.3.7.1 About the Waveform Marker

SSG5000X provides four waveform markers to mark specific points on a waveform segment. You can set each marker's polarity and marked points (on a single sample point or over a range of sample points). When the signal generator encounters an enabled marker, an auxiliary signal is routed to the rear panel **[IQ_EVENT]** output.

You can use an auxiliary output signal to synchronize another instrument with the waveform, or as a trigger signal to start a measurement at a given point on a waveform. You can also configure markers to initiate RF Blanking.

2.8.3.7.2 Marker Number

Click this item to set the waveform marker being operated. There are "1" ,

"2" , "3" and "4" four markers for selecting.

2.8.3.7.3 Output Mux

Click this item to select the marker to be output, and the [IQ_EVENT] connector on the rear panel will output the corresponding pulse signal according to the currently selected marker and related settings.

2.8.3.7.4 Marker Polarity

The default value is "Negative". Click the drop-down box to switch the polarity of the marker.

- Positive: the high level (3.3V) signal is output during the on marker points, and the low level (0V) signal is output during the off marker points.
- Negative: the low level (0V) signal is output during the on marker points, and the high level (3.3V) signal is output during the off marker points.

2.8.3.7.5 Pulse/RF Blank

When this option is turned on, the signal generator blanks the RF output when the marker signal goes low. The following figures show two examples to

illustrate the influence of blanking on RF output signal when the polarity of marker is positive and negative respectively.

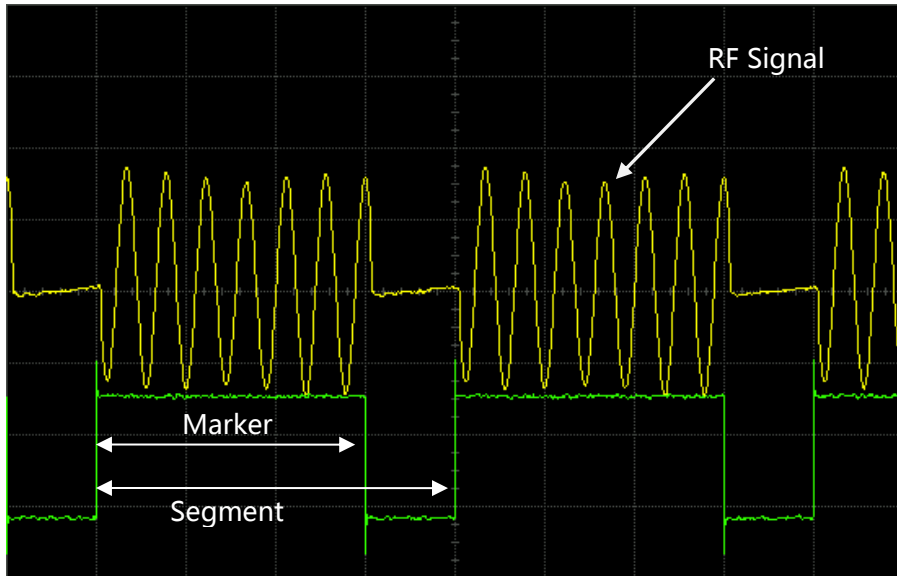

Marker Polarity = Positive

When marker polarity is positive, the RF output is blanked during the *off* marker points.

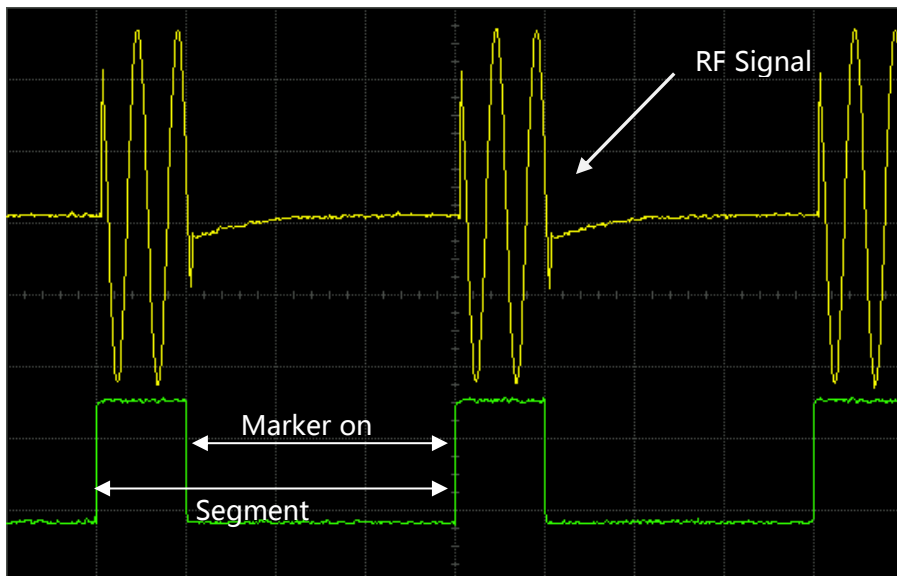

Marker Polarity = Negative

When marker polarity is negative, the RF output is blanked during the *on* marker points.

2.8.3.7.6 Marker Delay

Click this item to set the delay time of pulse signal output by the [IQ_EVENT] connector relative to RF signal.

The delay range is -4000 ns to 860 us, and default value is 0 us.

2.8.3.7.7 Set Markers

Click this item to enter the marker setting interface.

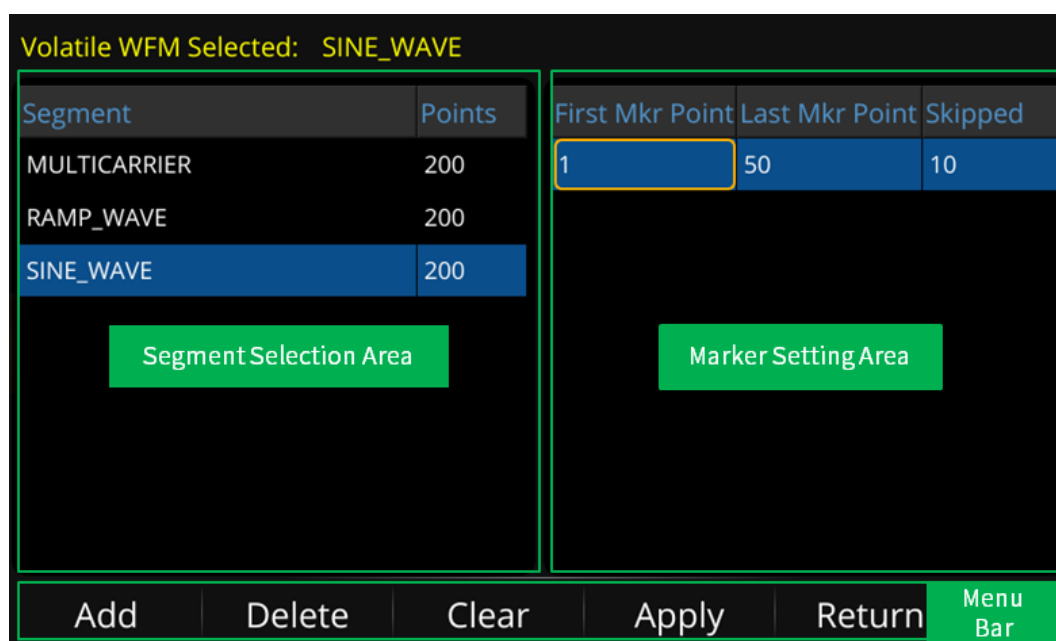

As shown in above figure, the marker setting page is composed of waveform segment selection area, marker setting area and menu bar.

Waveform Segment Selection Area

The waveform segment selection area lists all waveform segments in the current volatile memory and their corresponding sampling points. Select a segment to set the marker points in the right marker setting area.

Marker Setting Area

In the marker setting area, each row of parameters in the table represents the marker settings of a segment:

- **First Mkr Point:** Set the sample point corresponding to the first marker point of the segment.
- **Last Mkr Point:** Set the sample point corresponding to the last marker point of the segment (the last marker point should always be less than or equal to the number of points in the segment, and greater than or equal to the first marker point).
- **Skipped:** Set the number of sample points you want to skip, so that only one sample point will be output every corresponding number of sample points in the segment.

When marker points are set, they do not replace points that already exist, but are set in addition to existing points. For example, set the marker point range of a segment to 1-30, and then add a marker point range of 20-50. The marker signal consisting of these two marker point ranges starts on sample point 1, and ends at on sample point 50.

Menu Bar

Functions of each item in the menu bar at the bottom of the page:

- Add: Insert a marker point range in the next line where the current cursor is located.
- Delete: Delete the marker point range in the line where the current cursor is located.
- Clear: Clear all the marker points from a waveform segment.
- Apply: Make the current marker points setting of a segment effective.
- Display: Click to view the marker signal diagram.
- Return: Return to the previous menu.

The marker signal diagram showed as below:

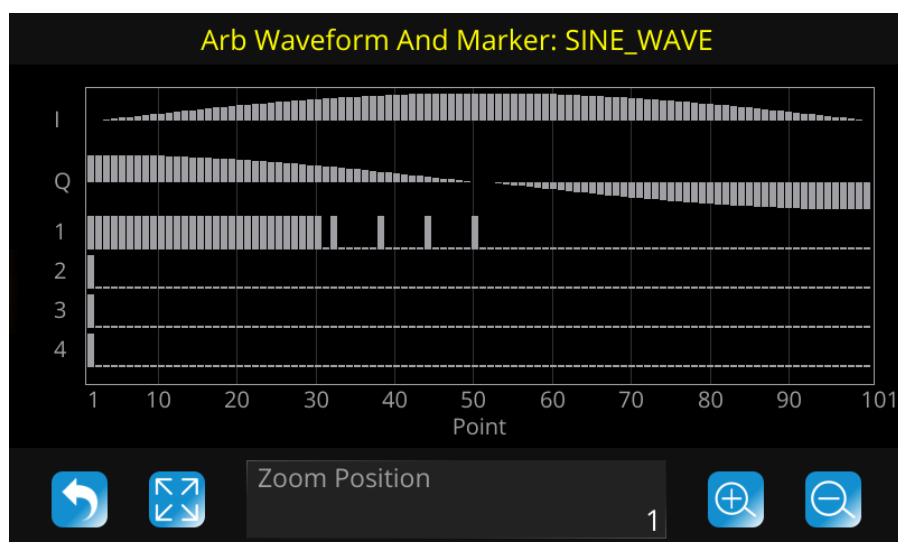

As shown, this page consists of the upper plot area and the lower control area:

- 1) Plot area: The marker signal diagram generated according to the current waveform segment and its marker point range.

"I" and "Q" on the right side of Y axis represent the output waveforms of I and Q of the currently selected waveform segment. "1", "2", "3" and "4" represent four marker signals.

The horizontal direction of the schematic diagram represents the sample point and marker point of the waveform segment, and the vertical direction represents the power level of the output signal.



2) Control area:

Click the  button to return to the previous marker point setting page;

Click the  button to resume the diagram to the initial state;

Click the  button to zoom in the diagram;

Click the  button to zoom out the diagram;

The "Zoom Position" parameter control displays the start position of the diagram, and the operations of  and  buttons are based on this position.

2.8.3.8 Waveform Utilities

Press **I/Q** -> **ARB** -> **Waveform Utilities** to enter the waveform utilities setting menu.

2.8.3.8.1 Select Segment

Select the waveform segment for scaling or peak clipping the I and Q data.

2.8.3.8.2 Scaling

Set the amplitude scaling percentage of a waveform segment.

The signal generator uses an interpolation algorithm (sampling between the I/Q data points) when reconstructing a waveform. For common waveforms, this interpolation can cause overshoots, which may create a DAC over-range error condition. This chapter describes how DAC over-range errors occur and how you can use waveform scaling to eliminate these errors.

Although scaling maintains the basic shape of the waveform, excessive scaling can compromise waveform integrity. For example, if the bit resolution becomes too low the waveform becomes corrupted with quantization noise. To achieve maximum accuracy and optimize dynamic range, scale the waveform no more than is required to remove the DAC over-range error.

2.8.3.8.3 Clipping Type

Set the waveform clipping type to circular or rectangular clipping.

The clipping function enables you to reduce peak-to-average power, and consequently spectral regrowth, by clipping the waveform. Clipping limits waveform power peaks by clipping the I and Q data to a selected percentage of its highest peak.

Circular clipping

Circular clipping ($|I+jQ|$ clipping) is applied to the composite I/Q data (I and Q data are equally clipped). The clipping level is constant for all phases of the vector and appears as a circle in the vector representation

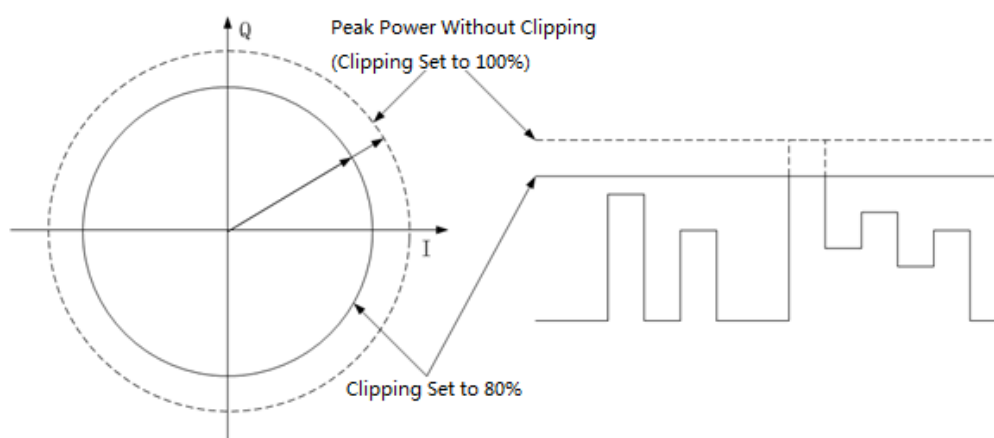

Rectangular clipping

Rectangular clipping ($|I|, |Q|$ clipping) is independently applied to the I and Q data. The clipping level is different for I and Q, and appears as a rectangle in the vector representation.

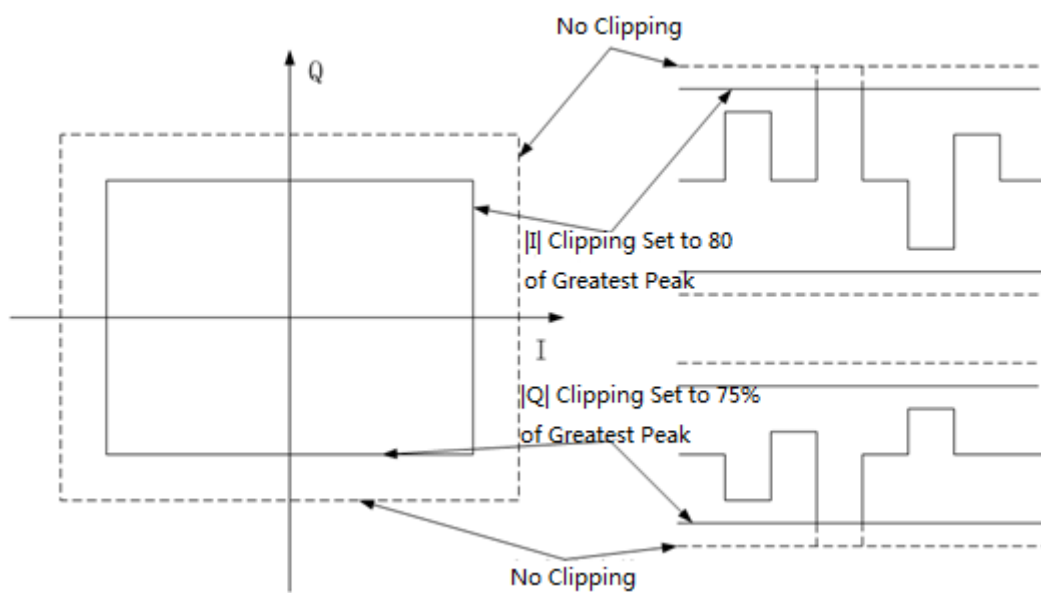

2.8.3.8.4 Clip $|I+jQ|$ to

Set the percentage of I / Q signal value ($\sqrt{I^2 + Q^2}$) reduced to the peak value.

2.8.3.8.5 Clip $|I|$ to

Set I Waveform clipping percentage.

2.8.3.8.6 Clip $|Q|$ to

Set Q Waveform clipping percentage.

2.8.3.8.7 Apply to Waveform

Click the "Apply to Waveform" button to make waveform scaling or clipping effective.

Note: Waveform scaling and clipping are non-reversible. Any data lost in the scaling or clipping operation cannot be restored. Save a copy of the waveform file before scaling or clipping.

2.8.3.8.8 Display CCDF

Click to view the CCDF (Complementary Cumulative Distribution Figure) before and after waveform segment clipping.

The CCDF diagram shows as below:

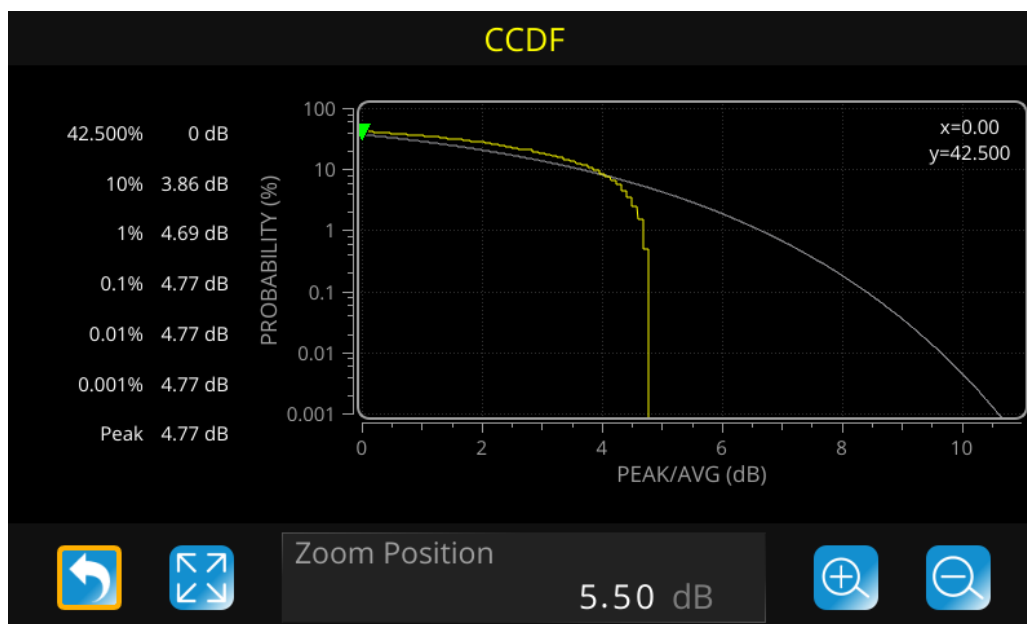

As shown, the page consists of the upper plot area and the lower control area:

- 1) Plot area:

Generate a CCDF waveform diagram based on the selected waveform. The vertical direction represents probability;

The horizontal direction represents a multiple of the relative average power (in dB).

The yellow curve is the current CCDF curve of the selected waveform. And the grey curve is the CCDF reference curve. You can use the zoom feature to observe different details of the waveform.



2) Control area:

Click the  button to return to the previous page;

Click the  button to resume the CCDF to the initial state;

Click the  button to zoom in the diagram;

Click the  button to zoom out the diagram;

The “Zoom Position” parameter control displays the center position of the diagram, and the operations of  and  buttons are based on this position.

2.8.3.9 Trigger

Press **I/Q** → **ARB** → **Trigger** to enter the ARB trigger setting menu.

Triggers control data transmission by controlling when the signal generator transmits the modulating signal.

2.8.3.9.1 Trigger Type

Trigger type defines the trigger mode: how the waveform plays when triggered, and you can set the trigger type to continuous, single, segment advance or ext gated.

- 1) **Continuous:** Continuous mode repeats the waveform until you turn the signal off or select a different waveform, trigger mode, or response (Free Run, Trigger & Run, and Reset & Run).
- 2) **Single:** Single mode plays the waveform once.
- 3) **Segment Advance:** Segment Advance mode plays a segment in a sequence only if triggered. The trigger source controls segment-to-segment playing. A trigger received during the last segment loops play to the first segment in the sequence.
- 4) **Ext Gated:** Ext Gated mode triggers the waveform at the first active triggering state, then repeatedly starts and stops playing the waveform in response to an externally applied gating signal.

2.8.3.9.2 Continuous Mode

The continuous mode can be set to free run, trigger & run or reset & run mode.

- 1) **Free Run:** Immediately triggers and plays the waveform; triggers received while the waveform is playing are ignored.
- 2) **Trigger & Run:** Plays the waveform when a trigger is received; subsequent triggers are ignored.

- 3) **Reset & Run:** Plays the waveform when a trigger is received; subsequent triggers restart the waveform.

2.8.3.9.3 Single Mode

The single mode can be set to no retrigger, buffered trigger or restart on trigger mode.

- 1) **No Retrigger:** Ignores an early trigger received while a waveform is playing.
- 2) **Buffered Trig:** An early trigger received while a waveform is playing waits until the current waveform completes, then plays the waveform once more.
- 3) **Restart on Trig:** An early trigger received while the waveform is playing immediately restarts the waveform.

2.8.3.9.4 Segment Advance Mode

The segment advance mode can be set to single or continuous mode.

- 1) **Single:** A segment in a sequence plays once, ignoring the repetition setting, after which the dual ARB player stops and waits for a trigger before advancing to the next segment. The next segment then plays to completion.

If a trigger is received while a segment is playing, the segment plays to completion. The dual ARB player then advances to the next segment and plays that segment to completion.

- 2) **Continuous:** A segment in a sequence plays continuously until the waveform receives another trigger.

If a trigger is received while a segment is playing, the segment plays to completion.

The dual ARB player then advances to the next segment and plays that segment continuously.

2.8.3.9.5 Ext Gated Mode

The ext gated mode can be set to active high or active low. The waveform stops during the inactive state of the trigger source, and plays during the active state.

2.8.3.9.6 Trigger Source

The trigger source can be set to trigger key, bus, or external.

- 1) **Trigger Key:** Each time the **Trigger** key is pressed, the signal source generates a trigger signal.
- 2) **Bus:** Each time the "*" TRG" command is sent, the signal source generates a trigger signal.
- 3) **Ext:** The signal generator receives the external trigger signal input from the **[PATTERN_TRIG]** connector on the rear panel of the instrument.

Note: in "Free Run" or "Ext Gated" trigger mode, the "Trigger Source" item is

hidden.

2.8.3.9.7 Ext Polarity

The Ext Polarity can be set to positive or negative.

- **Positive:** The signal generator responds during the trigger signal low state.
- **Negative:** The signal generator responds during the trigger signal high state.

Note: In Continuous, Single, and Segment Advance modes, use the “Ext Polarity” item to set the external trigger polarity. In Ext Gated mode, the Active Low and Active High items determine the external trigger polarity.

2.8.3.9.8 Delay Type

When setting external trigger source, users can set the external trigger delay. The delay type can be set to off, time, or sample.

- **Off:** Off trigger delay.
- **Time:** Set the trigger delay based on the delay time.
- **Sample:** Set the trigger delay based on the delay sample.

2.8.3.9.9 Delay Time

Set the time from when the external trigger signal is received until the trigger takes

effect.

2.8.3.9.10 Delay Samples

Set the number of sampling points from the time when the external trigger signal is received until the trigger takes effect, that is

$$\text{delay time} = \text{delay samples} / \text{sample clock.}$$

Note: When the trigger mode is initially selected or when changing from one trigger mode to another, the carrier signal on the RF output may be lost until the modulating signal is triggered. This is because the signal generator sets the I and Q signals to 0 V before the first trigger event.

2.8.3.10 Waveform Header

Press **I/Q**->**ARB**->**Waveform Header** to enter the waveform header setting menu.

2.8.3.10.1 About Waveform Header

For certain waveforms, you can save the settings and parameters of the signal generator in the header file, including the marker settings. When you load the stored waveform file into the BBG storage medium, the header file settings are automatically applied to the signal generator so that set up the signal generator

the same way every time you play a waveform.

The waveform sequence header file takes precedence over the header file of each waveform segment. When the waveform sequence is played, the waveform segment header files are ignored and the waveform sequence header file is automatically loaded into the signal generator.

2.8.3.10.2 Editing a Waveform Header

The editing interface of a waveform header is shown as below.

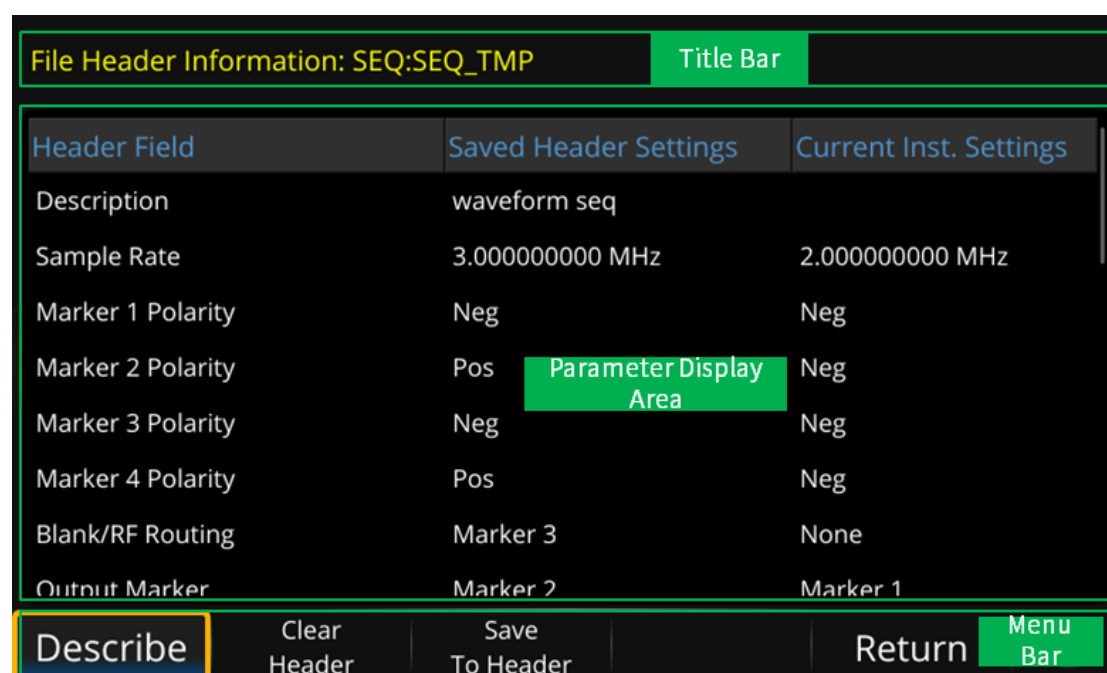

The waveform header editing interface is composed of title bar, parameter display area and menu bar.

Title Bar

Display the currently selected waveform segment or waveform sequence. Press

I/Q->**ARB**->**Select Waveform** to select a segment or sequence to edit its waveform header.

Parameter Display Area

There are three columns parameters in parameter display area.

- Header Field: list all the file header parameters.
- Saved Header Settings: show the header settings saved in the currently selected waveform segment or sequence header file. "Unspecified" means that there is no setting saved for that particular parameter.
- Current Inst. Settings: show the current signal generator settings. The header parameters are in **I/Q**->**ARB**->**ARB Setup** and **I/Q**->**ARB**->**Marker Utilities** menu.

Note: If a setting is unspecified in the header file, the signal generator uses its current value for that setting when you select and play the waveform.

Menu Bar

- Describe: set a description for the waveform header file.
- Clear Header: reset the saved header settings to default settings, that is "Unspecified" .
- Save to Header: save the information in the Current Inst. Settings column to the header file. At this time, the Saved Header Settings column and the Current Inst.

Settings column display the same values.

Note: in order to save the waveform segment header file parameters to non-volatile memory, you need to press **I/Q** -> **ARB** -> **Waveform Segment** and re-save the waveform segment.

2.8.3.11 Waveform File Type

ARB waveform segments can be loaded into three file types: *.arb, *.WDbin and *.txt, which can be copied to the device's non-volatile memory through ftp or U disk.

2.8.3.11.1 arb file

The arb file (*.arb) is generated by the signal generator, or generated by the EasyIQ software.

2.8.3.11.2 WDbin file

A WDbin file (*.WDbin) is a binary file of pure waveform data. The I and Q waveform data are 16-bit complement data and are alternately stored in the file.

	0	1	2	3	4	5	6	7	8	9	a	b	c	d	e	f
00000000h:	0B	00	00	00	2D	00	00	00	65	00	00	00	B3	00	00	00
00000010h:	17	01	00	00	91	01	00	00	20	02	00	00	C4	02	00	00
00000020h:	7D	03	00	00	49	04	00	00	29	05	00	00	1C	06	00	00
00000030h:	21	07	00	00	38	08	00	00	5F	09	00	00	96	0A	00	00
00000040h:	DC	0B	00	00	31	0D	00	00	92	0E	00	00	00	10	00	00
00000050h:	79	11	00	00	FC	12	00	00	88	14	00	00	1C	16	00	00
00000060h:	B7	17	00	00	58	19	00	00	FE	1A	00	00	A7	1C	00	00
00000070h:	53	1E	00	00	00	20	00	00	AC	21	00	00	58	23	00	00
00000080h:	01	25	00	00	A7	26	00	00	48	28	00	00	E3	29	00	00
00000090h:	77	2B	00	00	03	2D	00	00	86	2E	00	00	FF	2F	00	00
000000a0h:	6D	31	00	00	CE	32	00	00	23	34	00	00	69	35	00	00
000000b0h:	A0	36	00	00	C7	37	00	00	DE	38	00	00	E3	39	02	00

2.8.3.11.3 txt file

The txt file (*.txt) is a txt file of pure waveform data. The I and Q waveform data are stored in the file in the form of floating point numbers. I and Q are stored in two columns, I in the first column and Q in the second column.

	0	10	20	30	40
1	-0.0205389568773461			-0.054048280281991	
2	0.137180700094607			-0.228156376842555	
3	0.342570268868068			-0.381725516525773	
4	0.188665425580615			-0.274391918698691	
5	-0.0585955381939146			-0.0303659169286172	
6	-0.0143436994537187			0.0993072298348949	
7	0.0267952513199255			0.248390148625141	
8	-0.131321146275216			0.380596331675161	
9	-0.0983306375316629			0.0823084200567644	
10	0.158116397595141			-0.372020630512406	
11	0.208716086306345			-0.252662739951781	
12	0.146214178899503			0.1293069246498	
13	0.349070711386456			0.0175481429486984	
14	0.555284279915769			-0.277932065797906	

2.8.4 AWGN

Press **I/Q** -> **AWGN** to enter the AWGN setting menu. You can use AWGN (Additive White Gaussian Noise) to modulate the Carrier waveform.

Use the following steps to apply 10 MHz bandwidth noise to a 1 GHz, 0 dBm carrier.

- 1) Press **I/Q** -> **AWGN** -> **Bandwidth** to set the noise bandwidth as 10 MHz.
- 2) Press **I/Q** -> **AWGN** -> **AWGN State** to set the AWGN state on. At the same time, an "AWGN" icon will display on the state bar.
- 3) Turn on the I/Q MOD module switch on the main page, or set **MOD ON/OFF** to on.
- 4) Configure the RF output, and set the Frequency as 1 GHz, set the Amplitude as 0 dBm, set **RF ON/OFF** on.

The carrier with AWGN is now available at the signal generator's **[RF OUTPUT 50Ω]** connector.

2.8.5 I/Q Control

Press **I/Q** -> **I/Q Control** to enter the I/Q Control setting menu. The I/Q Control menu not only enables you to select the I/Q signal source and output, it also provides adjustments and calibrations to compensate for differences in the I and Q signals.

2.8.5.1 I/Q Mod State

Turn on or off the I/Q modulation. When turn on the Custom, Multitone, ARB or AWGN state, the I/Q Mod State will be automatically turned on.

2.8.5.2 I/Q Source

Set the I/Q modulation source to internal or external.

- Internal: Use the internal signal generated by the signal generator as modulation source.
- External: The signal generator accepts externally supplied analog I and Q signals as modulation sources via the **[I INPUT]** and **[Q INPUT]** connectors on the rear panel.

For example:

1. Connect the I and Q signals to the rear panel connectors.
 - a. Connect an analog I signal to signal generator's rear panel **[I INPUT]**.
 - b. Connect an analog Q signal to the signal generator's rear panel **[Q INPUT]**.
2. Set the signal generator to recognize the rear panel input signals:

Press **I/Q** → **I/Q Control** → **I/Q Source**, and set it as External.
3. Turn on the I/Q Mod State.
4. Configure the RF output:
 - a. Set the carrier frequency.

b. Set the carrier amplitude.

c. Turn the RF output on.

2.8.5.3 Compensation Channel

Set the compensation channel as RF or Output.

- RF: Compensate RF channel of the front panel.
- Output: Compensate the I/Q signal output from the rear panel connectors.

2.8.5.4 I/Q Adjustment

Use the I/Q Adjustments to compensate for or add impairments to the I/Q signal.

This adjustment is only used for RF output.

1) Gain Balance.

Adjust the I signal amplitude relative to the Q signal amplitude. And use it as an internal channel image optimization.

2) I Offset

Adjust the DC bias level of I+ and I- baseband signals. Unit: %. Range: $\pm 50\%$.

3) Q Offset

Adjust the DC bias level of Q+ and Q- baseband signals. Unit: %. Range: $\pm 50\%$.

Users can adjust I Offset and Q offset alternately to optimize LO leakage.

4) Quadrature Angle Adjustment

Offset the phase of the Q signal relative to the phase of the I signal. The baseband quadrature adjustment key is calibrated in units of degrees. This can optimize the image leakage.

2.8.5.5 I/Q Output

This adjustment is only applied to the I and Q signal on the rear panel output.

1) I/Q Output Atten

Set the I and Q signal attenuation on the rear panel output. I and Q signals will be attenuated at the same time.

Range: 0-20 dB.

2) I/Q Output Gain Balance

Adjust I signal amplitude or Q signal amplitude. Range: ± 4 dB.

When the setting value is positive, the I signal is attenuated, and when the setting value is negative, the Q signal is attenuated.

3) I Output Offset

This adjusts the DC offset level of the I+ and I- output signal. I+ and I- cannot be adjusted independently.

4) Q Output Offset

This adjusts the DC offset level of the Q+ and Q- output signal. Q+ and Q- cannot be adjusted independently.

5) I/Q Common Offset

Adjust the DC offset of both I and Q signals simultaneously.

2.8.5.6 I/Q Swap

Turning on the I/Q Swap state, the analog I and Q signals output from the rear panel are interchanged, and the I and Q signals modulating the carrier are interchanged.

2.9 Shortcut Keys

2.9.1 PRESET

Recall the preset setting and restore the signal generator to a specified status.

- Press **UTILITY** -> **Setting** -> **Preset Type** to select "Default" or "User" .
- Press **PRESET** to load the factory settings listed in the following table or User-defined settings.

Table 2-3 Default setting

Parameter	Default
RF	
RF State	Off
Frequency	
Frequency	6 GHz
Freq Offset	0 Hz
Phase Offset	0 deg
Level	
Level	-130 dBm
Level Offset	0 dB
ALC State	Auto
Flatness	Off
Sweep	

Sweep State	Off
Sweep Mode	Continuous
Direction	Up
Trigger Mode	Auto
Point Trigger	Auto
Trigger Slope	Positive
Step Sweep	
Step Sweep State	On
Start Freq	6 GHz
Stop Freq	6 GHz
Start Level	-130dBm
Stop Level	-130dBm
Sweep Points	11
Dwell Time	30 ms
Sweep Space	Linear
Sweep Shape	Sawtooth
List Sweep	
List Sweep State	Off
ANALOG MOD	
ANALOG MOD State	Off
AM	

AM State	Off
AM Source	Int
AM Shape	Sine
AM Rate	1 kHz
AM Depth	50 %
FM	
FM State	Off
FM Source	Int
FM Shape	Sine
FM Deviation	100 kHz
FM Rate	10 kHz
PM	
PM State	Off
PM Source	Int
PM Shape	Sine
PM Rate	10 kHz
PM Deviation	1 rad
Pulse	
Pulse State	Off
Pulse Source	Int
Pulse Mode	Single

Pulse Period	10 ms
Pulse Width	2 ms
Double Pulse Delay	4 ms
#2 Width	2 ms
Trigger Out	On
Pulse Trigger	Auto
Trig Delay	140 ns
Trig Slop	Positive
Pulse Polarity	Normal
Pulse Out	Off
Trig Polarity	Normal
Pulse Train	Off
LF Source	
LF State	Off
LF Shape	Sine
LF Frequency	1 kHz
LF Level	500 mV
LF Offset	0 uV
LF Phase	0 deg
LF Sweep	
Sweep State	Off

Start Freq	500 Hz
Stop Freq	1.5 kHz
Center Freq	1 kHz
Freq Span	1 kHz
Sweep Time	1 s
Trigger Mode	Auto
Sweep Shape	Sawtooth
Trigger Mode	Linear
Direction	Up
IQ MOD	
IQ MOD State	Off
Custom	
Custom State	Off
Data Setup	PN7
Symbol Rate	1 MSps
Symbol Length	512
Bits/Symbol	4
Mod Type	16QAM
Gray	Off
Filter Type	RootCosine
Filter Alpha	0.35

Filter Length	128
Oversampling	2
Multitone	
Multitone State	Off
Tone Number	2
Single Side	Off
Sample Rate	2 MHz
Freq Spacing	1 MHz
ARB	
ARB State	Off
Select Waveform	*NONE
ARB Setup	
Sample Clock	2 MHz
Modulator Atten Type	Auto
Modulation Atten	6 dB
Real Time AWGN	Off
Output Mux	Carrier+Noise
Power Control Mode	Total
Total Power	0 dBm
Carrier to Noise Ratio Format	C/N
Carrier to Noise Ratio	0 dB

Carrier Bandwidth	1 Hz
Flat Noise Bandwidth	1 Hz
Filter Type	None
Baseband Offset	Off
Multi Carrier	
Waveform Name	MULTICARRIER
Power Reference	Peak
Carrier Table	SINE_WAVE,0,0,0
Signal Period Mode	LCM
Signal Period	100 us
Sampling Rate	2 MHz
Marker Utilities	
Marker Number	1
Output Mux	1
Marker Polarity	Negative
Pulse/RF Blank	Off
Marker Delay	0 us
Set Markers	1,1,0
Waveform Utilities	
Select Segment	*NONE
Scaling	100 %

Clipping Type	$ I+jQ $
Clip $ I+jQ $ to	100 %
Trigger	
Trigger Type	Continuous
Continuous Mode	Free Run
AWGN	
AWGN State	Off
Bandwidth	10 MHz
I/Q Control	
I/Q Mod State	Off
I/Q Source	Internal
Compensation Channel	RF
I/Q Adjustment	On
Gain Balance	0 dB
I Offset	0 %
Q Offset	0 %
Quad Angle Adjustment	0 deg
I/Q Swap	Off
I/Q Output	Off
I/Q Output Atten	0 dB
I/Q Output Gain Balance	0 dB

I Output Offset	0 mV
Q Output Offset	0 mV
I/Q Common Offset	0 mV

2.9.2 Home

Return to the home page.

2.9.3 Trigger

When the trigger mode of the sweep is Key, press this key once to trigger a sweep.

When the trigger mode of the pulse is Key, press this key once to start a pulse modulation.

When the trigger mode of the LF sweep is Key, press this key once to trigger a LF sweep.

When the trigger source of the IQ modulation is Key, press this key once to trigger an IQ modulation.

2.9.4 ESC/Close

Switch off the instrument from remote control to manual control.

Quit the edit mode, if the edit mode is active.

In dialog boxes that contain an "Esc" button it closes the dialog box.

Exit the current menu and return to the previous menu.

2.9.5 MOD ON/OFF

Enable/disable modulation on the RF output. When enabled, the backlight will light, the screen status bar MOD will change from gray to blue, and RF output modulation will be activated. Press this button again to disable modulation. When disabled, the backlight is off, all modulation is off, and the user interface status bar MOD changes from blue to gray.

2.9.6 RF ON/OFF

Enabled or Disable the RF output. When enabled, the backlight will light, the screen status bar RF will change from gray to blue, and the RF output will be enabled. Press this button again to disable modulation. When disabled, the backlight is off, RF output is off, and the user interface status bar RF changes from blue to gray.

Chapter 3 Application Examples

3.1 Output RF signal

Output a RF signal with a frequency of 3GHz and amplitude of 0dBm from the [RF OUTPUT 50Ω] connector.

1. Restore factory settings

a) Press **UTILITY** or the touch screen to set **UTILITY** -> **Setting** -> **Preset Type**-> **Default**.

b) Press **PRESET**, or press **UTILITY** -> **Preset**.

2. Set the Frequency

Press **FREQ**, and enter the 3GHz with the numeric keypad, or click the frequency on the touch screen to pop up the keypad to input 3GHz.

3. Set the Level

Press **LEVEL**, and enter the 0dBm with the numeric keypad, or click the amplitude on the touch screen to pop up the keypad to input 0dBm on the keypad.

4. Turn on RF output

Press **RF ON/OFF** or press the **HOME** key back to the main interface, select the RF block, the white square on the left of ON to enable RF output. When enabled, the **RF ON/OFF** key backlight turns green and the RF state in the status bar changes to blue.

At this time, the **[RF OUTPUT 50Ω]** connector outputs an RF signal with a frequency of 3 GHz and amplitude of 0 dBm.

3.2 Correcting Line Loss

Users can correct line loss using the Flatness function combined with a power meter.

Connect the **[RF OUTPUT 50Ω]** connector of the SSG to the cable under test, and connect the end of the cable to a power meter. Plug the power meter into the USB port of the SSG and wait for the power meter connection to complete.

1. Restore factory settings

- a) Press **UTILITY** or the touch screen to set **UTILITY** -> **Setting** -> **Preset Type**-> **Default**.
- b) Press **PRESET**, or press **UTILITY** -> **Preset**.

2. Set the Frequency & Level

- a) Press **FREQ**, and enter the 1GHz with the numeric keypad, or click the frequency on the touch screen to pop up the keypad to input 1GHz.
- b) Press **LEVEL**, and enter the 0dBm with the numeric keypad, or click the amplitude on the touch screen to pop up the keypad to input 0dBm on the keypad.

3. Set the frequency of flatness calibration

- a) Press **LEVEL**->**Flatness**->, select the **Fill Type** as "Manual Step" ;
- b) Set the **Start Freq** to 4GHz, **Stop Freq** to 5GHz, **Points** to 11;

4. Perform amplitude calibration

- a) Click "**Fill Flatness with Sensor**" button and a "Collecting" dialog will pop up.

After the data collection is finished, it will automatically return to the flatness list page and give the corrected amplitude correction value for each frequency.

3.3 Output a modulated signal

In this section, we will show how to enable modulation by configuring the SSG to output an AM modulated signal with the following characteristics: Carrier

frequency is 1GHz, the carrier amplitude is -10dBm, the AM modulation depth is 80%, the modulation frequency is 10 kHz, and the modulation waveform is a sine wave.

1. Restore factory settings

- a) Press **UTILITY** or the touch screen to set **System** -> **Setting** -> **Preset Type**-> **Default**.
- b) Press **PRESET** or reset the system settings to perform reset operations.

2. Set the carrier frequency & amplitude

- a) Press **FREQ** and enter 1GHz with the numeric keypad, or click the frequency input box on the touch screen to pop up the keypad to input 1GHz on the keypad.
- b) Press **LEVEL**, type -10 dBm with the digital keyboard, or click on the amplitude input box on the touch screen, pop up the keyboard, and type - 10dBm on the keyboard;

3. Set the AM modulation parameters

Press the **MOD** or click the ANALOG MOD function block on the touchscreen to enter the amplitude modulation parameter setting interface.

- a) Set the modulation waveform to be a sine wave;

- b) Set the modulation depth to 80%;
- c) Set the modulation frequency to be 10 kHz;
- d) Set the AM state open;

4. Enable the RF modulation output

- a) Press **MOD ON/OFF** and then press **RF ON/OFF**. The backlights of **MOD ON/OFF** and **RF ON/OFF** will be illuminated. RF and MOD labels in the status bar will change from gray to blue.

At this time, the signal on the **[RF OUTPUT 50Ω]** connector will match the settings configured above.



3.4 Output a pulse train

A pulse train is a user-defined sequence of high and low RF levels with specific time durations for each part. In this example, we will show how to configure the RF source to output the following pulse train:

Serial number	Positive pulse width	Negative pulse width	Repetitions
1	10ms	30ms	1
2	20ms	20ms	2

-
1. Restore factory settings
 - a) Press **UTILITY** or touch **Preset Type-> Default**.
 - b) Press **PRESET** or reset the system settings to perform the reset operation.

 2. Install the pulse train option
 - a) Activate the pulse train generator option.

 3. Edit pulse list
 - a) Press **MOD** or select ANALOG MOD from the Home page. You can swipe left or right or press **MOD** repeatedly to reach the Pulse Mode screen. Set Pulse Mode to Train, and the Pulse Train menu will appear.
 - b) Click  in Pulse Train menu to enter settings, set the positive width of first pulse to 10ms, the negative width to 30ms, and the count to 1.
 - c) Click the "+" on the left to add one line, set the positive pulse width to 20ms, the negative pulse width to 20ms, and the count to 2.
 - d) After clicking, you can click  on the left side to see the schematic diagram of the pulse train as follows.
-

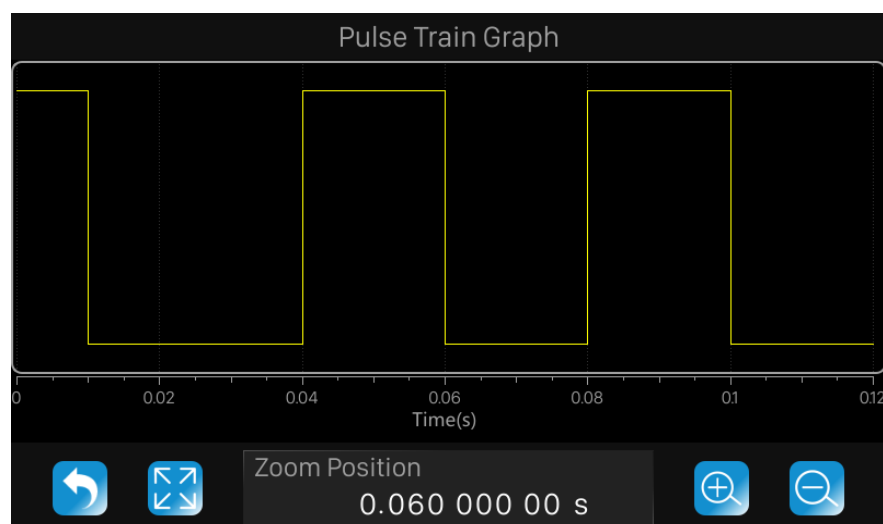

4. Set the **Pulse State** to on.

5. Enable the RF modulation output
 - a) Press **MOD ON/OFF** and then press **RF ON/OFF**. The backlights of **MOD ON/OFF** and **RF ON/OFF** will be illuminated. RF and MOD labels in the status bar will change from gray to blue.

At this time, the signal on the **[RF OUTPUT 50Ω]** connector will match the settings as configured above.

3.5 Output IQ modulated signal in Custom Mode

The following steps describe how to generate an IQ modulated signal with a modulation mode of 32QAM. Users can modify and configure IQ modulation

related parameters according to actual application requirements.

1. Restore factory settings

- a) Press **UTILITY** or touch **Preset Type-> Default**.
- b) Press **PRESET** or reset the system settings to perform the reset operation.

2. Set the baseband signal

Press **I/Q** or select IQ MOD block from the Home page, and then click **Custom**.

- a) Open the **Data Source** setting interface, and set Data Setup to PN9, Symbol Rate to 1MHz, and Symbol Length to 512;
- b) Open the **Modulation** setting interface, and set Mod Type to QAM, QAM Type to 32QAM;
- c) Open the **Filter** setting interface, and set Filter Type to RootCosine, Filter Alpha to 0.35, Filter Length to 128, OverSampling to 2;
- d) Set **Custom State** on;

3. Set the carrier frequency & amplitude

- a) Press **FREQ**, and enter the 1GHz with the numeric keypad, or click the frequency on the touch screen to pop up the keypad to input 1GHz.
- b) Press **LEVEL**, and enter the -10dBm with the numeric keypad, or click the amplitude on the touch screen to pop up the keypad to input -10dBm on the

keypad.

4. Enable the RF modulation output

b) Press **MOD ON/OFF** and then press **RF ON/OFF**. The backlights of **MOD ON/OFF** and **RF ON/OFF** will be illuminated. RF and MOD labels in the status bar will change from gray to blue.

At this time, the **[RF OUTPUT 50Ω]** connector of the SSG outputs an IQ modulation signal with a modulation mode of 32QAM, and the IQ modulation signal is connected to an IQ demodulation device to observe the demodulation characteristics of the IQ modulation signal:

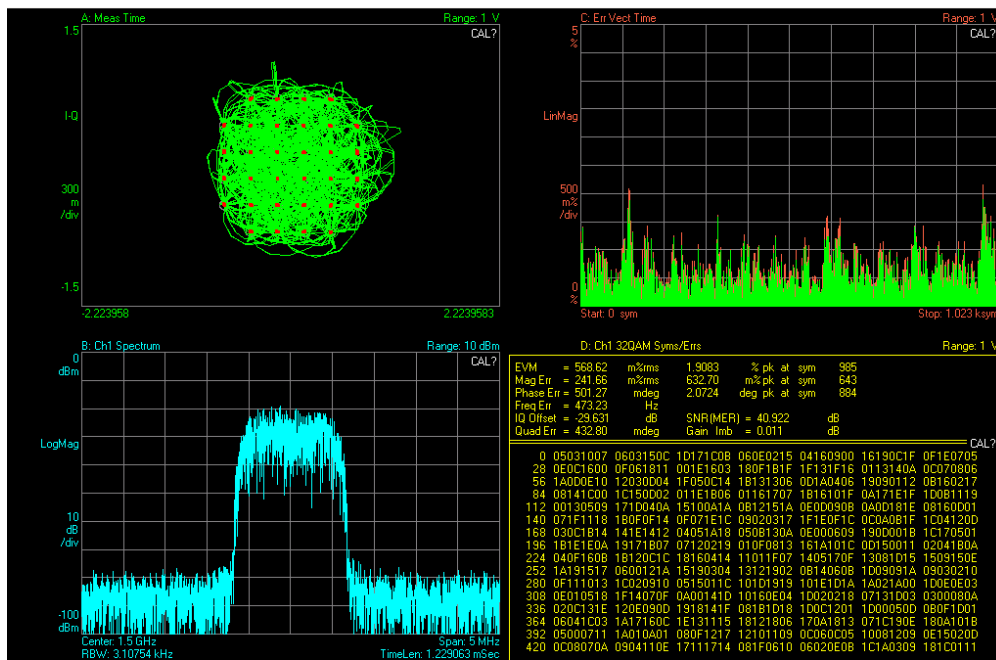

3.6 Test OIP3 of Active Devices in Multitone Mode

OIP3 is a key indicator for evaluating the linearity of active devices. This can be tested using the SSG5000X.

The following steps describe how to generate a two-tone continuous wave signal with a carrier frequency of 3.2 GHz and an interval frequency of 1 MHz to test OIP3 of the active device.

1. Restore factory settings

- a) Press **UTILITY** or touch **Preset Type-> Default**.
- b) Press **PRESET** or reset the system settings to perform the reset operation.

2. Set the baseband signal

Press **I/Q** or select IQ MOD block from the Home page, and then click **Multitone**.

- a) Set Tone Number to 1;
- b) Set Sample Rate to 10 MHz;
- c) Set Freq Spacing to 1 MHz;
- d) Set Single Side state off;
- e) Set Multitone State on;

3. Set the carrier frequency & amplitude

- a) Press **FREQ**, and enter the 3.2 GHz with the numeric keypad, or click the frequency on the touch screen to pop up the keypad to input 3.2 GHz.
 - b) Press **LEVEL**, and enter the -10dBm with the numeric keypad, or click the amplitude on the touch screen to pop up the keypad to input -10dBm on the keypad.
4. Enable the RF modulation output
- a) Press **MOD ON/OFF** and then press **RF ON/OFF**. The backlights of **MOD ON/OFF** and **RF ON/OFF** will be illuminated. RF and MOD labels in the status bar will change from gray to blue.

At this time, the **[RF OUTPUT 50Ω]** connector of the SSG5000X outputs a two-tone continuous wave signal with a carrier frequency of 3.2 GHz and an interval frequency of 1 MHz. The signal is used as the input of the active device, and the output signal is tested to obtain the OIP3 characteristic as shown in the following figure.

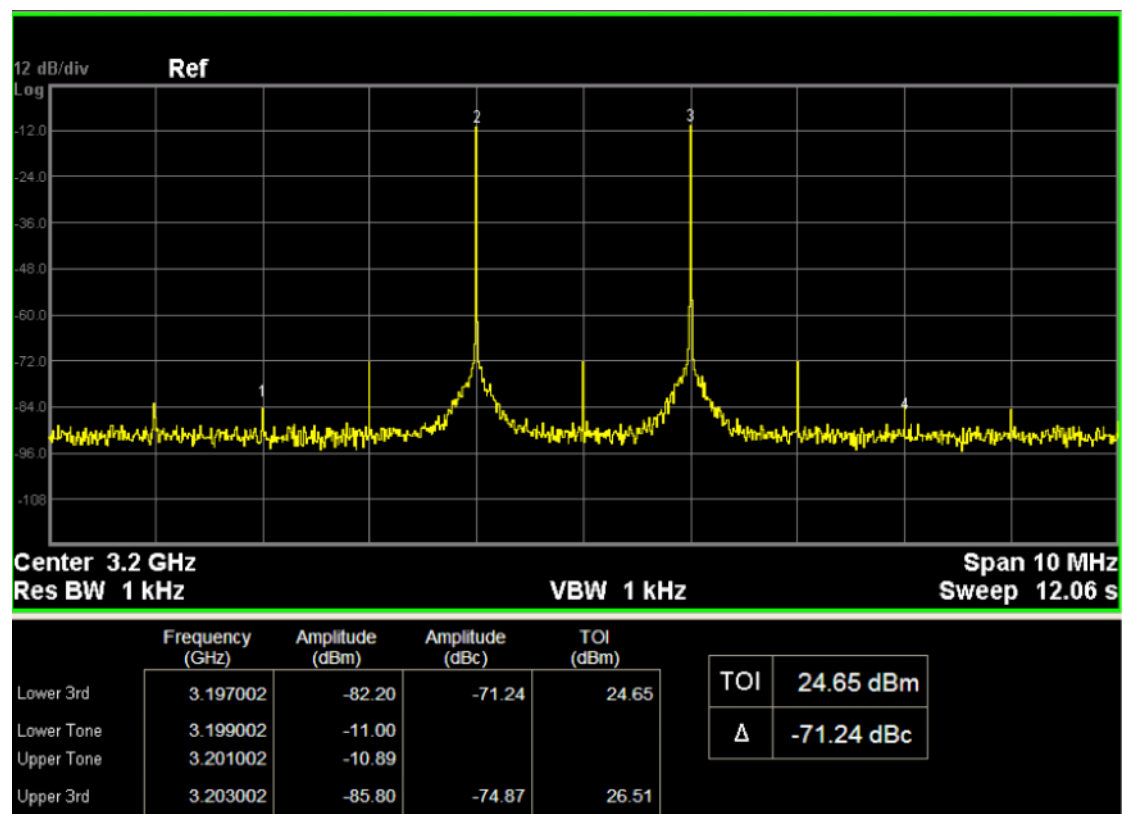

Note: IQ compensation can be performed through **I/Q Control**->**I/Q Adjustment** menu of the SSG. For example, when the IQ modulation signal shows a significant local oscillator leakage, it can be solved by alternately adjusting the Offset of I and Q.

3.7 Play waveform sequence Using ARB Mode

Using the SSG5000X's ARB (arbitrary waveform) mode, you can play waveform sequences.

1. Restore factory settings

- a) Press **UTILITY** or touch **Preset Type-> Default**.
 - b) Press **PRESET** or reset the system settings to perform the reset operation.
2. Create Waveform Sequence
- a) Press **I/Q** -> **ARB** -> **Waveform Sequence**, and then click "Build" button to enter the creating new waveform sequence interface;
 - b) Click the waveform segments "SINE_WAVE" and "RAMP_WAVE" in the Segment list on the left, and you can see that these two waveform segments are added to the waveform sequence list;
 - c) Modify the number of repetitions of SINE_WAVE to 2 and the number of repetitions of RAMP_WAVE "to 3;
 - d) Click "Save" button and save the new sequence as "seq1" .
3. Play Waveform Sequence
- a) Press **I/Q** -> **ARB** -> **Select Waveform**, and select to play the sequence "seq1" ;
 - b) Set **ARB State** on;

At this time, the waveform sequence "seq1" is played. You can return to the main page and click  button in the IQ MOD block to view the played waveform. The waveform currently playing is shown as below:

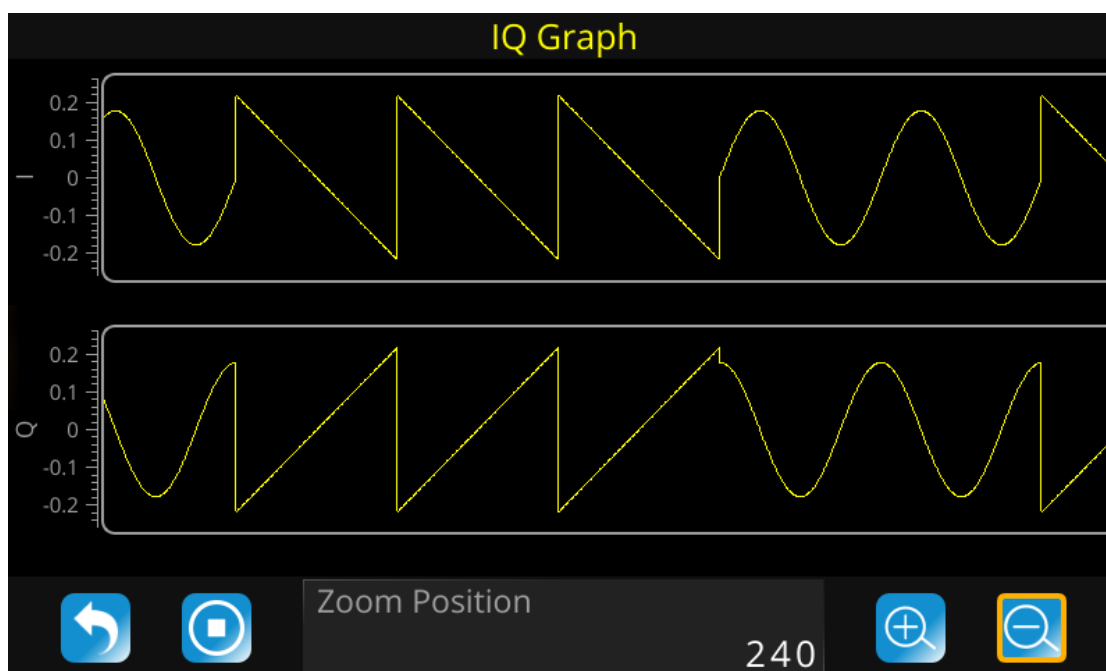

3.8 Add AWGN to Modulated Signal Using ARB Mode

Using the SSG5000X's ARB (arbitrary waveform) mode, you can add Additive White Gaussian Noise (AWGN) to the carrier while modulating the carrier.

1. Restore factory settings
 - a) Press **UTILITY** or the touch screen to set **System** -> **Setting** -> **Preset Type**-> **Default**.
 - b) Press **PRESET** or reset the system settings to perform reset operations.
2. Set the carrier frequency

a) Press **FREQ** and enter 2GHz with the numeric keypad, or click the frequency input box on the touch screen to pop up the keypad to input 2GHz on the keypad.

3. Set the real-time AWGN function

a) Press **I/Q**-> **ARB**-> **ARB Setup**-> **Real Time AWGN** to enter real-time AWGN setting interface;

b) Set the **Output Mux** to "Carrier + Noise", the **Carrier Bandwidth** to 3.84 MHz, the **Flat Noise Bandwidth** to 8 MHz, the **Carrier to Noise Ratio Format** to "C/N", the **Carrier to Noise Ratio** to 34 dB, the **Power Control Mode** to "Total ", and the **Total Power** to -10dBm;

c) Turn on the **Real Time AWGN** state;

4. Play Waveform

a) Press **I/Q**-> **ARB**-> **Select Waveform**, and select "WCDMA_3 DPCH" to play;

b) Turn on **ARB State**.

5. Enable the RF modulation output

a) Press **MOD ON/OFF** and then press **RF ON/OFF**. The backlights of **MOD ON/OFF** and **RF ON/OFF** will be illuminated. RF and MOD labels in the status bar will change from gray to blue.

At this time, connect the [RF OUTPUT 50Ω] connector of the SSG5000X to the spectrum analyzer, set the center frequency to 2 GHz, turn on the trace averaging function, and the spectrum of the modulated wave with Additive White Gaussian Noise is shown below.

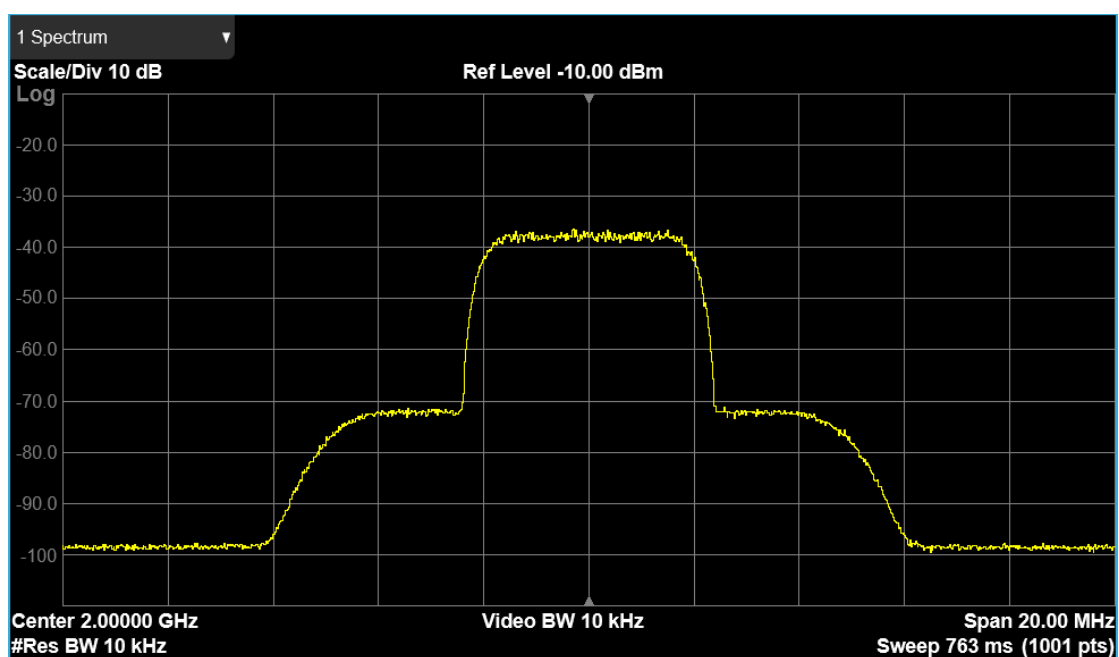

Chapter 4 Programming Overview

The SSG5000X Signal Generator features a LAN, USB Device, and SIGLENT GPIB—USB module interfaces. By using a computer with these interfaces, and a suitable programming language (Python, C+, .NET, etc., and NI-VISA software), users can remotely control the signal generator using standard SCPI (Standard Commands for Programmable Instruments) commands. The SSG5000X Programming Guide features more details on the specific commands.

This chapter introduces how to build communication between the signal generator and a controller computer with these interfaces.

4.1 Remote Operation

The SSG provides both the USB and LAN connection which allows you to set up a remote operation environment with a controller computer. A controller computer could be a personal computer (PC) or a minicomputer. Some intelligent instruments also function as controllers.

4.1.1 Connecting via the USB Device port

Refer to the following steps to finish the connection via USB-Device:

1. For standard installations, you can use NI-VISA on your PC for the VXI driver. If you wish to control the instrument without NI-VISA, use sockets or telnet.
2. Connect the SSG USB Device port to a PC with a USB A-B cable.
3. Switch on the SSG



Figure 4-1 USB Device

The SSG will be detected automatically as a new USB hardware.

4.1.2 Connecting via the LAN port

Refer to the following steps to finish the connection via LAN:

1. Install NI-VISA on your PC for VXI driver. Or without NI-VISA, using socket or telnet in your PC's Operating System.
2. Connect the SSG to PC or the local area network with a LAN cable
3. Switch on the SSG



Figure 4-2 LAN

4. Press button on the front panel **System**→Interface→LAN to enter the LAN Configure function menu.
5. Select the IP Configure between Static and DHCP
 - ◆ DHCP: the DHCP server in the current network will assign the network parameters automatically (IP address, subnet mask, gate way) for the SSG.
 - ◆ Static: you can set the IP address, subnet mask, gate way manually. Press Apply.

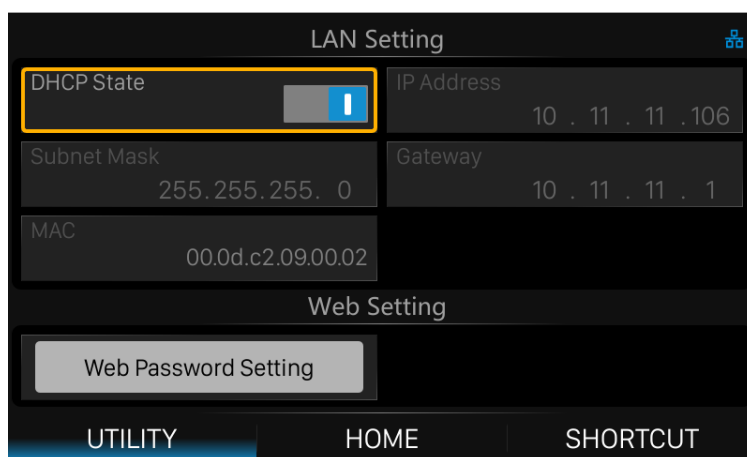

Figure 4-3 LAN Configure

The SSG will be detected automatically or manually as a new LAN point.

4.1.3 GPIB: Connecting via the USB-Host port

Refer to the following steps to finish the connection via USB:

1. Install NI-VISA on your PC for GPIB driver.
2. Connect the SSG USB Host port to a PC's GPIB card port, with SIGLENT USB-GPIB adaptor.

3. Switch on the SSG



Figure 4-4 SIGLENT USB-GPIB Adaptor

4. Press button on the front panel **System** → Interface → GPIB to enter the GPIB number.

The SSG will be detected automatically as a new GPIB point.

4.2 Build Communications

4.2.1 Build Communications Using VISA

NI-VISA includes a Run-Time Engine version and a Full version. The Run-Time Engine version provides NI device drivers such as USB-TMC, VXI, GPIB, etc. The full version includes the Run-Time Engine and a software tool named NI MAX that provides a user interface to control the device.

You can get NI-VISA full version from:

<http://www.ni.com/download/>.

After download you can follow the steps below to install it:

1. Double click the visa_full.exe, dialog shown as below:

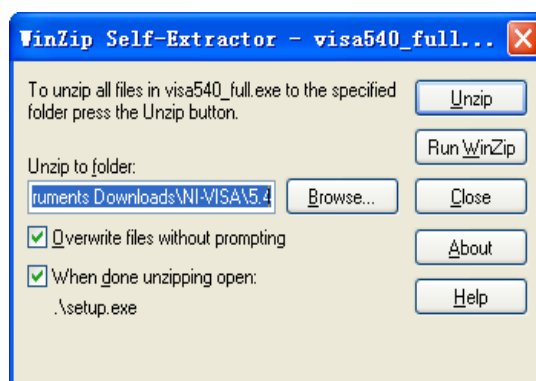

2. Click Unzip, the installation process will automatically launch after unzipping files. If your computer needs to install .NET Framework 4, its setup process will auto start.



3. The NI-VISA installing dialog is shown above. Click Next to start the installation process.

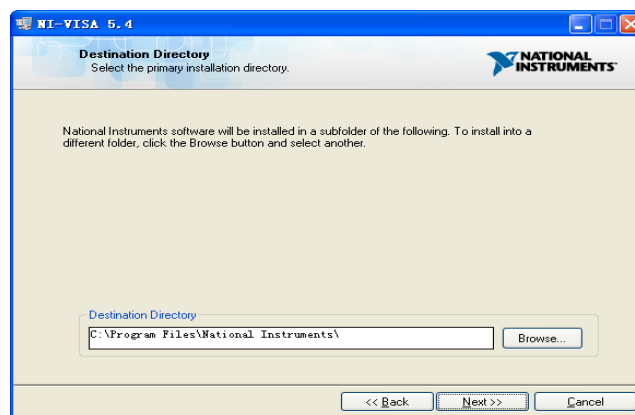

4. Set the install path, default path is "C:\Program Files\National Instruments\" , you can change it. Click Next, dialog shown as above.

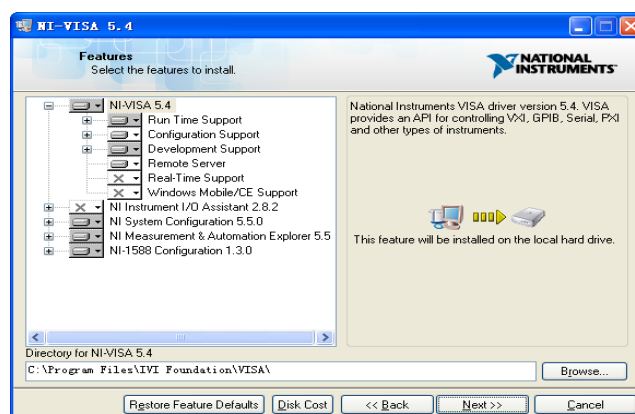

5. Click Next twice, in the License Agreement dialog, select the "I accept the above 2 License Agreement(s)." , and click Next, dialog shown as below:

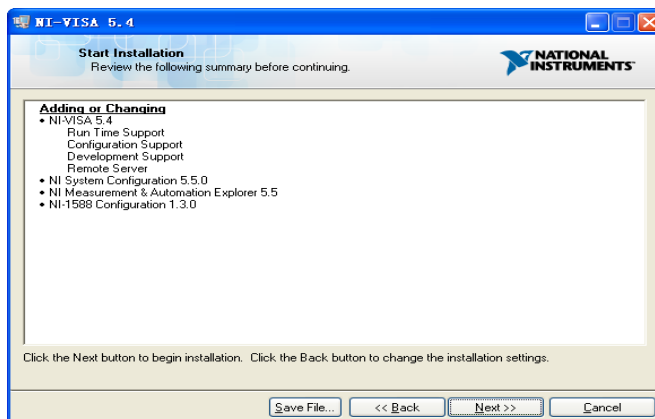

6. Click Next to run installation.

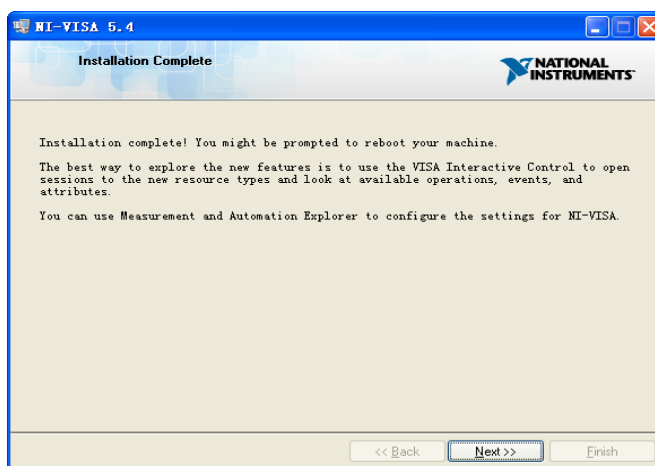

Now the installation is complete, reboot your PC.

4.2.2 Build Communications Using Sockets/Telnet

Through the LAN interface, VXI-11, Sockets and Telnet protocols can be used to communicate with the SSG. VXI-11 is provided in NI-VISA, while Sockets and Telnet are commonly included in the operating system (OS) of many computers.

Socket LAN is a method used to communicate with the signal generator over the LAN interface using the Transmission Control Protocol/Internet Protocol (TCP/IP). A

socket is a fundamental technology used for computer networking and allows applications to communicate using standard mechanisms built into network hardware and operating systems. The method accesses a port on the signal generator from which bidirectional communication with a network computer can be established.

Before you can use sockets LAN, you must select the signal generator's sockets port number to use:

- **Standard mode:** Available on port 5025. Use this port for programming.
- **Telnet mode:** The telnet SCPI service is available on port 5024.

4.3 Remote Control Capabilities

4.3.1 User-defined Programming

Users can use SCPI commands to program and control the signal generator. For details, refer to the introductions in “Programming Guide” .

4.3.2 Send SCPI Commands via NI MAX

Users can control the signal generator remotely by sending SCPI commands via NI-MAX software. NI_MAX is National Instruments Measurement and Automation Explorer. It is an executable program that enables easy communication to troubleshoot issues with instrumentation.

4.3.2.1 Using USB

Run NI MAX software.

1. Click “Device and interface” at the upper left corner of the software;
2. Find the “USBTMC” device symbol



3. Click “Open VISA Test Panel” option button, then the following interface will appear.

- Click the “Input/Output” option button and click the “Query” option button in order to view the operation information.

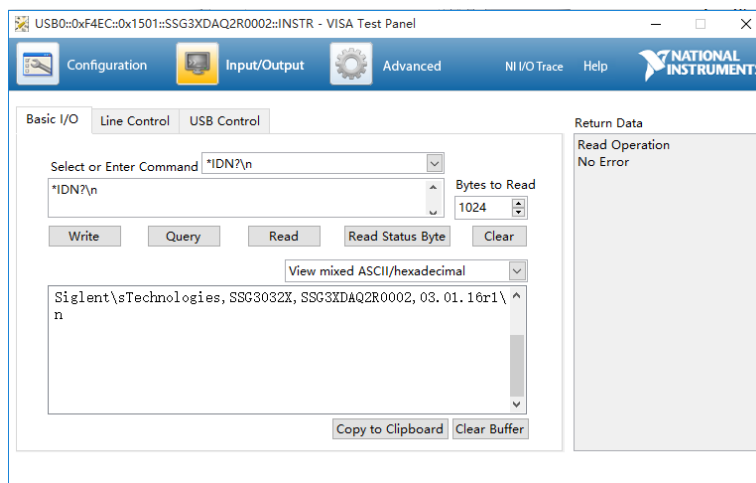

Note: The “*IDN?” command (known as the Identification Query) returns the instrument manufacturer, instrument model, serial number, and other identification information.

4.3.2.2 Using LAN

Select “Add Network Device” , and select “VISA TCP/IP Resource” as shown:

Run NI MAX software.

- Click “Device and interface” at the upper left corner of the software;
- Find the “Network Devices” symbol, click “Add Network Devices” ;

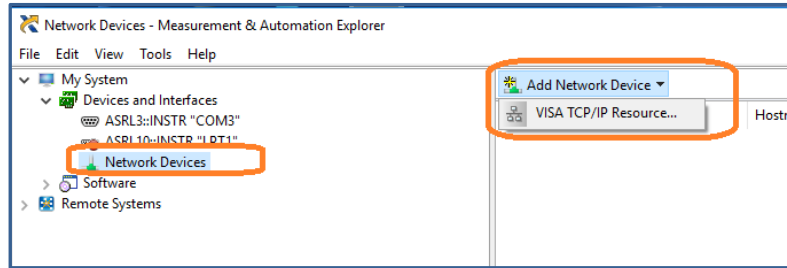

3. Select Manual Entry of LAN instrument, select next, and enter the IP address as shown. Click Finish to establish the connection:

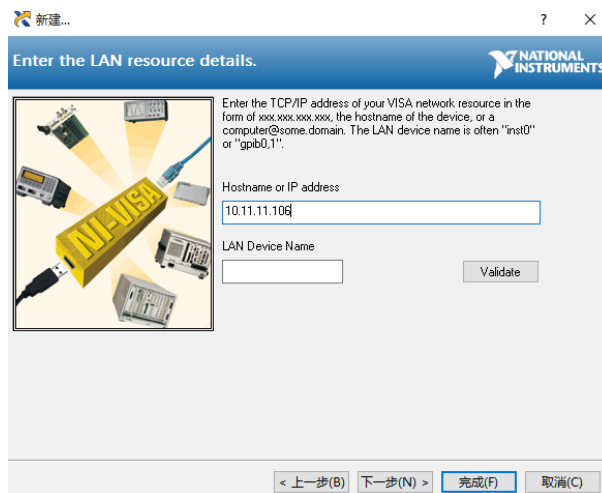
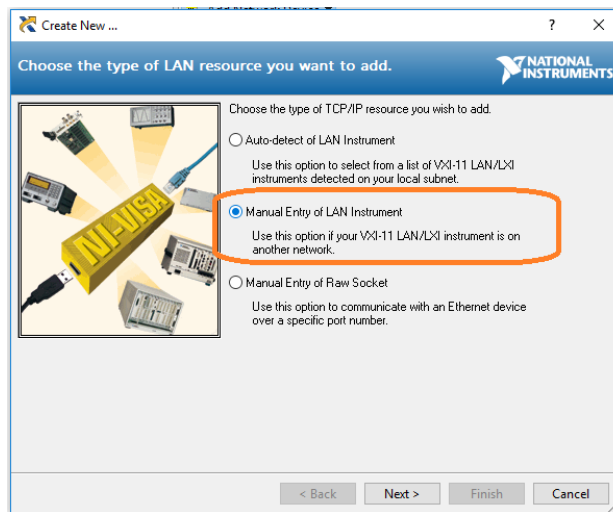

4. After a brief scan, the connection should be shown under Network Devices:



5. Click "Open VISA Test Panel" option button, then the following interface will appear:

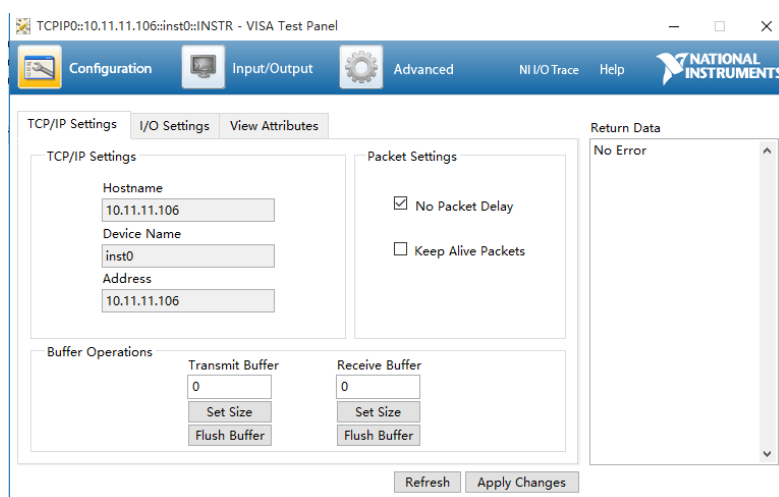

6. Click "Input/Output" option button and click "Query" option button. If everything is OK, you will see the Read operation information returned as shown below.

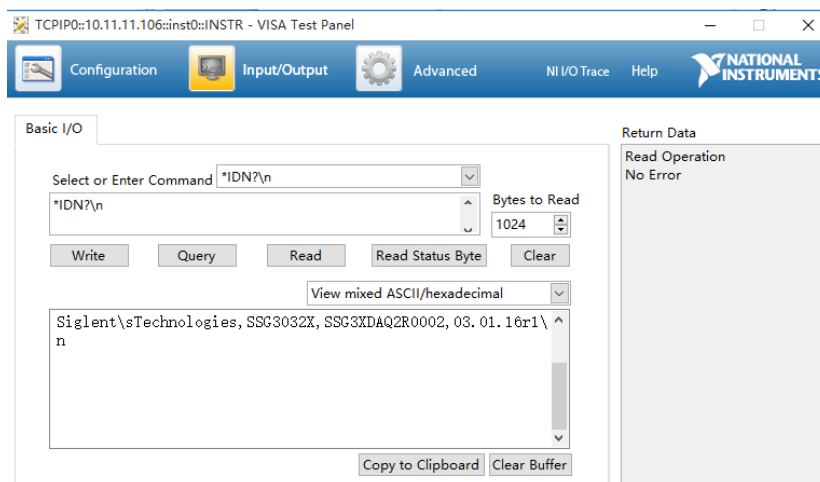

4.3.1 Web Control

With the new embedded web server, users can control the SSG through LAN from a web browser on PC or mobile terminals. This provides wonderful remote controlling and monitoring capabilities.

Chapter 5 Service and Support

5.1 General Inspection

1. Inspect the shipping container

Keep the damaged shipping container or cushioning material until the contents of the shipment have been completely checked and the instrument has passed both electrical and mechanical tests.

The consigner or carrier will be responsible for damages to the instrument resulting from shipment. **SIGLENT** will not provide free maintenance or replacement.

2. Inspect the instrument

If the instrument is found to be damaged, defective or fails in electrical or mechanical tests, please contact **SIGLENT**.

3. Check the accessories

Please check the accessories according to the packing list. If the accessories are incomplete or damaged, please contact your **SIGLENT** sales representative.

5.2 Troubleshooting

Before calling **SIGLENT**, or returning an SSG for service, perform the quick checks listed below. This check may eliminate the problem.

If the problem remains still, please contact **SIGLENT** and provide your device information of the SSG (Get method: **UTILITY**->**System Info**).

1. The SSG's screen is still dark (no display) after power on:

(1) Check whether the fan is running:

- If yes, the connection of the internal screen cable may be loose.
- If not, the instrument has failed to start up and please refer to step (2).

(2) Check the power:

- Check whether the power supply has been connected correctly and the power switch has been turned on.
- Check whether the power fuse is burned. If a new fuse needs to be installed, please use the specified fuse type/rating.

2. The key is unresponsive or gives a wrong response:

(1) Press all the keys at the front panel to check if all of them are normal after power on.

(2) Press **Utility**-> **Self Test** ->**Key Test** to check if all the keys are working properly.

(3) If a key is not working, the numeric keyboard connection might be loose or the numeric keyboard is broken.

Do not disassemble the instrument by yourself and contact **SIGLENT**.

3. Correct setting but incorrect waveform output

(1) No RF output

- Check that the signal cable is securely connected to the corresponding [RF OUTPUT 50 Ω] port.

- Check the cable for damage.

- Check if the RF button backlight is lit. If not lit, press this button to light it and the user interface status bar RF flag turns blue. The RF output is now turned on correctly.

- Check if the signal output amplitude is too small, and adjust the output amplitude appropriately.

(2) No modulation on the RF output

- Check that the signal cable is securely connected to the corresponding [RF OUTPUT 50 Ω] port.

- Check the cable for damage.

- Check that both the MOD and RF button backlights are lit and that the modulation switch needs to be turned on.

- Check if the modulation parameters are appropriate and modulate the modulation parameters appropriately.
- If an external modulation source is used, make sure that the external source is connected correctly and has an output and should work within the range established by the source.

4. Sweep is abnormal:

(1) Scanning stagnation

The user interface frequency zone/amplitude zone displays a scan progress bar indicating that a scan operation is in progress. If there is stagnation, check the points.

- Open at least one scan type: Select Frequency, Amplitude, or Frequency & Amplitude according to the SWEEP scan type status.
- If the single scan mode is enabled, a single scan is performed when the single software meets the trigger condition.
- If the scan trigger mode is not automatic trigger, press SWEEP trigger mode to automatically trigger to determine if the scan trigger is missing and the scan is blocked.
- If the point trigger mode is not automatic trigger, it is automatically triggered by the SWEEP trigger mode to determine if the point trigger is missing and the scan is blocked.

- Determine if the dwell time setting is too large or too small for the scan to be visible.

- Make sure at least two points are set in the step scan or list scan.

(2) In the list or step scan, the amplitude does not change

- Verify that the scan type is set to Amplitude or Frequency & Amplitude.

- If the current scan type is set to Frequency, the amplitude value does not change.

5. USB device cannot be recognized:

(1) Check if the USB device is connected to other instruments or the computer can work normally.

(2) Confirm the flash type U disk device used. This instrument does not support the hard disk type U disk device.

(3) After restarting the instrument, insert the USB flash drive to check.

(4) If you are unable to use the USB flash drive normally, please contact.

6. Inaccurate measurement results or insufficient accuracy:

Users can obtain detailed descriptions of technical indicators from the back of this manual to calculate system errors and check measurement results and accuracy issues. To achieve the performance metrics listed in this manual, you need:

(1) Check if the RF signal source is within the calibration period (1 year).

(2) Verify that the RF signal source has been warmed up for at least 30 minutes before testing.

(3) Check that the performance of the test equipment used meets the requirements.

(4) Ensure that the test equipment used is within the calibration cycle.

(5) Check if the test equipment used is under the working conditions required by its manual.

(6) Check if all connections are tightened.

7. Pop-up Message:

The instrument may display prompt messages, error messages or state messages according to the current working status. These messages are displayed to help you to use the instrument correctly and are not instrument failures.

Chapter 6 Service and Support

6.1 Service Summary

SIGLENT warrants that the products that it manufactures and sells will be free from defects in materials and workmanship for a period of three years (accessories for a period of one year) from the date of shipment from an authorized Siglent distributor. If the product proves defective within the respective period, **SIGLENT** will provide repair or replacement as described in the complete warranty statement.

To arrange for service or obtain a copy of the complete warranty statement, please contact your nearest Siglent sales and service office. Except as provided in this summary or the applicable warranty statement, **SIGLENT** makes no warranty of any kind, express or implied, including without limitation the implied warranties of merchantability and fitness for a particular purpose. In no event shall **SIGLENT** be liable for indirect, special or consequential damages.

6.2 Contact Us

China:

SIGLENT TECHNOLOGIES CO., LTD.

Add: Bldg. No.4 & No.5, Antongda Industrial Zone, 3rd Liuxian Road, Bao'an District,

Shenzhen, 518101, China.

Tel: + 86 755 3661 7876

Fax: + 86 755 3359 1582

Email: sales@siglent.com;

[Website: http://www.siglent.com/ens/](http://www.siglent.com/ens/)

USA:

SIGLENT Technologies America, Inc.

6557 Cochran Rd Solon, Ohio 44139

Tel: 440-398-5800

Toll Free: 877-515-5551

Fax: 440-399-1211

Email: info@siglent.com

[Website: www.siglentamerica.com](http://www.siglentamerica.com)

Europe:

SIGLENT TECHNOLOGIES EUROPE GmbH

ADD: Liebigstrasse 2-20, Gebaeude 14, 22113 Hamburg Germany

Tel: +49(0)-819-95946

Fax: +49(0)-819-95947

Email: info-eu@siglent.com

Website: www.siglenteu.com