

ST632 / ST632-S ST632P / ST632P-S

SmartMount® Universal Tilt Wall Mount for 22" to 40" Flat Panel Displays

Small to medium displays are quick and easy to install with this pre-assembled mount. Just mount the wall plate to the wall, attach the wall plate to the flat panel display and hook on the VESA® compliant adapter plate to the wall plate. Tilt can be adjusted without the use of tools to guide the display to the ideal viewing angle.



Display size: 22"-40"



Max load: 115lb (52kg)

FEATURES

- VESA® 75 and 100, 200 x 100 and 200 x 200mm compliant
- Additional display adapter plates also available
- +15°/-5° tilt adjustment without the use of tools
- Display adapter plate simply hooks onto the wall plate for quick and easy installation
- Mounts to wood stud, concrete, cinder block and metal stud (metal stud accessory required)
- UL listed

STANDARDIZED COMPATIBILITY
 VESA® 75, 100, 200 x 100 and 200 x 200mm compliant for reliable display compatibility

EASY INSTALLATION
 Adapter plate hooks onto wall plate for safe, simple installation

IDEAL VIEWING ANGLE
 Tilt adjustment of +15°/-5° without the use of tools



Low-profile design holds display only 1.66" (42mm) from the wall

* OSHPD Approval Pending



Model Numbers

WARRANTY: Limited 5-year

ST632(-S)
ST632P(-S)

Universal Tilt Wall Mount for 22" to 40" Flat Panel Displays - security models
Universal Tilt Wall Mount for 22" to 40" Flat Panel Displays - standard models

Product Specifications

	DIMENSIONS (W x H x D)	PRODUCT WEIGHT	LOAD CAPACITY	FINISH	AVAILABLE COLORS
ST632(P)(-S)	8.75" x 9.35" x 1.66"-2.91" (222 x 237 x 42-74mm)	3.5lb (1.6kg)	115lb (52kg)	Scratch resistant fused epoxy	ST632(P): Black ST632(P)-S: Silver

Package Specifications

	PACKAGE SIZE (W x H x D)	PACKAGE SHIP WEIGHT	PACKAGE UPC CODE	PACKAGE CONTENTS	UNITS IN PACKAGE
ST632(P)(-S)	ST632(-S): 12.75" x 9.5" x 2.5" (128 x 95 x 25mm) ST632P(-S): 9.25" x 12.5" x 2.75" (234 x 317 x 69mm)	4.4lb (1.99kg)	ST632: 735029237242 ST632-S: 735029237259 ST632P: 735029237266 ST632P-S: 735029237273	Tilting wall plate, VESA® 75/100 adapter plate, additional VESA® 200 x 100 and 200 x 200mm adapter plate, mounting and display attachment hardware	1

Accessories

ACC215: 2-pack Metal Stud Fastener Kit

All dimensions = inch (mm)

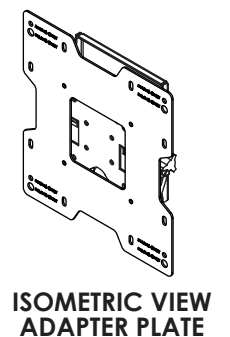
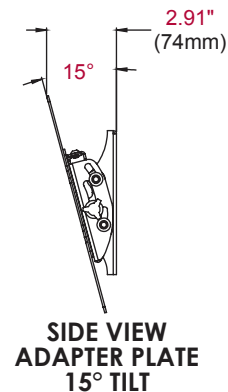
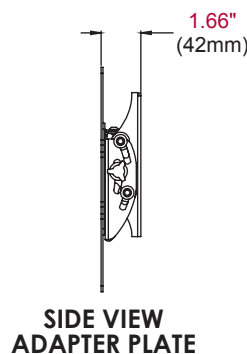
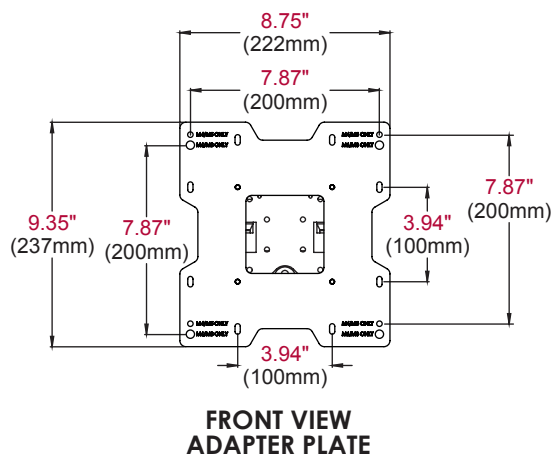
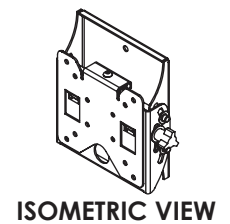
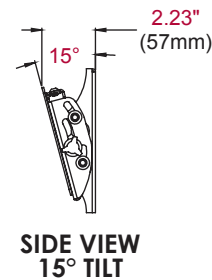
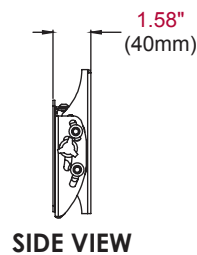
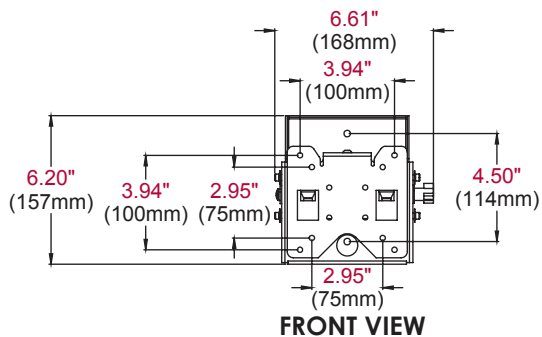

ARCHITECTS SPECIFICATIONS

The Smartmount® Universal Tilt Wall Mount shall be a Peerless-AV model ST632 and shall be located where indicated on the plans. It shall be constructed of heavy gauge cold rolled steel and finished with scratch resistant Black or Silver Fused Epoxy. Assembly and installation shall be done according to instructions provided by the manufacturer.

Peerless Industries, Inc. ■ 2300 White Oak Circle ■ Aurora, IL 60502 ■ (800) 865-2112 ■ (630) 375-5100 ■ Fax: (800) 359-6500 ■ www.peerless-av.com

Visit www.peerless-av.com to see the complete line of AV solutions from Peerless-AV, including flat panel mounts, projector mounts, carts/stands, furniture, cables, screen cleaners and a full assortment of accessories.