

User Manual

WM55H

The color and the appearance may differ depending on the product, and the content in the manual is subject to change without prior notice to improve the performance.

Table of contents

Before Using the Product

Safety Precautions	4
Storage	4
Electricity and safety	4
Installation	5
Operation	6
Precautions for Use	8

Preparations

Checking the Components	9
Parts	10
Ports	12
Before Installing the Product (Installation Guide)	13
Rotation	13
Ventilation	13
Installing the Wall Mount	14
Installing the Wall Mount	14
Wall Mount Kit Specifications (VESA)	14
Connecting to a network	15
Network Settings (Wired)	15
Network Settings (Wireless)	17
Use WPS	19

Writing

What's a 'Roll'?	20
Screen Elements	21
Drawing / Erasing	22
Changing pen thickness	22
Changing the pen color	22
Erasing	22
Managing Rolls	23
Opening rolls	24
Page Viewer	25

IMPORT

Connecting to a Mobile Device	27
Connecting using Smart View or Screen Mirroring	27
Connecting using NFC tagging	27
Connecting to a Laptop	28
Connecting using a cable	28
Connecting via the WiFi Display function	28
Importing from a USB Device	29
Importing from a Network Drive	29
Source Window	30

EXPORT

Sending Email	32
Printing	33
Installing Flip Printing Software	33
Setting up the printer	33
Exporting to a USB Device	35
Exporting from a Network Drive	35

Menu

Pen	36
Connect	37
System	42
Picture	44
Support	45

Troubleshooting Guide

Problems and Solutions	46
------------------------	----

Table of contents

Specifications

General	51
Preset Timing Modes	53

Appendix

Responsibility for the Pay Service (Cost to Customers)	55
Not a product defect	55
A Product damage caused by customer's fault	55
Others	55
Prevention of Afterimage Burn-in	56
What is afterimage burn-in?	56
Recommended prevention practices	56
License	56

Chapter 01

Before Using the Product

Safety Precautions

Warning

A serious or fatal injury may result if instructions are not followed.

Caution

Personal injury or damage to properties may result if instructions are not followed.



Activities marked by this symbol are prohibited.



Instructions marked by this symbol must be followed.





Storage

Due to the characteristics of high-glossy products, using a UV humidifier nearby may create white-colored stains on the product.

 Contact Customer Service Center if the inside of the product needs cleaning (service fee will be charged).

Electricity and safety

Warning

-  Do not use a damaged power cord or plug, or a loose power socket.
An electric shock or fire may result.
-  Do not use multiple products with a single power socket.
Overheated power sockets may cause a fire.
-  Do not touch the power plug with wet hands. Otherwise, an electric shock may result.
-  Do not bend or pull the power cord with force. Be careful not to leave the power cord under a heavy object.
Damage to the cord may result in a fire or electric shock.
-  Do not place the power cord or product near heat sources.
A fire or electric shock may result.

- ❗ Insert the power plug all the way in so it is not loose.
An unsecure connection may cause a fire.
- ❗ Connect the power plug to a grounded power socket (type 1 insulated devices only).
An electric shock or injury may result.
- ❗ Clean any dust around the pins of the power plug or the power socket with a dry cloth.
A fire may result.

Caution

- ⊘ Do not disconnect the power cord while the product is being used.
The product may become damaged by an electric shock.
- ❗ Only use the power cord provided with your product by Samsung. Do not use the power cord with other products.
A fire or electric shock may result.
- ❗ Keep the power socket where the power cord is connected unobstructed.
The power cord must be disconnected to cut off power to the product when an issue occurs.
- ❗ Hold the plug when disconnecting the power cord from the power socket.
An electric shock or fire may result.

Installation

Warning

- ⊘ DO NOT PLACE CANDLES, INSECT REPELLANTS OR CIGARETTES ON TOP OF THE PRODUCT. DO NOT INSTALL THE PRODUCT NEAR HEAT SOURCES.
A fire may result.
- ⊘ Do not install the product in poorly ventilated spaces such as a bookcase or closet.
An increased internal temperature may cause a fire.
- ⊘ Do not install the product on an unstable or vibrating surface (insecure shelf, sloped surface, etc.)
 - The product may fall and become damaged and/or cause an injury.
 - Using the product in an area with excess vibration may damage the product or cause a fire.
- ⊘ Do not expose the product to direct sunlight, heat, or a hot object such as a stove.
The product lifespan may be reduced or a fire may result.
- ⊘ Do not install the product within the reach of young children.
 - The product may fall and injure children.
 - As the front is heavy, install the product on a flat and stable surface.
- ⊘ Edible oil, such as soybean oil, can damage or deform the product. Do not install the product in a kitchen or near a kitchen counter.
- ❗ Have a technician install the wall-mount hanger.
 - Installation by an unqualified person can result in an injury.
 - Only use approved cabinets.
- ❗ Install the product at least 10 cm away from the wall to allow ventilation.
An increased internal temperature may cause a fire.

- ! Keep the plastic packaging out of the reach of children.

Children may suffocate.

- ! Do not install the product in a vehicle or a place exposed to dust, moisture (water drips, etc.), oil, or smoke.

A fire or electric shock may result.

Caution

- ⊘ Do not set down the product on its front.

The screen may become damaged.

- ! Do not drop the product while moving.

Product failure or personal injury may result.

- ! Set down the product gently.

Product failure or personal injury may result.

- ! Installing the product in an unusual place (a place exposed to a lot of fine dust, chemical substances, extreme temperatures or a significant presence of moisture, or a place where the product will operate continuously for an extended period of time) may seriously affect its performance.

Be sure to consult Samsung Customer Service Center if you want to install the product at such a place.

Operation

Warning

- ⊘ There is a high voltage inside the product. Never disassemble, repair or modify the product yourself.
 - A fire or electric shock may result.
 - Contact Samsung Customer Service Center for repairs.
- ⊘ Do not let children hang from the product or climb on top of it.

Children may become injured or seriously harmed.
- ⊘ If the product is dropped or the outer case is damaged, turn off the power switch and disconnect the power cord. Then contact Samsung Customer Service Center.

Continued use can result in a fire or electric shock.
- ⊘ Do not leave heavy objects or items that children like (toys, sweets, etc.) on top of the product.

The product or heavy objects may fall as children try to reach for the toys or sweets resulting in a serious injury.
- ⊘ Do not move the product by pulling the power cord or any cable.

Product failure, an electric shock or fire may result from a damaged cable.
- ⊘ Do not lift or move the product by pulling the power cord or any cable.

Product failure, an electric shock or fire may result from a damaged cable.
- ⊘ Ensure the vents are not blocked by tablecloths or curtains.

An increased internal temperature may cause a fire.
- ⊘ Do not insert metallic objects (chopsticks, coins, hairpins, etc) or objects that burn easily (paper, matches, etc) into the product (via the vent or input/output ports, etc).
 - Be sure to power off the product and disconnect the power cord when water or other foreign substances have entered the product. Then contact Samsung Customer Service Center.
 - Product failure, an electric shock or fire may result.

 Do not place objects containing liquid (vases, pots, bottles, etc) or metallic objects on top of the product.

- Be sure to power off the product and disconnect the power cord when water or other foreign substances have entered the product. Then contact Samsung Customer Service Center.
- Product failure, an electric shock or fire may result.

 Before moving the product, turn off the power switch and disconnect the power cable and all other connected cables.

Damage to the cord may result in a fire or electric shock.

 If the product generates abnormal sounds, a burning smell or smoke, disconnect the power cord immediately and contact Samsung Customer Service Center.

An electric shock or fire may result.

 During a lightning or thunderstorm, power off the product and remove the power cable.

A fire or electric shock may result.

 Do not drop objects on the product or apply impact.

A fire or electric shock may result.

 If a gas leakage is found, do not touch the product or power plug. Also, ventilate the area immediately.

Sparks can cause an explosion or fire.

 Do not use or keep combustible spray or an inflammable substance near the product.

An explosion or fire may result.

Caution

 Do not use humidifiers or stoves around the product.

A fire or electric shock may result.

 Do not touch the screen when the product has been turned on for an extended period of time as it will become hot.

 Do not place heavy objects on the product.

Product failure or personal injury may result.

 Leaving the screen fixed on a stationary image for an extended period of time may cause afterimage burn-in or defective pixels.

Activate power-saving mode or a moving-picture screen saver if you will not be using the product for an extended period of time.

 Disconnect the power cord from the power socket if you do not plan on using the product for an extended period of time (vacation, etc).

Dust accumulation combined with heat can cause a fire, electric shock or electric leakage.

 Use the product at the recommended resolution and frequency.

Your eyesight may deteriorate.

 Looking at the screen too close for an extended period of time can deteriorate your eyesight.

 Rest your eyes for more than 5 minutes for every 1 hour of product use.



Eye fatigue will be relieved.

 Store small accessories out of the reach of children.

Precautions for Use

Be careful that if you use the supplied pen with a load exceeding 2.5 kg, scratches may occur on the protective glass.

If you use a ballpoint pen other than the supplied pen, be careful that the screen may be stained with ink or damaged.

-  We recommend that you use the supplied pen. Do not use sharp, pointed objects other than the pen.
-  If dust or dirt from the supplied pen remains on the protective glass, clean it referring to the instructions below.

Cleaning the exterior and display

Wipe the surface with a slightly wet, soft cloth, and then wipe with a dry cloth.

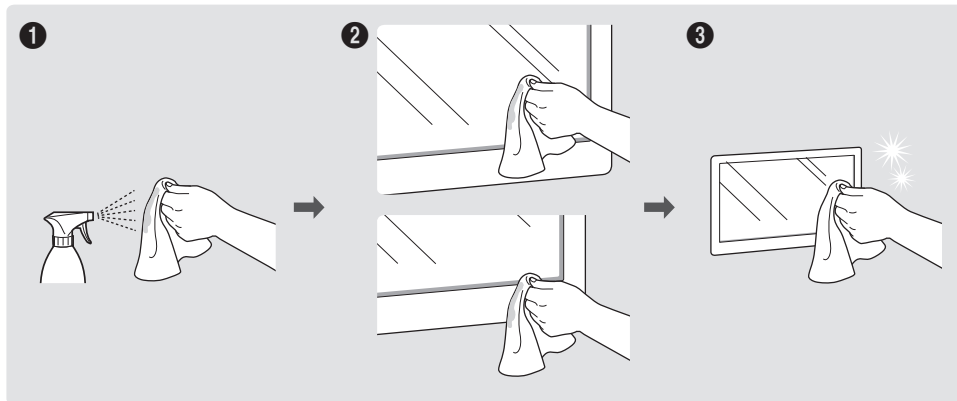

Chapter 02

Preparations

Checking the Components

 Contact the vendor where you purchased the product if any components are missing.

 The appearance of the components may differ from the images shown.



Quick Setup Guide



Warranty card
(Not available in some locations)



Regulatory guide



Power cord

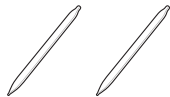

Touch Pen X 2

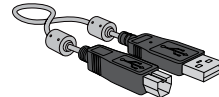

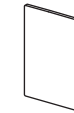

USB cable





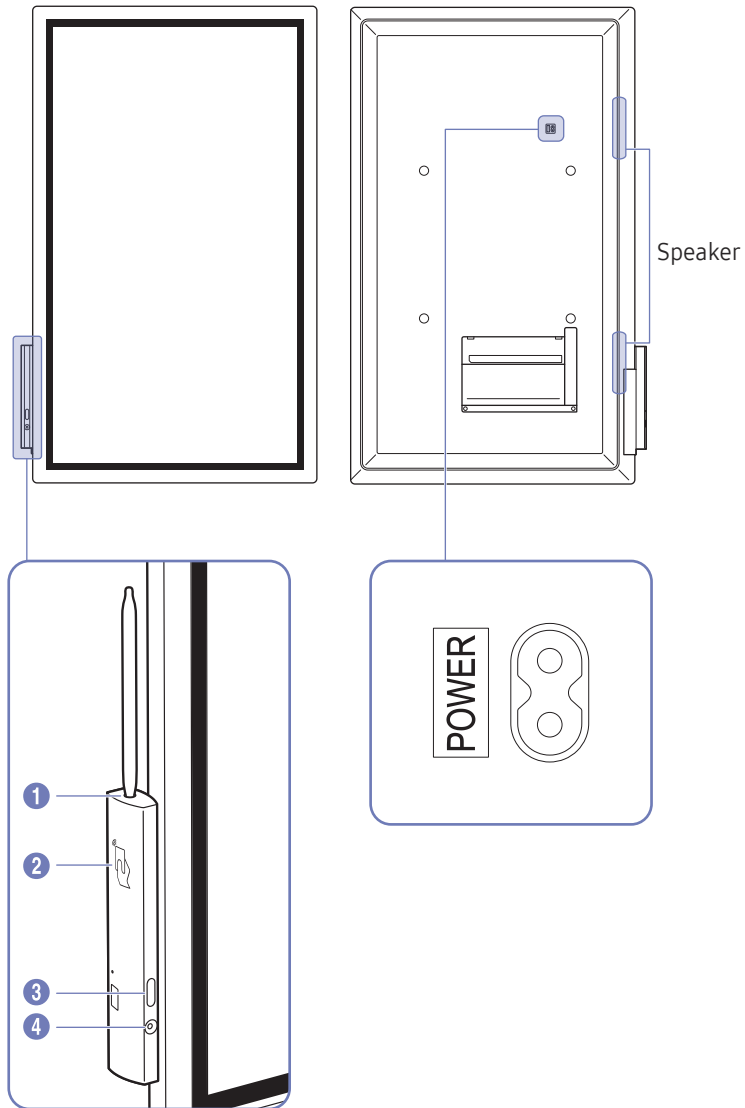

Cover Terminal

Parts



 The color and shape of parts may differ from what is shown. Specifications are subject to change without notice to improve quality.





Parts	Description
1 Pen holder	<p>Keep the touch pen in place.</p> <ul style="list-style-type: none"> When the product is turned off and you lift the pen from the pen holder, the screen turns on. When the product is in the screen saver mode and you lift the pen from the pen holder, the screen turns on.
2 NFC pad	<ul style="list-style-type: none"> Tag your mobile device to the NFC pad for connection. <ul style="list-style-type: none">  In writing mode, an NFC tagging can automatically perform Smart View or Screen Mirroring on your mobile device.  This function is supported only on Android 8.0 Oreo version or later of Samsung mobile devices. Tag an NFC card to the NFC pad to enter an email address automatically. <ul style="list-style-type: none">  While creating an email, an email address is automatically entered if it is read from the encoded NFC tag.  For how to enter an email address in the NFC card, refer to 'Sending Email'.
3 Power button	<ul style="list-style-type: none"> Press and hold the button to turn off the product. In writing mode, shortly press the Power button to switch to the screen saver mode. In HDMI or Screen Mirroring mode, press the Power button to exit full screen mode.

Parts	Description
<p>4 Motion sensor</p>	<p>Detects user's motions to turn the product on or off.</p> <div data-bbox="1234 341 2112 616" data-label="Diagram"> <pre> graph LR WB[WHITEBOARD / BLACKBOARD] -- "Motion is detected." --> SS[Screen Saver] SS -- "Motion is detected." --> PO[Power Off] PO -- "Motion is detected." --> WB WB -- "There is no motion for 1 hour." --> SS SS -- "There is no motion for 1 hour." --> PO PO -- "The screen is touched or the touch pen is lifted." --> WB </pre> </div> <p>If the product is turned off because no motion is detected, it operates as follows:</p> <ul style="list-style-type: none"> When → System → Advanced Settings → Auto Save is set to On: The last roll you are creating is displayed on the screen. When → System → Advanced Settings → Auto Save is set to Off: A new roll is displayed on the screen. <p>When the screen of a mobile device and laptop is displayed on the product in the full screen mode, the product does not switch to the screen saver mode.</p> <p>When the screen is turned off, it may turn on in the screen saver mode due to the surrounding environment and illumination. To turn the product's screen on or off with the Power button only, set Motion Sensor to Off at → System → Advanced Settings.</p> <ul style="list-style-type: none"> For ensuring normal operation of the motion sensor, do not install the product in a place exposed to direct sunlight. Do not hide the front of the motion sensor with an object. When there are any foreign substances on the motion sensor, wipe them with a soft cloth.

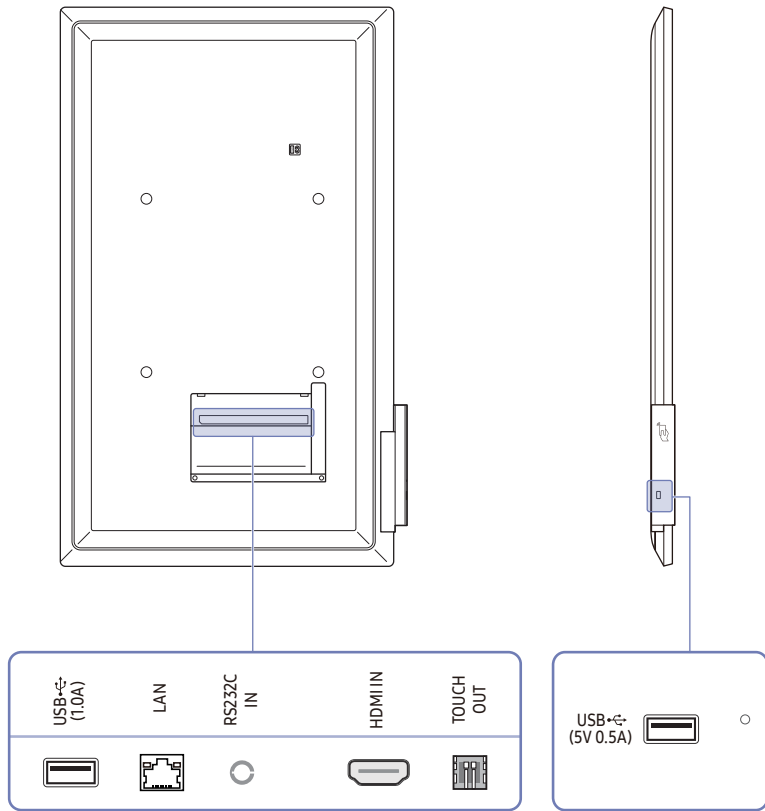
Ports

 The color and shape of parts may differ from what is shown. Specifications are subject to change without notice to improve quality.



Ports	Description
USB  (1.0A)	Connect to a USB memory device.  The USB ports on the product accept a maximum constant current of 1.0A. If the maximum value is exceeded, USB ports may not work.
LAN	Connects to a network using a LAN cable. (10/100 Mbps)  Use Cat7(*STP Type) cable for the connection. *Shielded Twist Pair.
RS232C IN	Dedicated to service technicians.
HDMI IN	Connects to a source device using a HDMI cable.
TOUCH OUT	Connects to a PC using a USB cable. You can operate the PC screen by touching the product screen.
USB  (5V 0.5A)	Connect to a USB memory device.  The USB ports on the product accept a maximum constant current of 0.5A. If the maximum value is exceeded, USB ports may not work.

Before Installing the Product (Installation Guide)

There is a product-specific stand sold separately from Samsung, and you can install it on the wall, too.

Rotation

Contact Samsung Customer Service Center for further details.

- To use the product in landscape orientation, turn the product anticlockwise so that the sensor part faces downward.

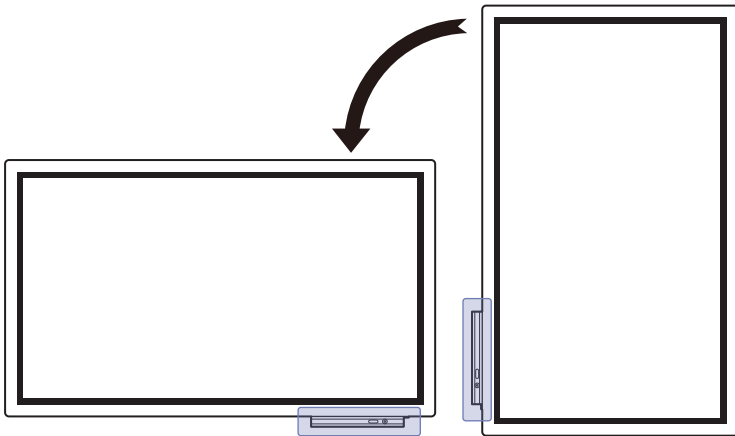

Ventilation

Contact Samsung Customer Service Center for further details.

Installation on a Perpendicular Wall

A Minimum 15 mm

B Ambient temperature: 35°C or less

- When installing the product on a perpendicular wall, allow at least 15 mm of space between the product and wall surface for ventilation and ensure that the ambient temperature is kept below 35°C.

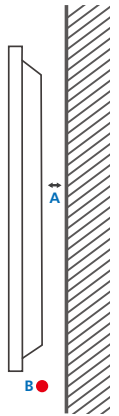

Installation on an Indented Wall

A Minimum 15 mm

B Minimum 25 mm

C Ambient temperature: 35°C or less

- When installing the product on an indented wall, allow at least the space specified above between the product and wall for ventilation and ensure that the ambient temperature is kept below 35°C.

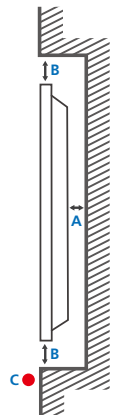

Installing the Wall Mount

Installing the Wall Mount

- The wall mount kit allows you to mount the product on the wall.
- For detailed information on installing the wall mount, see the instructions provided with the wall mount.
- We recommend you contact a technician for assistance when installing the wall mount bracket.
- Samsung Electronics is not responsible for any damage to the product or injury to yourself or others if you select to install the wall mount on your own.

Wall Mount Kit Specifications (VESA)

 Install your wall mount on a solid wall perpendicular to the floor. To install the product on the other wall area, contact the nearest agency.

If you install the product on a slanted wall, it may fall and result in severe personal injury.

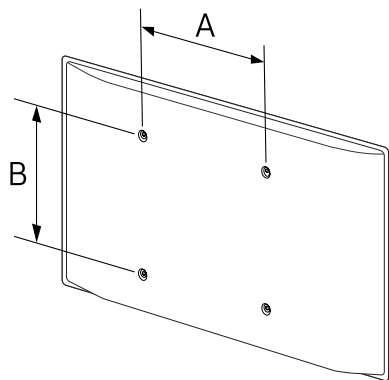

- Samsung wall mount kits contain a detailed installation manual and all parts necessary for assembly are provided.
- Do not use screws that are longer than the standard length or do not comply with the VESA standard screw specifications. Screws that are too long may cause damage to the inside of the product.
- For wall mounts that do not comply with the VESA standard screw specifications, the length of the screws may differ depending on the wall mount specifications.
- Do not fasten the screws too firmly. This may damage the product or cause the product to fall, leading to personal injury. Samsung is not liable for these kinds of accidents.
- Samsung is not liable for product damage or personal injury when a non-VESA or non-specified wall mount is used or the consumer fails to follow the product installation instructions.
- Always have at least two people mount the product on a wall.
- Standard dimensions for wall mount kits are shown in the table below.

VESA screw hole specs (A * B) in millimeters (inches)	Standard Screw	Quantity
400 × 400 (15.7 × 15.7)	M8	4

 Do not install your Wall Mount Kit while your product is turned on. It may result in personal injury due to electric shock.

Connecting to a network

Network Settings (Wired)

Connecting to a Wired Network

There are three ways to attach your product to your LAN using cable.

- You can attach your product to your LAN by connecting the LAN port on the back of your product to an external modem using a LAN cable. See the diagram below.

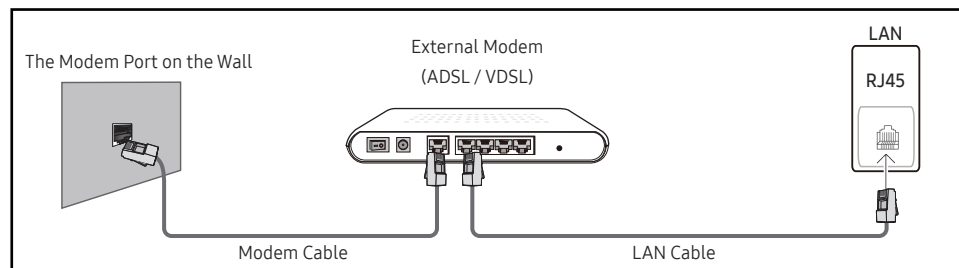

- You can attach your product to your LAN by connecting the LAN port on the back of your product to an IP Sharer which is connected to an external modem. Use LAN cable for the connection. See the diagram below.

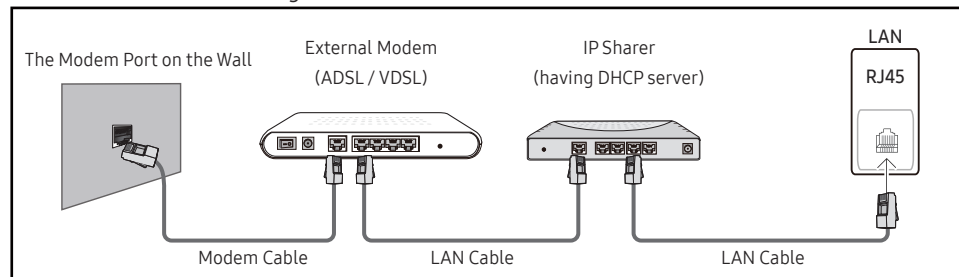

- Depending on how your network is configured, you may be able to attach your product to your LAN by connecting the LAN port on the back of your product directly to a network wall outlet using a LAN cable. See the diagram below. Note that the wall outlet is attached to a modem or router elsewhere in your house.

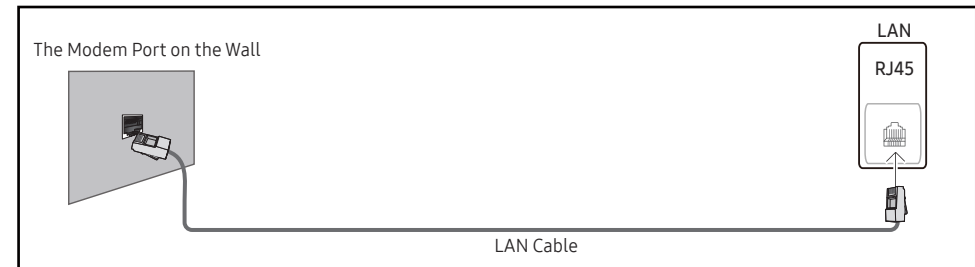

If you have a Dynamic Network, you should use an ADSL modem or router that supports the Dynamic Host Configuration Protocol (DHCP). Modems and routers that support DHCP automatically provide the IP address, subnet mask, gateway, and DNS values your product needs to access the Internet so you do not have to enter them manually. Most home networks are Dynamic Networks.

Some networks require a Static IP address. If your network requires a Static IP address, you must enter the IP address, subnet mask, gateway, and DNS values manually on your product Cable Setup Screen when you set up the network connection. To get the IP address, subnet mask, gateway, and DNS values, contact your Internet Service Provider (ISP).

If you have a Windows computer, you can also get these values through your computer.

- ✎ You can use ADSL modems that support DHCP if your network requires a Static IP address.
- ✎ ADSL modems that support DHCP also let you use Static IP addresses.



Set the network connection to use Internet services such as perform software upgrades.

Automatic Open Network Settings (Wired)

Connect to the network using a LAN cable.

Make sure a LAN cable is connected first.

How to set up automatically

- 1 Set **Network Type** to **Wireless** from the **Open Network Settings** page.
- 2 The network test screen appears and verifies the network connection.
When the connection has been verified, the **“Success! Your device is connected to the Internet. If you have any problems using online services, please contact your Internet service provider.”** message appears.
 If the connection process fails, check the LAN port connection.
 If the automatic process cannot find the network connection values or if you want to set the connection manually, go to the next section, network setup.

Manual Open Network Settings (Wired)

Offices may use static IP addresses.



If this is the case, ask the network administrator for the IP address, subnet mask, gateway and DNS server address. Enter these values manually.

Getting the Network Connection Values

To view the Network connection values on most Windows computers, follow these steps.

- 1 Right click the Network icon on the bottom right of the screen.
- 2 In the pop-up menu that appears, click Status.
- 3 On the dialog that appears, click the **Support** tab.
- 4 On the **Support** Tab, click the **Details** button. The Network connection values are displayed.

How to set up manually

- 1 Set **Network Type** to **Wireless** from the **Open Network Settings** page.
- 2 The network test screen appears and the verification process starts. Press **Cancel**. The verification process stops.
- 3 Select **IP Settings** on network connection screen. The **IP Settings** screen appears.
- 4 Select the field at the top, press , and then set **IP Setting** to **Enter manually** Repeat the entry process for each field in the **IP Address**.
 Setting **IP Setting** to **Enter manually** automatically changes **DNS Setting** to **Enter manually**.
- 5 When done, select **OK** at the bottom of the page, and then press . The network test screen appears and the verification process starts.
- 6 When the connection has been verified, the **“Success! Your device is connected to the Internet. If you have any problems using online services, please contact your Internet service provider.”** message appears.

Network Settings (Wireless)

Connecting to a Wireless Network

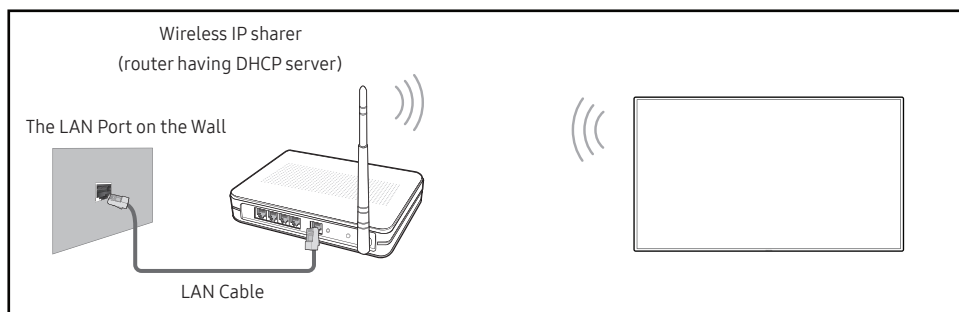

Samsung recommends using IEEE 802.11n. When you play video over a network connection, the video may not play smoothly.

- ✎ Select a channel for the wireless IP sharer that is not currently being used. If the channel set for the wireless IP sharer is currently being used by another device nearby, this will result in interference and communication failure.
- ✎ Your product supports only the following wireless network security protocols. If you select the Pure High-throughput (Greenfield) 802.11n mode and the Encryption type is set to WEP, TKIP or TKIP AES (WPS2Mixed) on your AP or wireless router, Samsung products will not support a connection in compliance with new Wi-Fi certification specifications.
- ✎ If your wireless router supports WPS (Wi-Fi Protected Setup), you can connect to the network via PBC (Push Button Configuration) or PIN (Personal Identification Number). WPS will automatically configure the SSID and WPA key in either mode.
- ✎ Connection Methods: You can setup the wireless network connection in three ways. Auto Setup (Using the Auto Network Search function), Manual Setup, **Use WPS**

Automatic Network Setup (Wireless)

Most wireless networks have an optional security system that requires devices that access the network to transmit an encrypted security code called an Access or **Security key**. The **Security key** is based on a Pass Phrase, typically a word or a series of letters and numbers of a specified length you were asked to enter when you set up security for your wireless network. If you use this method of setting up the network connection, and have a **Security key** for your wireless network, you will have to enter the Pass Phrase during the the automatic or manual setup process.

How to set up automatically

- 1 Set **Network Type** to **Wireless** from the **Open Network Settings** page.
- 2 The **Network** function searches for available wireless networks. When done, it displays a list of the available networks.
- 3 In the list of networks, press the ▲ or ▼ button to select a network, and then press the ↵ button twice.
 - ✎ If the desired wireless router does not appear, select **Refresh** to search again.
 - ✎ If the router cannot be found after retrying, select the **Stop** button. The **Add Network** button appears.
- 4 If the **Enter the password for (AP name)** screen appears, go to step 5. If you select a wireless router that does not have security, go to step 7.
- 5 If the router has security, enter the **Enter the password for (AP name)**. (Security key or PIN).
- 6 When done, use the right arrow button to move the cursor to **Done**, and then press ↵. The network connection screen appears and the verification process starts.
 - ✎ A connection with the router is established, but the Internet cannot be accessed.
- 7 When the connection has been verified, the **“Success! Your device is connected to the Internet. If you have any problems using online services, please contact your Internet service provider.”** message appears.

Manual Network Setup (Wireless)

Offices may use static IP addresses.







If this is the case, ask the network administrator for the IP address, subnet mask, gateway and DNS server address. Enter these values manually.

Getting the Network Connection Values

To view the Network connection values on most Windows computers, follow these steps.

- 1 Right click the Network icon on the bottom right of the screen.
- 2 In the pop-up menu that appears, click Status.
- 3 On the dialog that appears, click the **Support** tab.
- 4 On the **Support** Tab, click the **Details** button. The Network connection values are displayed.



How to set up manually

- 1 Set **Network Type** to **Wireless** from the **Open Network Settings** page.
- 2 The **Network** function searches for available wireless networks. When done, it displays a list of the available networks.
- 3 In the list of networks, press the ▲ or ▼ button to select a network, and then press the  button twice.
 -  If the desired wireless router does not appear, select **Refresh** to search again.
 -  If the router cannot be found after retrying, select the **Stop** button. The **Add Network** button appears.
- 4 If the **Enter the password for (AP name)** screen appears, go to step 5. If you select a wireless router that does not have security, go to step 7.
- 5 If the router has security, enter the **Enter the password for (AP name)**. (Security key or PIN).
- 6 When done, use the right arrow button to move the cursor to **Done**, and then press . The network connection screen appears and the verification process starts.
- 7 Select **Cancel** while network connections are being attempted. This will stop the connection.
- 8 Select **IP Settings** on network connection screen. The **IP Settings** screen appears.
- 9 Select the field at the top, press , and then set **IP Setting** to **Enter manually**. Repeat the entry process for each field in the **IP Address**.
 -  Setting **IP Setting** to **Enter manually** automatically changes **DNS Setting** to **Enter manually**.
- 10 When done, select **OK** at the bottom of the page, and then press . The network test screen appears and the verification process starts.
- 11 When the connection has been verified, the “**Success! Your device is connected to the Internet. If you have any problems using online services, please contact your Internet service provider.**” message appears.

Use WPS

How to set up using Use WPS

If your router has a **Use WPS** button, follow these steps.

- 1 Set **Network Type** to **Wireless** from the **Open Network Settings** page.
- 2 Select **Use WPS**, press , and then press  again.
- 3 Press the WPS or PBC button on your wireless router within the next two minutes. Your product automatically acquires all the network setting values it needs and connects to your network.
- 4 The network connection screen appears, and network setup is done.

Chapter 03

Writing

What's a 'Roll'?

- Files are called 'rolls' in this product. A 'roll' is a file with multiple pages linked together.
- A roll can have up to 20 pages linked together.
- Pages are linked vertically in portrait orientation, and horizontally in landscape orientation.

 You can open only one roll on one screen. For more information, refer to '[Managing Rolls](#)'.

Portrait orientation

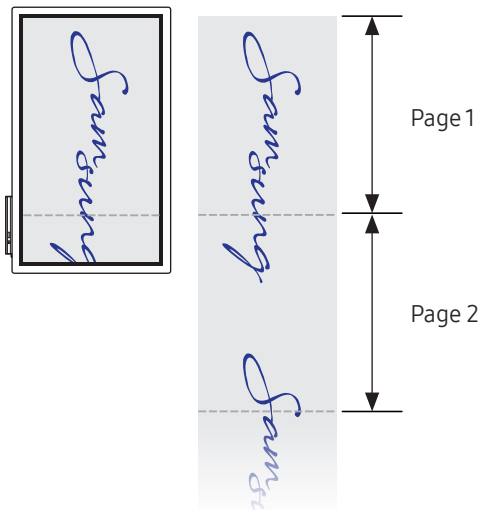



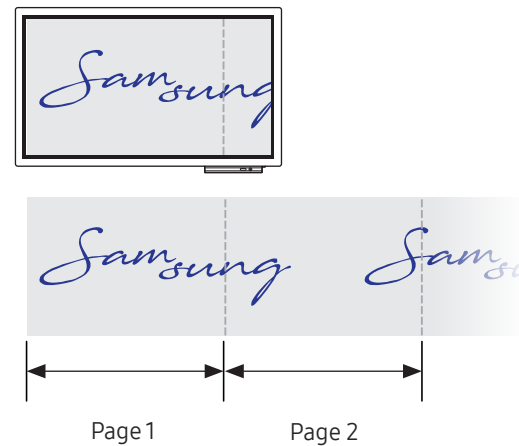

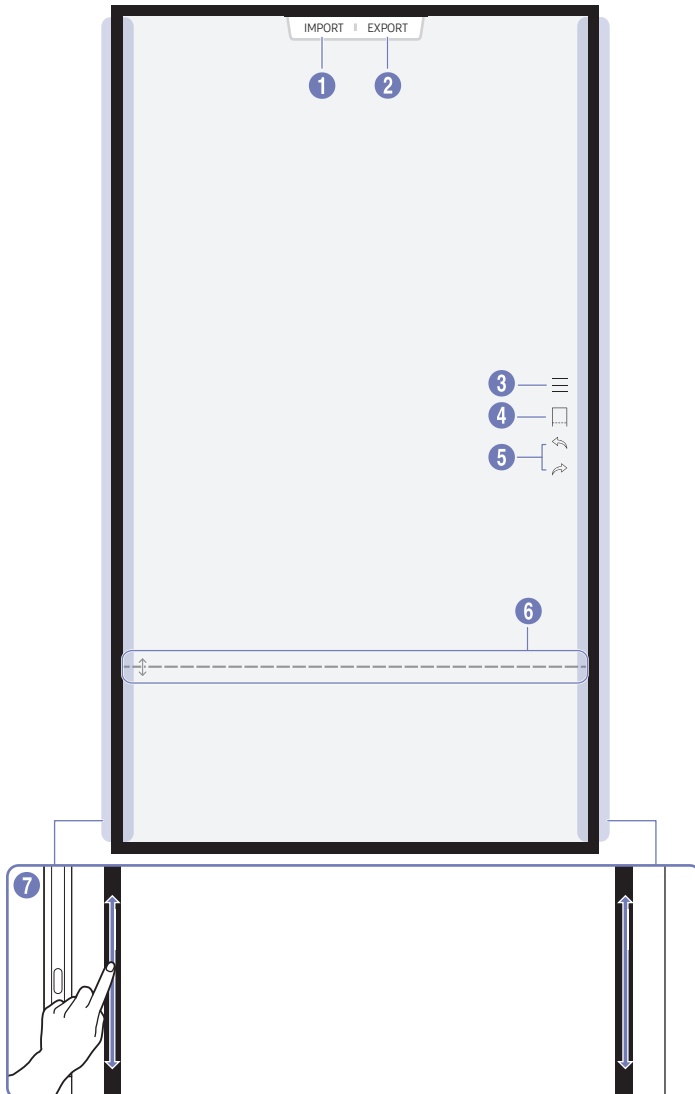

Landscape orientation



Screen Elements



Buttons	Description
1 IMPORT	View the screen of a mobile device or laptop connected to the product, or import data such as images from a connected USB or network drive.
2 EXPORT	Share your creations in various ways.
3 	Manage and change the rolls and settings.
4 	Move or edit the created rolls for each page.
5 	Undo or redo the last action. <ul style="list-style-type: none"> If any page editing actions such as page adding, deleting, and moving are found,  is reset.   can be performed up to 20 times for each individual.
6 Page breaking line	Scroll the page breaking line to move the roll.
7 Bezel Scroll	Scroll the black area to move the roll.

Drawing / Erasing

You can freely use the supplied pen to write anything you want.

- Thin Tip (A): Pen Type
- Thick Tip (B): Highlighter Type

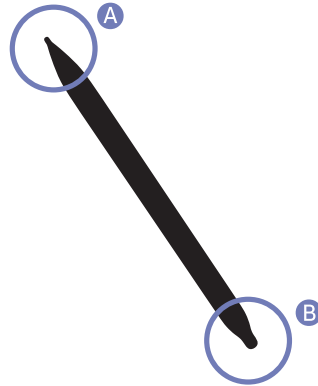

Changing pen thickness

You can change the pen thickness.

 Change the pen thickness at  → Pen → Pen & Highlighter Thickness.

Changing the pen color

You can change the pen color by touching and holding the screen with the pen.

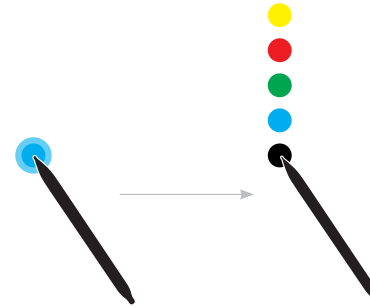

 To change the pen color type, select  → Pen → Pen Color or Highlighter Color.

Erasing

You can use your finger or palm to erase your writing.

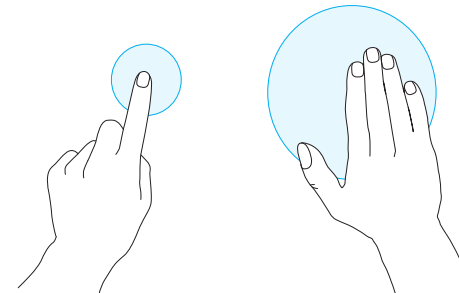

Managing Rolls

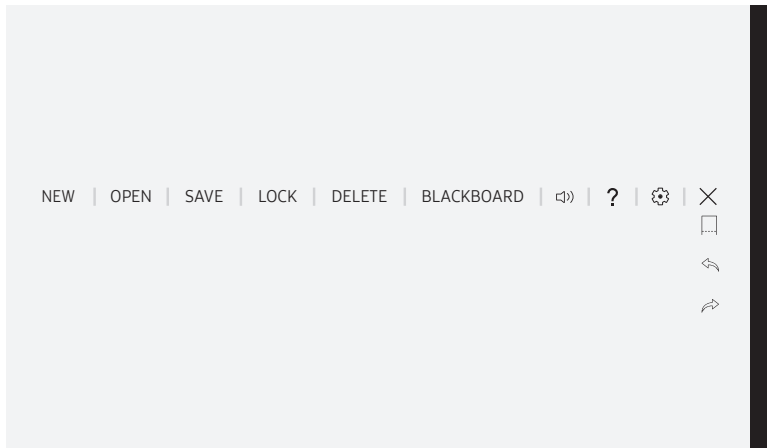
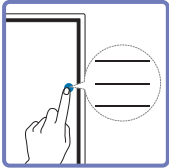

Buttons	Description
NEW	Create a new roll.
OPEN	OPEN , Delete , or Export a saved roll.
SAVE	Save the current roll.
LOCK / Unlock	<ul style="list-style-type: none"> LOCK: Press a four-digit password to lock the current roll. Unlock: To Unlock a locked roll, press the four-digit password you set when locking the roll. <p> Once unlocked, the current roll remains unlocked until it is locked again.</p>
DELETE	Delete the current roll.
BLACKBOARD / WHITEBOARD	Change the writing mode. The roll you are editing is automatically saved and a new roll is opened.
	Adjust the volume.
?	You can view How To Use.
	You can see the configuration menu.

The displayed image may differ depending on the model.

Opening rolls

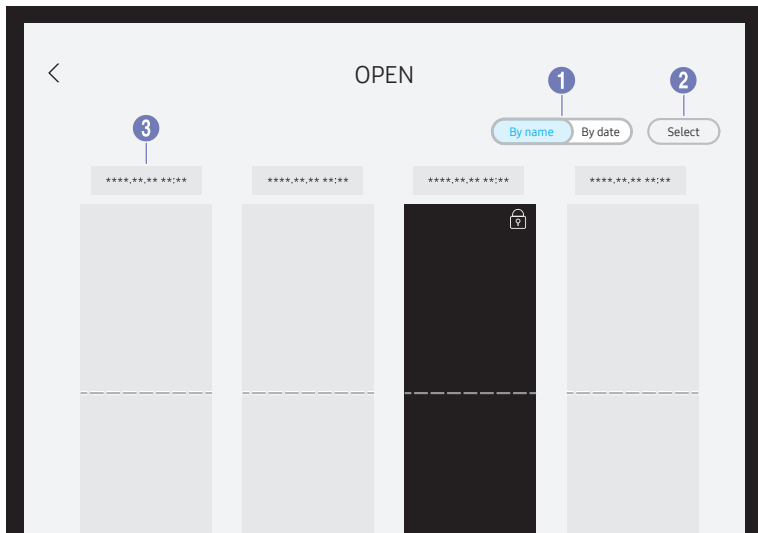
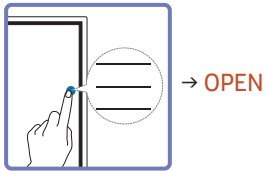

The displayed image may differ depending on the model.

Select the desired roll.

Parts	Description
1 By name ↔ By date	Set the sort order of files.
2 Select	Select multiple rolls to export or delete.
3 File Name	Rename the file.

To open a locked roll (🔒), press the four-digit password.

The rolls are sorted by recent date.

Deleting / Exporting rolls

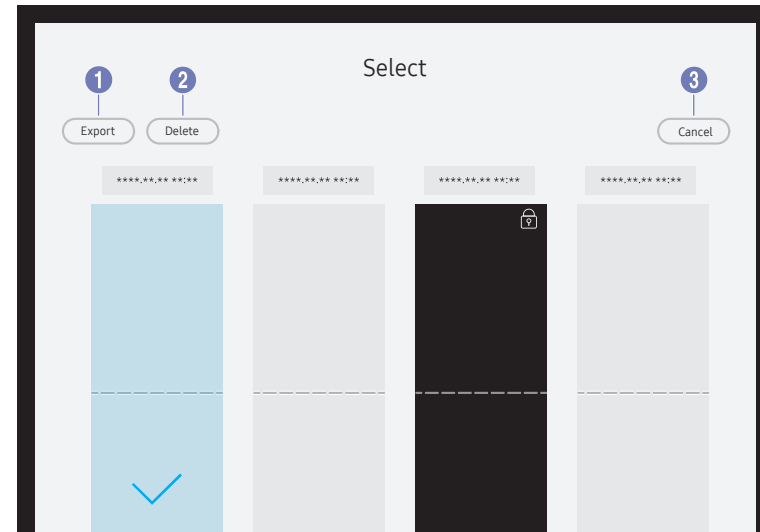
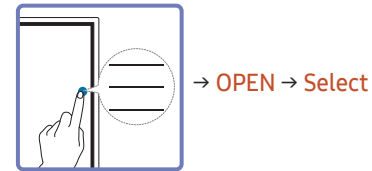

The displayed image may differ depending on the model.

You can select multiple rolls to export or delete.

Parts	Description
1 Export	Share the selected rolls any way you like. <ul style="list-style-type: none"> • Email / USB / NETWORK DRIVE
2 Delete	Delete the selected rolls.
3 Cancel	Deselect the roll.

Page Viewer

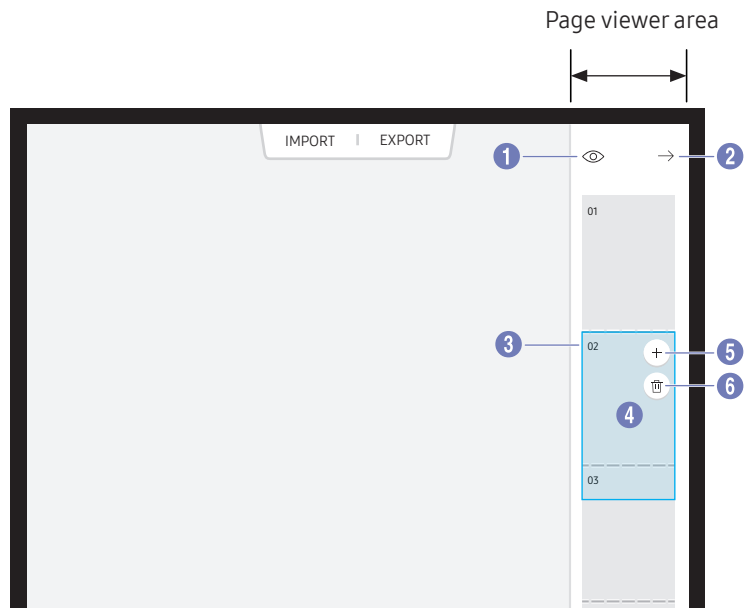
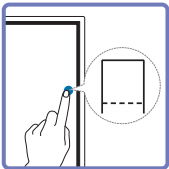

The displayed image may differ depending on the model.

You can move or edit the created rolls for each page.

Parts	Description
1	Preview the roll. The preview mode does not support the draw / erase function.
2	Close the page viewer.
3 Page number	Displays the page number.
4 Focus	Displays the page you are currently viewing. <ul style="list-style-type: none"> When you select a page, the focus is moved to it. Drag on the Page viewer area to move to other page. Touch and hold a page to open the page editing screen. On the page editing screen, press and drag the desired page to change its page order.
5	Add a new page to the focused position. You can create up to 20 pages per roll.
6	Delete the focused page.

Chapter 04





IMPORT



You can view the screen of a mobile device or laptop connected to the product, or import data such as images from a connected USB or network drive.

- Touch **IMPORT** at the top of the screen to select the desired device.
-  You can capture the screens you want from the imported content.



 The displayed image may differ depending on the model.

Icons	Description
	Displays the screen from a mobile device by using Smart View or Screen Mirroring function.
	Displays your laptop screen imported using HDMI connection or WiFi display.
	Displays images and dedicated files (.iwb) imported from a connected USB device.
	Displays images and dedicated files (.iwb) imported from a connected network drive.

-  Dedicated files (extension: iwb) are files created and saved by this product and are only available on the FLIP model.
-  Supportable image file formats: JPG, BMP, PNG, MPO

Connecting to a Mobile Device

IMPORT → MOBILE

Connecting using Smart View or Screen Mirroring



- 1 Drag down the top bar on the mobile device screen to start **Smart View** or **Screen Mirroring**.
 - 2 Select this product from the list of devices displayed on the screen.
 - The initial device name is **[Flip] Samsung WMH Series**.
- ✎ You can control the mobile device from the product screen.
 - ✎ HDCP-encrypted content may not be visible when connected.

Connecting using NFC tagging

- ✎ This function is supported only on Android 8.0 Oreo version or later of Samsung mobile devices.
- ✎ In writing mode, an NFC tagging can automatically perform Smart View or Screen Mirroring on your mobile device.

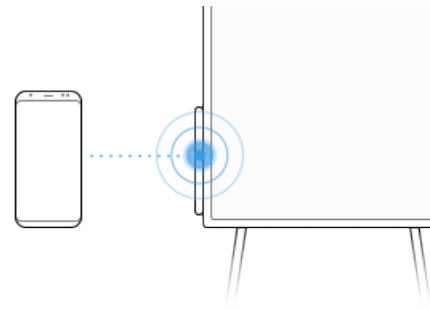

- 1 Turn on the **NFC** feature on a supported mobile device.
 - 2 Tag the mobile device to the **NFC pad** at the side of the product.
- ✎ You can control the mobile device from the product screen.

Connecting to a Laptop

IMPORT → LAPTOP

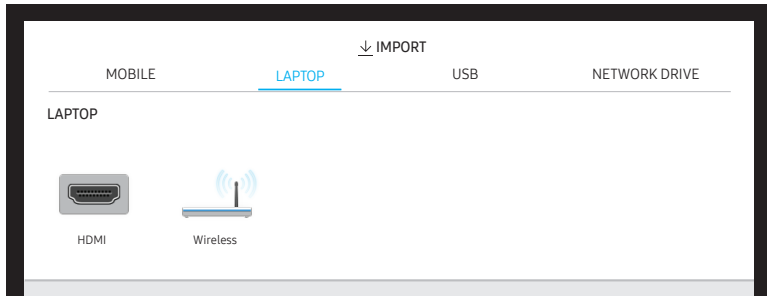

The displayed image may differ depending on the model.

Connecting using a cable

- 1 Connect the product to the laptop using an HDMI cable.

HDCP-encrypted content may not be visible when connected.



- 2 Select **IMPORT** → **LAPTOP** → **HDMI** from the top of the screen.
- 3 To control the laptop from the product screen, connect the supplied USB cable to the **TOUCH OUT** port on the product.

This function is supported only when the laptop screen is in both landscape orientation and the full screen mode.



Connecting via the WiFi Display function

This function is only available for the laptops that support the WiFi Display function.

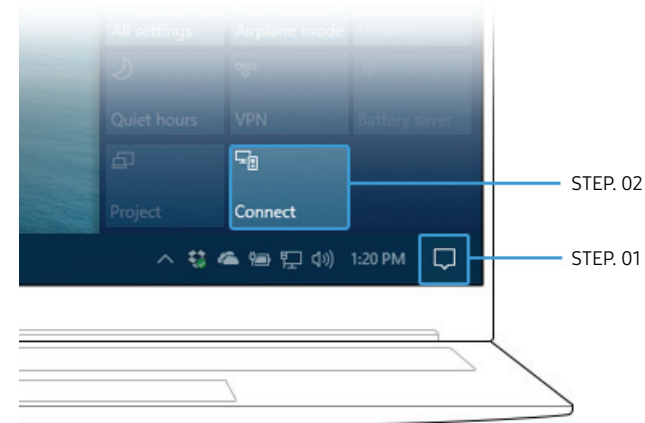

- 1 Select **Action Center** or **Devices** in the taskbar notification area of the laptop.
- 2 Click **Connect** or **Project** and select a [Flip] Samsung WMH Series device to complete the connection.

The connection procedure may vary depending on the laptop.

After the WiFi Display connection is made, you can control the laptop screen from the product screen.

This function is only supported by Windows 8.1 and Windows 10.

Importing from a USB Device

IMPORT → USB

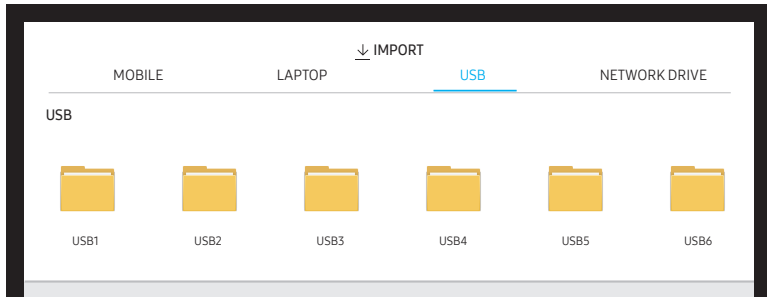

 The displayed image may differ depending on the model.

Connect an external HDD or a USB storage device.

 You can import only images and dedicated files (.iwb).

Importing from a Network Drive

IMPORT → NETWORK DRIVE

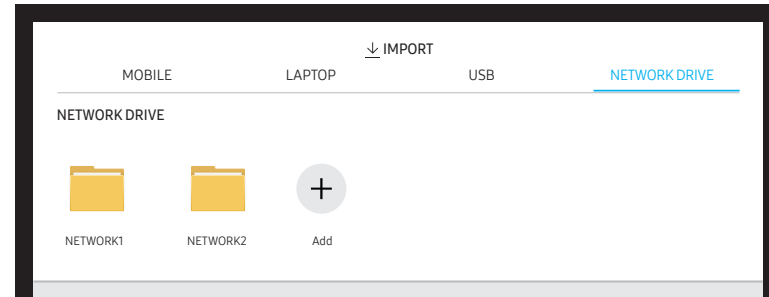

 The displayed image may differ depending on the model.

Connect the network drive to bring files.

 You can register a network drive while the network is connected.

For information about how to connect to a network, see '[Connecting to a network](#)'.

 You can register a network drive account at  → **Connect** → **Advanced Settings** → **Network Drive** → **Add Account**.

To register a network drive account, you must enter the **Address**, **Username**, and **Password**.

To register your network drive account, refer to '[Add Account](#)' for **NETWORK DRIVE**.

 You can import only images and dedicated files (.iwb).







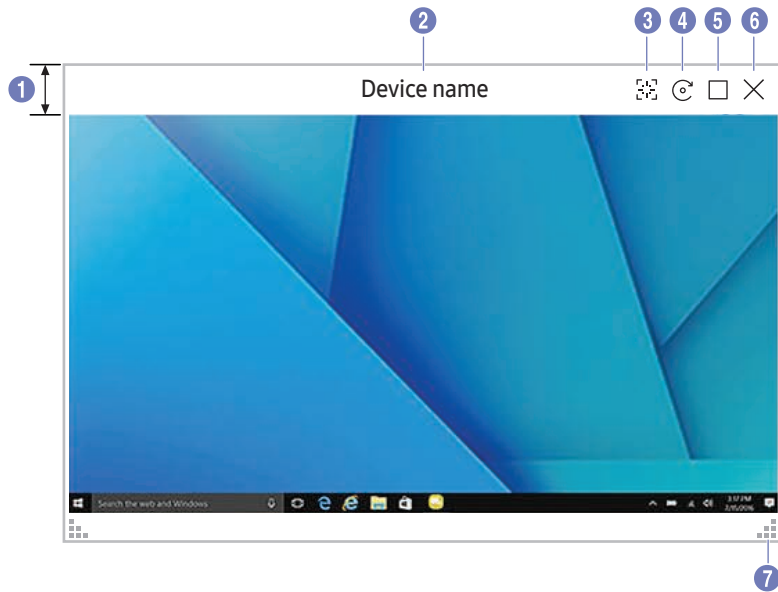

Source Window

When you connect a laptop or a mobile device to the product, the source window appears.

 This function is available only in the writing mode.



 The displayed image may differ depending on the model.

Parts	Description
1 Menu bar	Drag the source window to move to the desired position.
2 Device name	Displays the name of the connected device.
3 	Capture the source window.
4 	Rotate the source window.  This function is supported only on Android 8.0 Oreo version or later of Samsung mobile devices.
5 	Switch to the full screen mode. <ul style="list-style-type: none"> When the power button is pressed on the full screen mode, the screen returns to the original mode.  When the product is in portrait orientation, the full screen mode is supported only on the Android 8.0 Oreo version or later of Samsung mobile devices.  The full screen mode for the laptop is only supported in the landscape orientation.
6 	Close the source window.
7 	Adjust the size of the source window.





Chapter 05

EXPORT

You can export your created rolls in various ways.



 The displayed image may differ depending on the model.

Icons	Description
	Send your created rolls via email.
	Print your created rolls.
	Export your created rolls to a connected USB device.
	Export your created rolls to a registered and connected network drive.

Sending Email

EXPORT → EMAIL

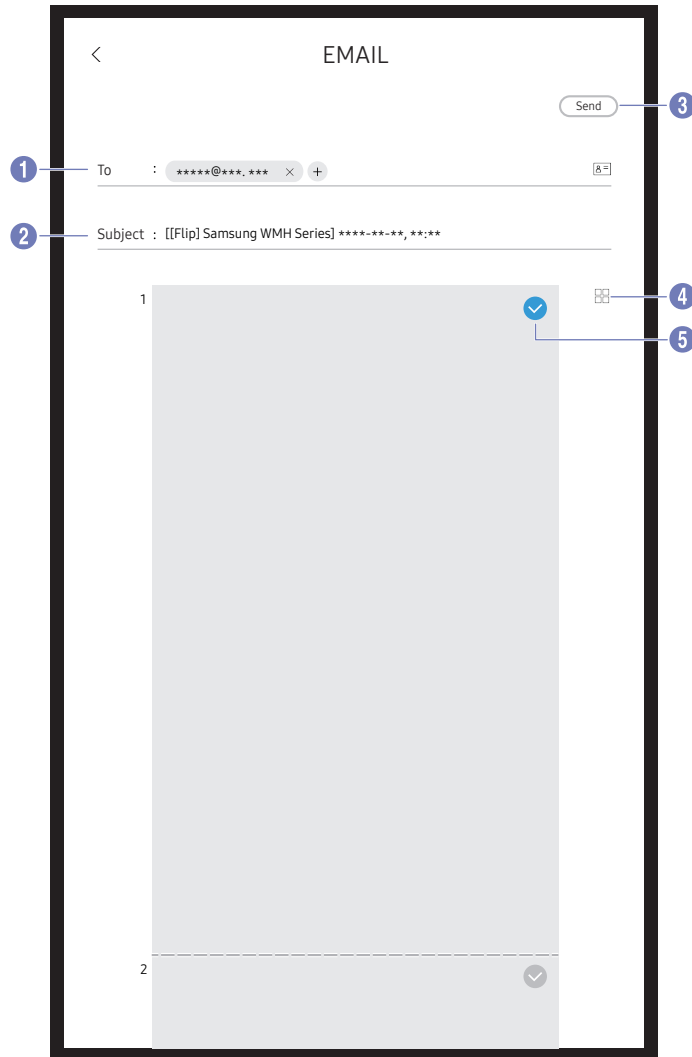

To send your created rolls via email, first register your email account.

- ✎ You can register your email account at ⚙️ → **Connect** → **Advanced Settings** → **Email**.
- ✎ If you set **Sender Authentication** to **Use** at ⚙️ → **Connect** → **Advanced Settings** → **Email**, you must authenticate your account each time you send an email. See below.
 - When **Sender Authentication** is set to **Use**, anyone who has a mail account on the same mail server (**SMTP Server Name, SMTP Port Number**) can send emails. But every time they send an email, they must enter their **Account** and **Password**.
 - When **Sender Authentication** is set to **Don't Use**, you can send emails only with the **Account** and **Password** registered in the product.
 - For the SMTP information required to register a mail server, contact your mail server administrator.
- ✎ Files saved as dedicated files are converted to .pdf files and sent.

Parts	Description
1 To	Enter the recipient's email address. <ul style="list-style-type: none"> • Press + and type text by using the virtual keyboard. • Press ✍️ on the virtual keyboard to enter text by handwriting. • To enter an email address automatically, tag an NFC card that has that email address entered. <ul style="list-style-type: none"> ✎ 📍: Explains where to tag the NFC tag. ✎ Using the NFC Writing App, register an email address with the NDEF Standard <Text> Record Type to an NFC Forum Type 2 Card sold on the market.
2 Subject	The email subject is automatically set to the device name and the current date.
3 Send	Send the email.
4 📄 / 📄	Change the page view mode for the roll to send.
5 ✓	Select the pages to send.

✎ The displayed image may differ depending on the model.

Printing

To print, you must set up the **Print Server** and the **Clock Set**.

To set up the **Print Server**, the product and the printer you want and your PC must be connected to the same network.

Flip Printing Software must be also installed on the PC connected.

- ✎ For information about how to connect to a network, see '[Connecting to a network](#)'.
- ✎ You can set up the **Print Server** at ⚙️ → **Connect** → **Print Server**.
- ✎ You can set **Clock Set** at ⚙️ → **System** → **Time** → **Clock Set**.
- ✎ The **Flip Printing Software** is available on its website
 - <http://displaysolutions.samsung.com>
 - <http://www.samsung.com>
- ✎ Devices that transfer files, such as virtual printers (PDF, XPS, One note, etc.) or fax machines, are not supported, but only printers that can print actual paper are supported.
- ✎ For print paper size, only A4 is supported.

Installing Flip Printing Software

Follow the onscreen instructions to install **Flip Printing Software**.

- ✎ The installation takes about 10 minutes, and the time taken may vary depending on your PC environment.

PC installation requirements

- Supported operating systems:
Windows 7(32/64 bit), Windows 10(32/64 bit), MAC
 - ✎ When installing the software, make sure that critical Windows updates are already installed. Update **Windows Update** to the latest version before beginning the setup.
 - ✎ For Windows 7, make sure that **Service Pack 1** is already installed.

Setting up the printer

After the **Flip Printing Software** is installed, make the following settings on the product onscreen menu.

Setting up automatically



- 1 Select ⚙️ → **Connect** menu.
- 2 Select **Print Server** → **Connect to Server** → **Auto**.

Setting up manually

- 1 Select ⚙️ → **Connect** menu.
- 2 Select **Print Server** → **Connect to Server** → **Manual**, and then enter the **Server IP** address of the PC where **Flip Printing Software** is installed.

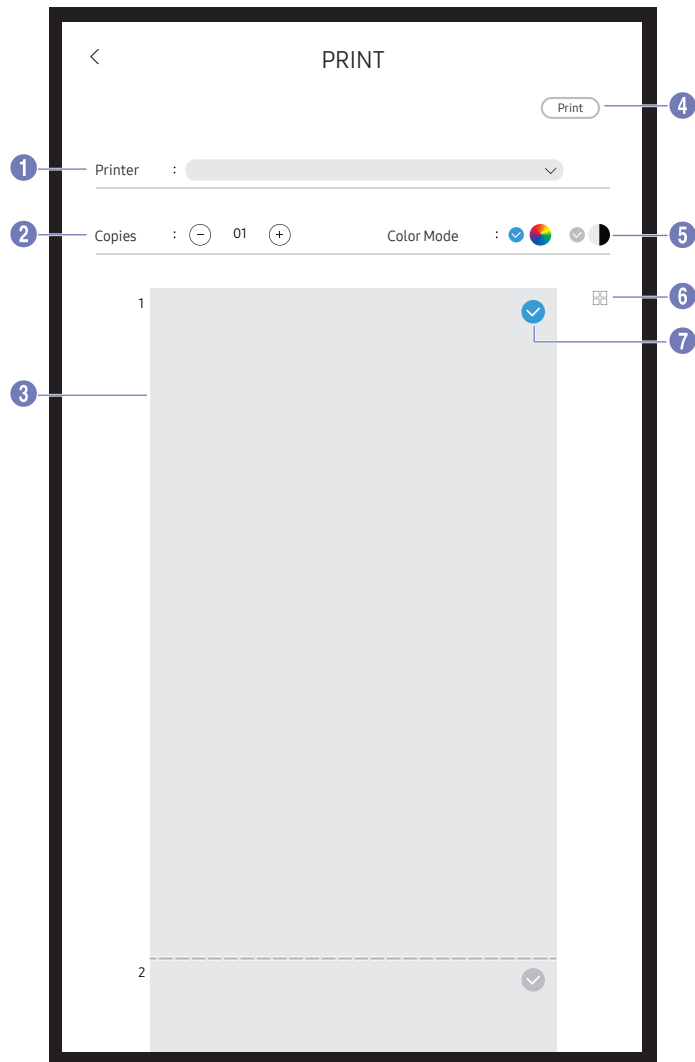
EXPORT → PRINT





Parts	Description
1 Printer	Displays a list of connected printers. Select a printer to print the roll with.
2 Copies	Set the number of prints.
3 Print preview area	Preview the roll to print.
4 Print	Start the printing.
5 Color Mode	Select the color to print the roll with.
6  / 	Change the page view mode of the roll to print.
7 	Select the pages to print.

 The displayed image may differ depending on the model.

Exporting to a USB Device

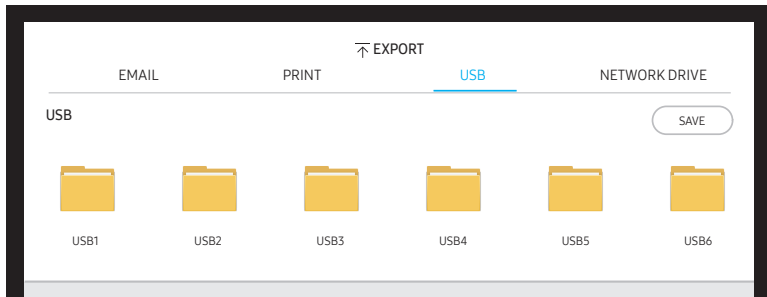
EXPORT → USB



 The displayed image may differ depending on the model.

Connect an external HDD or a USB storage device.

 You can save only the .iwb and .pdf file.

Exporting from a Network Drive

EXPORT → NETWORK DRIVE

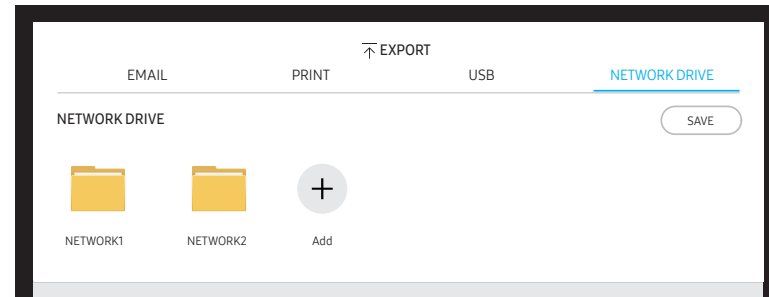

 The displayed image may differ depending on the model.

Connect the network drive to save files.

 You can register a network drive while the network is connected.

For information about how to connect to a network, see '[Connecting to a network](#)'.

 You can register a network drive account at  → **Connect** → **Advanced Settings** → **Network Drive** → **Add Account**.





To register a network drive account, you must enter the **Address**, **Username**, and **Password**.

To register your network drive account, refer to '[Add Account](#)' for **NETWORK DRIVE**.

 You can save only the dedicated files (.iwb).

Connect

2nd	3rd	Description
Network		Configure your device's network.
	Network Status	View your current network and internet status.
	Open Network Settings	Configure network settings to connect to an available network.
	Proxy Server	Set up your proxy server connection and related functions.
Device Connect Manager		Allow devices, like smartphones and tablets, on your network to share content with your product.
	Access Notification	Display a notification when a device, such as a smartphone or tablet, is connected. If you use a Wi-Fi network that requires a password, turn Off this option to automatically connect with devices without viewing notifications.
	Device List	View and manage connected devices.

2nd	3rd	Description
Advanced Settings	Email	Set up an email account for sending emails.  For more information, refer to ' Sending Email '.
	LDAP	<ul style="list-style-type: none"> • Set LDAP Connection Configure a new LDAP connection. <ul style="list-style-type: none"> - Use LDAP: Whether or not to use LDAP - Import Setup Value: Can fetch the following settings from LDAPConnectionConfig.txt stored on the USB(Password excluded) <ul style="list-style-type: none">  For more information, refer to 'How to create a text file for use of LDAP'. - User ID: DN(Distinguished Name) of the User ID that is used in the LDAP server. <ul style="list-style-type: none">  The format of User ID complies with the DN format of LDAP. e.g. cn=admin, dc=myldap, dc=com - Password: Password that is used for authentication of the LDAP server - Server Address: IP or URL of the LDAP server - Server Port Number: Port number of the LDAP server - Base DN: Top DN that is to be used for search in the DIT(Directory Information Tree) when connecting the LDAP - SSL/TLS: Whether or not to use SSL/TLS <ul style="list-style-type: none">  When SSL/TLS is set to be Use, the encrypted data communication is enabled. - Use Untrusted Certificates: Whether or not to allow untrusted certificates - Authentication Type: Select Basic or Anonymous for authentication of the corresponding LDAP server.

2nd	3rd	Description
Advanced Settings	LDAP	<ul style="list-style-type: none"> • LDAP Query Configuration Set the query for the connected LDAP. <ul style="list-style-type: none"> – UID: Change the user UID that is used in LDAP. – Email: Change the Email that is used in LDAP. – Name: Change the user name (common name) that is used in LDAP. – Last Name: Change the surname of the user that is used in LDAP. – Company name: Change the company name that is used in LDAP. – Department: Change the department name that is used in LDAP. – Custom Query: Fetches the user defined query from LDAPQuery.txt (case sensitive) stored on the USB. ✎ For more information, refer to 'How to create a text file for use of LDAP'. ✎ Press the Reset button to restore the settings to the factory defaults. ✎ When the mapping does not match, the search result does not include the attributes.

How to create a text file for use of LDAP

The LDAP configuration basically consists of many long sentences.

During LDAP configuration, FLIP can be fetched using the text file to prevent typos and make a batch setting.

 Input of file name and content should be case sensitive for correct operation.

- Format of LDAPConnectionConfig.txt

(1) Example of the text file

```
User ID=cn=Manager, dc=example, dc=com
Server Address=123.456.789.012
Server Port Number=12345
Base DN=dc=samsung, dc=example, dc=com
SSL/TLS=Don't Use
Use Untrusted Certificates=Don't Use
Authentication Type=Basic
```

(2) Allocation of values (VAL) for each key

```
User ID: Enter the User ID.
Server Address: Enter the IP or URL of the LDAP server.
Server Port Number: Enter the Port of the LDAP server.
SSL/TLS: Enter Use or Don't Use.
Use Untrusted Certificates: Enter Use or Don't Use.
Authentication Type: Enter Basic or Anonymous.
```

- Format of LDAPQuery.txt

(1) Example of the text file

```
Col=mail
Col=cn
Col=departmentNumber
Col=o
Query=((mail=*<A>*)(cn=*<A>*))
```





(2) Allocation of values (VAL) for each key

1) Col part

- In most cases, the above five rows are used and they are sequentially mapped to email, name, level, department and company.
- Each row is mapped based on the following grammar. Col is each attribute in LDAP and VAL is the value mapped in LDAP Query Configuration. Col is the name shown on the left in LDAP Query Configuration and VAL is the attribute displayed on the right in the LDAP Query Configuration menu. Col=VAL or Col=VAL+VAL
- You can select the value of the desired column (Col) and change it.
- Col=level indicates the title. It does not appear on the menu but it is used to display the search result.



2) Query part

- <A> is the Keyword that is used for a Search.
- The syntax for the Custom Query complies with the LDAP Query rule excluding <A>. For example, when <A> is included in the mail or cn attribute, you can create it as follows. Query=((mail=*<A>*)(cn=*<A>*))

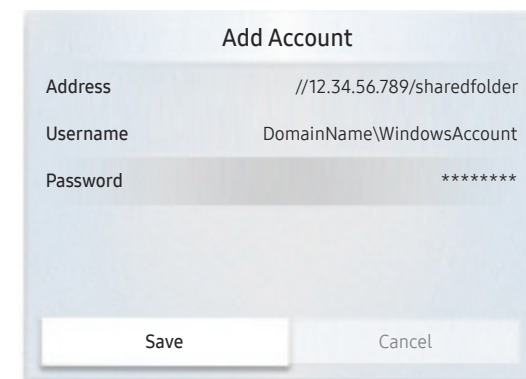
2nd	3rd	Description
Advanced Settings	Print Server	<p>Set up the Print Server to use the printing function.</p> <p> For more information, refer to 'Printing'.</p> <ul style="list-style-type: none"> • Connect to Server <ul style="list-style-type: none"> – Auto: View and select one from a list of server IP addresses of the PCs where Flip Printing Software is installed, available on the network. – Manual: Enter the Server IP address of the PC where Flip Printing Software is installed.
	Network Drive	<p>Add or edit network drive accounts. You can only add network drives by using Samba.</p> <ul style="list-style-type: none"> • Add Account: Add new network drive accounts. Only Samba can be added to the network drive. <p> SAMBA 2.0 or later is supported. If you cannot connect to the network drive, update SAMBA to the latest version.</p> <p> To register a network drive account, you must enter the Address, Username, and Password.</p> <ul style="list-style-type: none"> – Address: //computer IP address/shared folder name <ul style="list-style-type: none">  When entering an address, be sure to use / instead of W and \. For example, if you share a folder named "sharedfolder" on a PC with IP address of 12.34.56.789, enter "//12.34.56.789/sharedfolder" as the address. – Username: A Windows account with permissions to the shared folder <ul style="list-style-type: none">  When entering a domain, be sure to use W or \. For example, DomainName\WindowsAccount – Password: The password you set for your Windows account <ul style="list-style-type: none"> • Edit Account: Edit network drive accounts.



System

2nd	3rd	Description
Language		Change your Language settings.
Time		Configure various time-related settings.
	Clock Set	Set current date and time.
	DST	Adjust clock for Daylight Saving Time.  Start Date, End Date and Time Offset are enabled only when DST is set to On .
Smart Security		Security provided to protect your display device and connected storage devices against viruses includes.
	Scan	Inspect your display device and connected storage devices to check for viruses.
	Isolated List	Check the list of items that have been isolated they contain viruses.
Change PIN		Change the 4-digit password required to use the Advanced Settings functions and the Reset All function.  The default PIN number is 0000.
Device Name		Enter Device Name. You can find this name on the device being used over the network.

2nd	3rd	Description
Advanced Settings		Configure advanced settings which includes USB Lock , Network Lock , Delete All Files , etc. Enter your 4 digit PIN number. The default PIN number is "0000".  If you want to change the PIN number, use the Change PIN function.
	Screen Saver	Set up the Screen Saver . You can select an image to use as the Screen Saver .
	USB Lock	Set up a USB Lock . After setting up, the device will be restarted to apply the settings.
	Network Lock	Set up a Network Lock . After setting up, the device will be restarted to apply the settings.
	Auto Save	Automatically save all data.
	Motion Sensor	Set up a motion sensor to automatically shut down your product when no motion is detected over a certain period of time.
	Delete All Files	Delete all data from the device, including locked data.
	Period for Delete All	Set a reset interval at which all data on the internal storage will be deleted regularly.
	Clone Product	Export this device's settings or import from other devices.
	Start Setup	Go through the initial setup steps like you did the first time you used this product.

Picture

2nd	3rd	Description
Backlight		Adjust backlight brightness to suit your preference. 100 is the brightest setting.
Color Temperature		It sets color temperature. The value and temperature increase simultaneously, so the ratio of blue color rises. (Range: 2800K - 16000K)
White Balance	R-Offset / G-Offset / B-Offset / R-Gain / G-Gain / B-Gain / Reset	Adjust the color temperature of the picture so that white objects appear brighter.
HDMI Black Level		Adjust the black level to optimize the HDMI picture brightness and contrast.  This function is available only when the product is connected to a laptop using an HDMI cable and the Source window is turned on.
Reset Picture		Restore all picture settings to the factory default.

Support

2nd	3rd	Description
Software Update		Update the software installed on your product.
	Update Now	Update software by downloading update files. <ul style="list-style-type: none">• Current version: This is the software version already installed in the product.
Contact Samsung		You can find information regarding our call centers and how to download products and software.  Contact Samsung and find the product Model Code and Software Version .
Reset All		It initializes all items in the total menu.

Chapter 07

Troubleshooting Guide

Problems and Solutions

 Before calling Samsung Customer Service Center, test your product as follows. If the problem persists, contact Samsung Customer Service Center.

 If the product is not turned on or off when you operate the buttons or motion sensor of the product, you can turn it on or off with the Samsung remote control or Samsung remote control application.

Source window (HDMI) issue	
Blank spaces are found on all four sides of the screen when an HDMI cable is connected to the product and PC.	The blank spaces found on the screen have nothing to do with the product.
	Blank spaces on the screen are caused by the PC or graphics card. To resolve the problem, adjust the screen size in the HDMI settings for the graphics card.
	If the graphics card settings menu does not have an option to adjust the screen size, update the graphics card driver to the latest version. (Please contact the graphics card or computer manufacturer for further details about how to adjust the screen settings.)
The images on the screen look distorted.	Check the cable connection to the product.
The screen is not clear. The screen is blurry.	Set the resolution and frequency to the recommended level.
The screen appears unstable and shaky.	Check that the resolution and frequency of the PC and graphics card are set within a range compatible with the product. Then, change the screen settings if required by referring to 'Preset Timing Modes'.
There are shadows or ghost images left on the screen.	

Source window (HDMI) issue	
White does not really look white.	Go to Picture and adjust the White Balance settings.
The product will turn off automatically.	Make sure the power cable is connected properly to the product and power outlet.
The screen display does not look normal.	Encoded video content may cause the display to appear corrupted in scenes featuring fast moving objects such as in a sports event or action video.
	Low signal level or low picture quality may cause the display to appear corrupted. This does not mean the product is defective.
	A cell phone within a distance of one-meter radius may cause static on analog and digital products.
The brightness and color do not look normal.	From the menu, select Support → Reset All to try resetting the screen.
The display looks unstable and then freezes.	The screen may freeze when a resolution other than the recommended resolution is used or if the signal is not stable. To resolve the issue, change the PC resolution to the recommended resolution.
The screen cannot be displayed in full screen.	If the source window is set to full screen mode while in portrait orientation, a black bar appears at both the top and bottom. Change to landscape orientation, and then switch the Source window to full screen mode.

Sound issue	
There is no sound.	Check the volume.
The volume is too low.	Adjust the volume.
	If the volume is still low after turning it up to the maximum level, adjust the volume on your PC sound card or software program.
Video is available but there is no sound.	If an HDMI cable is connected, check the audio output settings on the PC.
	If a source device is used <ul style="list-style-type: none"> • Check the audio output settings for the source device. (For example, if your monitor is connected to HDMI, you may need to change the audio option of your video output device to HDMI.)
	Reconnect the power cable to the device and then reboot the device.
There is static coming from the speakers.	Low signal level can cause corrupted sound.
There is audible sound when the volume is muted.	Audio settings for main speakers are separate from the internal speakers on the product. Changing or muting the volume on the product does not affect an external amplifier(decoder).

Touch function issues	
The icons can be touched but the drawings cannot.	Use the provided product-specific pen.
Drawing and erasing do not work when the Source window is open.	In the PIP mode, the drawing function is not supported within the Source window. In the source window, drawings in a PC application such as Paint are made by that PC application.
Touching does not work when HDMI connection is used.	When the product is connected to a PC, make sure that the PC screen is in the full screen mode (landscape).
	Check whether the TOUCH OUT port on the product is connected to a USB port on the PC using a USB cable.
I use two pens, but they do not work well.	Make sure that there is enough space between the two pens at multi-touching.
Touches break, reaction speed gets slow, and so on.	Make sure that there are no foreign substances on the screen surface.
	Check whether the screen is broken.
	Make sure that the product is not exposed to direct sunlight.

Other issue	
The product smells like plastic.	The plastic smell is normal and disappears over time.
Small particles are found on the edges of the product.	The particles are part of the product design. The product is not defective.
When I try to change the PC resolution, a message " The defined resolution is not currently supported. " appears.	The message " The defined resolution is not currently supported. " appears if the input source resolution exceeds the maximum resolution of the product. To resolve the issue, change the PC resolution to a resolution supported on the product.
There is no sound from the speakers in HDMI mode when a DVI-HDMI cable is connected.	DVI cables do not transmit sound data.
HDMI Black Level is not functioning properly on an HDMI device with YCbCr output.	This function is available only when a source device, such as a DVD player and STB, is connected to the product via an HDMI (RGB signal) cable.
There is no sound in HDMI mode.	Displayed picture colors may not look normal. Video or sound may not be available. This can occur if a source device that only supports an older version of the HDMI standard is connected to the product.

Chapter 08

Specifications

General

Horizontal Frequency

The time required to scan a single line from the left to the right side of the screen is called a horizontal cycle. The reciprocal number of a horizontal cycle is called horizontal frequency. Horizontal frequency is measured in kHz.

Vertical Frequency

The product displays a single image multiple times per second (like a fluorescent light) to display what the viewer sees. The rate of a single image being displayed repeatedly per second is called vertical frequency or refresh rate. Vertical frequency is measured in Hz.

Model Name		WM55H
Panel	Size	55 CLASS (54.6 inches / 138.7 cm)
	Display area	1209.60 mm (H) x 680.40 mm (V) / 47.6 inches (H) x 26.8 inches (V)
Synchronization	Horizontal Frequency	30 - 81 kHz, 30 - 90 kHz (HDMI)
	Vertical Frequency	48 - 75 Hz, 24 - 75 Hz (HDMI)
Resolution	Optimum resolution	1920 x 1080 @ 60 Hz, 3840 x 2160 @ 30 Hz
	Maximum resolution	1920 x 1080 @ 60 Hz, 3840 x 2160 @ 30 Hz
Power Supply		AC100-240V~ 50/60Hz Refer to the label at the back of the product as the standard voltage can vary in different countries.
Environmental considerations	Operating	Temperature : 32 °F – 104 °F (0 °C – 40 °C) * For installing the housing, keep the internal temperature at 40 °C or below. Humidity : 10% – 80%, non-condensing
	Storage	Temperature : -4 °F – 113 °F (-20 °C – 45 °C) Humidity : 5% – 95%, non-condensing * Applicable before the product package is unpacked.

 Plug-and-Play

This monitor can be installed and used with any Plug-and-Play compatible systems. Two-way data exchange between the monitor and PC system optimizes the monitor settings. Monitor installation takes place automatically. However, you can customize the installation settings if desired.

 Due to the nature of the manufacturing of this product, approximately 1 pixel per million (1ppm) may appear brighter or darker on the panel. This does not affect product performance.

 This is a class A product. In a domestic environment this product may cause radio interference in which case the user may be required to take adequate measures.

 For detailed device specifications, visit the Samsung Electronics website.

(USA only)

Dispose unwanted electronics through an approved recycler.

To find the nearest recycling location, go to our website: www.samsung.com/recyclingdirect or call, (877) 278 - 0799

Preset Timing Modes

 This product can be set to only one resolution for each screen size to obtain the optimum picture quality due to the nature of the panel. Using a resolution other than the specified resolution may degrade the picture quality. To avoid this, it is recommended that you select the optimum resolution specified for your product.

The screen will automatically be adjusted if a signal that belongs to the following standard signal modes is transmitted from your PC. If the signals transmitted from the PC differ from the standard mode, the screen may not be displayed. In such a case, change the settings as shown in the following table by referring to the graphics card user manual.

Resolution	Horizontal Frequency (kHz)	Vertical Frequency (Hz)	Pixel Clock (MHz)	Sync Polarity (H/V)
IBM, 640 x 480	31.469	59.940	25.175	-/-
IBM, 720 x 400	31.469	70.087	28.322	-/+
MAC, 640 x 480	35.000	66.667	30.240	-/-
MAC, 832 x 624	49.726	74.551	57.284	-/-
MAC, 1152 x 870	68.681	75.062	100.000	-/-
VESA, 640 x 480	31.469	59.940	25.175	-/-
VESA, 640 x 480	37.861	72.809	31.500	-/-
VESA, 640 x 480	37.500	75.000	31.500	-/-
VESA, 800 x 600	35.156	56.250	36.000	+/+
VESA, 800 x 600	37.879	60.317	40.000	+/+
VESA, 800 x 600	48.077	72.188	50.000	+/+

Resolution	Horizontal Frequency (kHz)	Vertical Frequency (Hz)	Pixel Clock (MHz)	Sync Polarity (H/V)
VESA, 800 x 600	46.875	75.000	49.500	+/+
VESA, 1024 x 768	48.363	60.004	65.000	-/-
VESA, 1024 x 768	56.476	70.069	75.000	-/-
VESA, 1024 x 768	60.023	75.029	78.750	+/+
VESA, 1152 x 864	67.500	75.000	108.000	+/+
VESA, 1280 x 720	45.000	60.000	74.250	+/+
VESA, 1280 x 800	49.702	59.810	83.500	-/+
VESA, 1280 x 1024	63.981	60.020	108.000	+/+
VESA, 1280 x 1024	79.976	75.025	135.000	+/+
VESA, 1366 x 768	47.712	59.790	85.500	+/+
VESA, 1440 x 900	55.935	59.887	106.500	-/+
VESA, 1600 x 900	60.000	60.000	108.000	+/+
VESA, 1680 x 1050	65.290	59.954	146.250	-/+
VESA, 1920 x 1080	67.500	60.000	148.500	+/+
CEA, 3840 x 2160	67.500	30.000	297.000	-/-

Chapter 09

Appendix

Responsibility for the Pay Service (Cost to Customers)

 When the service is requested, in spite of in warranty, we may charge you for a visit from a service technician in the following cases.

Not a product defect

Cleaning of the product, Adjustment, Explanation, Re-installation and etc.

- If a service technician is requested to give instructions on how to use product or simply adjusts options without disassembling product.
- If a defect is caused by external environmental factors (Internet, Antenna, Wired Signal, etc.)
- If a product is reinstalled or devices are connected additionally after installing the purchased product for the first time.
- If a product is reinstalled to move to a different spot or to move to a different house.
- If the customer requests instructions on how to use another company's product.
- If customer requests instructions on how to use the network or another company's program.
- If customer requests software installation and setup for the product.
- If a service technician removes/cleans dusts or foreign materials inside of the product.
- If customer requests an installation additionally after purchasing a product through home-shopping or online.

A Product damage caused by customer's fault

Product damage caused by customer's mishandling or wrong repair

If a product damage is caused by;

- External impact or drop.
- Use of supplies or separately sold product unspecified by Samsung.
- Repair from a person besides an engineer of outsourcing service company or partner of Samsung Electronics Co., Ltd.
- Remodeling or repairing the product by customer.
- Using it with incorrect voltage or non-authorized electrical connections.
- Not following the "cautions" in User Manual.

Others

- If product fails by natural disaster. (lightning, fire, earthquake, flood damage, etc)
 - If consumable components are all used up. (Battery, Toner, Fluorescent lights, Head, Vibrator, Lamp, Filter, Ribbon, etc.)
-  If customer requests a service in case the product has no defect, service fee may be charged. So please read User Manual first.

Prevention of Afterimage Burn-in

What is afterimage burn-in?

Afterimage burn-in should not occur when the panel is operating normally. Normal operation refers to a continuously changing video pattern. If the panel displays a fixed pattern for an extended period of time a slight voltage difference may occur between the electrodes in pixels that control the liquid crystals.

Such a voltage difference between electrodes increases with time and makes the liquid crystals thinner. When this occurs, a previous image can remain on the screen when the pattern changes.

-  This information is a guide to prevent afterimage burn-in. Viewing a fixed screen for an extended period of time may cause afterimage burn-in. This problem is not included in warranty.

Recommended prevention practices

Viewing a fixed screen for an extended period of time may cause afterimage burn-ins or smudges. Turn off the product when it is not used for a long time, activate the Power Saving mode, or run a moving screen saver.

License



The terms HDMI and HDMI High-Definition Multimedia Interface, and the HDMI Logo are trademarks or registered trademarks of HDMI Licensing LLC in the United States and other countries.

Open Source Licence Notice

In the case of using open source software, Open Source Licences are available on the product menu. Open Source Licence Notice is written only English.

For information on the Open Source Licence Notice, contact the Samsung Customer Center or send email to oss.request@samsung.com.
