

User Manual

SBB-MBOX

The color and the appearance may differ depending on the product, and the content in the manual is subject to change without prior notice to improve the performance.

An administration fee may be charged in the following situations:

- (a) An engineer is called out at your request, but it is found that the product has no defect (i.e., where the user manual has not been read).
- (b) You bring the unit to a repair center, but it is found that the product has no defect (i.e., where the user manual has not been read).

You will be informed of the administration fee amount before a technician visits.

Table of contents

Before Using the Product

Safety Precautions	6
Safety symbols	6
Electricity and Safety	7
Installation	8
Operation	8
Cleaning	10

Preparations

Checking the Components	11
-------------------------	----

Parts	12
Front Side	12
Reverse Side	13
BRIDGE BOX	14

Remote Control	15
----------------	----

Prior to Installation	17
Precautions for installation	17

Installing M-Box on Rack Case	17
-------------------------------	----

Connecting and using devices

Before Connecting	18
Pre-connection Checkpoints	18

Connecting to a PC	18
Connection Using an HDMI Cable	18
Connection Using an HDMI-DVI Cable	19

Connecting to a Video Device	19
Connection Using an HDMI-DVI Cable	19
Connection Using an HDMI Cable	20

Connecting the LAN Cable	20
--------------------------	----

Connecting a Optical Cable	21
----------------------------	----

Multiple Display Control	21
Cable Connection	21

External Device Connection Cables	24
Connecting using an HDMI Cable	25

Changing the Input source	26
Sources	26

AMBIENT

Ambient Settings	27
Auto Brightness	27
Sleep After	27
Reset All Photos	27

My W Edition	27
About My W Edition	27

Décor	28
About Décor	28

Nature	28
About Nature	28

Art	28
About Art	28

Media Art	28
About Media Art	28

My Collection	29
About My Collection	29

Background Theme	29
Background Theme	29

Using content effects	29
Style & Settings	29
Screen Settings	29
View Details	29

Table of contents

ENTERTAINMENT

Notification	30
Settings	30
Picture Mode	30
Sound Mode	30
Sound Output	31
Game Mode	31
Caption	31
Sleep Timer	31
Network	31
More	31
Source	31
Connection Guide	31
Universal Remote Setup	32
Search	32
Apps	32

Screen Adjustment

Picture Mode	33
Picture Size Settings	33
Picture Size	33
Fit to Screen	34
Zoom and Position	34
Expert Settings	34
Backlight / Brightness / Contrast / Sharpness / Color / Tint (G/R)	34
Apply Picture Settings	34
Digital Clean View	35
Auto Motion Plus Settings	35
LED HDR	35
Contrast Enhancer	35
Film Mode	35
Color Tone	35
White Balance	36
Gamma	36
RGB Only Mode	36
Color Space Settings	36
Reset Picture	36

Sound Adjustment

Sound Output	37
Sound Mode	37
Wi-Fi Speaker Surround Setup	38
Expert Settings	38
Woofer & Equalizer	38
Digital Output Audio Format	38
Digital Output Audio Delay	38
Dolby Atmos Compatibility	38
Sound Feedback	38
Reset Sound	38

Table of contents

General

Intelligent Mode Settings	39
Intelligent Mode	39
Adaptive Brightness	39
<hr/>	
Bixby Voice settings	39
Before Using Bixby	40
Requirements for Bixby Use	40
Using Bixby	40
Starting Bixby using buttons on the Samsung Smart Remote	41
Getting to Know the Explore Bixby Screen	42
<hr/>	
Network	43
Network Status	43
Open Network Settings	43
Network Settings (Wired)	44
Network Settings (Wireless)	46
Reset Network	48
Expert Settings	48
<hr/>	
System Manager	48
Time	48
Language	49
Device Name	49
Samsung Account	49
Change PIN	49
Auto Protection Time	49
Smart Security	49
<hr/>	
External Device Manager	50
Anynet+ (HDMI-CEC)	50
Game Mode	52

Input Signal Plus	52
HDMI Black Level	52
Device Connect Manager	52
<hr/>	
Apple AirPlay Settings	52
<hr/>	
Eco Solution	53
Ambient Light Detection	53
Minimum Backlight	53
Power Saving Mode	53
Motion Lighting	53
Auto Power Off	53
<hr/>	
Accessibility	54
Voice Guide Settings	54
High Contrast	54
Grayscale	54
Color Inversion	55
Enlarge	55
Caption Settings	55
Remote Button Repeat Settings	55
<hr/>	
Smart Features	55
Autorun Last App	55
<hr/>	
Reset	55

Support

Software Update	56
Update Now	56
Auto update	56
<hr/>	
Self Diagnosis	56
Start Picture Test	56
Start Sound Test	56
Signal Information	56
Samsung The Wall Device Manager	57
Start Smart Hub Connection Test	57
Reset Smart Hub	57
<hr/>	
Remote Management	57
<hr/>	
About Samsung The Wall	57
<hr/>	
Terms & Policy	57

Troubleshooting Guide

Requirements Before Contacting Samsung Customer Service Center	58
Testing the Product	58
Checking the Resolution and Frequency	58
Check the followings.	59

Table of contents

Specifications

General	63
Preset Timing Modes	64

Appendix

Responsibility for the Pay Service (Cost to Customers)	66
Not a product defect	66
A Product damage caused by customer's fault	66
Others	66
License	67





Chapter 01







Before Using the Product

Safety Precautions

The following safety instructions are to ensure your personal safety and prevent property damage. Please read the following to ensure the proper use of the product.

Safety symbols

Symbol	Name	Meaning
	Warning	A serious or fatal injury may result if instructions are not followed.
	Caution	Personal injury or damage to properties may result if instructions are not followed.
	Prohibition	Do NOT attempt.
	Instruction	Follow directions.

CAUTION			
RISK OF ELECTRIC SHOCK. DO NOT OPEN.			
CAUTION: TO REDUCE THE RISK OF ELECTRIC SHOCK, DO NOT REMOVE COVER (OR BACK). THERE ARE NO USER SERVICEABLE PARTS INSIDE. REFER ALL SERVICING TO QUALIFIED PERSONNEL.			
	This symbol indicates that high voltage is present inside. It is dangerous to make any kind of contact with any internal part of this product.		AC voltage: Rated voltage marked with this symbol is AC voltage.
	This symbol indicates that this product has included important literature concerning operation and maintenance.		DC voltage: Rated voltage marked with this symbol is DC voltage.
	Class II product: This symbol indicates that a safety connection to electrical earth (ground) is not required. If this symbol is not present on a product with a mains lead, the product MUST have a reliable connection to protective earth (ground).		Caution. Consult instructions for use: This symbol instructs the user to consult the user manual for further safety related information.

Electricity and Safety

 The following images are for reference only. Real-life situations may differ from what is shown in the images.

Warning





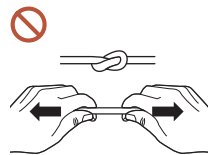

Do not touch the power plug with wet hands. Otherwise, an electric shock may result.

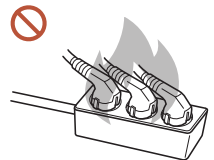

Do not bend or pull the power cable with force. Be careful not to leave the power cable under a heavy object. Product failure, an electric shock or fire may result from a damaged cable.



Do not connect multiple products to a single power socket. Overheated power sockets may cause a fire.

-  Insert the power plug all the way in so it is not loose. An unsecure connection may cause a fire.
-  Clean any dust around the pins of the power plug or the power socket with a dry cloth. A fire may result.
-  Connect the power plug to a grounded power socket. (Except for devices that do not provide grounding) An electric shock or injury may result.
-  Do not use a damaged power plug or a loose power socket. An electric shock or fire may result.

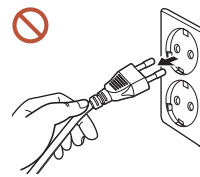

Caution

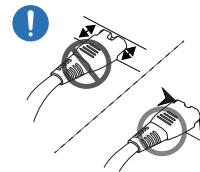

Hold the plug when disconnecting the power cable from the power socket. An electric shock or fire may result.









When connecting the power plug to the port, be sure to connect it completely. If the power plug is not completely connected to the port, the plug may be unexpectedly disconnected, or there is a risk of overheating due to overcurrent, leading to safety accidents.

-  Only use the power cable provided with your product by Samsung. Do not use the power cable with other products. An electric shock or fire may result.
-  Keep the power socket where the power cord is connected unobstructed. When a problem occurs with the product, the power cord must be unplugged to completely cut off power to the product. The power is not completely cut off by using only the Power button on the body of the product.
-  Do not disconnect the power cable while the product is being used. The product may become damaged by an electric shock.









Installation



Warning

-  Before moving the product, turn off the power switch and disconnect the power cable and all other connected cables.
Damage to the cable may cause a fire or electric shock.
-  When installing the product, keep it at a distance from the wall so that it is well ventilated.
An increased internal temperature may cause a fire.
-  If the product is installed in an unusual location, the surrounding environment may cause a serious quality problem. Therefore, be sure to contact Samsung Customer Service Center before installation.
(Places where many fine dusts are generated, places where chemicals are used, places with too high or low temperatures, places with a lot of moisture or water, transportation equipment such as vehicles, airports and stations used continuously for a long time, and more)
-  Do not install the product in a poorly ventilated space such as bookcase or closet.
An increased internal temperature may cause a fire.
-  Keep the plastic packaging out of the reach of children.
Children's misuse of the plastic packaging may cause suffocation.
-  Do not install the power cable (DC power supply) and the product near heat sources.
(Candles, mosquito repellents, cigarettes, sprays, heating devices, places exposed to direct sunlight, and more)



Operation

Warning

-  If the product generates a strange noise, a burning smell, or smoke, unplug the power plug immediately and contact your Samsung Customer Service Center.
An electric shock or fire may result.
-  If a gas leakage is found, do not touch the product or the power plug, and ventilate the room immediately.
Sparks can cause an explosion or fire.
-  Keep the remote control batteries and the small accessories out of the reach of children. Ensure children do not swallow any of them.
If children have had the battery in their mouths, consult your doctor immediately.
-  If the product is dropped or its appearance is damaged, turn off the power switch and disconnect the power cord. Then contact Samsung Customer Service Center.
Continued use can result in an electric shock or a fire.
-  Do not move the product by pulling the power cord or any cable.
Product failure, an electric shock or fire may result from a damaged cable.
-  Ensure the vents are not blocked by tablecloths or curtains.
An increased internal temperature may cause a fire.
-  Do not apply an impact to the product.
 - The screen display may be damaged.
 - An electric shock or fire may result.
-  Do not insert metallic objects (chopsticks, coins, hairpins, etc) or objects that burn easily (paper, matches, etc) into the product (via the vent or input/output ports, etc).
 - If foreign substances enter the product, be sure to power off the product and disconnect the power cord. Then contact Samsung Customer Service Center.
 - Product failure, an electric shock or fire may result.

-
-  Do not place objects containing liquid (vases, pots, bottles, etc) or metallic objects on top of the product.
 - If foreign substances such as water enter the product, be sure to disconnect the power cord. Then contact Samsung Customer Service Center.
 - Product failure, an electric shock or fire may result.
 -  During a lightning or thunderstorm, power off the product and disconnect the power cord.

An electric shock or fire may result.
 -  While the power plug is plugged into a power socket, do not insert a chopstick or other conductor into a remaining power socket. Also, after disconnecting the power plug from the power socket, do not touch the pins of the plug immediately.

Otherwise, an electric shock may result.
 -  There is a high voltage inside the product. Never disassemble, repair or modify the product yourself.
 - Contact Samsung Customer Service Center for repairs.
 - An electric shock or fire may result.
 -  Do not use humidifiers or stoves around the product.

An electric shock or fire may result.





Caution

-  Insert each battery so that its polarity (+, -) is correct.

If the polarity is not correct, the battery may rupture or the internal fluid may leak, causing contamination and damage to the surroundings, fire, or personal injury.
-  When you do not use the product for a long time due to vacation or other reason, disconnect the power cord from the power socket.

Dust accumulation combined with heat can cause a fire, electric shock or electric leakage.
-  The batteries (and rechargeable batteries) are not ordinary refuse and must be returned for recycling purposes. The customer is responsible for returning the used or rechargeable batteries for recycling.

The customer can return used or rechargeable batteries to a nearby public recycling center or to a store selling the same type of the battery or rechargeable battery.
-  Do not use or keep combustible spray or an inflammable substance near the product.

An explosion or fire may result.
-  Do not place heavy objects on the product.

Product failure or personal injury may result.
-  Use only the specified standardized batteries, and do not use a new battery and a used battery at the same time.

Otherwise, the batteries may be damaged or cause fire, personal injury or damage due to a leakage of the internal liquid.
-  Do not lift or move the product when it is in operation.

Cleaning

Warning

-  Do not spray water or cleaner directly on the product.
 - The product's surface may be damaged, or the markings may be erased.
 - An electric shock or fire may result.

Caution

-  When cleaning, be sure to disconnect the power plug and wipe gently with a soft and dry cloth such as superfine fibers or cotton flannels to prevent scratches.

The product's surface may be damaged, or the markings may be erased.
-  Only use a soft cloth (e.g. microfiber, flannel) on the surface of the product to avoid scratches.

The product's surface or the screen display can be easily scratched with foreign substances.
-  Do not apply chemicals containing alcohol, solvent, or surfactant such as wax, benzene, thinner, pesticide, air freshener, lubricant, or cleaner to the product.

The product's exterior may be discolored or cracked, the surface of the screen may be peeled off, or the markings may be erased.

Chapter 02

Preparations

Checking the Components

Contact the vendor where you purchased the product if any components are missing.

The appearance of the components may differ from the images shown.



Simple User Guide



Warranty card
(Not available in some locations)



Power cord

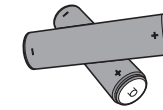

Batteries (AAA x 2)
(Not available in some locations)

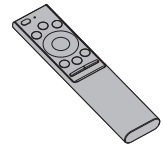

Remote Control



AC/DC adapter

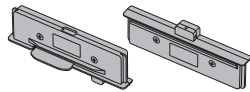

Sensor (Top x 2 / Bottom x 2)



24 Pin System Cable x 5

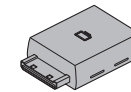

Module RX x 8

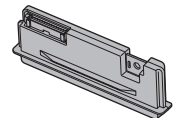

Bluetooth/Wi-Fi module

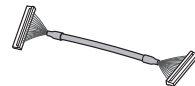

Bluetooth/Wi-Fi module cable

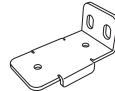

Rack case mounting bracket x 2



Screw (M4 x L8) x 4



Screw (M5 x L12) x 4

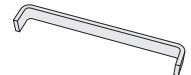

GUIDE CUSHION x 2

Parts

Front Side

 The color and shape of parts may differ from what is shown. Specifications are subject to change without notice to improve quality.



Parts	Description
⏻	Turn the product on or off.
USB 2.0	Connect to a USB memory device.

Reverse Side

 The color and shape of parts may differ from what is shown. Specifications are subject to change without notice to improve quality.

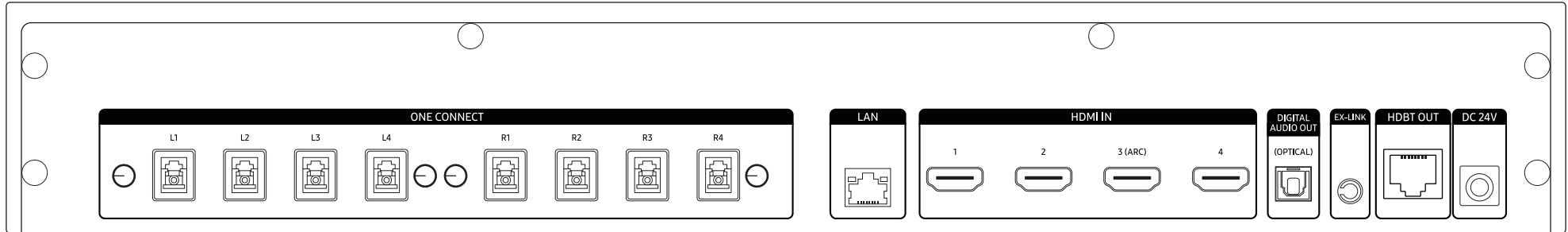



Parts	Description
ONE CONNECT (L1, L2, L3, L4)	Connects to a cable using an LC fiber cable.
ONE CONNECT (R1, R2, R3, R4)	
LAN	Connect to a network using the LAN cable. (10/100 Mbps)
HDMI IN (1, 2, 3 (ARC), 4)	Connects to a source device using a HDMI cable or HDMI-DVI cable.
DIGITAL AUDIO OUT(OPTICAL)	Connects to a audio device using the optical(digital) cable.

Parts	Description
EX-LINK	Dedicated to service technicians.  This port is for servicing only and has no user function. Do not connect a cable to this port.
HDBT OUT	Connects to the HDBT IN port on the BRIDGE BOX using a LAN cable.
DC 24V	Connects to the AC/DC adapter.

BRIDGE BOX

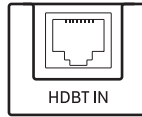
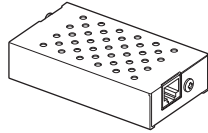
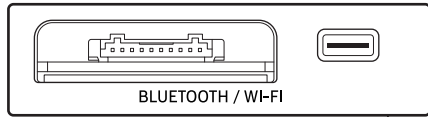
 The color and shape of parts may differ from what is shown. Specifications are subject to change without notice to improve quality.



Parts	Description
BLUETOOTH / WI-FI	Connects to the Bluetooth/Wi-Fi module using the Bluetooth/Wi-Fi module cable.
	Connects to the BLUETOOTH / WI-FI port on the first cabinet using the enclosed 24 Pin System Cable.
HDBT IN	Connects to the HDBT OUT port on the M-Box by using a LAN cable.

Remote Control

- Using other display devices in the same space as the remote control of this product can cause the other display devices to be inadvertently controlled.
- A button without a description in the image below is not supported on the product.

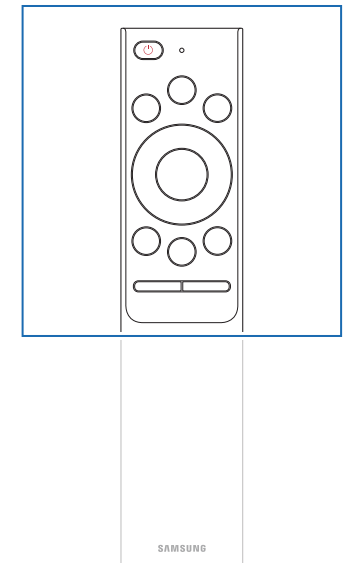
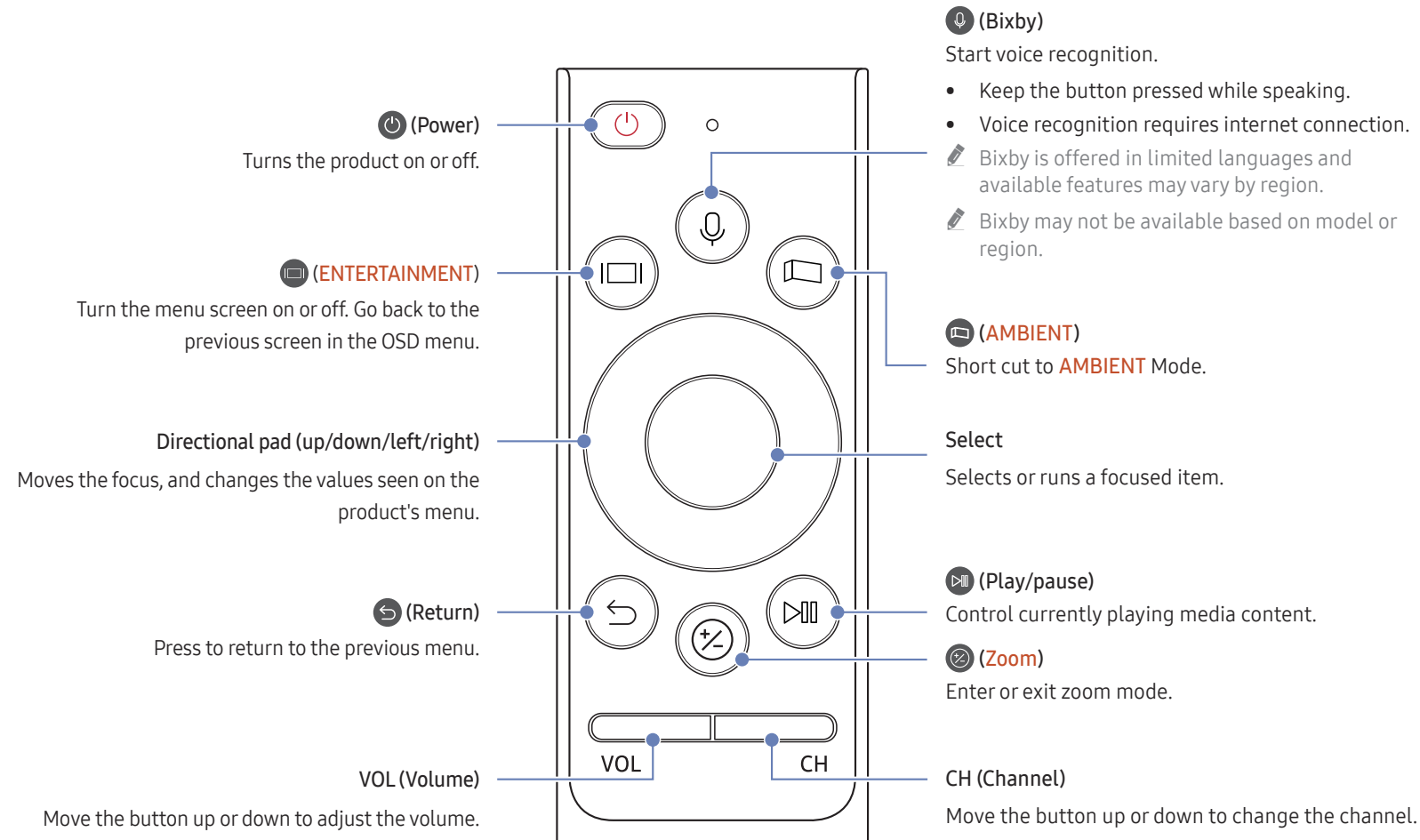

- The product connects with the Samsung Smart Remote automatically when powered on. If the automatic pairing does not work, direct the Samsung Smart Remote at the front side of the product and press **Return** and **Select** together for 3 seconds.
- Hold the remote control directing at the cabinet bottom and press any button to start pairing. If the pairing attempt keeps failing, contact Samsung Customer Service Center.

Installing batteries into the Samsung Smart Remote

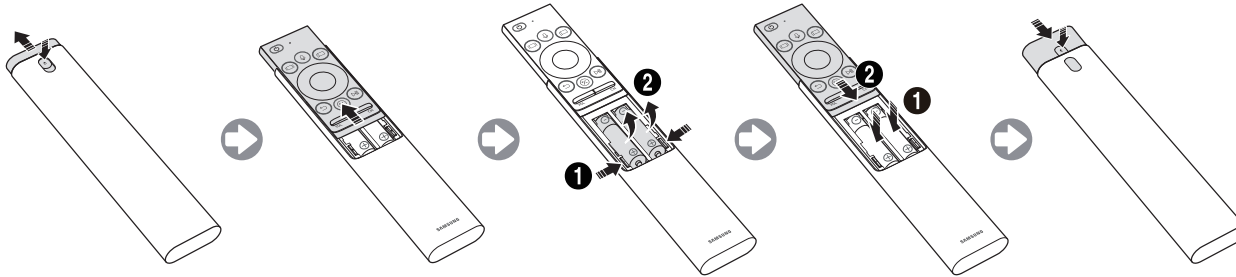

- 1 Press the ▲ button at the top rear of the Samsung Smart Remote. The body will pop out slightly from the body cover.
 - 2 Turn the remote over, and then slide the body of the remote upwards until the battery compartment is revealed.
 - 3 If there are batteries in the remote, press the ► and ◀ buttons on both sides of the battery compartment to remove the existing batteries.
 - 4 Insert two new batteries (1.5V AAA type) into the battery compartment making sure that the batteries' polarities (+, -) are oriented correctly. When done, slide the body of the remote until it is nearly in its original position.
 - 5 Turn the remote over, press and hold the ▲ button on the top rear, and then slide the body of the remote down into place.
- Alkaline batteries are recommended for longer battery life.

Prior to Installation

Precautions for installation

- It is recommended that this device be installed in a 19-inch rack case, rather than under general consumer environment conditions.
- Make sure that the ambient temperature inside the rack does not exceed 35°C.
- If installing more than one M-Box, ensure that there is a space of at least 1U (approximately 44.45 mm) between the M-Boxes to prevent the vent on top of each M-Box from being blocked.
- Make sure the vent faces upward. Do NOT install the device in portrait orientation or upside down.
- Make sure the vent on top is not blocked to prevent the device from overheating.
- Exercise caution to ensure that no foreign material enters the vent on top of the device.
- If installing the device close to a wall, make sure that there is a space of at least 10 mm between the wall and the four sides of the device to ensure good ventilation.
- Make sure that there is a space of at least 50 mm between the wall and the rear ports of the device to gain access for connection of cables.
- Make sure at least 15.2 m (50 ft) distance is ensured between the modem and the Bluetooth/Wi-Fi module.

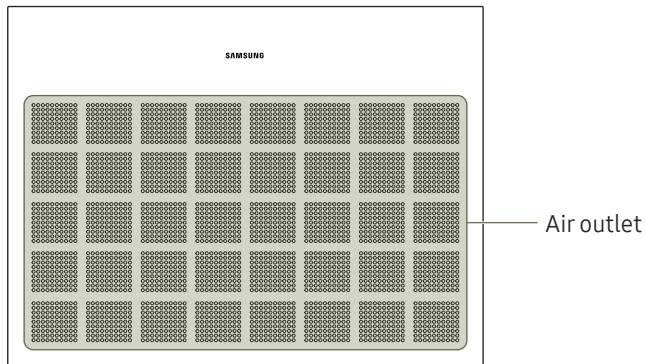

Installing M-Box on Rack Case

 The color and shape of parts may differ from what is shown. Specifications are subject to change without notice to improve quality.

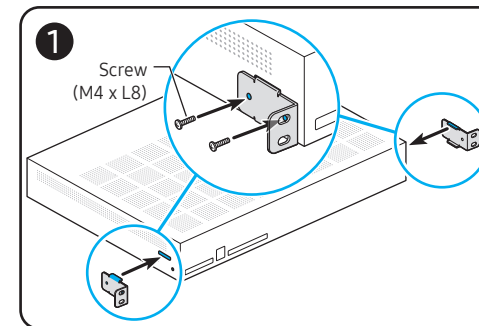
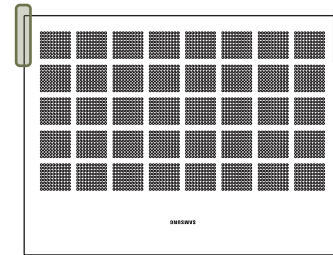

1 Attach the brackets to both sides of the M-Box main unit.

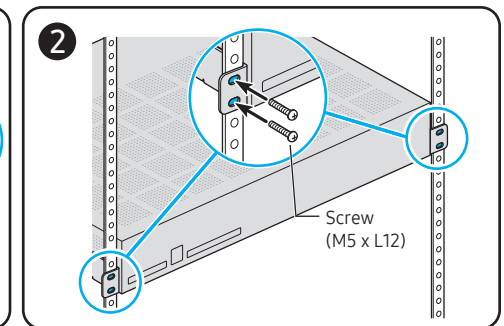

2 Fix the M-Box to the rack case.

 Use appropriate screws that are compatible with the rack case size.

Chapter 03

Connecting and using devices

Before Connecting

Pre-connection Checkpoints

- ✎ Also refer to the user guide for the source device you want to connect with. The number and location of ports available on the source device may vary.
- ✎ Do not connect the power cable until all connections are completed. Connecting the power cable during connection may damage the product.
- ✎ Check the types of ports at the back of the product you want to connect.

CLASS 1 LASER PRODUCT

- Caution - Invisible laser radiation when open. Do not stare into beam.
 - Do not bend or cut cables excessively.
 - Do not place heavy objects on the cable.
 - Do not disassemble the connector of the cable.
- Caution - Use of controls, adjustments, or the performance of procedures other than those specified herein may result in hazardous radiation exposure.

Connecting to a PC

- Do not connect the power cable before connecting all other cables. Ensure you connect a source device first before connecting the power cable.
- A PC can be connected to the product in a variety of ways. Select a connection method suitable for your PC.

Connection Using an HDMI Cable

- ✎ Connecting parts may differ in different products.

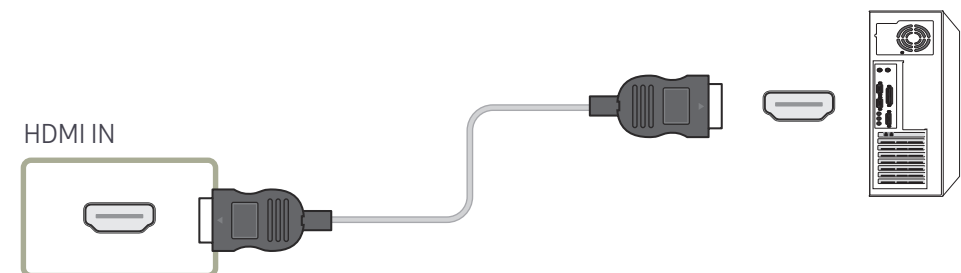

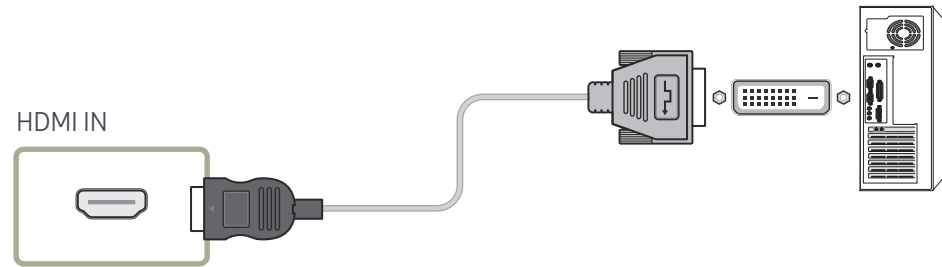

Connection Using an HDMI-DVI Cable

 Connecting parts may differ in different products.



Connecting to a Video Device

- Do not connect the power cable before connecting all other cables. Ensure you connect a source device first before connecting the power cable.
 - You can connect a video device to the product using a cable.
-  After connecting the source, press  →  **Source** on the remote control to select the connected device.

Connection Using an HDMI-DVI Cable

 Connecting parts may differ in different products.

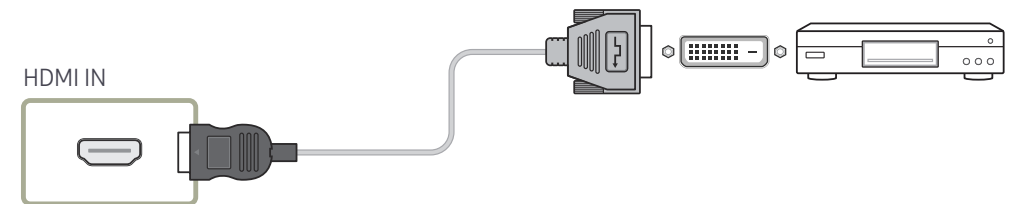

Connection Using an HDMI Cable

 Connecting parts may differ in different products.

Using an HDMI Cable or HDMI to DVI Cable

- For better picture and audio quality, connect to a digital device using an HDMI cable.
- If the product is connected to an external device that is compatible with an older HDMI version, the product may not display screen colors properly. It may also display a blank screen.
If such a problem occurs, ask the manufacturer of the external device about the HDMI version and, if out of date, request an upgrade.
- Be sure to use an HDMI cable with a thickness of 14 mm or less.
- Be sure to purchase a certified HDMI cable. Otherwise, the picture may not display or a connection error may occur.
- A basic high-speed HDMI cable or one with ethernet is recommended.
This product does not support the ethernet function via HDMI.

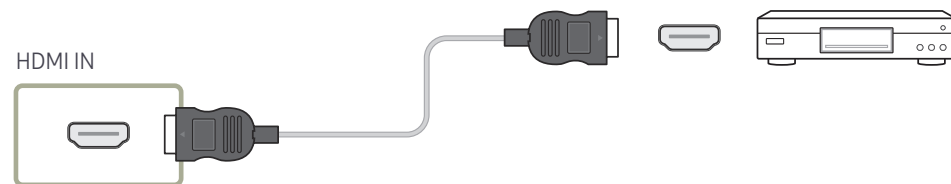

Connecting the LAN Cable

 Connecting parts may differ in different products.

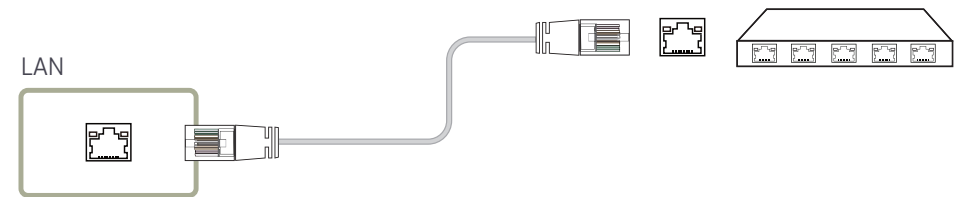

- Use a cable of CAT 6 (*STP type) or higher.
*STP: Shielded Twisted Pair
-  Connect to a HUB or router that supports the DHCP function.

Connecting a Optical Cable

 Connecting parts may differ in different products.

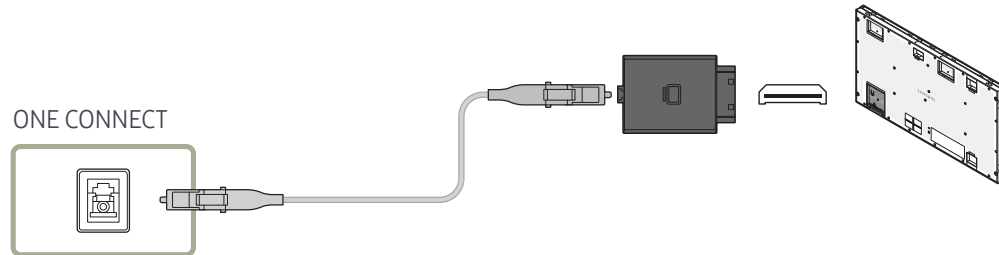

- Use special caution to ensure that the connector is connected correctly. Incorrect connection may cause malfunction. Connect the cable to the connector in the direction shown in the figure. Insert the cable gently until a “click” sound is audible.

Multiple Display Control

Control multiple display devices connected to a PC simultaneously.

Cable Connection

LAN Cable

- Pin assignment

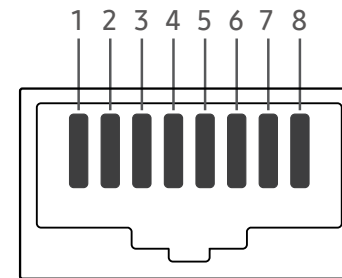

Pin No	Standard Color	Signal
1	White and orange	TX+
2	Orange	TX-
3	White and green	RX+
4	Blue	NC
5	White and blue	NC
6	Green	RX-
7	White and brown	NC
8	Brown	NC

- Connector: RJ45

Direct LAN cable (PC to HUB)

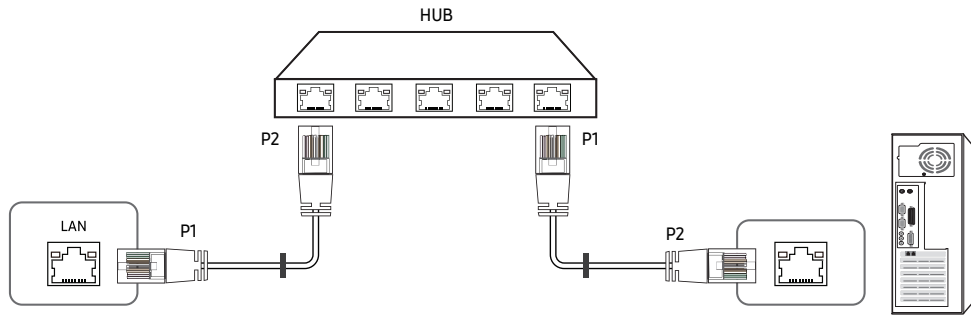

Signal	P1		P2	Signal
TX+	1	↔	1	TX+
TX-	2	↔	2	TX-
RX+	3	↔	3	RX+
RX-	6	↔	6	RX-

Cross LAN cable (PC to PC)

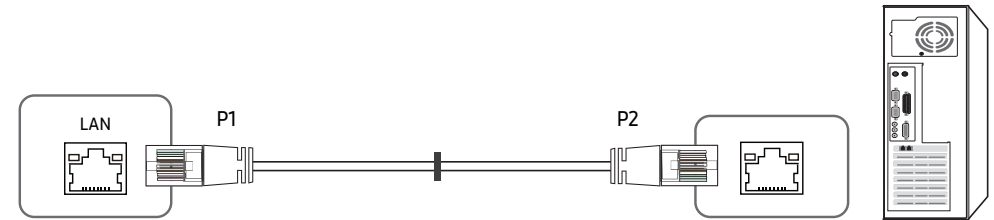





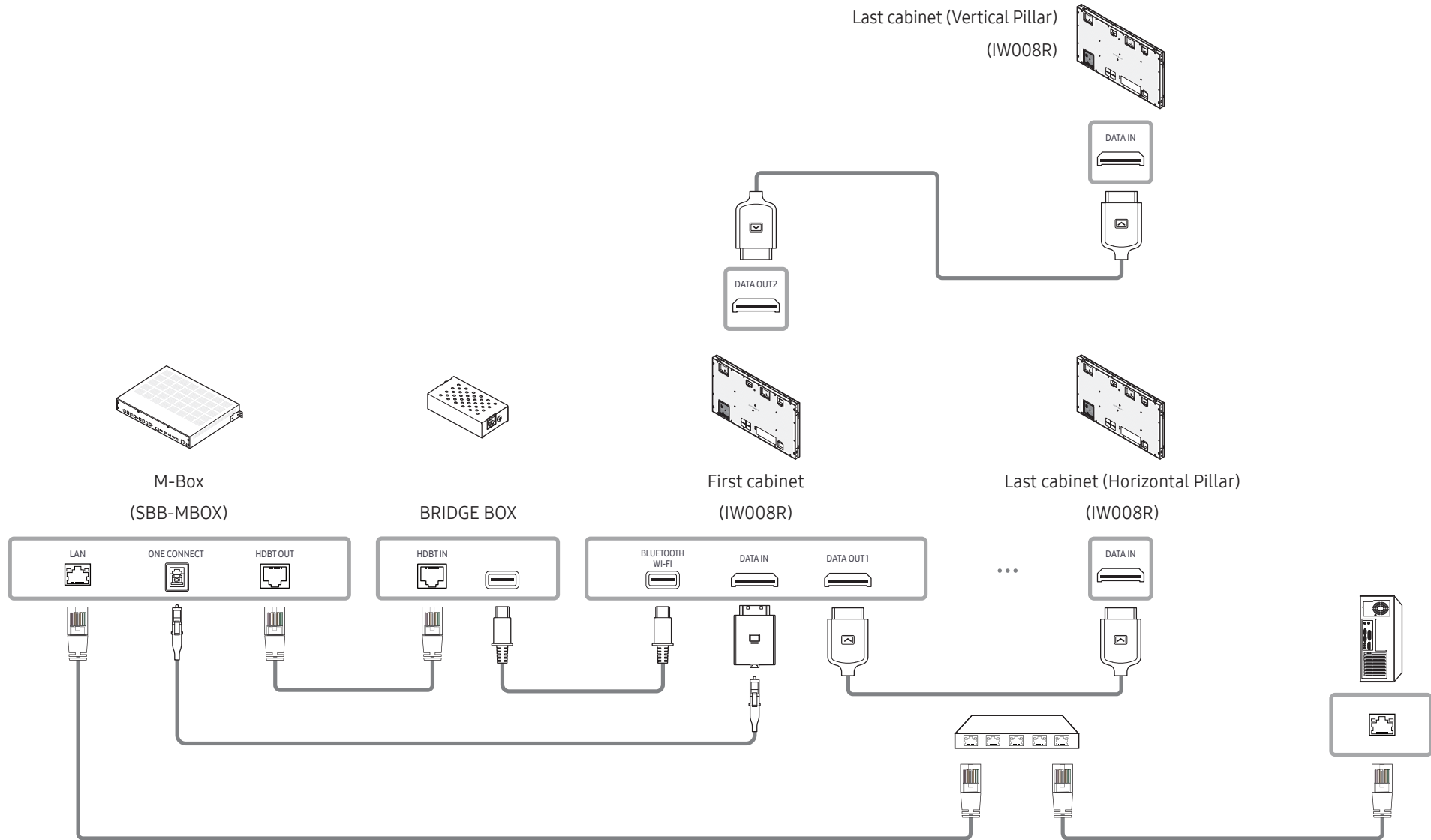

Signal	P1		P2	Signal
TX+	1	↔	3	RX+
TX-	2	↔	6	RX-
RX+	3	↔	1	TX+
RX-	6	↔	2	TX-





Connection



External Device Connection Cables

These are descriptions on connection cables used to connect external devices to the product.

Connection Cable	Image	Description
HDMI to HDMI		
HDMI to MINI HDMI		
HDMI to Micro HDMI		Transmits digital video and audio signals from the external device simultaneously via the product's HDMI port.
HDMI to USB Type-C		The cables come in a wide variety, depending on the types of the input and output ports used on the external device.
HDMI to DisplayPort		
Mini DisplayPort to HDMI		

Connection Cable	Image	Description
DVI to HDMI		DVI to HDMI cables may transmit digital video signals only and not audio signals. Accordingly, the use of an HDMI to HDMI cable is recommended.
Optical		This type of cable is used to transmit audio signals to external speakers with minimal loss. Optical cables do not transmit video signals.
Component		A cable used to transmit analog signals. The cable splits video signals into red, green, and blue channels and transmits the signals in FHD quality. Audio signals are transmitted via the red and white channels.
Composite		A cable used to transmit analog signals. Video signals are transmitted via the yellow channel, whereas audio signals are transmitted via the red and white channels.

 Available connection cables may differ depending on the model or geographical area.

Connecting using an HDMI Cable

- The following types of HDMI cables are recommended:
 - High Speed HDMI Cable
 - High Speed HDMI Cable with Ethernet
 - Premium High Speed HDMI Cable
 - Premium High Speed HDMI Cable with Ethernet
 - Ultra High Speed HDMI Cable
 - Use an HDMI cable that is less than 17 mm thick to ensure an optimal connection.
 - Use of a non-certified HDMI cable may result in a blank screen or a connection error.
 - Certain HDMI cables and external devices may not be compatible with the product's HDMI version.
 - This product does not support Ethernet access over HDMI. Ethernet is a Local Area Network (LAN) model utilizing standard coaxial cables of the IEEE.
 - Use a cable that is less than 3 m in length to get the best UHD-viewing quality.
 - Depending on the type of the graphic card used, certain computers may not support HDMI. If connecting a computer that does not support HDMI, use a DVI to HDMI cable or HDMI to DisplayPort cable to connect the computer to the product.
 - Connecting the product to an external device (DVD/Blu-ray player, set-top box, etc.) via an HDMI cable automatically activates Power Synchronization Mode. Power Synchronization Mode continuously monitors external devices that are connected via an HDMI cable. To disable this feature, disconnect the HDMI cable from the external device.
-  Depending on the model, this feature may not be supported.

Changing the Input source

Sources

Source → Source

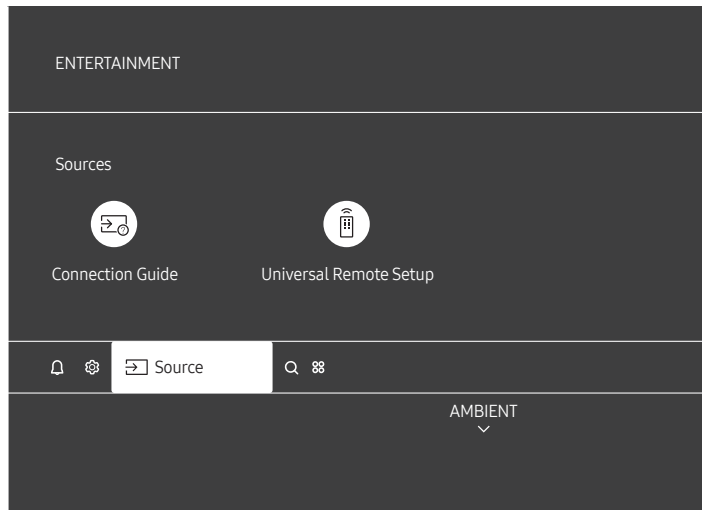

The displayed image may differ depending on the model.

Source allows you to select a variety of sources and change source device names.

You can display the screen of a source device connected to the product. Select a source from source list to display the screen of the selected source.

- After connecting the source, press Source → Source on the remote control to select the connected device.
- The screen may not display correctly if an incorrect source is selected for the source device you want to convert to.

Connection Guide

Source → Source → Connection Guide

View detailed information about supported source devices.

- The list can include the following source devices. Source devices on the list differ depending on the selected source.
Video Device / Game Console / Audio Device / PC / SmartPhone / External Storage / Input Device

Universal Remote Setup

Source → Source → Universal Remote Setup

Select Start to set up Samsung The Wall remote as a universal remote for easy control of all your devices. First turn on the device you want to add and connect the device to The Wall.

- Start / Exit
Cable/Satellite Box / Home Theater / OTT Box/Game Console / Blu-ray disc player
- Point Samsung The Wall remote at Samsung The Wall, and make sure there are no obstacles between M-Box(Front/Rear) The Wall and the device.
- This function may not be supported depending on the device and geographical area.

Chapter 04

AMBIENT

Ambient Settings

 →  **Ambient Settings**

Configure **AMBIENT** settings shown below.

Auto Brightness



Change automatic brightness settings for **AMBIENT**.

 If this function is set to **Off**, The Wall screen brightness will not automatically be adjusted based on the ambient light intensity.

- **Off / On**

Sleep After

Set a timer for automatic deactivation of **AMBIENT**.

 The screen will be turned off if there is no remote input within the specified period of time. To turn on **AMBIENT** again, press  button on the remote.

- **Off / After 1 hour / After 2 hours / After 3 hours / After 4 hours**

Reset All Photos

Resets photos retrieved from a mobile device or Samsung Cloud.

My W Edition

 → **My W Edition**

Select a preferred content and a preferred background and set them as your **AMBIENT**.

 Available content categories may differ depending on the model or geographical area.

About My W Edition

Use a variety of themes to create an eye-catching, attractive wall. Choose desired frame styles and contents, and decorate the space around The Wall with My W Edition.

 Use your tablet to create contents featuring your personal photos. Install the dedicated app from Samsung Galaxy Store.

- **Mix & Match / Classic / Elegant / Soothing / Contemporary**

Décor

 → [Décor](#)

About Décor

Use a variety of decoration themes to improve the elegance of your interior space. Choose preferred content or nature scenery that would match naturally with the space around The Wall.

- [Rotating Tiles](#) / [Light Grid](#) / [Light Cones](#) / [Rotating Discs](#) / [Moving Rods](#) / [Moving Pattern](#)

Nature

 → [Nature](#)

About Nature

Invite a piece of nature into your home. Relax and rest, being surrounded by a scenery that set your mind at ease.

- [Waterfall](#) / [Sky](#) / [Spring](#)

Art

 → [Art](#)

About Art

Enjoy wonderful, splendid photos and works of art at home. A world-class collection of art comes alive in your space.

- [Art 1 ~ Art 40](#)

Media Art

 → [Media Art](#)

About Media Art

Add depth to your interior space with immersive contents and designs.

- [Media Art 1 ~ Media Art 10](#)

My Collection

 → [My Collection](#)

About My Collection

Import photos or images from your tablet to turn your home space into a unique gallery.

Background Theme

 → [Background Theme](#)

Background Theme

Enjoy the experience of viewing the various themes of The Wall harmonizing well with your space.

- [Light Stone](#) / [Gray Stone](#) / [Beige Stone](#) / [Grid Stone](#) / [Dark Stone](#) / [Rough Stone](#) / [Cracked Stone](#) / [Slate](#) / [Stone Brick](#)

Using content effects

During playback of **AMBIENT**, press the “down” button to configure the following settings.

 Available setting items may vary, depending on the content.

Style & Settings

- [Background Materials](#) / [Moldings](#) / [Brightness](#) / [Saturation](#) / [Color Tone](#) / [Red Tone](#) / [Green Tone](#) / [Blue Tone](#)

Screen Settings

- [Brightness](#) / [Saturation](#) / [Color Tone](#) / [Red Tone](#) / [Green Tone](#) / [Blue Tone](#)

View Details

During playback of **AMBIENT**, press the “up” button to view details about the content.

Chapter 05

ENTERTAINMENT

Notification

 →  **Notification**

View the list of event notifications for the product.

Notifications appear on the screen at the scheduled viewing time or when there is an event on a registered device.

Settings

 →  **Settings**

Press **Settings** to display **Quick Settings** at the bottom of the screen. You can quickly access and set frequently used settings.

Picture Mode

Customize the screen and sound settings to suit your preferences and viewing environment.

 Brightness of the cabinet screen may become changed by the ambient light sensor / color sensor.

 If either of the sensors in the upper and lower portions of the cabinet is covered, screen brightness may not be adjusted properly.

- **Dynamic**
- **Standard**
- **Natural**
- **Movie**

Sound Mode

You can select a sound mode to suit your personal preferences.

 Some external sound output systems are not compatible with this function.

- **Standard**: Selects the normal sound mode.
- **Music**: Emphasises music over voices.
- **Movie**: Provides the best sound for movies.
- **Clear Voice**: Emphasises voices over other sounds.
- **Amplify**: Increase the intensity of high-frequency sound to allow a better listening experience for the hearing impaired.

Sound Output

Select the preferred speaker to play The Wall sound from.

- [Optical / Bluetooth Speaker List](#)

Game Mode

When connecting to a game console such as PlayStation™ or Xbox™, you can enjoy a more realistic gaming experience by selecting game mode.

- [Off / On](#)

 If you connect other external devices while **Game Mode** is on, the screen may not be in good condition.

Caption

Set **Caption** to **On**.

- [Off / On](#)

 If the program does not support captions, captions will not be shown even if **Caption** has been enabled.

 This feature is not affected by the DVD or Blu-ray player's subtitle settings. If using such a device, use the device's subtitle settings.

Sleep Timer

Automatically shuts off the product after a preset period of time.

- [Off / 30 minutes / 60 minutes / 120 minutes / 180 minutes](#)

 Use the up and down arrows to select a period of time, and then press **Select**. To cancel **Sleep Timer**, select **Off**.

Network

Configure The Wall's network.

Network Status

You can check the current network and Internet status.

More

Available functions include [Source](#), [Search](#) and [Apps](#).

Source

 →  **Source**

 **Source** allows you to select a variety of sources and change source device names.

Connection Guide

View detailed information about source devices that can connect to the product.

Video Device

- [HDMI / HDMI Troubleshooting](#)

Game Console

- [HDMI / HDMI Troubleshooting](#)

Audio Device

- [HDMI \(ARC\)](#) / [Optical](#) / [Bluetooth](#) / [Wi-Fi](#) / [Wi-Fi Speaker Surround Setup](#) / [HDMI Troubleshooting](#)

PC

- [HDMI](#) / [Screen Sharing \(Wireless\)](#) / [Apple AirPlay](#) / [HDMI Troubleshooting](#)

SmartPhone

- [Screen Sharing \(Smart View\)](#) / [SmartThings](#) / [Apple AirPlay](#)

External Storage



- [USB Flash Drive](#) / [Hard Disk Drive \(HDD\)](#)

Input Device

- [Remote Control](#)

Universal Remote Setup

Select Start to set up Samsung The Wall remote as a universal remote for easy control of all your devices. First turn on the device you want to add and connect the device to The Wall.



- [Start / Exit](#)
[Cable/Satellite Box](#) / [Home Theater](#) / [OTT Box/Game Console](#) / [Blu-ray disc player](#)
-  Point Samsung The Wall remote at Samsung The Wall, and make sure there are no obstacles between Samsung The Wall and the device.
-  This function may not be supported depending on the device and geographical area.

Search

 →  [Search](#)

Search within the screen or for programs, movie titles, or Smart Hub apps.

Apps

 →  [Apps](#)

Install and use Smart Hub apps such as News, Sports, Weather, and Games on the product as you would on a smartphone or tablet.

Chapter 06

Screen Adjustment

Configure the **Picture** settings (**Brightness**, **Color Tone**, etc.).

The layout of the **Picture** menu options may vary depending on the product.

Picture Mode

🏠 → ⚙️ **Settings** → ⚙️ **More** → **Picture** → **Picture Mode**

Customize the screen and sound settings to suit your preferences and viewing environment.

✎ Brightness of the cabinet screen may become changed by the ambient light sensor / color sensor.

✎ If either of the sensors in the upper and lower portions of the cabinet is covered, screen brightness may not be adjusted properly.

- **Dynamic**
- **Standard**
- **Natural**
- **Movie**

Picture Size Settings

🏠 → ⚙️ **Settings** → ⚙️ **More** → **Picture** → **Picture Size Settings**

Configure the picture size settings.

Picture Size

Different screen adjustment options are displayed depending on the current input source.

- **16:9 Standard**: Sets the picture to **16:9 Standard** wide mode.
- **Custom**: Changes the resolution to suit the user's preferences.
- **4:3**: Sets the picture to basic (**4:3**) mode.

✎ Do not set your product to **4:3** format for a long time.
The borders displayed on the left and right, or top and bottom of the screen may cause image retention (screen burn) which is not covered by the warranty.



Fit to Screen

Adjusts the picture position. When selected, the full program image will be displayed. No part of the image will be cut off.

- **Off / On / Auto**

Zoom and Position



Adjusts the picture zoom and position.

-  If you want to reset the picture to its original position, select **Reset** in the **Zoom and Position** screen. The picture will be set to its default position.
-  This menu is available when **Picture Size** is set to **Custom** mode.
-  HDR content will always be displayed in full-screen mode when playing to ensure the optimum picture quality.

Expert Settings



 →  **Settings** →  **More** → **Picture** → **Expert Settings**

Configure advanced picture settings to create your preferred picture.

-  You can adjust and store settings for each external device you have connected to an input on the product.
-  Lowering picture brightness reduces power consumption.

Backlight / Brightness / Contrast / Sharpness / Color / Tint (G/R)

Your product has several options for adjusting picture quality.

-  When you make changes to **Backlight, Brightness, Contrast, Sharpness, Color** or **Tint (G/R)**, the OSD will be adjusted accordingly.
-  You can adjust and store settings for each external device you have connected to an input on the product.
-  Lowering picture brightness reduces power consumption.

Apply Picture Settings

Apply the picture settings to all external devices connected to the device or to the current source only.

- **All Sources / Current Source**

Digital Clean View

Reduce picture noise to avoid distractions such as flickering.

- **Auto / Low / Off**

Auto Motion Plus Settings

Enhance picture sharpness to optimise for fast-moving images.

Auto Motion Plus

Removes blur and judder from scenes with larger amounts of rapid movement to provide a clearer picture.

The menu names may vary depending on the country.

Off: Switches **Auto Motion Plus** off.

Auto: Sets **Auto Motion Plus** to **Auto** mode.

Custom: Use to reduce the afterimage and judder as much as you want.

- **Blur Reduction:** Use to reduce the afterimage as much as you want.
 - This is only supported if the **Auto Motion Plus** is set to **Custom**.
- **Judder Reduction:** Use to reduce the judder as much as you want.
 - This is only supported if the **Auto Motion Plus** is set to **Custom**.

LED HDR

Make the dark elements of the image darker and the bright elements brighter to make the image as realistic as possible.

- **Off / Low / Standard / High**

Contrast Enhancer

Automatically balance the contrast to prevent excessive differences between bright and dark areas.

- **Off / Low / High**

Film Mode

Make frame transitions from older video sources smoother.

- **Off / Auto1 / Auto2**

 This option can be configured if the input source supports 480i, 576i or 1080i.

 This option is not supported when a PC is connected.

Color Tone

Select the colour tone that best suits your viewing preferences.

If **Picture Mode** is set to **Dynamic**

- **Cool / Standard**

If **Picture Mode** is set to **Standard, Natural** or **Movie**

- **Cool / Standard / Warm1 / Warm2**

 Settings can be adjusted and stored for each external device connected to an input on the product.

White Balance

Adjust the colour temperature of the picture so that white objects appear brighter.

 This option cannot be accessed while **Picture Mode** is set to **Dynamic** or **Natural**.

2 Point

Adjust red, green, and blue luminosity levels in two sections for precise white balance optimisation.

- **R-Gain / G-Gain / B-Gain:** Adjust the proportion of each of red, green and blue colours in bright areas.
- **R-Offset / G-Offset / B-Offset:** Adjust the proportion of each of red, green and blue colours in dark areas.
- **Reset:** Suitable for environments where videowall display are used.

20 Point Settings

Controls the white balance in 20 point interval by adjusting the red, green, and blue brightness.

20 Point

Adjust red, green, and blue luminosity levels in twenty sections for precise white balance optimisation.

- **Off** (●) / **On** (●)
- **Interval:** Select interval to adjust.
- **Red:** Adjust the red level.
- **Green:** Adjust the green level.
- **Blue:** Adjust the blue level.
- **Reset:** Restore the current level's 20 point White Balance to the default values.

 Some external devices may not support this function.

Gamma

Adjust the primary colour intensity.

- **HLG / ST.2084 / BT.1886 / 2.2**

 This option cannot be accessed while **Picture Mode** is set to **Dynamic** or **Natural**.

HLG / ST.2084 / BT.1886 / 2.2

Adjust the **HLG, ST.2084, BT.1886, 2.2** levels of the picture.

RGB Only Mode

Fine-tune the saturation and tint of the red, green, and blue colour channels.

- **Off / Red / Green / Blue**

 This option cannot be accessed while **Picture Mode** is set to **Dynamic** or **Natural**.

Color Space Settings

Configure colour space settings to refine the spectrum of colours on your screen.

 This option cannot be accessed while **Picture Mode** is set to **Dynamic** or **Natural**.

Color Space

Choose a colour space.

- **Auto / Native / Custom**

 To adjust **Color, Red, Green, Blue** and **Reset**, set **Color Space** to **Custom**.

Reset Picture

Restore all picture settings to the factory default.

Chapter 07

Sound Adjustment

Configure the sound (**Sound**) settings for the product.

Sound Output

 →  **Settings** →  **More** → **Sound** → **Sound Output**

Select the preferred speaker to play The Wall sound from.

- **Optical / Bluetooth Speaker List**

Sound Mode

 →  **Settings** →  **More** → **Sound** → **Sound Mode**

You can select a sound mode to suit your personal preferences.

 Some external sound output systems are not compatible with this function.



- **Standard**: Selects the normal sound mode.
- **Music**: Emphasises music over voices.
- **Movie**: Provides the best sound for movies.
- **Clear Voice**: Emphasises voices over other sounds.
- **Amplify**: Increase the intensity of high-frequency sound to allow a better listening experience for the hearing impaired.

Wi-Fi Speaker Surround Setup

 →  **Settings** →  **More** → **Sound** → **Wi-Fi Speaker Surround Setup**

Configure a stereo or surround system using the Samsung Soundbar and wireless speakers connected via Wi-Fi.

Expert Settings

 →  **Settings** →  **More** → **Sound** → **Expert Settings**

Configure advanced sound settings.

Woofers & Equalizer

Use Equalizer to customize sound setting for each speaker.

Digital Output Audio Format

Select the digital audio output format.

The **Dolby Digital+** option is only available devices that support the format.

- **PCM** / **Dolby Digital** / **Dolby Digital+**

Digital Output Audio Delay

Adjust the delay time between audio and video tracks. This function is only available when the device is connected via SPDIF. (Range: 0-250)

Dolby Atmos Compatibility

Set it to On if the audio device connected via HDMI (ARC) port supports Dolby Atmos.

The screen may flicker when switching between settings.

- **Off** (●) / **On** (●)

Sound Feedback

Play a sound when a menu or option is selected.

- **Off** / **Low** / **Medium** / **High**

Reset Sound

Reset all sound settings to the factory defaults.

Chapter 08

General

Intelligent Mode Settings

 →  **Settings** →  **More** → **General** → **Intelligent Mode Settings**

Intelligent Mode analyzes the surrounding environment, usage pattern, and content to provide an optimal viewing experience. It's possible to enable or disable the following options. Configure these options to customize your viewing experience.

 Depending on the model, this feature may not be supported.

Intelligent Mode

Turn **Intelligent Mode** on or off.

- **Off** (●) / **On** (●)

Adaptive Brightness

Measures the ambient light level using a light sensor and adjusts the backlight's brightness automatically.

- **Off** (●) / **On** (●)

 This function may not be supported, depending on the installation environment.

Bixby Voice settings

 →  **Settings** →  **More** → **General** → **Bixby Voice settings**

Configure basic voice interaction features.

Change settings related to using Bixby.

 Available features may vary depending on the model.

- **Language**

For changing Bixby's language setting.

 Changing this setting does not affect the language setting of the product or other apps.

 Bixby only supports some languages.

- **Voice response**

You can change or turn off Bixby's voice.

- **Sound Feedback**

Bixby provides a notification sound when it starts to listen to your voice or ends the listening.

 Depending on the model, this feature may not be supported.

- **Default music service provider**

For selecting which app to use when searching for music via Bixby.

- **Privacy**

For allowing or disallowing the use of the user's personal information when using services via Bixby.

Before Using Bixby

- Languages supported by Bixby and available Bixby features may vary depending on the region.
- Certain Bixby features will not be available if a language other than the national language has been set.
- Bixby is only available when the product is connected to the internet.
- Even if there is internet access, Bixby may not respond due to a server error.
- Once Bixby is updated, operating specifications of existing features may change.
- Bixby requires a Samsung Smart Remote with a built-in microphone and a Samsung product that supports voice recognition.
- Special characters and symbols like "-" are not supported. In addition, words and phrases that include numbers and symbols may not be recognized properly.
- The search term and the search result may not match.
- Certain apps may charge a fee for using their services and/or involve a separate service application or agreement process.
- In order to change channels using voice commands, you must first complete the **Set Up Your Service Provider** process. If **Set Up Your Service Provider** was not completed, it is possible to complete the configuration from **Reset** (🏠 → ⚙️ **Settings** → **General** → **Reset**)
- In order to use the voice-to-text and smart search features, the user must agree to sharing their voice data with a third-party provider of voice-recognition services.
- Use of Bixby requires the user's consent to the following agreements:
 - Smart Hub User Agreement
 - Collection and Use of Personal Information for Smart Hub Services
 - Collection and Use of Personal Information for Voice-Recognition Services.

Requirements for Bixby Use



- Voice-recognition performance can be influenced by the volume and tone of the voice, the accuracy of pronunciation, and the operating environment (product audio, ambient noise, etc.).
- The optimal vocal volume for voice recognition is between 75dB and 80dB.

Using Bixby

You can control the product by speaking voice commands into Samsung Smart Remote's microphone.

- ✎ To use Bixby, the product must be connected to the internet.
- ✎ To use Bixby, you must register and sign in to your Samsung account. Some functions may not be supported if you are not signed in to your Samsung account.
- ✎ Bixby only supports some languages, and the supported functions may differ depending on the geographical area.
- ✎ Bixby may not be supported depending on the model or geographical area.

Starting Bixby using buttons on the Samsung Smart Remote

You can also make a conversation with Bixby using the Samsung Smart Remote buttons. Press and hold the  button, say a voice command, and then release the  button.

To read the Bixby user guide, press  button once.

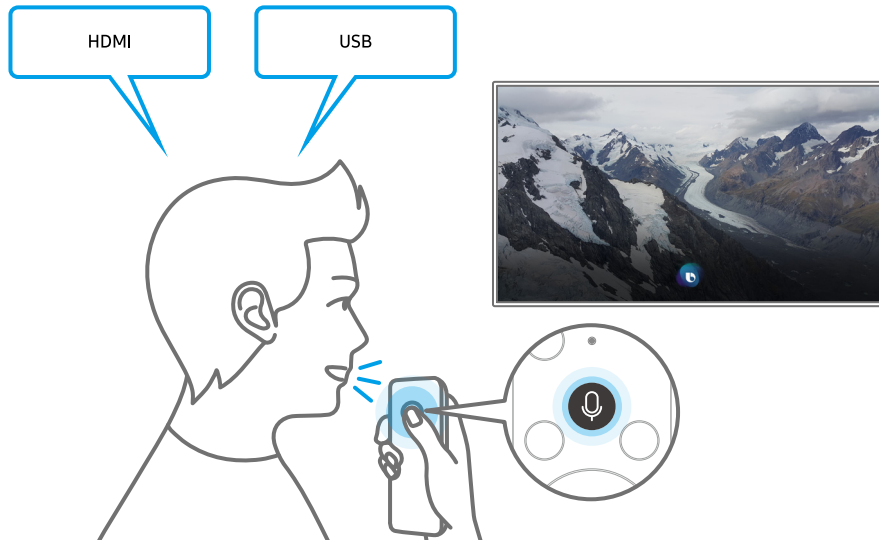

- Pressing  displays the **Explore Now** button on the bottom of the screen. Press the Select button to navigate to the **Explore Bixby** screen.

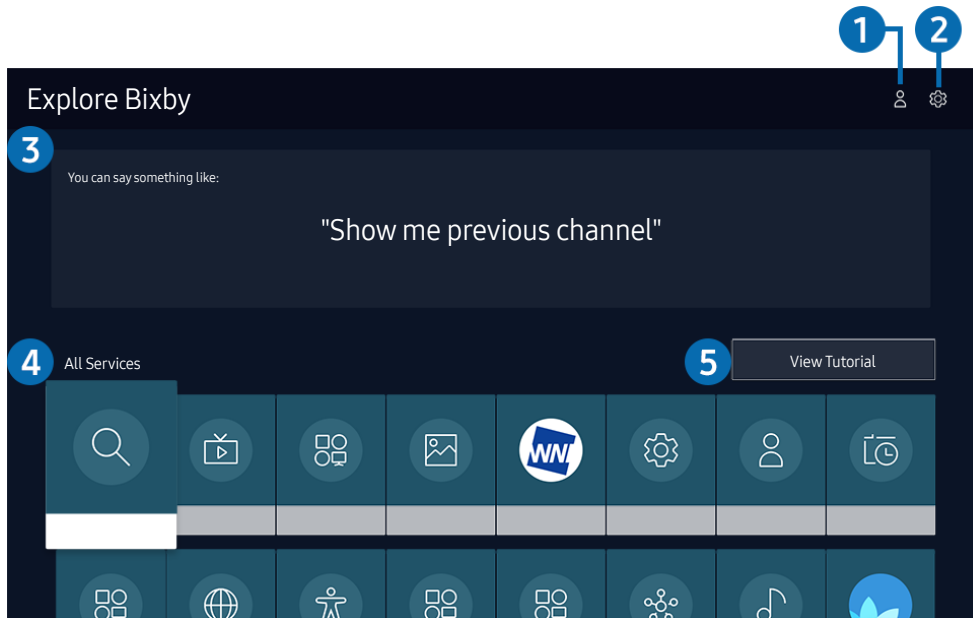

Getting to Know the Explore Bixby Screen



 The actual menu screen may differ depending on the product model.

Number	Description
1	Navigate to the My Profile screen and log out or register a voice ID. Registering a voice ID makes it possible to log in to your account using your voice.  If you are not logged into a Samsung account, you can log in by selecting  My Profile .
2	Change settings related to using Bixby.
3	Recommended commands you can use to control the product via Bixby in the given situation are shown.
4	Familiarize yourself with situation-specific voice commands for using Bixby. Use the directional buttons to select a voice command you wish to use and then press the Select button. You can control the product using a wide variety of voice commands.
5	A guide on using Bixby will appear as a pop-up window.

Network

 →  Settings →  More → General → Network

Configure The Wall's network.

Network Status

You can check the current network and Internet status.

Open Network Settings

Configure network settings to connect to an available network.

Network Type

Configure the network connection mode.

- [Wireless](#) / [Wired](#)

Network Settings (Wired)

Connecting to a Wired Network

There are three ways to attach your product to your LAN using cable.

- You can attach your product to your LAN by connecting the LAN port on the back of your product to an external modem using a LAN cable. See the diagram below.

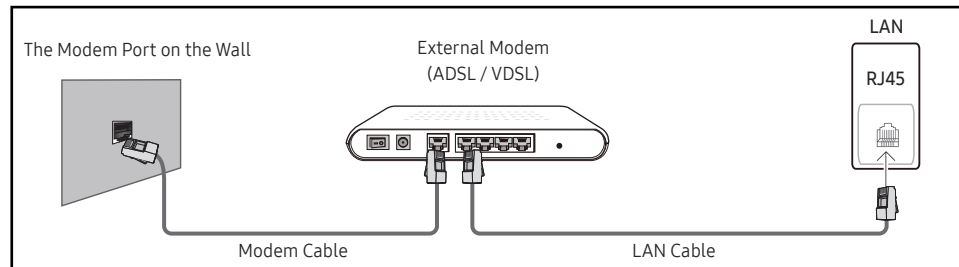

- You can attach your product to your LAN by connecting the LAN port on the back of your product to an IP Sharer which is connected to an external modem. Use LAN cable for the connection. See the diagram below.

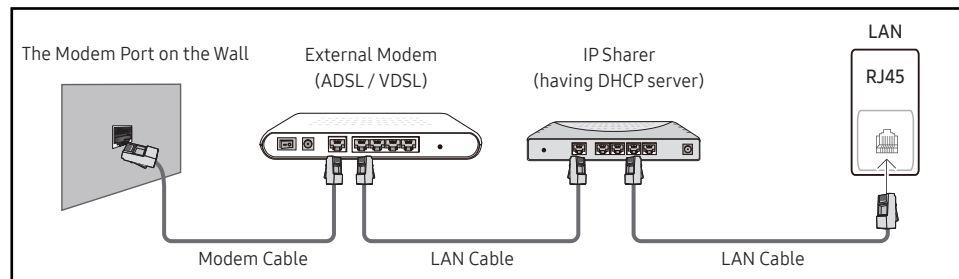

- Depending on how your network is configured, you may be able to attach your product to your LAN by connecting the LAN port on the back of your product directly to a network wall outlet using a LAN cable. See the diagram below. Note that the wall outlet is attached to a modem or router elsewhere in your house.

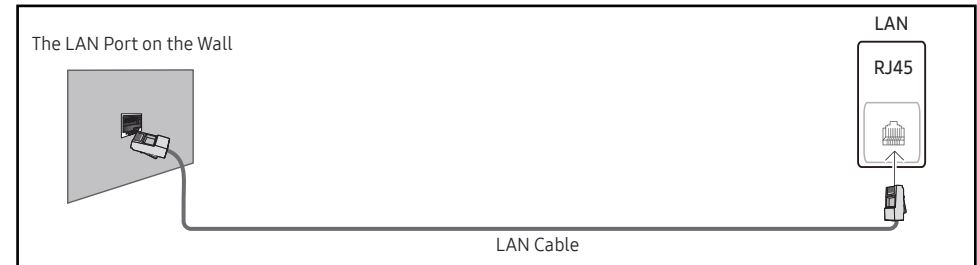

If you have a Dynamic Network, you should use an ADSL modem or router that supports the Dynamic Host Configuration Protocol (DHCP). Modems and routers that support DHCP automatically provide the IP address, subnet mask, gateway, and DNS values your product needs to access the Internet so you do not have to enter them manually. Most home networks are Dynamic Networks.

Some networks require a Static IP address. If your network requires a Static IP address, you must enter the IP address, subnet mask, gateway, and DNS values manually on your product **IP Settings** when you set up the network connection. To get the IP address, subnet mask, gateway, and DNS values, contact your Internet Service Provider (ISP).

If you have a Windows computer, you can also get these values through your computer.

- ✎ You can use ADSL modems that support DHCP if your network requires a Static IP address.
- ✎ ADSL modems that support DHCP also let you use Static IP addresses.
- ✎ It is not possible to use an ADSL modem if your Internet speed is below 10 Mbps.

Set the network connection to use Internet services such as perform software upgrades.

Automatic Open Network Settings (Wired)

Connect to the network using a LAN cable.

Make sure a LAN cable is connected first.

How to set up automatically

- 1 Select **Open Network Settings**. The **Open Network Settings** session starts.
- 2 The network test screen appears and verifies the network connection.
When the connection has been verified, the “**Success! Your device is connected to the Internet. If you have any problems using online services, please contact your Internet service provider.**” message appears.

 If the connection process fails, check the LAN port connection.

 If the automatic process cannot find the network connection values or if you want to set the connection manually, go to the next section(Manual Open Network Settings (Wired)).

Manual Open Network Settings (Wired)

Offices may use static IP addresses.

If this is the case, ask the network administrator for the IP address, subnet mask, gateway and DNS server address. Enter these values manually.

Getting the Network Connection Values

To view the Network connection values on most Windows computers, follow these steps.

- 1 Right click the Network icon on the bottom right of the screen.
- 2 In the pop-up menu that appears, click Status.
- 3 On the dialog that appears, click the **Support** tab.
- 4 On the **Support** Tab, click the **Details** button. The Network connection values are displayed.

 The path to the settings depends on the installed OS.

How to set up manually

- 1 Select **Open Network Settings**. The **Open Network Settings** session starts.
- 2 The network test screen appears and the verification process starts. Press **Cancel**. The verification process stops.
- 3 Select **IP Settings** on network connection screen. The **IP Settings** screen appears.
- 4 Set the **IP Setting** option to **Enter manually** and provide the network details from your computer.
 Setting **IP Setting** to **Enter manually** automatically changes **DNS Setting** to **Enter manually**.
- 5 When finished, select **OK**. The product will attempt again to connect to the network based on the new settings.
- 6 When the connection has been verified, the “**Success! Your device is connected to the Internet. If you have any problems using online services, please contact your Internet service provider.**” message appears.

Network Settings (Wireless)

Connecting to a Wireless Network

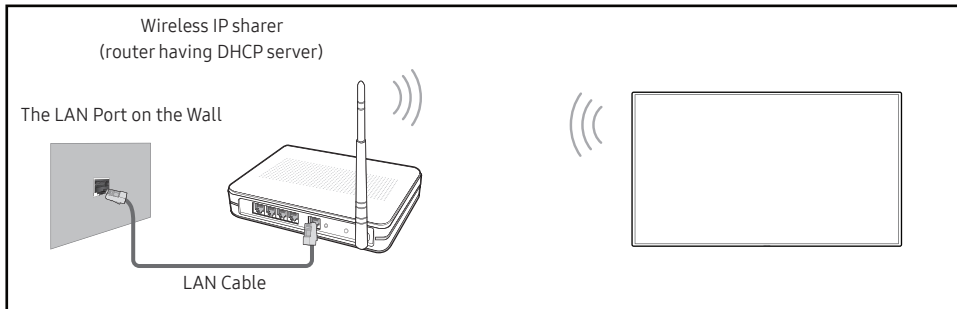

Samsung recommends using IEEE 802.11n. When you play video over a network connection, the video may not play smoothly.

- ✎ Select a channel for the wireless IP sharer that is not currently being used. If the channel set for the wireless IP sharer is currently being used by another device nearby, this will result in interference and communication failure.
- ✎ Your product supports only the following wireless network security protocols. If you select the Pure High-throughput (Greenfield) 802.11n mode and the Encryption type is set to WEP, TKIP or TKIP AES (WPS2Mixed) on your AP or wireless router, Samsung products will not support a connection in compliance with new Wi-Fi certification specifications.
- ✎ If your wireless router supports WPS (Wi-Fi Protected Setup), you can connect to the network via PBC (Push Button Configuration) or PIN (Personal Identification Number). WPS will automatically configure the SSID and WPA key in either mode.
- ✎ Connection Methods: You can setup the wireless network connection in three ways. Auto Setup (Using the Auto Network Search function), Manual Setup, **Use WPS**
- ✎ Make sure at least 15.2 m (50 ft) distance is ensured between the modem and the Bluetooth/Wi-Fi module.
- ✎ Depending on your wireless network environment, you may experience wake up delay while Screen Mirroring Wake Up is enabled.

Automatic Network Setup (Wireless)

Most wireless networks have an optional security system that requires devices that access the network to transmit an encrypted security code called an Access or **Security key**. The **Security key** is based on a Pass Phrase, typically a word or a series of letters and numbers of a specified length you were asked to enter when you set up security for your wireless network. If you use this method of setting up the network connection, and have a **Security key** for your wireless network, you will have to enter the Pass Phrase during the automatic or manual setup process.

How to set up automatically

- 1 Set **Network Type** to **Wireless** from the **Open Network Settings** page.
- 2 The **Network** function searches for available wireless networks. When done, it displays a list of the available networks.
- 3 Select the router from the list and press **Select**.
 - ✎ If the desired wireless router does not appear, select **Refresh** to search again.
 - ✎ If the router cannot be found after retrying, select the **Stop** button. The **Add Network** button appears.
- 4 If the **Enter the password for (AP Name)** screen appears, go to step 5. If you select a wireless router that does not have security, go to step 7.
- 5 If the router has security, enter the **Enter the password for (AP Name)**. (Security key or PIN).
- 6 When finished, select **Done**. The network connection screen appears and the verification process starts.
 - ✎ A connection with the router is established, but the Internet cannot be accessed.
- 7 When the connection has been verified, the **"Success! Your device is connected to the Internet. If you have any problems using online services, please contact your Internet service provider."** message appears.

Manual Network Setup (Wireless)

Offices may use static IP addresses.



If this is the case, ask the network administrator for the IP address, subnet mask, gateway and DNS server address. Enter these values manually.

Getting the Network Connection Values

To view the Network connection values on most Windows computers, follow these steps.

- 1 Right click the Network icon on the bottom right of the screen.
- 2 In the pop-up menu that appears, click Status.
- 3 On the dialog that appears, click the **Support** tab.
- 4 On the **Support** Tab, click the **Details** button. The Network connection values are displayed.

How to set up manually

- 1 Set **Network Type** to **Wireless** from the **Open Network Settings** page.
- 2 The **Network** function searches for available wireless networks. When done, it displays a list of the available networks.
- 3 Select the router from the list and press **Select**.
 -  If the desired wireless router does not appear, select **Refresh** to search again.
 -  If the router cannot be found after retrying, select the **Stop** button. The **Add Network** button appears.
- 4 If the **Enter the password for (AP Name)**. screen appears, go to step 5. If you select a wireless router that does not have security, go to step 7.
- 5 If the router has security, enter the **Enter the password for (AP Name)**. (Security key or PIN).
- 6 When finished, select **Done**. The network connection screen appears and the verification process starts.
- 7 Select **Cancel** while network connections are being attempted. This will stop the connection.
- 8 Select **IP Settings** on network connection screen. The **IP Settings** screen appears.
- 9 Select the field at the top, press **Select**, and then set **IP Setting** to **Enter manually**. Repeat the entry process for each field in the **IP Address**.
 -  Setting **IP Setting** to **Enter manually** automatically changes **DNS Setting** to **Enter manually**.
- 10 When finished, select **OK**. The network test screen appears and the verification process starts.
- 11 When the connection has been verified, the **“Success! Your device is connected to the Internet. If you have any problems using online services, please contact your Internet service provider.”** message appears.

Reset Network

Restore the network settings to the factory default.

Expert Settings

Configure advanced network settings.

Power On with Mobile

You can turn the product on or off using a mobile device connected to the same network as the product.

- **Off** (●) / **On** (●)

IP Remote

Remotely connect an IP controller to the product to manage the system.

- **Enable** / **Disable**

 Set **Power On with Mobile** to **On** to use this option.

System Manager

 →  **Settings** →  **More** → **General** → **System Manager**

Adjust Samsung The Wall's system and customize settings for your viewing environment.

Time

Configure various time-related settings.

Clock Set

Select **Clock Set**. Select **Date** or **Time**, and then press **Select**.

Use the number buttons to enter numbers or press the up and down arrow buttons. Use the left and right arrow buttons to move from one entry field to the next. Press **Select** when done.

 You can set the **Date** and **Time** directly by pressing the number buttons on the remote control.

Sleep Timer

Automatically shuts off the product after a preset period of time.

- **Off** / **30 minutes** / **60 minutes** / **120 minutes** / **180 minutes**

 Use the up and down arrows to select a period of time, and then press **Select**. To cancel **Sleep Timer**, select **Off**.

Off Timer

Schedule automatic turn-off.

- **Setup:** Select **Off**, **Once**, **Everyday**, **Mon~Fri**, **Mon~Sat**, **Sat~Sun** or **Manual**. If you select **Manual**, you can choose the days you want **Off Timer** to turn off your product.
 - ✎ The check mark indicates days you've selected.
- **Time:** Set the hour and minute. Use the number buttons or the up and down arrow keys to enter numbers. Use the left and right arrow buttons to change entry fields.

Language

Set the menu language.

- ✎ A change to the language setting will only be applied to the onscreen menu display. It will not be applied to other functions on your PC.

Device Name

Select or enter a device name.

This name can be shown on network device over the network.

- **Samsung The Wall Series / User Input**

Samsung Account

Go to the **Samsung Account** screen to log out or add an account.

Change PIN

Change your 4-digit Personal Identification Number (PIN).

Choose any 4 digits for your PIN and enter it in **Enter a new PIN..** Reenter the same 4 digits in **Enter the PIN again..**

The product has memorized your new PIN.

- ✎ The default PIN number is "0-0-0-0".
- ✎ Change the PIN to keep your device secure.

Auto Protection Time

Activate a screensaver when Samsung The Wall displays a still image for two hours.

- **Off** (●) / **On** (●)

Smart Security

The security provided to protect your display device and connected storage devices against viruses includes.

Scan

Inspect your display device and connected storage devices to check for viruses.

Isolated List

This is the list of items that have been Isolated for containing viruses.

External Device Manager

 →  Settings →  More → General → External Device Manager

Manage external devices connected to Samsung The Wall.

Anynet+ (HDMI-CEC)

Anynet+ is a function that enables you to control all connected Samsung devices that support Anynet+ with your Samsung product remote control. The Anynet+ system can be used only with Samsung devices that have the Anynet+ feature. To be sure your Samsung device has this feature, check if there is an Anynet+ logo on it.

- Off (●) / On (●)

 You can only control **Anynet+** devices using the product remote control, not the buttons on the product.

 The product remote control may not work under certain conditions. If this occurs, reselect the **Anynet+** device.

 **Anynet+** works when the AV device supporting **Anynet+** is in the standby or on status.

 **Anynet+** supports up to 12 AV devices in total. Note that you can connect up to 3 devices of the same type.

Troubleshooting for Anynet+

Problem	Possible Solution
Anynet+ does not work.	<ul style="list-style-type: none"> • Check if the device is an Anynet+ device. The Anynet+ system supports Anynet+ devices only. • Check if the Anynet+ device power cord is properly connected. • Check the Anynet+ device's Video/HDMI cable connections. • Check whether Anynet+ (HDMI-CEC) is set to On in the External Device Manager menu. • Check whether the remote control is Anynet+ compatible. • Anynet+ doesn't work in certain situations. (initial setup) • If you have removed and then reconnected the HDMI cable, please make sure to search devices again or turn your product off and on again. • Check if the Anynet+ function of the Anynet device is set on.
I want to start Anynet+.	<ul style="list-style-type: none"> • Check if the Anynet+ device is properly connected to the product and check if the Anynet+ (HDMI-CEC) is set to On in the External Device Manager menu.
I want to exit Anynet+.	<ul style="list-style-type: none"> • Press the  button on the product remote control and select a non- Anynet+ device.
The message " Disconnecting Anynet+ device ... " appears on the screen.	<ul style="list-style-type: none"> • You cannot use the remote control when you are configuring Anynet+ or switching to a view mode. • Use the remote control after the product has completed Anynet+ configuration or has finished switching to Anynet+.
The Anynet+ device does not play.	<ul style="list-style-type: none"> • You cannot use the play function when initial setup is in progress.
The connected device is not displayed.	<ul style="list-style-type: none"> • Check whether or not the device supports Anynet+ functions. • Check whether or not the HDMI cable is properly connected. • Check whether Anynet+ (HDMI-CEC) is set to On in the External Device Manager menu. • Search Anynet+ devices again. • Anynet+ requires an HDMI connection. Make sure the device is connected to your product with an HDMI cable. • Some HDMI cables may not support Anynet+ functions. • If the connection is terminated because there has been a power failure or the HDMI cable has been disconnected, please repeat the device scan.

Game Mode

When connecting to a game console such as PlayStation™ or Xbox™, you can enjoy a more realistic gaming experience by selecting game mode.

- **Auto / On / Off**

 If you connect other external devices while **Game Mode** is on, the screen may not be in good condition.

Input Signal Plus

Expands the input signal range for HDMI connections.

- **HDMI1 / HDMI2 / HDMI3 / HDMI4**

HDMI Black Level

Adjust the black level to optimize the HDMI picture brightness and contrast.

- **Normal / Low / Auto**

Device Connect Manager

Allow devices, like smartphones and tablets, on your network to share content with Samsung The Wall.

Access Notification

Display a notification when a device is connected for the first time.

Turn off Access Notification to connect devices automatically.

- **Off / First Time Only / Always On**

Device List

View and manage connected devices.

Apple AirPlay Settings

 →  **Settings** →  **More** → **General** → **Apple AirPlay Settings**

Use AirPlay to stream content on your iPhone, iPad, or Mac on the product screen.

Eco Solution

 →  Settings →  More → **General** → **Eco Solution**

Configure energy saving options.

Ambient Light Detection

Set to adjust the screen brightness automatically based on the ambient light to reduce power consumption.

If you find the screen getting too bright or dark while using **Ambient Light Detection**, you can set **Minimum Backlight** to limit the change.

- **Off** (●) / **On** (●)

Minimum Backlight

Set the minimum brightness for the signage screen. This function only works if its value is lower than the value set in the **Picture** menu's **Backlight** setting.

 Your display brightness may change based on the ambient light level. (The screen can become slightly brighter or darker.)

Power Saving Mode

Reduce the power consumption by adjusting the screen brightness.

- **Off** (●) / **On** (●)

Motion Lighting

Set to adjust the screen brightness based on the motion of the display content to reduce power consumption.

- **Off** (●) / **On** (●)

Auto Power Off

Choose how long the display will wait before turning off after no user interaction is detected.

- **Off** / **4 hours** / **6 hours** / **8 hours**

Accessibility

 →  Settings →  More → General → Accessibility

Accessibility Shortcuts allows quick access to various settings to accommodate special needs.

Press the volume button for 1 second or longer. Quickly enable or disable options such as **Voice Guide**, **High Contrast**, **Enlarge**, **Grayscale**, and **Color Inversion**.

 Alternatively, press the subtitle button or mute button on the bundled remote control.

 Audio guide for **Accessibility Shortcuts** remains active even when **Voice Guide** is set to **Off**.

Voice Guide Settings

Audio guide to product use is available to ensure convenient use regardless of visual impairment or blindness.

When enabled, Voice Guide provides audio descriptions for setting basic options such as the screen and volume adjustment, accessing information about the current and next listings, and setting viewing schedule.

Users can also listen and navigate various smart services such as **Internet** and **Search**.

Enable or disable the option by navigate to **Voice Guide** and pressing the select button.

Voice Guide

Enable or disable the Voice Guide feature. Voice Guide will be provided in the current language.

- Off (●) / On (●)

 **Volume**, **Speed** and **Pitch** are enabled only when **Voice Guide** is set to **On**.

Volume

Adjust the volume of **Voice Guide**.

- Loud / Medium / Soft

Speed

Adjust the tempo of **Voice Guide**.

- Very Fast / Fast / Normal / Slow / Very Slow

Pitch

Adjust the pitch of **Voice Guide**.

- High / Medium / Low

High Contrast

Set the background and font to high-contrast colors in Menu. Menu transparencies become opaque when the option is selected.

- Off (●) / On (●)

Grayscale

Convert the screen colors to shades of gray to clarify the line details.

- Off (●) / On (●)

 Some of the **Accessibility** menu options are not available while **Grayscale** is enabled.

Color Inversion

Invert the colours on the screen. White become black, black becomes white, orange becomes blue, and so on.

- Off (●) / On (●)

Enlarge

Set whether to enlarge the highlighted item in the menu.

- Off (●) / On (●)

Caption Settings

Set **Caption** to On.

- Off (●) / On (●)

 If the program does not support captions, captions will not be shown even if **Caption** has been enabled.

 This feature is not affected by the DVD or Blu-ray player's subtitle settings. If using such a device, use the device's subtitle settings.

Caption Mode

Select a caption mode from the list.

- Default / CC1 ~ CC4 / Text1 ~ Text4

Digital Caption Options

Configure detailed settings related to caption display.

Remote Button Repeat Settings

Set to decrease the button response speed while pressing down a button on the remote control.

Set **Slow Button Repeat** to On and adjust the response speed under **Repeat Interval**.

- Off (●) / On (●)
- **Slow Button Repeat**: Enable or Disable the Slow Button Repeat feature.
- **Repeat Interval**: Adjust the remote button repeat interval.

Smart Features

 →  **Settings** →  **More** → **General** → **Smart Features**

Use Smart Hub to access various apps that are available on Apps.

Autorun Last App

Set **Autorun Last App** to On to start the most recently used app when turning on the product.

Enable or disable the option by pressing the select button on the menu.

- Off (●) / On (●)

 Some apps may not support this option.

Reset



 →  **Settings** →  **More** → **General** → **Reset**

All the settings will return to factory defaults.



Chapter 09

Support

Software Update

 →  **Settings** →  **More** → **Support** → **Software Update**

The **Software Update** menu lets you upgrade your product software to the latest version.

-  Be careful not to turn off the power until the upgrade is complete. The product will turn off and on automatically after completing the software upgrade.
-  When you upgrade software, all video settings you have made will return to their default settings. We advise you to write down your settings so that you can easily reset them after the upgrade.

Update Now



Update the software to the latest version.

-  **Current version:** This is the software version already installed in the product.

Auto update

Accepting the Smart Hub service agreement automatically sets **Update Now** to **On**.

You may choose to stop the automatic update by pressing the select button on the menu.

- **Off** (●) / **On** (●)
-  Updating process may take longer if other networking features are active.
-  Internet connection is required.

Self Diagnosis

 →  **Settings** →  **More** → **Support** → **Self Diagnosis**

Check the screen and sound output for any problem and change Smart Hub and reset settings.

Start Picture Test

Use this test when you experience a problem with Samsung The Wall's picture.

Start Sound Test

Use this test when you experience a problem with Samsung The Wall's sound.

Signal Information

Shows HDMI signal information.

Samsung The Wall Device Manager

Scans and cleans the Samsung The Wall's CPU, RAM, and storage space.

Start Smart Hub Connection Test

Use this to check the Smart Hub connection if you have a problem with using the network connection and product services.

Reset Smart Hub

Use this to reset all saved data and installed applications such as the Samsung account information, linked service account information, installed applications, and agreements.

Remote Management

 →  **Settings** →  **More** → **Support** → **Remote Management**

This service allows Samsung Customer Service Center agent to provide remote diagnostics on your product.

Enable or disable the option by pressing the select button on the menu.

You must accept the service agreement and privacy agreement to use this service and allow our engineer to remotely inspect your product and apply fixes and updates as necessary.

Accept the service agreement and privacy agreement first, and then provide our service agent with the PIN in the following pop-up message.

- **Off** (●) / **On** (●)

 Press the button for more than 5 seconds to enter **Remote Management** mode.

 Internet connection is required.

About Samsung The Wall

 →  **Settings** →  **More** → **Support** → **About Samsung The Wall**

View contact information and Samsung The Wall Specifications that you may need in order to receive service support from the Samsung Call Center or Samsung website.

 Go to **About Samsung The Wall** and find the product **Model Code** and **Software Version**.

Terms & Policy

 →  **Settings** →  **More** → **Support** → **Terms & Policy**

View and set the privacy policy for Smart Hub and various other services.

 Make sure that the product is connected to the network.

Chapter 10

Troubleshooting Guide

 Before calling Samsung Customer Service Center, test your product as follows. If the problem persists, contact Samsung Customer Service Center.

Requirements Before Contacting Samsung Customer Service Center

Testing the Product

Check if your product is operating normally by using the product test function.

If the screen remains blank while the power indicator blinks even when the product is correctly connected to a PC, perform product testing.

- 1 Power off both the PC and product.
- 2 Disconnect all the cables from the product.
- 3 Power on the product.
- 4 If **No Signal** is displayed, the product is operating normally.

If the screen remains blank, check the PC system, video controller and cable.

Checking the Resolution and Frequency

For modes that exceed the supported resolutions, the message "**Not Optimum Mode**" appears briefly.

Set the PC resolution by referring to [Preset Timing Modes](#).

Check the followings.

Installation issue (PC mode)	
The screen keeps switching on and off.	Check that the cable between the product and the PC is connected correctly.
Blank spaces are found on all four sides of the screen when an HDMI or an HDMI-DVI cable is connected between the product and PC.	The blank spaces found on the screen have nothing to do with the product.
	Blank spaces on the screen are caused by the PC or graphics card. To resolve the problem, adjust the screen size in the HDMI or DVI settings for the graphics card.
	If the graphics card settings menu does not have an option to adjust the screen size, update the graphics card driver to the latest version. (Please contact the graphics card or computer manufacturer for further details about how to adjust the screen settings.)
Screen issue	
The power indicator is off. The screen will not switch on.	Make sure that the power cord is connected.
No Signal is displayed on the screen.	Check that the product is connected correctly with a cable.
	Check that the source device connected to the product is powered on.
Not Optimum Mode is displayed.	This message is displayed when a signal from the graphics card exceeds the product's maximum resolution and frequency.
	Refer to the Standard Signal Mode Table and set the maximum resolution and frequency according to the product specifications.
The images on the screen look distorted.	Check the cable connection to the product.
The screen is not clear. The screen is blurry.	Set the resolution and frequency to the recommended level.

Screen issue	
The screen appears unstable and shaky.	Check that the resolution and frequency of the PC and graphics card are set within a range compatible with the product. Then, change the screen settings if required by referring to 'Preset Timing Modes'.
There are shadows or ghost images left on the screen.	
The screen is too bright. The screen is too dark.	Go to Picture and adjust the Brightness and Contrast settings.
Screen color is inconsistent.	Go to Picture and adjust the Color Space Settings settings.
White does not really look white.	Go to Picture and adjust the White Balance settings.
There is no image on the screen and the power indicator blinks every 0.5 to 1 second.	The status of product is in power-saving mode.
	Press any key on the keyboard or move the mouse to return to the previous screen.
The product will turn off automatically.	If a PC is connected to the product, check the power status of the PC.
	Make sure the power cable is connected properly to the product and power outlet.
	If the signal from a connected device is not detected, the product automatically turns off after 10 to 15 minutes.
The screen display does not look normal.	Encoded video content may cause the display to appear corrupted in scenes featuring fast moving objects such as in a sports event or action video.
	Low signal level or low picture quality may cause the display to appear corrupted. This does not mean the product is defective.
	A cell phone within a distance of one-meter radius may cause static on analog and digital products.

Screen issue	
The brightness and color do not look normal.	Go to Picture and adjust the screen settings such as Picture Mode , Color , Brightness and Sharpness .
	Reset the screen settings to the default settings. (P.36)
I see red, green, and blue.	Check the cable connections.
	This issue may happen when the screen of the product is defective. Contact a Samsung Service Center to resolve the issue.
The display looks unstable and then freezes.	The screen may freeze when a resolution other than the recommended resolution is used or if the signal is not stable. To resolve the issue, change the PC resolution to the recommended resolution.
The screen cannot be displayed in full screen.	A scaled SD (4:3) content file can cause black bars on both sides of an HD channel screen.
	A video with an aspect ratio different from the product can cause a black bar to appear at the top and bottom of the screen.
	Change the screen size setting to full screen on the product or source device.
The cabinet screen blinks.	Check the Optical cable connected to the device.
	Check that the Optical cable is correctly connected to the device.
	Check that there is no foreign material found in the ONE CONNECT port (optical) on the device.
Remote control issue	
The remote control does not work.	Make sure that the batteries are correctly in place (+/-).
	Check if the batteries are flat.
	Check for power failure.
	Make sure that the power cord is connected.
	Check for any special lighting or neon signs switched on in the vicinity.

Source device issue	
A beeping sound is heard when my PC is booting.	If a beeping sound is heard when your PC is booting, have your PC serviced.
Other issue	
The product smells like plastic.	The plastic smell is normal and disappears over time.
Video playback is choppy.	Check the cable connection and connect it again if required.
	Use a standard cable.
Small particles are found on the edges of the product.	The particles are part of the product design. The product is not defective.
When I try to change the PC resolution, a message "The defined resolution is not currently supported." appears.	The message "The defined resolution is not currently supported." appears if the input source resolution exceeds the maximum resolution of the display. To resolve the issue, change the PC resolution to a resolution supported on the display.
HDMI Black Level is not functioning properly on an external device with HDMI YCbCr output.	This function is available only when a source device with RGB signal, such as a DVD player and STB, is connected to the product to HDMI cable.
The power indicator does not blink.	Press a button on the remote control and check that the power indicator blinks.
	<ul style="list-style-type: none"> If the power indicator does not blink, check the product connection and then turn off the product and turn it on again. If the power indicator does not blink although the cable is connected correctly and the product has been turned off and then on again, contact the nearest service center.

Chapter 11

Specifications

General

Model Name		SBB-MBOX
Power Supply		AC100-240V~ 50/60Hz Based on the AC voltage of the adapter. For the DC voltage of the product, refer to the product label.
Environmental considerations	Operating	Temperature: 32 °F - 104 °F (0 °C - 40 °C) Humidity: 10% - 80%, non-condensing
	Storage	Temperature: -4 °F - 113 °F (-20 °C - 45 °C) Humidity: 5% - 95%, non-condensing * Applicable before the product package is unpacked.
Supported models		IW008R

Plug-and-Play

This monitor can be installed and used with any Plug-and-Play compatible systems. Two-way data exchange between the monitor and PC system optimizes the monitor settings. Monitor installation takes place automatically. However, you can customize the installation settings if desired.

For detailed device specifications, visit the Samsung Electronics website.

You can see the label-rating inside of the cover terminal.

(USA only)

Dispose unwanted electronics through an approved recycler.

To find the nearest recycling location, go to our website:

www.samsung.com/recycling or call, 1-800-SAMSUNG



Preset Timing Modes

Horizontal Frequency

The time required to scan a single line from the left to the right side of the screen is called a horizontal cycle. The reciprocal number of a horizontal cycle is called horizontal frequency. Horizontal frequency is measured in kHz.

Vertical Frequency

The product displays a single image multiple times per second (like a fluorescent light) to display what the viewer sees. The rate of a single image being displayed repeatedly per second is called vertical frequency or refresh rate. Vertical frequency is measured in Hz.

-  This product can be set to only one resolution for each screen size to obtain the optimum picture quality due to the nature of the screen. Using a resolution other than the specified resolution may degrade the picture quality. To avoid this, it is recommended that you select the optimum resolution specified for your product.
-  The native resolutions are 3840 x 2160 at 60 Hz and 7680 x 4320 at 60 Hz with the **Input Signal Plus** set to **On**. The native resolution is 3840 x 2160 at 30 Hz with the **Input Signal Plus** set to **Off**.

Model Name		SBB-MBOX
Synchronization	Horizontal Frequency	15 – 255 kHz
	Vertical Frequency	24 – 120 Hz
Resolution	Optimum Resolution	3840 x 2160 @ 60 Hz
	Maximum Resolution	7680 x 4320 @ 60 Hz

The screen will automatically be adjusted if a signal that belongs to the following standard signal modes is transmitted from your PC. If the signal transmitted from the PC does not belong to the standard signal modes, the screen may be blank with the power indicator on. In such a case, change the settings according to the following table by referring to the graphics card user manual.

Resolution	Horizontal Frequency (kHz)	Vertical Frequency (Hz)	Pixel Clock (MHz)	Sync Polarity (H/V)
IBM, 720 x 400	31.469	70.087	28.322	- / +
MAC, 640 x 480	35.000	66.667	30.240	- / -
MAC, 832 x 624	49.726	74.551	57.284	- / -
MAC, 1152 x 870	68.681	75.062	100.000	- / -
VESA DMT, 640 x 480	31.469	59.940	25.175	- / -
VESA DMT, 640 x 480	37.861	72.809	31.500	- / -
VESA DMT, 640 x 480	37.500	75.000	31.500	- / -
VESA DMT, 800 x 600	37.879	60.317	40.000	+ / +
VESA DMT, 800 x 600	48.077	72.188	50.000	+ / +
VESA DMT, 800 x 600	46.875	75.000	49.500	+ / +
VESA DMT, 1024 x 768	48.363	60.004	65.000	- / -
VESA DMT, 1024 x 768	56.476	70.069	75.000	- / -
VESA DMT, 1024 x 768	60.023	75.029	78.750	+ / +
VESA DMT, 1152 x 864	67.500	75.000	108.000	+ / +
VESA DMT, 1280 x 720	45.000	60.000	74.250	+ / +
VESA DMT, 1280 x 800	49.702	59.810	83.500	- / +
VESA DMT, 1280 x 1024	63.981	60.020	108.000	+ / +
VESA DMT, 1280 x 1024	79.976	75.025	135.000	+ / +
VESA DMT, 1440 x 900	55.935	59.887	106.500	- / +
VESA DMT, 1600 x 900	60.000	60.000	108.000	+ / +

Resolution	Horizontal Frequency (kHz)	Vertical Frequency (Hz)	Pixel Clock (MHz)	Sync Polarity (H/V)
VESA DMT, 1680 x 1050	65.290	59.954	146.250	- / +
VESA DMT, 1920 x 1080	67.500	60.000	148.500	+ / +
VESA CVT, 2560 x 1440	88.787	59.951	241.500	+ / -
VESA CVT, 2560 x 1440	192.996	119.998	497.750	+ / -
CTA-861, *1920 x 1080	112.500	100.000	297.000	+ / +
CTA-861, *1920 x 1080	135.000	120.003	297.000	+ / +
CTA-861, 3840 x 2160	67.500	30.000	297.000	+ / +
CTA-861, *3840 x 2160	135.000	60.000	594.000	+ / +
CTA-861, *3840 x 2160	225.000	100.000	1188.000	+ / +
CTA-861, *3840 x 2160	270.000	120.000	1188.000	+ / +
CTA-861, 4096 x 2160	54.000	24.000	297.000	+ / +
CTA-861, 4096 x 2160	56.250	25.000	297.000	+ / +
CTA-861, 4096 x 2160	67.500	30.000	297.000	+ / +
CTA-861, *4096 x 2160	112.500	50.000	594.000	+ / +
CTA-861, *4096 x 2160	135.000	60.000	594.000	+ / +
CTA-861, *4096 x 2160	225.000	100.000	1188.000	+ / +
CTA-861, *4096 x 2160	270.000	120.000	1188.000	+ / +
CTA-861, *7680 x 4320	108.000	24.000	1188.000	+ / +
CTA-861, *7680 x 4320	132.000	30.000	1188.000	+ / +
CTA-861, *7680 x 4320	220.000	50.000	2376.000	+ / +
CTA-861, *7680 x 4320	264.000	60.000	2376.000	+ / +

 *: The resolution may not be supported depending on the model.

Chapter 12

Appendix

Responsibility for the Pay Service (Cost to Customers)

 When the service is requested, in spite of in warranty, we may charge you for a visit from a service technician in the following cases.

Not a product defect

Cleaning of the product, Adjustment, Explanation, Re-installation and etc.

- If a service technician is requested to give instructions on how to use product or simply adjusts options without disassembling product.
- If a defect is caused by external environmental factors (Internet, Antenna, Wired Signal, etc.)
- If a product is reinstalled or devices are connected additionally after installing the purchased product for the first time.
- If a product is reinstalled to move to a different spot or to move to a different house.
- If customer requests instructions on how to use because of another company's product.
- If customer requests instructions on how to use the network or another company's program.
- If customer requests software installation and setup for the product.
- If a service technician removes/cleans dusts or foreign materials inside of the product.
- If customer requests an installation additionally after purchasing a product through home-shopping or online.

A Product damage caused by customer's fault

Product damage caused by customer's mishandling or wrong repair

If a product damage is caused by;

- External impact or drop.
- Use of supplies or separately sold product unspecified by Samsung.
- Repair from a person besides an engineer of outsourcing service company or partner of Samsung Electronics Co., Ltd.
- Remodeling or repairing the product by customer.
- Using it with incorrect voltage or non-authorized electrical connections.
- Not following the "cautions" in User Manual.

Others

- If product fails by natural disaster. (lightning, fire, earthquake, flood damage, etc)
- If consumable components are all used up. (Battery, Toner, Fluorescent lights, Head, Vibrator, Lamp, Filter, Ribbon, etc.)
-  If customer requests a service in case the product has no defect, service fee may be charged. So please read User Manual first.

License



The terms HDMI and HDMI High-Definition Multimedia Interface, and the HDMI Logo are trademarks or registered trademarks of HDMI Licensing LLC in the United States and other countries.

Open Source Licence Notice

In the case of using open source software, Open Source Licences are available on the product menu. Open Source Licence Notice is written only English.

For information on the Open Source Licence Notice, contact the Samsung Customer Center or send email to oss.request@samsung.com.
