

Survey 100 / 200

Irradiance Meter

-  Quick reference guide
-  Guía de consulta rápida
-  Guida rapida
-  Schnellanleitung
-  Guide de Prise en main rapide



SOLAR

www.seawardsolar.com

UK Office:

Seaward Solar, Bracken Hill, South West Industrial Estate,
Peterlee, County Durham, SR8 2SW United Kingdom

Tel: +44 (0) 191 586 3511 **Fax:** +44 (0) 191 586 0227

Email: enquiry@seawardsolar.com **Web:** www.seawardsolar.com

USA Office:

Seaward Group USA
6304 Benjamin Road, Suite 506, Tampa, Florida, 33634

Tel: (813) 886 2775 **Email:** enquiry@seawardsolar.com

Web: www.seawardsolar.com

Part No: 396A558

Overview

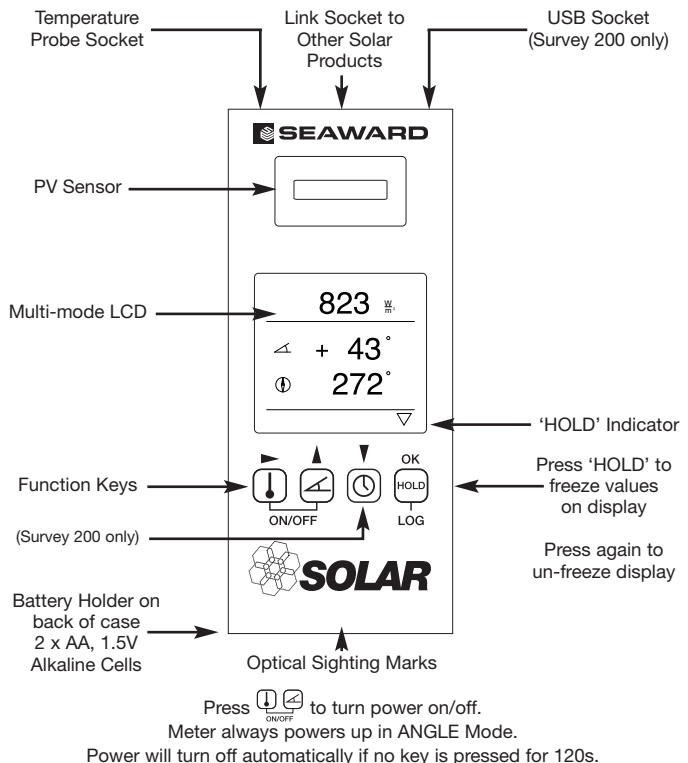

Resumen

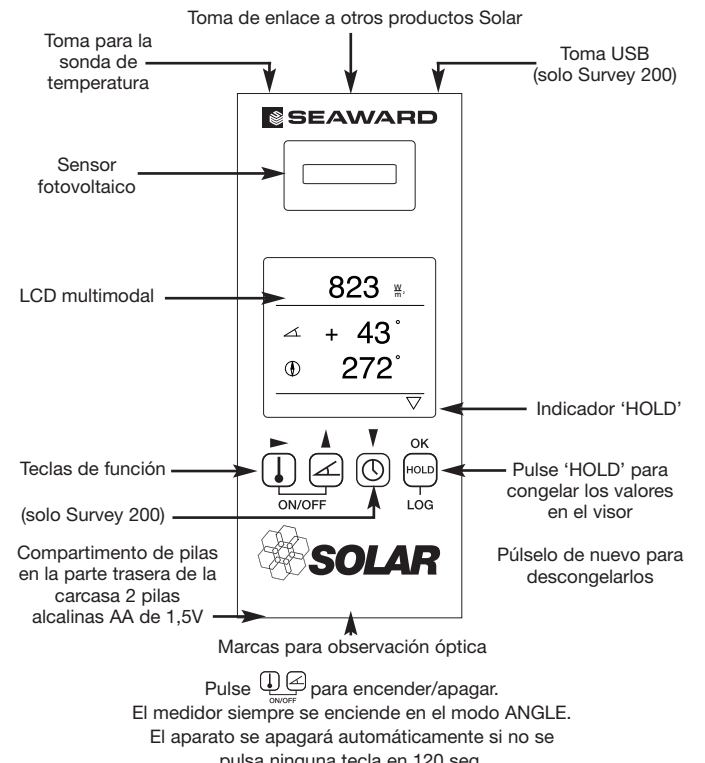

Important Information

Read these operating instructions before using this instrument. This equipment should only be used by suitably trained personnel. The Solar Survey is intended for use in a dry environment only. Check the Solar Survey 100/200 and all associated cables and leads before operating the equipment. Do not use if there are signs of damage. Only use the connecting leads & temperature probes supplied with the Solar Survey 100/200. Use 2x 1.5V AA Cells - these may be Alkaline or rechargeable NiCd or NiMH.

Información importante

Lea estas instrucciones de funcionamiento antes de usar este instrumento. Este equipo solo debe usarlo personal adecuadamente formado. El Solar Survey está destinado exclusivamente al uso en ambientes secos. Compruebe el Solar Survey 100/200 y todos sus cables y conductores asociados antes de usar el equipo. No lo use si presenta signos de daño. Use solamente los cables de conexión y las sondas de temperatura suministradas con el Solar Survey 100/200. Use 2 pilas AA de 1,5 V. Pueden ser alcalinas o recargables de NiCd o NiMH.

Wichtiger Hinweis

Lesen Sie sich diese Bedienungsanleitung gründlich durch, bevor Sie das Gerät verwenden. Die Bedienung des Geräts sollten nur durch geschultes Personal erfolgen. Der Solar Survey sollte nur in trockener Umgebung verwendet werden. Vor der Inbetriebnahme sollten der Solar Survey 100/200 und alle angeschlossenen Kabel und Leitungen auf Beschädigungen untersucht werden. Gerät nicht in Betrieb nehmen, wenn Spuren von Beschädigung vorliegen. Nur die mit dem Solar Survey 100/200 mitgelieferten Anschlusskabel & Temperaturfühler verwenden. 2x 1,5V AA Zellen verwenden - entweder Alkali-Zellen oder wiederaufladbare NiCd- oder NiMH-Zellen.

Informations importantes

Lisez cette notice d'emploi avant de vous servir de cet appareil. Cet appareil ne doit être utilisé que par un personnel ayant reçu une formation appropriée. Le Solimètre Solar Survey est conçu exclusivement pour un usage en environnement sec. Vérifiez le Solimètre Solar Survey 100/200 et tous les câbles et cordons associés avant de vous en servir. N'utilisez pas l'appareil si vous remarquez des signes de dommages. Utilisez exclusivement les cordons et sondes de température fournis avec le Solimètre Solar Survey 100/200. Utilisez 2 piles de 1,5 V AA, alcalines ou rechargeables NiCd ou NiMH.

Informazioni importanti

Prima di utilizzare lo strumento leggere queste istruzioni. L'apparecchio è destinato esclusivamente a personale opportunamente formato. Il Solar Survey deve essere utilizzato esclusivamente in ambienti asciutti. Prima di utilizzare l'apparecchio, controllare il Solar Survey 100/200 e tutti i relativi cavi e conduttori. Non utilizzare lo strumento se si notano segni di danni. Con il Solar Survey 100/200 utilizzare solo i conduttori di connessione e le sonde di temperatura in dotazione. Utilizzare 2 pile AA da 1,5 V (alcaline o ricaricabili al Ni-Cd o al Ni-MH).

Irradiance with Compass & Tilt Measurement

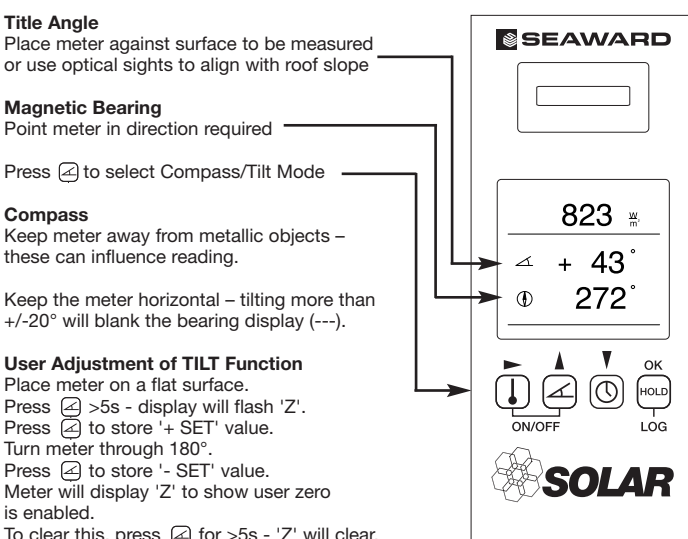

Irradiancia con brújula y medición de la inclinación

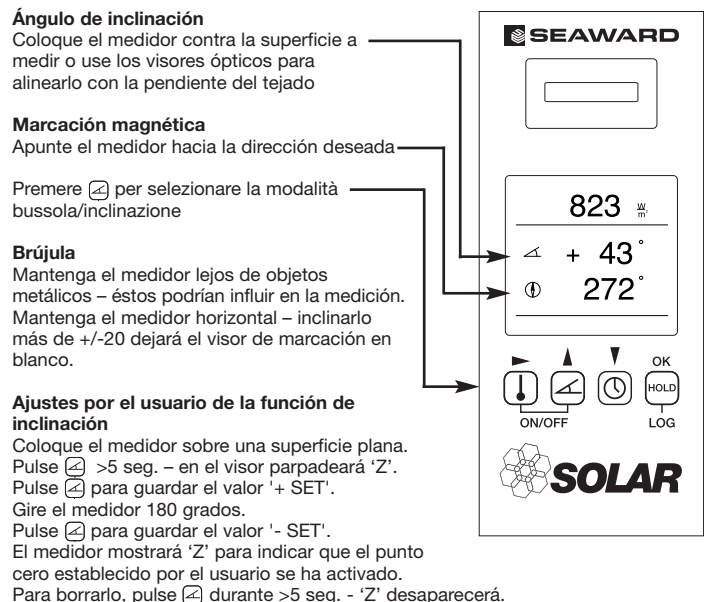

Irradiance and Temperature Measurement

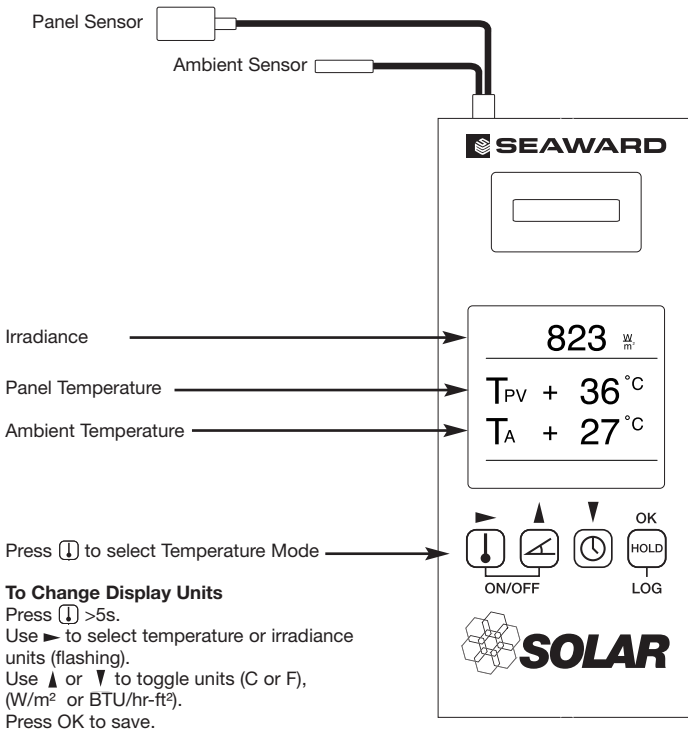

Medición de irradiancia y temperatura

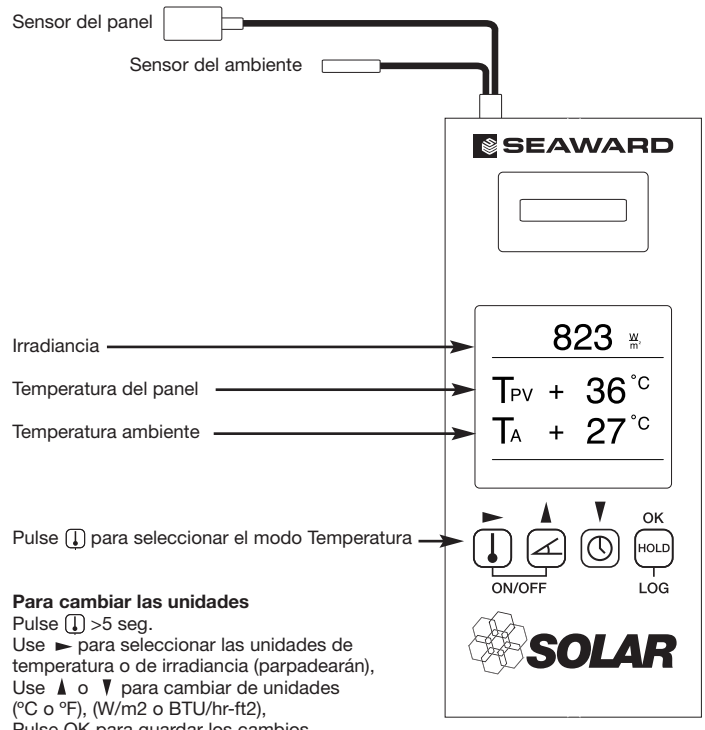

Time & date (Survey 200 only)

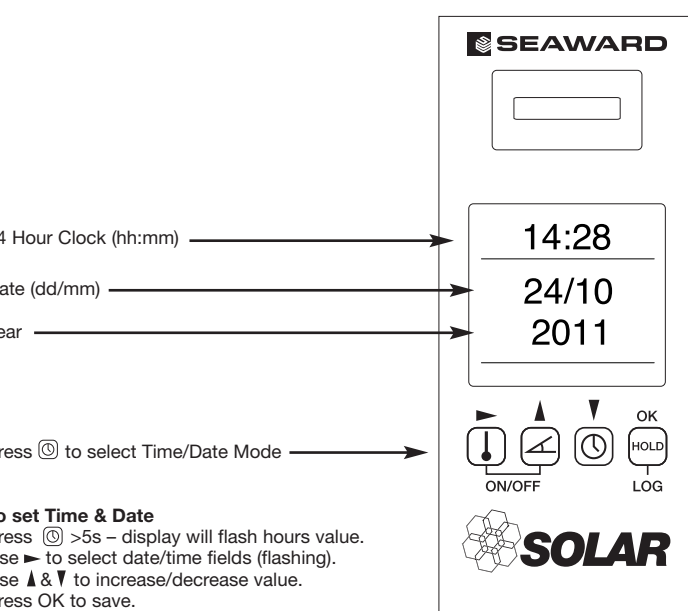

Hora y fecha (solo Survey 200)

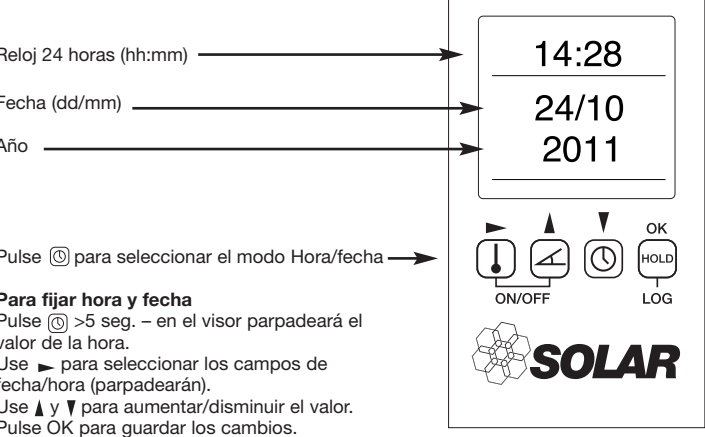

Datalogging (Survey 200 only)

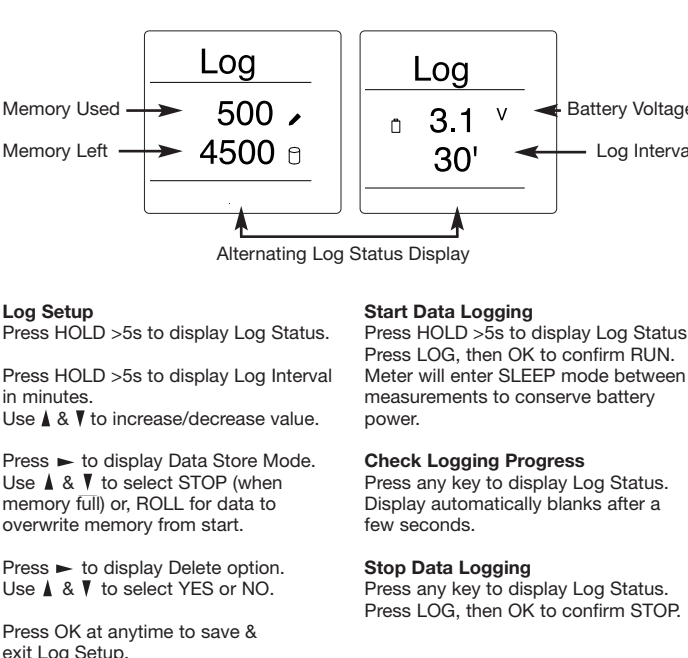

Registro de datos (Solo Survey 200)

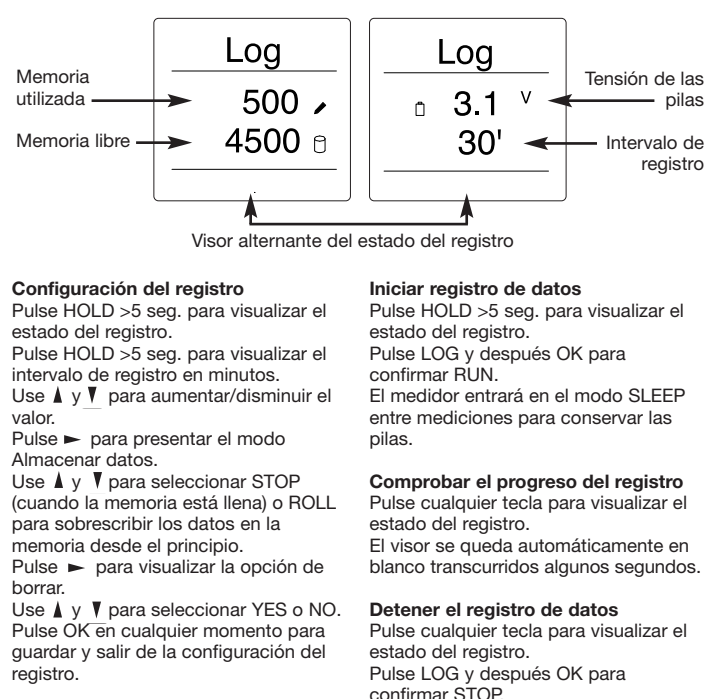

Übersicht

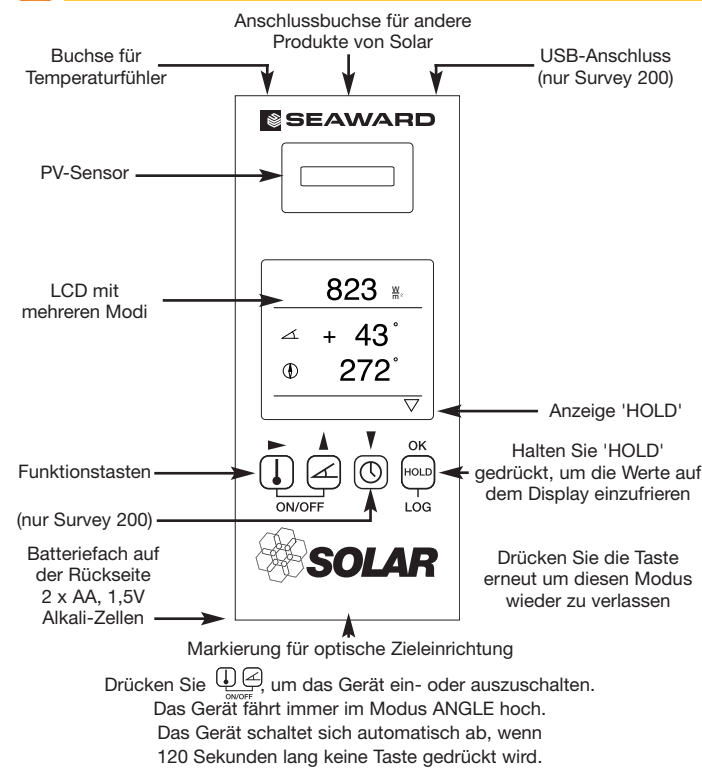

Descrizione

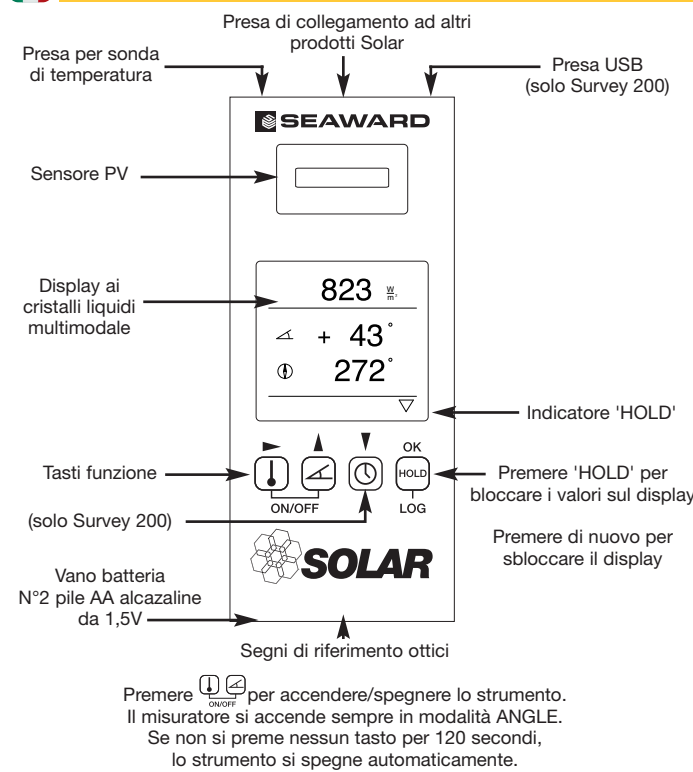

Vue générale

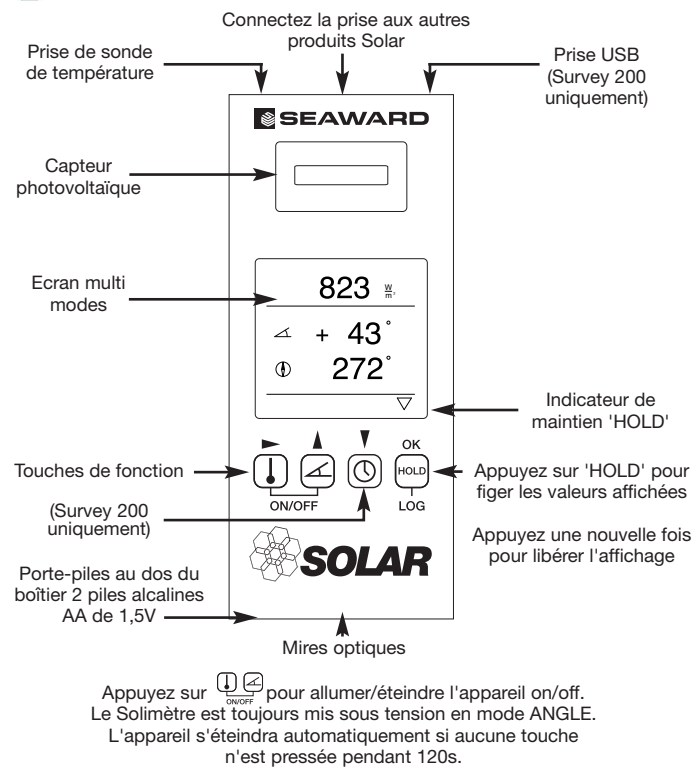

Strahlungsintensität mittels Kompass und Neigungsmessung

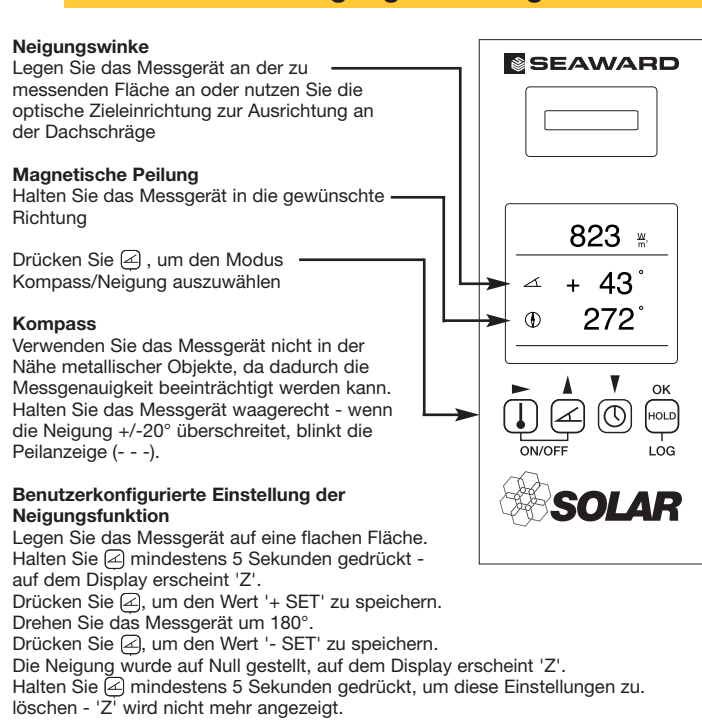

Misurazione dell'irraggiamento con il metodo della bussola / dell'inclinazione

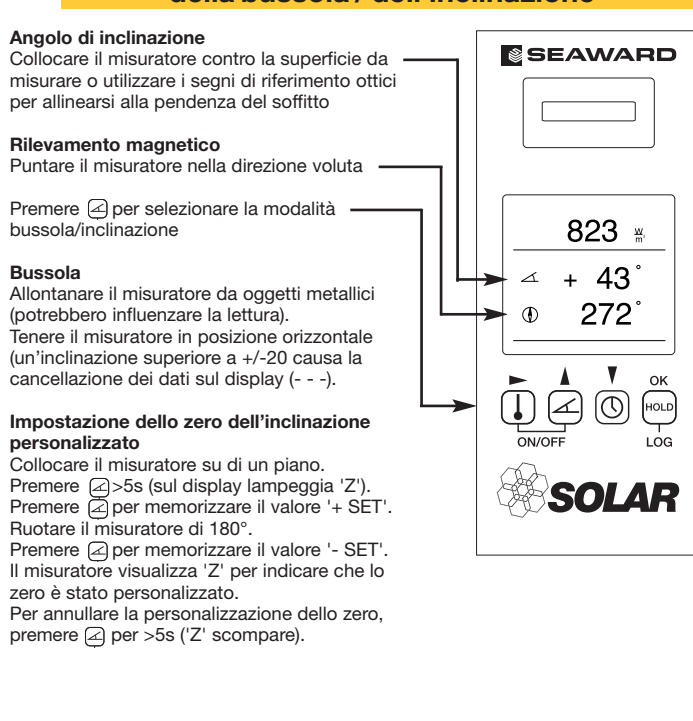

Irradiance avec Boussole et Mesure d'Inclinaison

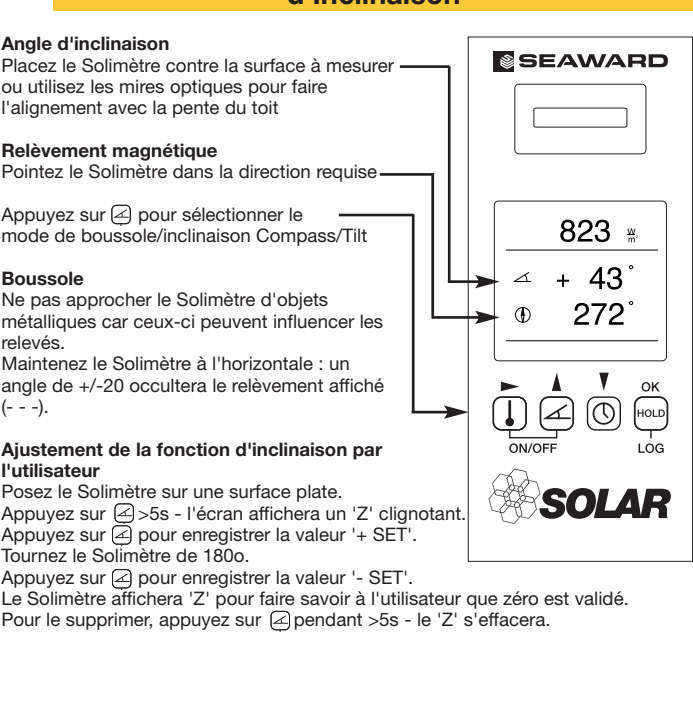

Messung von Strahlungsintensität und Temperatur

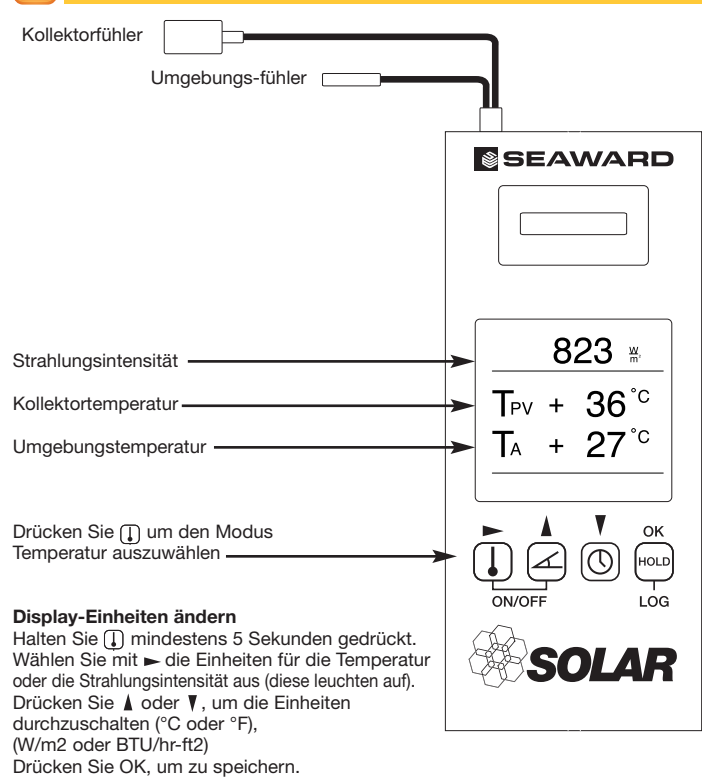

Misura dell'irraggiamento e della temperatura

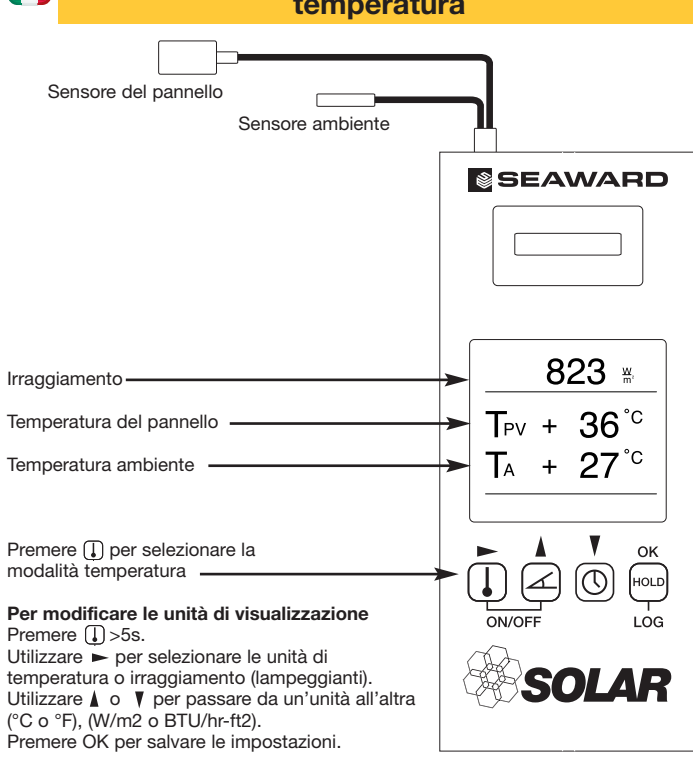

Irradiance et Mesures de Température

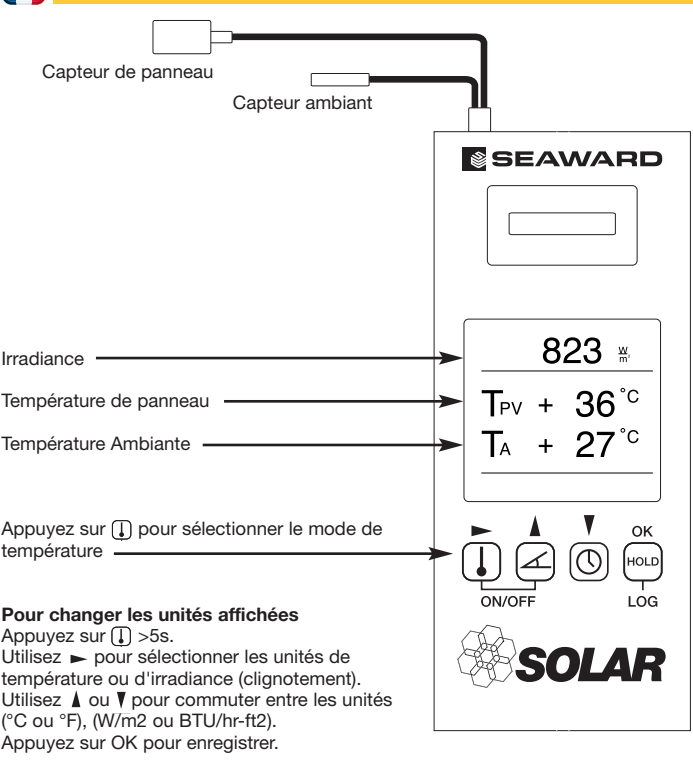

Zeit & Datum (nur Survey 200)

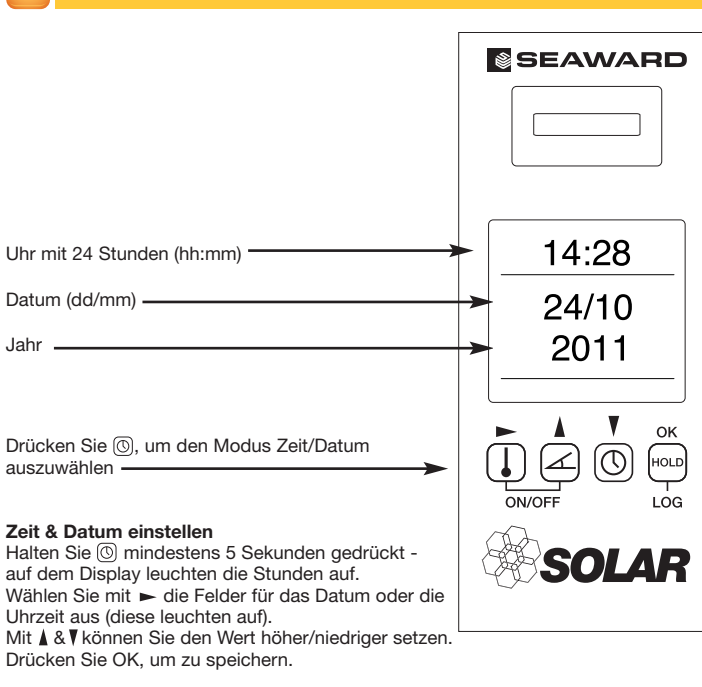

Data e ora (solo Survey 200)

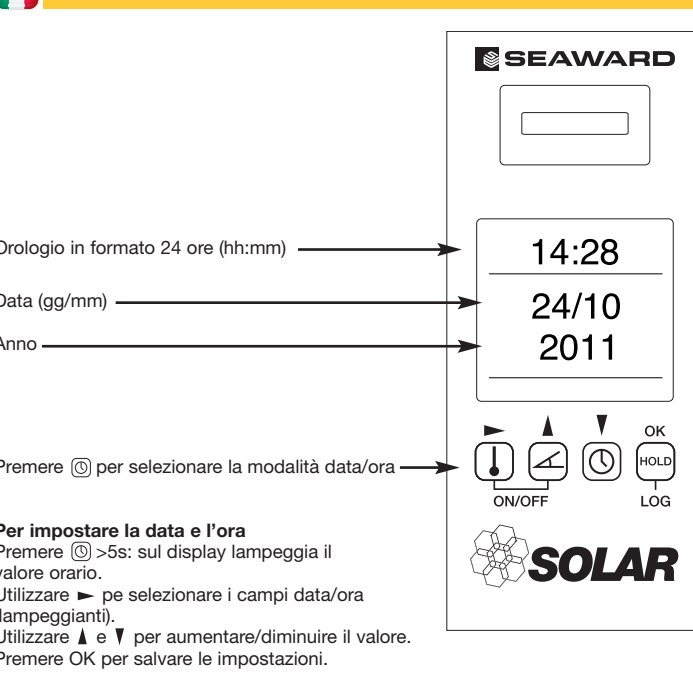

Heure et Date (Survey 200 uniquement)

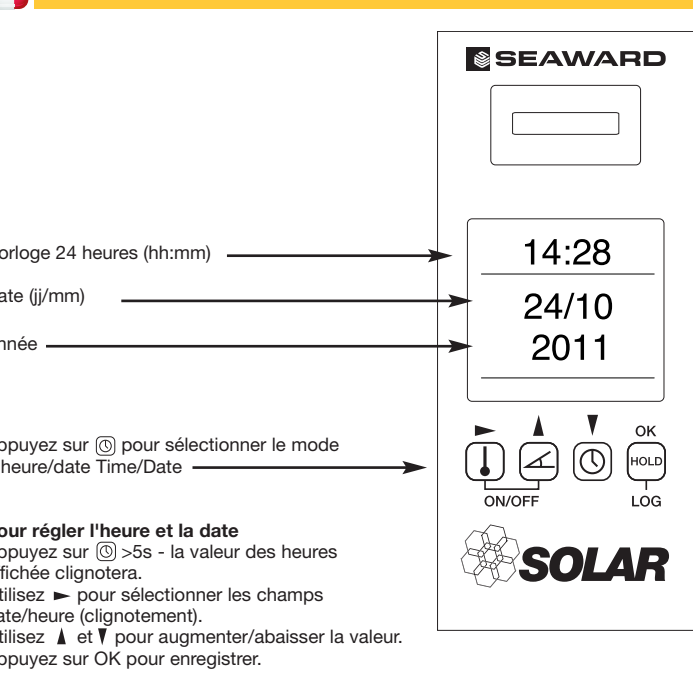

Datenprotokollierung (nur Survey 200)

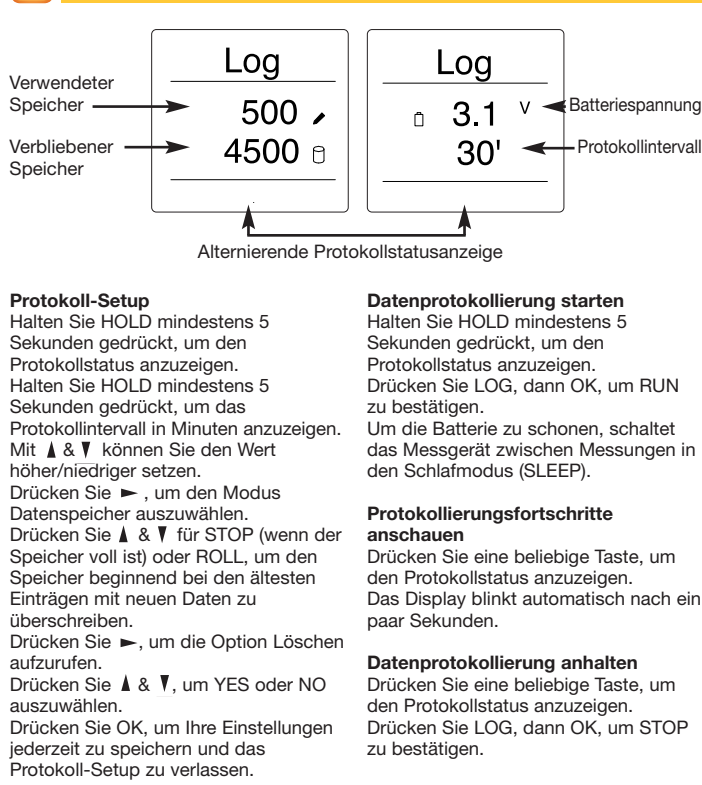

Registrazione dei dati (solo Survey 200)

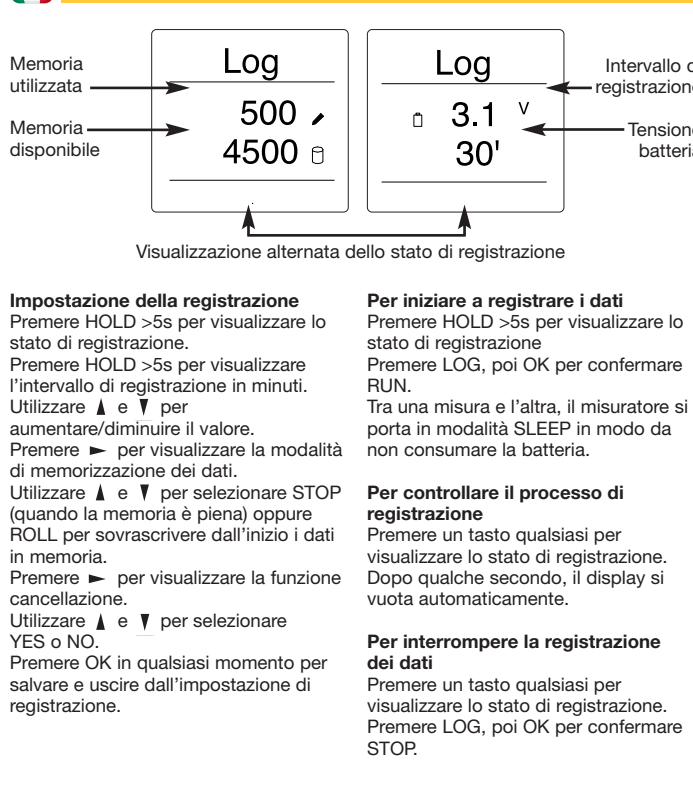

Enregistrement des Données (Survey 200 uniquement)

