

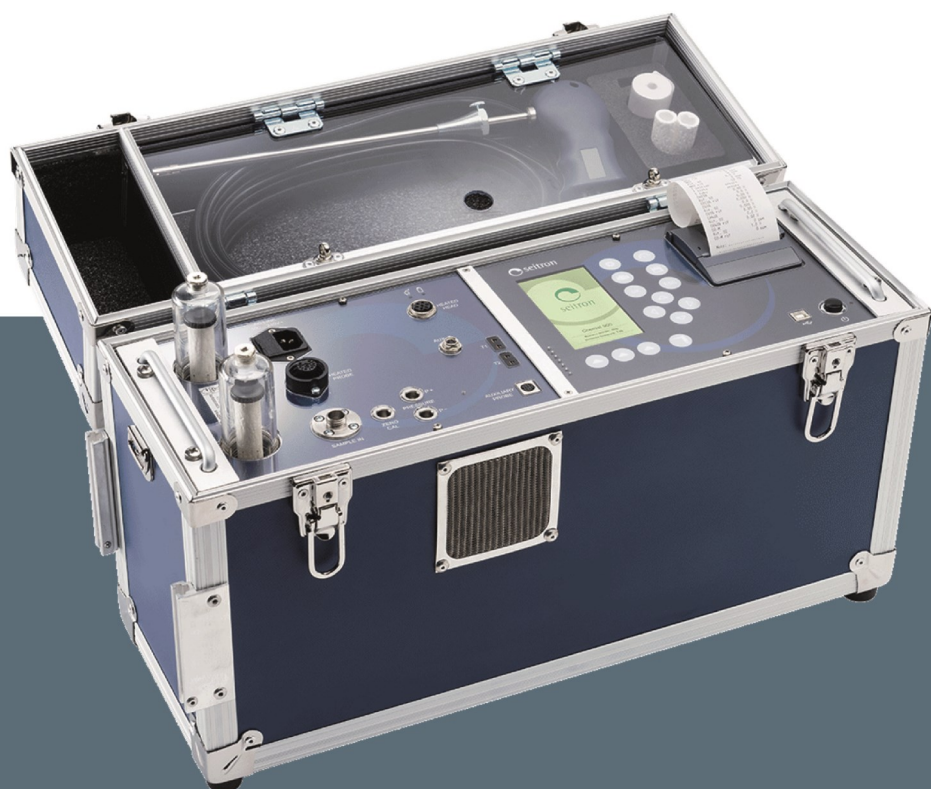

USE AND MAINTENANCE



S9000

Industrial Analyzer

SEITRON AMERICAS Inc. - ALL RIGHTS RESERVED -

Any reproduction, in whole or in part, of this document by any means (including photocopying or storing it in any electronic device) and the transmission of the latter to third parties in any way, including electronically, is strictly forbidden without the prior written approval by SEITRON AMERICAS Inc.

IMPORTANT INFORMATION	08
Information about this manual	08
Safety warnings	08
SAFETY	09
Intended use of the product	09
Improper use of the product	09
GENERAL FEATURES	10
Overview of the Flue Gas Analyzer	10
PRODUCT DESCRIPTION	12
Operating principle	12
Measurement cells	12
Infrared bench	13
CO dilution	13
Types of fuels	13
Sample treatment	13
Peltier module condensation assembly (Cooler)	13
Condensate trap	14
Remote condensate sink	14
External dust filters	14
Infrared bench protection dust filters	14
Air filter	14
Remote air inlet	14
Pressure sensor	14
Gas suction pump	15
Peristaltic pump	15
Draft measurement with automatic sensor zeroing	15
Sooth measurement	15
Temperature measurements	15
Auxiliary measurements	15
Bluetooth® data link	15
DESCRIPTION OF COMPONENTS	16
Front panel	16
Components outside the unit	19
Access to the internal components	20
Internal components - sensors side	21
Internal components - sample treatment side - case of condensate trap	22
Internal components - sample treatment side - case of Peltier cooler	23
TECHNICAL FEATURES	24
Technical features	24
Measurement and Accuracy Ranges	26
STARTUP	28
Preliminary operations	28
Warnings	28
Power supply of the Analyzer	29
Checking and replacing the batteries	29
Use with external power pack	29
Connection diagram	30
Gas sampling heated line (hose + head with AISI 316L stainless steel internal filter for NOx - SOx measurement)	32
Gas sampling probe for industrial engines	33

Probe with heated head for carbon black measuring	33
Combustion air temperature sensor	33
Temperature measurement with Tc-K sensor	34
Auxiliary temperatures measurement sensor	34
Ionization current measuring probe	34
Manometer for draft measurement	34
Pressure test kit	34
Burner pressure verification probe	35
Hose for remote zero air suction	35
POWER ON - OFF	36
Starting the device	36
CONFIGURATION	37
Configuration Menu	37
Configuration→Analysis	38
Configuration→Analysis→Fuel	40
Configuration→Analysis→Condensation	41
Configuration→Analysis→O ₂ reference	42
Configuration→Analysis→NO _x /NO ratio	43
Configuration→Analysis→Measurement units	44
Configuration→Analysis→Measures list	45
Configuration→Analysis→Sample processing	47
Configuration→Analysis→Autozero	48
Configuration→Analysis→Air temperature	49
Configuration→Instrument	50
Configuration→Instrument→Bluetooth®	52
Configuration→Instrument→Time/Date	53
Configuration→Instrument→Brightness	54
Configuration→Instrument→Buzzer	55
Configuration→Instrument→Pumps	56
Configuration→Instrument→Pumps→Suction	57
Configuration→Instrument→Pumps→Peristaltic	58
Configuration→Instrument→Dilutor	59
Configuration→Instrument→Micromanometer	60
Configuration→Instrument→NDIR bench	61
Configuration→Operator	62
Configuration→Alarms	64
Configuration→Information	65
Configuration→Information→Battery	66
Configuration→Information→Sensors	67
Configuration→Information→Info Service	68
Configuration→Information→Reminder	69
Configuration→Information→Probes	70
Configuration→Diagnostic	71
Configuration→Diagnostic→Sensors	72
Configuration→Diagnostic→Pump	73
Configuration→Diagnostic→Pump→Suction	74
Configuration→Diagnostic→Pump→Peristaltic	75
Configuration→Diagnostic→Gas probe	76
Configuration→Diagnostic→On site calibration	77
On site calibration procedure	78
Configuration→Diagnostic→Hardware	85
Configuration→Diagnostic→NDIR bench	86
Configuration→Diagnostic→Sample processing	87
Configuration→Language	88

Configuration→Restore	89
MEMORY	90
Memory Menu	90
Memory arrangement	92
Memory→Save	93
Memory→Average	95
Memory→Select	96
Memory→Memory recall	97
Memory→Data logger	100
Memory→Data logger→Manual	101
Memory→Data logger→BlmSchV - data logger	102
Memory→Data logger→Data logger	103
Memory→Delete	105
Memory→Delete→Single	106
Memory→Delete→All	107
Memory→Usage	108
PRINT	109
Print Menu	109
Print→Report	110
Print→Configuration	111
Print→Test	112
Print→Printer	113
Print→Printer→Pairing	114
Print→Header	116
Print→Measures list	118
MEASUREMENTS	120
Measurements menu	120
Measurements→Draft	122
Measurements→Smoke	123
Smoke measurement with manual pump (optional)	124
Performance test with the manual soot pump	124
Smoke measurement with heated head probe (optional)	126
Put into service of the smoke probe with heated head	126
Connecting the heated head probe for smoke measurement	127
Performing the test with the smoke probe	128
Measurements→Ambient CO	129
Measurements→Temperature	130
Measurements→Pressure	131
Measurements→Velocity	132
How to connect the Pitot tube to the instrument	133
Test execution	134
Measurements→AUX measurements	135
Measurements→Power of burner	136
Testing in 'Manual' mode	137
Testing in 'Measure' mode (based on flow rate)	138
Testing in 'Measure' mode (based on meter)	139
Measurements→Ionization probe	141
COMBUSTION ANALYSIS	142
Combustion Analysis	142
Startup and device auto-calibration	142
Inserting the probe in the stack	142
Simultaneous measurement of pressure, O ₂ , pollutants	143

Combustion Analysis	144
End of Analysis	144
Combustion Analysis - Preliminary operations	145
Combustion Analysis - Manual mode	147
Combustion Analysis - BImSchV mode	149
Combustion Analysis - Data logger mode	150
Combustion Analysis - Periodic mode	152
SENSORS	153
Sensors arrangement in the sensors compartment	153
Sensors list	153
Sensor types and relevant positioning	154
Gas sensors life	155
Gas sensors life table	155
Expandability to 9 sensors	156
CxHy sensor for measurement of the unburnt hydrocarbons (Pellistor)	157
Installing the CxHy sensor	157
CO ₂ sensor for Carbon Dioxide measurement (NDIR single sensor)	158
Installing the CO ₂ sensor	158
NH ₃ sensor for ammonia gas measurement in combustion processes	159
NDIR infrared bench	160
MAINTENANCE	161
Routine maintenance	161
Preventive maintenance	161
Cleaning the sample probe	161
Cleaning the industrial engines sample probe	162
Cleaning the heated sample probe	163
Maintaining the external dust filter unit	164
Replacing the gas sensors	165
Replacing the printer paper roll	168
Firmware update	169
TROUBLESHOOTING	170
Troubleshooting guide	170
SPARE PARTS AND SERVICE	172
Spare parts	172
Accessories	173
Service centers	174
ANNEX A - Analysis report examples	175
ANNEX B - Coefficients of the fuels and Formulas	178
ANNEX C - Optional measures list	179
WARRANTY CERTIFICATE	181



WARNING

This manual is referred to firmware version 1.26.
Visit our website www.seitronamericas.com to download the latest
User and Maintenance manual.



1.1 Information about this manual

- This manual describes the operation and the characteristics and the maintenance of the Combustion Analyzer S9000.
- Read this operation and maintenance manual before using the device. The operator must be familiar with the manual and follow the instructions carefully.
- This use and maintenance manual is *subject to change due to technical improvements - the manufacturer assumes no responsibility for any mistakes or misprints.*



Respect your environment: think before printing the full manual on paper.

1.2 Danger levels and other symbols

Symbol	Meaning	Comments
--------	---------	----------



Warning

Read information carefully and prepare safety appropriate action!

To prevent any danger from personnel or other goods. Disobey of this manual may cause danger to personnel, the plant or the environment and may lead to liability loss.

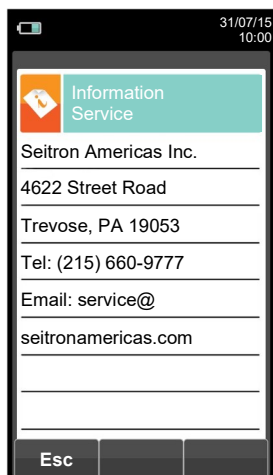

Information on LCD



Ensure correct disposal

Dispose of the battery pack at the end of its working life only at the dedicated collecting bin.

The customer takes care, on his own costs, that at the end of its working life the product is collected separately and it gets correctly recycled.



Keyboard with preformed keys with main control functions.

2.1 Proper use of the product

This chapter describes the areas of application for which this instrument is intended.

All products of the series S9000 are portable measuring devices for flue gas and emissions analysis for the following machinery:

- Furnaces (fuel oil, gas, wood, coal)
- Low-temperature and condensing boilers
- Gas heaters
- Combustion in industrial processes
- Measures for control of emissions
- Machinery test compliance
- Gas turbines
- Gas engines
- Furnaces and boilers manufacturer's technical assistance
- Technical assistance in industrial heating systems

This measuring device is capable of measurements under German regulations on emissions protection (1. BImSchV)¹.

Additional functions of this measuring instrument:

- Flue gas analysis according to 1. BImSchV or qA-a mean value (selectable)
- Calculating of stack heat loss and efficiency
- CO environment measurement
- Smoke value, calculation of average value
- Measurement of differential pressure
- Draft measurement
- Pressure measurement in the gas supply line

2.2 Improper use of the product

The use of S9000 in application areas other than those specified in Section 2.1 "Intended use of the product" is to be considered at the operator's risk and the manufacturer assumes no responsibility for the loss damage or costs that may result. It is compulsory to read and pay attention to the instructions in this use and maintenance manual.

S9000 should not be used:

- as an alarm device for safety purposes
- in classified zones with explosion risk (ATEX or equivalent)

3.1 General overview of the Analyzer

S9000 is a portable industrial analyzer for flue gas and emissions monitoring.

The instrument is equipped with:

- Pneumatic circuit which can accommodate up to 9 sensors in the FLEX-sensors series.
- Housing for fitting an NDIR (infrared) bench for measurement of CO, CO₂ and CH₄.

Moreover:

- The gas autozero cycle can be performed with the probe inserted in the stack.
- The autozero of the pressure sensor (piezoresistive, temperature compensated) can also be performed with the gas probe inserted in the stack.
- Intuitive user interface: the instrument can be used without the support of the user manual.
- Wide (55x95 mm) and bright TFT color display which delivers great readability thanks to the zoom function and an efficient backlight.
- Single rechargeable 'Li-Ion' battery pack, used to power both the unit and the thermal printer. The battery charger is internal to the instrument and allows to perform the dual function of battery charging and power supply for the instrument, thus enabling the user to work even with the batteries fully discharged by connecting the AC power cable, once connected to a 90 to 264Vac mains source.
- Thermal printer integrated in the instrument.
- Connectivity with a computer through the USB connection and/or Bluetooth®. Once the special software provided with the instrument is used, this allows for the storage of combustion analysis as well as the configuration of the main parameters.
- Connectivity with a smartphone through Bluetooth®. Once the specific APP 'SEITRON SMART ANALYSIS' available on Google play-store is installed on the device, the user can start remote analysis of combustion and/or view real-time data of the analysis in progress.

S9000 Analyzer is transportable and therefore is delivered in a durable aluminum case.

Main functions:

- Combustion analysis in manual or automatic mode (BlmSchV or according to the data logger function, user-defined mode).
- Comes with 11 most used fuel parameters (such as natural gas, LPG, gas oil and fuel oil).
- Possibility to store in memory the parameters for 16 further fuels, once their chemical composition is known.
- Monitoring of pollutants (emissions)
- Memory capable of storing up to 16,000 full analysis.
- Storing of acquired data and their averaging.

Measurable gases:

- CO (NDIR), CO₂ (NDIR), C_xH_y (NDIR)
- O₂
- CO (ambient monitoring)
- CO / H₂
- CO (low, medium, high)
- NO (low, medium)
- NO₂ (low, medium)
- SO₂ (low, medium)
- NO_x
- H₂S
- NH₃
- H₂

Measurements:

- Ambient CO (with the internal sensor)
- Draft in the stack.
- Smoke (with the use of the external manual pump).
- Gas pressure in the piping, pressure in the burning chamber and check of the pressure switches, using the measurement range up to 200hPa.
- Combustion air measurement
- Auxiliary temperatures
- Air speed for air or flue gas leaving the stack with the use of Pitot tube
- Ionization current measurement (with external auxiliary probe)

Maintenance:

- Sensors can be replaced by the user without having to ship the instrument to the service center, because the spare sensors delivered are pre-calibrated.
- The instrument requires annual calibration carried out at any authorized service center.

Certificate of calibration

The instrument is accompanied with a calibration certificate.

4.1 Working principle

The gas sample is taken in through the gas probe, by a diaphragm suction pump inside the instrument. The measuring probe has a sliding cone that allows the probe to be inserted in holes with a diameter of 11 mm to 16 mm and to adjust the immersion depth: **it is recommended to have a gas sampling point roughly in the center of the flue/stack.** The gas sample is cleaned of humidity and impurities by a condensate trap and filter located inside the instrument. The gas is then analyzed in its components by electrochemical and infrared sensors. The electrochemical cell guarantees high precision results in a time interval of up to about 60 minutes during which the instrument can be considered very stable. When measurement is going to take a long time, we suggest auto-zeroing the instrument again and flushing the inside of the pneumatic circuit for three minutes with clean air. During the zero calibrating phase, the instrument aspirates clean air from the environment and detects the cells' drifts from zero (20.95% for the O₂ cell), then compares them with the programmed values and compensates them. The pressure sensor autozero must, in all cases, be done manually prior to measuring pressure. The values measured and calculated by the microprocessor are viewed on the LCD display which is backlit to ensure easy reading even when lighting is poor.

4.2 Measurement cells

The instrument takes advantage of pre-calibrated FLEX-series gas sensors for the measurement of Oxygen (O₂), Carbon Monoxide (CO - Hydrogen compensated measurement, Nitrogen Oxide (NO), Nitrogen Dioxide (NO₂), Sulphur Dioxide (SO₂) and Hydrogen sulfide (H₂S). The sensors do not need particular maintenance yet they have to be replaced periodically when exhausted. Measurement of the oxygen (%O₂) is carried out with an electrochemical cell that behaves like a battery which it is subject, over time, to lose sensitivity due to the fact that normally is ever present in the air about 20.9% Oxygen. The toxic gases (CO, SO₂, NO, NO₂) are measured with electrochemical sensors that are not subject to natural deterioration being intrinsically lacking of oxidation processes. The measurement cells are electrochemical cells made up of an anode, a cathode, and an electrolytic solution, which depends on the type of gas to be analyzed. The gas penetrates the cell through a selective diffusion membrane and generates an electric current proportional to the absorbed gas. Such current is measured, digitalized, temperature-compensated, processed by the microprocessor, and displayed.

The gas shall not be at such a pressure to damage or destroy the sensors; for this reason the suction pump is continuously adjusted, in order to ensure an appropriate flow to the sensors. The maximum estimated allowed pressure is ± 100 hPa gage.

The response times of the measurement cells used in the analyzer are:

O ₂	=	20 sec. at 90% of the measured value
CO(H ₂)	=	50 sec. at 90% of the measured value
CO	=	50 sec. at 90% of the measured value
NO	=	40 sec. at 90% of the measured value
NO ₂	=	50 sec. at 90% of the measured value
SO ₂	=	50 sec. at 90% of the measured value
H ₂ S	=	50 sec. at 90% of the measured value
NH ₃	=	90 sec. at 90% of the measured value
H ₂	=	90 sec. at 90% of the measured value

It is therefore suggested to wait 5 minutes (anyway not less than 3 minutes) in order to get reliable analysis data.

If sensors of toxic gases are submitted to concentrations higher than 50% of their measurement range for more than 10 minutes continuously, they can show up to $\pm 2\%$ drift as well as a longer time to return to zero. In this case, before turning off the analyzer, it is advisable to wait for the measured value be lower than 20ppm by in taking clean air. If there is an automatic calibration solenoid, the device performs an automatic cleaning cycle and it turns off when the sensors return to a value close to zero. The auto-zero solenoid valve allows the operator to turn the instrument on with the probe inserted in the flue. Up to 4 alarm set points are programmable with visual and acoustic signals for the relevant measurement parameters. The standard provides that the instrument must be calibrated by a certified laboratory that is authorized to issue annual calibration certificates. Exhausted cells can be easily replaced by the user without depriving himself of the instrument and without complicated calibration procedures with certified mixtures as they are pre-calibrated before being supplied.

Seitron Americas certifies the accuracy of the measurements only upon a calibration certificate issued by its laboratory or other approved laboratory.



WARNING

Some sensors (for example NH₃, H₂, H₂S, SO₂,...) are sensible to other gases called interfering gases.

On the analysis phase, the influence of interfering gases is compensated only if on the instrument are installed the correspondent sensors.

If a sensor sensitive to NO and NO₂ interfering gases is installed on the instrument, but only the NO sensor is installed in the instrument, NO₂ gas compensation is carried out starting from the NOx/NO ratio.

4.3 Infrared bench - Optional

On this instrument it is possible to install an infrared bench, for the measurement of gases, which is based on the infrared spectroscopy (IR). With this method it is possible to measure CO, CO₂ (which are therefore not calculated, but measured instead), and hydrocarbons C_xH_y. Along the pneumatic circuit, before the IR bench, an additional dust filter is inserted.

The principle is based on non-dispersive absorption of infrared radiation (NDIR) at two different wavelengths, which allows accuracy, stability over time and high response speed.

The gases absorb light at particular wavelengths, most in the IR range. An NDIR system includes: an IR light source, a chamber containing the gas sample to be analyzed, and a photodetector equipped with an optical filter. The light passes through the chamber and the sample of the gas will absorb it at a specific wavelength (eg. 4.26µm for CO₂) or on specific bands.

The signal collected by the photodetector is then processed by the electronics in order to obtain the concentration of CO, CO₂ or C_xH_y.

The filter is the non-dispersive optical component and allows the photodetector to uniquely identify the gas based on the performance of the absorption spectrum. The more narrow the bandwidth of the filter, the greater the specificity of the sensor.

The intensity of light (at a certain wavelength) that reaches the detector is inversely proportional to the concentration of the gas treated. The infrared measurement technique allows measurements that are not interfered by the presence of other gases.

4.4 CO dilution

One of the characteristics of the electrochemical sensor for the measurement of CO is the need to require very long self-calibration time in case it has been in contact with high gas concentration (greater than the full scale) for a long time.

The CO sensor is therefore protected in this instrument by an automatic dilution system that allows to extend the measuring range of the sensor without overloading the sensor itself.

The dilution system allows to have the CO sensor efficient any time and ready to perform properly even in case of very high concentration of CO.

The dilution system also allows to extend the measurement range of the CO sensor as follows:

- up to 100,000 ppm for a CO sensor with 8000 ppm full scale
- up to 250,000 ppm for a CO sensor with 20,000 ppm full scale

In this way in addition to better manage the wearing of the sensor, it is also possible to continue sampling, without any work interruption.

4.5 Fuel types

The device is provided with the technical data of the most common types of fuels stored in its memory. By using the PC configuration program, available as an optional, it is possible to add fuels and their coefficients in order to define up to a maximum of 32 fuels, other than the default ones.

For more details see [Annex B](#).

4.6 Sample treatment

The gas sample to be analyzed must be delivered to the measuring sensors properly dried and cleaned of solid residues of combustion; actually for this reason it is usually named 'dry analysis'.

For this purpose S9000 accepts two different modules for sample treatment:

- Peltier module condensation assembly (Cooler)
- Water trap

4.6.1 Peltier module condensation assembly (Chiller) - Option

This is an integrated system for the conditioning of the gas sample.

The condensation assembly with Peltier module has the goal of cooling as fast as possible the gas sample down to the temperature of 5° C.

The cooler causes the moisture contained in the gas to condensate thus allowing the gas to reach the sensors without undergoing significant changes in its composition. This system is particularly useful when water-soluble components have to be analyzed (e.g. SO₂, NO₂, etc.).

In order to raise the efficiency of the Peltier module condensation assembly, it is advisable to use, for the sampling of gas, a special probe with heated head and/or heated hose.

This probe includes in its interior a thermoresistance for the automatic control of the temperature, which must be maintained above the dew point any time, to prevent unwanted condensation at the probe level.

The heated hose allows the gas to reach Peltier module condensation assembly unchanged in its chemical characteristics.

In conditions of extreme ambient temperature (+113° F) it is possible that the internal temperature of the cooler is not maintained at +41° F but tends to move up to +50° F /+59° F, this internal temperature is still sufficient to obtain the drying of the gas, in these conditions it is possible to lose about a 10% efficiency of drying.

4.6.2 Water trap - Optional

Consisting of a cylinder in transparent polycarbonate it is positioned along the pneumatic circuit inside the body of the analyzer.

Its purpose is to decrease the speed of the air so that it will be no longer able to carry the heavy particles of dust and water which, consequently, will fall into the cylinder.

The bottom of the water trap's body is connected to a peristaltic pump, controlled directly by the microprocessor, for the emptying thereof. The condensation water is expelled through the condensation drain positioned at the bottom of the analyzer. The peristaltic pump is activated in an intermittent manner in order to preserve the life of the hose, which is an integral part of the pump itself.

The hose has an average life of about 500 hours; the diagnosis menu features a timer which countdowns the residual life of the hose. When the hose is replaced, it is mandatory to manually reset the timer [see section 9.9.2](#)).

4.7 Remote condensate drain

On the bottom side of the instrument suitcase is located the output of the condensation water.

By properly connecting an appropriate silicone hose it is possible to move the output point of the condensation water.

4.8 External dust filters

In order to protect the pneumatic circuit and the gas sensors, two protecting filters are placed inside the analyzer. These two filters are in series with each other: the first is the lowest one, the second is at the top.

Consisting of a cylinder in transparent polycarbonate, these are located on the left side of the analyzer protected from impacts with a protection bar.

A replaceable, low-porosity filter is positioned within each cylinder with the purpose of retaining solid particles suspended in the flue gas. The filter has an efficiency of 99% for 20um solid particles.

It is recommended to replace the filters any time they are significantly dirty (see section ['MAINTENANCE'](#)).

4.9 Dust filter for the NDIR bench protection

For further protection of the NDIR bench, an additional dust filter has been inserted into the analyzer. Located aside of the cells, it is made of a cylinder in transparent polycarbonate with a replaceable, low-porosity filter inside, with the purpose of retaining solid particles suspended in the flue gas. We recommend to check the filter once a year during periodic maintenance.

4.10 Air filter

A further dust filter is located inside the analyzer with the purpose to protect the circuit that samples air from the environment during the autozero cycle. We recommend to check the filter once a year during periodic maintenance.

4.11 Remote air intake

The top panel of the analyzer is a pneumatic connector labelled as 'ZERO CAL'. This connector is the air intake used to perform the auto-zero for the gas sensors.

In particular conditions, where the instrument is placed in a closed and potentially polluted environment, it is possible to move the air intake of the instrument to an environment with clean air, through the use of a hose with an appropriate male fitting connected to the 'ZERO CAL' input.

4.12 Pressure sensor, piezoelectric, temperature compensated

The instrument is internally provided with a piezoresistive differential pressure sensor, temperature compensated, for measuring pressure or draft.

This sensor is differential type thus, thanks to the second measurement port, can be used for measuring the draft (depressure) in the stack, for the leak test of the pipes, for differential pressure measurement, for measuring the velocity of the flue gas using a Pitot tube, for flow measurement, and possibly for other measurements (pressure of gas in the piping, pressure loss across a filter, etc.).

The measurement range is -1,000 Pa .. +20,000 Pa.

Any potential drift of the sensor are nulled thanks to the autozeroing system which in this instrument can be operated with the flue gas probe inserted in the stack, because the instrument is equipped with a solenoid valve that switches the pressure measurement to the ambient, thus allowing to zero the sensor in air.

4.13 Suction pump

This diaphragm pump, located inside the instrument, is operated with a DC engine powered by the instrument in order to obtain the optimal suction flow rate of the flue gas for the ongoing analysis; an internal sensor measuring the flow allows to:

- Maintain a constant flow rate of the pump
- Check the state of efficiency of the pump
- Check the level of filter clogging



WARNING

ANY PRESSURE APPLIED TO THE SENSOR GREATER THAN ± 300 hPa MAY CAUSE A PERMANENT DEFORMATION OF THE MEMBRANE, THUS DAMAGING IRREVERSIBLY THE SENSOR ITSELF.

4.14 Simultaneous measurement of pressures, O₂, pollutants

The instrument, in order to obtain the best boiler's combustion performance parameters, allows to measure simultaneously the input and output pressure of the gas valve, the level of O₂, the levels of pollutants and all the calculated parameters needed to obtain the correct value of yield.

[See section 13.1.3.](#)

4.15 Peristaltic pump

The peristaltic pump has the purpose to automatically empty the condensation water and it is controlled directly by the microcontroller with alternating intervals of on/off in order to preserve the life of the neoprene hose.

While the interval of ignition is not user controllable, and it is equal to 30 seconds, the duration of the interval is configurable by the user in the range 30..3600 seconds.

4.16 Draft measurement with sensor automatic autozero

S9000 performs the draft pressure measurement. The auto-calibration of the sensor is carried out through the switching of an internal valve that allows to perform the zeroing procedure without removing the probe from the stack.

This feature is particularly useful when the analysis is taken in 'data logger' mode.

4.17 Smoke measurement

It is possible to enter the smoke values measured according to the smoke index scale. The instrument will calculate the average and print the results in the analysis report.

The measurement must be performed with the appropriate probe head heated to measure the carbon black or an external pump which may be required as an accessory.

4.18 Temperature measurements

S9000 can measure several types of temperatures taking advantage of dedicated probes.

4.19 Auxiliary measurements

This analyzer also features a connection to optional external sensors for draft measurement as well as for the measurement of the ionization current in the boilers.

4.20 Bluetooth® connection

The S9000 analyzer is internally equipped with a Bluetooth® module, which allows the communication with the following remote devices:

- Remote Bluetooth® printer
- Smartphone or tablet with installed the OS Google Android v.4.1 (Jelly Bean) or later and the proper APP 'SEITRON SMART ANALYSIS' (available on Google Play Store) installed.
- PCs running Microsoft Windows 7 or later and Bluetooth® interface upon installation of the specific software 'Seitron smart analysis' supplied together with the instrument.

The maximum transmission range in open field is 100 meters (Class 1 Bluetooth® module), provided that also the communication companion is equipped with a Class1 Bluetooth® interface.

This solution allows greater freedom of movement for the operator who is no longer bound directly to the instrument for acquisition and analysis, with significant advantages for many applications.





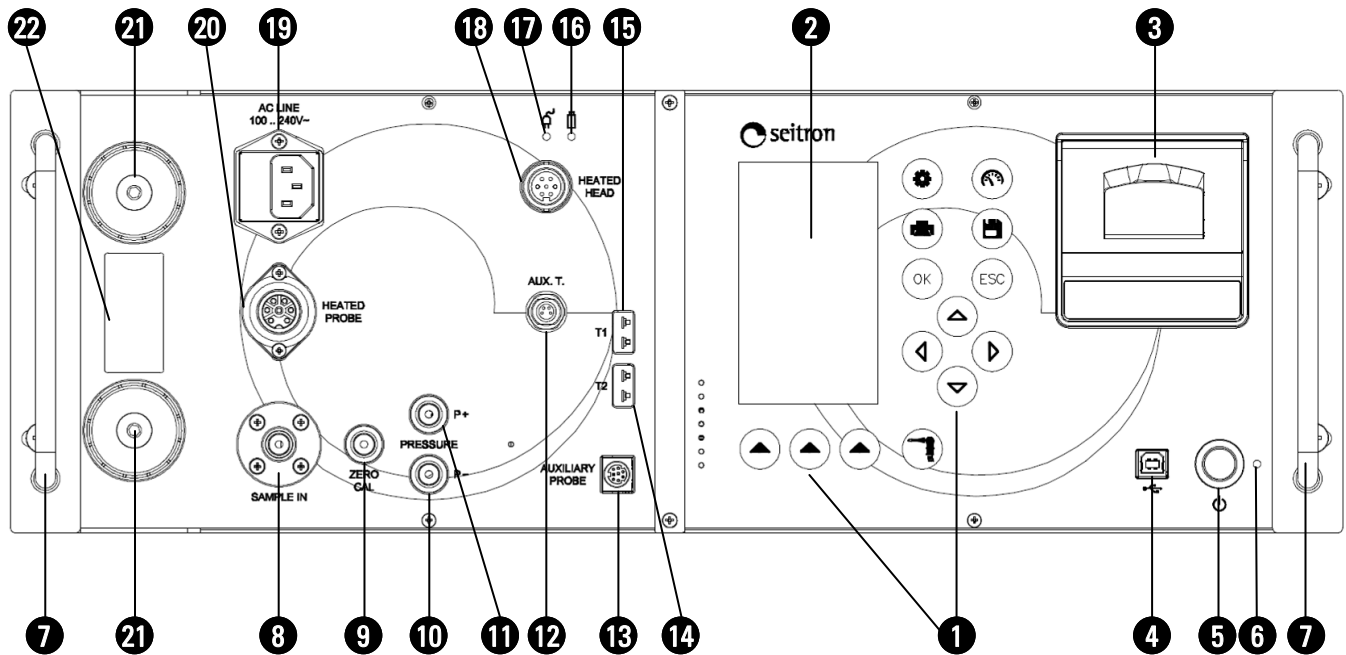

5.0 COMPONENTS DESCRIPTION





5.1 Front panel



DESCRIPTION:

1 Polycarbonate touch keypad and relevant main functions:

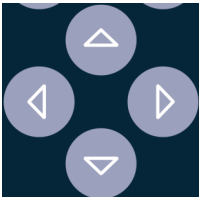
KEY	FUNCTION
	Activates the context keys shown on the display
	Performs the combustion analysis
	Access to the Configuration menu
	Access to the Measurements menu
	Access to the Printing menu
	Access to the Memory menu

KEY	FUNCTION
	Confirm settings
	Quits the current screen
	Select and/or Modify
	Turns off the display backlight

2 Display



TFT 272 x 480 pixel backlit color display with 21 characters available and 8 lines. Allows the user to view the measured parameters in the most comfortable format; a Zoom function displays the measured values in magnified form.

CAUTION:

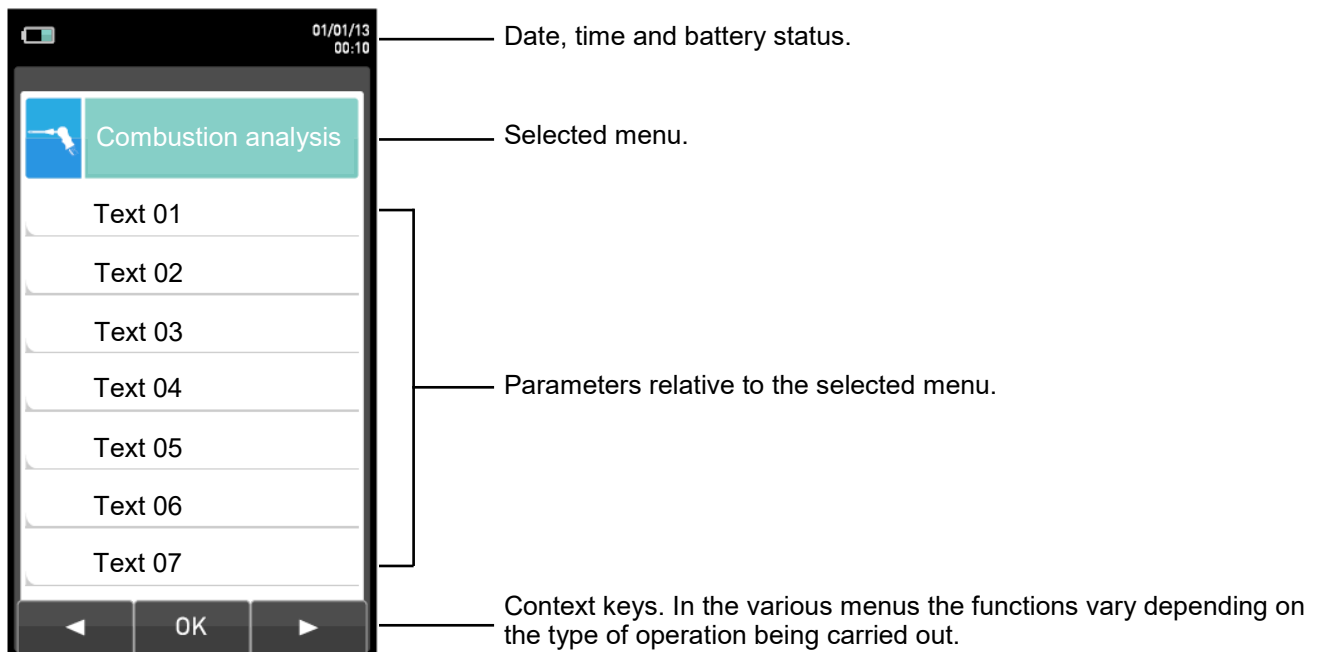
If the instrument is exposed to extremely high or extremely low temperatures, the quality of the display may be temporarily impaired. Display appearance may be improved by acting on the contrast key.



Backlight:

The backlight can be turned off with the simultaneous pressure on keys  + . The backlight is turned on when any key is pressed, except the 'On-Off' key.

3 Printer

Thermal printer on non-fading paper.

By pressing the print button you get access to the corresponding menu from which, in addition to printing the receipt, you can choose the print settings and manually feed the paper in order to simplify the replacement of the paper roll.

4 USB connector (type B)

Used to connect the instrument to a personal computer running Microsoft Windows 7 or later upon installation of the specific software 'Seitron smart analysis', supplied with the instrument.

5 ON / OFF key

To turn on or off the analyzer hold this key down for a few seconds.

6 Programming LED

This LED provides important information during the firmware update procedure. For further details please refer to [section 15.9 'Firmware Update'](#).

7 Handles for the extraction of the instrument from its case

8 'SAMPLE IN' pneumatic connector

Input for connecting the gas sample probe.

9 'ZERO CAL' pneumatic connector

Input for the connection of a hose to remote air source to properly perform the autozero. If the instrument is placed in a closed and potentially polluted environment, the user can remote the air intake for the instrument to a clean air environment using the 'ZERO CAL' connector.

10 'P-' pneumatic connector

Pressure negative input (P-): used for measuring draft; it connects to the second hose (with the larger pneumatic connector) of the sample probe for simultaneous measurement of draft and combustion analysis.

11 'P+' pneumatic connector

Positive input (P+): used for measuring the pressure in general as well as for the leakage test.



Inputs 'P+' and 'P-' are respectively the positive and negative inputs of the internal differential pressure sensor, piezoresistive, temperature compensated; therefore these can be simultaneously used to measure the differential pressure.

12 'AUX. T.' Auxiliary Temperature Connector

M8 4-pole connector for an external temperature sensor (Pt100).

13 'AUXILIARY PROBE' connector

Serial connector, Mini Din 8-pin, for connection of an external probe such as:

- Probe for measurement of the ionization current
- Micromanometer

14 'T2' Connector

Used to connect the Tc-K plug of the incoming combustion air temperature probe.

15 'T1' Connector

Used to connect the Tc-K male connector of the gas temperature probe.

16 Battery-charging indicator

This LED, while the batteries are charging, provides the following information:

- On (red): Battery charging
- Off: Fully charged batteries

Once recharging is started the display is turned on and shows the charging status.

17 Mains power indicator

- On (green): The instrument is powered directly from the mains.
- Off: The instrument is not powered from the mains.

18 'HEATED HEAD' connector

7-pin DIN connector used to power the heated head.

19 'AC LINE - 100..240V ~' connector

IEC C14 socket for the power cable, supplied with the instrument. On the socket is located a fuse-holder drawer for 2 5x20 4A T type fuses .

20 'HEATED PROBE' connector

Used to connect the relevant connector of the heated probe thus powering the heated hose.

21 Two external dust filters

22 Instrument data label

5.2 Parts external to the instrument

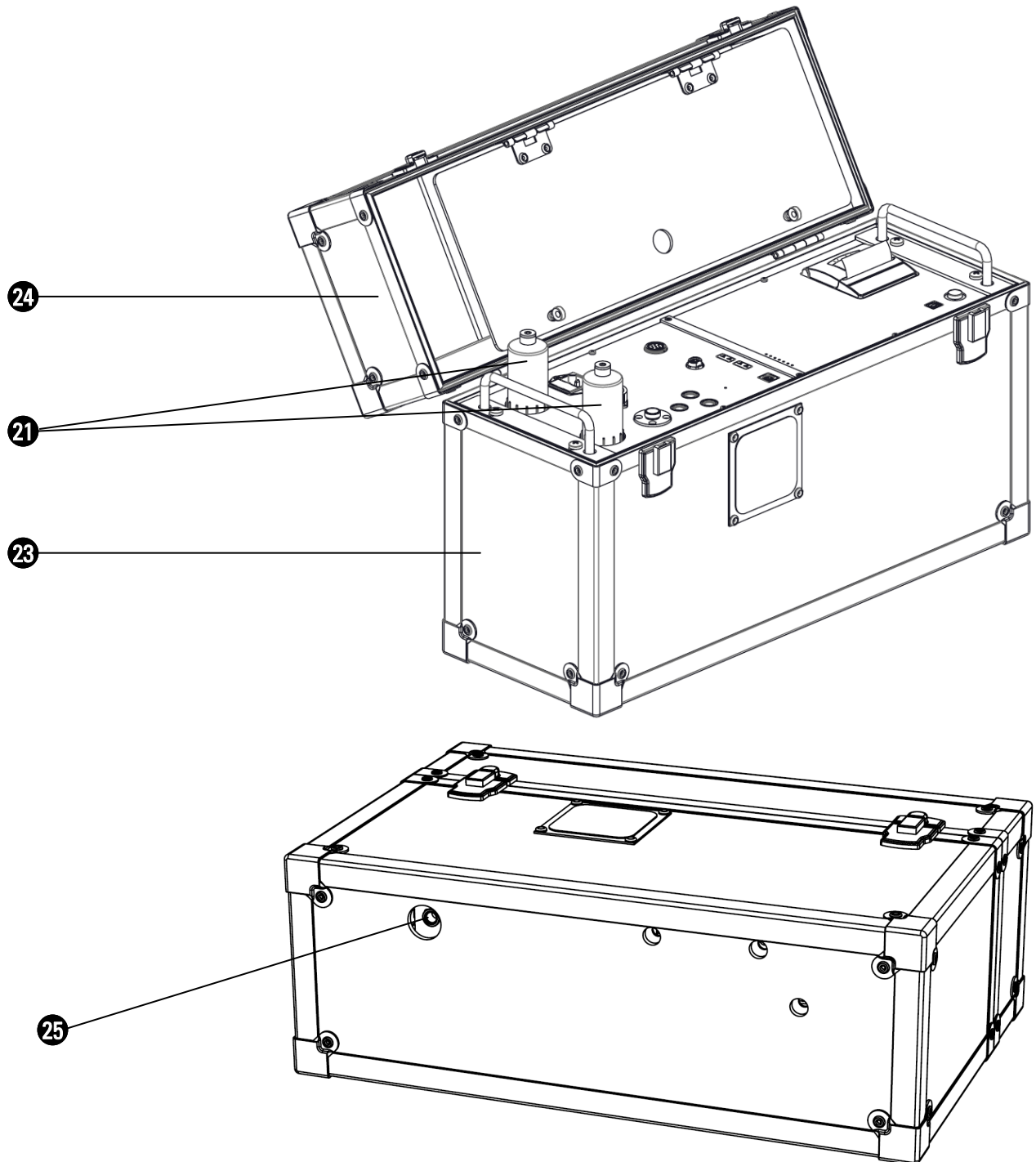

DESCRIPTION:

- 21 Two external dust filters
- 23 Case
- 24 Case - accessories compartment
- 25 Condensate drain

5.3 Access to internal parts

To access the internal parts of the analyzer the instrument has to be removed from the case, as shown in the following pictures:

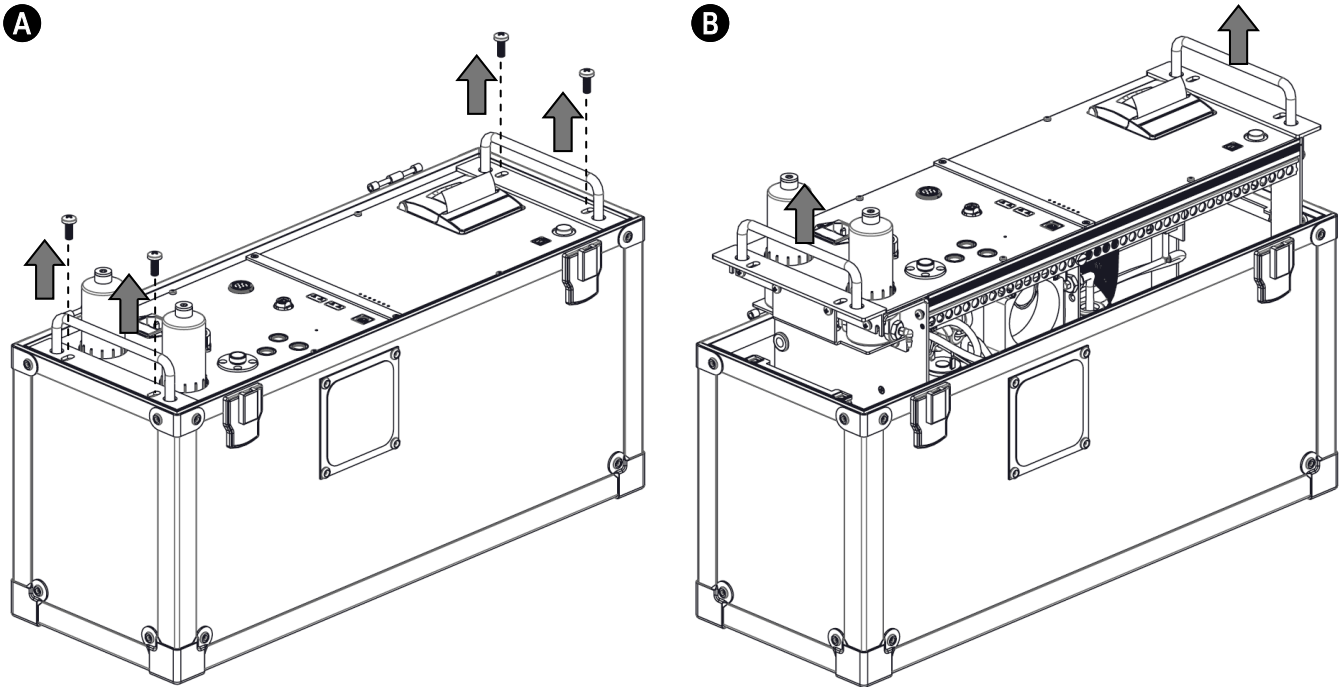

5.4 Instrument internal parts - sensors side

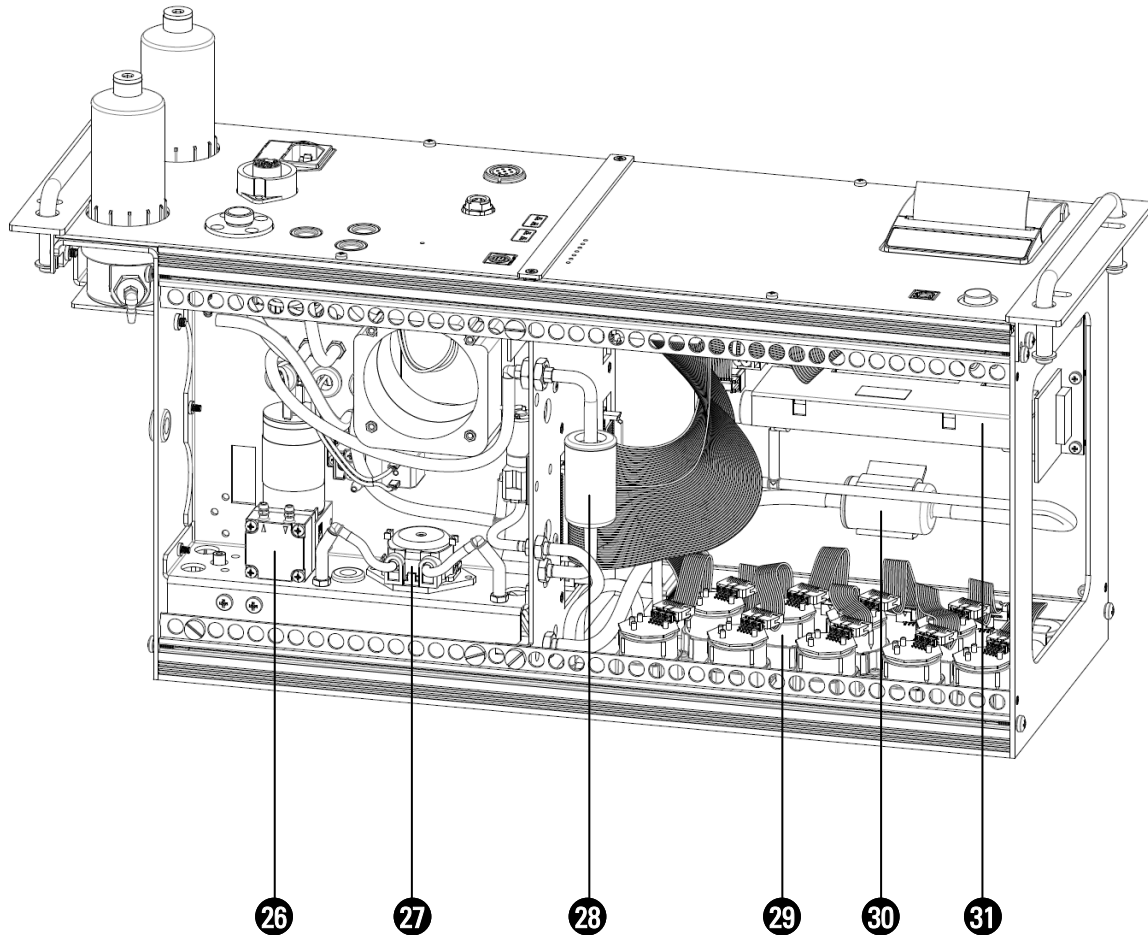

DESCRIPTION:

- 26** Gas suction pump
- 27** Peristaltic pump
- 28** Air filter
- 29** Sensors manifold
- 30** Dust filter for NDIR (infrared) bench protection
- 31** NDIR (infrared) bench

5.5 Instrument internal parts - sample treatment side and condensate trap

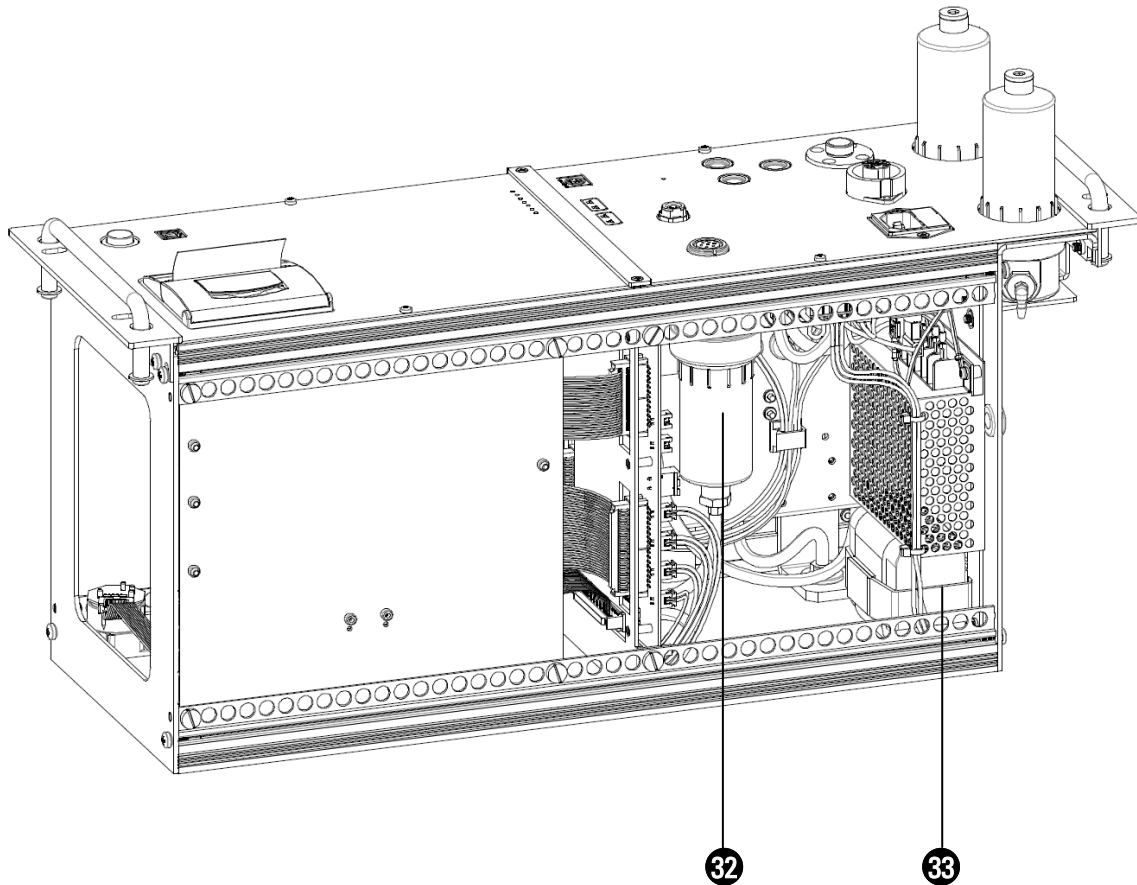

DESCRIPTION:

- 32 Condensate trap
- 33 Battery pack

Instrument internal parts - sample treatment side and Peltier module cooler

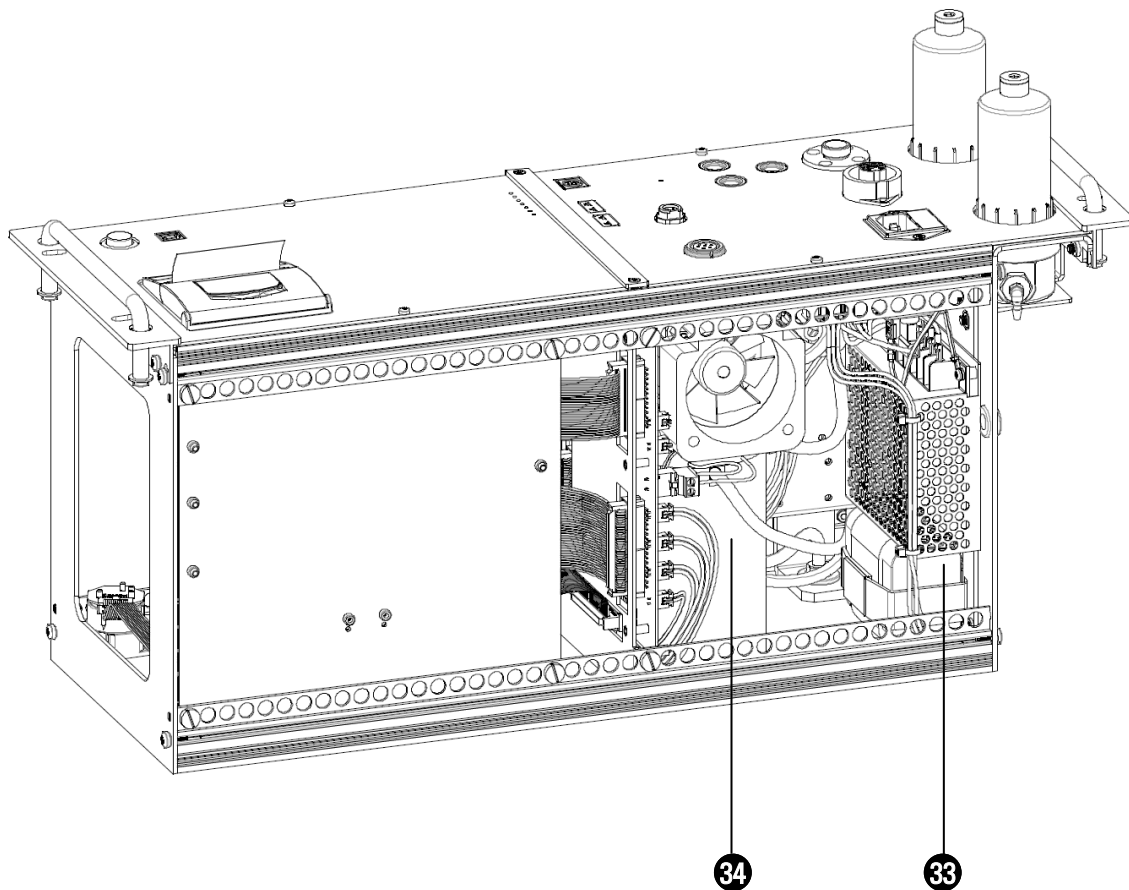

DESCRIPTION:

- 34** Condensing assembly with Peltier module (Cooler)
- 33** Battery pack

6.1 Technical features

Power supply:	90 .. 264Vac or Li-Ion battery pack with internal protection circuit, rechargeable.
Battery charger:	With power cable with IEC C14 socket.
Charging time:	8 hours for charging from 0% to 90%
Instrument operating time:	10 hours of continuous operation (without printing and Peltier module cooling assembly operation). 2 hours with cooler active.
Display:	4.3" TFT 272x480 pixels graphic color with backlight
<u>Connectivity:</u>	
Communication port:	USB connector type B.
Bluetooth®:	Class 1. Communication distance <100 meters (in open field)
Autozero:	Automatic autozero cycle with the probe inserted in the stack.
Dilution:	Widens the CO sensor measurement range up to 100,000ppm (10.00%). Programmable as simple protection of the CO sensor with the intervention level set by the user.
Gas measurement sensors:	Up to 9 configurable sensors: electrochemical, NDIR (single cell) and pellistor.
Infrared bench:	NDIR bench for 3-gases: CO, CO2, CxHy.
Programmed fuels:	15 factory pre-set plus 32 user-programmable.
Self-diagnosis:	Checks all functions and internal sensors and reports any abnormal operation.
Temperature measurement:	Two K-type thermocouple inputs with mini connector (ASTM E 1684-96) for differential temperature measurement (supply and return).
Room temperature measurement:	With internal sensor or through T2 thermocouple input and remote sensor.
Printer:	Integral thermal printer with 'easy loading paper' system and paper presence sensor.
Printer power supply:	With the analyzer batteries.
Printer autonomy:	Up to 40 reports with fully charged batteries.
Internal data memory:	16,000 complete data analyses, also storing time and name of the customer.
User Data:	8 programmable user names.
Print header:	6 lines x 24 characters user-customized.
Line filter:	Replaceable cartridge, 99% efficiency with 20um particles.
Suction pump:	0.528 gal (2.0 l/min) head at the stack up to 300 hPa.
Flow measurement:	Internal sensor.
<u>Sample treatment</u>	
<u>Cooler</u>	
Drying system:	Quick moisture condensation with cyclone
Type:	Peltier module
Cooler set-point temperature:	+41°F (+5°C)
Max temp. deviation from the set-point:	+50°F (+10°C)
Condensate drainage:	With peristaltic pump 38 ml/min
Peristaltic pump duty cycle:	30 sec On + 30 sec Off
Warm up time:	15..20 minutes
Operating temperature:	23°F to 113° F (-5 °C to +45 °C)
<u>Water trap:</u>	
Type:	Integral to the instrument
Condensate drainage:	With peristaltic pump 38 ml/min
Operating temperature:	23°F to 113° F (-5 °C to +45 °C)

Smoke:	With external hand pump; input and printing of the smoke index
Leakage test (if applicable):	Performed with AAKT04 accessory: separated report print. With automatic calculation of the piping volume.
Condensing boiler efficiency:	Automatic detection condensing boiler, with efficiency calculation and printout (>100%) based on PCI.
Ambient gas:	Measurement and separate report for ambient CO.
Draft measurement:	Performed with the internal sensor connected to port P-. 0.1 Pa resolution, 0.5 Pa accuracy.

Operating temperature:	23°F to 113° F (-5 °C to +45 °C)
Storage temperature:	-4°F to 122°F (-20 °C to +50 °C)
Humidity limit:	20% .. 80% RH
IP rating:	IP42
Air pressure:	Atmospheric
External dimensions:	19.69x14.17x7.87" (50x36x20 cm) (W x H x D) 50 x 46 x 13 cm (W x H x D) with the intermediate tray for transportation of probe and heated head .
Weight:	<p>~ 24 lbs. (~ 12 Kg) (Typical configuration: nine sensors - Cooler - IR bench - flue gas sampling probe - power supply cable - USB cable - shoulder strap - two paper rolls - USB flash drive - condensate drain tube - remote air intake tube - combustion air temperature sensor).</p> <p>~ 26 lbs. (~ 13 Kg) (Typical configuration with additional accessories: gas probe 3 mt extension - auxiliary air temperature probe - 300 mm Pitot tube - draft gauge probe).</p> <p>~ 37 lbs. (~ 16,7 Kg) (Typical configuration with additional accessories and a middle drawer containing a heated head probe with 300 mm tip and heated tube).</p>

6.2 Measurement and Accuracy Ranges

MEASUREMENT	SENSOR	RANGE	RESOLUTION	ACCURACY	
O ₂	Electrochemical sensor	0 .. 25.0% vol	0.1% vol	±0.2% vol	
CO with H ₂ compensation	Electrochemical sensor	0 .. 8000 ppm	1 ppm	±10 ppm	0 .. 200 ppm
				±5% measured value	201 .. 2000 ppm
diluted	Electrochemical sensor	10.00% vol	0.01% vol	±10% measured value	
CO Low range with H ₂ compensation	Electrochemical sensor	0 .. 1000 ppm	0.1 ppm	±2 ppm	0 .. 40.0 ppm
				±5% measured value	40.1 .. 1000.0 ppm
diluted	Electrochemical sensor	100000 ppm	10 ppm	±20% measured value	
CO Mid range	Electrochemical sensor	0 .. 20000 ppm	1 ppm	±100 ppm	0 .. 2000 ppm
				±5% measured value	2001 .. 4000 ppm
diluted	Electrochemical sensor	25.00% vol	0.01% vol	±10% measured value	
CO Hi range	Electrochemical sensor	0 .. 10.00% vol	0.01% vol	±0.02% vol or ±5% m.v.	0 .. 2.00 %
				±5% measured value	2.01 .. 10.00 %
NO	Electrochemical sensor	0 .. 5000 ppm	1 ppm	±5 ppm	0 .. 100 ppm
NO Low range	Electrochemical sensor	0 .. 500 ppm	0.1 ppm	±5% measured value	101 .. 5000 ppm
				±2 ppm	0 .. 40.0 ppm
NO _x	Calculated				
SO ₂	Electrochemical sensor	0 .. 5000 ppm	1 ppm	±5 ppm	0 .. 100 ppm
				±5% measured value	101 .. 5000 ppm
SO ₂ Low range	Electrochemical sensor	0 .. 500 ppm	0.1 ppm	±2 ppm	0 .. 40.0 ppm
				±5% measured value	40.1 .. 500.0 ppm
NO ₂	Electrochemical sensor	0 .. 1000 ppm	1 ppm	±5 ppm	0 .. 100 ppm
				±5% measured value	101 .. 1000 ppm
NO ₂ Low range	Electrochemical sensor	0 .. 500 ppm	0.1 ppm	±2 ppm	0 .. 40.0 ppm
				±5% measured value	40.1 .. 500.0 ppm
C _x H _y	Pellistor sensor	0 .. 5.00% vol	0.01% vol	±0.25% vol	
H ₂ S	Electrochemical sensor	0 .. 500 ppm	0.1 ppm	±5 ppm	0 .. 100.0 ppm
				±5% measured value	100.1 .. 500.0 ppm
NH ₃	Electrochemical sensor	0 .. 500 ppm	0.1 ppm	±10 ppm	0 .. 100.0 ppm
				±10% measured value	100.1 .. 500.0 ppm
H ₂	Electrochemical sensor	0 .. 2000 ppm	1 ppm	±10 ppm	0 .. 100.0 ppm
				±10 % measured value	100 .. 2000.0 ppm
H ₂	Sensore Elettrochimico	0 .. 40000 ppm	10 ppm	±100 ppm	0 .. 1000 ppm
				±10 % valore misurato	1001 .. 40000 ppm
CO ₂	Calculated	0 .. 99.9% vol	0.1% vol		
CO ₂	NDIR sensor	0 .. 20.0% vol	0.01% vol	±0.3% vol	0.00 .. 6.00 %
				±5% measured value	6.1 .. 20 %
CO ₂	NDIR bench	0 .. 50.0% vol	0.1% vol	±0.3% vol	0.00 .. 8.00 %
				±5% measured value	8.01 .. 40.00 %
CO	NDIR Bench	250000 ppm (0 .. 25.0% vol)	1 ppm	±50ppm	0.00 .. 2500 ppm
			10 ppm	±3% measured value	2501 .. 100000 ppm
			10 ppm	±5% measured value	100001 .. 250000 ppm
CH ₄	NDIR Bench	0 .. 1000000 ppm (100% vol.)	1 ppm	±50 ppm	0 .. 200 ppm
				±2% measured value	201 .. 50000 ppm
				±3% measured value	50001 .. 1000000 ppm
CO ₂	NDIR Bench	0 .. 50.0% vol	0.1% vol	±0.3% vol	0.00 .. 8.00 %
				±5% measured value	8.01 .. 40.00 %
				±10% measured value	40.01 .. 50.00 %
CO	NDIR Bench	250000 ppm (0 .. 25.0% vol)	1 ppm	±50ppm	0.00 .. 2500 ppm
			10 ppm	±3% measured value	2501 .. 100000 ppm
			10 ppm	±5% measured value	100001 .. 250000 ppm
HC	NDIR Bench	100000 ppm (0 .. 10.0% vol)	1 ppm	±10% measured value	0 .. 300 ppm
				±3% measured value	301 .. 4000 ppm
				±5% measured value	4001 .. 100000 ppm

7.1 Preliminary operations

Remove the instrument from its packing and check it for damage. Make sure that the content corresponds to the items ordered. If signs of tampering or damage are noticed, notify the SEITRON AMERICAS service center or distributor immediately and keep the original packing. A label applied on the instrument carries the model and the serial number. **Both these data should always be stated when requesting technical assistance, spare parts or clarification on the product or its use.**

Seitron Americas maintains an updated database for each and every instrument. Before using for the first time we recommend you charge the batteries completely.

7.2 WARNING

- Use the instrument with an ambient temperature between 23°F and 113°F (-5°C and +45°C).



IF THE INSTRUMENT HAS BEEN KEPT AT VERY LOW TEMPERATURES (BELOW OPERATING TEMPERATURES) WE SUGGEST WAITING A WHILE (1 HOUR) BEFORE SWITCHING IT ON TO HELP THE SYSTEM THERMAL BALANCE AND TO PREVENT CONDENSATE FORMING IN THE PNEUMATIC CIRCUIT.

- After use and before turning the instrument off remove the probe and let ambient clean air through it for at least 30 seconds in order to purge the pneumatic path from all residues of gas.
- Do not use the instrument if the filters are clogged or damp.
- Before placing the measuring probe back in its case after use, make sure it is has cooled down enough and there is no condensate in the tube. It might be necessary to periodically disconnect the filter and the condensate separator and blow compressed air inside the tube to empty all residues.
- Remember to have the instrument checked and calibrated once a year in order to comply with the existing standards.

7.3 Analyzer power supply



STARTING FROM 30 DAYS BEFORE THE DUE DATE OF THE INSTRUMENT CALIBRATION, THE DISPLAY WILL SHOW A MESSAGE REMINDING THE USER TO SEND THE INSTRUMENT TO THE SERVICE CENTER.

Example:



Press and hold for a few seconds

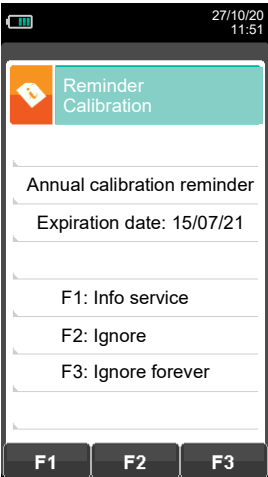

CONTEXT KEY	FUNCTION
F1	Shows all information relevant to service center.
F2	Temporarily ignores the message. At next turn-on of the instrument the reminder will be shown again.
F3	Permanently ignores the message .

The instrument contains a high-capacity Li-Ion rechargeable battery. The battery feeds the instrument, built-in printer and any other probes or remote devices that may be connected. The instrument runs for approximately 10 hours if the printer is not used or 2 hours with the Cooler active. Should the battery be too low to effect the necessary measurements, the instrument can be hooked up to the mains via the power pack provided, allowing operations (and analysis) to proceed. The battery will be recharged whilst the instrument is being used.

The battery full charging cycle takes up to 8/10 hours. This cycle is automatically ended; the end of the charging cycle is displayed with the turn-off of the red LED located on the front panel as well as with the display which will show the battery and the number '100%'.

WARNING: If the instrument is not going to be used for a long time (e.g. summer) it is advised to store it after a complete charging cycle; furthermore, perform a complete charging cycle once every 4 months.

7.3.1 Checking and replacing the batteries

The state of the internal battery can be displayed during the auto-calibration of the device and possibly later via the information menu.

In the menu, the remaining battery power is displayed.

If battery charge appears to be low, let it discharge completely and then carry out a full 100% charge cycle by connecting the instrument to the mains for 8/10 hours.

If the problem persists, replace the battery pack with a Seitron Americas original or contact the SERVICE CENTER to carry out the necessary repairs.

The average life of the battery pack is 500 charging/discharging cycles. To exploit this characteristic to the full it is advisable to always use the instrument powered by the internal batteries and to charge it only when it gives the battery flat message.



THE INSTRUMENT IS SHIPPED WITH A BATTERY LEVEL LOWER THAN 30% AS REQUIRED BY CURRENT AIR TRANSPORTATION STANDARDS. BEFORE USE PERFORM A COMPLETE CHARGING CYCLE OF 8 HOURS.

IT IS ADVISABLE TO CHARGE THE BATTERY AT AN AMBIENT TEMPERATURE RANGING BETWEEN 50° F AND 86° F (10°C AND 30°C).

The instrument can be left in stock for a period of time depending on the charging level of the battery; below there is a table showing the correlation between stock time and charging level.

BATTERY LEVEL	STOCK TIME
100%	110 days
75%	80 days
50%	45 days
25%	30 days

7.3.2 Use with power supply cord

This instrument can operate even with batteries fully discharged provided it is connected to the mains power through the IEC C14 power cord (supplied).



**THE POWER SUPPLY/BATTERY CHARGER IS SWITCHING TYPE.
THE APPLICABLE INPUT VOLTAGE RANGES BETWEEN 90Vac AND 264Vac.
INPUT FREQUENCY: 50-60Hz.
LINE PROTECTION: 2 FUSES 4A T 5x20 SIZE**

IN CASE OF PROLONGED USE CONNECT THE INSTRUMENT TO MAINS.

7.4 Connection diagram

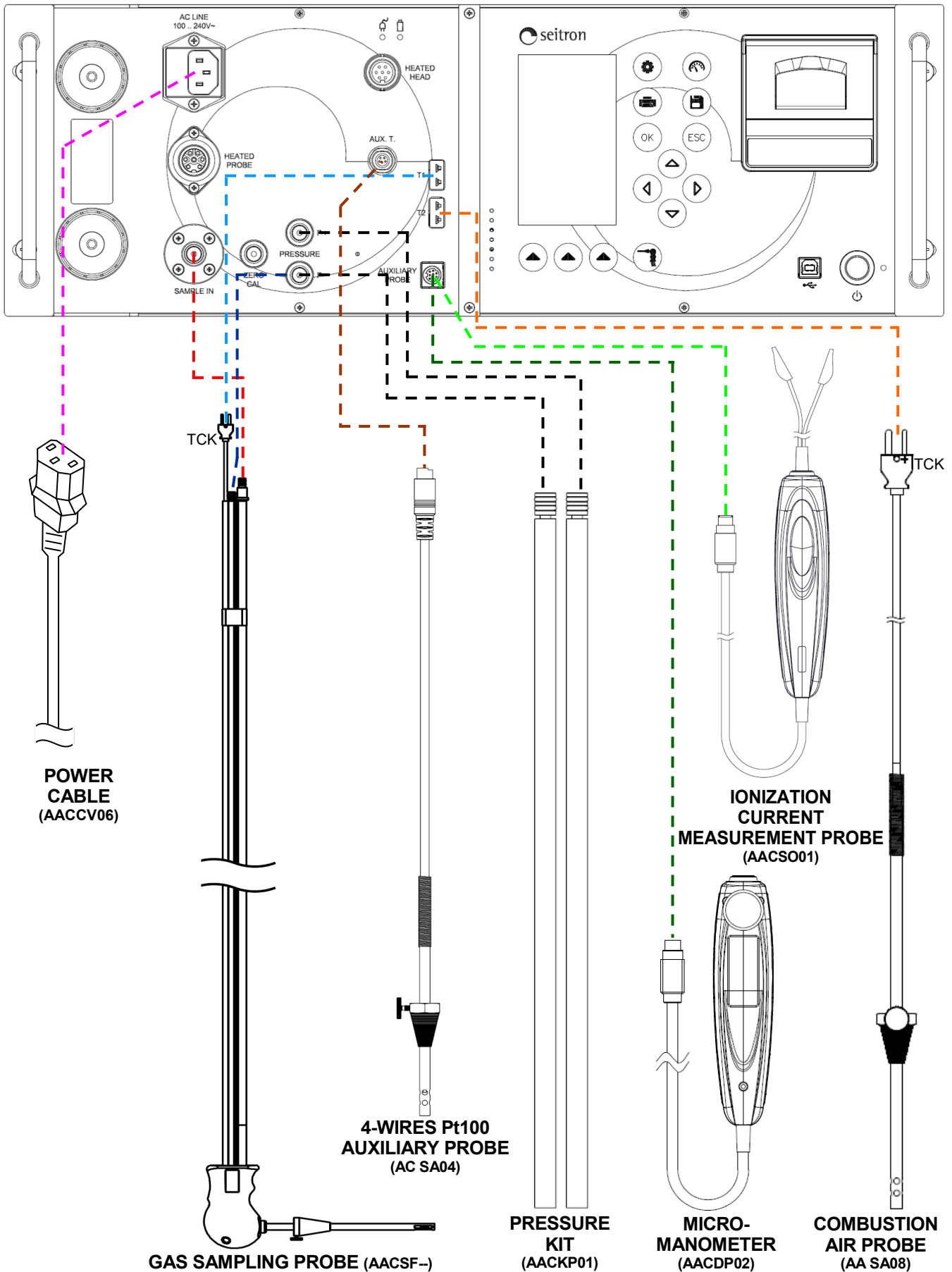

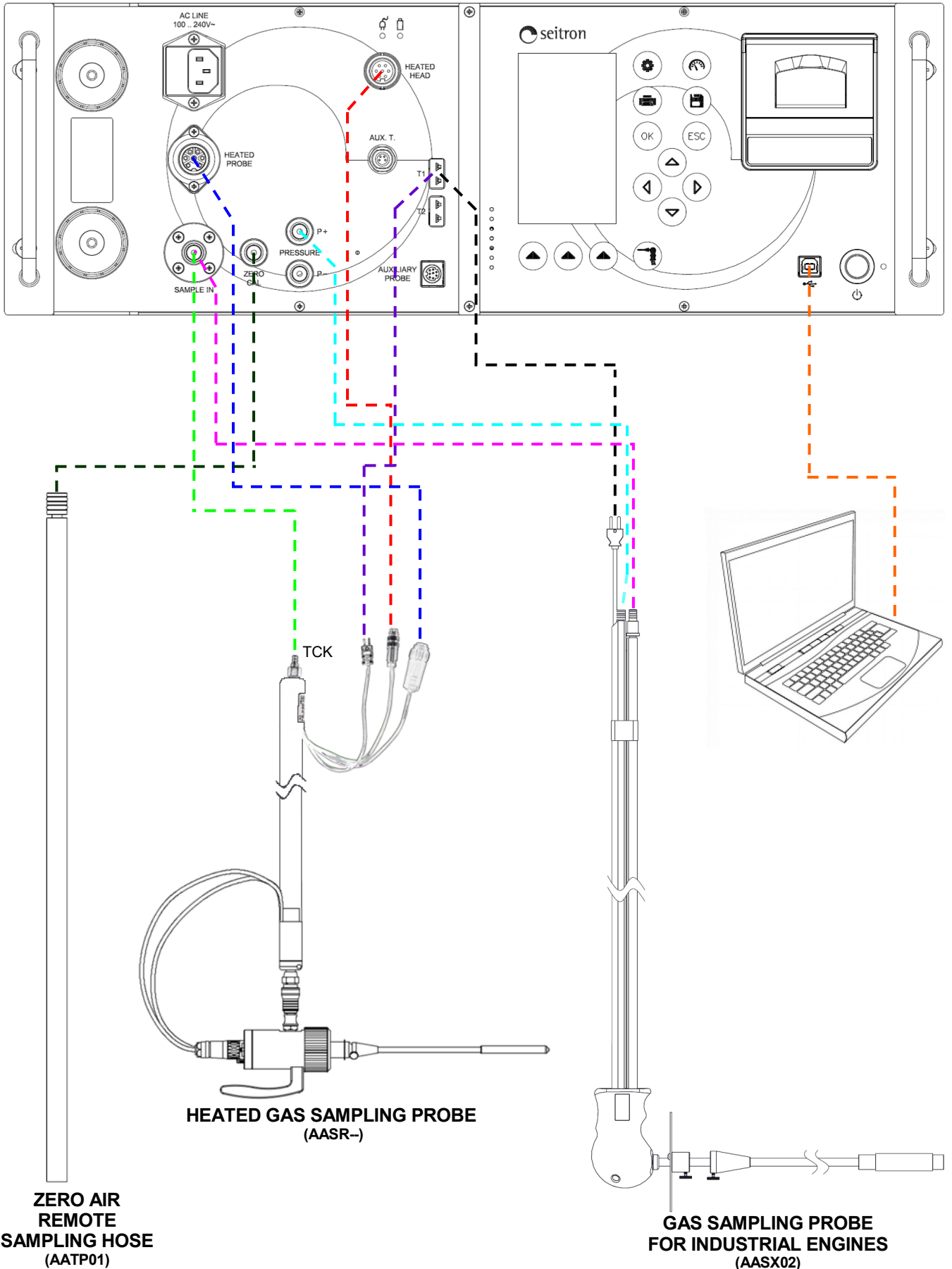

7.4.1 Heated gas sampling line (hose + head with internal AISI 316L stainless steel filter for NOx - SOx measurement)

This optional type of probe is used for applications where the measurement of NOx/SOx is required for long periods of time. This probe can be connected only to combustion analyzers equipped with integrated cooler.

A heated tube allows to keep the gas temperature above the dew point up to the integrated cooler. The Peltier cell conditioning unit allows the drying of the sample thus preventing the dilution of NO2 and SO2 into the condensate water.

The heated gas sampling line (temperature > 90°) allows to sample the gases to be analysed and carry them into the analyzer without condensation occurring on the way in order to avoid that gases like NOx and SOx dissolve in the condensate water making them not measurable by the sensors in the measuring chamber.

The gas, kept warm by the heated line, flows in the instrument passing through an efficient Peltier module cooler which reduces very quickly the gas temperature down to 5°C. This quick thermal shock creates an immediate condensation of the water in a dedicated tank; the gas, now dried, is therefore carried to the measuring chamber. The condensation water resulting from the combustion process is then extracted from the analyzer with a peristaltic pump. Applications that have very dirty fumes require a pre-filtration system right after the point where the samples are taken: for this purpose the head is equipped with a filter made of Synthesized stainless steel (1257 cartridge 95% eff. 40µm). In order to avoid condensation and therefore the dissolution of NOx and SOx in the water, the filter is heated up to a temperature higher than 90° C.

This filter can be cleaned in an ultrasonic bath or using solvents and steel brushes.

Technical features:

Tip: Material: AISI 304 stainless steel
 Diameter: 0.315" (8 mm)
 Length: 11.811" (300 mm)
 39.37" (1000mm)

Heated head:

Material: Anodised aluminium (black)
 Synthesized AISI 316L stainless steel internal filter (95% eff. with 40um particles)
 Power supply: From the instrument with round DIN 7 poles connector
 Temperature control: TcK thermocouple
 Temperature set-point: Adjustable from 194°F to 266°F (90°C to 130°C)

Heated hose:

Material: Internal measurement hose: Teflon
 External insulation: water-repellent
 Length: 9,843 ft. (3 m)
 Bending radius: 5.512" (140 mm)
 Power per meter: 65 Watt
 Power supply: From the instrument with special R24 connector
 110Vac - 230Vac automatic voltage switching
 Temperature control: NTC 10k
 Temperature set-point: Adjustable from 194°F to 266°F (90°C to 130°C)

Temperature sensor:

Type K thermocouple (Ni-NiCr) - IEC584 - class 1 19.685" (500mm)
 Type K thermocouple (Ni-NiCr) - IEC584 - class 1 39.37" (1000mm)

Available probes:

WARNING: The heated probe and heated head can only be used if the analyzer is connected to the mains, with AC voltage between 90 V and 264 V.

Connection:

Code:	Heated head with sintered filter	Type K thermocouple	12" (300mm) tip	40" (1000mm) tip	10 ft. (3 m) electrically heated hose
AASR03	✓	✓	✓		✓
AASR04	✓	✓		✓	✓

For the gas sampling heated line [see section 7.4.](#)

7.4.2 Gas probe for industrial engines

This type of probe is typically used in processes where the fumes sampled are very dirty and must be filtered out before reaching the measurement instrument. To preserve the internal system it is mandatory to filter the dust out of the gas directly on the probe tip, using an AISI 316L stainless steel filter. Condensate and fumes are then separated inside the instrument using the internal separation assembly. The probe tip is provided with a flange that acts as a heatsink to make sure that, in case of very high temperature at the stack, the handle is not damaged by a temperature that might exceed 212° .. 248° F (100° .. 120° C) - max. allowed temperature.

Technical features:

Tip:	Material:	AISI 304 stainless steel
	Diameter:	0.315" (8 mm)
	Length:	29.5276" (750mm) rigid tip + flange, insertion depth 23.622" (600mm)
Handle:	Material:	Nylon
	Color:	Black
Hose:	Material:	EPDM
	Length:	9,843 ft. (3 m)
Filter:	AISI 316L Syntherized stainless steel, washable with ultrasonic bath or with solvents and steel brush.	
Temperature sensor:	Type K thermocouple (Ni-NiCr) - IEC584 - Class 1	
Pneumatic connectors:	Male - 0.3504" (8.9 mm) diameter	
	Male - 0.315" (8.0 mm) diameter	
Temperature sensor connector:	TcK mignon size	
Operating temperature:	max. 1472°F (800°C)	

7.4.3 Probe with heated head for carbon black measuring.

This kind of probe, optionally available, is used for the carbon black measuring. The heated head (temperature >90°) avoid the formation condensation that might be deposited on the filter paper.

Technical features

Tip:	Material:	AISI 316L stainless steel
	Diameter:	0.315" (8 mm)
	Length:	11.811" (300mm) rigid
		29.5276" (750mm) rigid
Adapter for wells:	Material:	Galvanized steel
	External diameter:	0.4" .. 0.79" (10.. 20 mm)
Handle:	Material:	Nylon
	Color:	Black
Hose:	Material:	EPDM
	Length:	11.483 ft. (3.5 meters)
Temperature sensor:	Type K thermocouple (Ni-NiCr) - IEC584 - Class 1	
Pneumatic connectors:	Male - 0.3504" (8.9 mm) diameter pressure connections	
	Male - 0.315" (8 mm) diameter gas input connection	
Electric signals connectors:	for pressure measuring and heater power.	
Operating temperature: AA SX04:	max. 1112°F (600°C) immersion depth 3.3" (160mm)	
AA SX05:	max. 1472°F (800°C) immersion depth 19.685" (500mm)	



USING THE PROBE WITH HEATED HEAD FOR THE MEASUREMENT OF THE CARBON BLACK REDUCES THE INSTRUMENT'S BATTERY AUTONOMY.

Connection:

For the wiring connection of the fumes heating sampling line [see section 12.3.4](#).

7.4.4 Combustion air temperature sensor

This probe is used to measure the temperature of the combustion air.

Use: to be used when the sampling site of the combustion air is located in a different area than the boiler room or the heating plant; when the combustion air sampling site is located in a different place than the boiler room, the temperature of the combustion air can be very different compared with the temperature of the air in the boiler room, generating a less accurate efficiency calculation.

Technical features:

Tip:	Material:	AISI 304 stainless steel
	Diameter:	0.236" (6mm)

Adapter for thermowells:	Length:	7.874" (200mm) rigid tip
	Material:	AISI 303 stainless steel
	External diameter:	0.295" .. 0.67" (7,5 .. 17 mm)
Temperature sensor:	Sensing element:	Type K thermocouple (Ni-NiCr) - IEC584 - Class 1
	Cable length:	6.562 ft. (2 m)
Connector:	TcK mignon size	
Measurement range:	-13°F .. 257°F (-25.0°C .. +125.0°C)	

Connection

As shown in [section 7.4](#) the probe must be connected to the instrument as follows:

- ◆ The polarized male connector of the thermocouple must be connected to the **T2** plug. The improper insertion of the same is not possible thanks to the different length of the tips.

7.4.5 Tc-K temperature measurement probe

Using the same input as for the Tc-K thermocouple 'T1' (i.e. the one used for gas temperature), it is possible to measure the supply and return water temperature. If this temperature is taken on the pipe itself, it is suggested to use contact probes with diameter matching as close as possible the pipe diameter.

Connection

As shown in [section 7.4](#) the probe must be connected to the device as follows:

- ◆ The polarized male connector of the thermocouple must be connected to the '**T1**' plug. The improper insertion of the same is not possible thanks to the different lengths of the tips.

7.4.6 Auxiliary temperature measurement probe

Input for 4-wires Pt100 temperature probe.

Connection

As shown in [section 7.4](#) the probe must be connected to the device as follows:

- ◆ The 4-poles M8 type connector must be connected to the '**AUX T**' plug on the analyzer.

7.4.7 Ionization current measurement probe

This special probe has been developed to extend the functions of the analyzer to check the quality of the combustion flame.

This probe allows the combustion analyzer to measure the current that is created within the combustion chamber between the chamber metal body and the measurement electrode.

Connection

As shown in [section 7.4](#) the probe must be connected to the device as follows:

- ◆ The 8-poles mini-DIN type connector must be connected to the '**AUXILIARY PROBE**' serial port on the analyzer.

7.4.8 Draft measurement gauge

This device has been designed to extend the functions of the combustion analyzer to the draft measurement. It enables the combustion analyzer to measure the draft and generally the pressure with an higher accuracy and resolution than the internal sensor of the instrument.

Connection

As shown on the section 7.4 the probe shall be connected to the instrument as follows:

- ◆ The draft gauge is provided with a female connector (ø 0.354" / 9mm) of the same type of the one for the pressure inputs on the combustion analyzer. Thanks to this connector the draft gauge can be connected directly to the shorter male connector (ø 0.354" / 9mm) of the flue gas sampling probe supplied.
- ◆ The 8-pole MiniDin connector shall be connected to the "**AUXILIARY PROBE**" serial port of the analyzer.

7.4.9 Pressure Test Kit

Two types of pressure measurement kit are available:

- 1st Kit includes two 3.28 ft. (1mt) hoses and two ø 0.354" (9mm) fittings; to be used for the differential pressure measurement.
- 2nd Kit includes one 3.28 ft. (1mt) hose and one ø 0.354" (9mm) fitting for pressure measurement.

Connection

As shown on [section 7.4](#) the kits shall be connected to the instrument as follows:

- 1st hose connector shall be connected to the P+ connector, while the other hose connector shall be connected to the analyzer P- connector.
- 2nd The hose connector shall be connected to the analyzer P+ or P- connector.

7.4.10 Burner pressure verification probe

This probe must be used to measure the burner pressure of the gas-powered boiler so it can be regulated in real time. It is made of a silicone tube, 0.315"x0.16" (8x4mm) and 3.28 ft. (1 meter) long, complete with connector for connecting to the analyzer.

7.4.11 Hose for remote zero air suction

It consists of one 2mt tube and one \varnothing 9mm male fitting to be used to move the clean air suction point to perform the instrument autozeroing.

Connection

As shown on [section 7.4](#) the tube shall be connected to the instrument as follows:

- ◆ The tube fitting shall be connected to the analyzer " **ZERO CAL** " pneumatic connector.

8.0 POWER ON - OFF

8.1 Starting the device

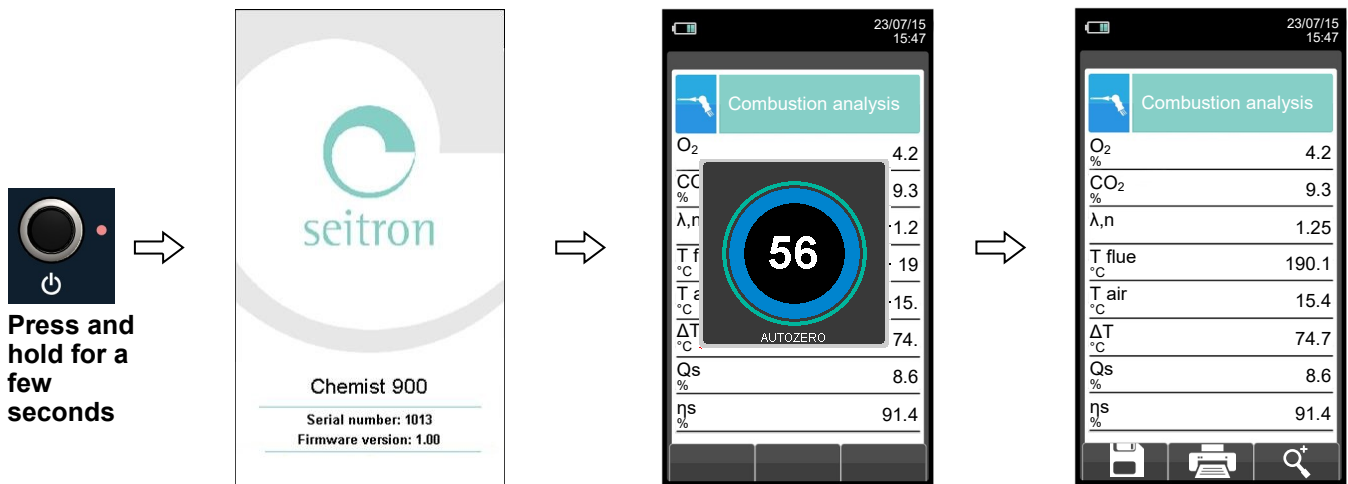

During autozero, you can only use the menus that do not require autozero.

ERROR
 Autozero failed.
 Repeat?
 F1: Autozero
 F2: Analysis
 F3: Diagnostic

This error message is displayed if the autozero of the device is not successfully completed.

KEY	FUNCTION
	Activate the context keys shown on the display.
	Goes through the measurements available.
	Activates the context key located in the left side of the display.
	Returns to the previous screen.

CONTEXT KEY	FUNCTION
	Repeats autozero (is shown in the case of an error).
	The device will suspend autozero and display the screen "Combustion Analysis"; it is possible to carry out the analysis of combustion (displayed in the case of an error).
	The device displays the screen "Sensor Diagnostics" (displayed in the case of an error).
	Save analysis.
	Print the test paper print-out according to the settings.
	Zoom. By pressing this interactive key repeatedly, the device displays the following sequence: AAA → AAA → AAA → AAA

9.1 Configuration menu

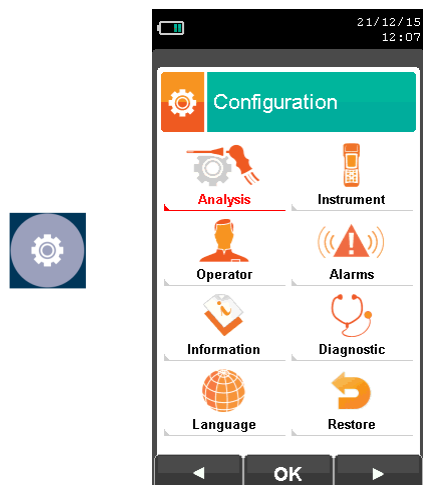

KEY	FUNCTION
	Activate the context keys shown on the display.
	Returns to the previous screen.

CONTEXT KEY	FUNCTION
	Selects the available parameters.
	Enters in the selected parameter setting.
	Selects the available parameters.

PARAMETER	DESCRIPTION
Analysis	Through this menu the user can configure the available parameters for a proper combustion analysis. SEE SECTION 9.2.
Instrument	This menu is used to configure the instrument's reference parameters. SEE SECTION 9.3.
Operator	In this sub menu you can enter or change the name of the operator that will carry out the analysis. Up to 8 lines are available. Also, you can select the name of the operator that will carry out the analysis and this will be printed on the analysis report. SEE SECTION 9.4.
Alarm	This submenu allows the user to set and memorize 10 alarms, defining the monitored parameter for each (gas, pressure, Ta, Tf), the alarm threshold and relevant measurement unit and whether it is a low or high-level alarm. Low-level alarms are triggered when the reading drops below the defined threshold, whereas high-level alarms are triggered when the reading rises above the defined threshold. SEE SECTION 9.5.
Information	This menu provides information regarding instrument status. SEE SECTION 9.6.
Diagnostic	The user, with this menu, can check any anomalies of the device. SEE SECTION 9.7.
Language	Set the desired language for the various menus and the test paper print-out. SEE SECTION 9.13.
Restore	Restore factory settings. SEE SECTION 9.14.

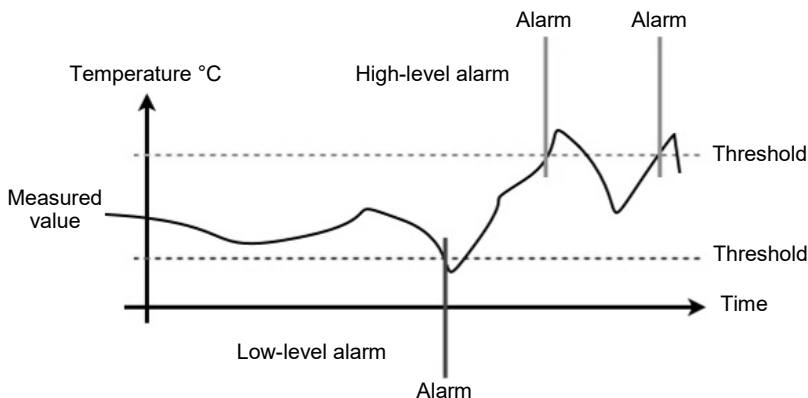

9.2 Configuration → Analysis

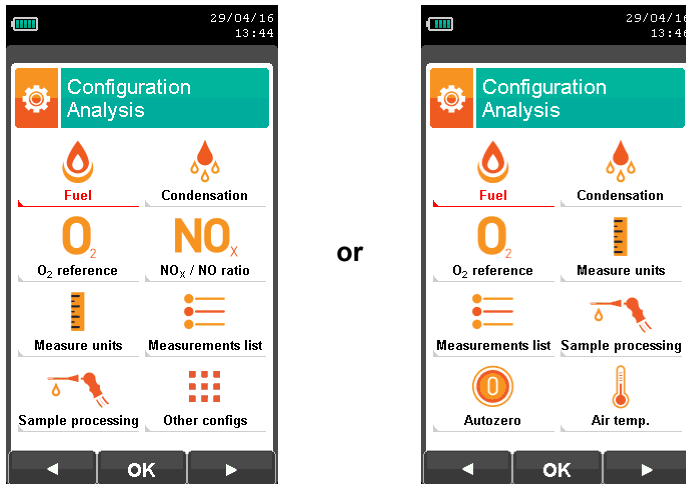
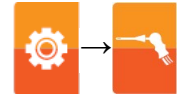







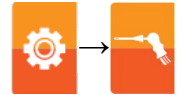

KEY	FUNCTION
	Activate the context keys shown on the display.
	Returns to the previous screen.

CONTEXT KEY	FUNCTION
	Selects the available parameters.
	Enters in the selected parameter setting.
	Selects the available parameters.

PARAMETER	DESCRIPTION
 Fuel	Lets the user select the type of fuel to be used during analysis. Fuel selection can be done either from this menu or during the analysis itself. By selecting the sub menu Fuel coefficients the user can view the characteristics of the fuels used in the calculation of performance. SEE SECTION 9.2.1.
 Condensation	The burner efficiency figure when condensation takes place is influenced by atmospheric pressure and humidity of the combustion air. As the atmospheric pressure is hardly precisely known, the operator is asked to enter a related parameter, i.e. the altitude of the place above the sea level, from which the pressure is then derived once the dependency from atmospheric conditions is neglected. In calculations the value of 101325 Pa is assumed as atmospheric pressure at sea level. Further the air relative humidity input is allowed, being this calculated at the combustion air temperature as measured from the instrument; in case this value is unknown the operator is recommended to enter 50% for this value. SEE SECTION 9.2.2.
 O ₂ reference	In this mode the user can set the oxygen percentage level to which pollutant emission values detected during analysis will be referenced. SEE SECTION 9.2.3.
 NO _x /NO ratio	NO _x /NO: all the nitrogen oxides which are present in the flue emissions (Nitrogen oxide = NO, Nitrogen dioxide = NO ₂); total nitrogen oxides = NO _x (NO + NO ₂). In the combustion processes, it is found out that the NO ₂ percentage contained in the gas is not far from very low values (3% or above); hence it is possible to obtain the NO _x value by a simple calculation without using a direct measurement with a further NO ₂ sensor. The NO ₂ percentage value contained in the gas can be however set at a value other than 3% (default value). This menu is only available when the NO ₂ sensor is not installed. SEE SECTION 9.2.4.



PARAMETER	DESCRIPTION
 <p>Measure units</p>	<p>Through this submenu the user can modify the measurement units for all the analysis parameters, depending on how they are used. SEE SECTION 9.2.5.</p>
 <p>Measures list</p>	<p>In this sub menu the user can see the list of measurements that the device can perform. With the interactive keys, the user can add, delete or move a selected measurement. SEE SECTION 9.2.6.</p>
 <p>Sample processing</p>	<p>In this mode the user can activate/deactivate the whole operating system of the heated probe. The user can also set the required temperature of the heated tube and the heating head. The activation of the Cooler system is indicated on the display with the icon "  ".</p> <div style="border: 1px solid black; padding: 10px; margin: 10px 0;">  <p>WHEN THE INSTRUMENT COOLER SYSTEM IS TURNED ON, THE BATTERY LIFE IS REDUCED DOWN TO 2 HOURS.</p> </div> <p>SEE SECTION 9.2.7.</p>
 <p>Other config.</p>	<p>If the ' NOx/NO Ratio ' parameter is provided, the instrument shall display this icon which represents the ' Autozero ' and ' Air Temperature ' menus described below.</p>
 <p>Autozero</p>	<p>In this sub menu the user can change the length of the autozero cycle of the analyzer and start it manually. SEE SECTION 9.2.8.</p>
 <p>Air temp.</p>	<p>This submenu allows to acquire or enter manually the combustion air temperature. SEE SECTION 9.2.9.</p>

9.2.1 Configuration → Analysis → Fuel

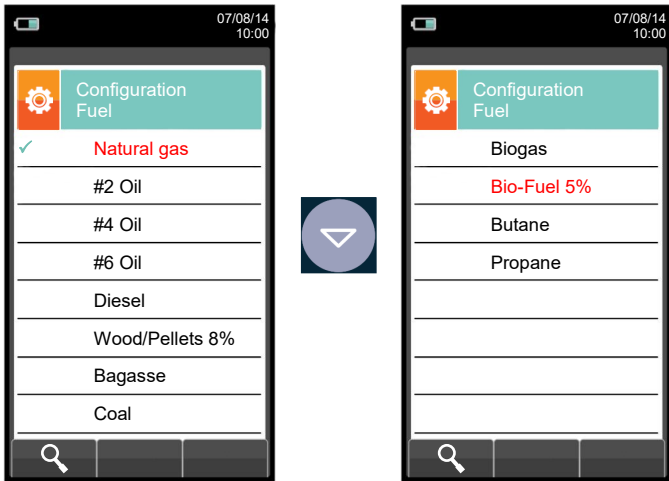
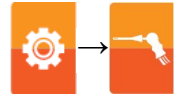

KEY	FUNCTION
	Activate the context keys shown on the display.
	The arrows select each line displayed.
	Confirms the choice of fuel to be used during the analysis.
	Returns to the previous screen.

CONTEXT KEY	FUNCTION
	Shows the details of the selected fuel (see example below).
	Returns to the previous screen.

Example:

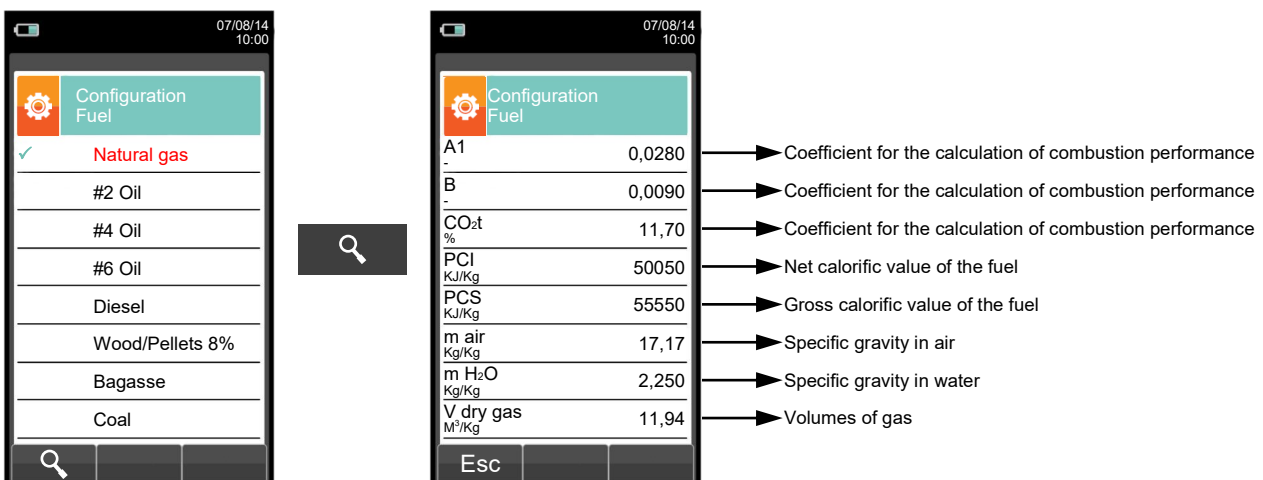

9.2.2 Configuration → Analysis → Condensation

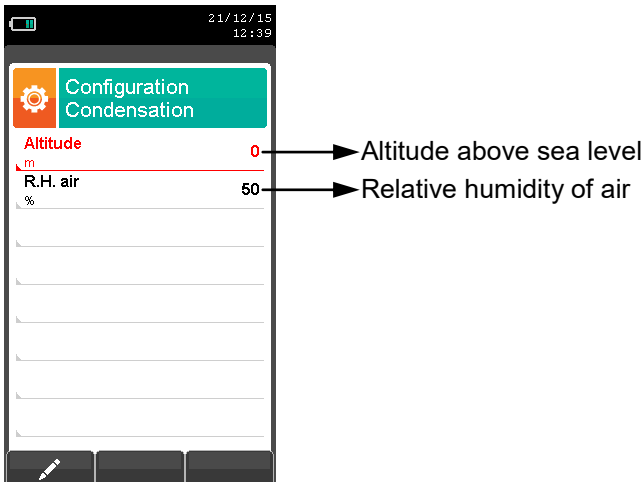
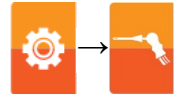

KEY	FUNCTION
	Activate the context keys shown on the display.
	The arrows select each line displayed (the selected line is red). In edit mode, it scrolls through the suggested values.
	Enters the modify mode for the selected parameter, then confirms the modification.
	When pressed in modify mode cancels the selection made, otherwise returns to the previous screen.

CONTEXT KEY	FUNCTION
	Enters the modification mode for the selected parameter.
	Confirms the modification.

Example:

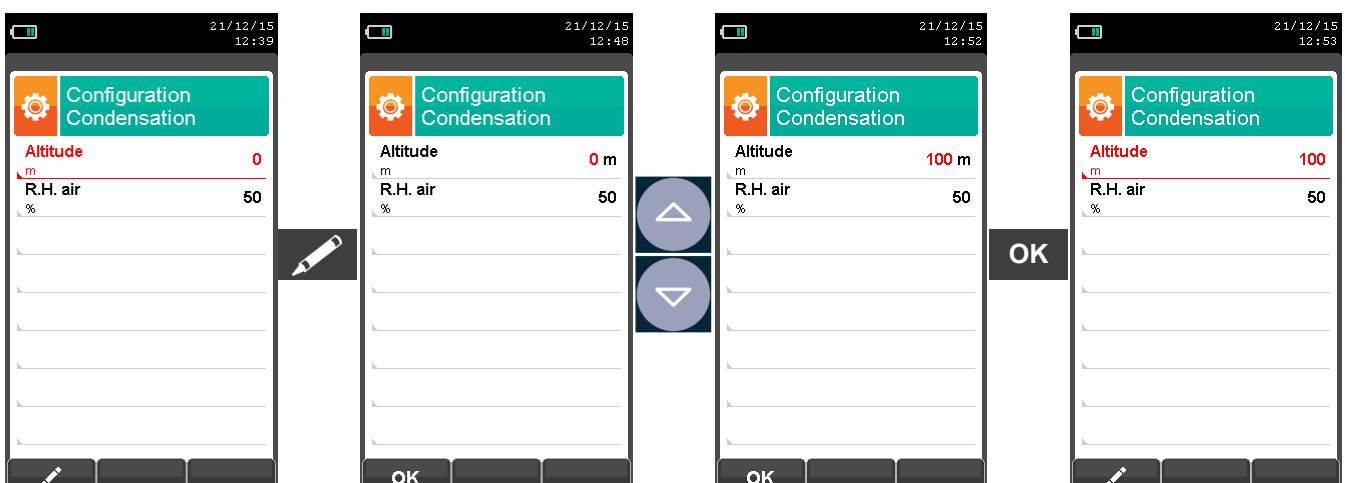

9.2.3 Configuration → Analysis → Reference O₂

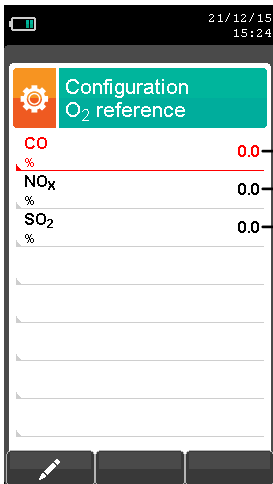
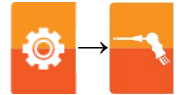

- Oxygen Reference Level for the CO measurement.
- Oxygen Reference Level for the NO_x measurement.
- Oxygen Reference Level for the SO₂ measurement.

KEY	FUNCTION
	Activate the context keys shown on the display.
	Keys '▲' and '▼' select any line shown on the display (the selected line is displayed in red). When in modify mode, sets the desired value.
	Enters the modify mode for the selected parameter, then confirms the modification.
	When pressed in modify mode cancels the selection made, otherwise returns to the previous screen.

CONTEXT KEY	FUNCTION
	Enters the modify menu for the selected parameter.
	Confirms the modification.

Example:

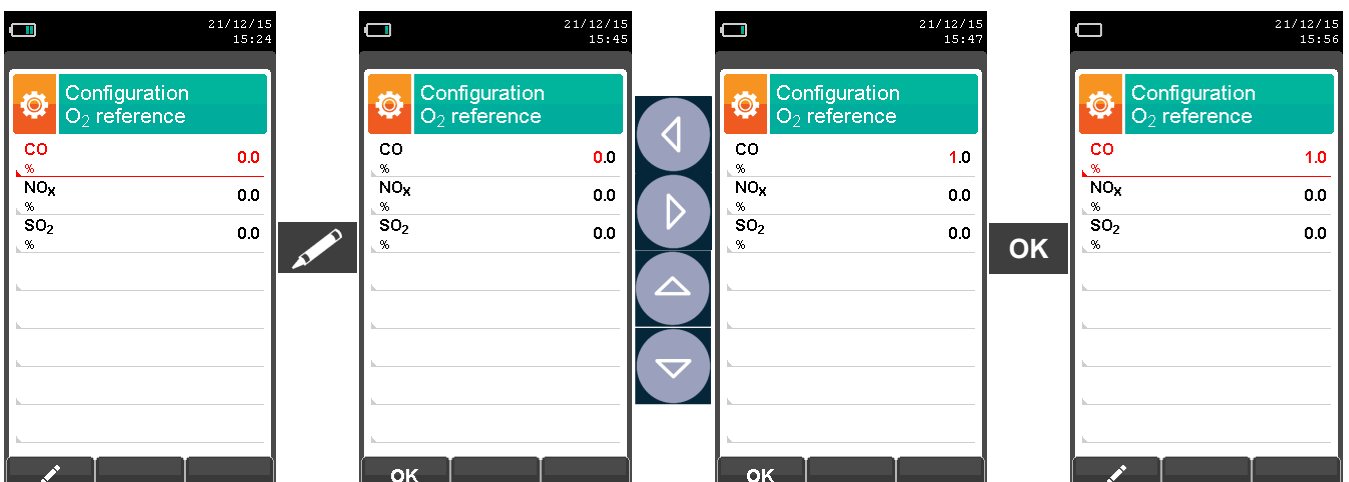

9.2.4 Configuration → Analysis → NO_x/NO ratio

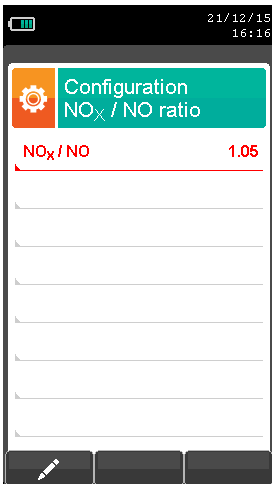
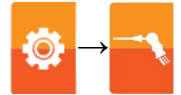

KEY	FUNCTION
	Activate the context keys shown on the display.
	When in modify mode, sets the desired value.
	Enters edit mode of the selected element and then confirms the change.
	When pressed in modify mode cancels the selection made, otherwise returns to the previous screen.

CONTEXT KEY	FUNCTION
	Enters edit mode.
	Confirms the modification.

Example:

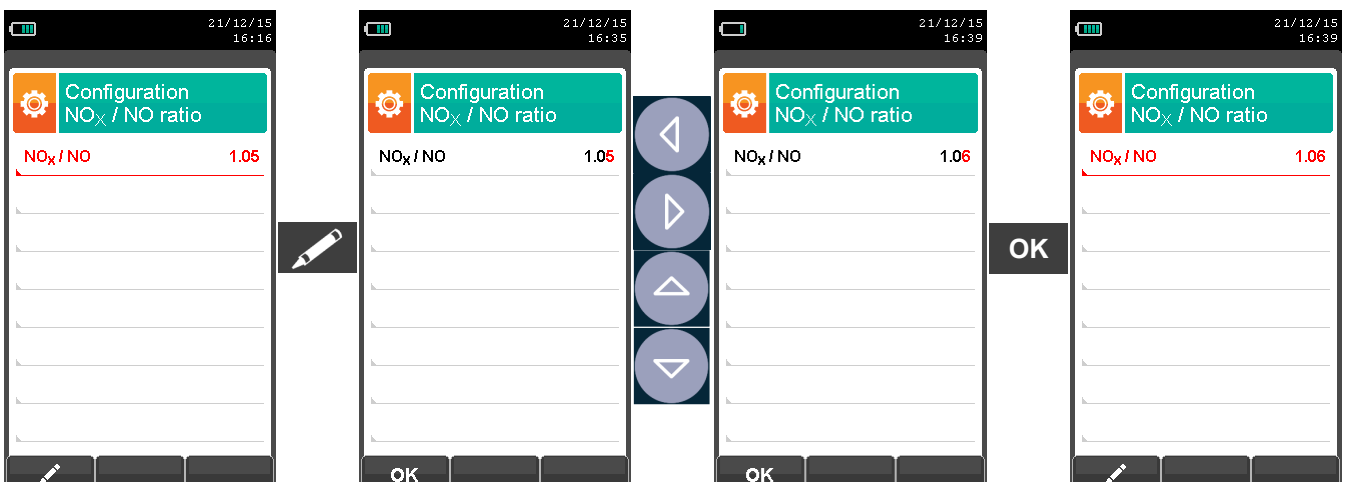

9.2.5 Configuration → Analysis → Measurement units

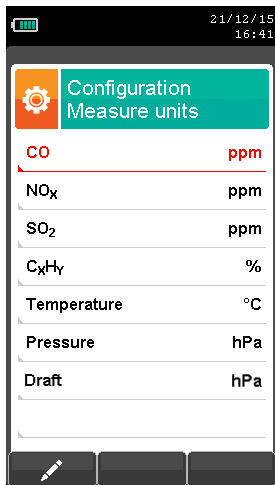
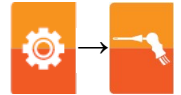

- Measurement unit can be set as: ppm - mg/m³ - mg/kWh - g/GJ - g/m³ - g/kWh - % - ng/J
- Measurement unit can be set as: ppm - mg/m³ - mg/kWh - g/GJ - g/m³ - g/kWh - % - ng/J
- Measurement unit can be set as: ppm - mg/m³ - mg/kWh - g/GJ - g/m³ - g/kWh - % - ng/J
- Measurement unit can be set as: ppm - mg/m³ - mg/kWh - g/GJ - g/m³ - g/kWh - % - ng/J
- Measurement unit can be set as: °C - °F
- Measurement unit can be set as: hPa - Pa - mbar - mmH₂O - mmHg - inH₂O - psi
- Measurement unit can be set as: hPa - Pa - mbar - mmH₂O - mmHg - inH₂O - psi

The measurement units mg/m³ and g/m³ are referred to Normal pressure and temperature conditions, P = 101325 Pa and T = 0 °C.

KEY	FUNCTION
	Activate the context keys shown on the display.
	Keys '▲' and '▼' select any line shown on the display (the selected line is displayed in red). When in modify mode, sets the desired value.
	Enters edit mode of the selected element and then confirms the change.
	When pressed in modify mode cancels the selection made, otherwise returns to the previous screen.

CONTEXT KEY	FUNCTION
	Enters the modification mode for the selected parameter.
	Confirms the modification.

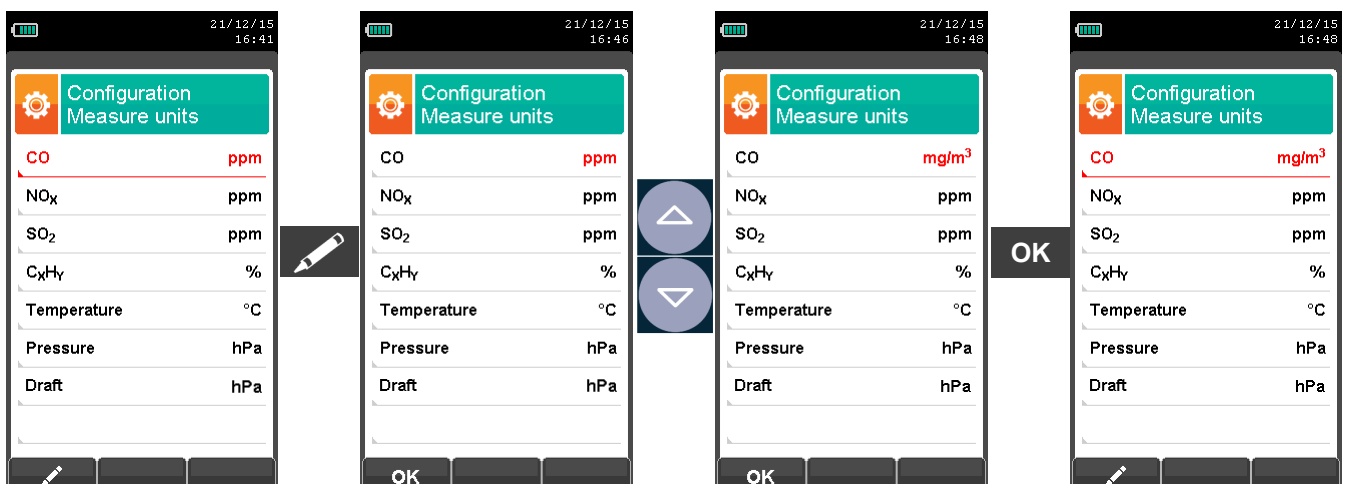

Example:



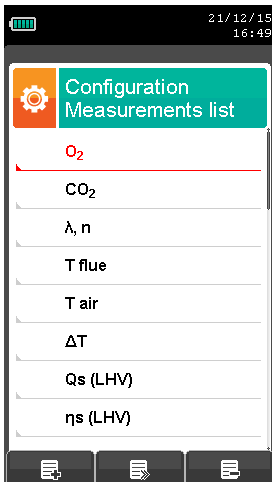
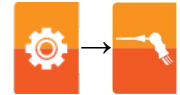







9.2.6 Configuration → Analysis → Measures list



 FOR FURTHER DETAILS SEE THE [ANNEX D](#)

KEY	FUNCTION
	Activate the context keys shown on the display.
	Select each line displayed (the line selected is red). In edit mode, it sets the desired value.
	When pressed in modify mode cancels the selection made, otherwise returns to the previous screen.

CONTEXT KEY	FUNCTION
	Adds a line to the list of available measurements.
	Activates the movement of a measurement from its current position.
	Deletes a measurement from the list of available measurements.
	After the activation of the function '  ': It scrolls through the available measurements. After the activation of the function '  ': It moves the element from its current position.
	Confirms the operation.
	Cancels the operation.

 OTHER THAN THE MEASUREMENT LIST ABOVE, IT IS POSSIBLE TO VISUALIZE THE MEASURE OF THE DETECTED GAS ALSO IN PPM, DEPENDING ON THE KIND OF MEASUREMENT CELL IN THE INSTRUMENT. IF IT IS NECESSARY TO MEASURE THE VALUE OF GAS WITH TWO DIFFERENT MEASUREMENT UNITS, SELECT IN THE MEASUREMENTS LIST THE DESIRED GAS IN PPM AND CHANGE THE MEASUREMENT UNIT FOR THE SAME GAS IN THE "CONFIGURATION->ANALYSIS->MEASUREMENT UNIT" SCREEN. NOW THE INSTRUMENT ACQUIRES THE MEASURE WITH TWO DIFFERENT UNITS (PPM AND THE ONE PREVIOUSLY SET)

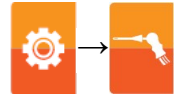

Example:

1. Add a measurement to the list - example

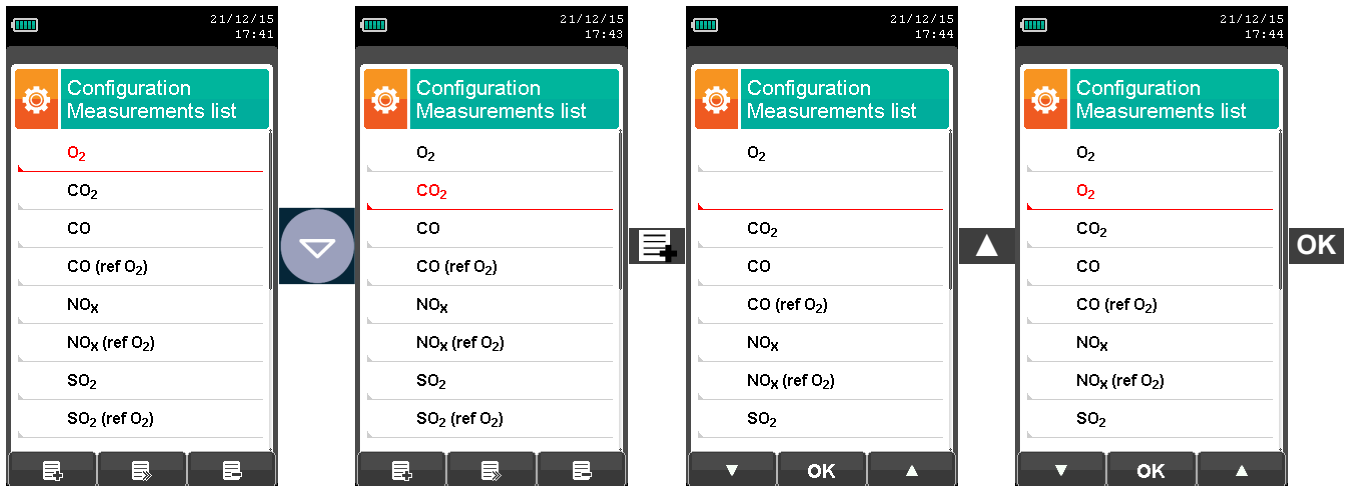

2. Change the position of a measurement - example

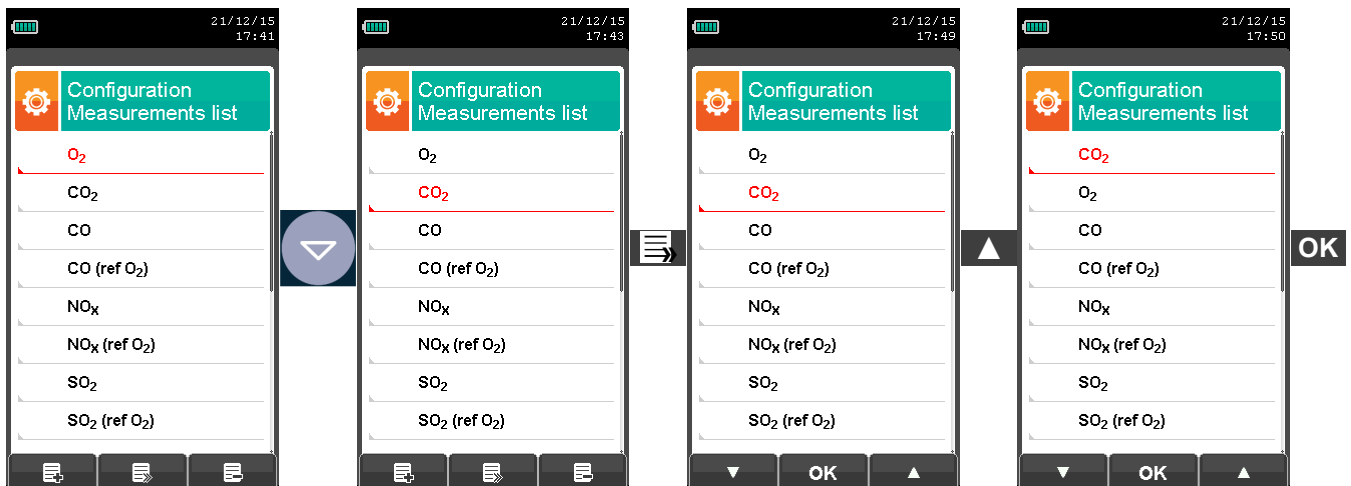

3. Delete a measurement from the list - example

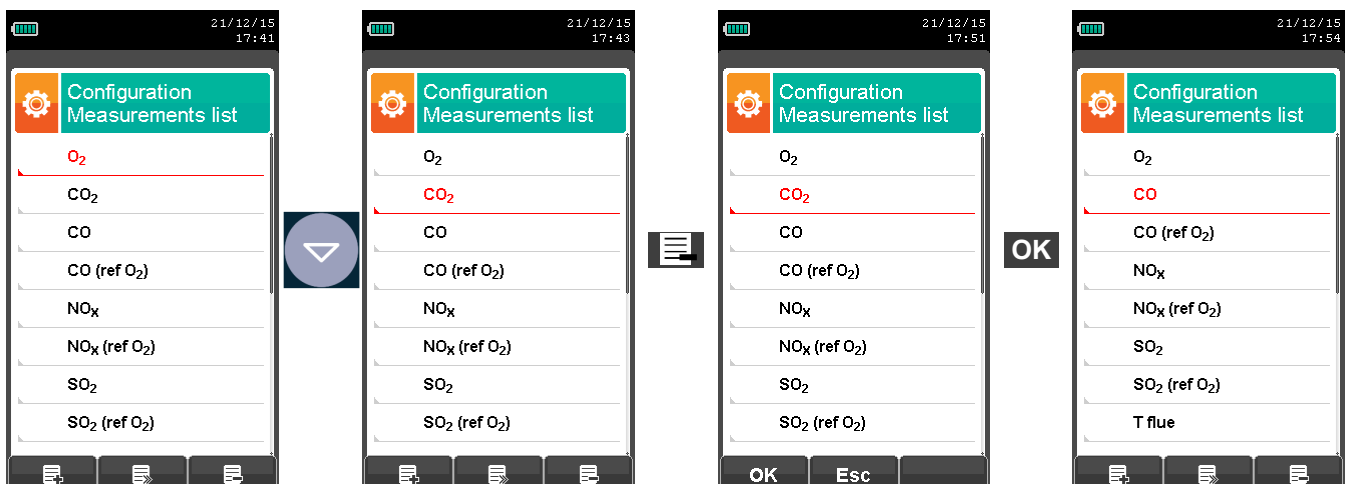

9.2.7 Configuration → Analysis → Sample processing

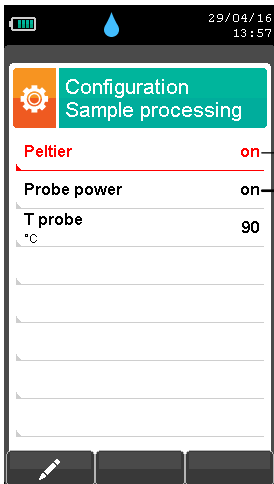
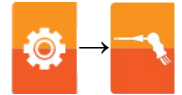

- Available settings: on (Cooler is switched on) or off (Cooler is switched off).
- Available settings: on (Heated Tube and Probe are switched on) or off (Heated Tube and Probe are switched off).
- Heated tube and heated head probe temperature: 194°F .. 266°F (90°C .. 130°C).

WARNING

The activation of the Cooler system is indicated on the display with the icon “”

KEY	FUNCTION
	Activate the context keys shown on the display.
	The arrows '▲' and '▼' select each line displayed (the selected line is highlighted in red). When in modify mode, sets the desired value.
	Enters the modify mode, then confirms the modification.
	When pressed in modify mode, it cancels the selection made or returns to the previous screen.

CONTEXT KEY	FUNCTION
	Enters the modification mode for the selected parameter.
	Confirms the modification.

Example:

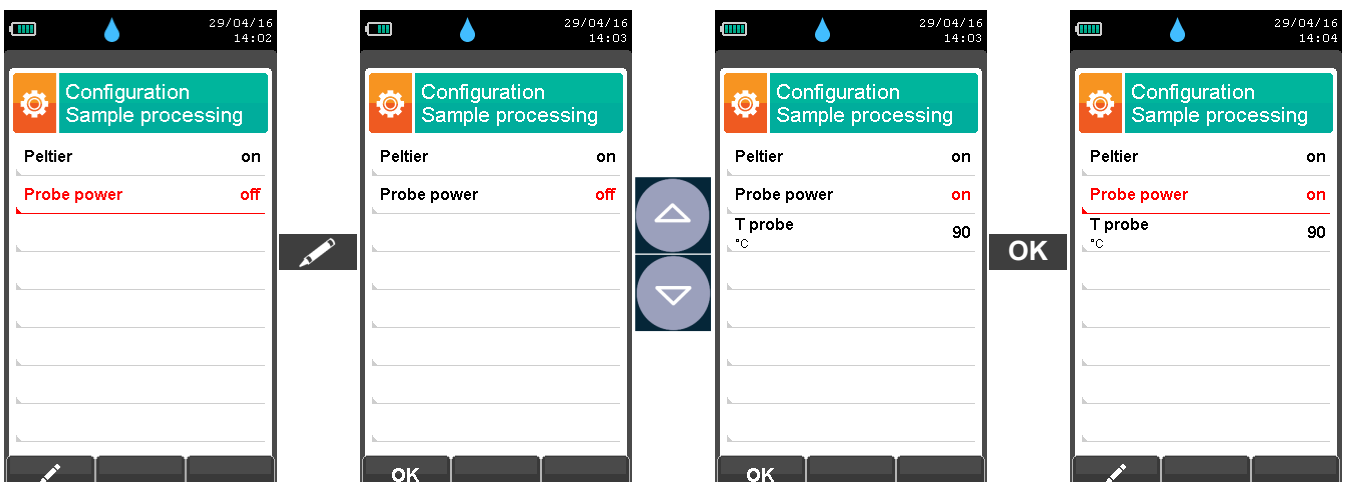

9.2.8 Configuration → Analysis → Autozero

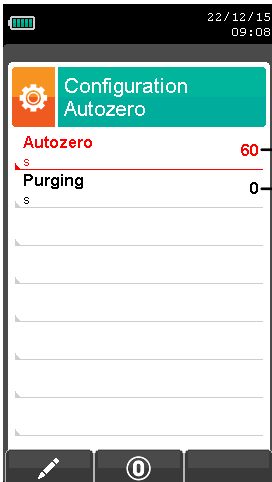
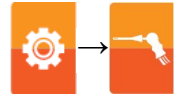

→ Duration of autozero, expressed in seconds.
 → Duration of the cleaning cycle, expressed in seconds.

KEY	FUNCTION
	Activate the context keys shown on the display.
	The arrows '▲' and '▼' select each line displayed (the selected line is highlighted in red). When in modify mode, sets the desired value.
	Enters edit mode of the selected element and then confirms the change.
	When pressed in modify mode cancels the selection made, otherwise returns to the previous screen.

CONTEXT KEY	FUNCTION
	Enters the modify menu for the selected parameter.
	Confirms the modification.
	Starts autozero for the selected duration.

Example:

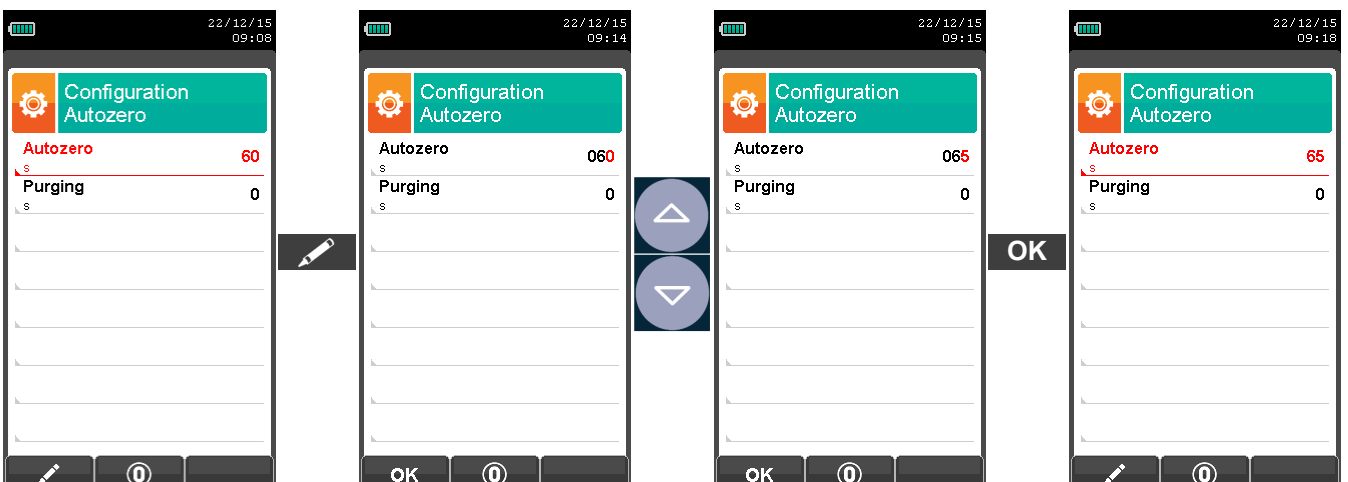

9.2.9 Configuration → Analysis → Air temperature

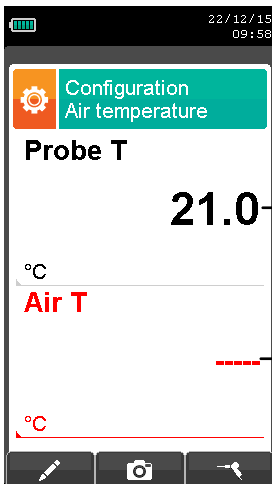
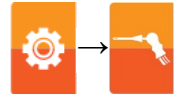

21.0 → Combustion air temperature detected by the Tc-K probe connected to the T1 connector. If the probe is not connected, a sensor error is displayed.

----- → Combustion air temperature entered manually or detected by the Tc-K probe.

KEY	FUNCTION
	Activate the context keys shown on the display.
	When in modify mode, sets the desired value.
	Activates the context key located in the left side of the display.
	Returns to the previous screen without saving the changes made.

CONTEXT KEY	FUNCTION
	Enters the modify mode for the "Air T" parameter: the user can set the required air temperature value to be used during the combustion analysis.
	Saves the value acquired or entered in the "Air T" parameter.
	Acquires the temperature value detected by the flue gas sampling probe. This value is shown on the "Air T" parameter.
	Confirms the modification .

Example:

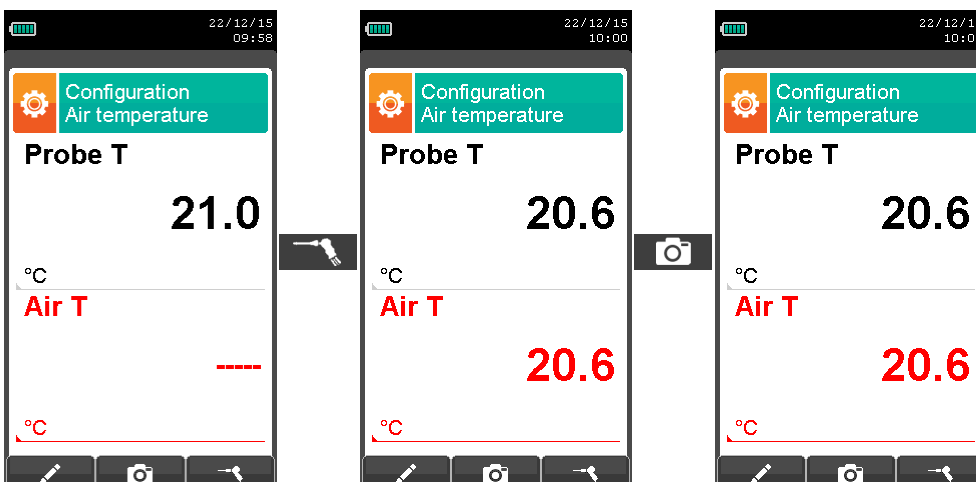

9.3 Configuration→Instrument

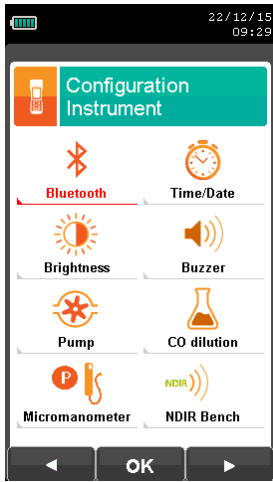



KEY	FUNCTION
	Activate the context keys shown on the display.
	Returns to the previous screen.

CONTEXT KEY	FUNCTION
	Selects the available parameters.
	Enters in the selected parameter setting.
	Selects the available parameters.

PARAMETER	DESCRIPTION
 Bluetooth	Through this sub menu the user can turn on and off the instrument Bluetooth [®] wireless communication with a PC or PDA. SEE SECTION 9.3.1.
 Time/Date	This allows the current time and date to be set. The user can select the date and hour format either in EU (European) or USA (American) mode. SEE SECTION 9.3.2.
 Brightness	The display brightness may be increased or decreased by acting on cursor keys. This operation may be performed even when the introductory screen is active. SEE SECTION 9.3.3.
 Buzzer	The instrument is fitted with an internal buzzer which is mainly used to signal any faults and/or alarms. In this submenu you can enable or disable the buzzer or enable it and mute the key tones. SEE SECTION 9.3.4.
 Pump	In this submenu you can access the settings of the fumes suction pump and the peristaltic pump. SEE SECTION 9.3.5.
 CO dilution	The CO sensor is protected by a pump which, in case of need, can inject clean air in the gas path in order to dilute the gas concentration measured by the sensor. This function can be either triggered by the overcoming of a CO concentration threshold which can be set by the user or, in case it is known that the flue gases contain high CO concentration, kept enabled any time, independently of CO concentration. The activation of the dilution pump is shown on the display by the icon " ". <div style="border: 1px solid black; padding: 5px; margin-top: 10px;"> THE MAIN PURPOSE CO AUTO-DILUTION FEATURE IS FOR PROTECTION OF THE CO SENSOR AGAINST OVER-SATURATION. THE ACCURACY AND RESOLUTION OF THE CO MEASUREMENT IS NOT AS GREAT WHEN THIS FEATURE IS ENABLED.</div> SEE SECTION 9.3.8.



PARAMETER	DESCRIPTION
 Micromanometer	Allows to configure the micromanometer input (optional) as P+ or P- port. In case P- is selected, the sign of pressure is inverted. SEE SECTION 9.3.9.
 NDIR bench	Allows to enable (on) or disable (off) the NDIR bench. SEE SECTION 9.3.10.

9.3.1 Configuration→Instrument→Bluetooth®

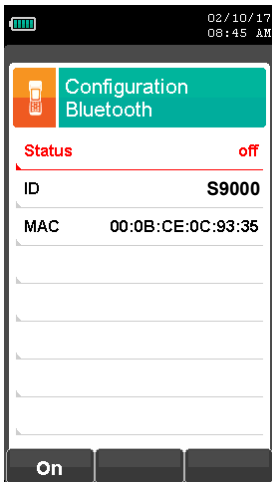

→ Bluetooth enabling / disabling
 → Instrument name
 → MAC address detected

KEY	FUNCTION
	Activate the context keys shown on the display.
	Also activates the context key shown on the display.
	Returns to the previous screen.

CONTEXT KEY	FUNCTION
	Turns on Bluetooth® communication.
	Turns off Bluetooth® communication.

9.3.2 Configuration→Instrument→Time/Date

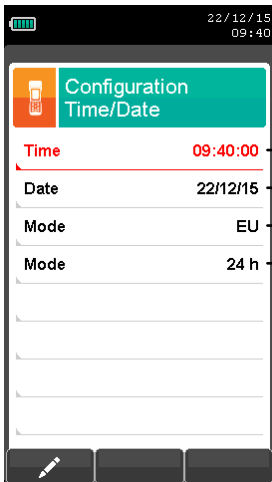

- Time, in the chosen format
- Date, in the chosen format
- Date format: EU (Europe) or USA (America)
- Time format: 24h or 12h

KEY	FUNCTION
	Activate the context keys shown on the display.
	The arrows '▲' and '▼' select each line displayed (the selected line is highlighted in red). When in modify mode, sets the desired value.
	Enters edit mode of the selected element and then confirms the change.
	When pressed in modify mode cancels the selection made, otherwise returns to the previous screen.

CONTEXT KEY	FUNCTION
	Enters edit mode of the selected parameter.
	Confirms the modification.

9.3.3 Configuration→Instrument→Brightness

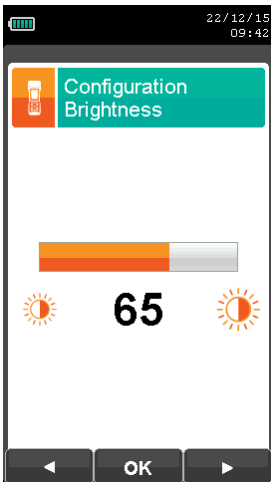

KEY	FUNCTION
	Activate the context keys shown on the display.
	Increases or decreases the brightness of the display.
	Confirms the modification.
	When pressed in modify mode cancels the selection made, otherwise returns to the previous screen.

CONTEXT KEY	FUNCTION
	Decreases the brightness of the display.
	Confirms the setting.
	Increases the brightness of the display.

9.3.4 Configuration→Instrument→Buzzer

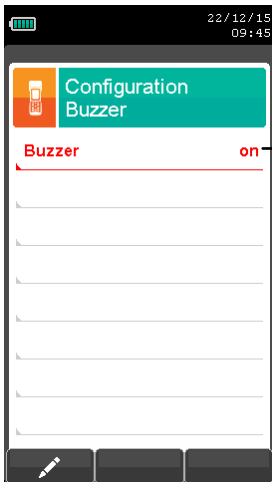

- Available settings:
- on:** the buzzer is enabled (key tones and signalling of faults/alarms are enabled).
 - limited:** the buzzer is enabled in a limited mode (key tones are disabled, while signalling of faults/alarms is enabled).
 - off:** the buzzer is disabled.

KEY	FUNCTION
	Activate the context keys shown on the display.
	When in modify mode, sets the desired value.
	Enters edit mode of the selected element and then confirms the change.
	When pressed in modify mode cancels the selection made, otherwise returns to the previous screen.

CONTEXT KEY	FUNCTION
	Enters edit mode of the selected parameter.
	Confirms the modification.

9.3.5 Configuration→Instrument→Pumps

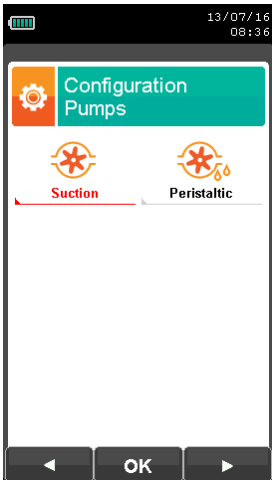

KEY	FUNCTION
	Activate the context keys shown on the display.
	Back to the previous screen.

CONTEXT KEY	FUNCTION
	Select the available parameters.
	Enter the selected parameter.
	Select the available parameters.

PARAMETER	DESCRIPTION
<p>Suction</p>	<p>In this submenu you can turn on and off the gas suction pump. Also, if the pump is on, it is possible to view and modify the pump flow measured in liters per minute. It will not be possible to turn off the pump if the auto-zero cycle is currently running.</p> <p>SEE SECTION 9.3.6.</p>
<p>Peristaltic</p>	<p>In this submenu it is possible to set the off interval of the peristaltic pump.</p> <p>SEE SECTION 9.3.7.</p>

9.3.6 Configuration → Instrument → Pumps → Suction

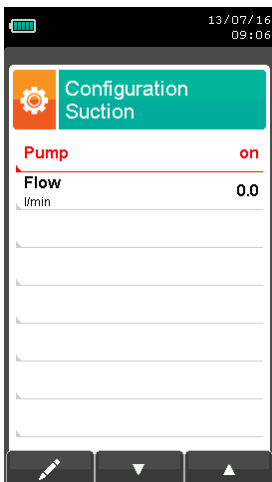

- Available options: on (pump switched on) or off (pump switched off).
- Display of the pump's flow, expressed in Litres per minute. The data is modifiable in the range (1.4 .. 2.2).





KEY	FUNCTION
	Activate the context keys shown on the display.
	When in modify mode, sets the desired value.
	Enters edit mode of the selected element and then confirms the change.
	When pressed in modify mode cancels the selection made, otherwise returns to the previous screen.

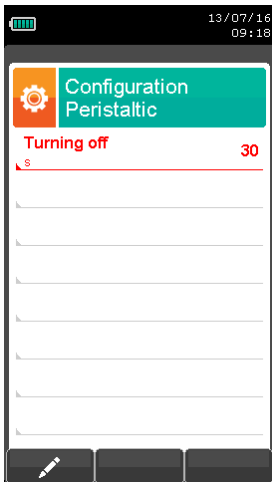

CONTEXT KEY	FUNCTION
	Activates edit mode: it is possible to turn on / off the fumes suction pump.
	Confirm the option selected.
	Holding down the key, decreases the pump flow.
	Holding down the key, increases the pump flow.

9.3.7 Configuration→Instrument→Pumps→Peristaltic



→ Power-off time configurable in the range 30 .. 3600 seconds.

KEY	FUNCTION
	Activate the context keys shown on the display.
	When in modify mode, sets the desired value.
	Enters edit mode of the selected element and then confirms the change.
	When pressed in modify mode cancels the selection made, otherwise returns to the previous screen.



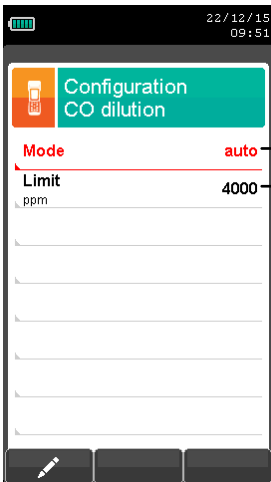

CONTEXT KEY	FUNCTION
	Edit mode: it is possible to set the range of time while the peristaltic pump remains disabled.
	Confirms the modification.



9.3.8 Configuration→Instrument→CO dilution



Available settings: auto, on or off.
 Threshold that activates the dilution pump (available only if the "Mode" parameter is set to "auto").

WARNING
 The activation of the dilution pump is shown on the display by the icon " ".

KEY	FUNCTION
	Activate the context keys shown on the display.
	Select each line displayed (the line selected is red). In edit mode, it sets the desired value.
	Enters edit mode of the selected element and then confirms the change.
	When pressed in modify mode cancels the selection made, otherwise returns to the previous screen.

CONTEXT KEY	FUNCTION
	Enters edit mode of the selected parameter.
	Confirms the modification.

9.3.9 Configuration → Instrument → Micromanometer

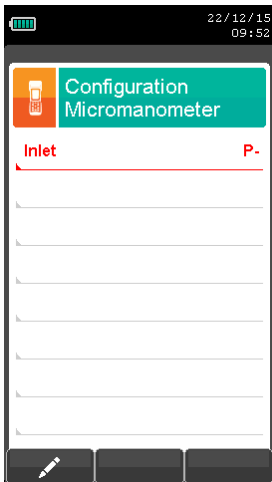

→ Sets the input used for the test: P+ or P-

KEY	FUNCTION
	Activate the context keys shown on the display.
	In edit mode, it sets the desired input.
	Enters edit mode of the selected element and then confirms the change.
	When pressed in modify mode cancels the selection made, otherwise returns to the previous screen.

CONTEXT KEY	FUNCTION
	Enters edit mode of the selected parameter.
	Confirms the modification.

9.3.10 Configuration → Instrument → NDIR bench

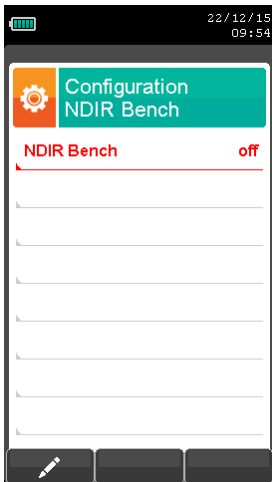

Available settings: **on**: NDIR bench is enabled - **off**: NDIR bench is disabled.

WARNING:
In order to make effective the new configuration, please turn the instrument off and then on again.

KEY	FUNCTION
	Activate the context keys shown on the display.
	In edit mode, it sets the desired input.
	Enters edit mode of the selected element and then confirms the change.
	When pressed in modify mode cancels the selection made, otherwise returns to the previous screen.

CONTEXT KEY	FUNCTION
	Enters edit mode of the selected parameter.
	Confirms the modification.

9.4 Configuration → Operator

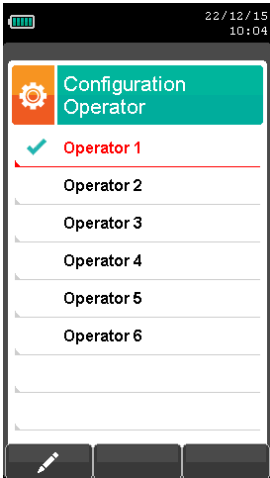
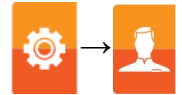

KEY	FUNCTION
	Activate the context keys shown on the display.
	In "edit text": Moves the cursor on the box corresponding to the letter or number required to form the word.
	In "Operator Configuration": Scrolls through the available operators.
	In "edit text": Confirms text input. In "Operator Configuration": selects the operator who will carry out the analysis; the operator is highlighted with the symbol "✓".
	Returns to the previous screen. In "edit text" mode returns to the previous screen without saving the changes.

CONTEXT KEY	FUNCTION
	Enters edit mode of the selected line: it is possible to enter the name of the operator (24 characters available).
	Confirms the selected letter or digit.
	Cancel the letter or digit before the cursor.
	Cycles through uppercase, lowercase, symbols and special characters.

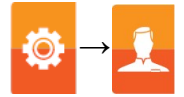

Example:

1. Edit text

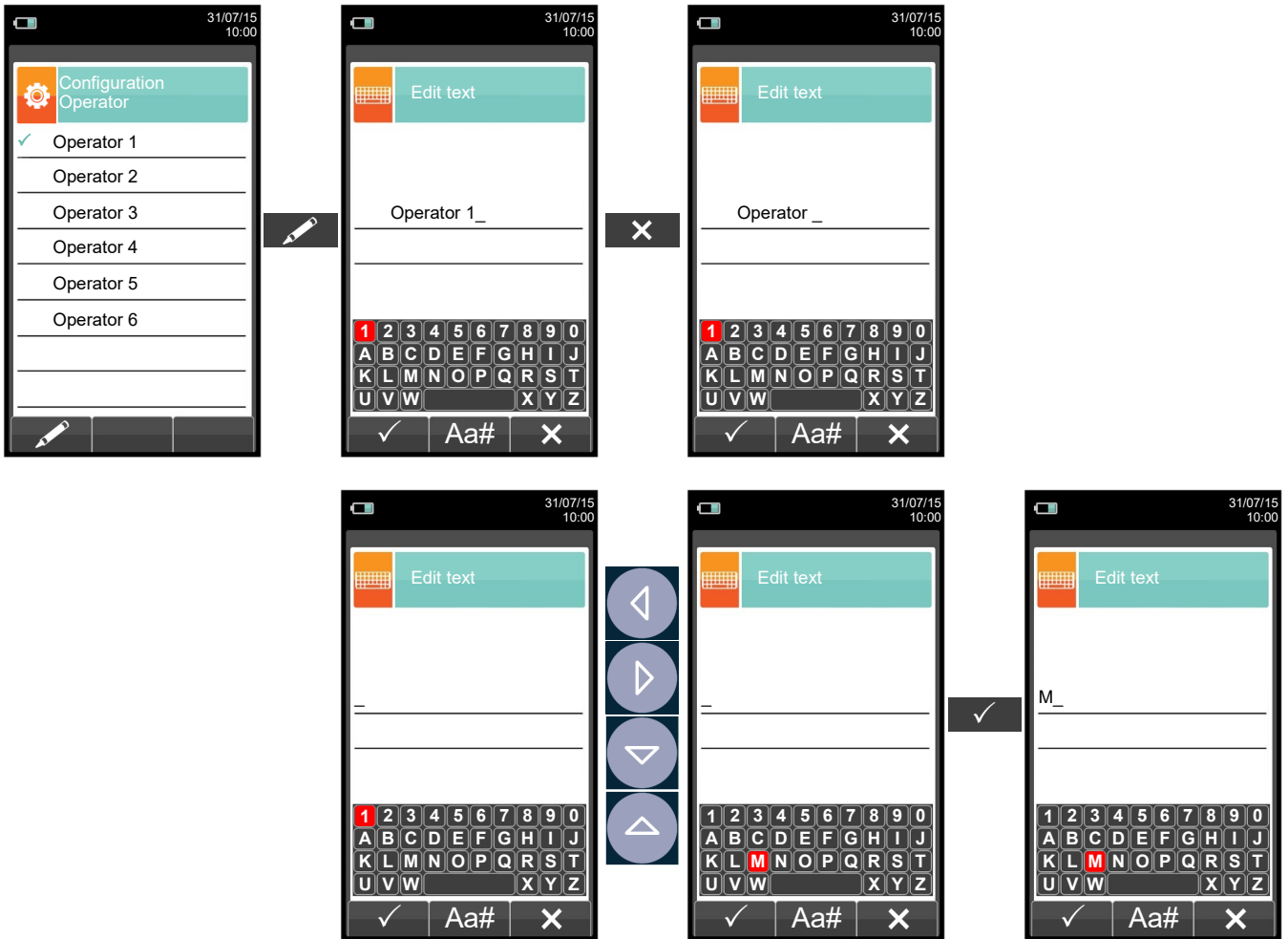

2. Select the operator who will carry out the analysis

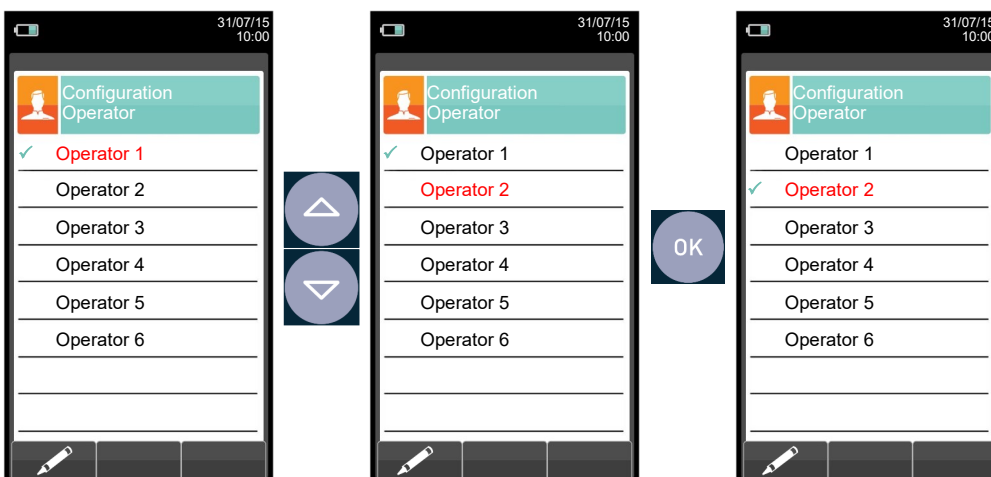

9.5 Configuration → Alarms

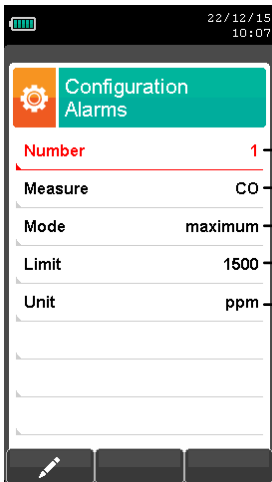

- Number of the alarm set
- Monitored parameter: O₂ - CO - NO - NO₂ - P diff - Plow - P ext - T1 - T2
- Type of alarm set: maximum - minimum - off
- Threshold setting for the alarm: ±999999.999
- Measurement unit for the threshold set: ppm, mg/m³, mg/kWh, g/GJ, g/m³, g/kWh, %, ng/J

KEY	FUNCTION
	Activate the context keys shown on the display.
	Keys '▲' and '▼' select any line shown on the display (the selected line is displayed in red). When in modify mode, sets the desired value.
	Enters the modify mode for the selected parameter, then confirms the modification.
	When pressed in modify mode cancels the selection made, otherwise returns to the previous screen.

CONTEXT KEY	FUNCTION
	Enters the modify menu for the selected parameter.
	Confirms the modification.

9.6 Configuration → Information

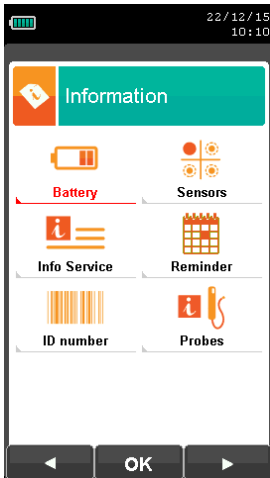
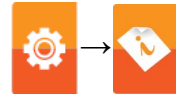



KEY	FUNCTION
	Activate the context keys shown on the display.
	Returns to the previous screen.

CONTEXT KEY	FUNCTION
	Selects the available parameters.
	Enters in the selected parameter setting.
	Selects the available parameters.

PARAMETER	DESCRIPTION
 Battery	Displays the current battery power status in percentage from 0 to 100%, both in text and graphically. SEE SECTION 9.6.1.
 Sensors	Allows to check which sensors are installed on the instrument, and in which position they are installed. The instrument automatically detects whether a sensor has been either added or removed. The screen page allows whether to accept the new configuration or ignore the change performed. SEE SECTION 9.6.2.
 Infoservice	This submenu contains details regarding the nearest Service Center to be contacted in the event of instrument fault or ordinary maintenance. The instrument model, serial number and firmware version are also displayed, thus allowing for a quick product identification. SEE SECTION 9.6.3.
 Reminder	In this menu the user can see the reminder of the instrument annual calibration that was entered in the factory or in the service center. The menu is protected by the following password: " 2908 ". SEE SECTION 9.6.4.
 ID number	Not available.
 Probes	Displays useful information about the probe connected to the serial cable shown in 15 in section 5.0 'Description of Components' . SEE SECTION 9.6.5.

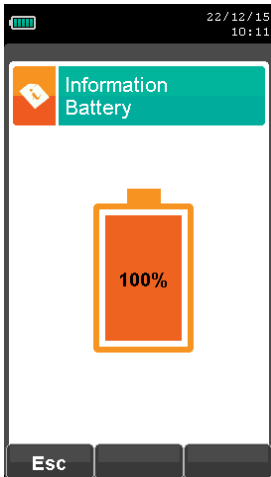
9.6.1 Configuration→Information→Battery



KEY	FUNCTION
	Activate the context keys shown on the display.
	Returns to the previous screen.

CONTEXT KEY	FUNCTION
	Returns to the previous screen.

9.6.2 Configuration→Information→Sensors

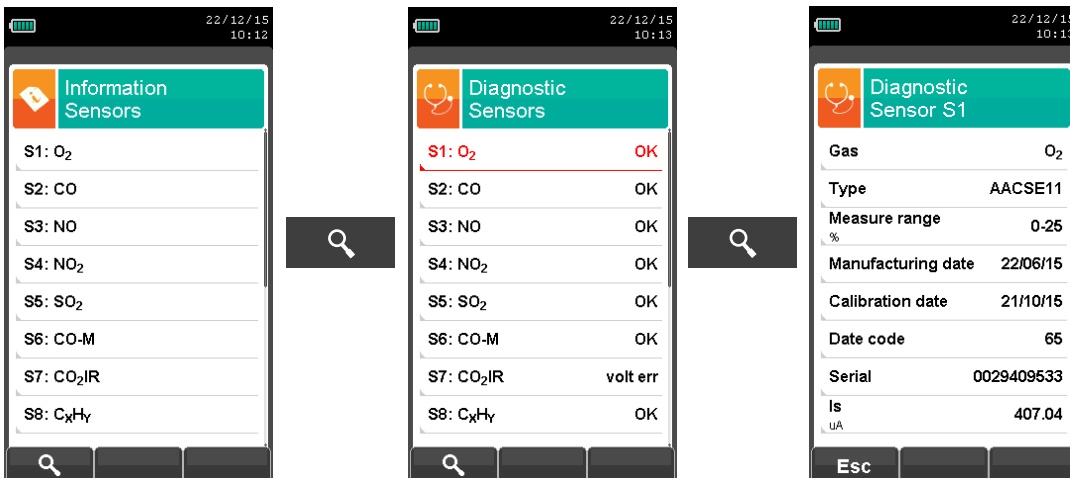
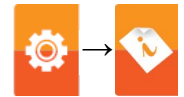

For further information see [section 9.7](#).

KEY	FUNCTION
	Activate the context keys shown on the display.
	Returns to the previous screen.

CONTEXT KEY	FUNCTION
	Displays the details of the main features of the sensors installed.
	Returns to the previous screen.

This screen displays, for each position, the following messages:

MESSAGE	DESCRIPTION
OK	Sensor configured OK (normal operation).
-----	Sensor is not communicating or has been removed. For sensors in positions 10, 11 and 12: NDIR bench is not installed or has been disabled .
<i>The name of the detected gas is flashing</i>	New sensor detected.
Pos err	Detected sensor in wrong position.
Volt err	Detected voltage is out of the normal operating range; repeat the autozero.
Curr err	Detected current is out of the normal operating range; repeat the autozero.
Err autozero	NDIR bench autozero failed.

Error messages displayed:

MESSAGE	DESCRIPTION
Cal err	Calibration error.
Data err	Sensor not recognized.
No cal	Sensor not calibrated.

9.6.3 Configuration → Information → InfoService

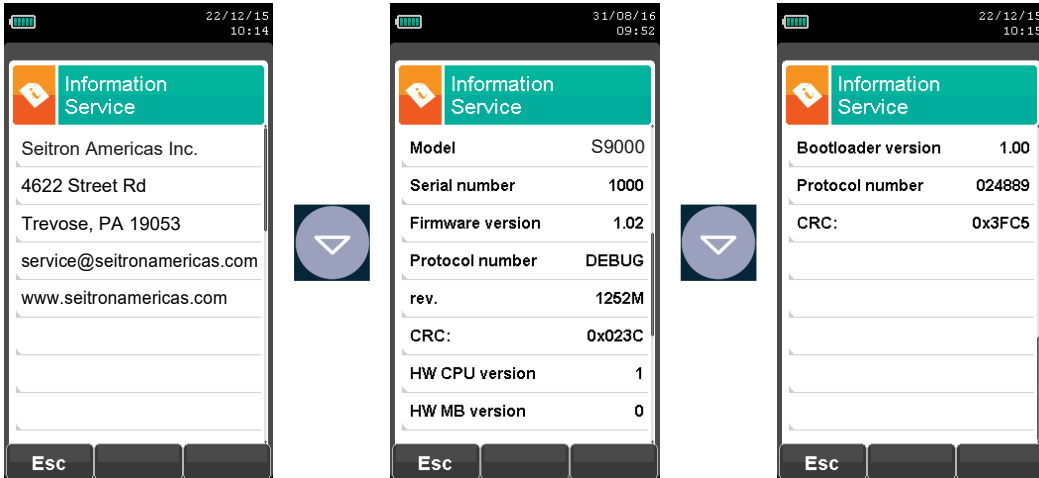

KEY	FUNCTION
	Activate the context keys shown on the display.
	Returns to the previous screen.

CONTEXT KEY	FUNCTION
	Returns to the previous screen.

9.6.4 Configuration→Information→Reminder

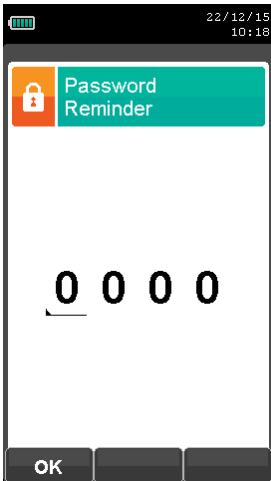

KEY	FUNCTION
	Activate the context keys shown on the display.
	Sets the password to access the remainder menu. The password is: 2908.
	Returns to the previous screen.

CONTEXT KEY	FUNCTION
	Shows details about the main features of the sensors installed.
	Returns to the previous screen.
	Shows all information relevant to service center.
	Temporarily ignores the message. At next turn-on of the instrument the reminder will be shown again.
	Ignores the message permanently.

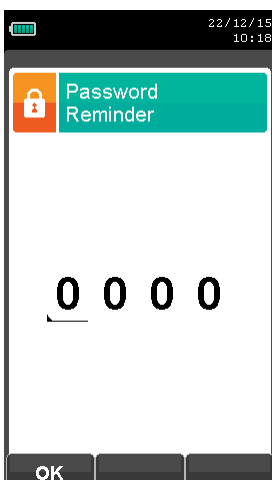



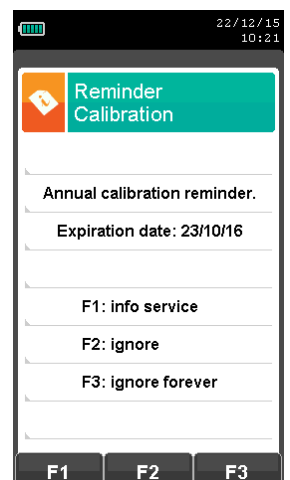
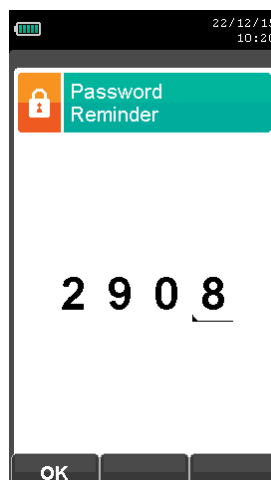

 Enter the password
 for the reminder
 menu ' 2908 '

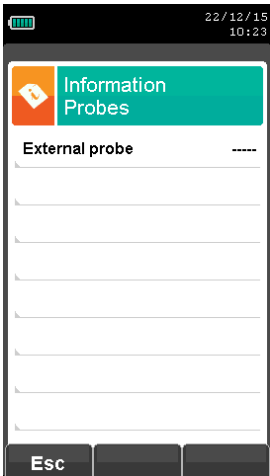

9.6.5 Configuration→Information→Probes



KEY	FUNCTION
	Activate the context keys shown on the display.
	Returns to the previous screen.

CONTEXT KEY	FUNCTION
	Returns to the previous screen.

9.7 Configuration → Diagnostic

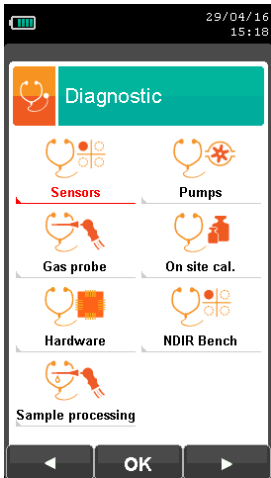
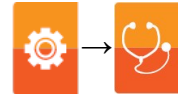

KEY	FUNCTION
	Activate the context keys shown on the display.
	Returns to the previous screen.

CONTEXT KEY	FUNCTION
	Selects the available parameters.
	Enters in the selected parameter setting.
	Selects the available parameters.

PARAMETER	DESCRIPTION
 Sensors	<p>Displays information on the state and calibration of the electrochemical sensors:</p> <ul style="list-style-type: none"> Ok No problem detected absent The sensor was not detected err data Memory data error of the sensor unknown It is necessary to update the FW of the device err pos The sensor has been installed in the wrong position err cal Calibration error (sensor not calibrated) err curr Currents outside the range err cfg Do not use this sensor as it has not been accepted on the screen "types of sensors". <p>Also, from this screen the user can access the identification data of the sensor: type, serial number, date of manufacture and calibration. There are also the measured currents; in this way it is possible to perform a quick diagnosis in the event of a malfunction. SEE SECTION 9.8.</p>
 Pumps	<p>The user can access to the management of the flue gas sampling pump and the peristaltic pump. SEE SECTION 9.9.</p>
 Gas probes	<p>Allows to check the tightness of the flue sampling probe. SEE SECTION 9.10.</p>
 On site cal.	<p>It is possible to make a recalibration of the instrument gas sensors with suitable known concentration gas cylinders. For the sensors sensible to other gases, called interfering gases (for example NH₃, H₂, H₂S, SO₂, ...) it is possible to perform the on site calibration also for the relevant interfering gases. The sensors recalibration procedure is protected with the password: inquire Seitron Americas Customer Service in order to obtain it. SEE SECTION 9.11.</p>
 Hardware	<p>At instrument turn on the firmware performs a full check on the physical efficiency of all types of HW memories installed on the instrument, as well as on the integrity of the data stored into them. Any issue is displayed in the screen 'Memories Diagnostics'. Should this happen it is advisable to turn the instrument off and then on again. In case the problem is permanent or frequently recurring, the user should contact the Service Center reporting the error code shown by the instrument. SEE SECTION 9.12.</p>
 NDIR Bench	<p>The user can check the status of the infrared bench NDIR. SEE SECTION 9.13.</p>
 Sample processing	<p>The user can check the status of the heated line (heated tube, heated head and Peltier cell unit). SEE SECTION 9.14.</p>

9.8 Configuration → Diagnostic → Sensors

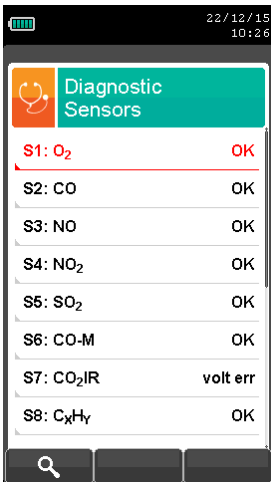
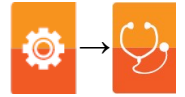

KEY	FUNCTION
	Activate the context keys shown on the display.
	Selects the fuel.
	Activates the context keys located in the left side of the display.
	Returns to the previous screen.

CONTEXT KEY	FUNCTION
	Displays the details of the selected sensor (see example below).
	Returns to the previous screen.

Example:

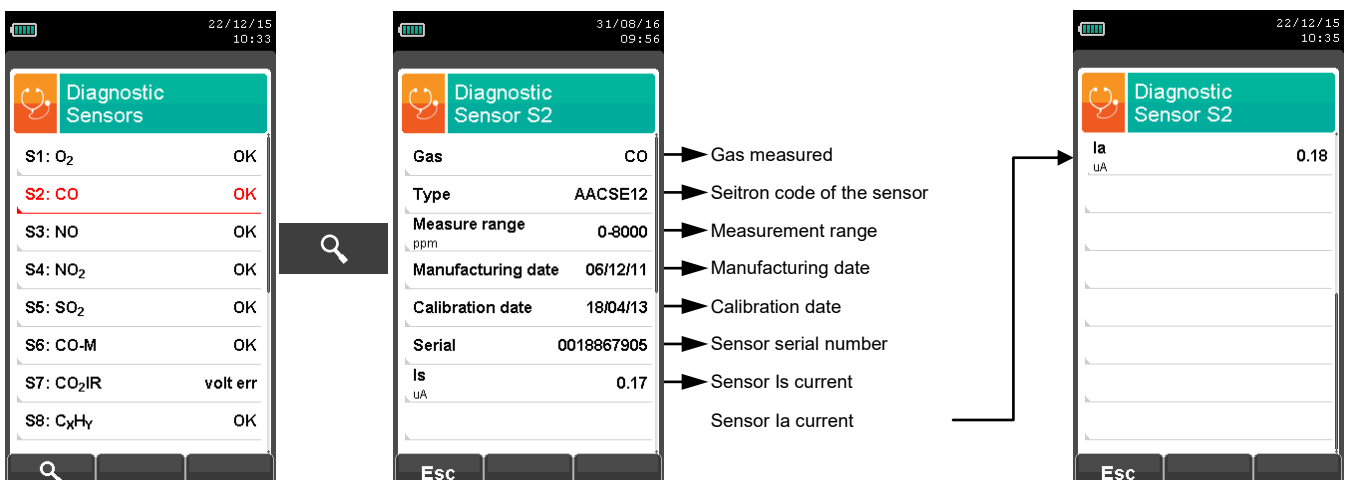

9.9 Configuration → Diagnostic → Pump

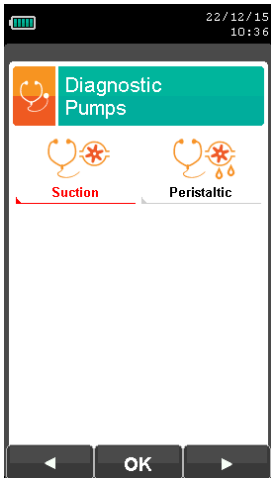
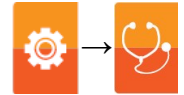

KEY	FUNCTION
	Activate the context keys shown on the display.
	Returns to the previous screen.

CONTEXT KEY	FUNCTION
	Selects the available parameters.
	Enters in the selected parameter setting.
	Selects the available parameters.

PARAMETER	DESCRIPTION
<p>Suction</p>	<p>In this submenu the user can temporarily turn the gas suction pump on or off. Also, it is possible to view the actual flow rate of the pump in liters per minute. It will not be possible to turn off the pump during an autozero cycle.</p> <p>SEE SECTION 9.9.1.</p>
<p>Peristaltic</p>	<p>In this submenu the remaining useful lifetime of the tube of the peristaltic pump is displayed. After replacing the tube of the peristaltic pump, perform a reset to restart the countdown of the hours of use of the tube.</p> <p>SEE SECTION 9.9.2.</p>

9.9.1 Configuration→Diagnostic→Suction

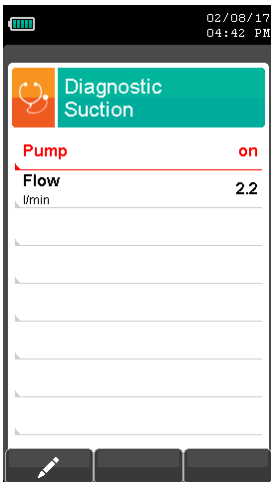
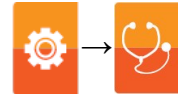

KEY	FUNCTION
	Activate the context keys shown on the display.
	Selects the fuel.
	Activates the context keys located in the left side of the display.
	Returns to the previous screen.

CONTEXT KEY	FUNCTION
	Enters edit mode: it is possible to turn the gas suction pump on and off.
	Confirms the modification.

9.9.2 Configuration→Diagnostic→Peristaltic

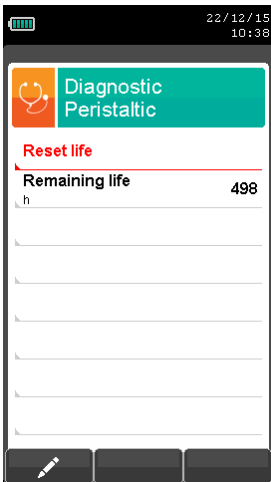
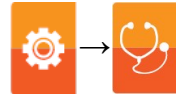

KEY	FUNCTION
	Activate the context keys shown on the display.
	Enters in the modification mode then confirms the changes made.
	Activate the context keys shown on the display.

CONTEXT KEY	FUNCTION
	Enters the modify mode: you can reset the timer of the time left for replacing the tube of the peristaltic pump.
	Resets the timer.
	Cancels and returns to the previous screen.

9.10 Configuration → Diagnostic → Gas probe

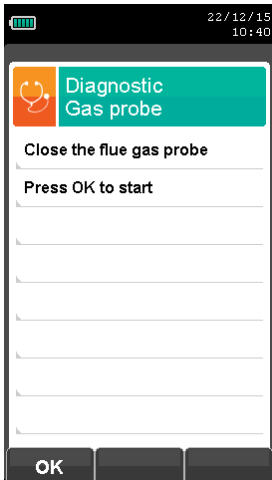
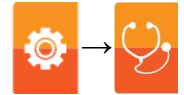

Connect the flue gas sampling probe and filter unit assembly to the instrument;
Fully insert the black rubber cap on the gas probe tip, as shown in the following picture:

KEY	FUNCTION
	Activate the context keys shown on the display.
	Activates the context key located in the left side of the display.
	Returns to the previous screen.

CONTEXT KEY	FUNCTION
	Starts the test to check the tightness of the gas sampling probe.
	Starts the test of the gas sampling probe.

Tightness test of the probe.

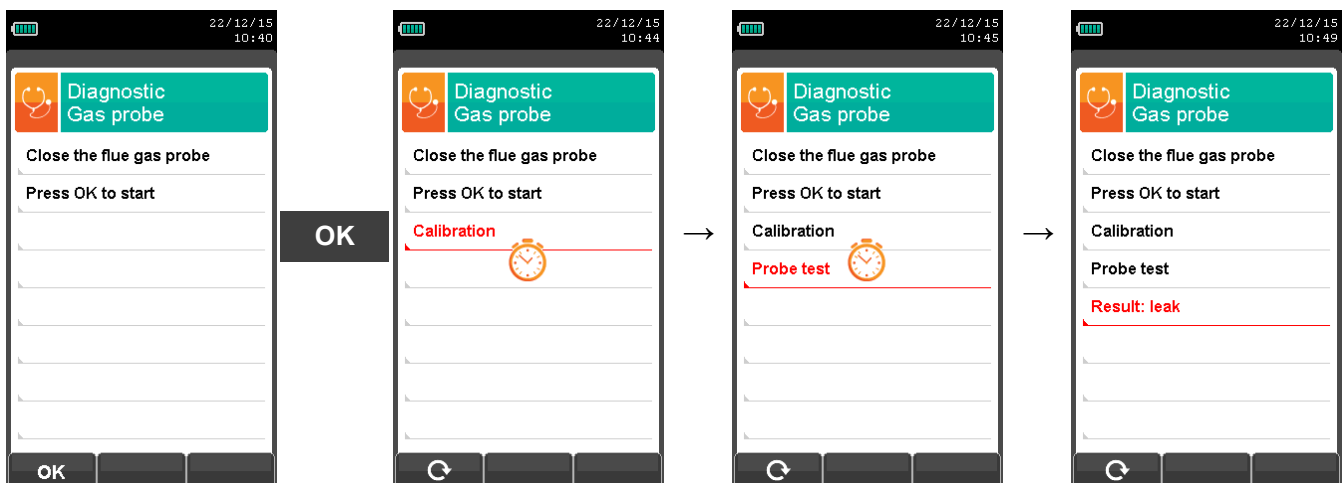

Results:

Tightness: The system is tight.

Error: Make sure that the probe is connected to the input P-, check the seals of the pneumatic connections and/or the seal of the condensation trap and check that the test cap is correctly inserted on the tip of the probe. **WARNING: a damaged probe tip may impair the test.**

9.11 Configuration → Diagnostic → On site cal.

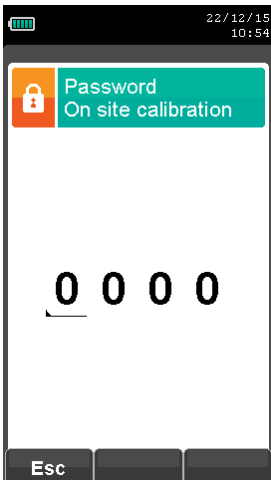
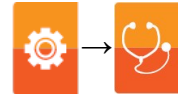

KEY	FUNCTION
	Activate the context keys shown on the display.
	Sets the password.
	Selects line; the selected line is displayed in red. In modification sets the value or the desired mode.
	Activates the context key located in the left side of the display.
	Returns to the previous screen. When in modify mode cancels the modification just made.

CONTEXT KEY	FUNCTION
	Once password is entered, gives access to the 'On site calibration' menu.
	Shows details for the selected sensor.
	Zeroes the timer.
	Enters the modification mode for the selected parameter.

9.11.1 Calibration procedure

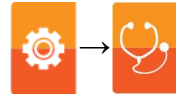

In order to perform the calibration, the following tools are needed:

- Calibration gas cylinder suitable for the sensor with known gas concentration, complete with a pressure regulator.

WARNING!

For the oxygen sensor on site calibration, the zero value calibration must be carried out with nitrogen or any other gas mixture which DOES NOT contain oxygen.

- Flow meter.
- Hose with ' T ' shaped junction, in order to connect the cylinder to the instrument and the flow meter.

1. Start the instrument

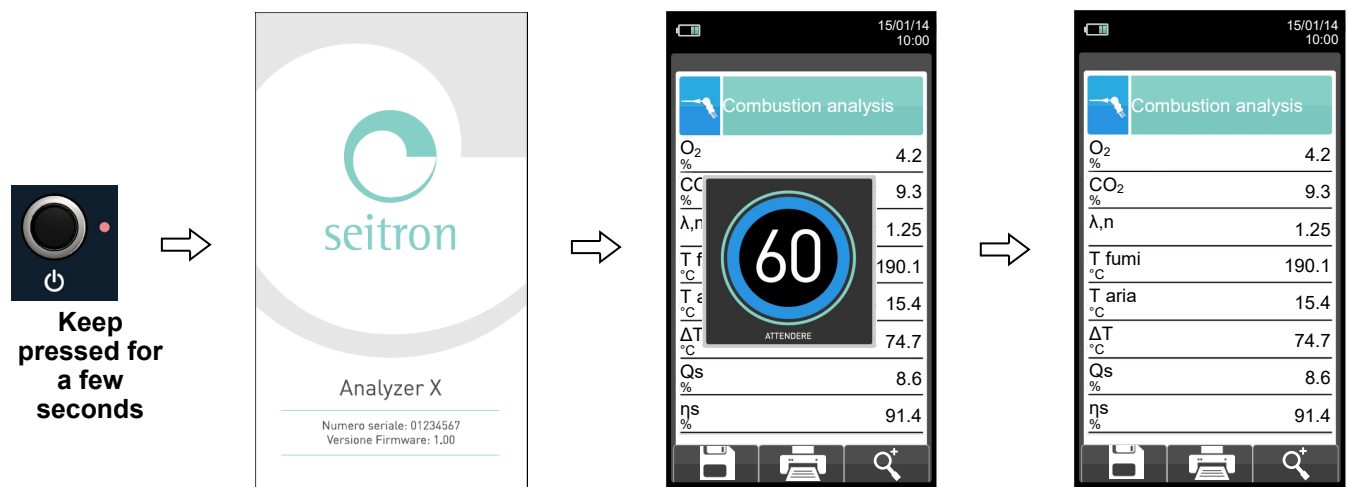

WARNING

- Make sure autozero is execute in clean air and terminates correctly.
- Do not connect the gas probe to the instrument.
- Check the battery charge level or connect the power adapter to avoid data loss during recalibration.

2. Once autozero is completed press the key and select the diagnostic icon.

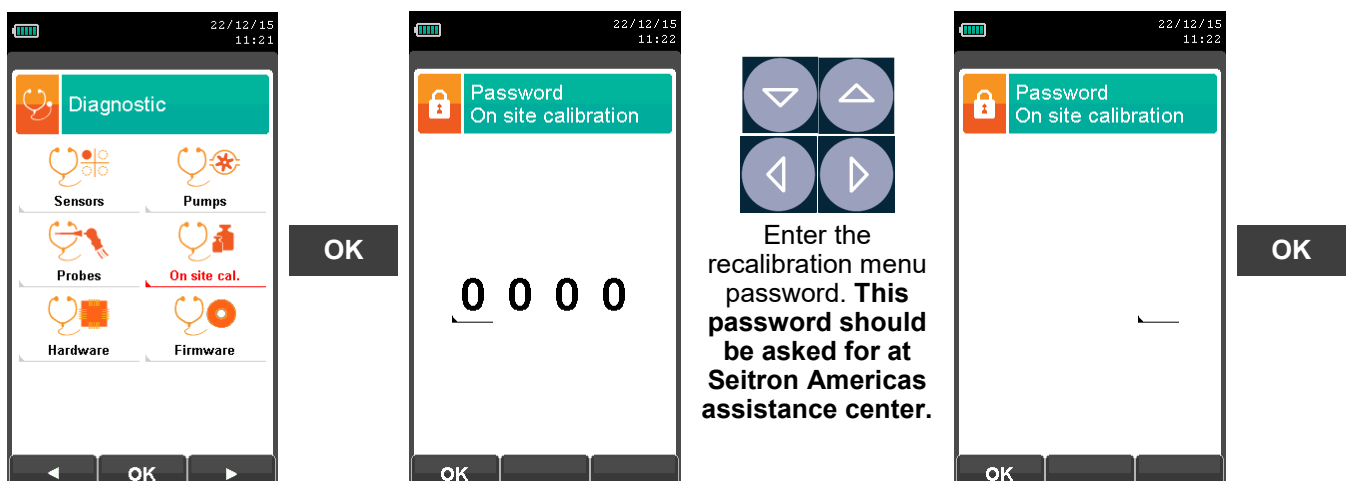

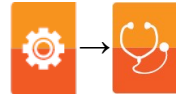

3. Once in the 'On site calibration' menu, the list of the installed sensors for which the recalibration is available is shown.

By selecting one sensor, in the recalibration screen all information related to the last performed calibration is shown.

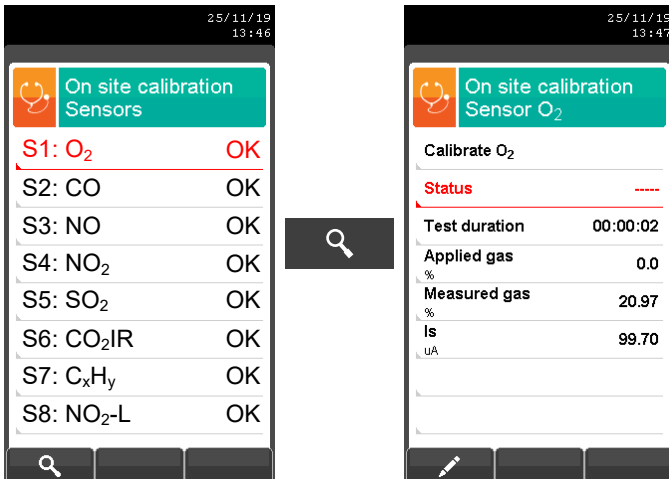

- Calibrate:** saves new calibration
- Status:** not active: returns to the factory calibration
active: returns to the last calibration made by the user
----: no 'on site calibration' has been previously stored
- Test duration:** timer
- Applied gas:** enters the concentration of the applied calibration gas
- Measured gas:** measures the concentration of the applied gas
- Is:** 'Is' current from the sensor
- Ia:** 'Ia' current from the sensor (CO only)

CHOOSE THE SENSOR TO BE CALIBRATED AND DO AS FOLLOWS

4. Connect the instrument to the gas cylinder suitable for the selected sensor, with known gas concentration, as shown in the following diagram.



WARNING!
Adequate ventilation must be provided when working with toxic gases, particularly the flow meter and instrument outputs must be evacuated by a ventilation system.

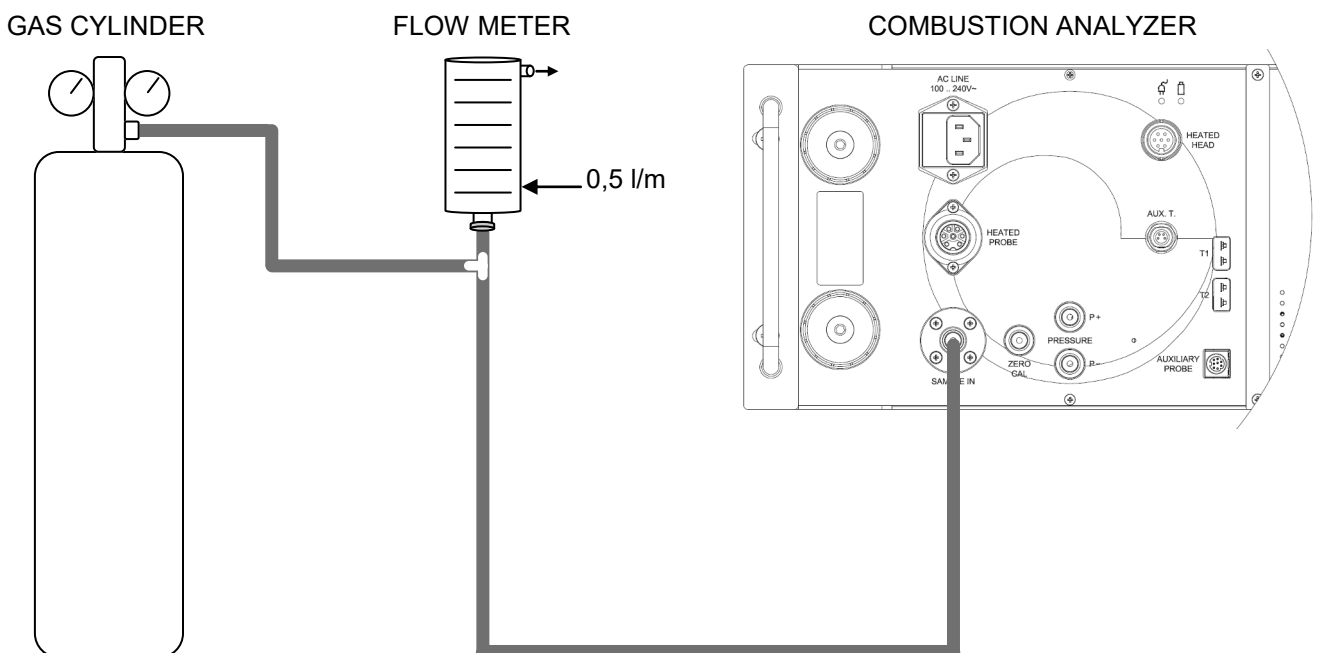

OXYGEN SENSOR (O₂) CALIBRATION DETAIL.

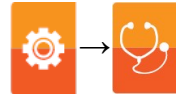

- The calibration will be possible only when the status is set to '----' (cells which never had an on-site calibration) or it is necessary to set the state to 'not active' (see example).

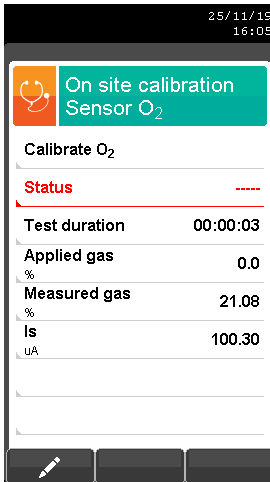

OR

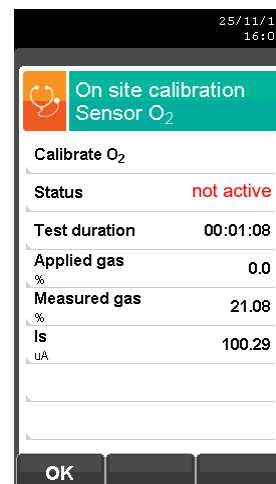
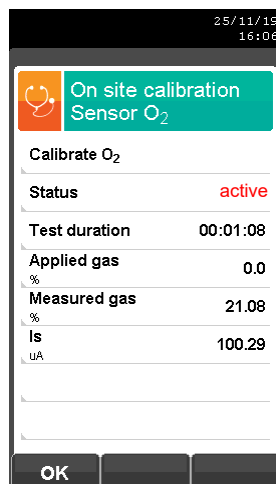
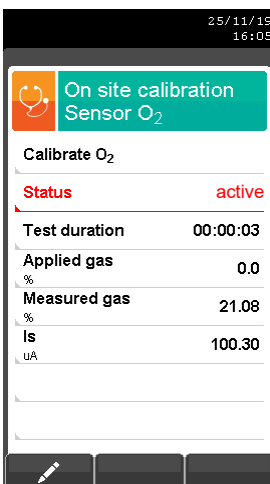

- Apply gas to the instrument** and adjust the output pressure of the gas from the cylinder so that the flow meter indicates a minimum flow of 0.5 l/m: this guarantees that the instrument is taking the exact amount of gas required by the internal pump.
- The instrument measures the concentration of gas applied; **wait at least 3 minutes to allow the reading to stabilize.** The reading is shown in line 'Gas measured'.

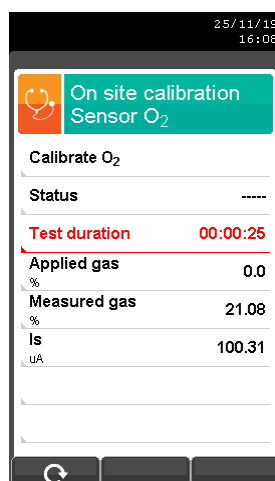
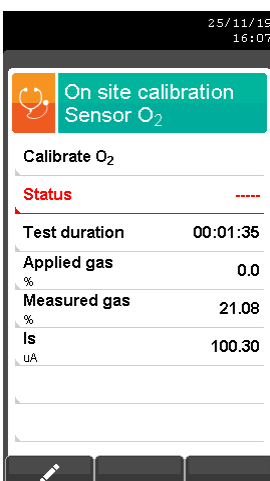

Zeroes the timer - helps to keep under control the time elapsing during the stabilization phase.

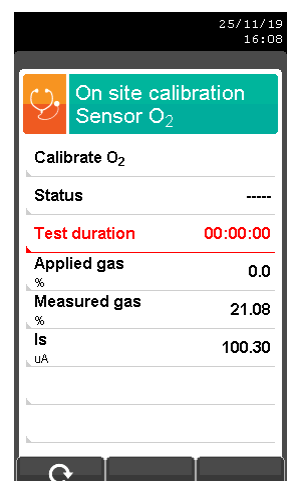

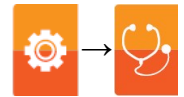

- When the stabilization time is over, select the 'Calibration' row and store the new calibration.

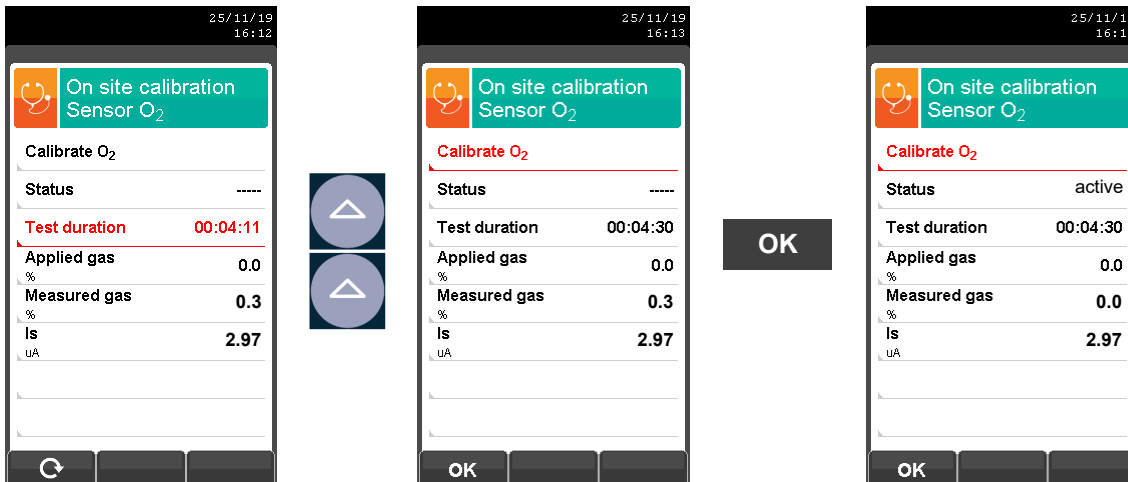

Once the new calibration has been stored, the possible temporary messages which can be seen on the row 'status' are the following:

saving: the instrument is saving the performed calibration

error: the sensor has NOT been recalibrated for any of the following reasons:

- The calibration gas cannot properly reach the instrument.
- The user didn't allow for the stabilization time to properly elapse.
- The sensor could be damaged or exhausted and must therefore be replaced.



WARNING

- At any time the user can restore the factory calibration in the instrument by setting the 'Status' line on 'not active'.
- The recommended stabilization time for the on-site calibration of the sensors is 3 minutes. This time can be up to 5 minutes for NO2 and SO2 sensors.

TOXIC GASES SENSOR CALIBRATION DETAIL (EXAMPLE REFERRED TO CO).

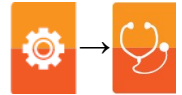

- The calibration will be possible only when the status is set to '----' (cells which never had an on-site calibration) or it is necessary to set the state to 'inactive' (see example).

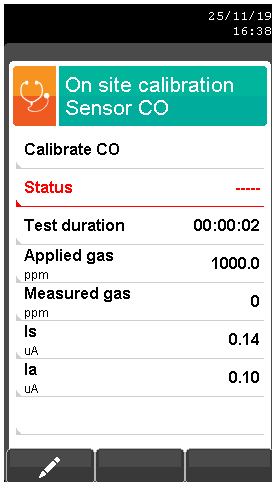

OR

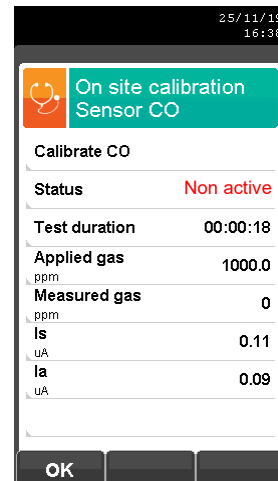
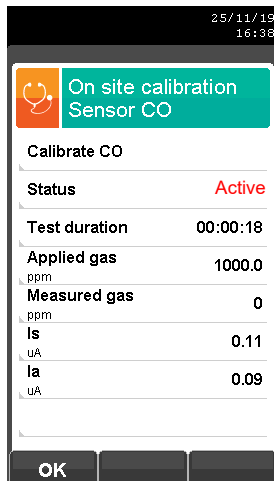
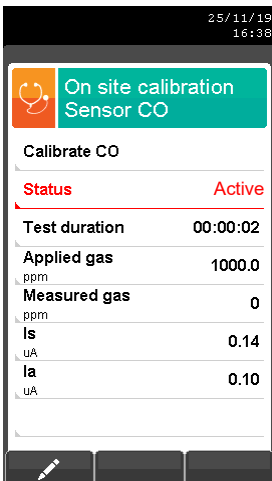

- Enter the concentration value of the applied gas.

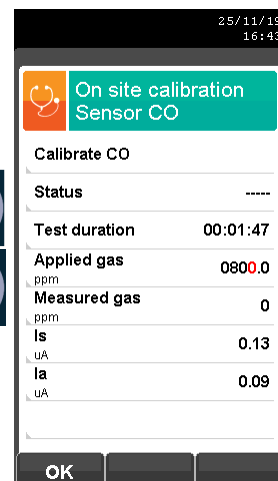
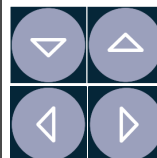
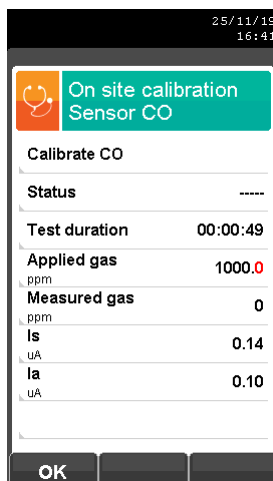
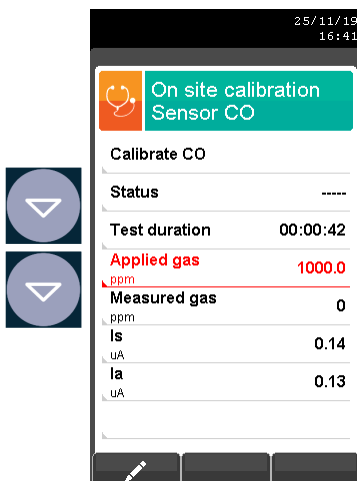

- Apply gas to the instrument and adjust the output pressure of the gas from the cylinder so that the flow meter indicates a minimum flow of 0.5 l/m: this guarantees that the instrument is taking the exact amount of gas required by the internal pump.

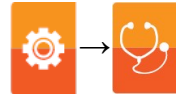

- The instrument measures the concentration of gas applied; **wait at least 3 minutes to allow the reading to stabilize**. The reading is shown in line 'Gas measured'.

The first screenshot shows the 'Calibrate CO' screen with a 'Test duration' of 00:00:35. The 'Applied gas' is 800.0 ppm and the 'Measured gas' is 683 ppm. A blue arrow points to the right.

The second screenshot shows the 'Test duration' at 00:01:10. A red bar highlights the 'Test duration' and 'Applied gas' fields. A circular refresh icon is shown to the right.

The third screenshot shows the 'Test duration' reset to 00:00:00. A text box explains: "Zeroes the timer - helps to keep under control the time elapsing during the stabilization phase."

- When the stabilization time is over, select the 'Calibration' row and store the new calibration.

The first screenshot shows the 'Calibrate CO' screen with a 'Test duration' of 00:04:30. A blue arrow points to the right.

The second screenshot shows the 'Calibrate CO' row highlighted in red. A blue arrow points to the right.

The third screenshot shows the 'Status' line as 'Attiva' and the 'Measured gas' as 800 ppm. An 'OK' button is shown to the right.

Once the new calibration has been stored, the possible temporary messages which can be seen on the row 'status' are the following:

- saving:** the instrument is saving the performed calibration
- error:** the sensor has NOT been recalibrated for any of the following reasons:
 - The calibration gas cannot properly reach the instrument.
 - Concentration for the calibration gas has not been set in the relevant line 'Applied gas'.
 - The user didn't allow for the stabilization time to properly elapse.
 - The sensor could be damaged or exhausted and must therefore be replaced.



WARNING

- At any time the user can restore the factory calibration in the instrument by setting the 'Status' line on 'not active'.
- The recommended stabilization time for the on-site calibration of the sensors is 3 minutes. This time can be up to 5 minutes for NO2 and SO2 sensors.

TOXIC GASES SENSOR CALIBRATION DETAIL WITH INTERFERING GASES

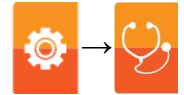

The toxic gases sensors with interfering gases are these sensors sensible to other gases. The on site calibration for these sensors also allows to calibrate the interfering gases.

The on site calibration procedure for these sensors is the same described in the previous pages regarding the toxic gases sensors and it can be performed for all the gases which interferes with the sensor itself.

On the following is described the mode to access the interfering gases with the sensor which must be calibrated on site (example referred to NH₃ sensor).

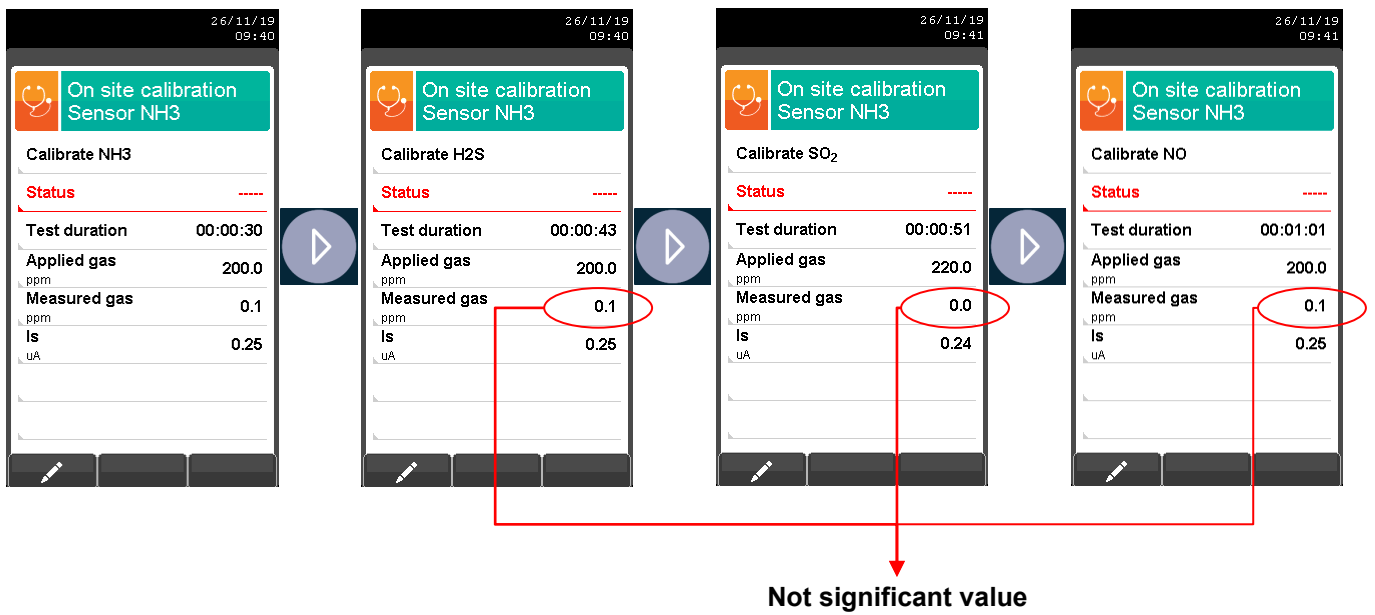

SENSOR	INTERFERING GASES		
NH ₃	H ₂ S	SO ₂	NO
SO ₂	CO	NO	NO ₂
H ₂ S	SO ₂	NO	NO ₂
H ₂	CO	NO	NO ₂

Tab. 1: Interfering gases table.

WARNING
The recommended stabilization time for the on-site calibration of these sensors is 5 minutes.

WARNING
During analysis, the influence of interfering gases is compensated only if the correspondent sensor is installed.

9.12 Configuration → Diagnostic → Hardware

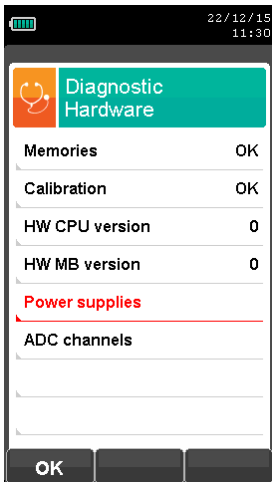
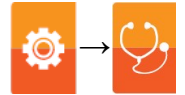

- State of memory
- State of calibration
- Version of CPU board
- Version of motherboard
- Main power supplies
- ADC converter input signals

KEY	FUNCTION
	Activate the context keys shown on the display.
	Returns to the previous screen.

CONTEXT KEY	FUNCTION
	Returns to the previous screen.
	Shows values in mV
	Shows values in bits

9.13 Configuration → Diagnostic → NDIR bench

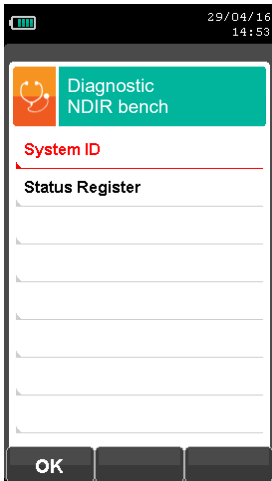
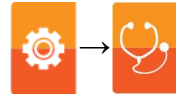

→ NDIR bench identification data.
 → NDIR bench information about operational status.

KEY	FUNCTION
	Activate the context keys shown on the display.
	Selects line; the selected line is displayed in red.
	Activates the context key located in the left side of the display.
	Returns to the previous screen.

CONTEXT KEY	FUNCTION
	Enters in the selected data setting.
	Returns to the previous screen.

9.14 Configuration → Diagnostic → Sample processing

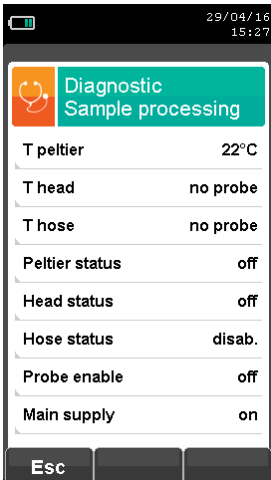
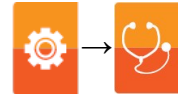





KEY	FUNCTION
	Activate the context keys shown on the display.
	Activates the context key located in the left side of the display.
	Returns to the previous screen.

CONTEXT KEY	FUNCTION
	Returns to the previous screen.

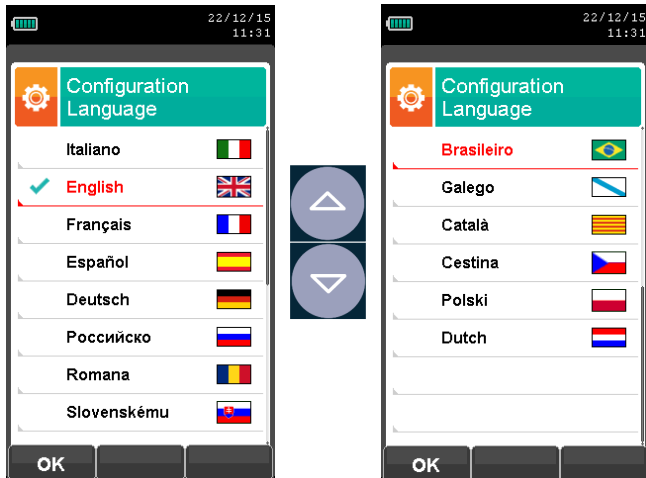

9.15 Configuration→Language



KEY	FUNCTION
	Activate the context keys shown on the display.
	Scrolls through the available languages.
	Sets the selected language.
	Returns to the previous screen.

CONTEXT KEY	FUNCTION
	Sets the selected language.



9.16 Configuration→Restore

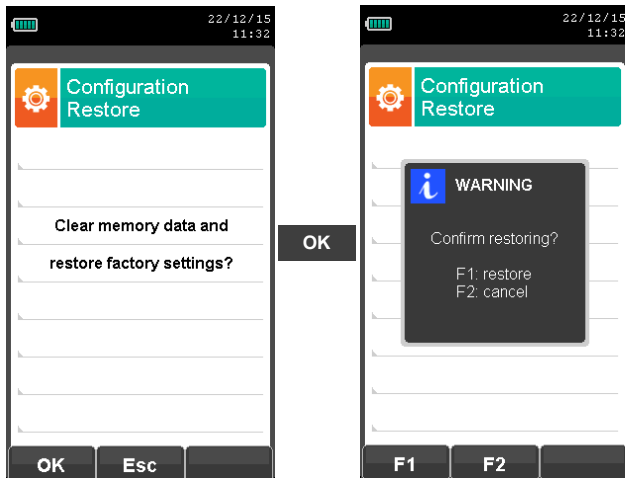

KEY	FUNCTION
	Activate the context keys shown on the display.
	Starts the factory values reset phase.
	Exits the current screen without resetting to factory values.

CONTEXT KEY	FUNCTION
	Starts the factory data reset phase.
	Exits the current screen without resetting.
	Factory reset.
	Cancels the factory data reset phase and goes back to the previous screen.

10.1 Memory Menu

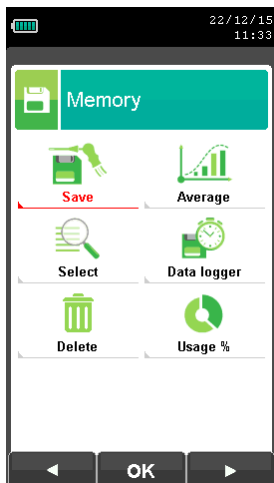



KEY	FUNCTION
	Activate the context keys shown on the display.
	Returns to the previous screen.

CONTEXT KEY	FUNCTION
	Selects the available parameters.
	Enters in the selected parameter setting.
	Selects the available parameters.

PARAMETER	DESCRIPTION
 Micromanometer	From this screen the user can start the combustion analysis. The data shown summarizes the mode of analysis and the selected memory. SEE SECTION 10.2.
 Average	Allows the user to see the average of the analyses contained in the selected memory. SEE SECTION 10.3.
 Select	<ul style="list-style-type: none"> - Allows the user to choose the memory position to be used to save the combustion analysis and/or the draft/pressure measurement. For each memory it is possible to enter the personal information of the customer (name of the customer, address, telephone number, type of combustion equipment, etc.). - Allows the user to see and print the stored analyses, individually or as an average. The analyses can be found (via the context key "find") by memory location or by the date they were saved; it is also possible to see the draft, carbon black and ambient CO. In the menu "Find Memory" the activation of the Print Memory is enabled only on the page where the analyses or the draft, carbon black and ambient CO data are displayed. SEE SECTION 10.4.
 Data logger	<p>This submenu allows the user to define the mode of analysis and of memory selection:</p> <p>Automatic analysis modes:</p> <p>BlmSchV - See section '10.5.2 Details on BlmSchV - data logger' The factory settings of the device are in accordance with the German standard BlmSchV, which requires that you perform at least 30 samples spaced 1 sec.</p> <p>data logger - See section '10.5.2 Details on BlmSchV - data logger' This mode is entirely configurable by the user (it is necessary to set the number of samples to be acquired, the duration of acquisition of each sample and the printing mode). When the combustion analysis starts, the device will automatically carry out and store the number of samples set, spaced from one another according to the set time. After the combustion analysis (indicated by a beep), if the "Manual Print" mode has been selected, the device will display the average of the samples taken with the possibility to recall them individually; the user can then print them (total, complete, ...). On the contrary, if the user has selected the option "Automatic Print", the device will automatically proceed to print the analyses, according to the current printing settings, without displaying the average.</p>



 <p>Data logger</p>	<p>periodic - see section "10.5.3 Memory > Data logger > Data logger". This mode can be completely configured by the user and allows to monitor the emissions of pollutants at set intervals of time. The start of the analysis of the emissions can be set by the user (immediately or at a scheduled day and time). When the emission analysis begins, the instrument shall automatically acquire and store the set number of samples. During the acquisition it is possible to monitor the performance.</p> <p>NOTE: IN THIS ANALYSIS MODE THE ANALYZER MUST BE CONNECTED TO THE MAINS SUPPLY. THE INSTRUMENT AUTO-ZEROING IS PERFORMED AT THE BEGINNING OF EVERY ANALYSIS CYCLE AND IN ANY CASE ON AN HOURLY BASIS; THE DURATION SHALL BE SET BY THE USER. At the end of the analysis of emissions (an audible alarm will be emitted) the instrument shall display the average acquired samples. The stored tests can be displayed and individually printed directly from the instrument or transferred to the PC for further processing. Warning: in automatic mode, the measurements of carbon black, draft and ambient CO must be taken before starting the combustion analysis.</p> <p>Manual analysis mode - See section '10.5.1 Details on manual mode'. If the user chooses the manual mode, he will perform the combustion analysis manually; in this case, the settings regarding printing and duration of the automatic analysis will not be considered. At this point the user can start the manual analysis after waiting for the measured displayed to stabilize. Then he can proceed to save or directly print the data, which will be prepared in accordance with the previously configured settings. At the end of the three analyses, the screen with the average can be displayed, which also contains all the data necessary to fill in the booklet of the system or plant.</p> <p>Memory selection mode Manual: the memory will have to be selected manually via the parameter "Select" Auto: the memory, to which the measurements and combustion analyses will be saved, will be suggested automatically when the device is turned on. SEE SECTION 10.5.</p>
 <p>Delete</p>	<p>Allows the user to delete the contents of each memory or of all memories. SEE SECTION 10.6.</p>
 <p>Usage %</p>	<p>The user, through this menu, can view the percentage of memory usage. SEE SECTION 10.7.</p>

10.1.1 Memory Organization



The memory nodes can be sorted in several ways:

- Acc. to Date-Time
- Acc. to memory n.
- Acc. to Client

Once a memory is selected, the average value is calculated over ALL the samples 'C-' acquired (parameter 'Average' in the 'Memory' menu) or, alternatively, over a smaller interval to be defined in the parameter 'Select' in the 'Memory' menu'.

One 'sample' is composed of the set of the measured parameters (gas, temperature, pressure, etc.). Each single sample can contain up to 30 parameters.

Memory constraints:

$N^{\circ} \text{ Memories} * (N^{\circ} \text{ Samples} + 1) \leq 16000.$

- The maximum number of memories is 8000.
- For each memory the maximum number of samples is **15999**.
- The maximum number of storable memories for analysis made according to the UNI10389-1 standard is:
 $16000 / (1+3) = 4000$

WARNING
When in Data Logger mode the samples are stored in the same unique memory position, following the sampling schedule set by the user.

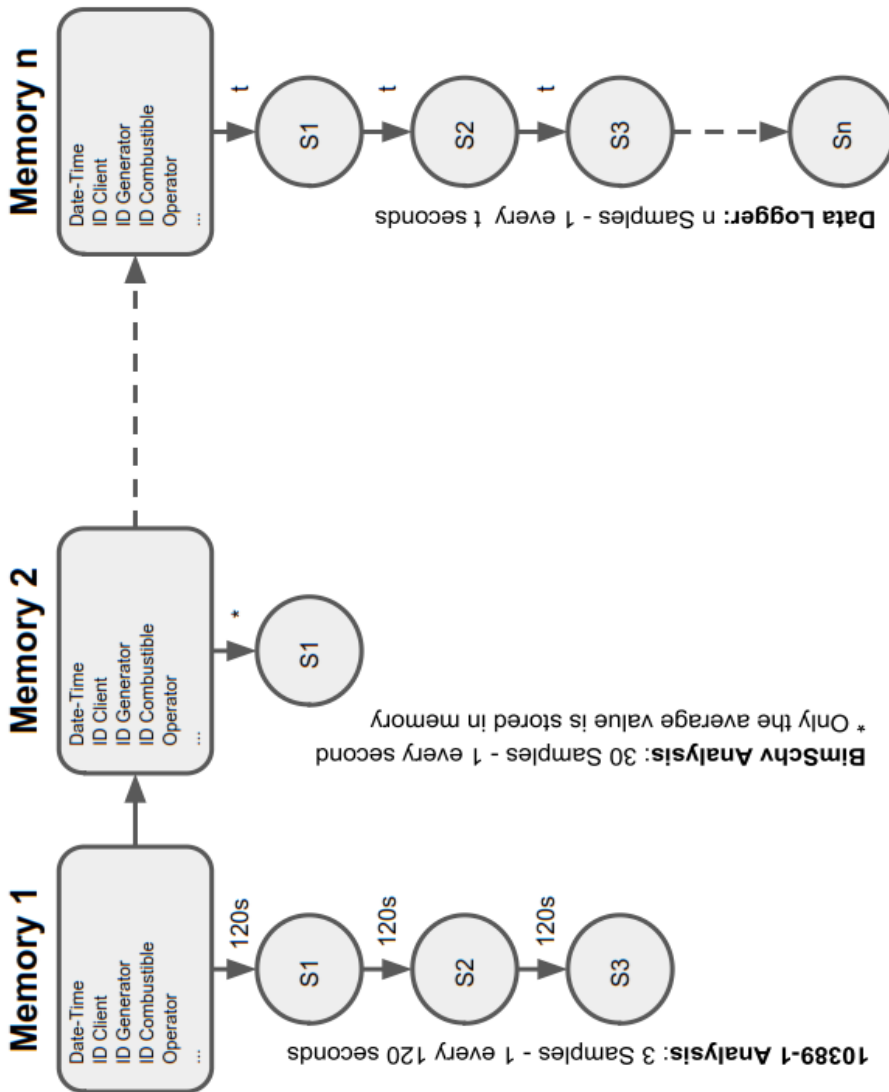



10.2 Memory Menu → Save

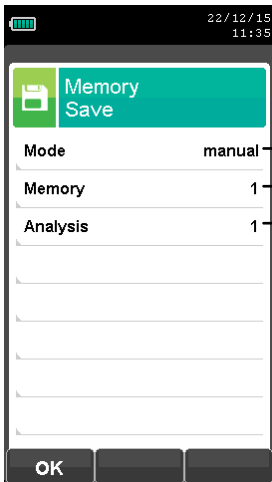

Manual analysis mode
 Number of selected memory
 Number of analyses carried out

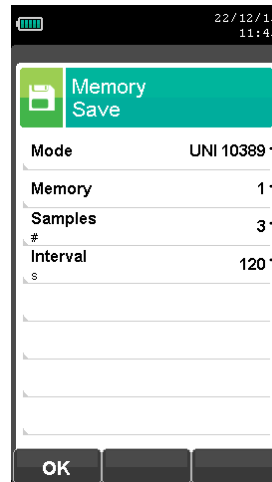

Automatic analysis mode
 Number of selected memory
 Number of samples to take
 Interval between samples

KEY	FUNCTION
	Activate the context keys shown on the display.
	Starts saving the combustion analysis according to the mode set in the parameter 'Data logger'.
	Returns to the previous screen.

CONTEXT KEY	FUNCTION
	Starts saving the combustion analysis according to the mode set in the parameter 'Data logger'.
	Deletes the contents of the selected memory. (Visible when the selected memory contains previous analyses).
	Cancels the deletion of the contents of the selected memory. (Visible when the selected memory contains previous analyses).



Example 1: Saving the combustion analysis in manual mode

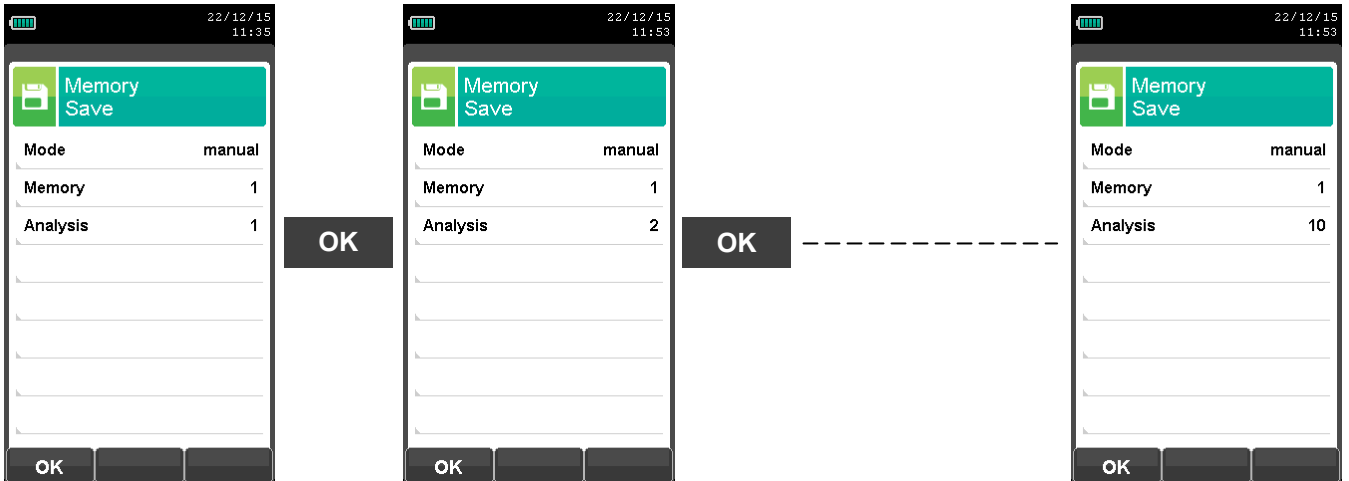



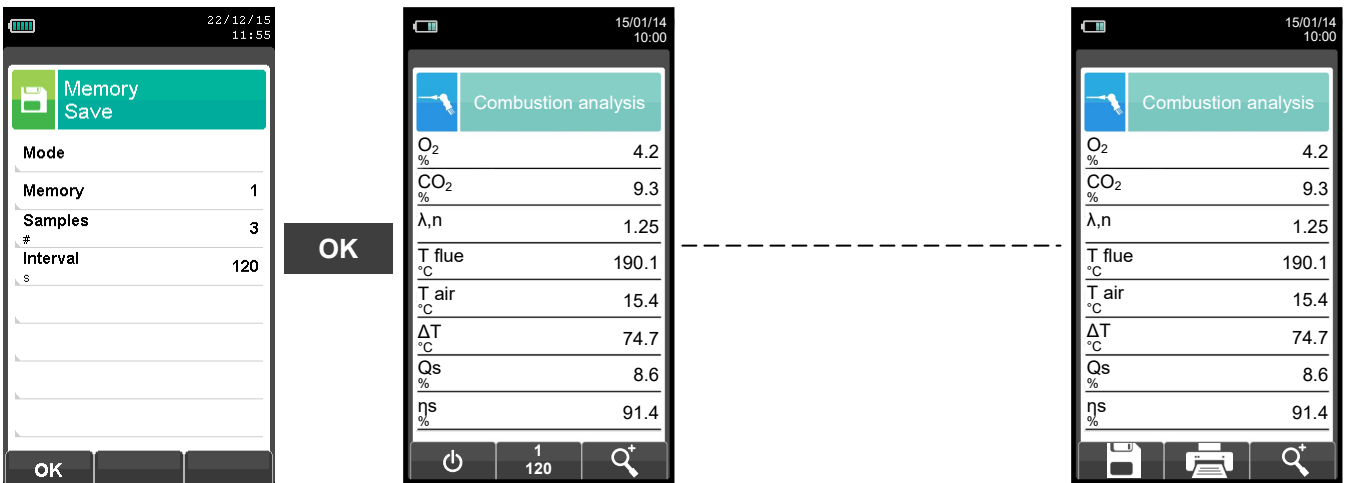

Example 2: Saving the combustion analysis in automatic mode



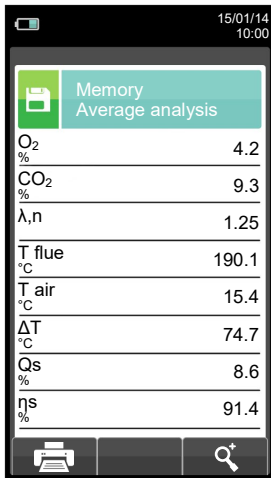

 FOR FURTHER INFORMATION SEE [SECTION 13 'COMBUSTON ANALYSIS'](#).

10.3 Memory Menu → Average



KEY	FUNCTION
	Activate the context keys shown on the display.
	Scrolls through the values of the average analysis.
	Activates the context key located in the left side of the display.
	Returns to the previous screen without saving the changes made.

CONTEXT KEY	FUNCTION
	Starts printing the test paper print-out. See section 11.
	Displays the status of the heated line when the stored analysis is performed.
	Zoom. By pressing this interactive key repeatedly, the device displays the following sequence: AAA → AAA → AAA → AAA

10.4 Memory Menu → Select

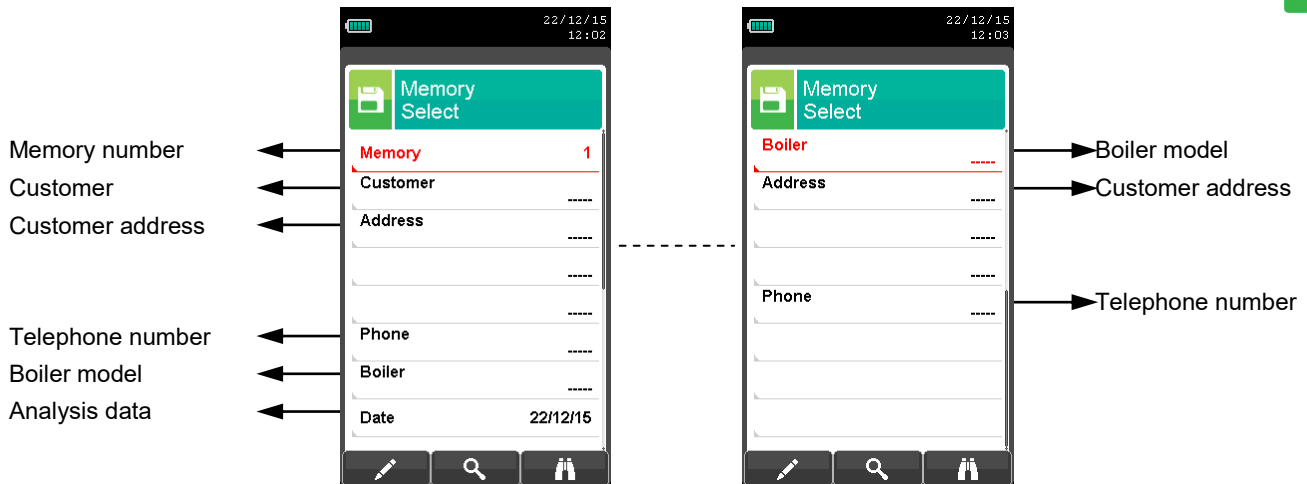

KEY	FUNCTION
	Activate the context keys shown on the display.
	In "edit text"/"search for data"/"search for memory number": it moves the cursor on the box corresponding to the desired letter or number.
	Selects line; the selected line is displayed in red.
	Activates the context key located in the left side of the display.
	Returns to the previous screen without saving the changes made.

CONTEXT KEY	FUNCTION
	Enters the modification mode for the selected parameter. It is possible to select the number of the memory to use for the combustion analysis and/or to enter the information relative to the plant.
	Recall memory. By activating this function, the user has the possibility to view the data present in the selected memory. Measurement conditions, single analysis, average analysis. SEE SECTION 10.4.1.
	Search function. Thanks to this function, the user has the possibility to quickly search for a specific analysis. The search can be carried out considering the memory number (by selecting the parameter "Memory"), the customer (by selecting one of the following parameters: "Customer", "Address", "Telephone" or "Generator") or the date (by selecting the parameter "Date").
	Confirms the settings and, if the search function is enabled, it starts the research.
	In "Edit text" it confirms the input of the selected letter or number.
	In "Edit text" it cancels the letter or number that precedes the cursor.
	In "Edit text" it goes from uppercase to lowercase, to symbols, to special characters.
	Selects the memories within the range of the research carried out.
	Selects the memories within the range of the research carried out.



10.4.1 Memory Recall

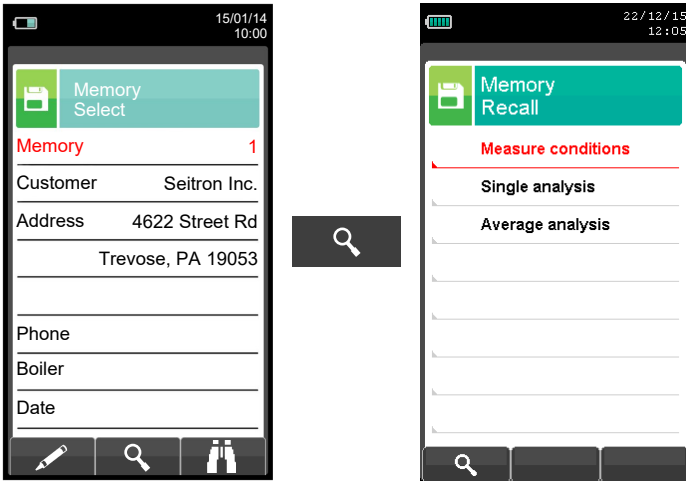

KEY	FUNCTION
	Activate the context keys shown on the display.
	Selects line; the selected line is displayed in red.
	Activates the context key located in the left side of the display.
	Returns to the previous screen.

CONTEXT KEY	FUNCTION
	Displays the details of the selected parameter.

1. Details of measurement conditions

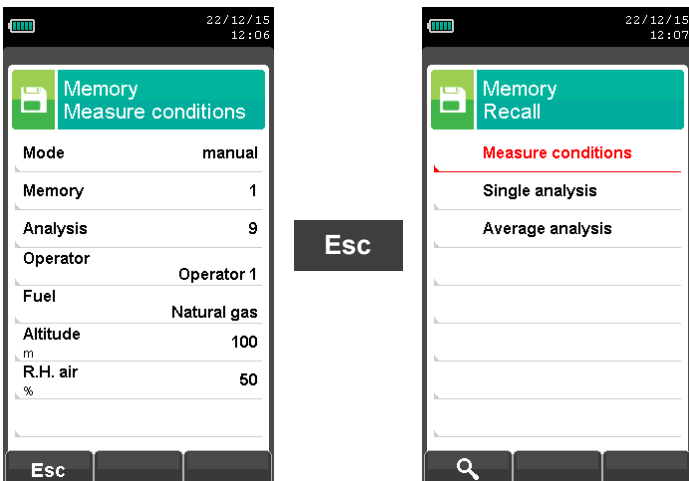

CONTEXT KEY	FUNCTION
	Returns to the previous screen.



2. Details of Single analysis

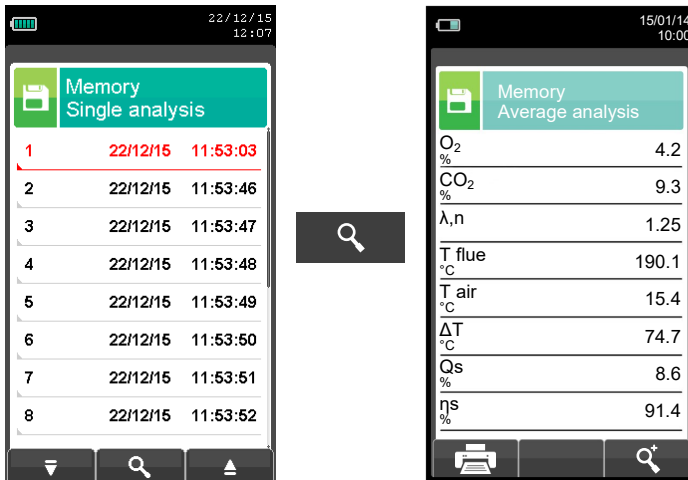

KEY	FUNCTION
	Activate the context keys shown on the display.
	Selects line; the selected line is displayed in red. In "view detail" the previous or next pages are shown.
	Views the details of the selected parameter.
	Returns to the previous screen.

CONTEXT KEY	FUNCTION
	Selects line; the selected line is displayed in red.
	Views the details of the selected parameter.
	Selects line; the selected line is red.
	Jumps to next page.
	Jumps to previous page.
	Starts printing the test paper print-out. See section 11.
	Displays the status of the heated line when the stored analysis is performed.
	Zoom. By pressing this interactive key repeatedly, the device displays the following sequence: AAA → AAA → AAA → AAA



3. Average analysis details

Defines the **start** sample to define the analysis average. ←

Defines the **end** sample to define the analysis average. ←

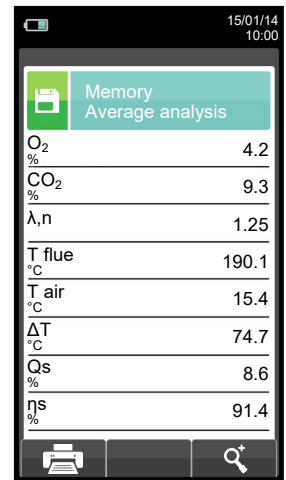
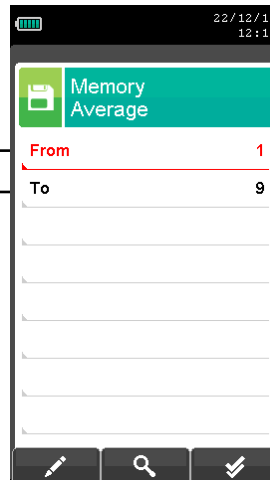

KEY	FUNCTION
	Activate the context keys shown on the display.
	In edit mode, it sets the number of the desired sample; the number to change is red.
	Selects line; the selected line is displayed in red.
	Activates the context key located in the left side of the display.
	Returns to the previous screen without saving the changes made.

CONTEXT KEY	FUNCTION
	Enters edit mode: it is possible to select the number of the sample to use to have the average of the analysis carried out.
	Shows the average analysis in the interval set.
	Zoom. By pressing this interactive key repeatedly, the device displays the following sequence: AAA → AAA → AAA → AAA
	Sets all the samples of the analyses carried out: From 1 (first sample) To xxx (last sample).
	Confirms the settings.
	Starts printing. See section 11.
	Displays the status of the heated line when the stored analysis is performed.

10.5 Memory Menu → Data logger



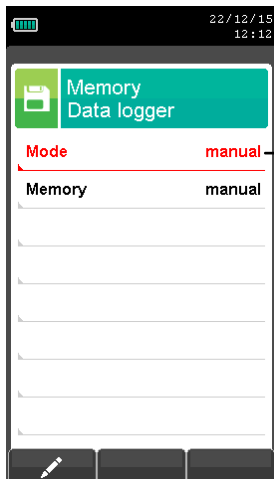

In this submenu the user can set the analysis modes and the relating parameters. 4 automatic modes and 1 manual mode can be selected.

Note: The display of parameters is contextual to the selected analysis mode.



The selectable analysis modes are:
Manual - BImSchV - data logger - periodic

KEY	FUNCTION
	Activate the context keys shown on the display.
	Returns to the previous screen.



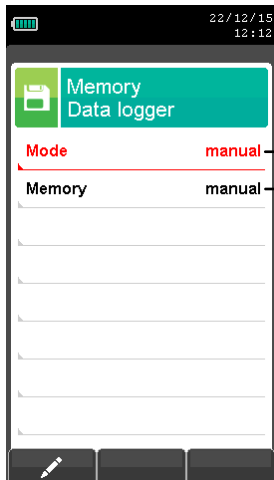

CONTEXT KEY	FUNCTION
	Enters the modification mode for the selected parameter.



10.5.1 Manual mode details



Manual selection mode

The memory selection modes are: **manual** or **auto**.
If "auto" mode has been selected, the research of the available memory will be performed automatically when the device is turned on).





KEY	FUNCTION
	Activate the context keys shown on the display.
	Selects the line; the selected line is highlighted in red. When in change mode sets the desired value or mode.
	Activates the context keys located in the left side of the display.
	Returns to the previous screen.

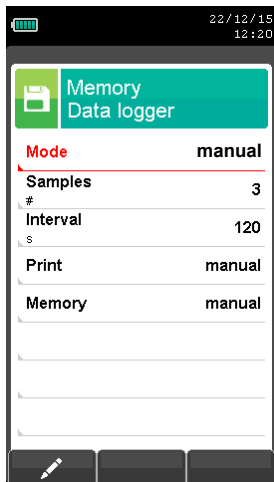

CONTEXT KEY	FUNCTION
	Enters the modification mode for the selected parameter.
	Confirms the settings.

10.5.2 Details on BlmSchV - data logger



- Selected modes: **manual - BlmSchV - data logger - periodic**
- Number of samples to acquire.
- Lapse of time between one sample and the next one.
- The selectable printing modes are: **manual** or **auto**.
If "**auto**" mode has been selected, the printing will be performed automatically at the end of the combustion analysis (parameter not visible in manual analysis mode).
- The memory selection modes are: **manual** or **auto**.
If "**auto**" mode has been selected, the research of the available memory will be performed automatically (when the device is turned on).

KEY	FUNCTION
	Activate the context keys shown on the display.
	Selects the line; the selected line is highlighted in red. When in change mode sets the desired value or mode.
	Activates the context key located in the left side of the display.
	Returns to the previous screen.

CONTEXT KEY	FUNCTION
	Enters the modification mode for the selected parameter.
	Confirms the settings.



10.5.3 Details of periodic mode

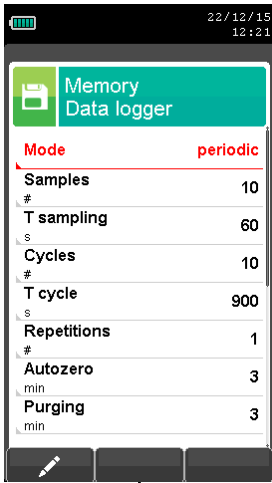

- Selected mode: **periodic**
- Number of samples to acquire.
- Lapse of time between a sample and the next one.
- Number of cycles to be performed within 24 hours.
*: number of times the instrument acquires the set number of samples.
- Lapse of time between the start of one cycle and the start of the next one.
- Number of times you want to repeat the acquisition of cycles in the following days.
- Duration of the autozero that will be executed at the beginning of each analysis cycle or every hour if the duration of the cycle is longer than an hour.
- Duration of cleaning that will be carried out at the end of each analysis cycle.

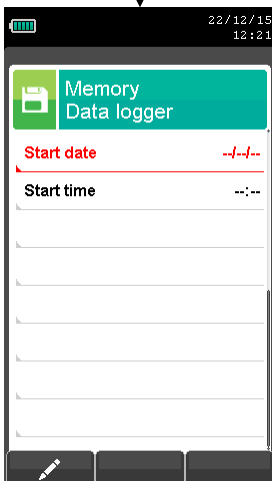

- Start date of emissions analysis.
- Start time of emissions analysis.

KEY	FUNCTION
	Activate the context keys shown on the display.
	Selects the line; the selected line is highlighted in red. When in change mode sets the desired value or mode.
	Activates the context key located in the left side of the display.
	Returns to the previous screen.

CONTEXT KEY	FUNCTION
	Enters the modification mode for the selected parameter.
	Confirms the settings.



Operational logic of the periodic mode

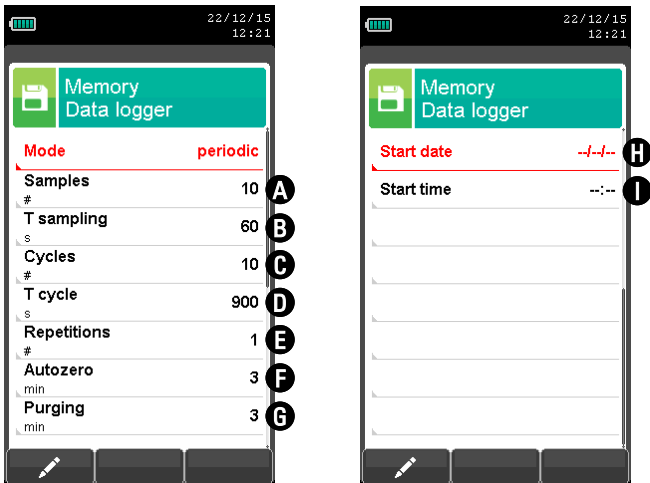

WARNING

- When in periodic mode, the heated line (if included and enabled) is always working.
- The heated line is activated 20 minutes before the analysis starts.

Operating modes relating to the above settings:

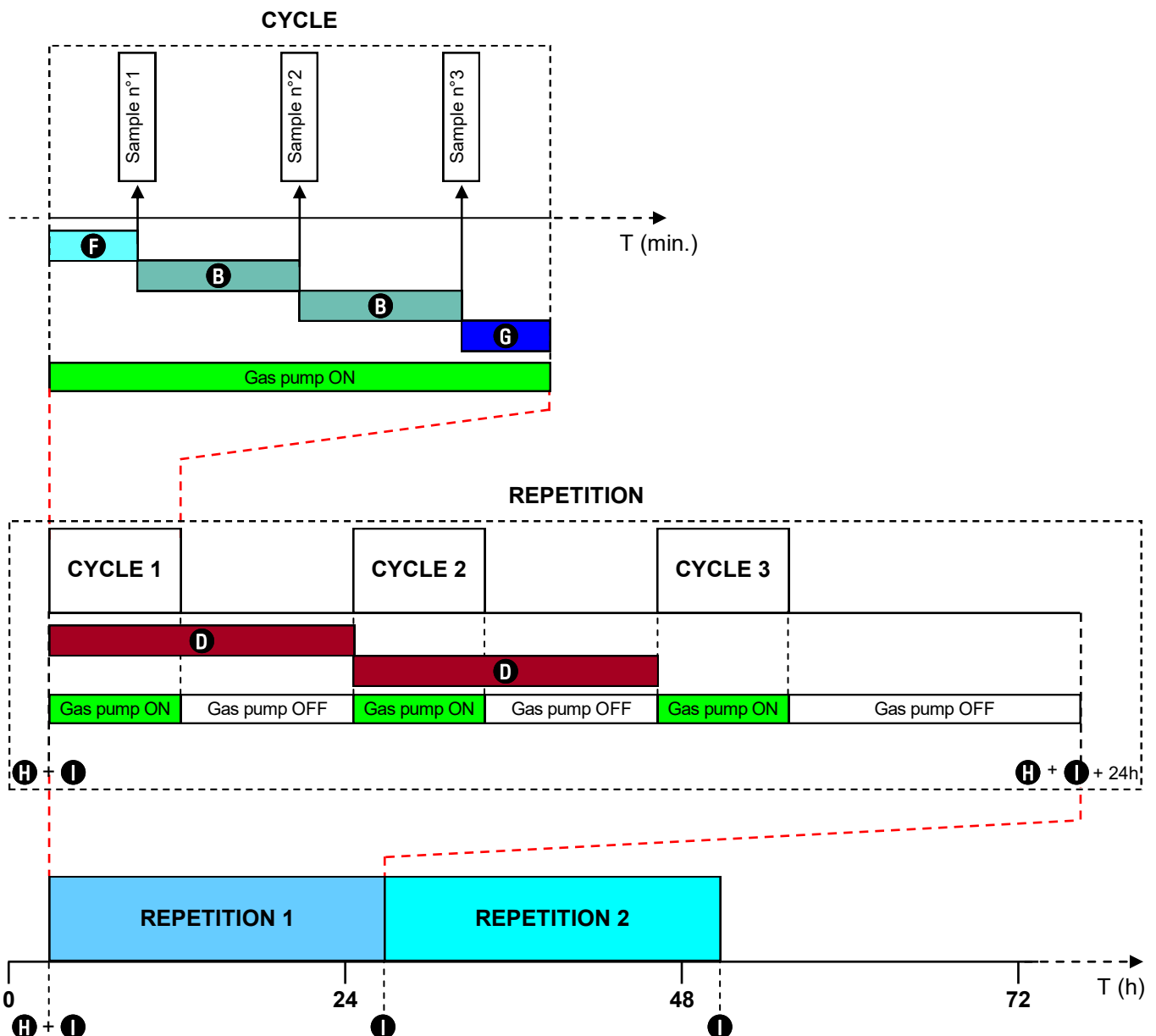

10.6 Memory → Delete

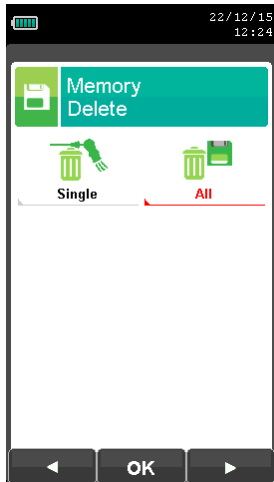

KEY	FUNCTION
	Activate the context keys shown on the display.
	Returns to the previous screen.

CONTEXT KEY	FUNCTION
	Selects the available parameters.
	Enters in the selected parameter setting.
	Selects the available parameters.

PARAMETER	DESCRIPTION
 Single	This option allows the user to delete the contents of each individual memory; to do this, the user will have to confirm the operation so as to avoid losing previously saved data. SEE SECTION 10.6.1.
 All	This option allows the user to delete the contents of all the memories; to do this, the user will have to confirm the operation so as to avoid losing previously saved data. SEE SECTION 10.6.2.



IT IS TO BE CONSIDERED NORMAL THAT THE MEMORIES ERASING PROCESS REQUIRES SOME MINUTES.

10.6.1 Memory→Delete→Single

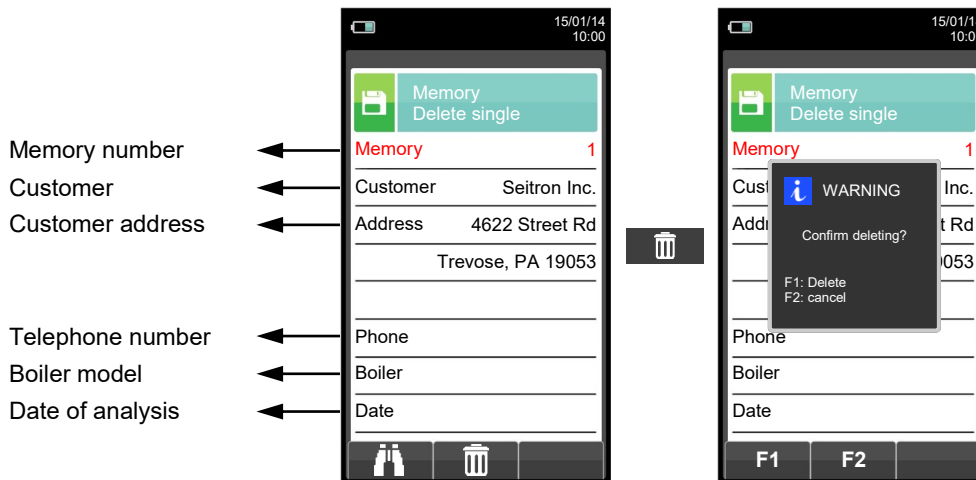

KEY	FUNCTION
	Activate the context keys shown on the display.
	In "edit text"/"search for data"/"search for memory number": it moves the cursor on the box corresponding to the desired letter or number.
	Selects line; the selected line is displayed in red.
	Activates the context key located in the left side of the display. In "edit text": Confirm text insertion.
	Returns to the previous screen.

CONTEXT KEY	FUNCTION
	Search function. Thanks to this function, the user has the possibility to quickly search for a specific analysis. The search can be carried out considering the memory number (by selecting the parameter "Memory"), the customer (by selecting one of the following parameters: "Customer", "Address", "Telephone" or "Generator") or the date (by selecting the parameter "Date").
	Confirms the settings and, if the search function is enabled, it starts the research.
	In "Edit text" it confirms the input of the selected letter or number.
	In "Edit text" it cancels the letter or number that precedes the cursor.
	In "Edit text" it goes from uppercase to lowercase, to symbols, to special characters.
	Selects the memories within the range of the research carried out.
	Selects the memories within the range of the research carried out.
	Starts deleting the selected memory.
	Deletes the selected memory.
	Cancel the deleting and goes back to the previous page.



10.6.2 Memory→Delete→All

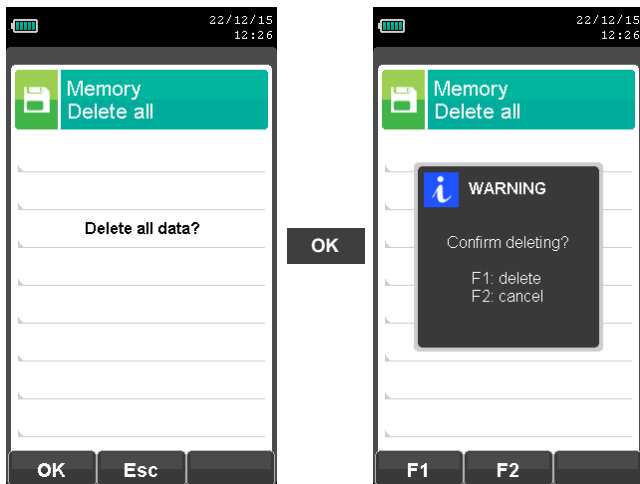

KEY	FUNCTION
	Activate the context keys shown on the display.
	Start erasing all memories.
	Returns to the previous screen.

CONTEXT KEY	FUNCTION
	Start erasing all memories.
	Returns to the previous screen.
	Deletes all memories.
	Cancel the deleting and returns to the previous page.

10.7 Memory→Usage %

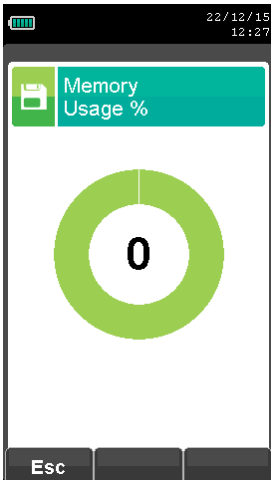

KEY	FUNCTION
	Activate the context keys shown on the display.
	Returns to the previous screen.

CONTEXT KEY	FUNCTION
	Returns to the previous screen.

11.1 Print Menu

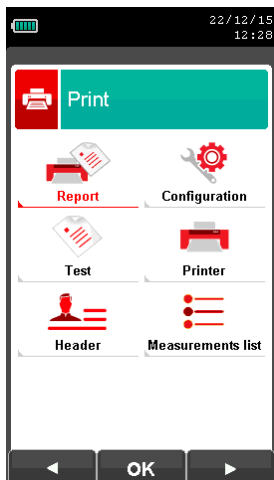

KEY	FUNCTION
	Activate the context keys shown on the display.
	Returns to the previous screen.

CONTEXT KEY	FUNCTION
	Selects the available parameters.
	Enters in the selected parameter setting.
	Selects the available parameters.

PARAMETER	DESCRIPTION
Report	Enables the Print Menu. A hard copy of the complete combustion analysis can be printed. The printed values are those shown on the display when the menu is enabled. This menu can be used for combustion analysis, even when recalled from the memory, for draft, smoke and ambient gas. SEE SECTION 11.2.
Configuration	The user, by means of this menu, can configure the test report format: Copies: Allows to set the number of printed copies and layout of the paper print-out. Several copies of the test paper print-out can be printed, choosing among different layouts according to the information included. Report: The paper print-out layout selection is only valid for combustion analysis and can be chosen among Complete, Partial and Total. Paper print-outs for draft, smoke and ambient gas concentration only allow a specific layout. Layouts options for combustion analysis are specified as described in the following: Full: includes a header with company data as well operator data previously programmed in the configuration menu, measurements sampled in the combustion analysis and, when sampled, the draft, smoke and CO ambient gas values. Partial: only reports the combustion analysis measurement values and information, without any header, comments or blank lines for operator comments. Total: prints full print-out of average values with individual test data. Date/Time: It allows you to define whether or not to print the date and time at which the combustion analysis was performed. Manual: The date and time are not printed in the header of the analysis report . It is the responsibility of the operator to enter the data manually . Auto: The date and time are printed in the header of the analysis report. SEE SECTION 11.3.
Test	Print: Prints a graphical/alphanumeric test paper print-out for a complete check of the printer operation. Paper feed: Feeds paper in the printer; this function is most useful when replacing the paper roll in the printer. SEE SECTION 11.4.
Printer	Selects the printer type: internal or Bluetooth®. When Bluetooth® printer is selected a pairing procedure will be needed in order to match the printer to the instrument. The pairing procedure has to be performed only once. SEE SECTION 11.5.
Header	Allows the user to enter, in six lines of 24 characters each the name of the Company or owner of the device or the information regarding the latter (e.g. address, telephone number), which will be printed in the header of the analysis report. SEE SECTION 11.6.
Measurements list	In this submenu the user has the possibility to view the list of measurements that the device performs. With the interactive keys, the user can add, delete or move a selected measurement. SEE SECTION 11.7.



11.2 Print→Report

```

Date: 15/01/14
Time: 10.10
Fuel: Natural gas
Altitude: 0 m
R.H. air: 50 %
O2          4.2 %
CO2         9.3 %
λ,n         1.25
T flue     190.2 °C
T air      15.4 °C
dT         174.8 °C
QS          8.6 %
Es          91.4 %
Ec          4.9 %
Et          96.3 %
CO          148 ppm
NO           40 ppm
NOX/NO:     1.03
NOX         41 ppm
CO amb      0 ppm
Draft:      0.05 hPa
T out:      20 °C
Smoke:      3 1 2
Aver. n:    2
    
```

KEY	FUNCTION
	Activate the context keys shown on the display.
	Returns to the previous screen.

CONTEXT KEY	FUNCTION
	Starts printing the test paper print-out.
	Stops printing the test paper print-out.



11.3 Print→Configuration

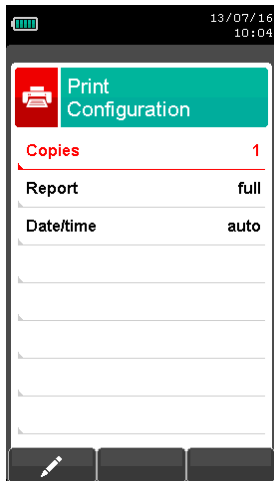

- Set the number of copies to print: 1 .. 5.
- The test paper print-out models that can be selected are: **partial - full - total**
For further details see Annex A.
- Set between: **Manual:** date and time are not printed on the analysis report.
Auto: date and time are printed automatically on the analysis report.

KEY	FUNCTION
	Activate the context keys shown on the display.
	Selects line; the selected line is displayed in red. In modification sets the value or the desired mode.
	Activates the context key located in the left side of the display.
	Returns to the previous screen. When in modify mode cancels the modification just made.

CONTEXT KEY	FUNCTION
	Enters the modification mode for the selected parameter.
	Confirms the settings.

Example:

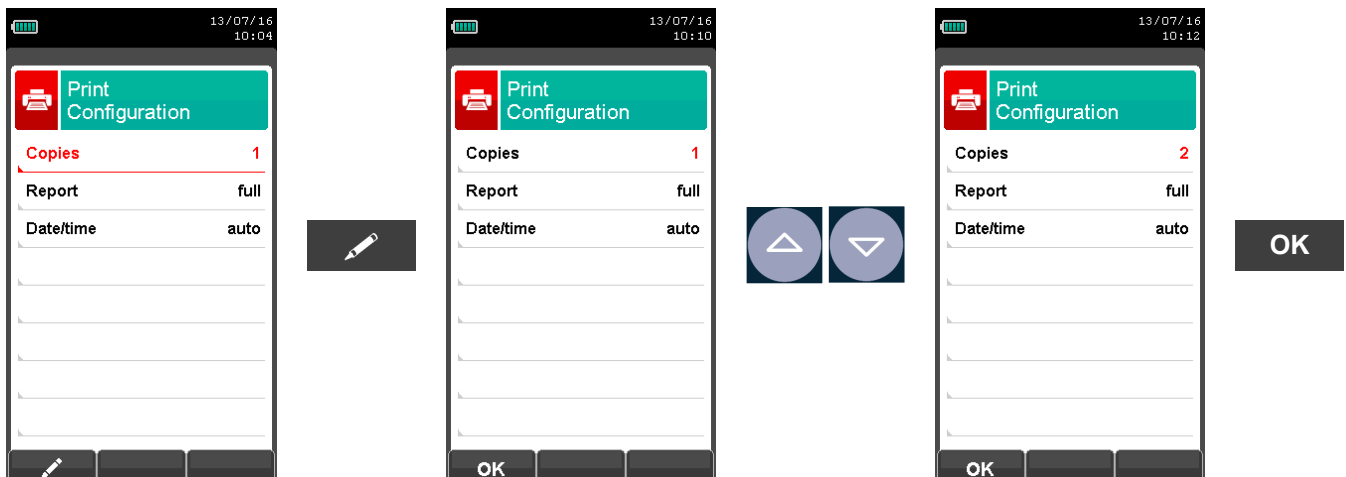



11.4 Print→Test



KEY	FUNCTION
	Activate the context keys shown on the display.
	Selects line; the selected line is displayed in red. In modification sets the value or the desired mode.
	Activates the context key located in the left side of the display.
	Returns to the previous screen. When in modify mode cancels the modification just made.

CONTEXT KEY	FUNCTION
	Confirms the settings.

Example:

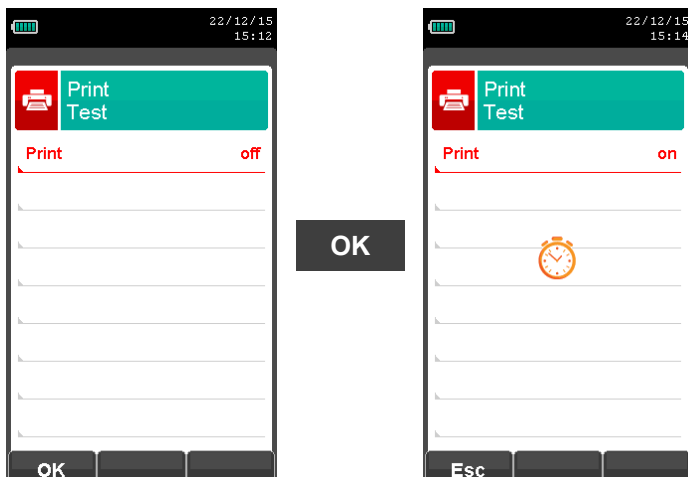



11.5 Print→Printer

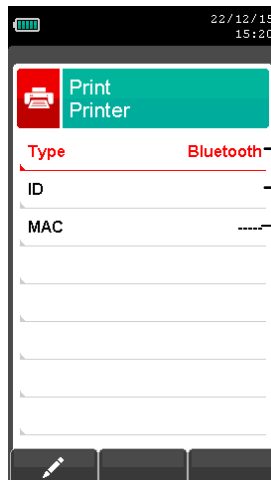
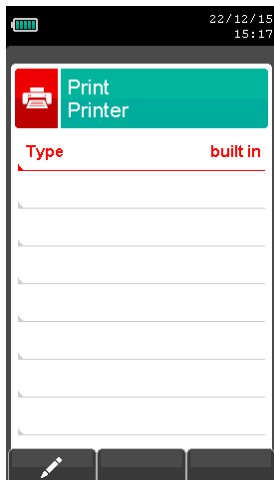

- Printer type: **built in (internal)/Bluetooth® (external)**.
- Name of the Bluetooth® printer associated with the instrument.
- Address of the Bluetooth® printer associated with the instrument.

WARNING

If you select the Bluetooth® printer, you will need to pair the instrument to a Bluetooth® printer. The pairing procedure must be performed once only.

KEY	FUNCTION
	Activate the context keys shown on the display.
	Selects line; the selected line is displayed in red. In modification sets the value or the desired mode.
	Activates the context key located in the left side of the display.
	Returns to the previous screen. When in modify mode cancels the modification just made.

CONTEXT KEY	FUNCTION
	Enters the modification mode for the selected parameter.
	Confirms the settings.

11.5.1 Print→Pairing

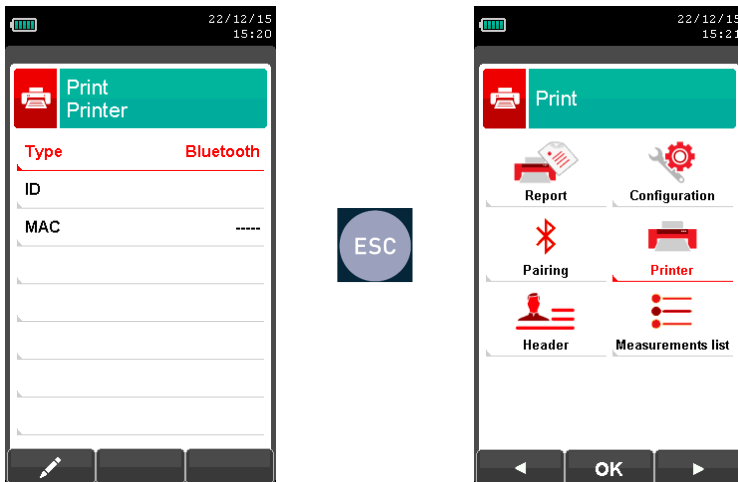

KEY	FUNCTION
	Activate the context keys shown on the display.
	Selects line; the selected line is displayed in red. In modification sets the value or the desired mode.
	Activates the context key located in the left side of the display.
	Returns to the previous screen. When in modify mode cancels the modification just made.

CONTEXT KEY	FUNCTION
	Selects the available parameters.
	Enters in the selected parameter setting.
	Selects the available parameters.
	Starts the search for Bluetooth® devices.
	Quits and returns to the previous screen.
	Enters the modification mode for the selected parameter.
	Repeats the pairing procedure.
	Confirms the settings.
	Confirms the selected letter or digit.
	Cancels the letter or digit before the cursor.
	Cycles through uppercase, lowercase, symbols and special characters.

In the following pages the pairing procedure between the instrument and a Bluetooth® printer is described.



1. Once the Bluetooth® printer is configured, proceed as follows:

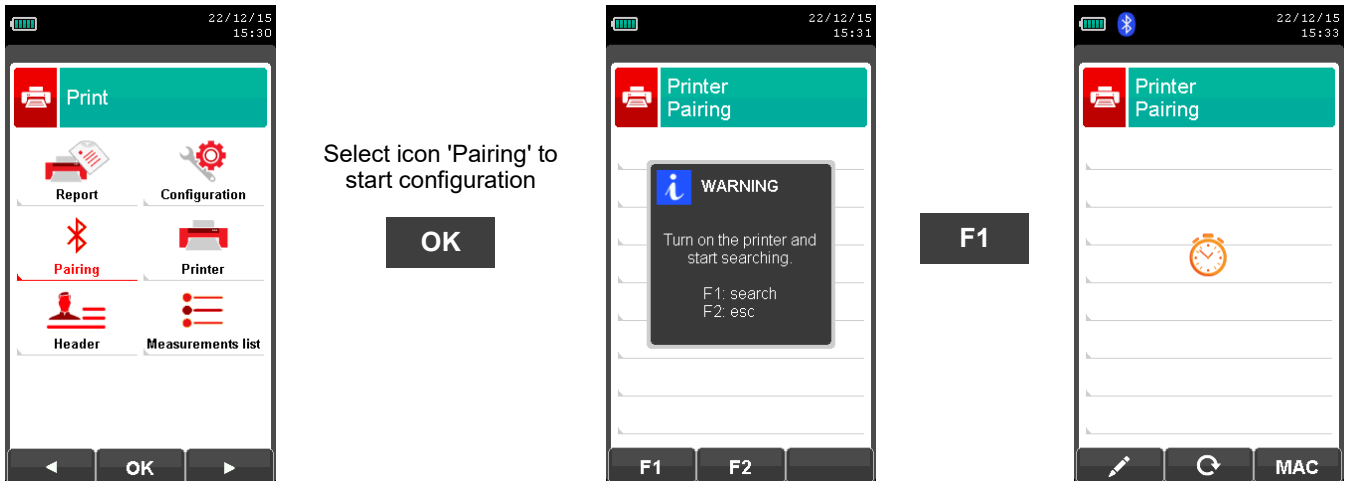

2. Select the line corresponding to the desired Bluetooth® printer, then proceed as follows:

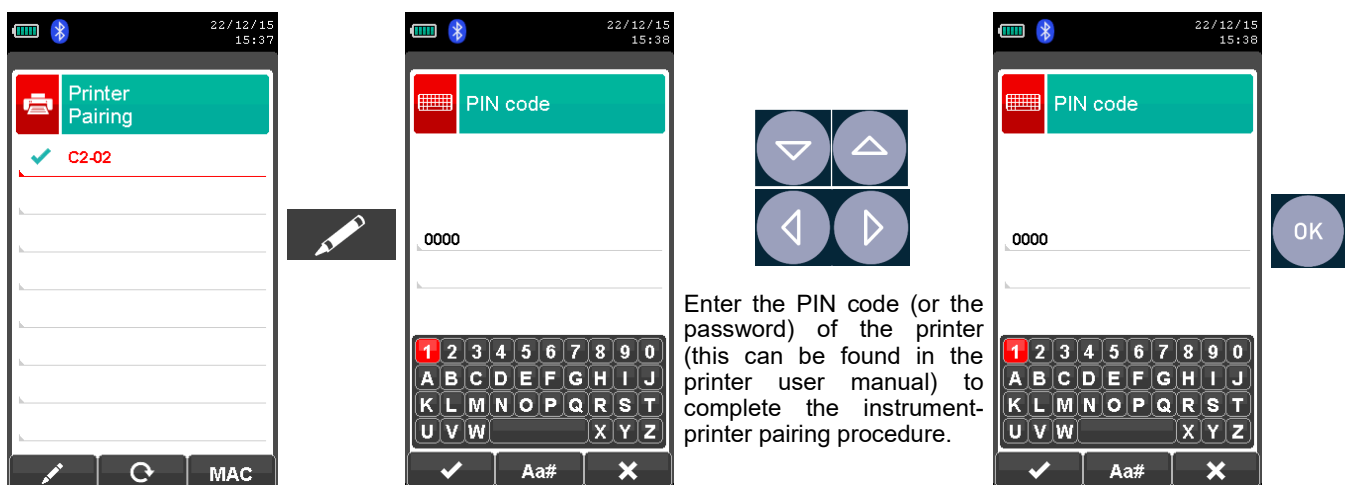

3. The instrument-printer pairing is completed. Press key '  ' to return to the previous screen.



11.6 Print→Header

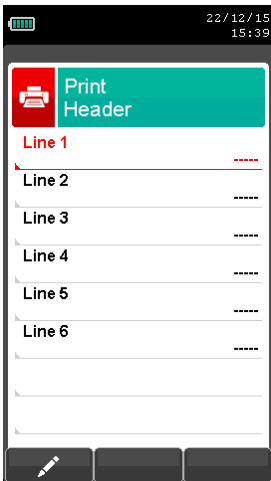

KEY	FUNCTION
	Activate the context keys shown on the display.
	In "edit text": It moves the cursor on the box corresponding to the letter or number required to form the desired word.
	In edit mode it moves the cursor through the available lines.
	In "edit text": it confirms the text input. In "Print header": It activates the context key displayed on the left.
	Returns to the previous screen. In "edit text" it goes back to the previous screen without saving the changes made.

CONTEXT KEY	FUNCTION
	Enters edit mode of the selected line: it is possible to enter the name of the operator (24 characters available).
	Confirms the selected letter or digit.
	Cancel the letter or digit before the cursor.
	Cycles through uppercase, lowercase, symbols and special characters.



Example:

1. Edit text

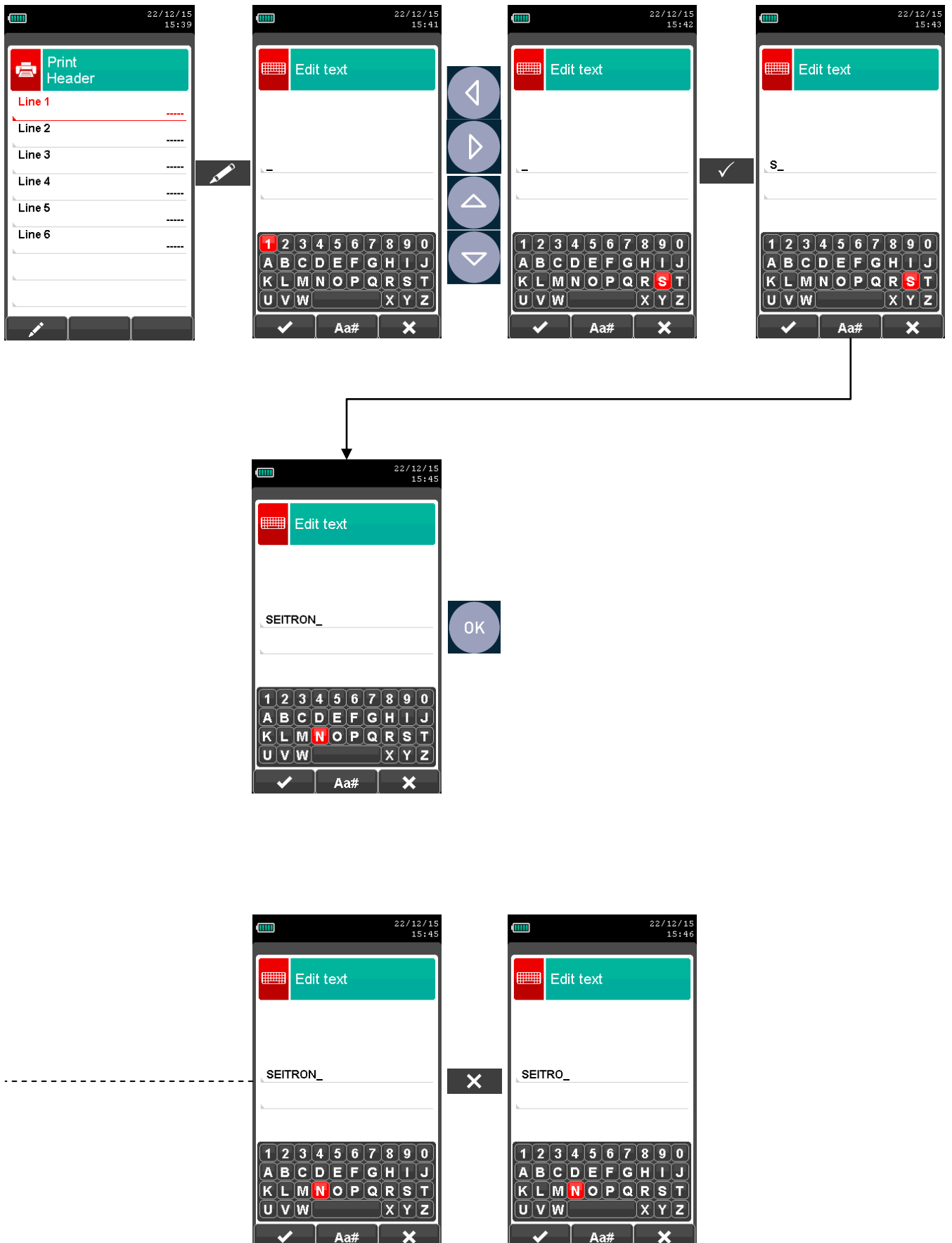



11.7 Print→Measures list

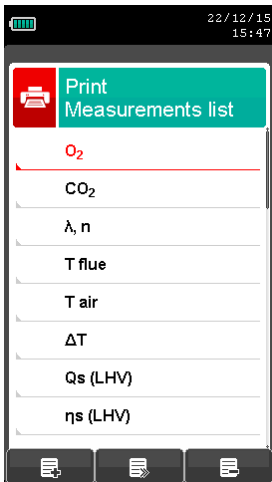

KEY	FUNCTION
	Activate the context keys shown on the display.
	Selects the available measurements from the suggested list. In edit mode, it scrolls through the measurements present.
	Confirms the modification.
	When pressed in modify mode cancels the selection made, otherwise returns to the previous screen.

CONTEXT KEY	FUNCTION
	Adds a measurement.
	Moves the position of a measurement.
	Deletes a measurement from the list.
	Scrolls through the available measurements.
	Confirms the change made.
	Scrolls through the available measurements.
	Cancels the change made.



Example:

1. Add a measurement to the list

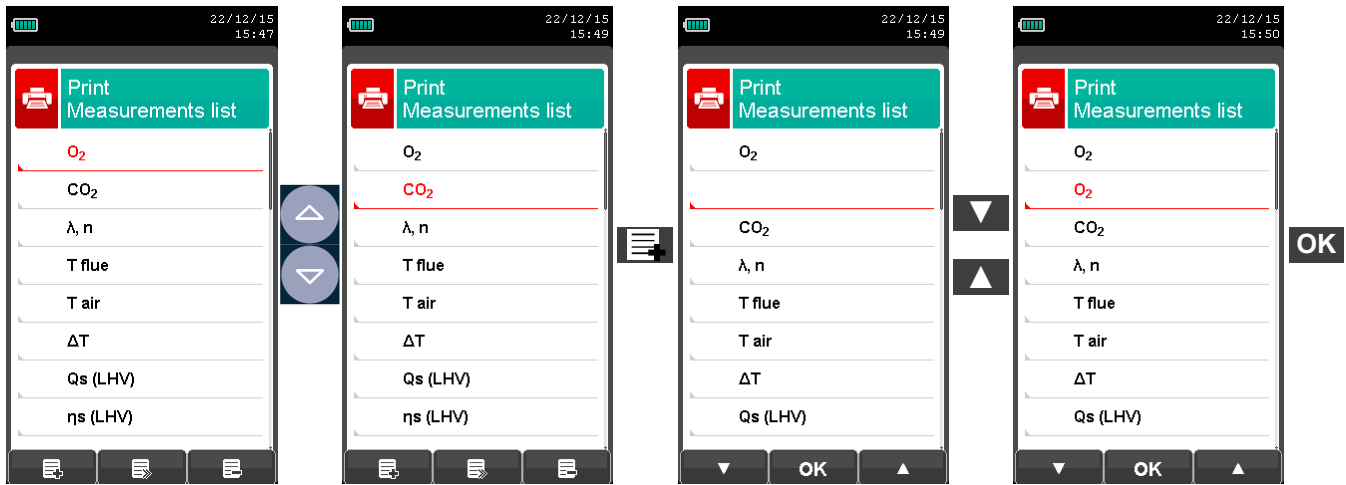

2. Move the position of a measurement

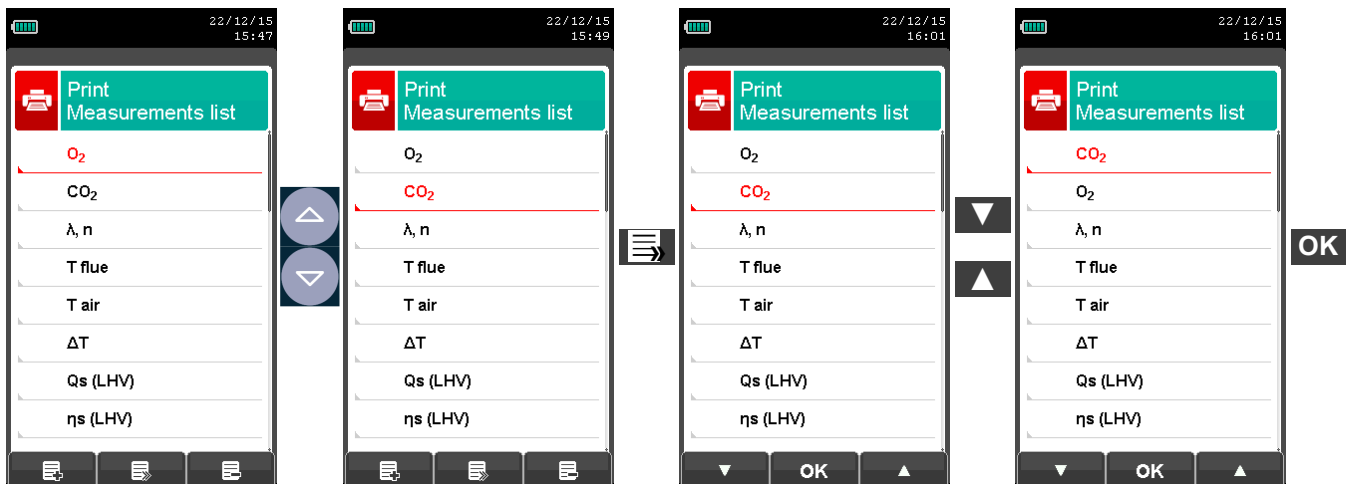

3. Deletes a measurement from the list

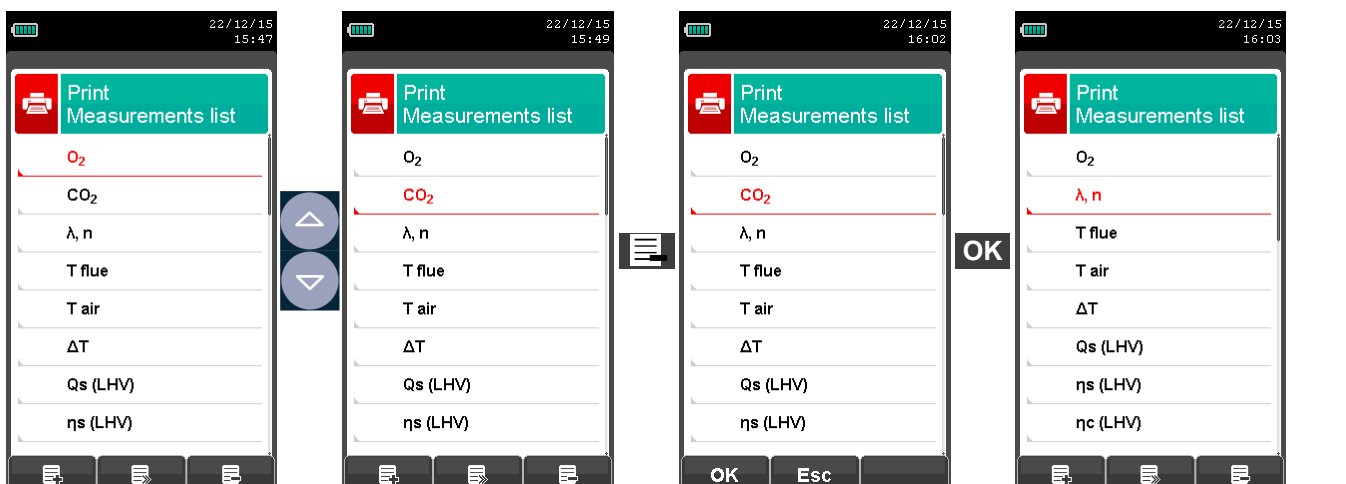



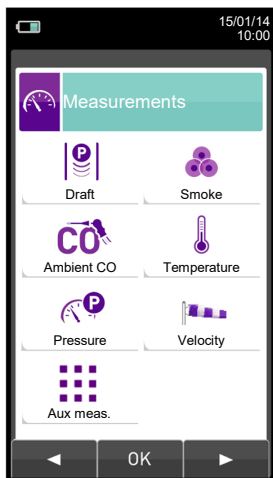

12.1 Measurements Menu



KEY	FUNCTION
	Activate the context keys shown on the display.
	Returns to the previous screen.
CONTEXT KEY	FUNCTION
	Selects the available parameters.
	Enters in the selected parameter setting.
	Selects the available parameters.

PARAMETER	DESCRIPTION
 Draft	<p>The DRAFT menu gives access to the stack draft measurement. Being a negative pressure draft must be measured using the negative pressure input P-. The correct values for a natural draft boiler are therefore positive by definition. Before performing the measurement the instrument allows the user to input the external air temperature as required by the standard. When making the measurement and the temperature has been inserted, the instrument provides a stack draft value related (P diff ref) to the external temperature of 68° F as requested by law. When the inserted external temperature is higher than 68° F the instrument reports a stack draft value reference equal to the measured draft. Afterwards the user can acquire the value displayed in order to add it to the running analysis measurements or, alternatively, print the relevant paper print-out through the 'PRINT' menu.</p> <p>NOTE: The measurement may not be accurate due to condensation inside the gas probe. Should you notice an inaccurate or unstable reading on the instrument, it is advisable to disconnect the gas probe from the instrument itself, and purge pipes by blowing with a compressor. In order to be sure there is no humidity, it is suggested to perform the measurement by means of the transparent rubber pipe supplied on issue.</p> <p>SEE SECTION 12.2.</p>
 Smoke	<p>It is possible to enter the data concerning one to three Smoke Tests measurements taken by means of an optional device (AAPM02–Manual Smoke Pump Kit); see the relevant instructions. The method consists in taking a certain quantity of combustion gas from the middle of the flue behind the surfaces of the exchangers at the end of the boiler, and make it pass through a special filter paper. The soot stain obtained is compared with the surfaces blackened in a different way according to a comparison scale; it is thus determined the "soot number", which will be entered in the instrument by hand.</p> <p>These measurements can be either stored in memory together with the combustion analysis data or printed on a paper print-out.</p> <p>SEE SECTION 12.3.</p>
 Ambient CO	<p>This type of analysis lets the user measure the CO value present in the environment, with the scope of checking the personal safety conditions of a specific working environment. The instrument leaves our factory with the following preset threshold values:</p> <p>COmax: 35 ppm Recommended exposure limit (REL) stipulated by the National Institute for Occupational Safety and Health (NIOSH), equivalent to 40 mg/m³ and calculated as an 8-hour Time-Weighted Average (TWA).</p> <div style="display: flex; align-items: center;"> <p>Make sure to perform to perform the autozero in a clean air environment (preferably outdoors), so that the ambient CO measurement is correct. It is advisable to turn on the instrument and wait for the autozero completion outside the area where the test is being performed.</p> </div> <p>The instrument allows to carry out ambient CO measurements only by means of sensors for low CO concentrations.</p> <p>SEE SECTION 12.4.</p>



PARAMETER	DESCRIPTION
 Temperature	<p>With this menu it is possible to measure the temperature of the supply water, by means of an OPTIONAL thermocouple K-type contact probe to be connected to the input T1. Also, it is also possible to measure the temperature of the return water, by connecting an OPTIONAL thermocouple K-type contact probe to be connected to the input T2. With the function ΔT it is possible to obtain the relevant temperature difference.</p> <p>SEE SECTION 12.5.</p>
 Pressure	<p>It is possible, through the use of the external flexible pipe made in RAUCLAIR (supplied), to measure a pressure value within the range stated in the technical features (connect the pipe to P+ input). During the pressure measurement the 'HOLD' function is made available, which allows to 'freeze' the value shown on the display, by pressing 'HOLD' key.</p> <p>SEE SECTION 12.6.</p>
 Velocity	<p>When a Pitot tube and a Tc-K thermocouple are connected, the instrument is capable to measure at the same time both temperature and velocity of a gas (air/flue gas).</p> <p>SEE SECTION 12.7.</p>
 Aux. Meas.	<p>Through this menu the user can access additional measures.</p> <p>SEE SECTION 12.8.</p>

12.2 Measurements → Draft

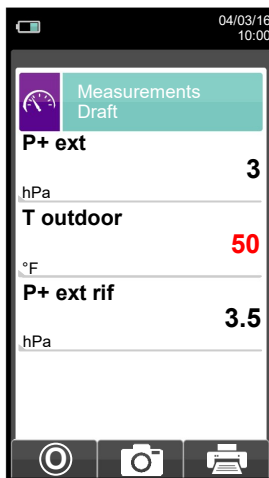
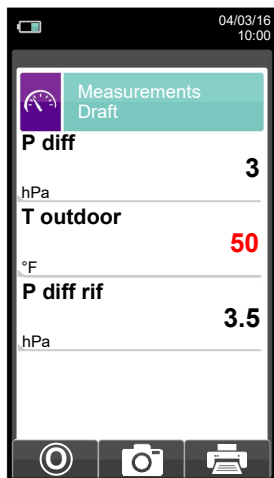

This screen is shown if a draft gauge is used to measure the draft.

KEY	FUNCTION
	Activate the context keys shown on the display.
	Sets the value of the external temperature.
	Returns to the previous screen.

CONTEXT KEY	FUNCTION
	The activation of one of these keys starts the Draft measurement.
	Carries out pressure zeroing.
	Saves, in the memory selected in the "Memory Select" menu, the value of the draft measured.
	Starts printing the test paper print-out. See section 11.

To measure the draft proceed as follows:

- Connect the probe pressure input hose to the instrument **P-** input.
- Enter the external air temperature.
- Before starting the pressure zeroing sequence pay attention to remove the gas probe from the stack.
- Having carried out the pressure zeroing sequence, insert the probe in the stack and measure the draft.
- The draft values to be stored in the memory must be acquired before storing the analysis data.
- To attach the draft value to the readings of the current analysis, activate the "save" function ' '.
- To print the test paper print-out with the value of the draft, activate the function ' '.
- It is possible to cancel an acquired draft from the memory; to overwrite a new one, activate the "save" function again ' '.
- After saving the draft measurement, to carry out the combustion analysis, press the key ' '.

12.3 Measurements → Smoke



Smoke measurement with manual pump kit.

Smoke measurement with heated head.

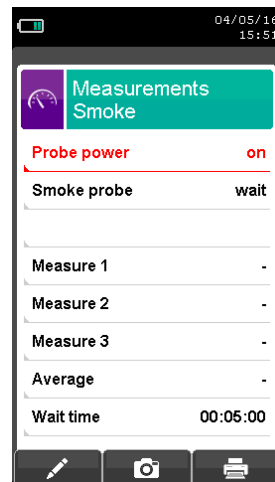
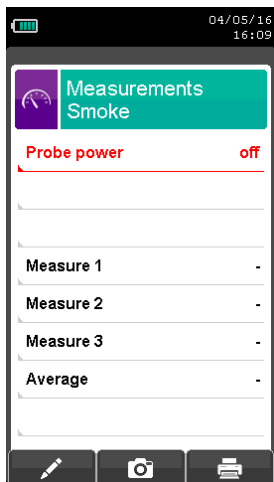

KEY	FUNCTION
	Activate the context keys shown on the display.
	Sets the "soot number" found by the device when measuring the carbon black.
	Also activates the context key located in the lower left side of the display.
	Returns to the previous screen.

CONTEXT KEY	FUNCTION
	Enters the modification mode for the selected parameter.
	Starts measurement (only when the heated head probe for smoke is used).
	Confirms the value entered.
	Saves, in the memory selected in the "Select Memory" menu, the values entered.
	Starts printing the paper print-out. See section 11.



- Perform the smoke measurements with the proper manual pump or with the heated head probe.

Enter the values found.

- The values of the carbon black that you want to save must be acquired before saving the analyses.

- To join the values of the carbon black to the measurements of the current analysis use the ' ' function.
- To print the paper print-out with the measurement of the carbon black, activate the ' ' function.
- It is possible to delete the values of the carbon black acquired in the memory by overwriting them by activating the ' ' function again.
- After saving the carbon black values, to carry out the combustion analysis, press the key ' '.

12.3.1 Smoke measurement with manual pump kit (optional) AAPM02 – Manual Smoke Pump Kit

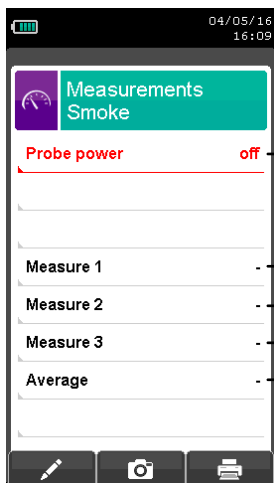

- When manual pump kit is used set to ' off ' the probe power supply.
- 1st measurement value, to be entered manually.
- 2nd measurement value, to be entered manually.
- 3rd measurement value, to be entered manually.
- Average value of the above measurements, automatically calculated by the instrument.

12.3.2 Test performance with the manual soot pump

Before using the product, please read this operating manual carefully and keep it ready to hand, when required.

Field of application

The soot pump serves for determining the smoke spot number of oil burning installations (diesel soot).

Basic safety instructions

!!! Be careful about the measures !!!

- Before using the soot pump, warm it up to room temperature.
- After approx. 10 measurements, check the withdrawal probe up to the valve for soot deposit and clean it. In regular intervals, this also applies for the other parts of the flue-gas pump (Maintenance of the pump).
- Occasionally test the soot pump for leaks (see: Testing the pump for leaks). It is recommended to keep the soot picture comparison scale always in its wrapper and thus clean.

!!! Ensure warranties!!!

- It is precondition, that the soot pump is exclusively used appropriate and according to the intended use.
- Do not apply force to the testing instrument. (It may not defend against it!)

Test operation

Sampling of soot

Before taking the soot sample, the burner should Already be in operation for at least 5 minutes.

- A. Insert the filter paper in the slot opening on the pump head and clamp it with a clockwise rotation of the probe head.
- B. Bring the probe tube through the measuring vent of the exhaust pipe in the middle of the flue-gas flow.
- C. **Perform 10 full suction strokes;** draw slowly and uniformly (suction stroke), shortly pause at the stop (pressure equalization), than move back fast. According to the prescription, 1.63 +/- 0.07dm³ exhaust gas are thereby drawn through the filter paper.
The operation time of the 10 strokes has to be 40-60 seconds.
- D. Release the probe head with a left-hand rotation and extract the filter paper stripe. A measuring spot with the corresponding coloring remains on the filter paper. For being able to determine the smoke spot number of a fireplace, at least 3 samples have to be taken! The smoke spot number than is averaged out of them (see: Determination of the smoke spot number).

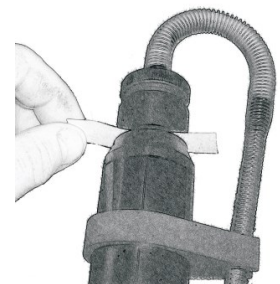

In case of a sluggish operation of the pump, lubricate the piston packing (see: Lubrication of the soot pump)!



Test for oil derivate

A. Test the measuring spot for oil-derivate. For that purpose, drop some solvent system acetone close to the measuring spot. If there is no grey coloration, no oil is contained. The sample is correct.

Otherwise

If there is a grey coloration of the measuring spot: The exhaust gas contains oil! Inspect the oil burning installation!

B. Hold the filter paper with the measuring spot behind the grey scales of the soot picture comparison scale until the spot appears fully in center and read off the smoke spot number. The shade of grey most looking similar to the measuring spot density shows the smoke spot number.

C. Now average over the smoke spot numbers of all samples withdrawn. This value, round up to the next whole number, is the value respectively the smoke spot number of the installation.

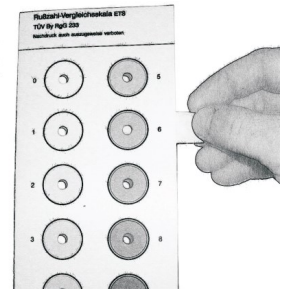

Maintenance

Cleaning of the soot pump

Remove lightly adhering soot particles:

- For this purpose, make some expeditious pump strokes with the pump, the probe head slightly drawn and no filter paper inserted. With it, lightly adhering dirt also peels away from the valve.

Disassembly of the soot pump:

- Unscrew the cylinder cap with left-hand rotation.
- Carefully pull the piston out of the cylinder. Pay attention not to damage the piston packing on the thread inside of the cylinder!

For cleaning the piston package, in no case take it off the piston rod!

- Unscrew the probe head with left-hand rotation.
- Screw off the valve using the enclosed key through left-hand rotation. Put the key securely into the borehole.

For removing lubricant residues, use only cleaning agents not affecting plastic material!

- Strongly effloresced piston rods may be cleaned with fine-grained sandpaper.
- Clean the pump components with a cloth or a suitable brush.

Lubrication of the sooth pump

Before lubricating the relevant parts of the soot pump, it has to be cleaned (see: Cleaning of the soot pump)!

For lubricating the pump use only the provided lubricating oil! Do not apply too much lubricating oil! Do not use lubricants containing mineral oil!

- Insert somewhat oil in the cylinder. Apply and distribute lubricating oil on the piston packing and than mount it.
- Move the piston in the cylinder until it is smooth running.
- Mount the remaining components.

Testing the pump for leaks

- Turn the probe head under slight pressure to the valve support (clockwise rotation / clamping position)
- Hold the pump with handle towards the body so, that the probe tube may be closed with the thumb (Of course you may also use other accessories for closing the probe tube.)
- Pull the pump piston on the handle out for approx. 3-5 cm and let it loose. The handle should spring back in its initial position: The pump is sealed.

or

- The handle does not spring back in its initial position: The pump is leak.

Possible causes:

- rubber hose defect
- valve / valve gasket is not OK
- crack in the piston packing



12.3.3 Smoke measurement with heated head probe (optional)



- When the heated head probe is used for smoke measurement set to ' on ' the probe power supply.
- Probe status: Wait (heating up) or Ready (probe is ready for measurement) or Measurement (acquisition).
- 1st measurement value, to be entered manually.
- 2nd measurement value, to be entered manually.
- 3rd measurement value, to be entered manually.
- Average value of the above measurements, automatically calculated by the instrument.
- Residual wait time.

12.3.4 Smoke probe with heated head operation

- Unscrew the protective cap from the nozzle of the probe.
- Insert the nozzle on the probe grip, aligning the male connector of the nozzle with the female connector of the grip and screw the over-seal.

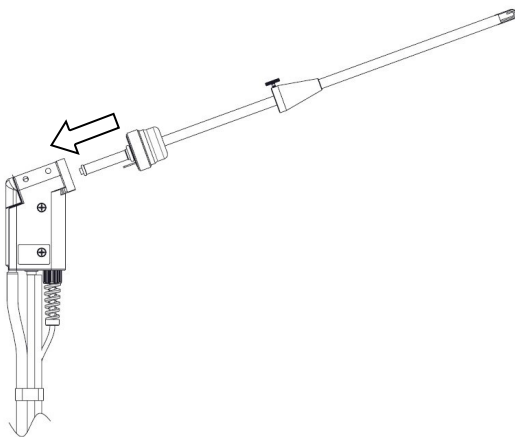

- Push the grip of the probe, so to open the where the paper black smoke filter will be inserted.
- The filter is to be inserted in the seat until it touches the bottom of the seat, as shown in the figure below.

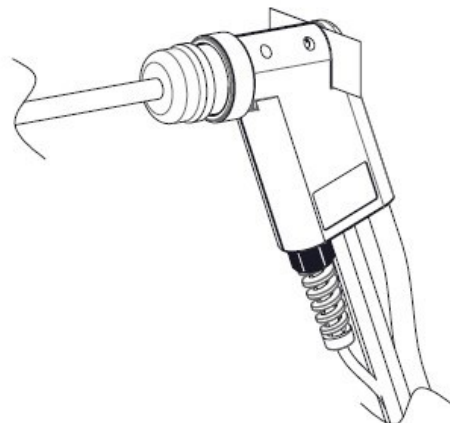
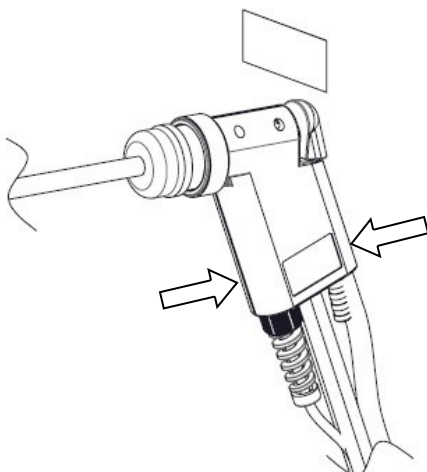

12.3.5 Connecting the heated head probe for smoke measurement

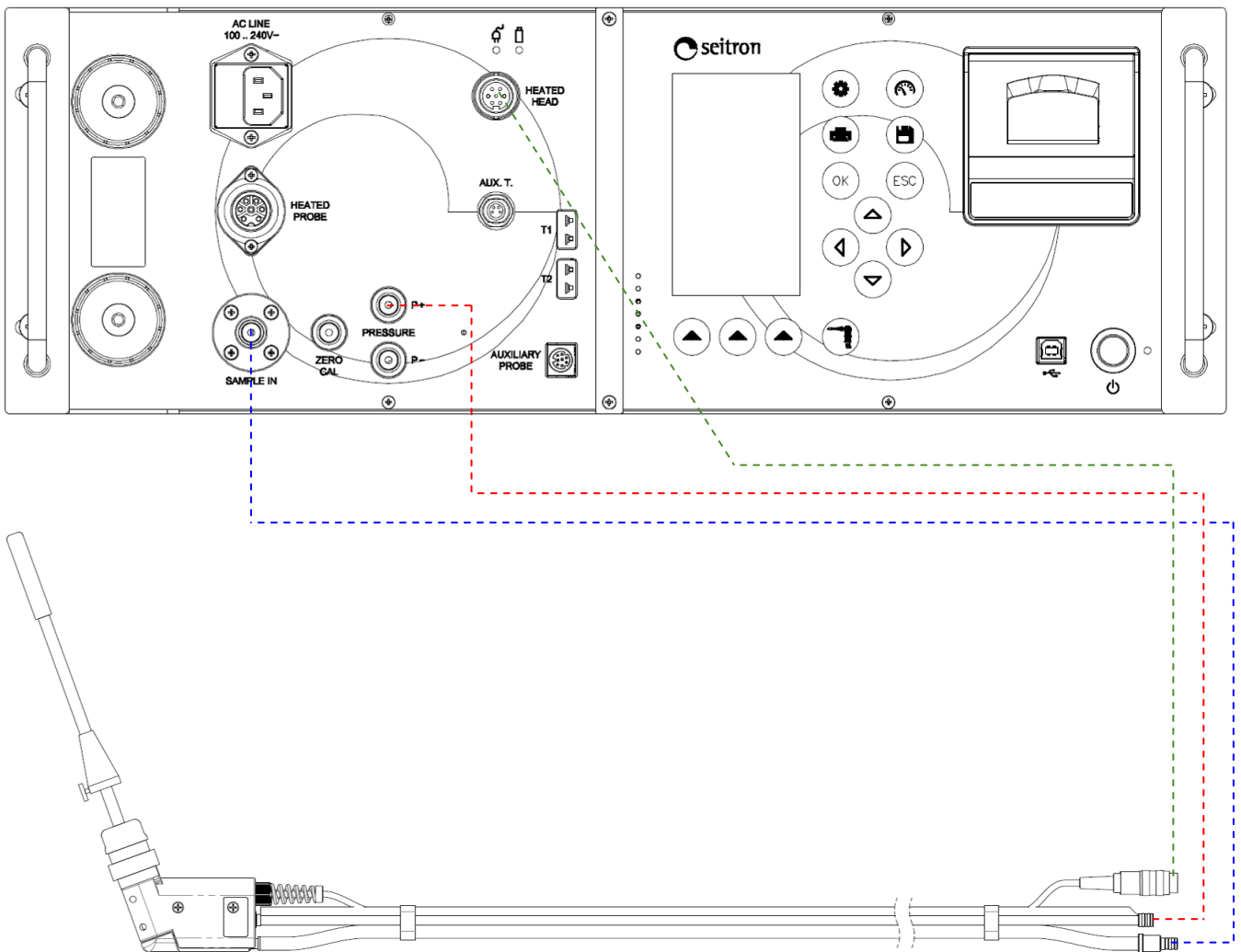

Heated head probe for smoke measurement: (AASX04 / AASX05).

12.3.6 Performing the test with the smoke probe

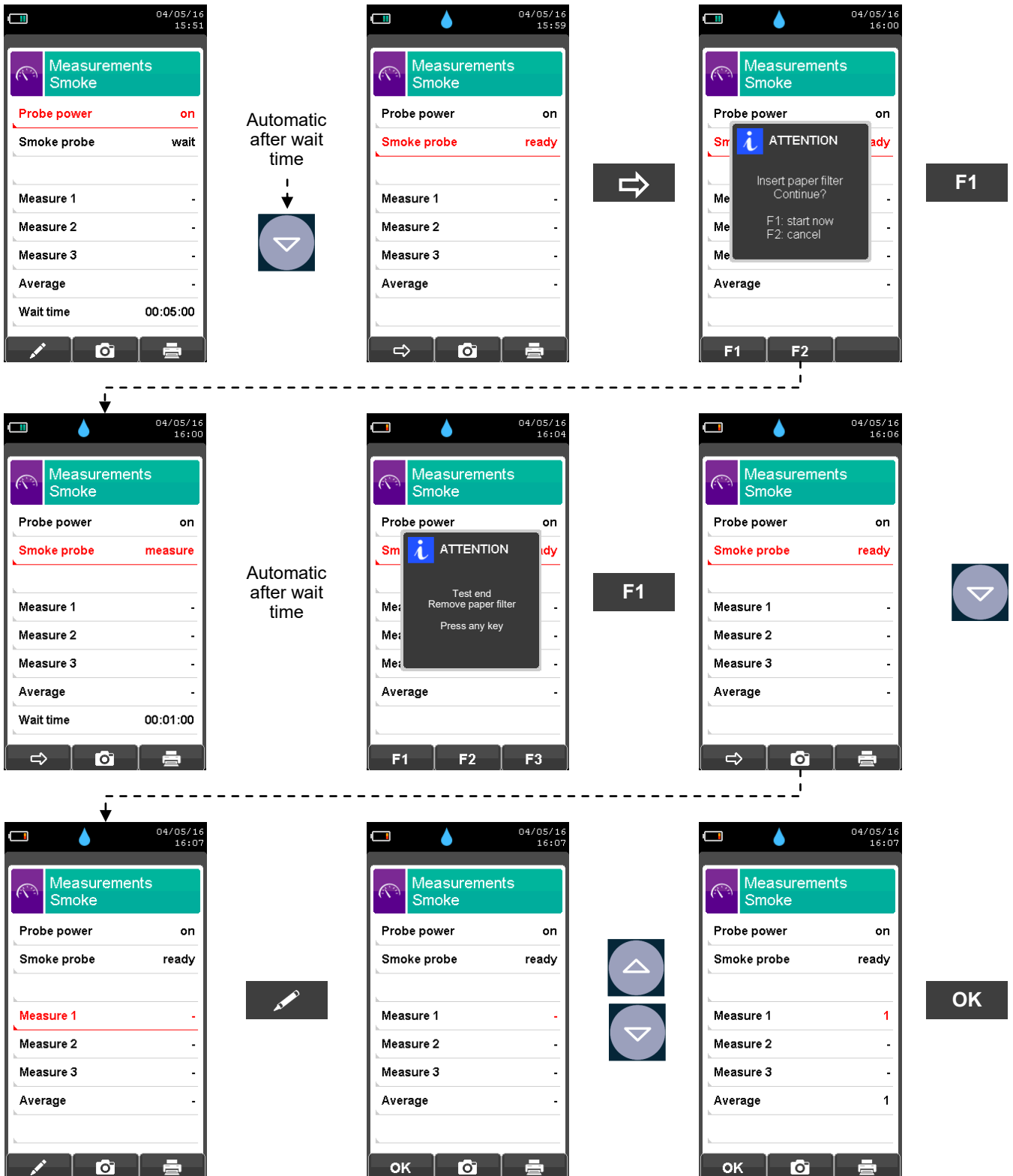

In order to perform additional measurements, please repeat all the described operations.

12.4 Measurements → Ambient CO

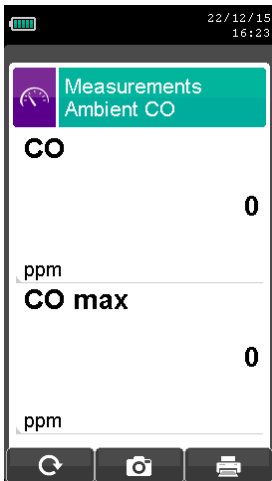





KEY	FUNCTION
	Activate the context keys shown on the display.
	Returns to the previous screen.

CONTEXT KEY	FUNCTION
	Updates the measurement.
	Saves, in the memory selected in the "Select Memory" menu, the data acquired.
	Starts printing the paper print-out. See section 11.



Make sure to perform to perform the autozero in a clean air environment (preferably outdoors), so that the ambient CO measurement is correct. It is advisable to turn on the instrument and wait for the autozero completion outside the area where the test is being performed.

- The values of the ambient CO that you want to save must be acquired before saving the analyses.
- To join the values of the ambient CO to the measurements of the current analysis use the '' function.
- To print the paper print-out with the measurement of the ambient CO, activate the '' function
- It is possible to delete a draft value acquired by the memory by overwriting it by activating the '' function again.
- After saving the draft values, to carry out the combustion analysis, press the key ''.



12.5 Measurements → Temperature

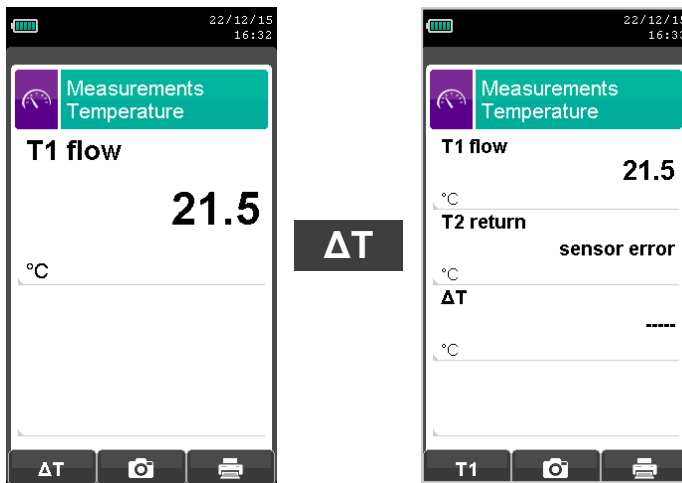

KEY	FUNCTION
	Activate the context keys shown on the display.
	Returns to the previous screen.

CONTEXT KEY	FUNCTION
	Accesses the acquisition of the temperature difference between the supply water (measured by the probe connected to the connector T1 of the device) and the return water (measured by the probe connected to the connector T2 of the device).
	Goes back to the visualization of the supply water temperature.
	Saves, in the memory selected in the "Select Memory" menu, the data acquired.
	Starts printing the paper print-out. See section 11.



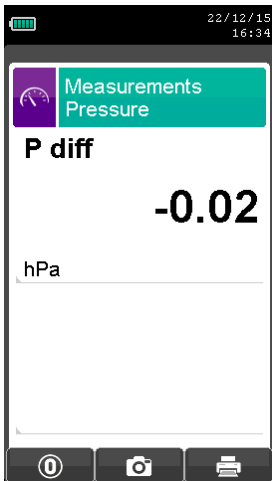

12.6 Measurements → Pressure





Measurement of the differential pressure by means of the internal pressure sensor (piezoresistive, temperature compensated).



Measurement of the pressure by means of an external micromanometer.

KEY	FUNCTION
	Activate the context keys shown on the display.
	Returns to the previous screen.

CONTEXT KEY	FUNCTION
	Performs pressure zeroing.
	Saves, in the memory selected in the "Select Memory" menu, the data acquired.
	Starts printing the paper print-out. See section 11.



12.7 Measurements → Velocity

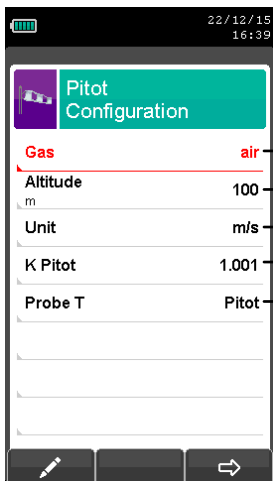

- Measurement: air or flue gas.
- Altitude above sea level.
- Measurement unit selectable across m/s, km/h, fpm, mph.
- Insert the K-factor of the Pitot tube stated by the tube manufacturer.
- Temperature acquisition mode:
Pitot (with Tc-K thermocouple) or Flue gas probe (or external Tc-K thermocouple).

KEY	FUNCTION
	Activate the context keys shown on the display.
	Selects line; the selected line is displayed in red. In edit mode, it sets the desired value.
	Activates the context key located in the left side of the display.
	Returns to the previous screen. When in modify mode cancels the modification just made.

CONTEXT KEY	FUNCTION
	Enters the modification mode for the selected parameter.
	Confirms the value entered.
	Go to next step.
	Make the zero for the measurement.
	Saves, in the memory selected in the "Select Memory" menu, the data acquired.
	Starts printing the paper print-out. See section 11.



12.7.1 Connecting the Pitot tube to the instrument

- Connect the Pitot tube (accessory) to inputs P+ and P- (which are normally used for the differential pressure measurement)
- Connect the Tc-K thermocouple cable from the flue gas probe to connector T1 of the instrument.

WARNING: When a Pitot tube integrated to a Tc-K thermocouple is used, remember to connect the thermocouple connector to T1 input at instrument side. In this case the flue gas probe must not be connected.

NOTE: the hoses associated to static and dynamic pressure can be connected either to the inputs P+ or P-

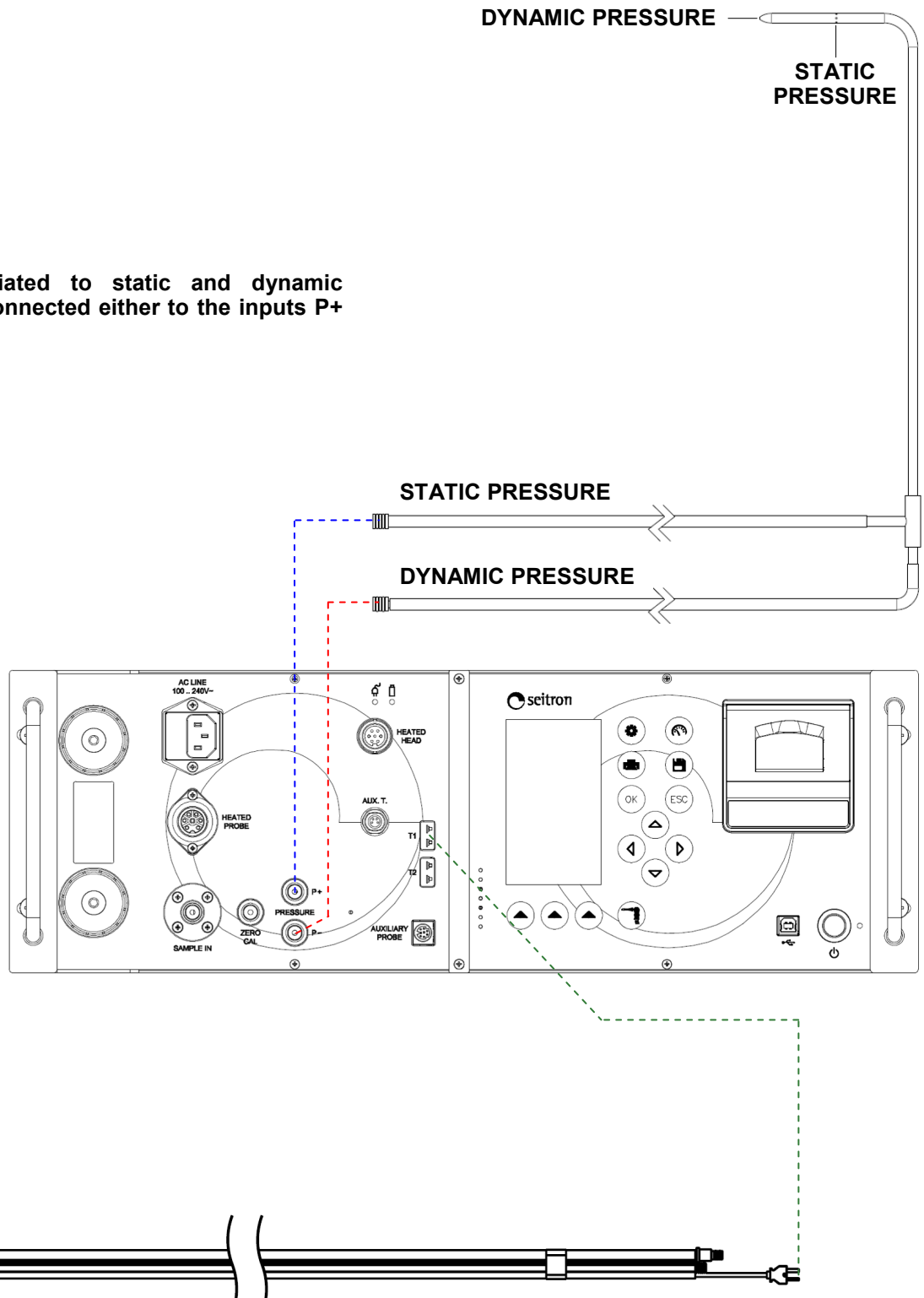

12.7.2 PERFORMING THE TEST

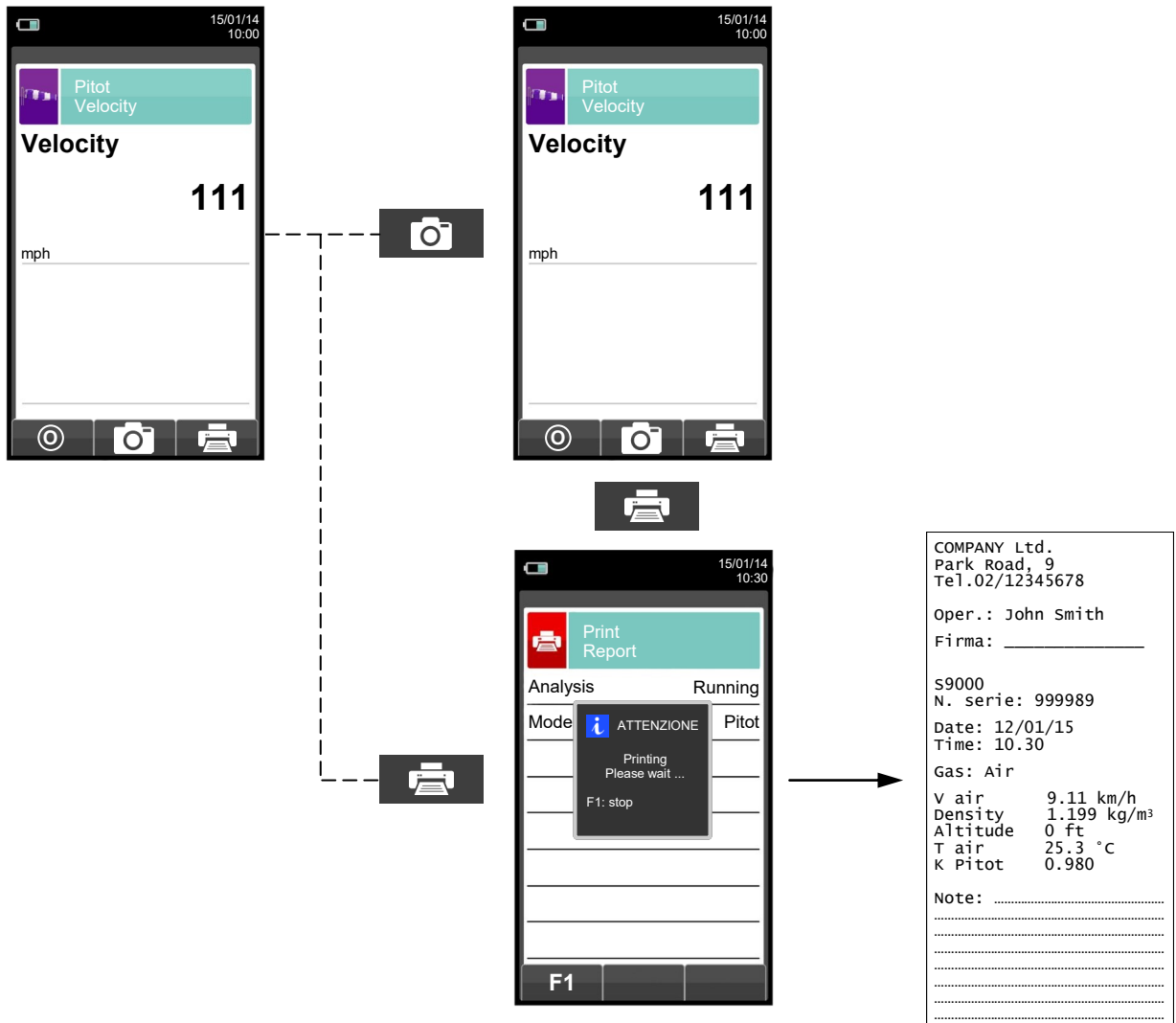
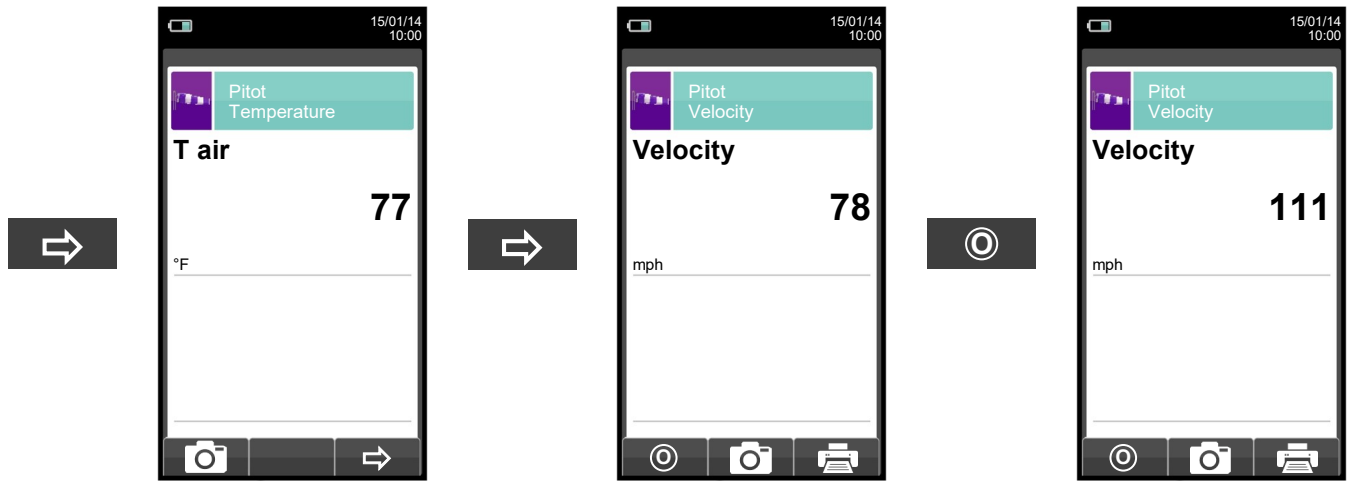

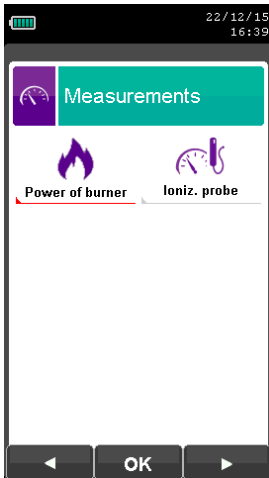

12.8 Measurements → AUX measurements



KEY	FUNCTION
	Activate the context keys shown on the display.
	Returns to the previous screen.

CONTEXT KEY	FUNCTION
	Selects the available parameters.
	Enters in the selected parameter setting.
	Selects the available parameters.

PARAMETER	DESCRIPTION
 Power of burner	<p>Thermal power of the burner The measurement of the thermal power at the burner can be performed in different ways, depending on the type of fuel selected.</p> <p>Boilers using gaseous fuels FLOW: if the system is equipped with a volumetric flow meter just enter the value of the fuel volume flow (m³ / h). COUNTER: this mode can be used if the system is equipped with a volumetric flow meter. The volume flow is calculated by reading on the counter, while the generator is in steady operation, the volume of gas flown in a time interval of at least 120 s. MANUAL: if the procedure was provided by the manufacturer and appropriate instructions have been specified on the user manual, the operator can find out the thermal power of the burner and enter it manually. In the absence of counter or any other system for measuring the flow, the nominal thermal power of the boiler stated by the manufacturer is to be assumed as the proper value.</p> <p>Boilers using liquid fuels FLOW: the value of the mass flow rate (kg / h) of the fuel must be entered. MANUAL: if the procedure was provided by the manufacturer and appropriate instructions have been specified on the user manual, the operator can find out the thermal power of the burner and enter it manually. In the absence of counter or any other system for measuring the flow, the nominal thermal power of the boiler stated by the manufacturer is to be assumed as the proper value.</p> <p>SEE SECTION 12.9.</p>
 Ioniz. probe	<p>You can measure the ionization current of a boiler and test its value based on the technical features of the boiler by connecting the ionization probe (optional) to the serial port (See section 7.4 and/or section 7.4.7).</p> <p>SEE SECTION 12.10.</p>

12.9 Measurements → Power of burner

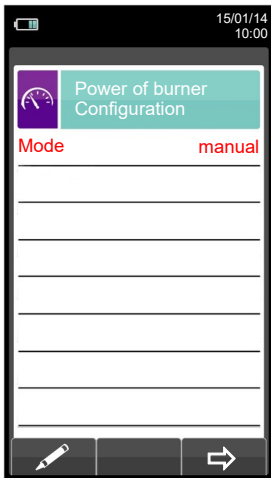

Enter the thermal power value calculated manually by the operator.

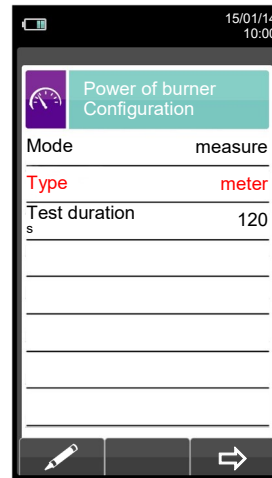

Test mode: you can choose to calculate the thermal power by entering a flow value, or by reading the volumetric counter (gaseous fuels only).

Duration of test: the option is displayed only for the test mode 'COUNTER', available for gaseous fuels. It is possible to enter the number of seconds between the reading of the initial and final gas volume. The minimum time required by law is 120 s.

KEY	FUNCTION
	Activate the context keys shown on the display.
	Selects line; the selected line is displayed in red. When in modify mode, sets the desired value.
	In change moves the cursor to the box corresponding to the desired number to set the desired value.
	Activates the context key located in the left side of the display.
	Returns to the previous screen. When in modify mode cancels the modification just made.

CONTEXT KEY	FUNCTION
	Enters the modification mode for the selected parameter.
	Confirms the settings.
	Go to next step.
	Saves, in the memory selected in the "Memory Select" menu, the value of the draft measured.
	Stops the test.

12.9.1 TESTING IN 'MANUAL' MODE

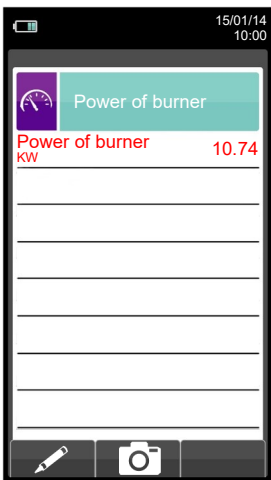
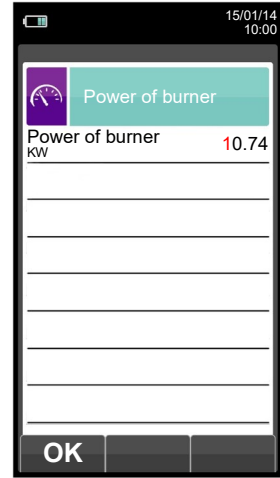
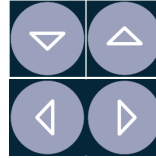
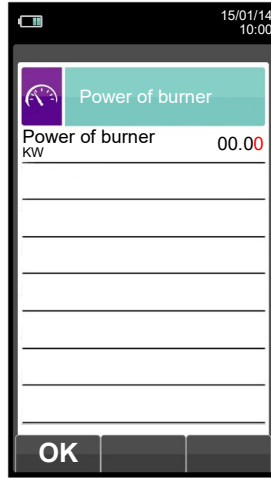
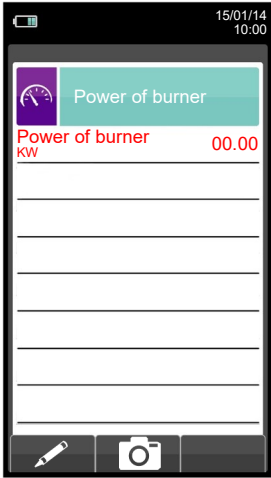

12.9.2 TESTING IN 'MEASURE' MODE (based on Flow rate)

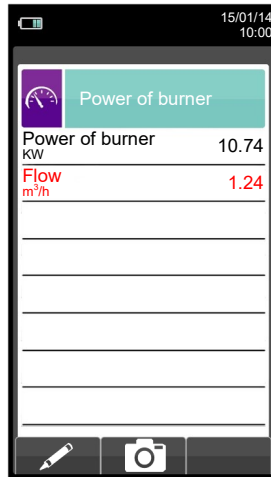
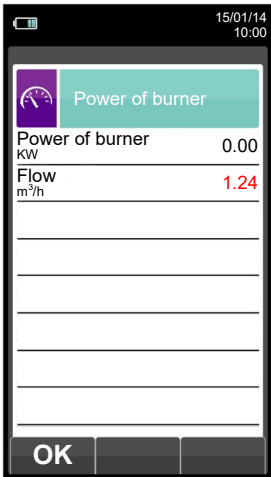
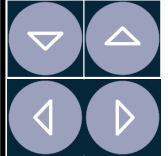
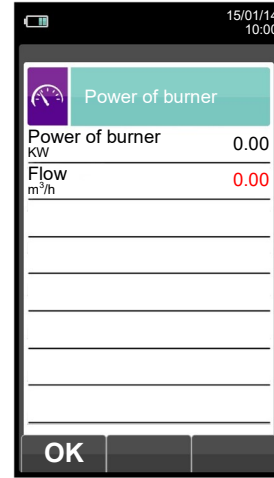
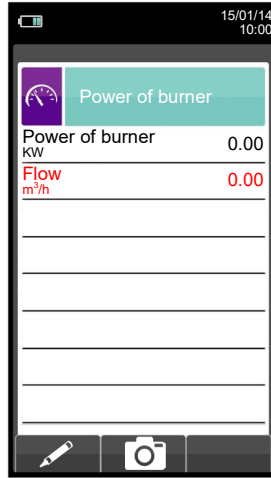
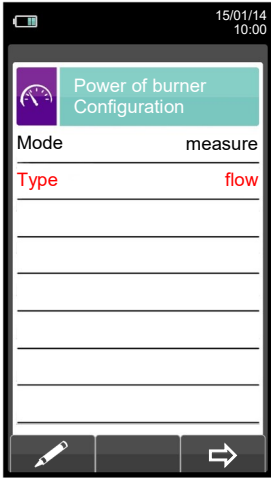

12.9.3 TESTING IN 'MEASURE' MODE (based on meter)

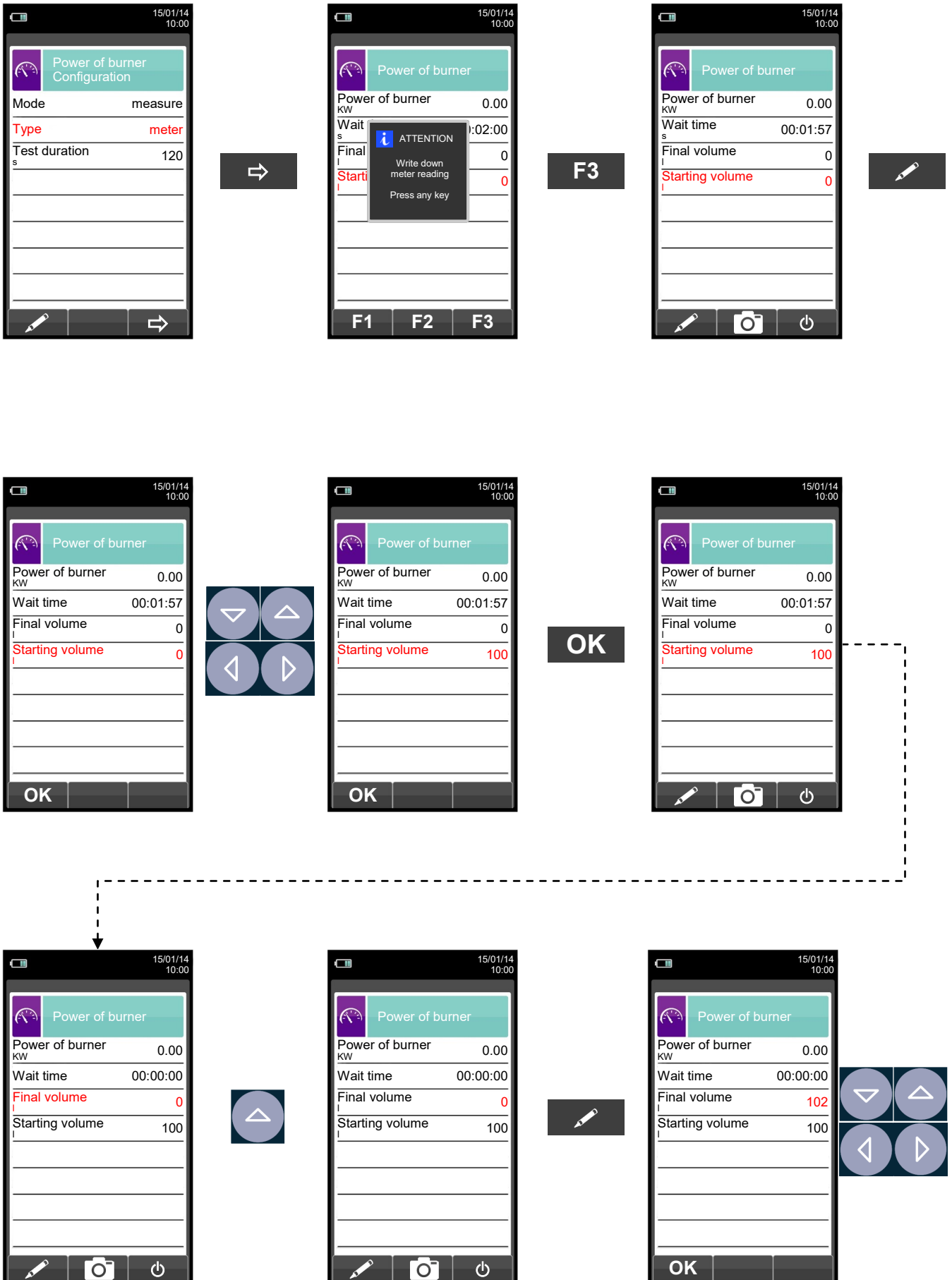

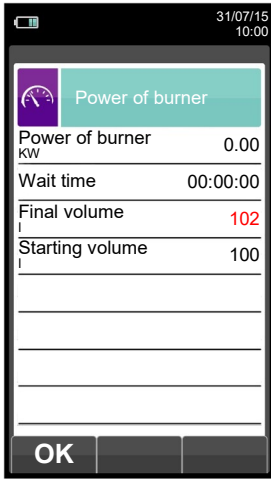



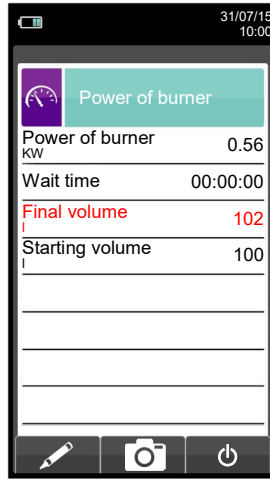

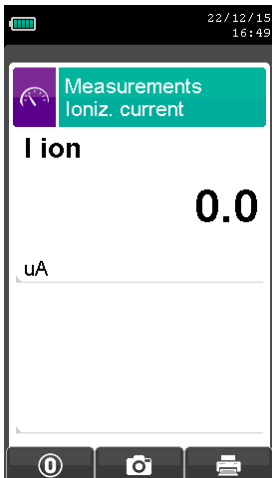

OK



12.10 Measurements → Ionization probe
Optional Ionization Probe Part # AACSO01 needed for this measurement)



KEY	FUNCTION
	Activate the context keys shown on the display.
	Returns to the previous screen.

CONTEXT KEY	FUNCTION
	Zeroes the current value.
	Acquires the current value for a further saving in the memory selected in the "Select Memory" menu.
	Starts printing the report. See section 11.

13.1 FLUE GAS ANALYSIS



To perform a full flue gas analysis, follow the instructions below.



SOME IMPORTANT WARNINGS TO CONSIDER DURING THE COMBUSTION ANALYSIS ARE LISTED BELOW:

FOR A CORRECT ANALYSIS NO AIR MUST FLOW INTO THE PIPE FROM OUTSIDE DUE TO A BAD TIGHTENING OF THE CONE OR A LEAK IN THE PIPELINE.

THE GAS PIPE MUST BE CHECKED IN ORDER TO AVOID ANY LEAKAGES OR OBSTRUCTIONS ALONG THE PATH.

THE CONNECTORS OF THE GAS SAMPLING PROBE AND OF THE CONDENSATE FILTER MUST BE WELL CONNECTED TO THE INSTRUMENT.

KEEP THE CONDENSATE TRAP IN THE VERTICAL POSITION DURING THE ANALYSIS; A WRONG POSITIONING MAY CAUSE CONDENSATE INFILTRATIONS IN THE INSTRUMENT AND THUS DAMAGE THE SENSORS.

DO NOT PERFORM ANY MEASUREMENT WHEN THE FILTER IS REMOVED OR DIRTY IN ORDER TO AVOID ANY RISK OF IRREVERSIBLE DAMAGES ON SENSORS.

13.1.1 Switching on the instrument and auto-calibration

Press the On/Off key to switch on the instrument - an introductory screen will appear. After a couple of moments the instrument will zero itself and will state that the sample probe should not be inserted in the stack.

In case the instrument is equipped with the electrovalve for automatic auto-zeroing, it will ask for the insertion of the gas probe in the stack. On the other hand if the instrument has not the electrovalve, it will require not to insert the gas probe in the stack.

In the latter it is important that the sample probe is not inside the stack since, during auto-calibration, the instrument draws fresh air from the environment and detects the zero value of the O₂, CO and NO sensors, the details of which are then memorized and used for reference during the analysis. It is equally important that this phase is performed in a fresh-air environment.

The pressure sensor (piezoresistive, temperature compensated) is also zeroed during auto-calibration.

13.1.2 Inserting the probe inside the stack

When auto-calibration is complete the instrument will instruct the user to insert the sample probe that has been previously connected to the relative input on the instrument, and the analysis screen will appear automatically.

In order for the probe to be inserted at the right point within the stack, its distance from the boiler has to be twice the diameter of the stack pipe itself or, if this is not possible, must comply with the boiler manufacturer's instructions.

In order to position the probe correctly, a reliable support must be provided by drilling a 0.5"/0.6" hole in the manifold (unless already present) and screwing in the positioning cone provided with the probe - in this way no air is drawn from the outside during sampling.

The screw on the cone allows the probe to be stopped at the right measuring depth - this usually corresponds to the center of the exhaust pipe. For greater positioning accuracy, the user may insert the probe gradually into the pipe until the highest temperature is read. The exhaust pipe must be inspected before carrying out the test, so as to ensure that no constrictions or losses are present in the piping or stack.



13.1.3 Simultaneous measurement of pressure, O₂, pollutants

In order to measure simultaneously pressure, O₂ and pollutants levels as well as all the others calculated parameters necessary to obtain the correct performance value, connect the instrument as follows:

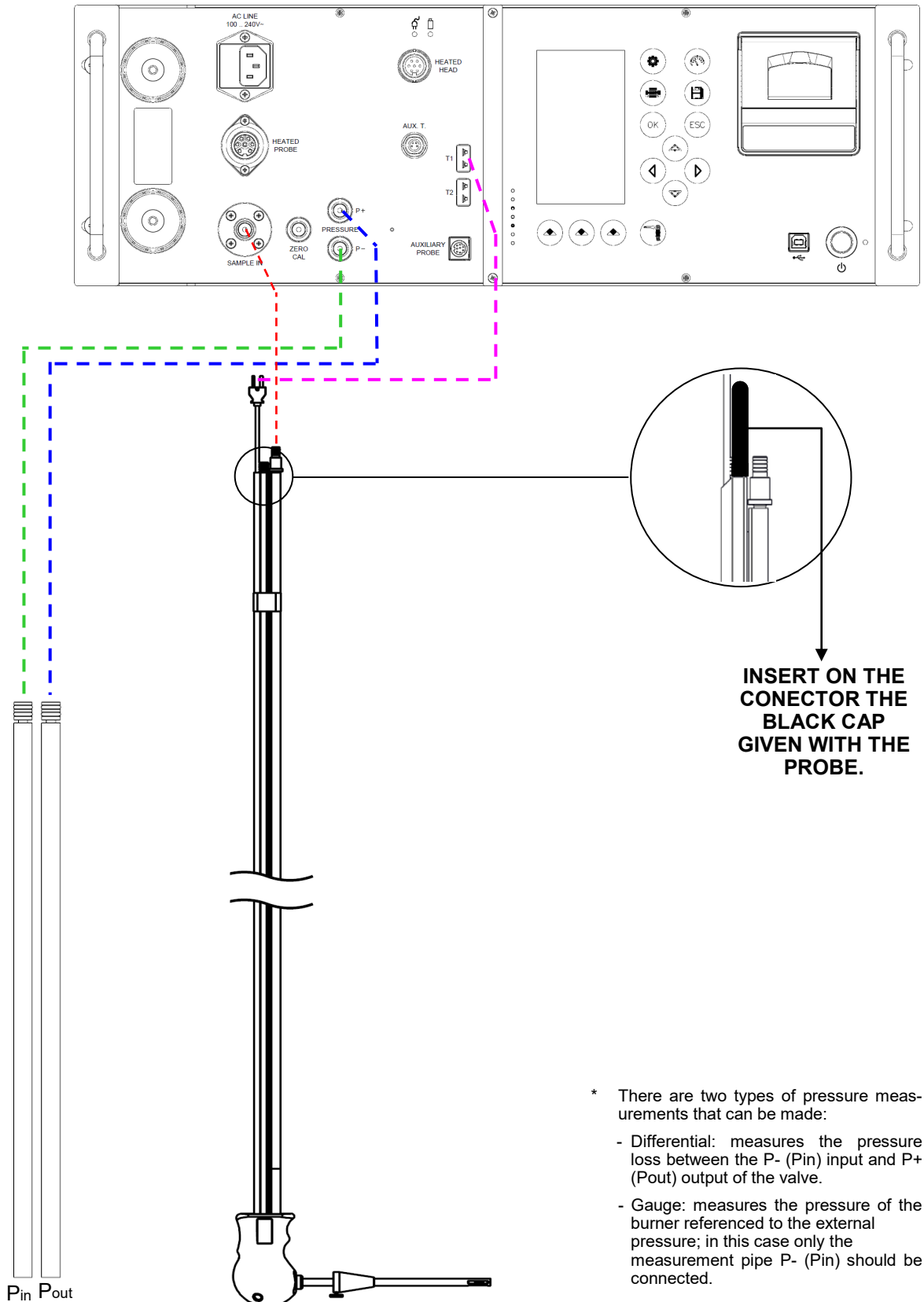

- * There are two types of pressure measurements that can be made:
- Differential: measures the pressure loss between the P- (Pin) input and P+ (Pout) output of the valve.
 - Gauge: measures the pressure of the burner referenced to the external pressure; in this case only the measurement pipe P- (Pin) should be connected.



13.1.4 Flue Gas Analysis

After the sample probe has been inserted in the stack and the combustion air temperature probe (if used) has been inserted in the relative sample manifold, if the instrument has not been configured during auto-calibration, the following data must be configured:

Memory: use this submenu to define the memory in which the test data and client details are to be stored.

Fuel: select the type of fuel burned in the combustion equipment producing the flue/exhaust gas being measured.

Operator: this is where the name of the test operator can be entered.

Mode: by entering this submenu, the user can determine the analysis mode - manual or automatic.

If automatic mode is chosen, the reading duration of each and every test must be set, besides the printing mode - manual or automatic. When flue gas analysis begins, the instrument will perform and memorize the three tests automatically, at the respective intervals set.

At the end of each test the instrument will emit an audible alarm (one "beep" after the first test, two "beeps" after the second test and three "beeps" after the third test).

At this point, when all three tests are over, if "Manual Printing" has been chosen the instrument will display the average of the three tests with the possibility of recalling the individual values.

If desired, the user can then print the relative data (total, complete, etc....). On the contrary, if "Automatic Printing" was selected, the instrument will print the test data automatically, based on the current print settings, without displaying the average test values.

Caution: when in automatic mode Draft, Smoke and ambient CO (NO) measurements must be taken before initiating the flue gas analysis.

If, on the other hand, manual analysis mode is chosen, flue gas analysis will proceed manually (please see relative Flow Chart). In this case the print settings and automatic test duration will not be considered.

At this point manual analysis may commence, first waiting at least two minutes until the displayed values stabilize: The user can then proceed with data storage, if required, or print the analysis report directly, which will be printed in the format set beforehand.

When all three tests are over, the user can recall the average analysis screen containing all the data necessary for compiling the maintenance log of the boiler or plant.

In both modes, automatic and manual, the displayed data of the pollutants CO / NO / NO_x can be translated into normalized values (with reference to the concentration of O₂ previously set).

13.1.5 End of Analysis

At the end of the combustion analysis, carefully remove the sample probe and remote air temperature probe, if used, from their relative ducts, taking care not to get burnt.

It is recommended to purge the analyzer with clean fresh air for at least 5 to 10 minutes before turning off the instrument by pressing the On/Off key.

At this point, if the instrument has detected a high concentration of CO and/or NO, a self-cleaning cycle will be initiated during which the pump will draw fresh outside air until the gas levels drop below acceptable values.

At the end of the cycle (lasting no longer than 3 min.) the instrument will switch itself off automatically.

13.2 FLUE GAS ANALYSIS - PRELIMINARY OPERATIONS

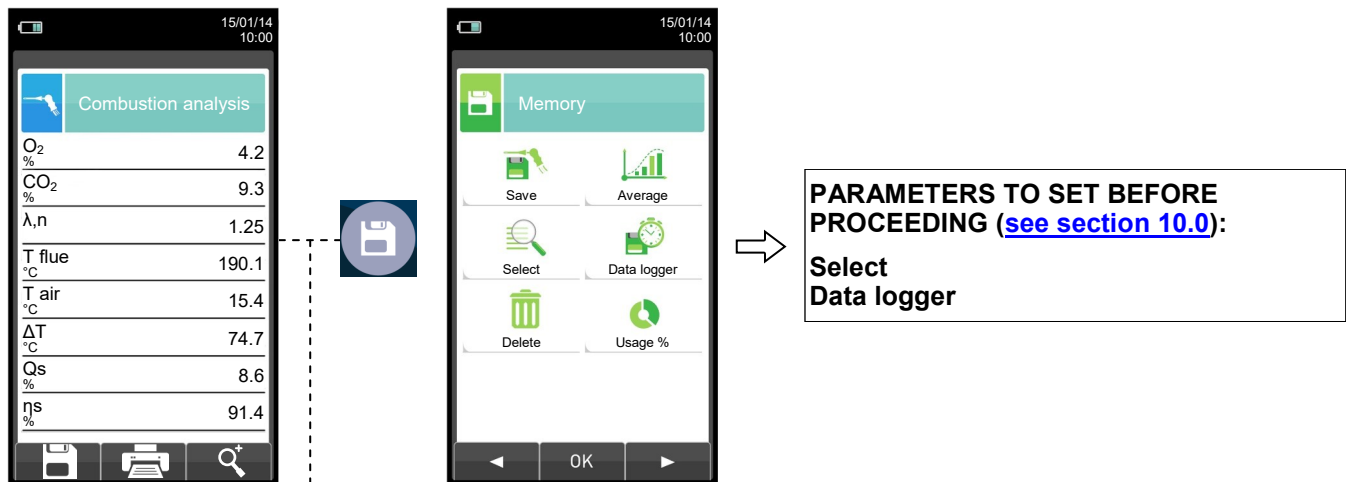
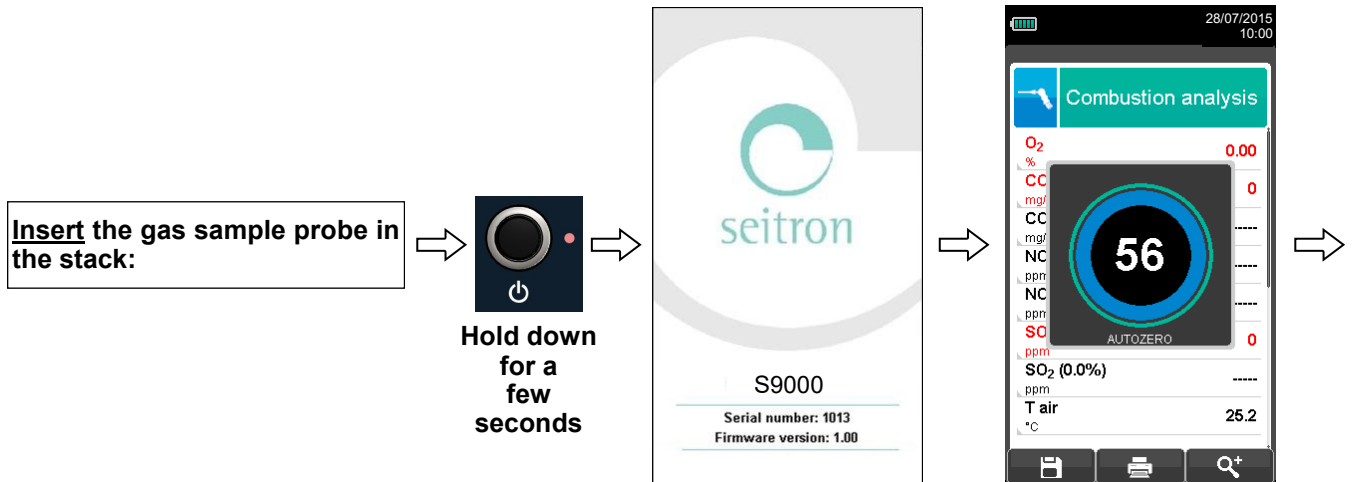

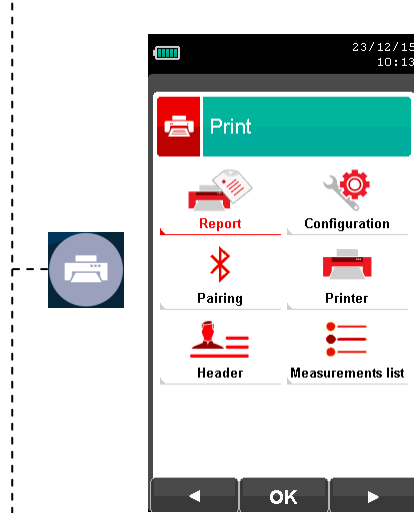

PARAMETERS TO SET BEFORE PROCEEDING (see section 11.0):

Configuration
Header
Measures list

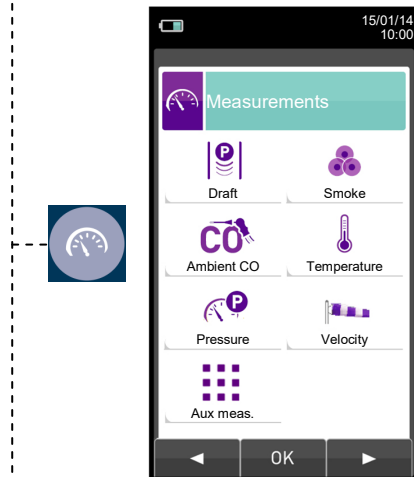

ACQUIRE THE FOLLOWING MEASUREMENTS BEFORE PROCEEDING WITH THE COMBUSTION ANALYSIS (see section 12.0):



In you don't, the measurements will not be printed with the combustion analysis.

Draft
Smoke
Ambient CO
Temperature
Pressure
Velocity

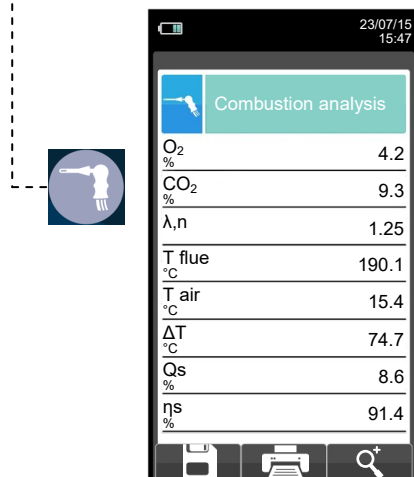

PRESS THE KEY '  ':
This starts saving the current analysis according to the set mode.

- Manual [See section 10.5.1](#)
- BlmSchV [See section 10.5.2](#)
- Data logger [See section 10.5.2](#)
- Periodic [See section 10.5.3](#)

PRESS THE KEY '  ':
This starts the printing on test paper print-out of the current analysis; additional measurements are also printed, if they are present in the memory.

13.3 PERFORMING COMBUSTION ANALYSIS - MANUAL MODE



15/01/14 10:00

Combustion analysis

O ₂ %	4.2
CO ₂ %	9.3
λ,n	1.25
T flue °C	190.1
T air °C	15.4
ΔT °C	74.7
Qs %	8.6
ηs %	91.4



15/01/14 10:00

Memory Save

Mode	manual
Memory	12
Analysis	1

OK
Saves analysis number 1

15/01/14 10:00

Combustion analysis

O ₂ %	4.2
CO ₂ %	9.3
λ,n	1.25
T flue °C	190.1
T air °C	15.4
ΔT °C	74.7
Qs %	8.6
ηs %	91.4



15/01/14 10:00

Memory Save

Mode	manual
Memory	12
Analysis	2

OK
Saves analysis number 2

15/01/14 10:00

Combustion analysis

O ₂ %	4.2
CO ₂ %	9.3
λ,n	1.25
T flue °C	190.1
T air °C	15.4
ΔT °C	74.7
Qs %	8.6
ηs %	91.4



15/01/14 10:00

Memory Save

Mode	manual
Memory	12
Analysis	3

OK
Saves analysis number 3

15/01/14 10:00

Combustion analysis

O ₂ %	4.2
CO ₂ %	9.3
λ,n	1.25
T flue °C	190.1
T air °C	15.4
ΔT °C	74.7
Qs %	8.6
ηs %	91.4



23/12/15 10:29

Memory

Save	Average
Select	Data logger
Delete	Usage %

Recalls the average analysis.



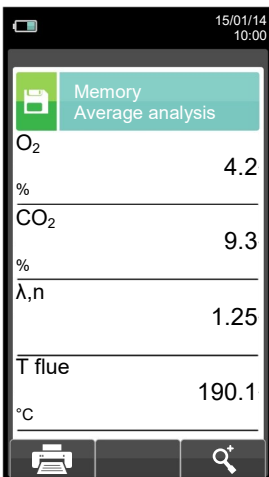
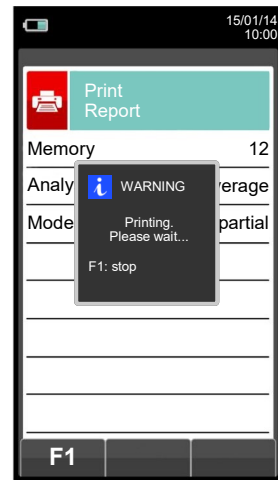
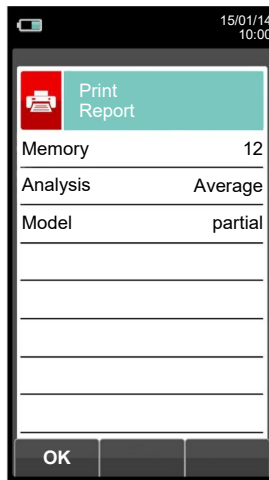
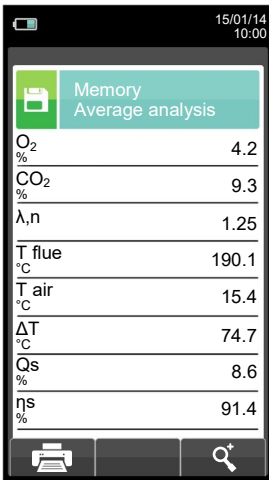

```

Date: 15/01/14
Time: 10.10
Fuel: Natural gas
Altitude: 0 m
R.H. air: 50 %
O2          4.2 %
CO2         9.3 %
λ,n         1.25
T flue      190.2 °C
T air       15.4 °C
dT          174.8 °C
QS          8.6 %
Es          91.4 %
EC          4.9 %
Et          96.3 %
CO          148 ppm
NO          40 ppm
NOX/NO:    1.03
NOX        41 ppm
Amb. CO    0 ppm
Draft:     0.05 hPa
T out:     20 °C
Smoke:    3 1 2
Aver. n:   2
    
```

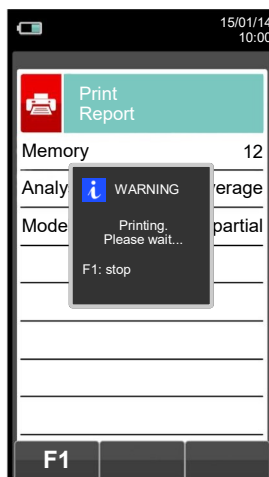
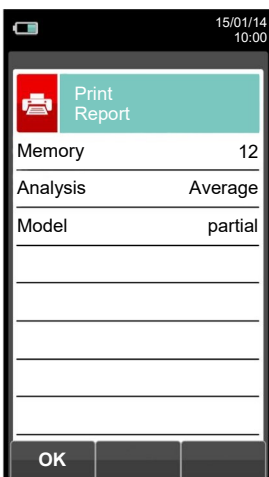



13.4 PERFORMING THE COMBUSTION ANALYSIS - BlmSchV MODE

15/01/14 10:00

Combustion analysis

O ₂ %	4.2
CO ₂ %	9.3
λ,n	1.25
T flue °C	190.1
T air °C	15.4
ΔT °C	74.7
Qs %	8.6
ηs %	91.4



15/01/14 10:00

Memory Save

Mode	BlmSchV
Memory	3
Samples	30
Interval s	1



15/01/14 10:00

Combustion analysis BlmSchV

O ₂ %	4.2
CO ₂ %	9.3
λ,n	1.25
T flue °C	190.1
T air °C	15.4
ΔT °C	74.7
Qs %	8.6
ηs %	91.4



Automatically saves the first sample when the set time is over.

15/01/14 10:02

Combustion analysis BlmSchV

O ₂ %	4.2
CO ₂ %	9.3
λ,n	1.25
T flue °C	190.1
T air °C	15.4
ΔT °C	74.7
Qs %	8.6
ηs %	91.4

Automatically saves the second sample when the preset time interval has elapsed and so on until the last sample.

Once the flue gas analysis is completed the instrument saves the average value of the samples taken.



15/01/14 10:00

Memory Analis BlmSchV

O ₂ %	4.2
CO ₂ %	9.3
λ,n	1.25
T flue °C	190.1
T air °C	15.4
ΔT °C	74.7
Qs %	8.6
ηs %	91.4



15/01/14 10:00

Print Report

Memory	3
Analysis	BlmSchV
Model	partial



15/01/14 10:00

Print Report

Memory	3
Analy	BlmSchV
Mode	partial

WARNING
Printing. Please wait...
F1: stop

Date: 15/01/14
Time: 10.10

Fuel: Natural gas
Altitude: 0 m
R.H. air: 50 %

O ₂	4.2 %
CO ₂	9.3 %
λ,n	1.25
T flue	190.2 °C
T air	15.4 °C
dT	174.8 °C
QS	8.6 %
Es	91.4 %
Ec	4.9 %
Et	96.3 %
CO	148 ppm
NO	40 ppm
NOX/NO:	1.03
NOX	41 ppm
CO amb	0 ppm
Draft:	0.05 hPa
T out:	20 °C
Smoke:	3 1 2
Aver. n:	2

13.5 PERFORMING THE COMBUSTION ANALYSIS - data logger MODE



15/01/14 10:00

Combustion analysis

O ₂ %	4.2
CO ₂ %	9.3
λ,n	1.25
T flue °C	190.1
T air °C	15.4
ΔT °C	74.7
Qs %	8.6
ηs %	91.4

Save Print Search



15/01/14 10:00

Memory Save

Mode	data logger
Memory	1
Samples	10
Interval s	60

OK



15/01/14 10:00

Combustion analysis data logger

O ₂ %	4.2
CO ₂ %	9.3
λ,n	1.25
T flue °C	190.1
T air °C	15.4
ΔT °C	74.7
Qs %	8.6
ηs %	91.4

Power 1 60 Search



15/01/14 10:02

Combustion analysis data logger

O ₂ %	4.2
CO ₂ %	9.3
λ,n	1.25
T flue °C	190.1
T air °C	15.4
ΔT °C	74.7
Qs %	8.6
ηs %	91.4

WARNING
Data logger active. Interrupt?
F1: Interrupt
F2: continue
F3: pause

F1 F2 F3



Automatically saves the first sample when the set time is over.

15/01/14 10:02

Combustion analysis data logger

O ₂ %	4.2
CO ₂ %	9.3
λ,n	1.25
T flue °C	190.1
T air °C	15.4
ΔT °C	74.7
Qs %	8.6
ηs %	91.4

Power 2 60 Search

Automatically saves the second sample when the set time is over and so on until the last sample.



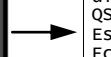
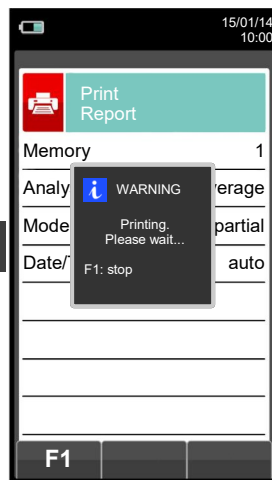
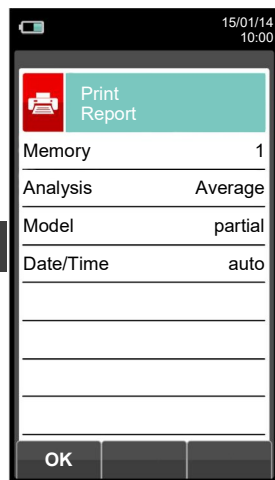
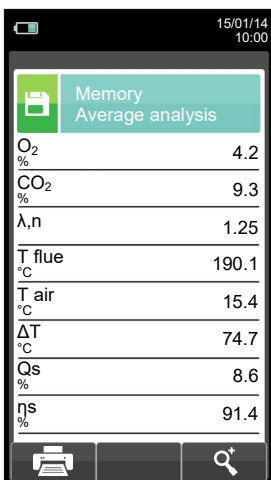

```

Date: 15/01/14
Time: 10.10
Fuel: Natural gas
Altitude: 0 m
R.H. air: 50 %
O2 4.2 %
CO2 9.3 %
lambda,n 1.25
T flue 190.2 C
T air 15.4 C
delta T 174.8 C
Qs 8.6 %
Es 91.4 %
Ec 4.9 %
Et 91.4 %
CO 148 ppm
NO 40 ppm
NOX/NO: 1.03
NOX 41 ppm
Amb. CO 0 ppm
Draft: 0.05 hPa
T out: 20 C
Smoke: 3 1 2
Aver. n: 2
    
```



13.6 PERFORMING THE COMBUSTION ANALYSIS - PERIODIC MODE

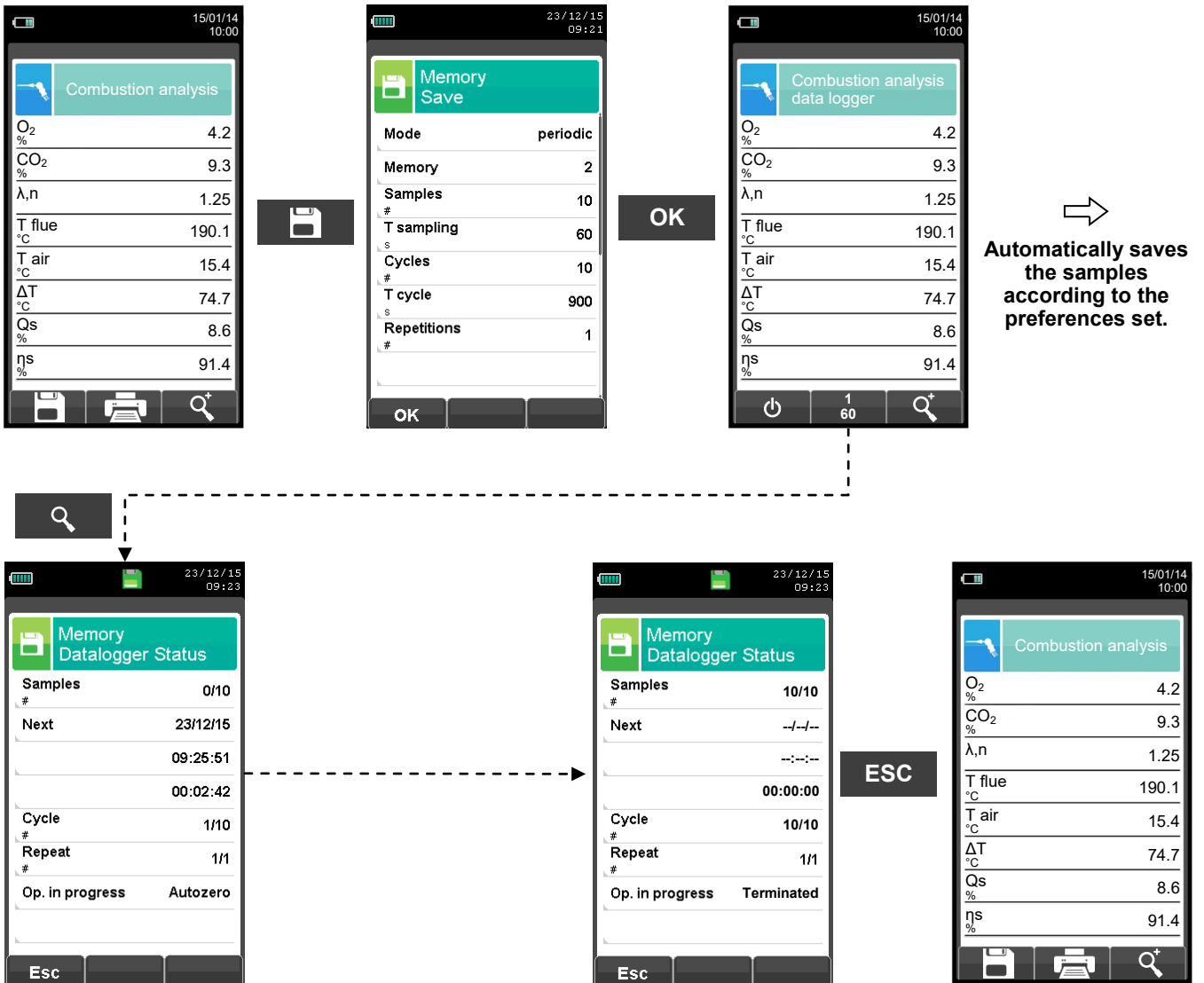

NOTE: Once the emissions analysis is completed (an audible signal will be emitted), the average of the samples acquired will be displayed on the instrument. The stored analyses can be individually displayed and printed directly from the instrument or can be downloaded to the PC for further processing.

14.1 Positioning of sensors inside the sensor compartment

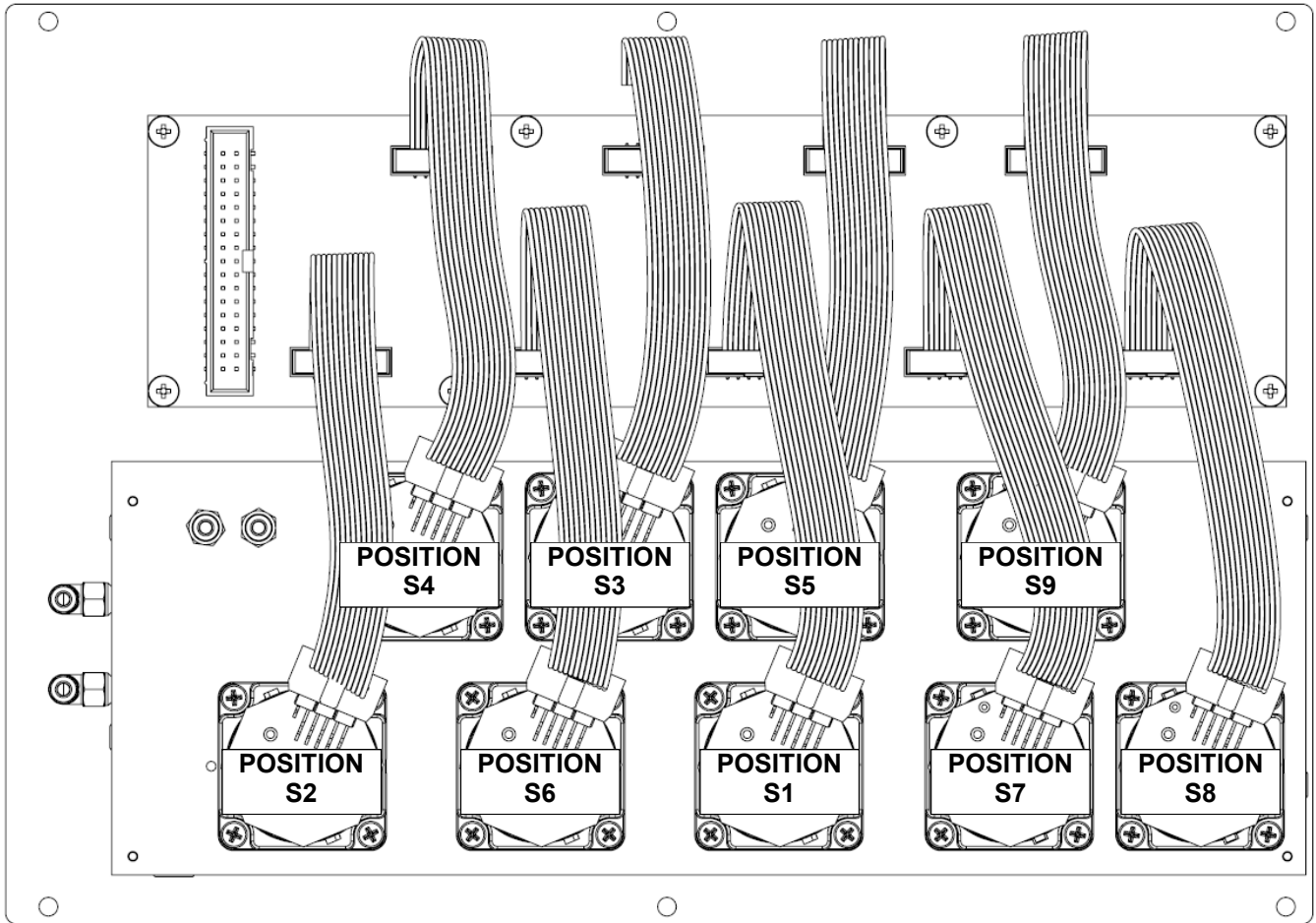

14.2 Sensors list

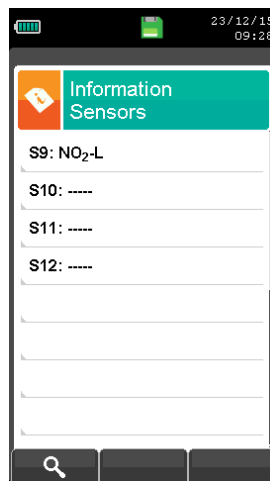
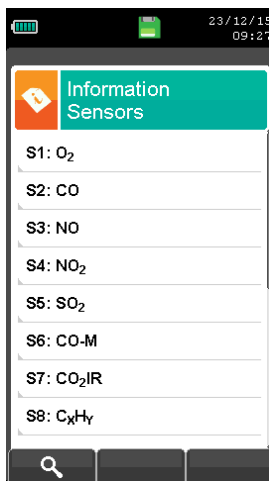

Note

- Positions S10, S11, S12 are related to the infrared bench.
- If two or more identical sensors are installed, the measured gas (i.e. NO₂, SO₂, ..) and the installation position (S2, S5, ..) will be shown on the display.

14.3 Sensor types and relevant positioning

CODE \ POSITION	S1	S2	S3	S4	S5	S6	S7	S8	S9
Flex-Sensor O₂ LL Cod. AACSE44	✓	✓	✓				✓		
Flex-Sensor CO+H₂ Cod. AACSE12		✓							
Flex-Sensor NO Cod. AACSE10	✓	✓	✓				✓		
Flex-Sensor NO₂ Cod. AACSE14	✓	✓	✓	✓	✓	✓	✓	✓	✓
Flex-Sensor SO₂ Cod. AACSE13	✓	✓	✓	✓	✓	✓	✓	✓	✓
Flex-Sensor CO 100.000 ppm Cod. AACSE17	✓	✓	✓	✓	✓	✓	✓	✓	✓
Flex-Sensor CO 20.000 ppm Cod. AACSE18	✓	✓	✓	✓	✓	✓	✓	✓	✓
Flex-Sensor CO₂ 0-20% v/v Cod. AACSE41	✓	✓	✓	✓	✓	✓	✓	✓	✓
Flex-Sensor CxHy 0-5.00% vol. riferito al CH₄ Cod. AACSE39	✓	✓	✓	✓	✓	✓	✓	✓	✓
Flex-Sensor CO+H₂ low range Cod. AACSE24		✓							
Flex-Sensor NO low range Cod. AACSE25	✓	✓	✓				✓		
Flex-Sensor NO₂ low range Cod. AACSE26	✓	✓	✓	✓	✓	✓	✓	✓	✓
Flex-Sensor SO₂ low range Cod. AACSE28	✓	✓	✓	✓	✓	✓	✓	✓	✓
Flex-Sensor CO₂ 0-50% v/v Cod. AACSE47	✓	✓	✓	✓	✓	✓	✓	✓	✓
Flex-Sensor H₂S Cod. AACSE35	✓	✓	✓	✓	✓	✓	✓	✓	✓
Flex-Sensor NH₃ Cod. AACSE56	✓	✓	✓	✓	✓	✓	✓	✓	✓
Flex-Sensor H₂ 2000ppm Cod. AACSE57	✓	✓	✓	✓	✓	✓	✓	✓	✓
Flex-Sensor H₂ 40000ppm Cod. AACSE78	✓	✓	✓	✓	✓	✓	✓	✓	✓

14.4 Gas sensors life

The gas sensors used in this instrument are electrochemical: thus, when the relative gas is detected, a chemical reaction takes place inside them that generates an electrical current.

The electrical current acquired by the instrument is then converted into the corresponding gas concentration. Sensor life is strongly related to the consumption of the reagents within.

Sensor characteristics diminish as the reagents are consumed and when these have been used up completely the sensor must be replaced. The sensors must be recalibrated on a regular basis to assure measuring accuracy: recalibration can only be performed by a qualified Seitron Americas service centre. Chart 14.5 illustrates the characteristics inherent to each sensor.

14.5 Table gas sensors life

CODE	MEASURED GAS	IDENTIFYING COLOR ⁽¹⁾	AVERAGE LIFE	RECALIBRATION
Flex-Sensor O₂ Cod. AACSE15R	O ₂ Oxygen		>24 months	not required
Flex-Sensor CO+H₂ Cod. AACSE12	CO Carbon Monoxide	Red	48 months	yearly ⁽²⁾
Flex-Sensor NO Cod. AACSE10	NO Nitrogen Oxide	Orange	48 months	yearly ⁽²⁾
Flex-Sensor NO₂ Cod. AACSE14	NO ₂ Nitrogen Dioxide	White	36 months	yearly ⁽²⁾
Flex-Sensor SO₂ Cod. AACSE13	SO ₂ Sulphur Dioxide	Green	36 months	yearly ⁽²⁾
Flex-Sensor CO 100000 ppm Cod. AACSE17	CO Carbon Monoxide	Purple	48 months	yearly ⁽²⁾
Flex-Sensor CO 20.000 ppm Cod. AACSE18	CO Carbon Monoxide	Blue	48 months	yearly ⁽²⁾
Flex-Sensor C_xH_y 0-5.00% vol. ref. to CH₄ Cod. AACSE39	C _x H _y Unburnt Hydrocarbons		48 months	yearly ⁽²⁾
Flex-Sensor CO+H₂ low range Cod. AACSE24	CO Carbon Monoxide	Red	48 months	yearly ⁽²⁾
Flex-Sensor NO low range Cod. AACSE25	NO Nitrogen Oxide	Orange	48 months	yearly ⁽²⁾
Flex-Sensor NO₂ low range Cod. AACSE26	NO ₂ Nitrogen Dioxide	White	48 months	yearly ⁽²⁾
Flex-Sensor SO₂ low range Cod. AACSE28	SO ₂ Sulphur Dioxide	Green	48 months	yearly ⁽²⁾
Flex-Sensor CO₂ 0-20% Cod. AACSE41	CO ₂ Carbon Dioxide		>48 months	yearly ⁽²⁾
Flex-Sensor CO₂ 0-50% Cod. AACSE47	CO ₂ Carbon Dioxide		>48 months	Yearly ⁽²⁾
Flex-Sensor H₂S Cod. AACSE35	H ₂ S Hydrogen Sulphide		36 months	yearly ⁽²⁾
Flex-Sensor NH₃ Cod. AACSE56	NH ₃ Ammonia		48 months	yearly ⁽²⁾
Flex-Sensor H₂ 2000ppm Cod. AACSE57	H ₂ Hydrogen		24 months	yearly ⁽²⁾
Flex-Sensor H₂ 40000ppm Cod. AACSE78	H ₂ Hydrogen		24 months	yearly ⁽²⁾

Note:

(1) Colored dot on the sensor electronic board.

(2) The standard requires for the instrument calibration once per year to be performed in a laboratory authorized to issue calibration certificates.

14.6 Expandability to 9 sensors

The S9000 combustion analyzer can be expanded up to 9 cells.

EXAMPLE OF AN EXPANDABLE 6 SENSORS S9000

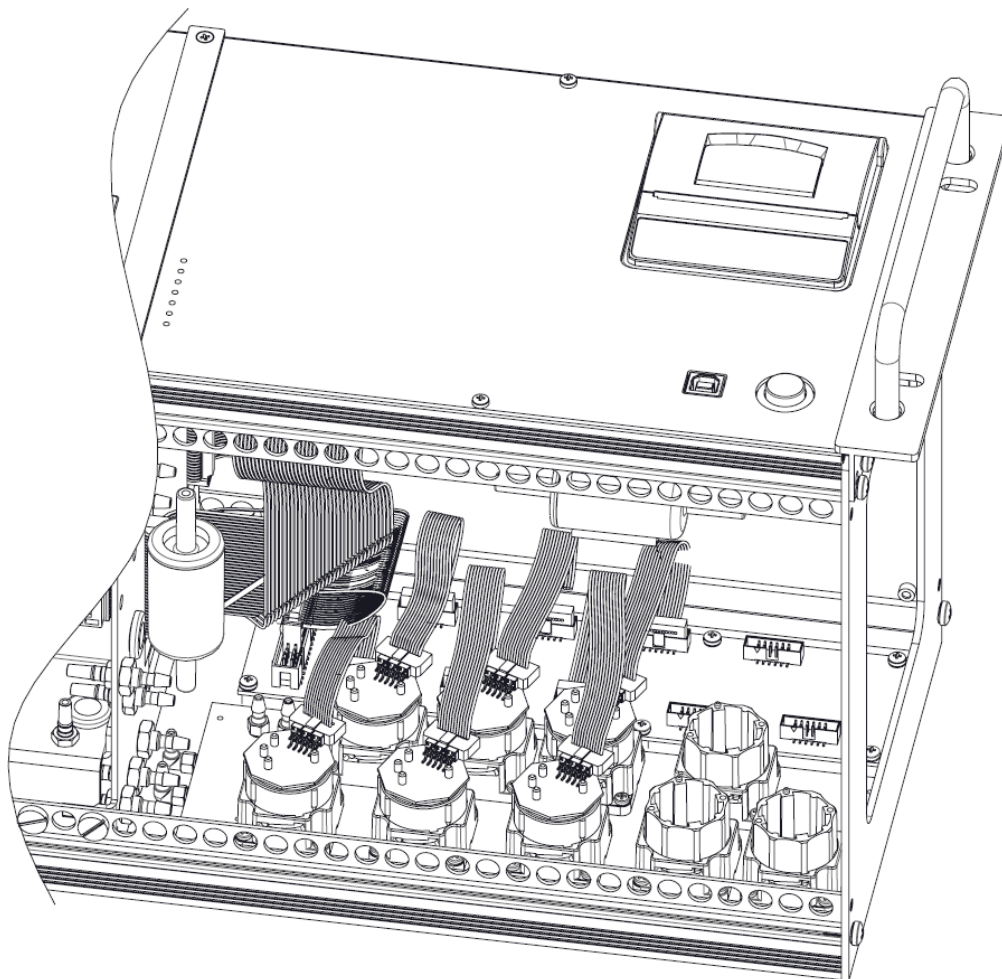

The upgrading of the number of sensors can be easily done by the user by performing the following directions:

- The expandable instruments are arranged in a way to accept up to a maximum of 9 sensors.
- Identify, with the help of paragraph 14.3 "[Sensor types and relevant positioning](#)", the sensor(s) which must be added to the existing configuration (Seitron delivers all FLEX-series sensors already pre-calibrated and ready to use).
- To install the new sensors follow all the steps described in the paragraph 'MAINTENANCE' in "[gas sensors replacement](#)".



THE INSTRUMENT AUTOMATICALLY DETECTS WHEN AN ADDITIONAL SENSOR IS INSTALLED OR HAS BEEN REMOVED. THE SCREEN 'SENSORS CONFIGURATION' ALLOWS TO ACCEPT THE NEW PROPOSED CONFIGURATION OR TO IGNORE THE CHANGE DETECTED. IN THIS SCREEN ARE SHOWN, FOR EACH POSITION, THE FOLLOWING MESSAGES:

EXAMPLE OF AN 'NO' SENSOR IN POSITION 3 REPLACED WITH AN 'NO2' SENSOR:

NO→NO₂ A SENSOR DIFFERENT FROM THE PREVIOUS ONE HAS BEEN DETECTED.

EXAMPLE OF A NEW SENSOR INSTALLED IN POSITION 4 (PREVIOUSLY NOT PRESENT):

SO₂→□ A NEW SENSOR HAS BEEN DETECTED.

14.7 CxHy sensor for measurement of the unburnt hydrocarbons (pellistor)

The unburnt hydrocarbons are chemicals produced by an incomplete combustion of molecules (hydrocarbons) made of Carbon and Hydrogen.

These are usually named as HC or (better) CxHy: when this is filled with the actual values for the number of C and H atoms, the actual type of fuel is exactly defined. In case of Methane, as an example, the correct formula is CH4. In the following table is shown the cross sensitivity of the CxHy sensor when exposed to fuels different from Methane (CH4), assumed as 1.00.

GAS / VAPOR	RELATIVE RESPONSE (with respect to Methane)	GAIN ADJUSTMENT
Ethanol	0.75	1.33
Iso-Butane	0.60	1.67
Methane	1.00	1.00
Methanol	1.00	1.00
n-Butane	0.60	1.67
n-Heptane	0.45	2.22
n-Hexane	0.50	2.00
Propane	0.70	1.43

Calculation example:

Type of gas: iso-butane
 Relative response: 0.6
 Gain adjustment: 1.67
 Reading value (related to methane): 1.34

Value = reading value x gain adjustment

Example: 1.34 x 1.67 = 2.24

WARNING

Gases that contain acidic or silicone compounds (HMDS) can irreversibly damage the sensor.

14.7.1 Installing the CxHy sensor

When the CxHy (position S3/S4) is mounted in the instrument, it is mandatory to configure the autozero by setting it at 180 seconds, in order to allow for a proper pre-heating of the sensor itself.

Configuration → Analysis → Autozero (See section 9.2.8)

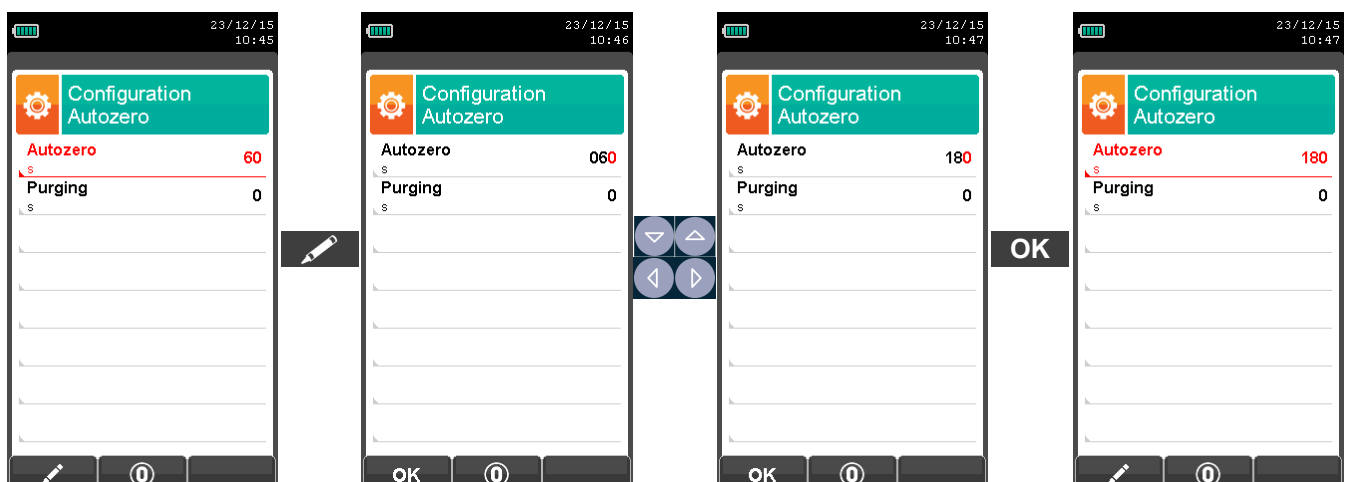

14.8 CO₂ sensor for Carbon Dioxide measurement in combustion processes (NDIR - Single Cell)

Carbon Dioxide (CO₂) is the result of combustion of an organic compound in presence of a quantity of oxygen sufficient to complete its oxidation. In nature, it is also produced by aerobic bacteria during the process of alcoholic fermentation and is the by product of respiration.

Many combustion processes are defined with 'mixed fuel' and is therefore difficult to calculate the amount of CO₂ produced. To avoid this drawback, the only way to know the amount of CO₂ produced in a combustion process with 'mixed fuel' is to measure the CO₂ with special NDIR sensors.

14.8.1 Installing the CO₂ sensor

When the CO₂ (position S3/S4) is mounted in the S9000, it is mandatory to configure the autozero by setting it at 60 seconds, in order to allow for a proper pre-heating of the sensor itself.

Configuration → Analysis → Autozero ([See section 9.2.8](#))

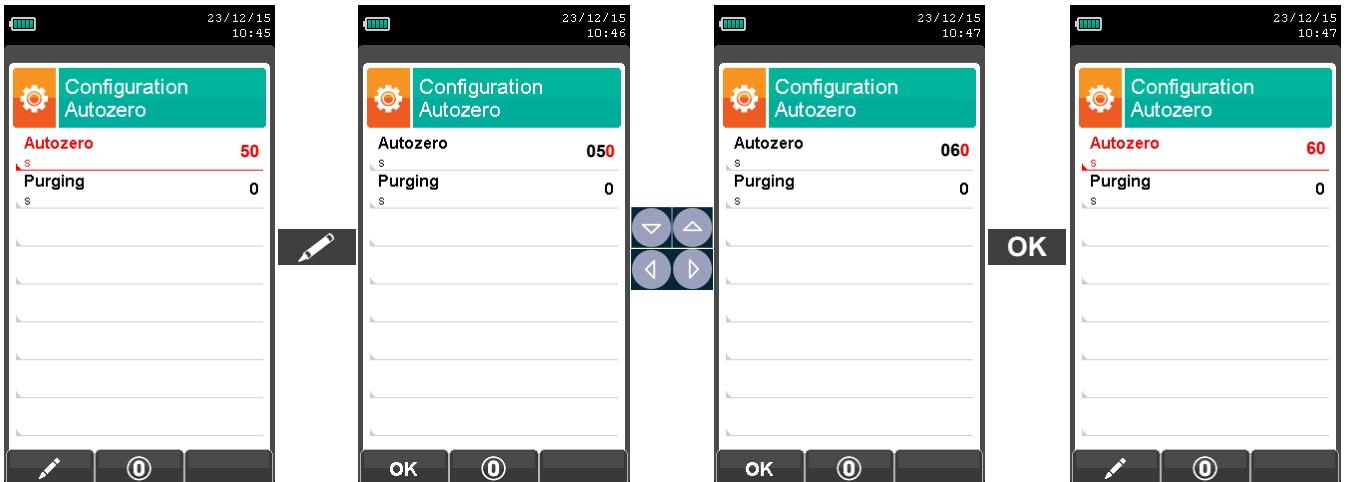
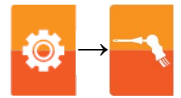

14.9 NH₃ sensor for ammonia gas measurement in combustion processes



USE ONLY WITH THE SMOKE PROBE FOR INDUSTRIAL ENGINES COMPLETE WITH SYNTHORIZED STEEL FILTER ON THE TIP AND FILTERED CARTRIDGE IN HDPE IN THE WATER TRAP.

This sensor measures the presence of ammonia (NH₃) in combustion gases and, since this gas is easily soluble in H₂O some precautions are necessary; the measure must be performed:

- For short periods of time (1-2 hours).
- Using only the flue gas sampling probe for industrial engines as it is equipped with a filter on the tip, suitable to perform this measurement. This filter creates a dry "pre-filtration" in order to retain the humidity that actually cancels the NH₃ content present in the fumes, making it not measurable. The filter being inserted inside the stack is heated by the fumes and kept warm; the gas that passes through the filter does not form condensation and therefore allows an accurate measurement of ammonia. The filter inserted in the stack is called "hot filter".
- It is necessary to replace the paper filters on the two anti-condensation traps external from the instrument, with two HDPE filters (to be sold separately), which retains the dust particles but not the residual humidity and therefore ammonia.

The procedure to replace the filters in the anti-condensation trap is described in the following:

1 Unscrew the transparent cap.

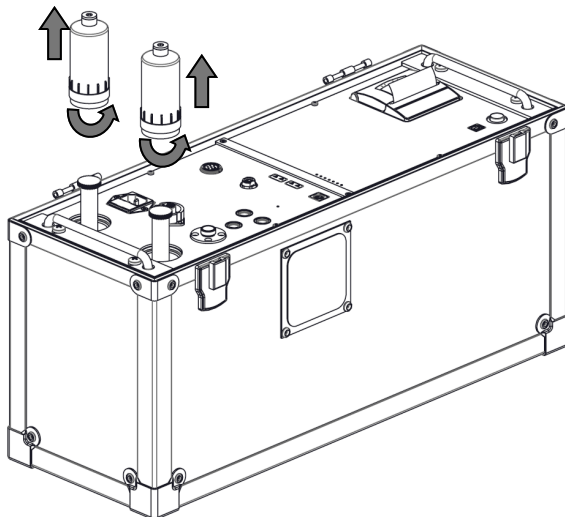

2 Un screw the anti dust filter.

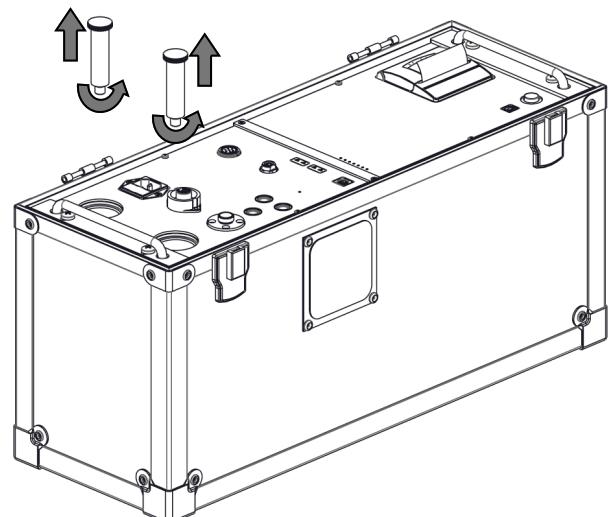

3 Replace the paper filter with the HDPE filter and screw it back on its seat.

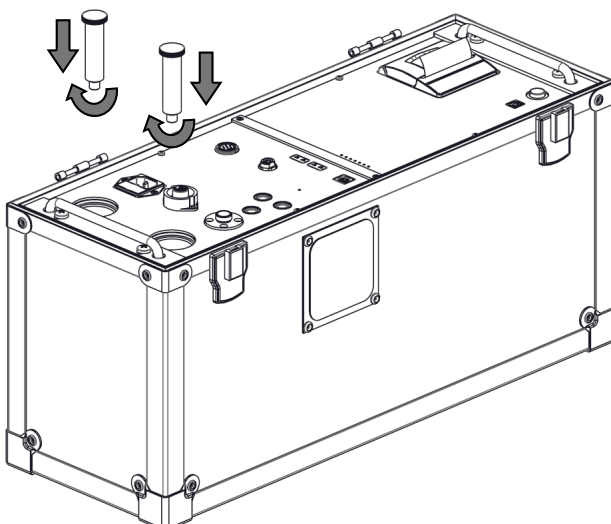

4 Screw back the transparent cap in its seat.

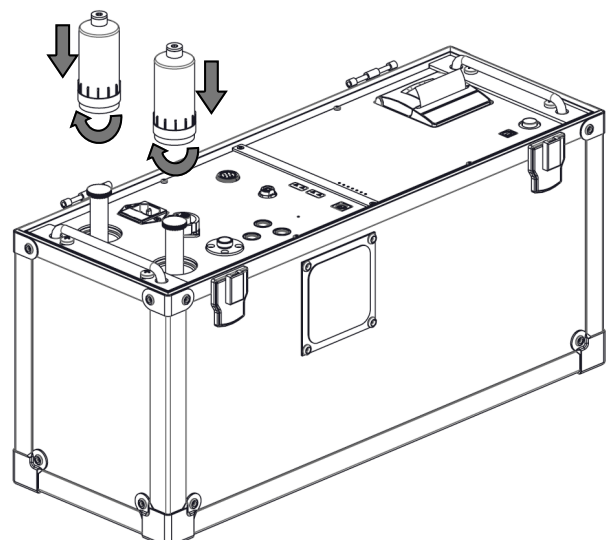

14.10 Infrared bench

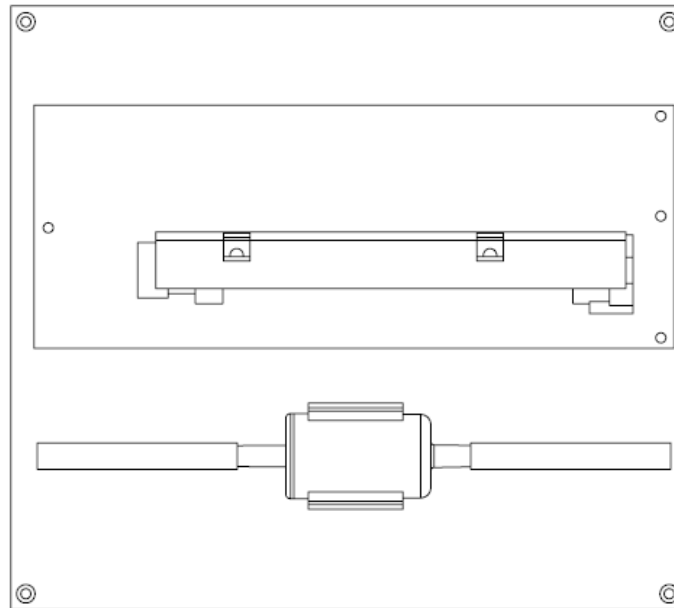

An infrared bench for the detection of gases based on (NDIR) infrared spectroscopy can be installed on **S9000**. By this system it is possible to simultaneously detect CO, CO₂ and C_xH_y.

An additional dust filter is fitted along the pneumatic circuit before the IR bench.

The principle is the (NDIR) nondispersive infrared absorption at two wavelengths, stability over time, no interference with other compounds of the process, very fast response and quick return to zero value even after measuring concentrations up to the maximum measurement limit.

Gases absorb light at specific wavelengths, typically in the IR. An NDIR system includes: an IR light source, a chamber which contains the gas sample to be analyzed and a detector equipped with an optical filter. The light goes through the chamber and the gas sample will absorb it at a specific wavelength (i.e. 4.26µm for CO₂) or in specific bands.

The filter is the nondispersive optical component which allows the detector to unequivocally identify the gas according to the absorption spectrum pattern. The narrower the filter bandwidth the higher is the specificity of the sensor. The intensity of light (at a specific wavelength) that reaches the detector is inversely proportional to the relevant gas concentration. The signal picked up by the detector is then processed by the downstream electronics in order to have the concentration of CO, CO₂ or C_xH_y.

15.1 Ordinary maintenance

This instrument has been designed and made using high quality components. A systematic and proper maintenance shall prevent the occurrence of any malfunctioning and increase the overall life cycle of your device.

The operator is recommended to carry out the following basic operations:

- Avoid any great thermal shock before using the instrument or possibly wait that its temperature is within the operating parameters.
- Do not extract flue gas directly without a dust/condensate trap.
- Do not exceed the sensor overload thresholds.
- When the analysis is completed, disconnect the water trap and hoses and let the analyzer purge with clean fresh air for at least 5 to 10 minutes, or at least until the displayed parameters return to their original values in air.
- Clean the filter unit as necessary, by replacing the dust filter and blowing air inside the tube of the sampling probe to release any condensate.

Do not use abrasive cleaners, solvents or other aggressive detergents to clean the instrument.

15.2 Scheduled Maintenance

Send the instrument to the SERVICE CENTER to be thoroughly cleaned and checked at least once a year. SEITRON AMERICAS highly qualified personnel is always at your disposal for any commercial or technical information and implementation or maintenance issues.

The service center is always ready to timely return the instrument like brand new. Calibrations are carried out using gases and instruments in compliance with National and International Sampling standards.

The annual test and certificate of calibration guarantee the proper operation of the instrument as provided by the standard and are mandatory for users who require ISO 9000 certification.

15.3 Cleaning of the sampling probe

After using the sampling probe and before placing it in its case, it is recommended to thoroughly clean it as follows:

- Disconnect the sampling probe from the instrument.
- Blow clean air in both tubes of the probe to release any remaining condensate.



15.4 Cleaning the sampling probe for industrial engines

After using the sampling probe for industrial engines, it is recommended to thoroughly clean it as follows:

- Disconnect the sampling probe from the instrument.
- Remove the filter from the probe tip by loosening the nut shown by the arrow.

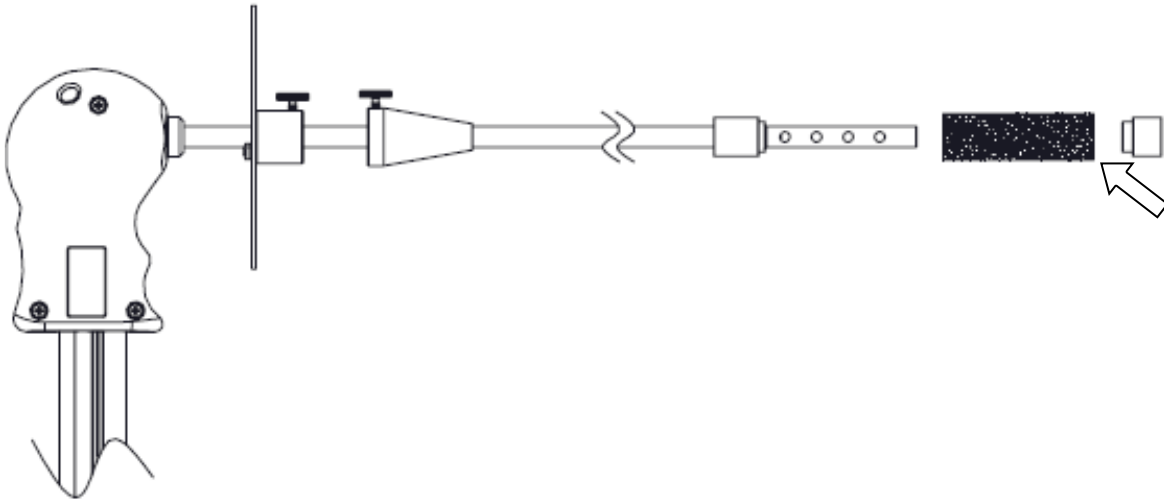

- Blow clean air in both tubes of the probe (shown by the arrow) to release any residual condensate.



- Clean the filter in an ultrasonic bath or by using solvent and steel wire brushes.



- To reassemble the probe logically reverse this procedure.

15.5 Cleaning the heated sampling probe

After using the sampling probe and before placing it in its compartment (available accessory) it is recommended to thoroughly clean it as follows :

- Disconnect the sampling probe from the instrument.
- Disconnect the tube from the heated head and blow clean air in the tube of the probe to release any remaining condensate.

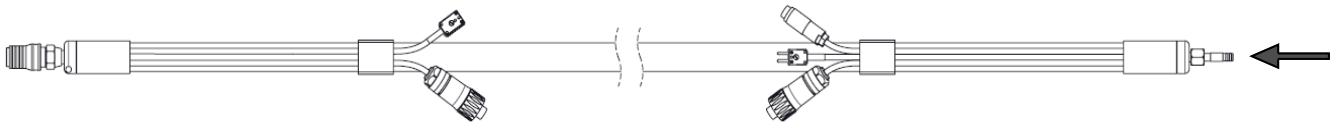

- Open the heated head by unscrewing the body, remove the stainless steel filter and blow clean air in the internal compartment of the filter holder.



CAUTION
OPEN THE HEATED HEAD ONLY WHEN IT IS COMPLETELY COLD.

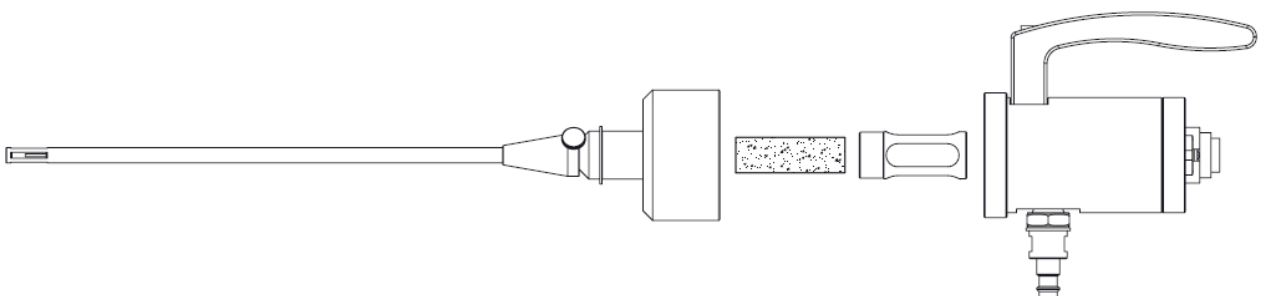
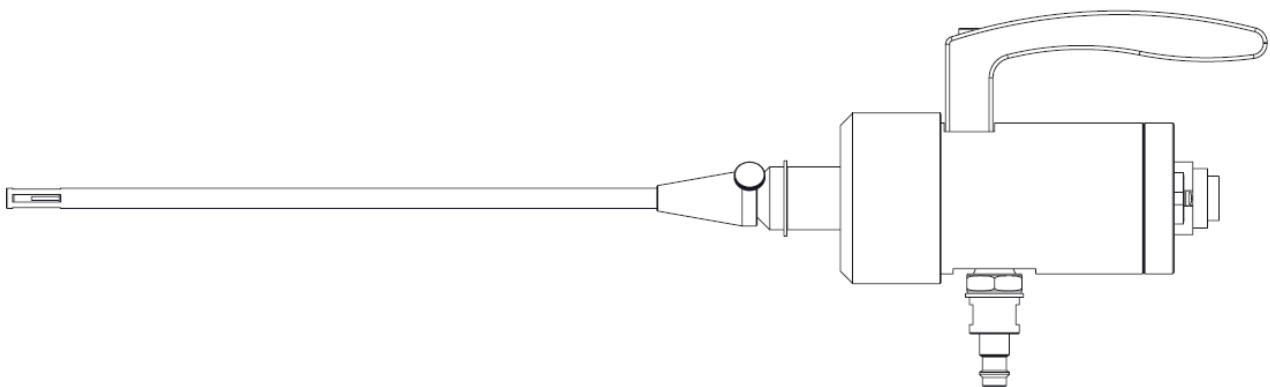

- Clean the filter in an ultrasonic bath or by using solvents and steel wire brushes.



- To reassemble the probe logically reverse this procedure.

15.6 Cleaning the external dust filters

If the external particulate & dust filters have large accumulations of particulates, ash, & dust and/or have any cracks in them, then replace these filters as shown below.

- 1** Unscrew the transparent cover.

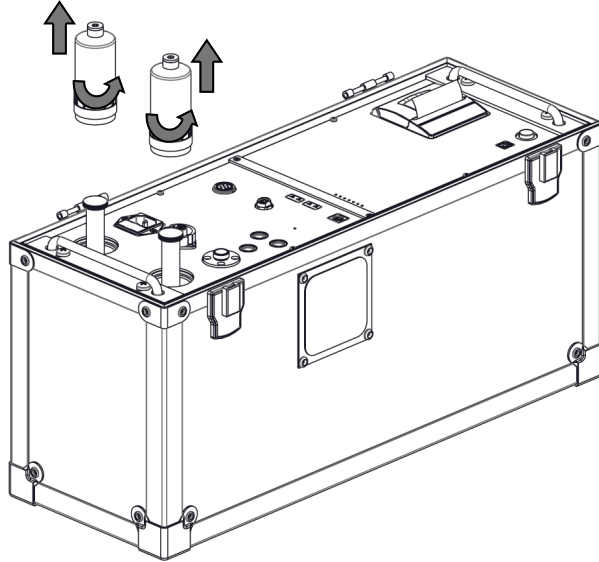

- 2** Unscrew the dust filter

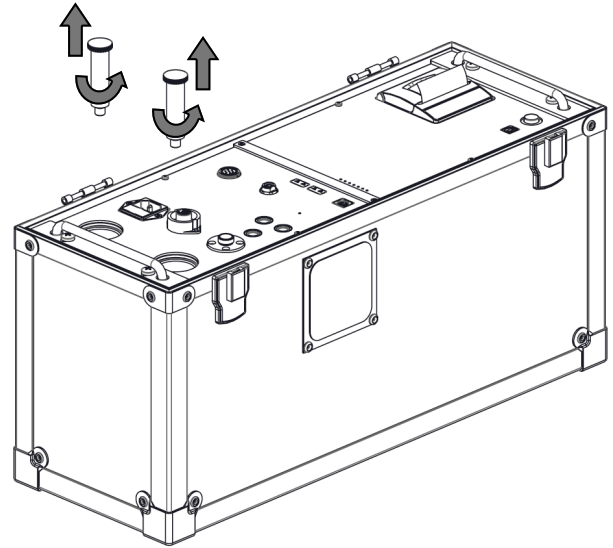

- 3** Clean the cover inside by using compressed air, soap and water or ultrasonic cleaner (do not use solvents or thinners as the case/container is made of PVC plastic material).
- 4** Replace the dust filter with a new one.
- 5** To reassemble the filter logically reverse this procedure.

15.7 Replacing the gas sensors

The gas sensors of the instrument shall be periodically replaced ([see the following table](#)) with new or recalibrated sensors.

The user can easily perform this replacement operation according to the following instructions:

- 1 Gain access to the internal parts of the instrument, as explained in [section 5.3 " Access to internal components "](#).
- 2 Locate the sensor to be replaced; here is an example of a connected sensor to be replaced (with the electrical connector still coupled).

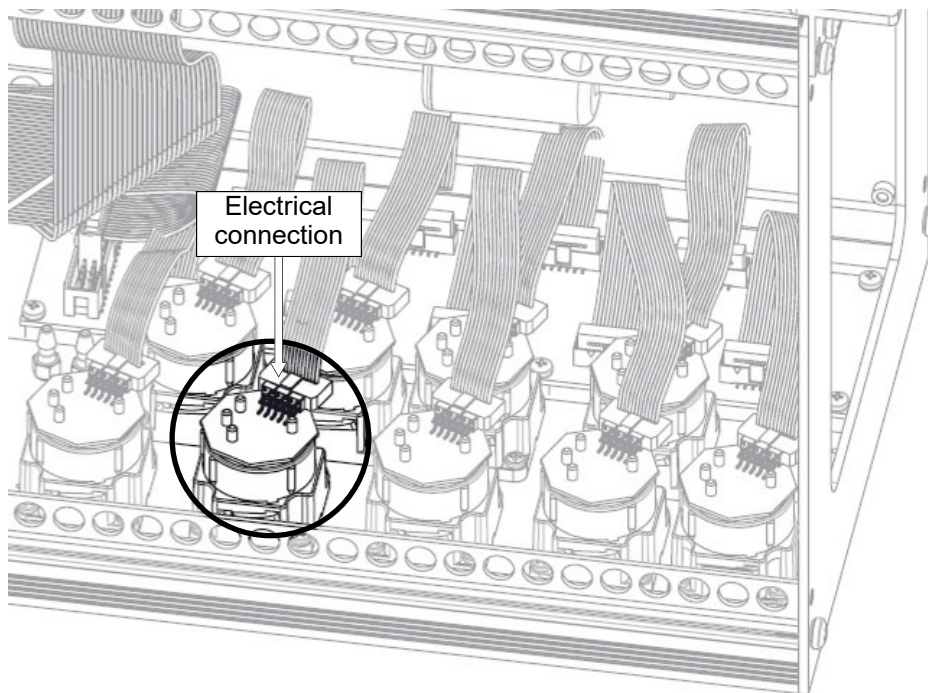

- 3 Disconnect the sensor to be replaced; here is an example of a disconnected sensor to be replaced (the electrical connector has been disconnected).

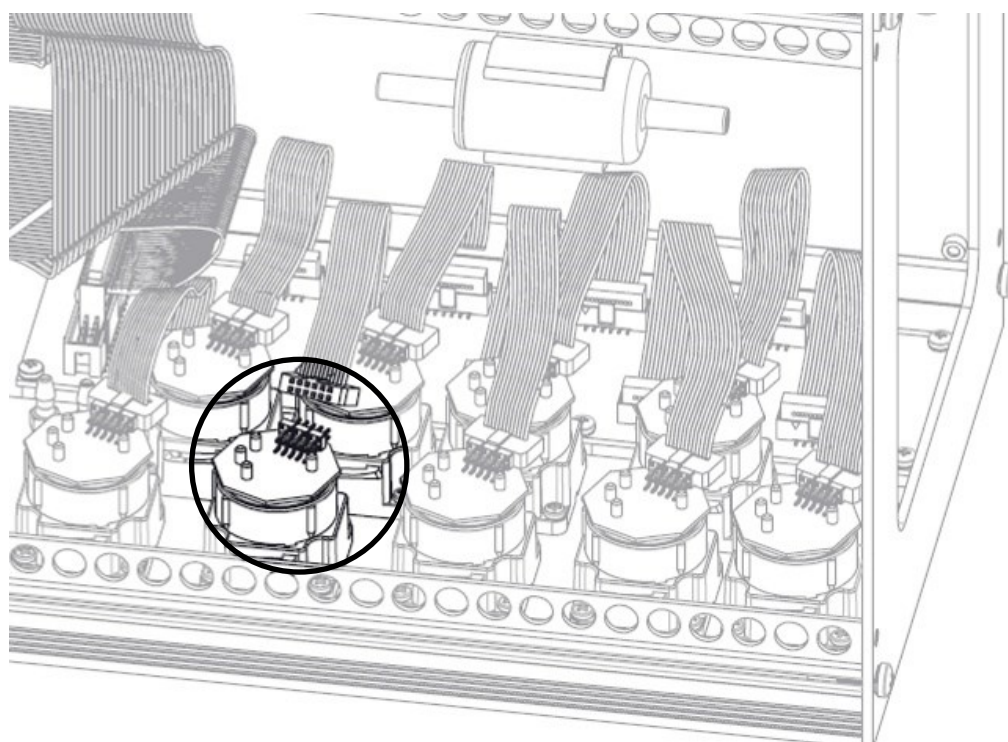

- 4 The sensor is bayonet-connected to its socket; rotate it counter-clockwise to remove it. Here is an example of a rotated sensor.



While rotating the sensor, take care not to exert any pressure on the printed circuit board mounted on the top of the sensor: exert pressure only onto the plastic body.

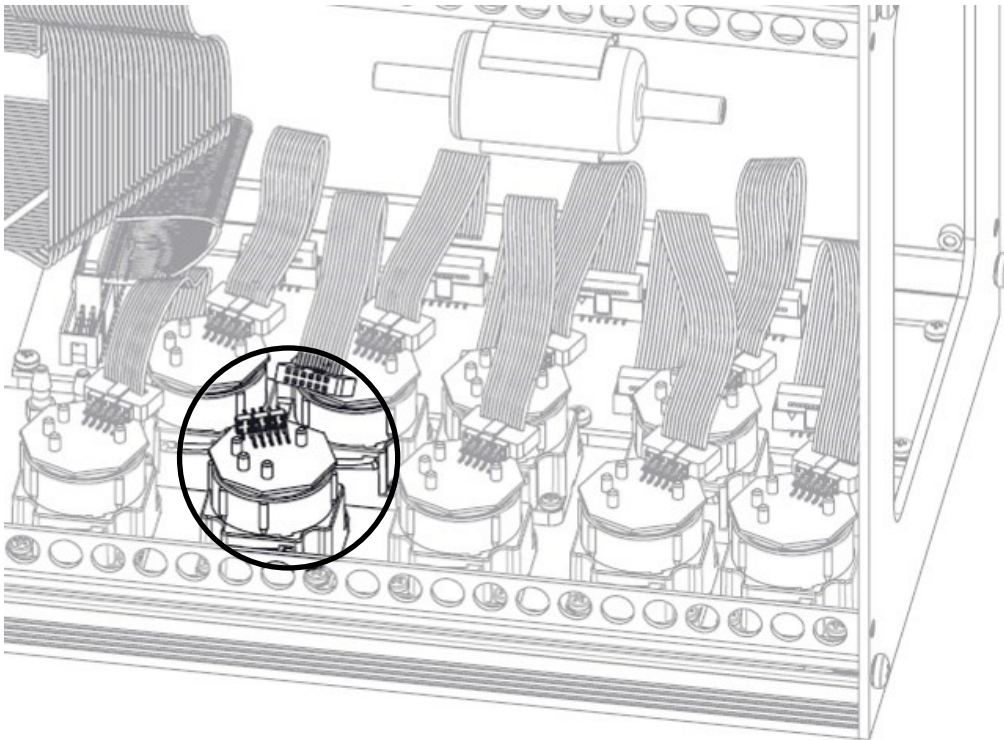

- 5 After rotating the sensor, pull it upward; here is an example of the sensor compartment with a sensor removed.

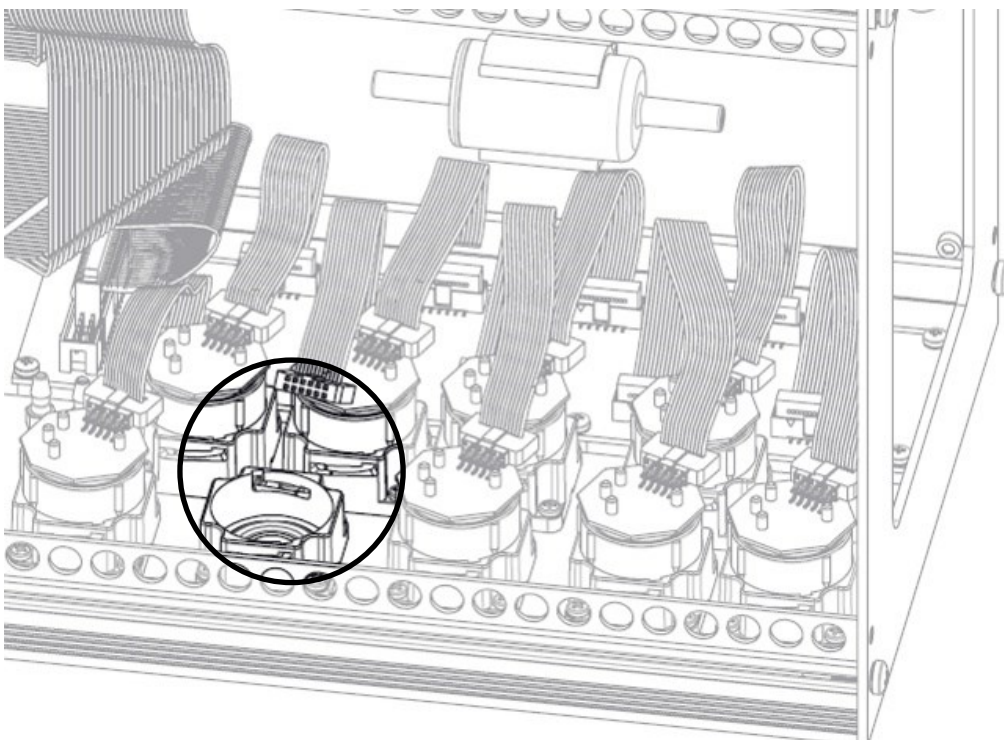

- 6 Fit the new sensor again taking care the electric connection is turned to the outside the instrument, not the inside (See point 4).

- 7 Rotate the sensor clockwise until hearing a click (See point 3).



While rotating the sensor, take care not to exert any pressure onto the printed circuit above: exert pressure onto the plastic body only.

- 8 Reconnect the sensor (See point 2).
- 9 Reinsert the instrument assembly into its case, as described in [section 5.3 " Access to the internal components"](#)

Turn on the instrument to check the new sensor works correctly through the menu "Sensor Troubleshooting". It is normal if a newly installed sensor gives a 'current error': it is necessary to wait some time, so that the sensor polarization can settle. The table here below shows the minimum settling time for each sensor.

CODE	MEASURED GAS	SETTLING TIME
Flex-Sensor O₂ Cod. AACSE15R	O ₂ Oxygen	2 hours
Flex-Sensor CO+H₂ Cod. AACSE12	CO Carbon Monoxide	2 hours
Flex-Sensor CO+H₂ low range Cod. AACSE24	CO Carbon Monoxide	2 hours
Flex-Sensor CO 100.000 ppm Cod. AACSE17	CO Carbon Monoxide	2 hours
Flex-Sensor CO 20.000 ppm Cod. AACSE18	CO Carbon Monoxide	2 hours
Flex-Sensor NO Cod. AACSE10	NO Nitrogen Oxide	48 hours ⁽¹⁾
Flex-Sensor NO low range Cod. AACSE25	NO Nitrogen Oxide	48 hours ⁽¹⁾
Flex-Sensor NO₂ Cod. AACSE14	NO ₂ Nitrogen Dioxide	2 hours
Flex-Sensor NO₂ low range Cod. AACSE26	NO ₂ Nitrogen Dioxide	2 hours
Flex-Sensor SO₂ Cod. AACSE13	SO ₂ Sulphur Dioxide	2 hours
Flex-Sensor SO₂ low range Cod. AACSE28	SO ₂ Sulphur Dioxide	2 hours
FLEX-Sensor C_xH_y 0-5.00% vol. referred to CH₄ Cod. AACSE39	C _x H _y Unburnt Hydrocarbons	1/2 hour
Flex-Sensor CO₂ 0 .. 20% vol. Cod. AACSE41	CO ₂ Carbon Dioxide	2 hours
Flex-Sensor CO₂ 0 .. 50% vol. Cod. AACSE47	CO ₂ Carbon Dioxide	2 hours
Flex-Sensor H₂S 500 ppm Cod. AACSE35	H ₂ S Hydrogen Sulphide	2 hours
Flex-Sensor NH₃ 500 ppm Cod. AACSE56	NH ₃ Ammonia	24 hours
Flex-Sensor H₂ 2000 ppm Cod. AACSE57	H ₂ Hydrogen	2 hours
Flex-Sensor H₂ 40000 ppm Cod. AACSE78	H ₂ Hydrogen	2 hours

Note:

(1) 48 hours settling time is needed; if the sensor is featured with an external polarization battery the settling time becomes 2 hours.

15.8 Replacing the printer paper

Follow these instructions to change the paper roll in the printer.

- 1 Lift the shiny tile, indicated by the arrow.

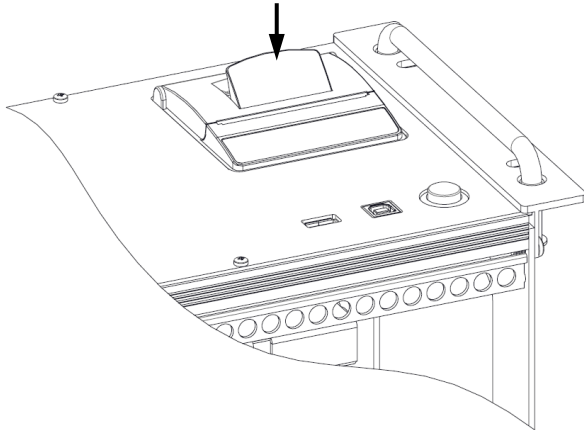

- 2 Lift the whole block of the lid completely.

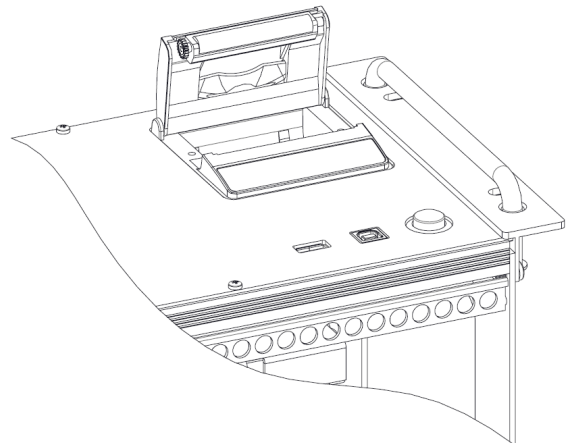

- 3 Insert the roll of printing paper as shown in the following figures.

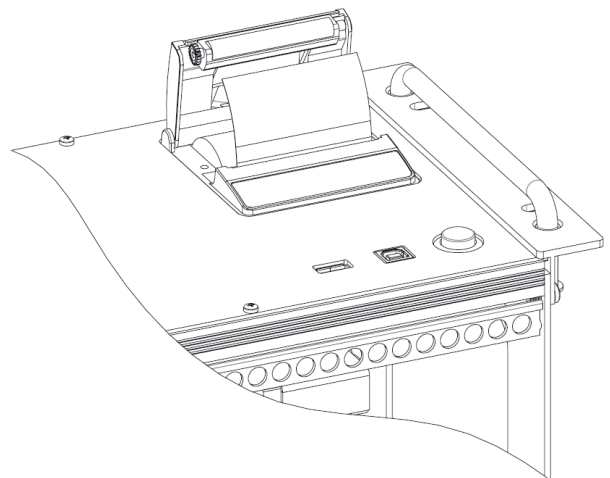
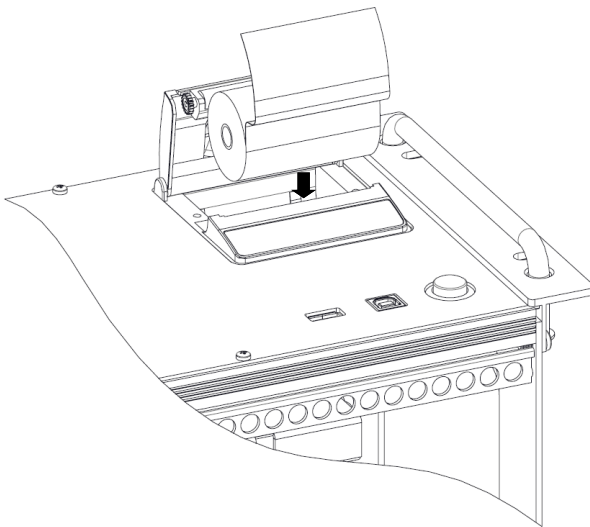

- 4 Close the whole block of the lid of the printer, pressing it lightly so as to hook it on to the device.

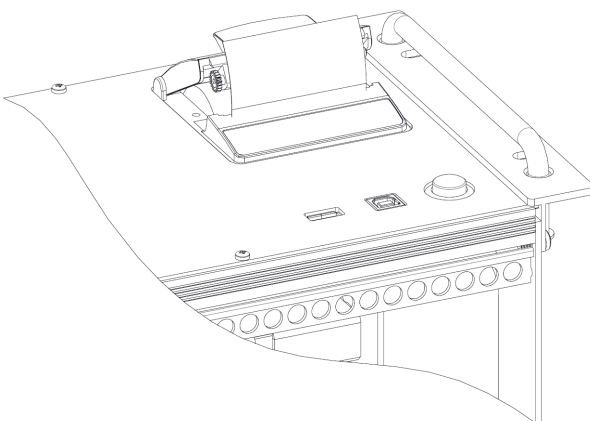

- 5 At this point it is possible to use the printer. See the parameter. [See section 11 "Print"](#).

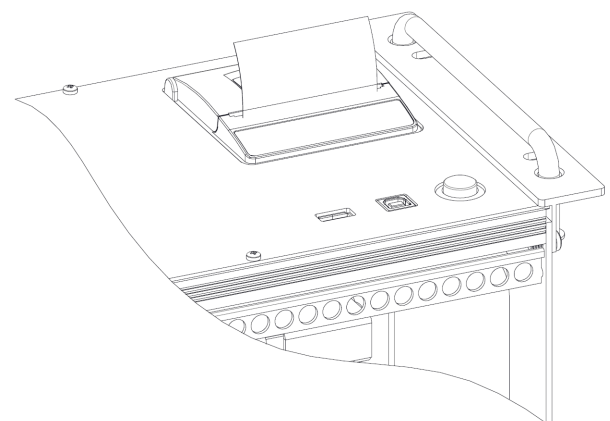

15.9 Firmware Update

The manufacturer periodically releases firmware updates of the instrument in order to correct unavoidable mistakes or improve the instrument performance or add new functions.

This update can be performed by the user by following the simple instructions below.

WARNING:

Since the firmware update could imply a different organization of the data stored in the instrument memory, maintaining the existing analysis data in the instrument is not guaranteed. Therefore it is always mandatory to make the transfer of the analysis from the instrument to the PC prior to the firmware update procedure.

Moreover, for the same reasons, it is absolutely mandatory that the management software tool installed on the PC is updated to a version compatible with the firmware version installed on the instrument.

Instructions to update the combustion analyzer with a new firmware:

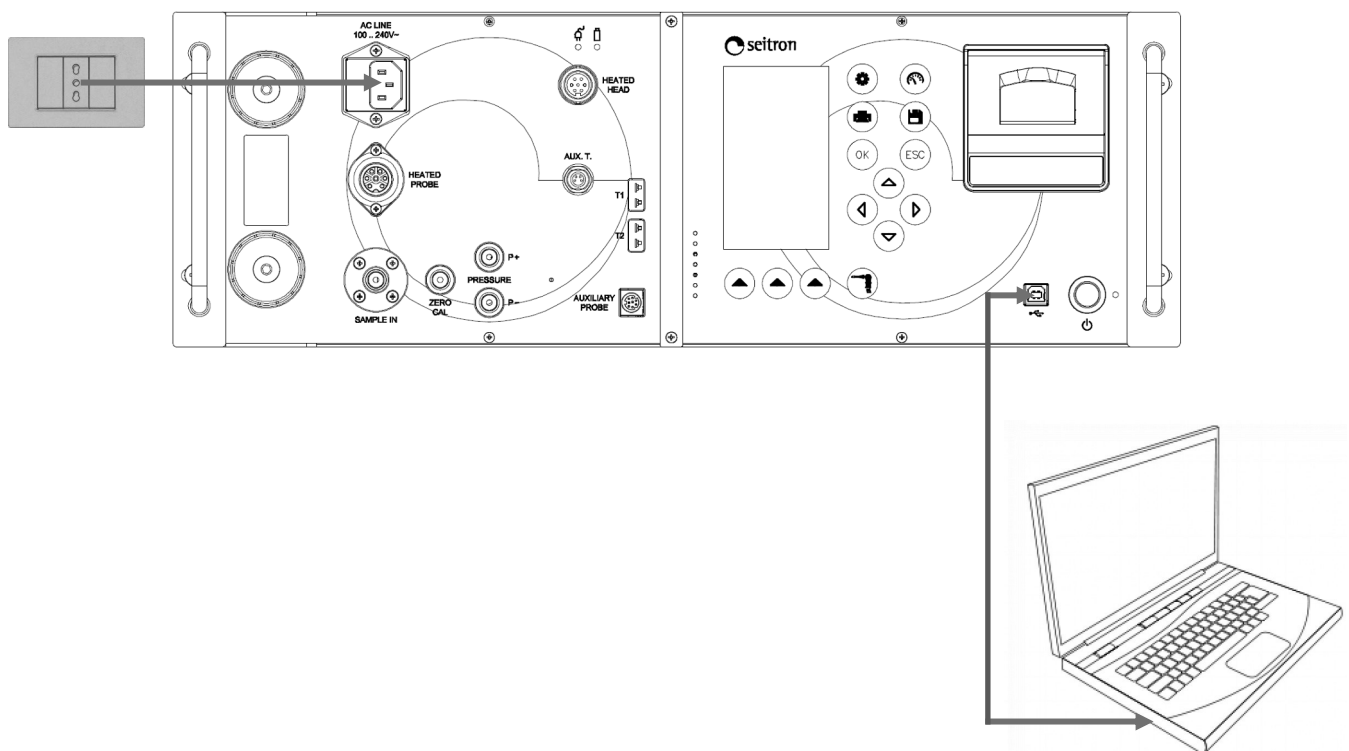

1. Log in to the website www.seitronamericas.com and download the firmware file available in the "combustion analyzers" section. This file is in a compressed version .zip.
2. Unzip the file thus obtaining the contents of the .zip file (extension .srec).
3. Plug in the analyzer to the PC via the USB cable.
4. Connect the analyzer to the mains supply using the cable with the IEC C14 socket supplied
5. Press and hold the ON/OFF key of the combustion analyzer for approx. 10 seconds
6. Release the ON/OFF key; the red led turns on steady
7. Press and hold the ON/OFF key until the red led turns off
8. Release the ON/OFF key; the red led turns on flashing slowly (1 flash/second)
9. The analyzer will be recognized by the operating system as a portable device drive.
10. Copy the firmware file (extension .srec) to the directory of the analyzer.
11. The red led blinks quickly to indicate that the firmware is being updated; wait till the end of the file copy operation.
12. The red led is steady on.
10. The file copy directory will be closed and the analyzer will restart.
11. The analyzer is now updated, it can be powered off and it can be unplugged from the PC and from the mains.

16.1 Troubleshooting guide

SYMPTOM	PROBABLE CAUSES AND REMEDIES
The instrument does not work; when pressing the On/Off key, it does not switch on.	<ul style="list-style-type: none"> a. Press and hold the On/Off key down for longer than 2 seconds. b. The battery is discharged; connect the battery charger to the instrument . c. The battery pack is not connected to the instrument; remove the instrument from its case and insert the connector of the battery pack in the attachment of the printed circuit board. d. The instrument is defective: send it to the service center.
The battery pictogram  , is empty.	Batteries are exhausted. Connect it to the battery charger. If the pictogram is flashing, the shutdown is imminent.
After the instrument turns on, the sensor diagnostic screen displays an error in one or more cells.	Sensor communication error (sensor may be broken or not properly connected) or a change in the sensors installed in relation to the configuration is signaled.
After switching on, the instrument fails to perform the autozeroing.	<ul style="list-style-type: none"> a. If the NDIR bench is installed and enabled, check that the autozero time is set at 70 seconds at least. b. An error has occurred in one or more sensors, see the sensor Diagnostic screen.
The pressure/draft screen signals an error of the piezoresistive temperature compensated pressure sensor.	There is a calibration problem. Send the instrument to the service center.
The analysis screen gives a flue gas temperature (Tf) error.	<ul style="list-style-type: none"> a. The thermocouple is not connected; connect the thermocouple to the analyzer. b. The sensor has been exposed to temperatures greater or lower than its operating temperature range. c. The thermocouple is faulty. Send the complete probe to a service center.
The "----" icon appears in the analysis screen.	The instrument is unable to calculate the numerical value based on the combustion analysis carried out. When the analyzer detects valid combustion data, the "----" icons are replaced with numerical data.
In the analysis screen, the "----" icon appears next to the gases detected by the NDIR bench.	<ul style="list-style-type: none"> a. Check if the NDIR bench is enabled, then switch off and switch the instrument on again. b. If in "Diagnostic→Bench NDIR→Status Register" the CO₂, CO, CH₄ indicate "invalid", it means that the inlet gas is out of the measurement range. c. If in "Diagnostic→Bench NDIR→Status Register" the Sample Temp. indicates "Out of Range", it means that the measurement temperature (detected in the cell /IR tube) is out of the 32-167°F range. d. Warning: in the "Diagnostic→Bench NDIR→Status Register" ignore the messages relating to "Zero Required" and "Proc. In Progress". e. If the problem persists, contact the service center.
"Max. Lim." or "Min. Lim" appears on the analysis screen.	The relevant sensor is detecting a value that is beyond the analyzer measuring range. "Max. Lim" or "Min. Lim." are replaced by numbers when the instrument reveals values that are within the measuring range.

Troubleshooting guide

SYMPTOM	PROBABLE CAUSES AND REMEDIES
The suction pump does not work or the flow is lower than 1,5l/min.	a. The suction flow is blocked. Check that the particulate filter is clean. b. Contact the service center.
The instrument is switched on, but the display seems to be off.	a. Check the display brightness level (see the configuration menu). b. If the problem persists, contact the service center.
The heated probe is enabled, but the heated tube status displays 'disab.'.	The probe connector is not properly connected to the 'HEATED PROBE' connector of the instrument .
The heated probe is enabled, but the heated tube status displays 'off'.	The instrument is not connected to the power supply.
The heated probe is enabled, but the heated head status displays 'disab.'.	The heated head connector is not properly connected to the 'HEATED HEAD' connector of the instrument .
T head indicates ' no probe '.	The heated head connector is not properly connected to the 'HEATED HEAD' connector of the instrument .
T tube indicates ' no probe '.	The heated head connector is not properly connected to the 'HEATED PROBE' connector of the instrument .
T tube and/or T head indicates ' error '.	a. The connector may be damaged. b. The cable of the temperature sensor may be damaged. Send it to the service center.
The heated probe is enabled, but the tube status and/or the head status and/or Peltier status display ' fault '.	a. Check that the T head, T tube and T Peltier temperatures are within the parameters that have been set. b. Contact the service center.
The Cooler is enabled, but the Peltier status indicates ' fault '.	a. Check that the T Peltier temperature is within the parameter that has been set. b. Contact the service center.
The integrated printer of the instrument does not print.	a. Check that the set printer is the internal printer. b. Start the test print; if the problem persists, contact the service center.

17.1 Spare parts

CODE	DESCRIPTION
AAPB12	Li-Ion 11,1V 5,2Ah battery pack
AARC10	Unfading printing thermal paper roll 2,2"x1,4"
AACADX005	Dummy sensor
AACSE15R	FLEX-Sensor O ₂ , pre-calibrated and interchangeable
AACSE12	FLEX-Sensor CO+H ₂ , pre-calibrated and interchangeable
AACSE10	FLEX-Sensor NO/NO _x , pre-calibrated and interchangeable
AACSE14	FLEX-Sensor NO ₂ , pre-calibrated and interchangeable
AACSE13	FLEX-Sensor SO ₂ , pre-calibrated and interchangeable
AACSE17	FLEX-Sensor CO 100.000 ppm, pre-calibrated and interchangeable
AACSE18	FLEX-Sensor CO 20.000 ppm, pre-calibrated and interchangeable
AACSE39	FLEX-Sensor CxHy related to CH ₄ , pre-calibrated and interchangeable
AACSE24	FLEX-Sensor CO+H ₂ low range, pre-calibrated and interchangeable
AACSE25	FLEX-Sensor NO low range, pre-calibrated and interchangeable
AACSE26	FLEX-Sensor NO ₂ low range, pre-calibrated and interchangeable
AACSE28	FLEX-Sensor SO ₂ low range, pre-calibrated and interchangeable
AACSE41	FLEX-Sensor CO ₂ 0-20% v/v, pre-calibrated and interchangeable
AACSE47	FLEX-Sensor CO ₂ 0-50% v/v, pre-calibrated and interchangeable
AACSE35	FLEX-Sensor H ₂ S, pre-calibrated and interchangeable
AACSE56	FLEX-Sensor NH ₃ , pre-calibrated and interchangeable
AACSE57	Flex-Sensor H ₂ 2000ppm, pre-calibrated and interchangeable
AACSE78	Flex-Sensor H ₂ 40000ppm, pre-calibrated and interchangeable
AAHH04	Heated head
AATR01	3 meters Electro-heated cable
AAPT01	300 mm tip for smoke probe with heated head
AAPT02	1000 mm tip for smoke probe with heated head
WFILX0022	Syntherized steel filter
WRACH0056	Female quick connector for heated cable; Italian and German profile compatibility
WRACH0057	Male quick connector for heated head; Italian and German profile compatibility
AASY01	Heated head black smoke measurement probe without tip
AAPT03	300 mm tip for black smoke probe with heated head
AAPT04	750 mm tip for black smoke probe with heated head
AS0000MF	Black smoke filter
AASU01	Black smoke measurement scale

17.2 Accessories

CODE	DESCRIPTION
AACCV01	Schuko plug cable.
AACCV04	European plug cable.
AACCV06	US plug cable.
AACDP02	Deprimometer for Draft test.
AACSO01	Probe for measuring the ionization current.
AACSA04	100 mm tip auxiliary temperature probe PT100 4w with 3 mt cable.
AASA08	200 mm tip remote combustion air temperature probe with 2 mt cable.
AASF31	180 mm flue gas sampling probe with 3 mt cable. Working temperature range: 400°C.
AASF32	300 mm flue gas sampling probe with 3 mt cable. Working temperature range: 600°C.
AASF35	750 mm flue gas sampling probe with 3 mt cable. Working temperature range: 800°C.
AASF36	1000 mm flue gas sampling probe with 3 mt cable. Working temperature range: 1200°C.
AASX03	750 mm flue gas sampling probe for industrial engines with 3 mt cable.
AASX04	Special smoke probe for the black smoke measurement with 300 mm tip and 3,5 m cable.
AASX05	Special smoke probe for the black smoke measurement with 750 mm tip and 3,5 m cable.
AACEX02S	3 m extension cable for gas sampling probe.
AASR03	Flue gas sampling probe with heated head, 300 mm tip and electro-heated 3 mt tube with thermocouple.
AASR04	Flue gas sampling probe with heated head, 1000 mm tip and electro-heated 3 mt tube with thermocouple.
AASP01	Heat protection shield for flue gas sampling probes.
AATT01	'L' shaped Pitot Tube (without Tc-K thermocouple): length 300mm - external \varnothing 6 mm. Supplied with two silicone tubes with length 2 meters.
AATT02	'L' shaped Pitot Tube (without Tc-K thermocouple): length 800mm - external \varnothing 6 mm. Supplied with two silicone tubes with length 2 meters.
AACKP01	Differential pressure kit.
AAPM02	Manual pump kit for smoke measurement.
AASW08	Configuration software on USB flash drive.
AAUA01	USB-A / USB-B adapter cable.
AAEB02	Trunk extension.
AATY01	Trunk trolley.
AATS01	Remote condensate drain hose.
AACKP02	Remote air intake hose.
AAFA03	Filtering cartridge HDPE 100um 12x32mm, 2 pieces.
AATT03	36" (900mm) S-Type Pitot Tube for Gas Velocity
SP4500	S-Probe attachment for forklifts and small engines

17.3 Service Centers

Headquarters:

Seitron Americas Inc.

4622 Street Rd

Trevose, PA 19053

Tel: (215) 660-9777

Email: service@seitronamericas.com

Web: www.seitronamericas.com

Example of Total analysis report.

COMPANY Ltd.
Park Road, 9
Tel.02/12345678

Oper.: John Smith

Sign.: _____

S9000 X
Serial: 999989

Memory: 01
Analysis: Average
Date: 04/04/14
Time: 10.30

Fuel: Natural gas
Altitude: 0 m
R.H. air: 50 %

O ₂	15.7 %
CO ₂	2.9 ppm
λ,n	4.01
T flue	100.6 °C
T air	27.0 °C
dT	73.6 %
QS	10.0 %
Es	90.0 %
Ec	0.0 %
Et	90.0 %
CO	23 ppm
NO	14 ppm
NO _x	15 ppm
Ref. O ₂ :	0.0 %
CO ref	92 ppm
Ref. O ₂ :	0.0 %
NO ref	56 ppm
Ref. O ₂ :	0.0 %
NO _x ref.:	60 ppm
Draft	4.5 Pa
T ext.	10.0 °C

Note: -----

Analysis: 1
04/03/16 10.00

O ₂	15.7 %
CO ₂	2.9 %
λ,n	4.01
T flue	100.4 °C
T air	27.0 °C
dT	73.4 °C
QS	10.0 %
Es	90.0 %
Ec	0.0 %
Et	90.0 %
CO	23 ppm
NO	14 ppm
NO _x	15 ppm
Ref. O ₂ :	0.0 %
CO ref	92 ppm
Ref. O ₂ :	0.0 %
NO ref	52 ppm
Ref. O ₂ :	0.0 %
NO _x ref.:	56 ppm
Tiraggio	4.5 Pa
T ext.	10.0 °C

Analysis: 2
04/03/16 10.15

O ₂	15.7 %
CO ₂	2.9 %
λ,n	4.01
T flue	100.6 °C
T air	27.0 °C
dT	73.6 °C
QS	10.0 %
Es	90.0 %
Ec	0.0 %
Et	90.0 %
CO	23 ppm
NO	14 ppm
NO _x	15 ppm
Ref. O ₂ :	0.0 %
CO ref	92 ppm
Ref. O ₂ :	0.0 %
NO ref	56 ppm
Ref. O ₂ :	0.0 %
NO _x ref.:	60 ppm
Draft	4.5 Pa
T ext.	10.0 °C

Analysis: 3
04/03/16 10.20

O ₂	15.7 %
CO ₂	2.9 %
λ,n	4.01
T flue	100.8 °C
T air	27.0 °C
dT	73.8 °C
QS	10.1 %

Es	89.9 %
Ec	0.0 %
Et	89.9 %
CO	23 ppm
NO	14 ppm
NO _x	15 ppm
Ref. O ₂ :	0.0 %
CO ref	92 ppm
Ref. O ₂ :	0.0 %
NO ref	56 ppm
Ref. O ₂ :	0.0 %
NO _x ref.:	60 ppm
Draft	4.5 Pa
T ext.	10.0 °C

Example of Full analysis report.

```

COMPANY Ltd.
Park Road, 9
Tel.02/12345678

Oper.: John Smith

Sign.: _____

s9000 x
Serial: 999989

Memory: 01
Analysis: Average
Date: 04/04/14
Time: 10.30

Fuel: Natural gas
Altitude: 0 m
R.H. air: 50 %

O2                15.9 %
CO2                2.8 ppm
λ,n               4.18
T flue            80.6 °C
T air             26.9 °C
dT               53.7 %
Qs                7.6 %
Es               92.4 %
Ec                0.0 %
Et               92.4 %
CO                 27 ppm
NO                 11 ppm
NOx               12 ppm
Ref. O2:          0.0 %
CO ref            113 ppm
Ref. O2:          0.0 %
NO ref            46 ppm
Ref. O2:          0.0 %
NOx ref.:         50 ppm
Draft             4.5 Pa
T ext.            10.0 °C

Note: -----
-----
-----
-----
-----
-----
-----

```

Example of Partial Paper print-out.

```

Date: 04/04/14
Time: 10.15

Fuel: Natural gas
Altitude: 0 m
R.H. air: 50 %

O2                15.7 %
CO2                2.9 ppm
λ,n               4.01
T flue            95.4 °C
T air             26.9 °C
dT               68.5 %
Qs                9.3 %
Es               90.7 %
Ec                0.0 %
Et               90.7 %
CO                 23 ppm
NO                 13 ppm
NOx               14 ppm
Ref. O2:          0.0 %
CO ref            92 ppm
Ref. O2:          0.0 %
NO ref            52 ppm
Ref. O2:          0.0 %
NOx ref.:         56 ppm
Smoke             4.5 Pa
T ext.            10.0 °C

Smoke:    3  1  2
Aver n°:   2

```

Example of Draft Paper print-out.

```

COMPANY Ltd.
Park Road, 9
Tel.02/12345678

Oper.: John Smith

Sign.: _____

s9000 x
Serial: 999989
Memory: 01

Date: 04/04/14
Time: 10.30

Draft             4.5 Pa
T ext.            10.0 °C

Note: -----
-----
-----
-----

```

Example of Smoke Paper print-out.

```

COMPANY Ltd.
Park Road, 9
Tel.02/12345678

Oper.: John Smith

Sign.: _____

S9000 X
Serial: 999989
Memory: 01

Date: 04/04/14
Time: 10.30

Fuel: Diesel

Smoke:      3  1  2
Aver. n°:   2

Note: -----
-----
-----

```

Example of ambient CO Paper print-out.

```

COMPANY Ltd.
Park Road, 9
Tel.02/12345678

Oper.: John Smith

Sign.: _____

S9000 X
Serial: 999989
Memory: 01

Date: 04/04/14
Time: 10.30

CO amb           0 ppm

Note: -----
-----
-----

```

Example of Velocity Paper print-out.

```

COMPANY Ltd.
Park Road, 9
Tel.02/12345678

Oper.: John Smith

Sign.: _____

S9000 X
Serial: 999989
Memory: 01

Date: 04/04/14
Time: 10.30

Gas: Air

V air           9.11 km/h
Density         1.199 kg/m³
Altitude        0 ft
T air           25.3 °C
K Pitot         0.980

Note: -----
-----
-----

```

Coefficients of the fuels and Formulas

The following chart lists the coefficients of the memorised fuels, used for calculating losses and efficiencies. Details of the coefficients of the fuels:

Coefficients for calculating combustion efficiency								
Fuel	A1 USA	B	CO ₂ t (%)	LHV (KJ/Kg)	HHV (KJ/Kg)	M air (Kg/Kg)	M H ₂ O (Kg/Kg)	V dry gas (m ³ /Kg)
Natural Gas	0.0280	0.0090	11.70	50050	55550	17.17	2.250	11.94
#2 Oil	0.0305	0.0066	15.70	42900	45700	14.30	1.136	10.34
#4 Oil	0.0306	0.0066	15.80	41100	43500	13.80	0.973	10.06
#6 Oil	0.0346	0.0048	16.00	39800	42197	13.61	0.981	9.97
Diesel	0.0305	0.0066	15.70	42900	45700	14.30	1.136	10.34
Wood/Pellets 8%	0.0354	0.0071	19.01	18150	19750	6.02	0.660	4.58
Bagasse	0.0395	0.0219	20.45	6950	8834	2.50	0.779	1.93
Coal	0.0320	0.0000	18.60	31400	32300	10.70	0.370	8.14
Biogas	0.0353	0.0091	17.33	17800	19800	6.08	0.830	4.55
Bio-Fuel 5%	0.0305	0.0066	15.70	42600	45400	14.22	1.133	10.64
Butane	0.0277	0.0073	14.00	45360	49150	15.38	1.548	10.99
Propane	0.0277	0.0073	13.70	45950	49950	15.61	1.638	11.11
B20	0.0313	0.0052	15.52	41806	44620	14.04	1.152	13.89

- **CO₂ t:** The value of CO₂ generated by combustion in stoichiometric condition, i.e. without excess Oxygen and therefore maximum.
- **A1, A2, B:** Also please have a look at the Siegert formulas from the European standard EN50379-1 (in the following).
A1 is the parameter in the Siegert Formula when the O₂ measurement is available.
A2 is used when the CO₂ measurement is available.
Note: - Please also consider that in the U.S. usually the A1 parameter is the same as the 'european' A1 BUT divided by 2.
- For Germany coefficients A1 and A2 are swapped.

Flue gas heat losses are calculated from measured oxygen content according to the relationship:

$$q_A = (t_A - t_L) \times \left(\frac{A1}{21 - O_2} + B \right)$$

Flue gas heat losses are calculated from measured carbon dioxide content according to the relationship:

$$q_A = (t_A - t_L) \times \left(\frac{A2}{CO_2} + B \right)$$

Air index is calculated with the formula:

$\lambda = 21 / (21 - O_2)$, where O₂ is the oxygen residual concentration in the combustion smokes.

Air excess is calculated with the formula:

$$e = (\lambda - 1) * 100$$

- **CO conv:** Conversion coefficient from ppm to mg/KWh. It can be expressed as a function of the gas density (CO in this case) and the volume of the dry smoke.
- **NO conv:** Same as CO conv, but for NO.
- **NOx conv:** Same as CO conv, but for NOx.
- **SO₂ conv:** Same as CO conv, but for SO₂.
- **LHV:** Lower Heating Value.
- **HHV:** Higher Heating Value.
- **m H₂O:** Mass of the air produced (per each Kg of fuel) in the combustion in stoichiometric condition.
- **m Air:** Mass of the air needed for combustion in stoichiometric condition.
- **V g.d.:** Volume of dry smokes produced in the combustion.

Optional measures list:

MEASURE	DEFINITION
λ, n	Air index (defined as λ , sometimes also indicated as n).
e	Air excess. Expressed as a percentage according to the formula in the appendix B, is the ratio between the volume of air actually entering the combustion chamber and the one theoretically needed.
ΔT	Differential temperature: It is the difference between the smoke temperature and the air combustion temperature.
Q_s (LHV)	Stack losses in relation to the Lower Heating Value: It is the percentage of dissipated heat through the stack referred to the lower heating value (LHV)
Q_s (HHV)	Stack losses in relation to the Higher Heating Value: It is the percentage of dissipated heat through the stack referred to the higher heating value (HHV)
η_s (LHV)	Sensible efficiency in relation to the Lower Heating Value: It is the burner efficiency calculated according to the standard, as the ratio between conventional heating power and the burner heating power. Among the combustion losses, only the sensible heat lost with flue gasses is taken into account, thus neglecting the radiation losses and incomplete combustion losses. This value is referred to the Lower Heating Value (LHV) of the fuel and cannot exceed 100%. The sensible efficiency value is to be compared against minimum efficiency stated for the heating system performances.
η_s (HHV)	Sensible efficiency in relation to the Higher Heating Value: It is the burner efficiency calculated as the ratio between conventional heating power and the burner heating power. Among the combustion losses, only the sensible heat lost with flue gasses is taken into account, thus neglecting the radiation losses and incomplete combustion losses. This value is referred to the Higher Heating Value (HHV) of the fuel and cannot exceed 100%. The sensible efficiency value is to be compared against minimum efficiency stated for the heating system performances.
η_c (LHV)	Condensation efficiency in relation to the Lower Heating Value: Efficiency deriving from the condensation of water vapour contained in flue gases, calculated according to the standard, and it is referred to the LHV.
η_c (HHV)	Condensation efficiency in relation to the Higher Heating Value: Efficiency deriving from the condensation of water vapour contained in flue gases referred to the HHV.
η_t (LHV) $\eta_t = \eta_s + \eta_c$	Total efficiency in relation to the Lower Heating Value: Total efficiency. It is the sum of sensible efficiency and condensation efficiency. It is referred to LHV (Lower Heating Value) and can exceed 100%.

MEASURE	DEFINITION
η_t (HHV)	Total efficiency in relation to the Higher Heating Value: Total efficiency. It is the sum of sensible efficiency and condensation efficiency. It is referred to HHV (Higher Heating Value) and can not exceed 100%.
Q_t (HHV)	Total stack losses: It is the total heat percentage dissipated through the stack.
NOx	Measure of nitrogen oxides quantity; the measurement unit can be set in the special menu.
NOx ppm *	Measure of nitrogen oxides quantity; the measurement unit can not be set but it is fixed in ppm.
NOx (rif. O2)	Measure of nitrogen oxides quantity referring to O2; the measurement unit can be set in the special menu.
NOx (rif. O2) ppm *	Measure of nitrogen oxides quantity referring to O2; the measurement unit can not be set but it is fixed in ppm.
PI	Poison Index (CO/CO2 ratio): It is defined as the ratio between CO and CO2 useful to determine whether the system needs maintenance.
CO	CO quantity measurement. Measurement units: ppm - mg/m ³ - mg/kWh - g/GJ - g/m ³ - mg/kWh - % - ng/J
CO (RIF)	CO quantity measurement with O2 reference. Measurement units: ppm - mg/m ³ - mg/kWh - g/GJ - g/m ³ - g/kWh - % - ng/J
T dew	Flue water condensation temperature (Dew point). This value is calculated.

* : Valid for Piemonte region only (Italy only).



OTHER THAN THE MEASUREMENT LIST ABOVE, IT IS POSSIBLE TO VISUALIZE THE MEASURE OF THE DETECTED GAS ALSO IN PPM, DEPENDING ON THE KIND OF MEASUREMENT CELL IN THE INSTRUMENT. IF IT IS NECESSARY TO MEASURE THE VALUE OF GAS WITH TWO DIFFERENT MEASUREMENT UNITS, SELECT IN THE MEASUREMENTS LIST THE DESIRED GAS IN PPM AND CHANGE THE MEASUREMENT UNIT FOR THE SAME GAS IN THE "CONFIGURATION->ANALYSIS->MEASUREMENT UNIT" SCREEN. NOW THE INSTRUMENT ACQUIRES THE MEASURE WITH TWO DIFFERENT UNITS (PPM AND THE ONE PREVIOUSLY SET)

WARRANTY CERTIFICATE

WARRANTY

S9000 combustion analyzer is guaranteed for 24 months from the date of delivery note, electronic parts, measurement cells and printer included.
Seitron Americas undertakes to repair or replace, free of charge, those parts that, in its opinion, are found to be faulty during the warranty period. The products which are found defective during the above mentioned periods of time have to be delivered to Seitron Americas Laboratories carriage paid. The following cases are not covered by this warranty: accidental breakage due to transport, inappropriate use or use that does not comply with the indications in the product's use and maintenance manual.
Any mistreatment, repairs and modifications to the product not explicitly authorized by Seitron Americas shall invalidate the present warranty.

IMPORTANT

For the product to be repaired under Warranty, please send a copy of this Certificate along with the instrument to be repaired, together with a brief explanation of the fault observed.

Space reserved for user

Name: _____

Company: _____

User's notes:

Date: _____

S.N.: _____



Seitron Americas Inc.

4622 Street Rd. Trevose, PA 19053 - USA

service@seitronamericas.com - www.seitronamericas.com