

ScopeMeter 190 Series II

Fluke 190-062, -102, -104, -202, -204, -502, -504

Service Manual

LIMITED WARRANTY AND LIMITATION OF LIABILITY

Each Fluke product is warranted to be free from defects in material and workmanship under normal use and service. The warranty period is three years and begins on the date of shipment. Parts, product repairs, and services are warranted for 90 days. This warranty extends only to the original buyer or end-user customer of a Fluke authorized reseller, and does not apply to fuses, disposable batteries, or to any product which, in Fluke's opinion, has been misused, altered, neglected, contaminated, or damaged by accident or abnormal conditions of operation or handling. Fluke warrants that software will operate substantially in accordance with its functional specifications for 90 days and that it has been properly recorded on non-defective media. Fluke does not warrant that software will be error free or operate without interruption.

Fluke authorized resellers shall extend this warranty on new and unused products to end-user customers only but have no authority to extend a greater or different warranty on behalf of Fluke. Warranty support is available only if product is purchased through a Fluke authorized sales outlet or Buyer has paid the applicable international price. Fluke reserves the right to invoice Buyer for importation costs of repair/replacement parts when product purchased in one country is submitted for repair in another country.

Fluke's warranty obligation is limited, at Fluke's option, to refund of the purchase price, free of charge repair, or replacement of a defective product which is returned to a Fluke authorized service center within the warranty period.

To obtain warranty service, contact your nearest Fluke authorized service center to obtain return authorization information, then send the product to that service center, with a description of the difficulty, postage and insurance prepaid (FOB Destination). Fluke assumes no risk for damage in transit. Following warranty repair, the product will be returned to Buyer, transportation prepaid (FOB Destination). If Fluke determines that failure was caused by neglect, misuse, contamination, alteration, accident, or abnormal condition of operation or handling, including overvoltage failures caused by use outside the product's specified rating, or normal wear and tear of mechanical components, Fluke will provide an estimate of repair costs and obtain authorization before commencing the work. Following repair, the product will be returned to the Buyer transportation prepaid and the Buyer will be billed for the repair and return transportation charges (FOB Shipping Point).

THIS WARRANTY IS BUYER'S SOLE AND EXCLUSIVE REMEDY AND IS IN LIEU OF ALL OTHER WARRANTIES, EXPRESS OR IMPLIED, INCLUDING BUT NOT LIMITED TO ANY IMPLIED WARRANTY OF MERCHANTABILITY OR FITNESS FOR A PARTICULAR PURPOSE. FLUKE SHALL NOT BE LIABLE FOR ANY SPECIAL, INDIRECT, INCIDENTAL OR CONSEQUENTIAL DAMAGES OR LOSSES, INCLUDING LOSS OF DATA, ARISING FROM ANY CAUSE OR THEORY.

Since some countries or states do not allow limitation of the term of an implied warranty, or exclusion or limitation of incidental or consequential damages, the limitations and exclusions of this warranty may not apply to every buyer. If any provision of this Warranty is held invalid or unenforceable by a court or other decision-maker of competent jurisdiction, such holding will not affect the validity or enforceability of any other provision.

Fluke Corporation
P.O. Box 9090
Everett, WA 98206-9090
U.S.A.

Fluke Europe B.V.
P.O. Box 1186
5602 BD Eindhoven
The Netherlands

Table of Contents

Chapter	Title	Page
1	Safety Instructions	1-1
	Introduction.....	1-3
	Safety Precautions.....	1-3
	Caution and Warning Statements	1-3
	Symbols.....	1-4
	Li-ion Battery Pack.....	1-7
	Safe Storage of Battery Pack	1-7
	Safe Use of Battery Pack	1-8
	Safe Transport of Battery Pack.....	1-9
	Safe Disposal of Battery Pack	1-9
2	Specifications	2-1
	Introduction.....	2-3
	Oscilloscope	2-3
	Automatic Scope Measurements	2-6
	Meter Measurements for Fluke 190-xx4.....	2-9
	Meter Measurements for Fluke 190-xx2.....	2-9
	Recorder.....	2-11
	Zoom, Replay and Cursors	2-12
	Miscellaneous.....	2-12
	Environmental.....	2-14
	Certifications.....	2-14
	Safety	2-14
	10:1 Probe VPS410	2-16
	Electromagnetic Immunity.....	2-16
3	Parts List	3-1
	Introduction.....	3-3
	How to Obtain Parts.....	3-3
	Final Assembly Parts	3-4
	Accessory List	3-8
4	Performance Verification.....	4-1
	Introduction.....	4-3
	Equipment Requirements for Verification.....	4-4
	General Instructions.....	4-4
	Operation Instructions.....	4-4
	Reset the Test Tool	4-4
	Menu Navigation.....	4-5
	Standard Test Tool Setup.....	4-5
	Display and Backlight Test.....	4-7

	Scope Input A, B, C, D Tests	4-8
	Input A, B, C, D Vertical Accuracy Test	4-8
	Input A, B, C, D DC Voltage Accuracy Test	4-11
	Input A, B, C, D AC Voltage Accuracy Test (LF)	4-14
	Input A, B, C, D AC-Coupled Lower Frequency Test	4-16
	Input A, B, C, D Peak Measurements Test	4-17
	Input A, B, C, D Frequency Measurement Accuracy Test	4-18
	Input A&B / C&D Phase Measurements Test	4-19
	Time Base Test	4-20
	Input A Trigger Sensitivity Test	4-21
	Input A AC Voltage Accuracy (HF) and Bandwidth Test	4-23
	Input B Trigger Sensitivity Test	4-24
	Input B AC Voltage Accuracy (HF) and Bandwidth Test	4-25
	Input C Trigger Sensitivity Test	4-26
	Input C AC Voltage Accuracy (HF) and Bandwidth Test	4-27
	Input D Trigger Sensitivity Test	4-28
	Input D AC Voltage Accuracy (HF) and Bandwidth Test	4-30
	Video Test with SC600 Scope Calibration Option	4-31
	External Trigger Level Test	4-34
	Meter Tests	4-35
	Meter DC Voltage Accuracy Test	4-35
	Meter AC Voltage Accuracy and Frequency Response Test	4-36
	Continuity Function Test	4-37
	Diode Test Function Test	4-37
	Ohms Measurements Test	4-38
	Probe Calibration Generator Test	4-39
5	Calibration Adjustment	5-1
	Introduction	5-3
	General	5-4
	Calibration Number and Date	5-4
	General Instructions	5-4
	Equipment Required For Calibration	5-5
	Calibration Procedure Steps	5-5
	How to Start the Calibration	5-6
	Contrast Calibration Adjustment	5-7
	Warming-Up and Pre-Calibration	5-9
	Final Calibration For v11.10 and later	5-10
	Warming-Up 2, Warm-Up Final, and ADC Timing	5-11
	Input A LF-HF Gain	5-12
	Input B LF-HF Gain	5-14
	Input C LF-HF Gain	5-16
	Input D LF-HF Gain	5-18
	Input AB Position	5-20
	Input AB LF-HF Gain and Position	5-20
	Input Pos ABCD (AB) Calibration	5-22
	Input ABCD (AB) Noise F FBW Calibration	5-22
	Input AB Volt Gain	5-22
	Multimeter Meter Zero	5-24
	Multimeter Volt Gain	5-24
	Multimeter Ohm Gain	5-26

	Final Calibration (Firmware: V10.9 and Lower)	5-28
	Error Messages	5-28
	Warm-Up Final and ADC Timing	5-28
	Input A LF-HF Gain	5-29
	Input B LF-HF Gain	5-31
	Input C LF-HF Gain	5-33
	Input D LF-HF Gain	5-35
	Input ABCD (AB) LF-HF Gain	5-36
	Input ABCD (AB) Position	5-38
	Input ABCD (AB) Volt Gain	5-38
	Input ABCD (AB) Zero	5-39
	Multimeter Volt Gain	5-40
	Multimeter Numeric Zero	5-41
	Multimeter Ohm Gain	5-41
	Save Calibration Data and Exit	5-43
	Probe Calibration	5-44
6	Disassembly	6-1
	Introduction	6-3
	Disassembly and Reassembly Procedures	6-3
	Required Tools	6-3
	Remove the Tilt Stand, Hang Strap, and Side Strap	6-3
	Open the Test Tool, Remove the Battery Pack	6-4
	How to Access the Top Side of PCA	6-5
	How to Access the Bottom Side of PCA	6-5
	Access to LCD, Keypad Foil, and Keypad	6-6
	Disassembly Steps	6-6

List of Tables

Table	Title	Page
1-1.	Symbols	1-4
3-1.	Final Assembly Parts and Kits	3-4
4-1.	Model Descriptions	4-3
4-2.	Vertical Accuracy Verification Points.....	4-10
4-3.	Volts DC Measurement Verification Points.....	4-13
4-4.	Volts AC Measurement Verification Points.....	4-15
4-5.	Input A, B AC Input Coupling Verification Points.....	4-16
4-6.	Volts Peak Measurement Verification Points.....	4-17
4-7.	Input A, B, C, D Frequency Measurement Accuracy Test	4-19
4-8.	Phase Measurement Verification Points.....	4-20
4-9.	Input A Trigger Sensitivity Test Points	4-22
4-10.	HF AC Voltage Verification Points.....	4-23
4-11.	Input B Trigger Sensitivity Test Points	4-25
4-12.	HF AC Voltage Verification Points.....	4-26
4-13.	Input C Trigger Sensitivity Test Points	4-27
4-14.	HF AC Voltage Verification Points.....	4-28
4-15.	Input D Trigger Sensitivity Test Points	4-30
4-16.	HF AC Voltage Verification Points.....	4-31
4-17.	Meter Volts dc Measurement Verification Points.....	4-36
4-18.	Meter Volts AC Measurement Verification Points.....	4-37
4-19.	Resistance Measurement Verification Points	4-39
5-1.	Input A LF-HF Gain Calibration Points	5-13
5-2.	Input B LF-HF Gain Calibration Points	5-15
5-3.	Input C LF-HF Gain Calibration Points.....	5-17
5-4.	Input D LF-HF Gain Calibration Points.....	5-19
5-5.	Input AB Gain and Position Calibration Points	5-21
5-6.	Input ABCD Gain Calibration Points.....	5-23
5-7.	DMM Volt Gain Calibration Points.....	5-25
5-8.	Ohm Gain Calibration Points.....	5-27
5-9.	Input A LF-HF Gain Calibration Points	5-30
5-10.	Input A LF-HF Gain Calibration Points	5-30
5-11.	Input B LF-HF Gain Calibration Points	5-32
5-12.	Input B LF-HF Gain Calibration Points	5-32
5-13.	Input C LF-HF Gain Calibration Points.....	5-34
5-14.	Input C LF-HF Gain Calibration Points.....	5-34
5-15.	Input D LF-HF Gain Calibration Points.....	5-36
5-16.	Input D LF-HF Gain Calibration Points.....	5-36
5-17.	Input ABCD Gain Calibration Points.....	5-37
5-18.	Input ABCD Gain Calibration Points.....	5-39
5-19.	DMM Gain Calibration Points	5-41
5-20.	Ohm Gain Calibration Points.....	5-42

List of Figures

Figure	Title	Page
3-1.	Open Case and Screws	3-6
3-2.	Screening Plate Removed and Screws	3-7
3-3.	PCA removed from Chassis, Bottom Side visible	3-8
4-1.	Menu Item Selection	4-5
4-2.	Display Test Pattern.....	4-7
4-3.	Test Tool Inputs A, B to 5502A Normal Output	4-9
4-4.	Test Tool Inputs A, B, C, D to 5502A Normal Output	4-11
4-5.	5502A Scope Output to Test Tool Input A, B, C, D	4-18
4-6.	5502A Scope Output to Test Tool Input A.....	4-20
4-7.	Time Base Verification	4-21
4-8.	5502A Scope Output to Test Tool Input B.....	4-24
4-9.	5502A Scope Output to Test Tool Input C.....	4-26
4-10.	5502A Scope Output to Test Tool Input D.....	4-29
4-11.	Test Tool Input A to TV Signal Generator	4-31
4-12.	SC600 Marker Pulse.....	4-33
4-13.	Test Tool Meter/Ext Input to 5502A Normal Output.....	4-34
4-14.	Test Meter Tool Input to 5502A Normal Output 4-Wire	4-38
4-15.	Probe Calibration	4-40
5-1.	Version and Calibration Data (example).....	5-4
5-2.	Display Test Pattern.....	5-8
5-3.	5502A SCOPE Output to Test Tool Input A	5-11
5-4.	5502A SCOPE Output to Test Tool Input B	5-14
5-5.	5502A SCOPE Output to Test Tool Input C	5-16
5-6.	5502A SCOPE Output to Test Tool Input D	5-18
5-7.	Test Tool Input ABCD to 5502A SCOPE Output.....	5-20
5-8.	Test Tool Input AB to 5502A Normal Output.....	5-22
5-9.	5502A NORMAL Output to Test Tool Banana Input.....	5-25
5-10.	Four-wire Ohms Calibration Connections.....	5-26
5-11.	5502A SCOPE Output to Test Tool Input A	5-29
5-12.	5502A SCOPE Output to Test Tool Input B	5-31
5-13.	5502A SCOPE Output to Test Tool Input C	5-33
5-14.	5502A SCOPE Output to Test Tool Input D	5-35
5-15.	Test Tool Input ABCD to 5502A SCOPE Output.....	5-36
5-16.	Test Tool Input ABCD to 5502A Normal Output.....	5-38
5-17.	5502A NORMAL Output to Test Tool Banana Input.....	5-40
5-18.	Four-wire Ohms Calibration Connections.....	5-42
5-19.	10:1 Probe Calibration Connection.....	5-44
5-20.	10:1 Probe Calibration	5-45
6-1.	Flat Cable Connector	6-5
6-2.	Opened Case and Screws	6-7
6-3.	Screening Plate Removed and Screws	6-8
6-4.	PCA removed from Chassis, Bottom Side visible.....	6-9

Chapter 1

Safety Instructions

Title	Page
Introduction	1-3
Safety Precautions.....	1-3
Caution and Warning Statements.....	1-3
Symbols	1-4
Li-ion Battery Pack.....	1-7
Safe Storage of Battery Pack.....	1-7
Safe Use of Battery Pack.....	1-8
Safe Transport of Battery Pack.....	1-9
Safe Disposal of Battery Pack	1-9

Introduction

Read these pages carefully before beginning to install and use the Test Tool.

This section contains information, cautions, and warnings that must be followed to ensure safe operation and to keep the Test Tool in a safe condition.

Warning

To prevent possible electrical shock, fire, or personal injury, do not service the Test Tool unless you are qualified to do so. Service described in this manual is to be done only by qualified service personnel.

Safety Precautions

For the correct and safe use of this Test Tool it is essential that both operating and service personnel follow generally accepted safety procedures in addition to the safety precautions specified in this manual. Specific warning and caution statements, where they apply, will be found throughout the manual. Where necessary, the warning and caution statements and/or symbols are marked on the Test Tool.













Caution and Warning Statements

A **Warning** identifies hazardous conditions and procedures that are dangerous to the user. A **Caution** identifies conditions and procedures that can cause damage to the Product or the equipment under test.

Symbols

Table 1 is a list of symbols that are used on the Test Tool, in the Users Manual, in this Service Information, or on spare parts for this Test Tool.

Table 1-1. Symbols

Symbol	Description
	Risk of Danger. Important information. See manual.
	Hazardous voltage
	Live Voltage
	Earth Ground
	DC (Direct Current)
	AC or DC (Alternating or Direct Current)
	Conforms to relevant Australian EMC standards.
	Conforms to relevant North American Safety Standards.
	Conforms to European Union directives.
	Conforms to relevant South Korean EMC Standards.
	Double Insulation
CAT III	Measurement Category III is applicable to test and measuring circuits connected to the distribution part of the building's low-voltage MAINS installation.
CAT IV	Measurement Category IV is applicable to test and measuring circuits connected at the source of the building's low-voltage MAINS installation.
 Li-ion	This product contains a Lithium-ion battery. Do not mix with the solid waste stream. Spent batteries should be disposed of by a qualified recycler or hazardous materials handler per local regulations. Contact your authorized Fluke Service Center for recycling information.
	This product complies with the WEEE Directive (2002/96/EC) marking requirements. The affixed label indicates that you must not discard this electrical/electronic product in domestic household waste. Product Category: With reference to the equipment types in the WEEE Directive Annex I, this product is classed as category 9 "Monitoring and Control Instrumentation" product. Do not dispose of this product as unsorted municipal waste. Go to Fluke's website for recycling information.

⚠⚠ Warning

To prevent electrical shock or fire:

- Use only the Fluke power supply, Model BC190 (Power Adapter).
- Before use, check that the selected/indicated range on the BC190 matches the local line power voltage and frequency.
- For the BC190/808 and BC190/820 universal Power Adapters, use line cords that comply with the local safety regulations.

Note

The BC190/808 and BC190/820 universal Power Adapters are equipped with a male plug that must be connected to a line cord appropriate for local use. The adapter is isolated so the line cord does not need to be equipped with a terminal for connection to protective ground.

⚠⚠ Warning

To prevent electrical shock or fire if a product input is connected to more than 42 V peak (30 Vrms) or 60 V dc:

- Use only insulated voltage probes, test leads and adapters supplied with the product, or indicated by Fluke as suitable for the Fluke 190 Series II ScopeMeter® Test Tool series.
- Before use, inspect voltage probes, test leads, and accessories for mechanical damage and replace when damaged.
- Remove all probes, test leads, and accessories that are not in use.
- Always connect the power adapter first to the ac outlet before connecting it to the product.
- Do not touch voltages >30 V ac rms, 42 V ac peak, or 60 V dc.
- Do not connect the ground spring to voltages higher than 42 V peak (30 Vrms) from earth ground.
- When using the ground reference lead with any of the probes, make sure that the black isolation sleeve is over the probe tip.
- Do not apply more than the rated voltage, between the terminals or between each terminal and earth ground.
- Do not apply input voltages above the rating of the instrument. Use caution when using 1:1 test leads because the probe tip voltage will be directly transmitted to the product.
- Do not use exposed metal BNC or banana plug connectors. Fluke offers cables with plastic, safety designed BNC connectors suitable for the ScopeMeter® Test Tool product.
- Do not insert metal objects into connectors.

- Use the product only as specified, or the protection supplied by the product can be compromised.
- Carefully read all instructions.
- Do not use the product if it operates incorrectly.
- Do not use the product or its accessories in case of any damage.
- Disable the product or its accessories in case of any damage.
- Keep fingers behind the finger guards on the probes.
- Use only correct measurement category (CAT), voltage, and current rated probes, test leads, and adapters for the measurement.
- Do not exceed the Measurement Category (CAT) rating of the lowest rated individual component of a product, probe, or accessory.
- Do not use the product around explosive gas, vapor, or in damp or wet environments.
- Measure a known voltage first to make sure that the product operates correctly.
- Examine the case before you use the product. Look for cracks or missing plastic. Carefully look at the insulation around the terminals.
- Do not work alone.
- Comply with local and national safety codes. Use personal protective equipment (approved rubber gloves, face protection, and flame resistant clothes) to prevent shock and arc blast injury where hazardous live conductors are exposed.
- The battery door must be closed and locked before you operate the product.
- Do not operate the product with covers removed or the case open. Hazardous voltage exposure is possible.
- Remove the input signals before you clean the product.
- Use only specified replacement parts.
- Use of the product in a manner not specified may impair the protection provided by the equipment.
- Do not use test leads if they are damaged. Examine the test leads for damaged insulation, exposed metal, or if the wear indicator shows.

Voltage ratings that are mentioned in the warnings are given as limits for “working voltage”. They represent V ac rms (50-60 Hz) for ac sinewave applications and as Vdc for dc applications.

The terms ‘Isolated’ or ‘Electrically floating’ are used in this manual to indicate a measurement in which the product input BNC is connected to a voltage different from earth ground.

The isolated input connectors have no exposed metal and are fully insulated to protect against electrical shock.

The BNC jacks can independently be connected to a voltage above earth ground for isolated (electrically floating) measurements and are rated up to 1000 Vrms CAT III and 600 Vrms CAT IV above earth ground.

Whenever it is likely that safety has been impaired, the product must be turned off and disconnected from the line power. The matter should then be referred to qualified personnel. Safety is likely to be impaired if, for example, the product fails to perform the intended measurements or shows visible damage.

Li-ion Battery Pack

The battery pack has been tested in accordance with the UN Manual of Tests and Criteria Part III Subsection 38.3 (ST/SG/AC.10/11/Rev.3) – more commonly known as the UN T1..T8 – tests, and have been found to comply with the stated criteria.

The battery pack has been tested to EN/IEC62133.

Safe Storage of Battery Pack

Warning

To prevent electrical shock or fire:

- **Do not store battery packs near heat or fire. Do not store in sunlight.**
- **Do not remove a battery pack from its original packaging until ready to use.**
- **When possible, remove the battery pack from the equipment when not in use.**
- **Fully charge the battery pack before storing it for an extended period to avoid a defect.**
- **After extended periods of storage, it may be necessary to charge and discharge the battery packs several times to obtain maximum performance.**
- **Keep the battery pack out of the reach of children and animals.**
- **Seek medical advice if a battery or part of it has been swallowed.**

Safe Use of Battery Pack

Warning

To prevent electrical shock or fire:

- The battery pack needs to be charged before use. Use only Fluke approved power adapters to charge the battery pack. Refer to Fluke's safety instructions and Users Manual for proper charging instructions.
- Do not leave a battery on prolonged charge when not in use.
- The battery pack gives the best performance when operated at normal room temperature $20\text{ }^{\circ}\text{C} \pm 5\text{ }^{\circ}\text{C}$ ($68\text{ }^{\circ}\text{F} \pm 9\text{ }^{\circ}\text{F}$).
- Do not put battery packs near heat or fire. Do not put in sunlight.
- Do not subject battery packs to severe impacts such as mechanical shock.
- Keep the battery pack clean and dry. Clean dirty connectors with a dry, clean cloth.
- Do not use any charger other than that specifically provided for use with this equipment.
- Do not use any battery which is not designed or recommended by Fluke for use with the Product.
- Take careful notice of correct placement of the battery in the product or the External Battery Charger.
- Do not short-circuit a battery pack. Do not keep battery packs in a place where the terminals can be shorted by metal objects (for example, coins, paperclips, pens or other).
- Never use a battery pack or charger showing visible damage.
- Batteries contain hazardous chemicals that can cause burns or explode. If exposure to chemicals occurs, clean with water and get medical aid. Repair the product before use if the battery leaks.
- Do not open, modify, reform, or repair a battery pack that appears to malfunction or has been physically damaged.
- Do not disassemble or crush battery packs.
- Use the battery only as intended for the application.
- Retain the original product information for future reference.

Safe Transport of Battery Pack

- The battery pack must be protected against short-circuit or damage during transport.
- Always consult the IATA guidelines describing safe air transport of Li-ion batteries. Refer also to the section in the beginning of this paragraph on safe use of the battery pack.
- Check-in luggage: battery packs are only allowed when installed in the Product.
- Hand-carry luggage: a number of battery packs as required for normal and individual use is allowed.
- Always consult national/local guidelines that are applicable for shipment by mail or other transporters.
- A maximum of three battery packs may be shipped by mail. The package must be marked as follows: PACKAGE CONTAINS LITHIUM-ION BATTERIES (NO LITHIUM METAL).

Safe Disposal of Battery Pack

- A failed battery pack shall be properly disposed of in accordance with local regulations.
- Properly dispose of the battery pack. Do not dispose of the battery as unsorted municipal waste.
- Dispose in discharged condition and cover the battery terminals with isolation tape.

Chapter 2

Specifications

Title	Page
Introduction	2-3
Oscilloscope	2-3
Automatic Scope Measurements	2-6
Meter Measurements for Fluke 190-xx4	2-9
Meter Measurements for Fluke 190-xx2	2-9
Recorder	2-11
Zoom, Replay and Cursors	2-12
Miscellaneous	2-12
Environmental	2-14
Certifications	2-14
Safety	2-14
10:1 Probe VPS410	2-16
Electromagnetic Immunity.....	2-16

Introduction

Specifications are subject to change without notification.

Oscilloscope

Isolated Inputs A, B, C and D (Vertical)

Number of Channels	
Fluke 190-xx2.....	2 (A, B)
Fluke 190-xx4.....	4 (A, B, C, D)
Bandwidth, DC Coupled	
Fluke 190-50x.....	500 MHz (-3 dB)
Fluke 190-2xx.....	200 MHz (-3 dB)
Fluke 190-1xx.....	100 MHz (-3 dB)
Fluke 190-062.....	60 MHz (-3 dB)
Lower Frequency Limit, AC Coupled	
with 10:1 probe.....	<2 Hz (-3 dB)
direct (1:1).....	<5 Hz (-3 dB)
Rise Time	
Fluke 190-50x.....	0.7 ns
Fluke 190-2xx.....	1.7 ns
Fluke 190-1xx.....	3.5 ns
Fluke 190-062.....	5.8 ns
Analog Bandwidth Limiters.....	20 MHz, 20 kHz, and 10 kHz (varies according to version)
Input Coupling.....	AC, DC
Polarity.....	Normal, Inverted
Sensitivity Ranges	
with 10:1 probe.....	20 mV to 1000 V/div
direct (1:1).....	2 mV to 100 V/div
Dynamic Range.....	> ± 8 div (<10 MHz)
	> ± 4 div (>10 MHz)
Waveform Positioning Range.....	± 4 divisions
Input Impedance on BNC, DC Coupled	
4-channel models.....	1 M Ω (± 1 %)//14 pF (± 2.25 pF)
2-channel models.....	1 M Ω (± 1 %)//15 pF (± 2.25 pF)
Vertical Accuracy.....	$\pm(2.1$ % + 0.04 range/div)
2 mV/div.....	$\pm(2.9$ % + 0.08 range/div)
Digitizer Resolution.....	8 bits, separate digitizer for each input

Horizontal

Minimum Time Base Speed (Scope Record).....	2 min/div
Real Time Sampling Rate	
Fluke 190-50x:	
5 ns to 4 μ s/div (3 or 4 channels).....	up to 1.25 GS/s
2 ns to 4 μ s/div (2 channels).....	up to 2.5 GS/s
1 ns to 4 μ s/div (1 channel).....	up to 5 GS/s
10 μ s to 120 s/div.....	125 MS/s
Fluke 190-202, -204:	
2 ns to 4 μ s/div (1 or 2 channels).....	up to 2.5 GS/s
5 ns to 4 μ s/div (3 or 4 channels).....	up to 1.25 GS/s
10 μ s to 120 s/div.....	125 MS/s
Fluke 190-102, -104:	
5 ns to 4 μ s/div (all channels).....	up to 1.25 GS/s
10 μ s to 120 s/div.....	125 MS/s
Fluke 190-062:	
10 ns to 4 μ s/div (all channels).....	up to 625 MS/s
10 μ s to 120 s/div.....	125 MS/s
Glitch Detection	
4 μ s to 120 s/div.....	displays glitches as fast as 8 ns
Waveform Display.....	A, B, C, D, Math (+, -, x, X-Y mode, spectrum) Normal, Average, Persistence, Reference
Time Base Accuracy.....	$\pm(100 \text{ ppm} + 0.04 \text{ div})$
Record Length (all models):	see table that follows.

Record Length (all models, Samples/points per input)

Mode	Glitch Detect On	Glitch Detect Off	Max. Sample Rate
Scope - Normal	300 min/max pairs	3 k true samples compressed into 1 screen (300 samples per screen)	190-062: 625 MS/s 190-102/104: 1.25 GS/s 190-202/204: 2.5 GS/s (1 or 2 channels on)
Scope - Fast	300 min/max pairs	-	190-204: 1.25 GS/s (3 or 4 channels on)
Scope - Full	300 min/max pairs	10 k true samples, compressed into 1 screen. Use Zoom and Scroll to see waveform details	190-50x: 5 GS/s (1 channel on) 190-50x: 2.5 GS/s (2 channels on) 190-504: 1.25 GS/s (3 or 4 channels on)
Scope Record Roll		30 k samples	4x 125 MS/s
Trend Plot		>18 k min/max/average values/measurement	Up to 5 measurements/second

Trigger and Delay

Trigger Modes.....	Automatic, Edge, Video, Pulse Width, N-Cycle, External (190-xx2)
Trigger Delay.....	up to +1200 divisions
Pre-Trigger View.....	one full screen length
Delay.....	-12 div to +1200 div
Max. Delay.....	48 s at 4 s/div

Automatic Connect-and-View Trigger

Source.....	A, B, C, D EXT (190-xx2)
Slope.....	Positive, Negative, Dual

Edge Trigger

Screen Update	Free Run, On Trigger, Single Shot
Source	A, B, C, D, EXT (190-xx2)
Slope	Positive, Negative, Dual
Trigger Level Control Range	±4 divisions
Trigger Sensitivity	
DC to 5 MHz at >5 mV/div	0.5 division
DC to 5 MHz at 2 mV/div and 5 mV/div	1 division
500 MHz (Fluke 190-50x)	1 division
200 MHz (Fluke 190-2xx)	1 division
100 MHz (Fluke 190-1xx)	1 division
60 MHz (Fluke 190-062)	1 division

Isolated External Trigger (190-xx2)

Bandwidth	10 kHz
Modes	Automatic, Edge
Trigger Levels (DC to 10 kHz)	120 mV, 1.2 V

Video Trigger

Standards	PAL, PAL+, NTSC, SECAM, Non-interlaced
Modes	Lines, Line Select, Field 1 or Field 2
Source	A
Polarity	Positive, Negative
Sensitivity	0.7 division sync level

Pulse Width Trigger

Screen Update	On Trigger, Single Shot
Trigger Conditions	<T, >T, =T (±10 %), ≠T(±10 %)
Source	A
Polarity	Positive or negative pulse
Pulse Time Adjustment Range	0.01 div. to 655 div. with a minimum of 300 ns (<T, >T) or 500 ns (=T, ≠T), a maximum of 10 s, and a resolution of 0.01 div. with a minimum of 50 ns

Continuous Auto Set

Autoranging attenuators and time base, automatic Connect-and-View™ triggering with automatic source selection.

Modes	
Normal	15 Hz to max. bandwidth
Low Frequency	1 Hz to max. bandwidth
Minimum Amplitude A, B, C, D	
DC to 1 MHz	10 mV
1 MHz to max. bandwidth	20 mV

Automatic Capturing Scope Screens

Capacity	100 Scope Screens
----------------	-------------------

For viewing screens, see Replay function.

Automatic Scope Measurements

The accuracy of all readings is within \pm (% of reading + number of counts) from 18 °C to 28 °C. Add 0.1x (specific accuracy) for each °C below 18 °C or above 28 °C. For voltage measurements with 10:1 probe, add probe accuracy. At least 1.5 waveform period must be visible on the screen.

General

Inputs A, B, C and D
 DC Common Mode Rejection (CMRR) >100 dB
 AC Common Mode Rejection at
 50, 60, or 400 Hz >60 dB

DC Voltage (VDC)

Maximum Voltage
 with 10:1 probe 1000 V
 direct (1:1)..... 300 V
 Maximum Resolution
 with 10:1 probe 1 mV
 direct (1:1)..... 100 μ V
 Full Scale Reading..... 999 counts
 Accuracy at 4 s to 10 μ s/div, Fluke 190-xx2
 2 mV/div $\pm(1.5\% + 10 \text{ counts})$
 5 mV/div to 100 V/div $\pm(1.5\% + 6 \text{ counts})$
 Accuracy at 4 s to 10 μ s/div, Fluke 190-xx4
 2 mV/div $\pm(3\% + 10 \text{ counts})$
 5 mV/div to 100 V/div $\pm(3\% + 6 \text{ counts})$
 Normal Mode AC Rejection
 at 50 or 60 Hz >60 dB

AC Voltage (VAC)

Maximum Voltage
 with 10:1 probe 1000 V
 direct (1:1)..... 300 V
 Maximum Resolution
 with 10:1 probe 1 mV
 direct (1:1)..... 100 μ V
 Full Scale Reading..... 999 counts
 Accuracy, Fluke 190-xx2
 DC coupled:
 DC to 60 Hz $\pm(1.5\% + 10 \text{ counts})$
 AC coupled, low frequencies:
 50 Hz direct (1:1) $\pm(1.5\% + 10 \text{ counts}) - 0.6\%$
 60 Hz direct (1:1) $\pm(1.5\% + 10 \text{ counts}) - 0.4\%$
 With the 10:1 probe the low frequency roll-off point will be lowered to 2 Hz, which improves the AC accuracy for low frequencies. When possible use DC coupling for maximum accuracy.
 AC or DC coupled, high frequencies:
 60 Hz to 20 kHz $\pm(2.5\% + 15 \text{ counts})$
 20 kHz to 1 MHz $\pm(5\% + 20 \text{ counts})$
 1 MHz to 25 MHz $\pm(10\% + 20 \text{ counts})$
 For higher frequencies the instrument's frequency roll-off starts affecting accuracy.

Accuracy, Fluke 190-xx4

DC coupled:

DC to 60 Hz..... $\pm(3\% + 10 \text{ counts})$

AC coupled, low frequencies:

50 Hz direct (1:1)..... $\pm(3\% + 10 \text{ counts}) - 0.6\%$

60 Hz direct (1:1)..... $\pm(3\% + 10 \text{ counts}) - 0.4\%$

With the 10:1 probe the low frequency roll-off point will be lowered to 2 Hz, which improves the AC accuracy for low frequencies. When possible use DC coupling for maximum accuracy.

AC or DC coupled, high frequencies:

60 Hz to 20 kHz..... $\pm(4\% + 15 \text{ counts})$

20 kHz to 1 MHz..... $\pm(6\% + 20 \text{ counts})$

1 MHz to 25 MHz..... $\pm(10\% + 20 \text{ counts})$

For higher frequencies the instrument's frequency roll-off starts affecting accuracy.

Normal Mode DC Rejection..... $>50 \text{ dB}$

All accuracies are valid if:

- The waveform amplitude is larger than one division
- At least 1.5 waveform period is on the screen

AC+DC Voltage (True RMS)

Maximum Voltage

with 10:1 probe.....1000 V

direct (1:1).....300 V

Maximum Resolution

with 10:1 probe.....1 mV

direct (1:1).....100 μV

Full Scale Reading1100 counts

Accuracy, Fluke 190-xx2

DC to 60 Hz..... $\pm(1.5\% + 10 \text{ counts})$

60 Hz to 20 kHz..... $\pm(2.5\% + 15 \text{ counts})$

20 kHz to 1 MHz..... $\pm(5\% + 20 \text{ counts})$

1 MHz to 25 MHz..... $\pm(10\% + 20 \text{ counts})$

For higher frequencies the instrument's frequency roll-off starts affecting accuracy.

Accuracy, Fluke 190-xx4

DC to 60 Hz..... $\pm(3\% + 10 \text{ counts})$

60 Hz to 20 kHz..... $\pm(4\% + 15 \text{ counts})$

20 kHz to 1 MHz..... $\pm(6\% + 20 \text{ counts})$

1 MHz to 25 MHz..... $\pm(10\% + 20 \text{ counts})$

For higher frequencies the instrument's frequency roll-off starts affecting accuracy.

Amperes (AMP)

With Optional Current Probe or Current Shunt

Rangessame as VDC, VAC, VAC+DC

Probe Sensitivity.....100 $\mu\text{V/A}$, 1 mV/A, 10 mV/A, 100 mV/A, 400 mV/A, 1 V/A, 10 V/A, and 100 V/A

Accuracy.....same as VDC, VAC, VAC+DC (add current probe or current shunt accuracy)

Peak

Modes	Max peak, Min peak, or peak-to-peak
Maximum Voltage	
with 10:1 probe	1000 V
direct (1:1).....	300 V
Maximum Resolution	
with 10:1 probe	10 mV
direct (1:1).....	1 mV
Full Scale Reading.....	800 counts
Accuracy	
Max peak or Min peak.....	±0.2 division
Peak-to-peak	±0.4 division

Frequency (Hz)

Range	1.000 Hz to full bandwidth
Full Scale Reading.....	999 counts
Accuracy	
1 Hz to full bandwidth.....	±(0.5 % +2 counts) (4 s/div to 10 ns/div and 10 periods on the screen)

Duty Cycle (DUTY)

Range	4.0 % to 98.0 %
Resolution	0.1 % (when period >2 div)
Full Scale Reading.....	999 counts (3-digit display)
Accuracy (logic or pulse)	±(0.5 % +2 counts)

Pulse Width (PULSE)

Resolution (with GLITCH off)	1/100 division
Full Scale Reading.....	999 counts
Accuracy	
1 Hz to full bandwidth.....	±(0.5 % +2 counts)

Vpwm

Purpose:	to measure on pulse width modulated signals, like motor drive inverter outputs
Principle:	readings show the effective voltage based on the average value of samples over a whole number of periods of the fundamental frequency
Accuracy:	as V_{rms} for sinewave signals

V/Hz

Purpose:	to show the measured Vpwm value (see Vpwm) divided by the fundamental frequency on Variable AC Motor Speed drives.
Accuracy:	% V_{rms} + % Hz

Note

AC motors are designed for use with a rotating magnetic field of constant strength. This strength depends on the applied voltage (Vpwm) divided by the fundamental frequency of the applied voltage (Hz). The nominal Volt and Hz values are shown on the motor type plate.

Power (A and B, C and D)

Power Factor	ratio between Watts and VA
Range	0.00 to 1.00
Watt	RMS reading of multiplication corresponding samples of input A or C (volts) and Input B or D (amperes)
Full Scale Reading	999 counts
VA	$V_{rms} \times A_{rms}$
Full Scale Reading	999 counts
VA Reactive (VAR)	$\sqrt{((VA)^2 - W^2)}$
Full Scale Reading	999 counts

Phase (A and B, C and D)

Range	-180 to +180 degrees
Resolution	1 degree
Accuracy	
0.1 Hz to 1 MHz	±2 degrees
1 MHz to 10 MHz	±3 degrees

Temperature (TEMP)

With Optional Temperature Probe (°F not for Japan)

Ranges (°C or °F)	-40.0 to +100.0 °
	-100 to +250 °
	-100 to +500 °
	-100 to +1000 °
	-100 to +2500 °
Probe Sensitivity	1 mV/°C and 1 mV/°F
Accuracy	±(1.5 % + 5 counts) (add temperature probe accuracy for overall accuracy)

Decibel (dB)

dBV	dB relative to one volt
dBm	dB relative to one mW in 50 Ω or 600 Ω
dB on	VDC, VAC, or VAC+DC
Accuracy	same as VDC, VAC, VAC+DC

Meter Measurements for Fluke 190-xx4

Four of the Automatic Scope Measurements as defined above may be displayed at the same time, using larger screen area for convenient reading, suppressing the scope waveform information. For specifications see Automatic Scope Measurements above.

Meter Measurements for Fluke 190-xx2

The accuracy of all measurements is within ± (% of reading + number of counts) from 18 °C to 28 °C.
 Add 0.1x (specific accuracy) for each °C below 18 °C or above 28 °C.

Meter Input (Banana Jacks)

Input Coupling.....	DC
Frequency Response.....	DC to 10 kHz (-3 dB)
Input Impedance.....	1 M Ω ($\pm 1\%$)/14 pF (± 1.5 pF)
Δ Max. Input Voltage.....	1000 V CAT III 600 V CAT IV (For detailed specifications, see "Safety")

Meter Functions

Ranging.....	Auto, Manual
Modes.....	Normal, Relative

General

DC Common Mode Rejection (CMRR).....	>100 dB
AC Common Mode Rejection at 50, 60, or 400 Hz.....	>60 dB

Ohms (Ω)

Ranges.....	500.0 Ω , 5.000 k Ω , 50.00 k Ω , 500.0 k Ω , 5.000 M Ω , 30.00 M Ω
Full Scale Reading	
500 Ω to 5 M Ω	5000 counts
30 M Ω	3000 counts
Accuracy.....	$\pm(0.6\% + 6$ counts)
Measurement Current.....	0.5 mA to 50 nA, $\pm 20\%$ decreases with increasing ranges
Open Circuit Voltage.....	<4 V

Continuity (CONT)

Beep.....	<50 Ω (± 30 Ω)
Measurement Current.....	0.5 mA, $\pm 20\%$
Detection of shorts of.....	≥ 1 ms

Diode

Maximum Voltage Reading.....	2.8 V
Open Circuit Voltage.....	<4 V
Accuracy.....	$\pm(2\% + 5$ counts)
Measurement Current.....	0.5 mA, $\pm 20\%$

Temperature (TEMP)

With Optional Temperature Probe

Ranges ($^{\circ}$ C or $^{\circ}$ F).....	-40.0 to +100.0 $^{\circ}$ -100.0 to +250.0 $^{\circ}$ -100.0 to +500.0 $^{\circ}$ -100 to +1000 $^{\circ}$ -100 to +2500 $^{\circ}$
Probe Sensitivity.....	1 mV/ $^{\circ}$ C and 1 mV/ $^{\circ}$ F

DC Voltage (VDC)

Ranges	500.0 mV, 5.000 V, 50.00 V, 500.0 V, 1100 V
Full Scale Reading	5000 counts
Accuracy	±(0.5 % +6 counts)
Normal Mode AC Rejection at 50 or 60 Hz ±1 %	>60 dB

AC Voltage (VAC)

Ranges	500.0 mV, 5.000 V, 50.00 V, 500.0 V, 1100 V
Full Scale Reading	5000 counts
Accuracy	
15 Hz to 60 Hz	±(1 % +10 counts)
60 Hz to 1 kHz	±(2.5 % +15 counts)
<i>For higher frequencies the frequency roll-off of the Meter input starts affecting accuracy.</i>	
Normal Mode DC Rejection	>50 dB

AC+DC Voltage (True RMS)

Ranges	500.0 mV, 5.000 V, 50.00 V, 500.0 V, 1100 V
Full Scale Reading	5000 counts
Accuracy	
DC to 60 Hz	±(1 % +10 counts)
60 Hz to 1 kHz	±(2.5 % +15 counts)
<i>For higher frequencies the frequency roll-off of the Meter input starts affecting accuracy.</i>	
All accuracies are valid if the waveform amplitude is larger than 5 % of full scale.	

Amperes (AMP)

With Optional Current Probe or Current Shunt

Ranges	same as VDC, VAC, VAC+DC
Probe Sensitivity	100 µV/A, 1 mV/A, 10 mV/A, 100 mV/A, 1 V/A, 10 V/A, and 100 V/A
Accuracy	same as VDC, VAC, VAC+DC (add current probe or current shunt accuracy)

Recorder

TrendPlot (Meter or Scope)

Chart recorder that plots a graph of min and max values of Meter or Scope measurements over time.

Measurement Speed	>5 measurements/s
Time/div	5 s/div to 30 min/div
Record Size (min, max, average)	19200 points
Recorded Time Span	64 min to 546 hours
Time Reference	time from start, time of day

Scope Record

Records scope waveforms in deep memory while displaying the waveform in Roll mode.

Source.....	Input A, B, C, D
Max. Sample Speed (4 ms/div to 1 min/div).....	125 MS/s
Glitch capture (4 ms/div to 2 min/div).....	8 ns
Time/Div in normal mode	4 ms/div to 2 min/div
Record Size	30 k points per waveform
Recorded Time Span	4.8 s to 40 hours
Acquisition Modes.....	Single Sweep, Continuous Roll, Start/Stop on Trigger
Time Reference	time from start, time of day

Zoom, Replay and Cursors

Zoom

Zoom ranges from full record overview to detailed view of individual samples

Replay

Displays a maximum of 100 captured quad input Scope screens.

Replay modes..... Step by Step, Replay as Animation

Cursor Measurements

Cursor Modes

single vertical cursor, dual vertical cursors, dual horizontal cursors (Scope mode)
--

Markers..... automatic markers at cross points

Measurements:

- value at cursor 1
- value at cursor 2
- difference between values at cursor 1 and 2
- time between cursors
- RMS between cursors
- Time of Day (Recorder modes)
- Time from Start (Recorder modes)
- Rise Time, fall time
- A x s (current over time between cursors)
- V x s (voltage over time between cursors)
- W x s (power over time between cursors using powerwaveform AxB or CxD)

Miscellaneous

Display

View Area..... 126.8 mm x 88.4 mm (4.99 in x 3.48 in)

Resolution

320 pixels x 240 pixels

Backlight

LED (Temperature compensated)

Brightness

Power Adapter: 200 cd/m ²

Battery Power: 90 cd/ m ²

Display Auto-OFF time (battery saving)..... 30 seconds, 5 minutes or disabled

⚠ Power

Fluke 190-xx4, -50x: Rechargeable Li-ion Battery (model BP291):

Operating Time	up to 7 hours (Low Intensity)
Charging Time.....	5 hours
Capacity/Voltage.....	52 Wh / 10.8 V

Fluke 190-062, -102, -202: Rechargeable Li-ion Battery (model BP290):

Operating Time.....	up to 4 hours (Low Intensity)
Charging Time.....	2.5 hours
Capacity/Voltage.....	26 Wh / 10.8 V

Rechargeable Li-ion Battery (model BP 290 and BP291):

Life Time (>80 % capacity).....	300 x charge/discharge
Allowable ambient temperature during charging.....	0 °C to 40 °C (32 °F to 104 °F)
Auto power down time (battery saving)	5 min, 30 min or disabled

Power Adapter BC190:

- BC190/801 European line plug 230 V ±10 %
- BC190/813 North American line plug 120 V ±10 %
- BC190/804 United Kingdom line plug 230 V ±10 %
- BC190/806 Japanese line plug 100 V ±10 %
- BC190/807 Australian line plug 230 V ±10 %
- BC190/808 Universal switchable adapter 115 V ±10 % or 230 V ±10 %, with plug EN60320-2.2G
- BC190/820 Universal adapter 100...240 V ±10 %, with plug EN60320-2.2G

Line Frequency.....50 Hz and 60 Hz

Probe Calibration

Manual pulse adjustment and automatic DC adjustment with probe check

Generator Output1.225 Vpp / 500 Hz square wave

Internal Memory

Number of Scope Memories.....up to 30 (varies according to version)

Each memory can contain 2/4 waveforms plus corresponding setups

Number of Recorder Memories.....10

Each memory can contain:

- 2/4 channel input TrendPlot
- 2/4 channel input Scope Record
- 100 2/4 channel input Scope screens (Replay)

Number of Screen Image memories9

Each memory can contain one screen image

External Memory

USB stick, 2GB max

Mechanical

Size265 mm x 190 mm x 70 mm (10.5 in x 7.5 in x 2.8 in)

Weight

Fluke 190-xx4.....	2.2 kg (4.8 lb) including battery
Fluke 190-5xx.....	2.2 kg (4.8 lb) including battery
Fluke 190-xx2.....	2.1 kg (4.6 lb) including battery

Interface Ports

Two USB ports provided. Ports are fully insulated from instrument's floating measurement circuitry:

- A USB-host port directly connects to external flash memory drive ('USB-stick', ≤2 GB) for storage of waveform data, measurement results, instrument settings and screen copies.
- A mini-USB-B is provided which allows for interconnection to PC for remote control and data transfer using SW90W (FlukeView® software for Windows®).
- One port can be active at the same time, so remote control and data transfer via mini-USB is not possible when saving or recalling data to or from the USB-stick.

Environmental

Environmental	MIL-PRF-28800F, Class 2
Temperature	
Operating	0 °C to 50 °C (32 °F to 122 °F)
Operating and charging	0 °C to 40 °C (32 °F to 104 °F)
Storage	-20 °C to +60 °C (-4 °F to +140 °F)
Humidity (Maximum Relative)	
Operating	
0 °C to 10 °C (32 °F to 50 °F)	noncondensing
10 °C to 30 °C (50 °F to 86 °F)	95 % (± 5 %)
30 °C to 40 °C (86 °F to 104 °F)	75 % (± 5 %)
40 °C to 50 °C (104 °F to 122 °F)	45 % (± 5 %)
Storage	
-20 °C to +60 °C (-4 °F to +140 °F)	noncondensing
Altitude	
Operating	
CATIII 600 V, CATII 1000 V	3 km (10,000 feet)
CATIV 600 V, CATIII 1000 V	2 km (6,600 feet)
Storage	12 km (40,000 feet)
Vibration (Sinusoidal)	max. 3 g
Vibration (Random)	0.03 g ² /Hz
Shock	max. 30 g
Electromagnetic Environment	EN/IEC61326-1(Portable Equipment)
Enclosure Protection	IP51, ref: IEC60529

Certifications

Conforms to



Safety

Designed for 1000 V Measurement Category III, 600 V Measurement Category IV (with supplied 10:1 probes) in accordance with:

- EN/IEC 61010-1, Pollution Degree 2
- EN/IEC 61010-2-030
- IEC 61010-031

Max. Input Voltages

BNC Input A, B, (C, D) directly	300 V CAT IV
Via VPS410	1000 V CAT III, 600 V CAT IV
METER/EXT banana input	1000 V CAT III, 600 V CAT IV

⚠ Max. Floating Voltage

Fluke 190-xxx (test tool or test tool + VPS410)

From any terminal to earth ground 1000 V CAT III, 600 V CAT IV

Between any terminal 1000 V CAT III, 600 V CAT IV

Fluke 190-xxx + VPS510

From any terminal to earth ground 300 V CAT III

Between any terminal 300 V CAT III

Voltage ratings are given as "working voltage". They should be read as Vac-rms (50-60 Hz) for AC sinewave applications and as Vdc for DC applications.

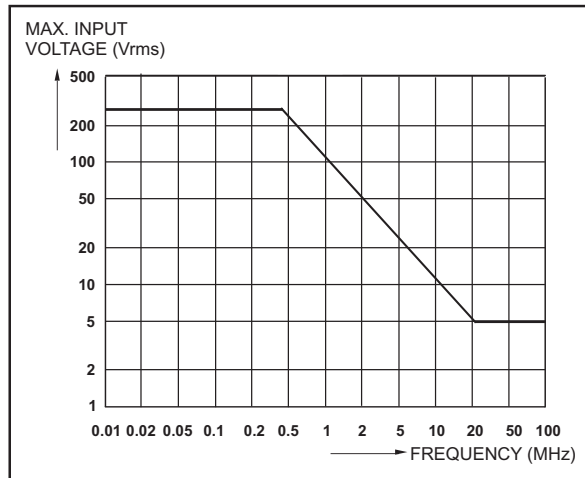

Max. Input Voltage vs. Frequency

hpp049.eps

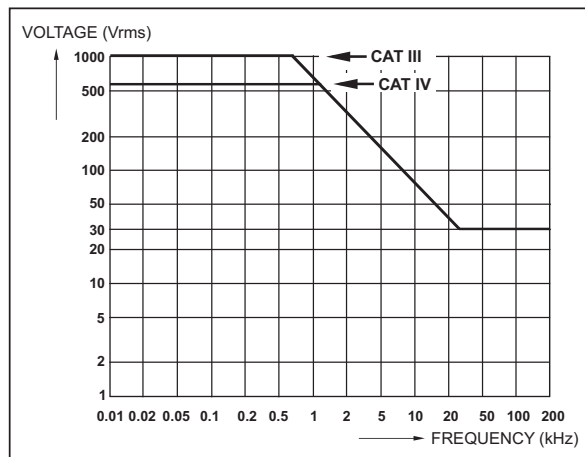

Safe Handling: Max. Voltage between Scope References, and between Scope References and Earth Ground

hpp50

10:1 Probe VPS410

Accuracy

Probe accuracy when adjusted on the test tool:

- DC to 20 kHz..... ±1 %
- 20 kHz to 1 MHz ±2 %
- 1 MHz to 25 MHz ±3 %

For higher frequencies the probe's roll-off starts affecting the accuracy.

For further probe specifications see the instruction sheet supplied with the VPS410 probe set.

Electromagnetic Immunity

The Fluke 190 Series II test tools, including standard accessories are compliant to EN 61326-1, with the addition of the table that follows.

Scope Mode (10 ms/div: Waveform disturbance with VPS410 voltage probe shorted (see table below).

(E = 3V/m)

Frequency	No Disturbance	Disturbance <10 % of full scale	Disturbance >10 % of full scale
80 MHz – 450 MHz	≥500 mV/d	100, 200 mV/div	2, 5, 10, 20, 50 mV/div
450 MHz – 1 GHz	All ranges		
1.4 GHz – 2 GHz	All ranges		
2 GHz – 2.7 GHz (1 V/m)	All Ranges		

Chapter 3

Parts List

Title	Page
Introduction	3-3
How to Obtain Parts.....	3-3
Final Assembly Parts	3-4
Accessory List.....	3-8

Introduction

This section contains a list of replaceable parts for all the models of the Test Tool. Parts are listed by assembly and alphabetized by item number or reference designator. The figures show the location of each part and the item number or reference designator.

The parts list shows:

- Description
- Ordering code

Caution

Electrical components, and in particular active components such as ICs, transistors, and diodes, may be damaged by static discharge.

Only qualified personnel at a static-free workstation should handle and service static-sensitive components and assemblies.

How to Obtain Parts

To locate an authorized service center, go to www.fluke.com.

In the event that the part ordered has been replaced by a new or improved part, the replacement will be accompanied by an explanatory note and installation instructions, if necessary.

To ensure prompt delivery of the correct part, include the following information when you place an order:

- Instrument model (for example Fluke-190-502) and serial number (25530001) that is printed on the type plate on the bottom cover
- Ordering code
- Item number - Reference designator
- Description
- Quantity

Final Assembly Parts

See Table 3-1 and Figure 3-1, 3-2, and 3-3 for the Final Assembly parts.

⚠ Caution

The Test Tool contains a Li-ion battery. Do not mix with the solid waste stream. Spent batteries should be disposed of by a qualified recycler or hazardous materials handler.

Table 3-1. Final Assembly Parts and Kits

Part or Kit	Ordering Code	Consists of Following Parts	Figure/Item nr
Case Set 4 channel	3981815	Front case (excluding lens/decal) 4 channel	3-3 / 5
		Dust seal long (2x)	3-3 / 3
		Dust seal short (2x)	3-3 / 4
		Case seal	3-3 / 13
		Bottom case assy	3-1 / 3
		Battery door	3-1 / 14
		Quarter turn screw (2x)	3-1 / 15
		Adhesive foam (for battery door)	--
		Standup bracket	3-1 / 16
Case Set 2 channel	4035349	Front case (Excl. lens/decal) 2 channel	3-3 / 5
		Dustseal long (2x)	3-3 / 3
		Dustseal short (2x)	3-3 / 4
		Case seal	3-3 / 13
		Bottom case assy	3-1 / 3
		Battery door	3-1 / 14
		Quarter turn screw (2x)	3-1 / 15
		Adhesive foam (for battery door)	--
		Standup bracket	3-1 / 16
Quarter turn screw	948609	For battery door (1x)	3-1 / 15
Li-ion Battery Pack	BP290	26 Wh, 10.8 V	---
Li-ion Battery Pack	BP291	52 Wh, 10.8 V	---
Lens/decal 190-062	4035360	---	3-3 / 14
Lens/decal 190-102	4035372	---	3-3 / 14
Lens/decal 190-104	3981826	---	3-3 / 14
Lens/decal 190-202	4035324	---	3-3 / 14
Lens/decal 190-204	3981832	---	3-3 / 14
Lens/decal 190-502	4035385		3-3 / 14
Lens/decal 190-504	4534710		3-3 / 14
LCD assy Flk-190-II	3981844	LCD module	3-3 / 1
		LCD fixation foam	3-3 / 2
		Flat cable	3-3 / 3
Top holster (Input Cover 2 channels + meter)	4035397	---	3-1 / 1
Top holster (Input Cover 4 channels)	3945328	---	3-1 / 1
Sealing strip (flexible) around inputs	3945319	Set of 2: 1 pce. for 4 channel + 1 pce. for 2 channel instruments	3-1 / 11

Table 3-1. Final Assembly Parts and Kits (cont.)

Part or Kit	Ordering Code	Consists of Following Parts	Figure/Item nr
Mounting Material Set	3981859	Self tapping Screw 10 mm (2x, to fix input cover)	3-1 / 2
		Dowel (6x, to fix straps)	3-1 / 4
		Steel Plate for Lock	3-1 / 5
		Self tapping Screw 16.5 mm (4x, to fix Rear Case)	3-1 / 6
		Screw M3x6 (2x, to fix bottom holster)	3-1 / 8
		Self tapping Screw (6x, 10.5 mm to fix Main PCA Module to Front Case)	3-3 / 12
Side Strap	3945370	Can be fixed on Left or Right side	---
Hang Strap	946769	Can be fixed on Top Side of Instrument	---
Bottom Holster Set	3981867	Bottom holster assy	3-1 / 7
		Cover for USB	3-1 / 9
		Cover for DC adapter power	3-1 / 10
Keypad 4 channels	3942805	---	3-3/ 6
Keypad 2 ch. + meter	4035336	---	3-3/ 6
Keypad Foil (all models)	3942810	(Incl. Flat Cable)	3-3 / 9
USB cable	3945381	USB-A to mini-USB-B (for PC connection)	---
BNC Connector Red, 500 MHz	4306959	X1100 ^[1]	
BNC Connector Blue, 500 MHz	4306967	X1300 ^[1]	
BNC Connector Gray, 500 MHz	4306971	X1400 ^[1]	
BNC Connector Green, 500 MHz	4306980	X1200 ^[1]	
BNC Connector Black, 500 MHz	4306998		---
BNC Connector Red, 200 MHz	3945031	X1100 ^[2]	
BNC Connector Green, 200 MHz	3945068	X1200 ^[2]	
BNC Connector Blue, 200 MHz	3945046	X1300 ^[2]	---
BNC Connector Gray, 200 MHz	3945054	X1400 ^[2]	---
Banana Jack Black	4035403	X 1501	---
Banana Jack Red	4035415	X 1500	---
DC Power Input Socket	215785	X9100	---
<p>[1] Later PCA sub code 5 [2] Early PCA sub code 2 or firmware version ≤10. Check that the serial number is ≥25375604. If yes, use the later connectors. If <25375604, evaluate the firmware and subversion. To find the version, press in sequence, USER and F3 VERSION & CAL. If the firmware version is <V11.00, use the early connectors. If the firmware is ≥V11.10, check under subversions that the last datablock is x5xx (for instance 2516). This value determines that the higher frequency adjust point should be used.</p> <ul style="list-style-type: none"> • for x5xx: use the later connectors • for x2xx: use the early connectors 			

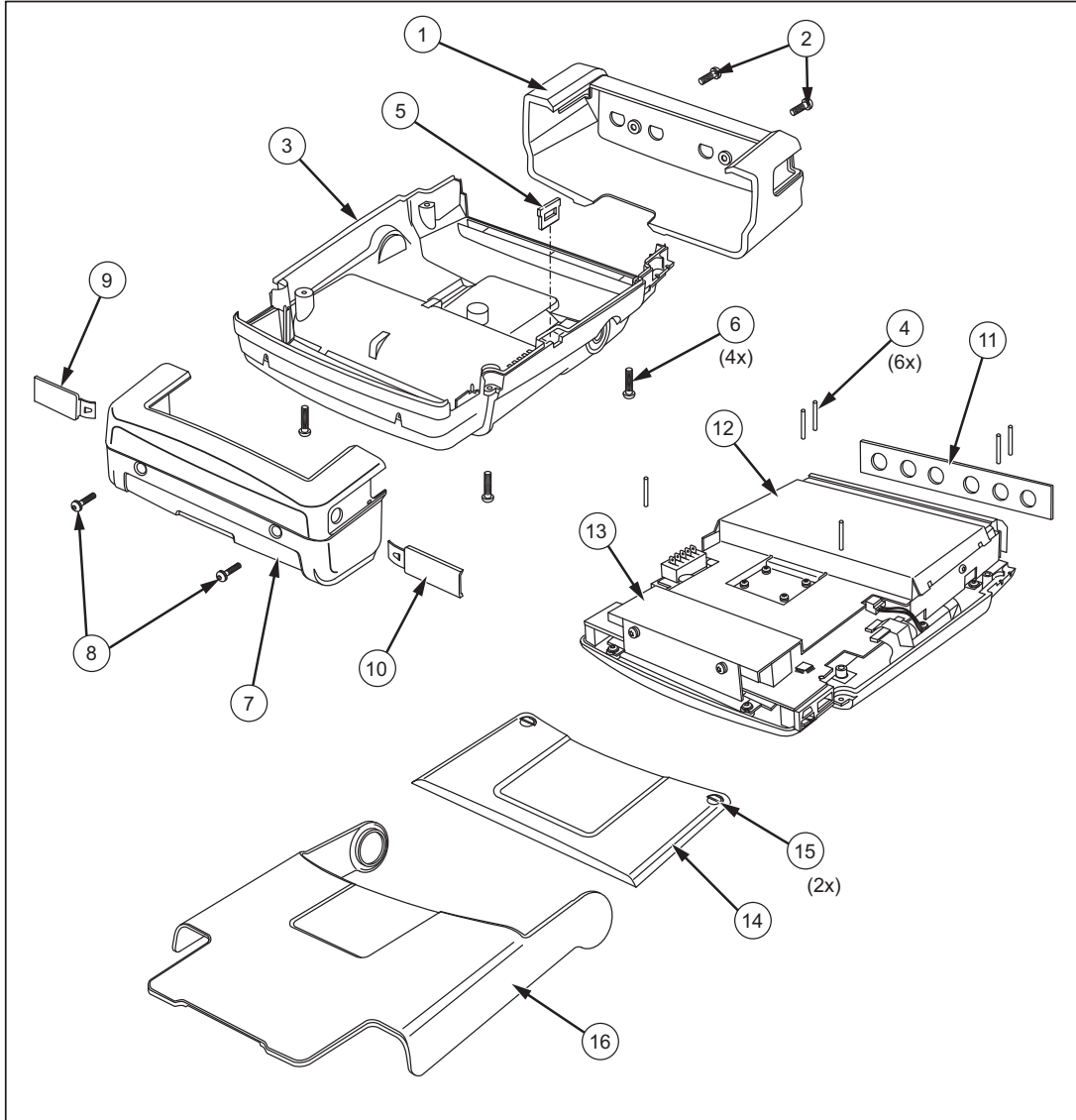

hpp201.eps

Figure 3-1. Open Case and Screws

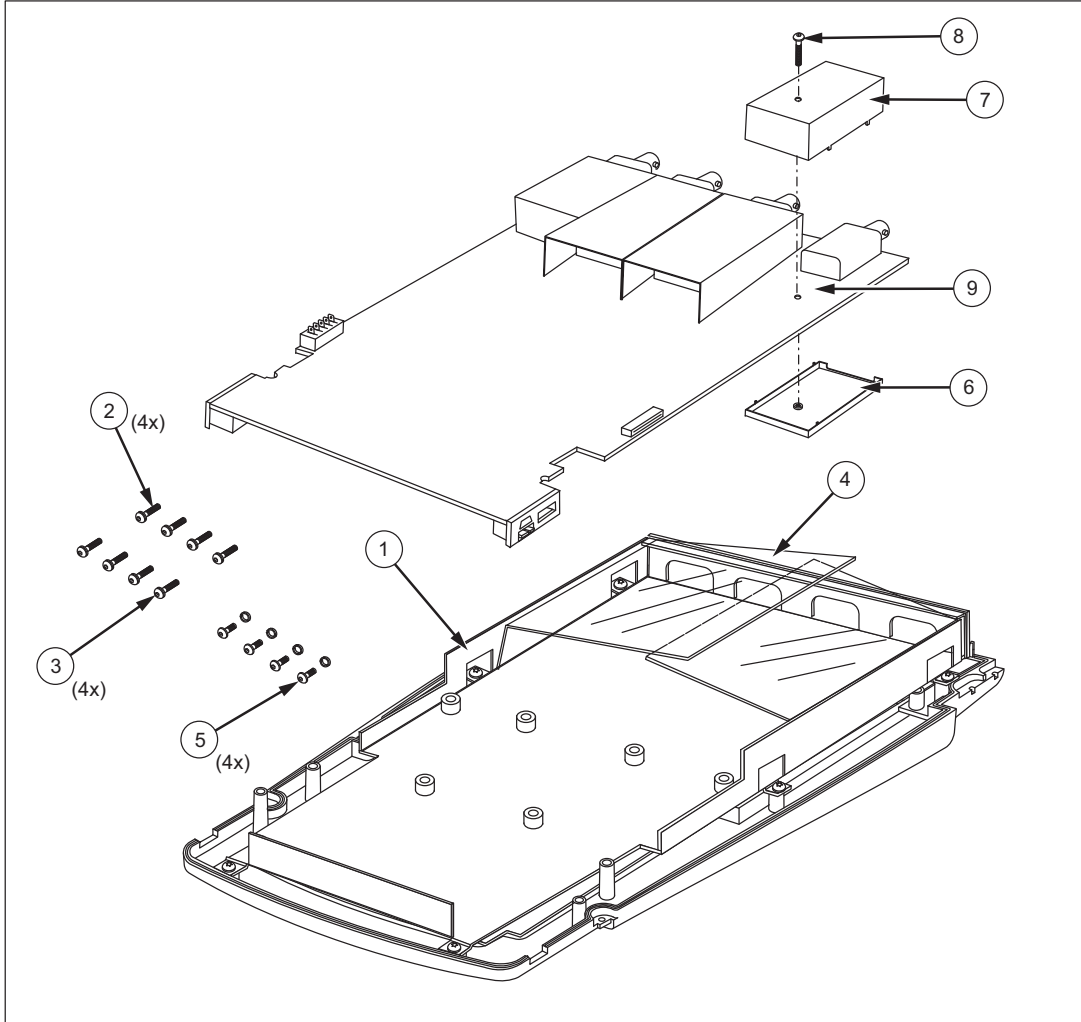

hpp202.eps

Figure 3-2. Screening Plate Removed and Screws

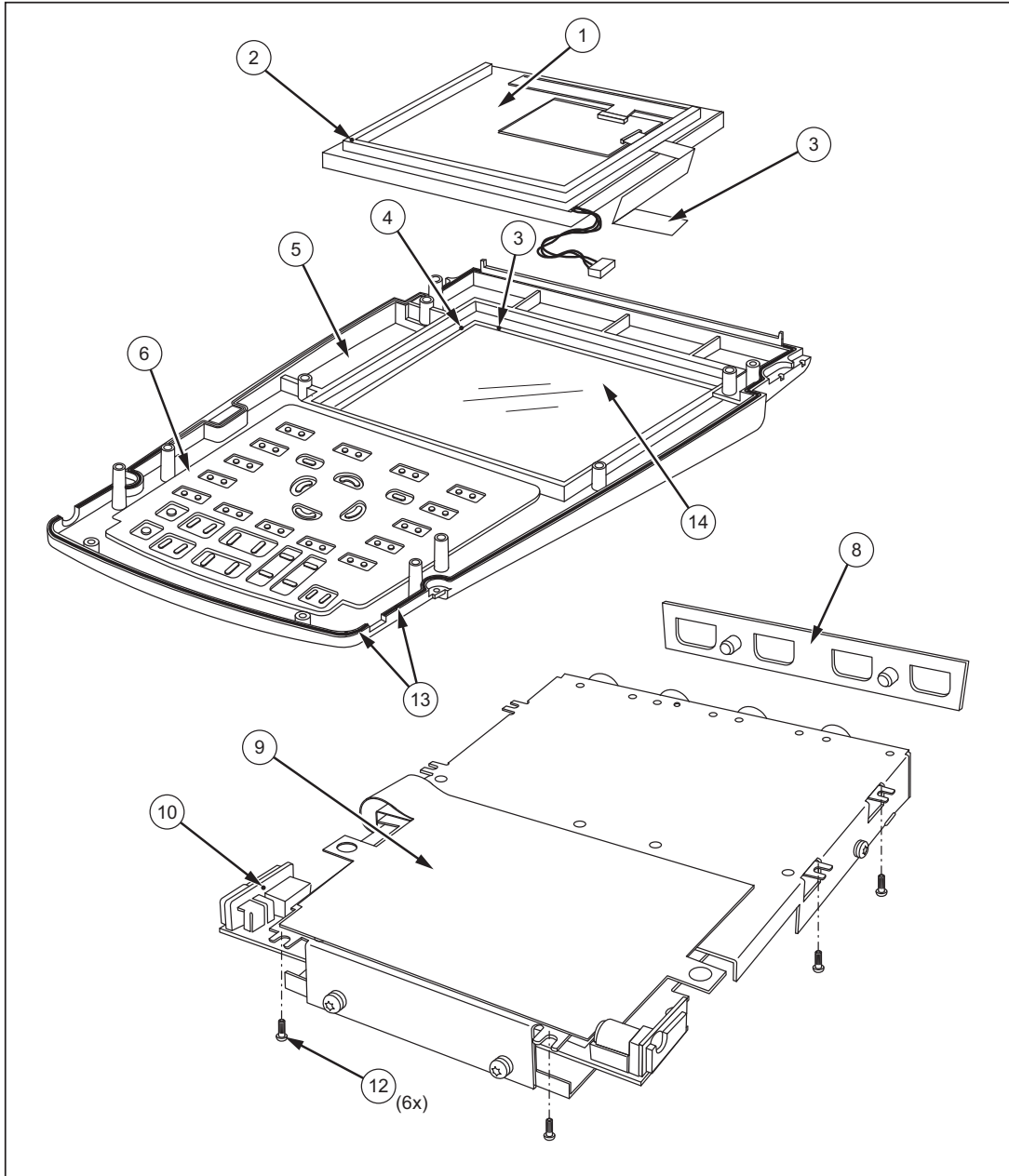

Figure 3-3. PCA Removed from Chassis, Bottom Side Visible

hpp203.eps

Accessory List

For an Accessory list, see *Maintaining the Test Tool* in the *Fluke ScopeMeter 190 Series II Users Manual*.

Go to www.fluke.com to download the users manual.

Chapter 4

Performance Verification

Title	Page
Introduction	4-3
Equipment Requirements for Verification	4-4
General Instructions.....	4-4
Operation Instructions.....	4-4
Reset the Test Tool	4-4
Menu Navigation	4-5
Standard Test Tool Setup.....	4-5
Display and Backlight Test	4-7
Scope Input A, B, C, D Tests.....	4-8
Input A, B, C, D Vertical Accuracy Test.....	4-8
Input A, B, C, D DC Voltage Accuracy Test.....	4-11
Input A, B, C, D AC Voltage Accuracy Test (LF)	4-14
Input A, B, C, D AC-Coupled Lower Frequency Test.....	4-16
Input A, B, C, D Peak Measurements Test.....	4-17
Input A, B, C, D Frequency Measurement Accuracy Test	4-18
Input A&B / C&D Phase Measurements Test	4-19
Time Base Test.....	4-20
Input A Trigger Sensitivity Test.....	4-21
Input A AC Voltage Accuracy (HF) and Bandwidth Test.....	4-23
Input B Trigger Sensitivity Test.....	4-24
Input B AC Voltage Accuracy (HF) and Bandwidth Test.....	4-25
Input C Trigger Sensitivity Test.....	4-26
Input C AC Voltage Accuracy (HF) and Bandwidth Test	4-27
Input D Trigger Sensitivity Test.....	4-28
Input D AC Voltage Accuracy (HF) and Bandwidth Test	4-30
Video Test with SC600 Scope Calibration Option	4-31

External Trigger Level Test	4-34
Meter (DMM) Tests.....	4-35
Meter DC Voltage Accuracy Test	4-35
Meter AC Voltage Accuracy and Frequency Response Test	4-36
Continuity Function Test.....	4-37
Diode Test Function Test	4-37
Ohms Measurements Test	4-38
Probe Calibration Generator Test	4-39

Introduction

⚠⚠ Warning

To prevent possible electrical shock, fire, or personal injury, do not service the Test Tool unless you are qualified to do so. Service described in this manual is to be done only by qualified service personnel.

Table 4-1 lists the available models for the Test Tools.

Table 4-1. Model Descriptions

Model	Description of Main Features
190-062	Two 60 MHz Scope Inputs (BNC), one Meter Input (banana jacks).
190-102	Two 100 MHz Scope Inputs (BNC), one Meter Input (banana jacks).
190-104	Four 100 MHz Scope Inputs (BNC).
190-202	Two 200 MHz Scope Inputs (BNC), one Meter Input (banana jacks).
190-204	Four 200 MHz Scope Inputs (BNC).
190-502	Two 500 MHz Scope Inputs (BNC), one Meter Input (banana jacks).
190-504	Four 500 MHz Scope Inputs (BNC).

The Test Tool should be calibrated and in operating condition on arrival.

The following performance tests are provided to ensure that the Test Tool is in proper operating condition. If the Test Tool fails any of the performance tests, calibration adjustment (see Chapter 5) and/or repair is necessary.

The Performance Verification Procedure is based on the specification (see Chapter 2). The values given here are valid for ambient temperatures between 18 °C and 28 °C.

The Performance Verification Procedure is a quick and efficient way to check all main specifications of the Test Tool. Accuracy of Test Tool specifications not tested is linked to those tested in this verification procedure and is embedded in the Test Tool's software. This link is tested extensively for each new software release.

Equipment Requirements for Verification

The primary source instrument used in the verification procedures is the Fluke 5502A. If a 5502A is not available, you can substitute another calibrator as long as it meets the minimum test requirements.

- Fluke 5502A Multi-Product Calibrator, including SC600 Oscilloscope Calibration Option.
- Stackable test leads (4x) as supplied with the 5502A.
- 50 Ω Coax Cables (2x): use Fluke PM9091 (1.5 m, 3 pcs./set) and PM9092 (0.5 m, 3 pcs./set).
- Male BNC to Dual Female BNC adapter (1x), Fluke PM9093/001.
- 50 Ω feed through termination, always use Fluke **TRM50** for Fluke 190-502 and 190-504.
- Dual Banana Plug to Female BNC Adapter (1x), Fluke PM9081/001.
- Dual Banana Jack to Male BNC Adapter (1x), Fluke PM9082/001.
- TV Signal Generator (part of SC600 600 MHz Oscilloscope Calibration Option).
- 10:1 Attenuator Probes as supplied with Test Tool.

General Instructions





Follow these general instructions for all tests:

- Power the Test Tool with the BC190 power adapter. The battery pack must be installed.
- Allow the 5502A to satisfy its specified warm-up period.
- For each test point, wait for the 5502A to settle.
- Allow the Test Tool a minimum of 30 minutes to warm up.
- One division on the LCD consists of 25 pixels (1 pixel = 0.04 division).
- This procedure is set up for all models of the Test Tool. These have either two oscilloscope channels A and B with BNC inputs and a multimeter channel with banana inputs, or four oscilloscope channels.
The figures that show the connection between calibrator and Test Tool are universal and also show the connection between calibrator and a Test Tool with four oscilloscope channels (for instance model 190-204).

Operation Instructions

Reset the Test Tool

Proceed as follows to reset the Test Tool:

1. Press  to turn off the Test Tool.
2. Press and hold .
3. Press and release  to turn on the Test Tool.
4. Wait until the Test Tool **beeps twice** and then release . Two beeps indicate a successful reset.

Menu Navigation

During verification you must open menus and choose items from the menu.

Proceed as follows to make choices in a menu:

1. Reset the Test Tool.
2. Open a menu, for example, press **SCOPE** and press **F2** (READING ...).
 The menu shown in Figure 4-1 opens.
 A yellow background or yellow characters mark the active functions. If more than one menu group is available, they are separated by a vertical line.
3. Press **←** or **→** to highlight the function to be selected.
4. Press **ENTER** to confirm the selection.

The active function in the next menu group is highlighted. If the confirmation is made in the last (most right) menu group, the menu will close.

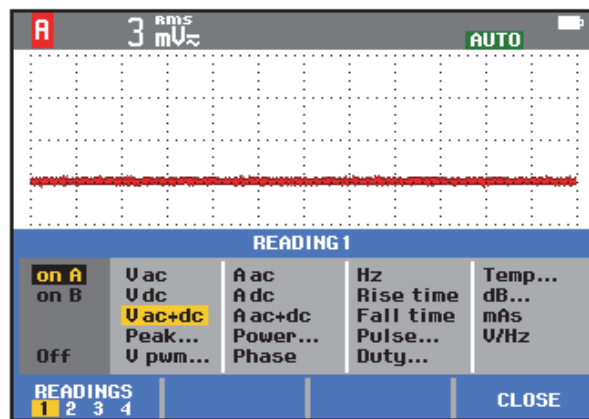

ws-Read2.BMP

Figure 4-1. Menu Item Selection

Standard Test Tool Setup

Before you start the verification procedure you must define a standard Test Tool setup, for example, SCOPE 1. During verification you will be asked to recall this setup. This defines the initial Test Tool setup for each verification.









Press **ENTER** to confirm each setting.

Note

The setup steps for channel C and D are only for the models 190-104, 190-204, and 190-504.

Proceed as follows to create a setup (for instance SCOPE1):

1. Reset the Test Tool. Input A is ON and other inputs are OFF.
2. Press **B** : **INPUT B ON**. The black text with yellow background indicates the actual settings.

3. Press **F3** to change the **PROBE B** setting.
4. Select **Probe Type: Voltage | Attenuation: 1:1**.
5. Press **C** : **INPUT C ON**.
6. Press **F3** to change the **PROBE C** setting.
7. Select **Probe Type: Voltage | Attenuation: 1:1**.
8. Press **D** : **INPUT D ON**.
9. Press **F3** to change the **PROBE D** setting.
10. Select **Probe Type: Voltage | Attenuation: 1:1**.
11. Press **A**. The inverse text indicates the actual settings.
12. Press **F3** to change the **PROBE A** setting.
13. Select **Probe Type: Voltage | Attenuation: 1:1**.
14. Press **SCOPE**.
15. Press **F1** – **READINGS ON**.
16. Press **F2** – **READING ...** and select with **F1** – **READINGS** and with  
 - a) Reading 1, on A, V dc
 - b) Reading 2, on B, V dc
 - c) Reading 3, on C, V dc
 - d) Reading 4, on D, V dc
17. Press **F4** **WAVEFORM OPTIONS** and select **Glitch: Off | Acquisition: Normal | Average: Off | Waveform: Normal**.
18. Press **MANUAL AUTO** to select **MANUAL** ranging (**MANUAL** in upper right of display).
19. Press **A**. Use  and  to move the Input A ground level (indicated by the zero icon  in the left margin) to the center grid line. Do this for all channels.
20. Press **SAVE**.
21. Press **F1** **SAVE...**
22. Use   to select **SCREEN+SETUP**.
23. Press **ENTER**.
24. Use   to select **OK SAVE**. Remember the name under which the settings are saved (for instance SCOPE 1).
25. Press **ENTER** to save the settings.
26. Press **HOLD RUN** to leave the Hold mode.

Display and Backlight Test

Proceed as follows to test the display and the backlight:

1. Press **⏻** to turn the Test Tool on.
2. Remove the BC190 power adapter, and verify that the backlight is dimmed.
3. Apply the BC190 power adapter and verify that the backlight brightness increases.
4. Press and hold **USER** (USER), then press and release **CLEAR** (CLEAR MENU).
The Test Tool shows the calibration menu in the bottom of the display.
5. Do not press **F3** now. If you do, turn off and turn on the Test Tool, and start at Step 4.
6. Press **CLEAR** to toggle on and off the menu.
5. Press **F1** (PREVIOUS) three times.
The Test Tool shows **Contrast (CL 0100)**:
6. Press **F3** (CALIBRATE). The Test Tool shows a dark display. The test pattern shown in Figure 4-2 may be not visible or hardly visible. Observe the display closely, and verify that the display shows no abnormalities, such as very light pixels or lines.

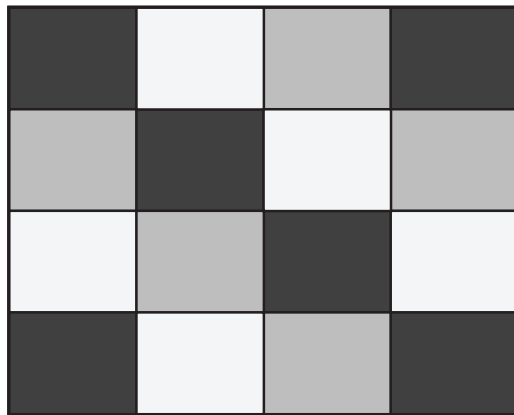

Figure 4-2. Display Test Pattern

hpp204.eps

7. Press **F2**.
The test pattern is removed and the Test Tool shows **Contrast (CL 0100)**:
8. Press **F2** again to do the next **Contrast (CL 0110)**:
9. Press **F3** (CALIBRATE).
The Test Tool shows the display test pattern at default contrast, see Figure 4-2.
Observe the display closely. Verify that the display shows no abnormalities and that the contrast of the upper left and upper right square of the test pattern is equal.

10. Press **F2**.

The test pattern is removed and the Test Tool shows **Contrast (CL 0110)**:

11. Press **F2** again to do the next step **Contrast (CL 0120)**:

12. Press **F3** (CALIBRATE).

The Test Tool shows a light display. The test pattern shown in Figure 4-2 may not be visible or hardly visible.

Observe the display closely and verify that the display shows no abnormalities.

13. Turn off and turn on the Test Tool to exit the calibration menu and return to the normal operating mode.

If the maximum, minimum, or default display contrast is not OK, then you can adjust these items without performing a complete calibration adjustment; refer to Section 5 for detailed information.

Scope Input A, B, C, D Tests

Input A, B, C, D Vertical Accuracy Test

Warning

To prevent possible electrical shock, fire, or personal injury, ensure that the calibrator is in standby mode before making any connection between the calibrator and the Test Tool. Dangerous voltages are present on the calibration source and connection cables during these steps.

Note

The test steps for channels C and D are only for the models 190-104, 190-204, or 190-504.

Proceed as follows:

1. Connect the Test Tool to the 5502A as shown in Figure 4-3. The vertical channels A, B, C, and D are checked in succession so that there is one waveform on the display at a time to facilitate amplitude adjustment.

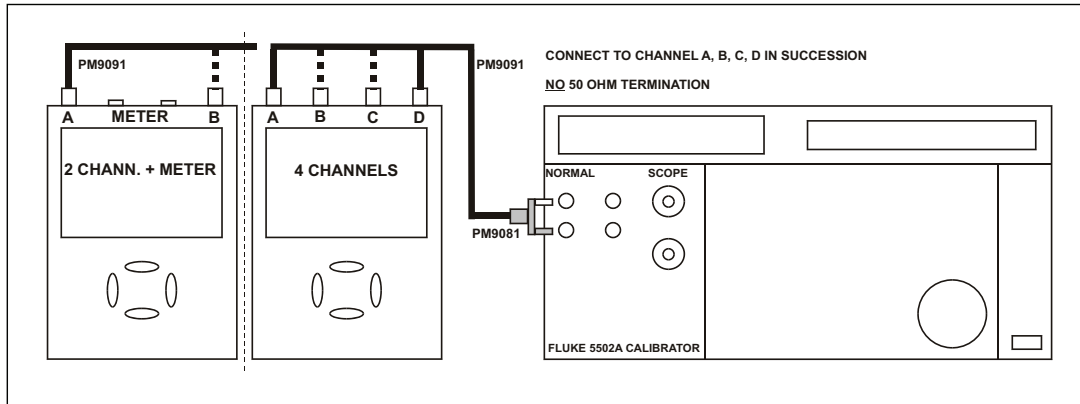

Figure 4-3. Test Tool Inputs A, B to 5502A Normal Output

perf-ver-a2.eps

2. Select the following Test Tool setup:
 - a) Recall the created setup (see *Standard Test Tool Setup*). Press **SAVE**, **F2** (RECALL) and select **SETUP**, press **ENTER**, select the setup name, and press **ENTER** to recall the setup.
 - b) Press **A**, press **F4** (INPUT A OPTIONS...), and select **Attenuator: Normal | Bandwidth: 10 kHz** or **20 kHz** for the available setting in the Test Tool.
 - c) Press **B**, press **F4** (INPUT B OPTIONS...), and select **Attenuator: Normal | Bandwidth: 10 kHz** or **20 kHz** for the available setting in the Test Tool.
 - d) Press **C**, press **F4** (INPUT C OPTIONS...), and select **Attenuator: Normal | Bandwidth: 10 kHz** or **20 kHz** for the available setting in the Test Tool.
 - e) Press **D**, press **F4** (INPUT D OPTIONS...), and select **Attenuator: Normal | Bandwidth: 10 kHz** or **20 kHz** for the available setting in the Test Tool.
 - f) Press **CLEAR** to clear the softkey menu and see the full display.

Note

The 10 kHz or 20 kHz bandwidth limiter rejects calibrator noise. It does not affect the gain accuracy at a 50 Hz input signal.

3. Press **A** and use **mV RANGE** and **V RANGE** to set the Input A sensitivity range to the first test point in Table 4-2.
4. Set the 5502A to source the appropriate initial ac voltage.
5. Adjust the 5502A output voltage until the displayed Input A trace amplitude is 6 divisions.
6. Observe the 5502A output voltage and check to see if it is within the range shown under the appropriate column.
7. Continue through the test points.

8. Check channel B, C, and D in succession. Connect channel B, C, or D to 5502A when appropriate.
9. Press **TRIGGER** and select B as trigger source with **F1**.
10. Press B, C, or D to assign vertical range to channel B, C, or D.
11. Observe the 5502A output voltage and check to see if it is within range.
12. When you are finished, set the 5502A to 0 (zero) Volt and Standby.

Table 4-2. Vertical Accuracy Verification Points

Range	Initial 5502A Setting V ac, sine, 50 Hz	Allowable 5502A output for trace amplitude of 6 divisions
2 mV/div	4.243 mV	3.960 to 4.526
5 mV/div	10.606 mV	10.183 to 11.028
10 mV/div	21.213 mV	20.368 to 22.058
20 mV/div	42.426 mV	40.735 to 44.117
50 mV/div	106.06 mV	101.83 to 110.29
100 mV/div	212.13 mV	203.67 to 220.58
200 mV/div	424.26 mV	407.35 to 441.17
500 mV/div	1.0607 V	1.0184 to 1.1030
1 V/div	2.1213 V	2.0367 to 2.2058
2 V/div	4.2426 V	4.0735 to 4.4117
5 V/div	10.606 V	10.183 to 11.029
10 V/div	21.213 V	20.368 to 22.058
20 V/div	42.426 V	40.735 to 44.117
50 V/div	106.06 V	101.83 to 110.29
100 V/div	212.13 V	203.67 to 220.58

The vertical accuracy test can be done with dc voltage. This method is advised for automatic verification that uses the Fluke Met/Cal Metrology Software. For each sensitivity range you must proceed as follows:

1. Apply a +3 division voltage, and adjust the voltage until the trace is at +3 divisions. Write down the applied voltage V1.
2. Apply a -3 division voltage, and adjust the voltage until the trace is at -3 divisions. Write down the applied voltage V2.
3. Verify that $V1 - V2 = 6 \times \text{range} \pm (2.1 \% + 0.04 \times \text{range})$

Example: for range 10 mV/div. (range/div figure doubles because 2 measurements V1 and V2 are done for one accuracy check) the allowed $V1 - V2 = 60 \text{ mV} \pm (0.021 \times 60 + 0.08 \times 10) = 60 \text{ mV} \pm (1.26 + 0.8) = 60 \text{ mV} \pm 2.06 \text{ mV}$.

Input A, B, C, D DC Voltage Accuracy Test

⚠️⚠️ Warning

To prevent possible electrical shock, fire, or personal injury, ensure that the calibrator is in standby mode before making any connection between the calibrator and the Test Tool. Dangerous voltages are present on the calibration source and connection cables during these steps.

Note

The test steps for channel C and D are only for the models 190-104, 190-204, and 190-504.

Proceed as follows to verify the automatic dc voltage scope measurement:

1. Connect the Test Tool to the 5502A as shown in see Figure 4-4.

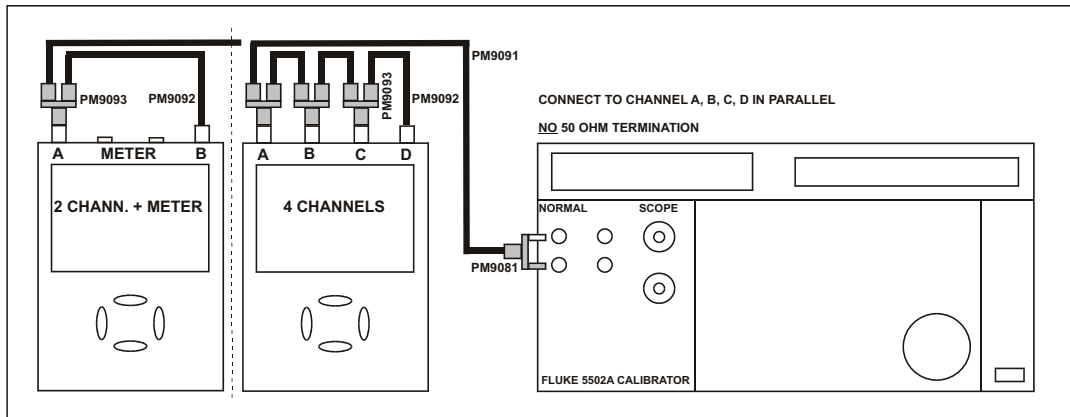

Figure 4-4. Test Tool Inputs A, B, C, D to 5502A Normal Output

perf-ver-b2.eps

2. Select the Test Tool setup:
 - a) Recall the setup (see *Standard Test Tool Setup*). Press **SAVE**, **F2** (RECALL) and select **SETUP**. Press **ENTER**, select the setup name, and press **ENTER** to recall the setup.
 - b) Press **A**, press **F4** (INPUT A OPTIONS...), and select **Attenuator: Normal | Bandwidth: 10 kHz or 20 kHz** for the available setting in the ScopeMeter.
 - c) Press **B**, press **F4** (INPUT B OPTIONS...), and select **Attenuator: Normal | Bandwidth: 10 kHz or 20 kHz** for the available setting in the ScopeMeter.
 - d) Press **C**, press **F4** (INPUT C OPTIONS...), and select **Attenuator: Normal | Bandwidth: 10 kHz or 20 kHz** for the available setting in the ScopeMeter.
 - e) Press **D**, press **F4** (INPUT D OPTIONS...), and select **Attenuator: Normal | Bandwidth: 10 kHz or 20 kHz** for available setting in the ScopeMeter.
 - f) Press **CLEAR** to clear the softkey menu and the full 8-divisions display.
3. Press **A** and use **mV RANGE** and **RANGE V** to set the Input A sensitivity range to the first test point in Table 4-3. Do this also for channel B, C, and D.
4. Set the 5502A to source the appropriate dc voltage.
5. Observe readings **A**, **B**, **C**, and **D** and check they are within the range shown under the appropriate column.

Due to calibrator noise, occasionally OL (overload) can be shown.
6. Continue through the test points.
7. When you are finished, set the 5502A to 0 (zero) Volt and Standby.

Table 4-3. Volts DC Measurement Verification Points

Range	5502A Output V dc	2 Channel Input Reading	4 Channel Input Reading
2 mV/div	+6.0 mV	+4.9 to +7.1	+4.8 to +7.2
	-6.0 mV	-7.1 to -4.9	-7.2 to -4.8
5 mV/div	+15.0 mV	+14.2 to +15.8	+13.9 to +16.1
	-15.0 mV	-15.8 to -14.2	-16.1 to -13.9
10 mV/div	+30.0 mV	+28.9 to +31.1	+28.5 to +31.5
	-30.0 mV	-31.1 to -28.9	-31.5 to -28.5
20 mV/div	+60.0 mV	+58.5 to +61.5	57.6 to 62.4
	-60.0 mV	-61.5 to -58.5	-62.4 to -57.6
50 mV/div	+150 mV	+142 to +158	+139 to +161
	-150 mV	-158 to -142	-161 to -139
100 mV/div	+300 mV	+289 to +311	+285 to +315
	-300 mV	-311 to -289	-315 to -285
200 mV/div	+600 mV	+585 to +615	+576 to +624
	-600 mV	-615 to -585	-624 to -576
500 mV/div	+1.50 V	+1.42 to +1.58	+1.39 to +1.61
	-1.50 V	-1.58 to -1.42	-1.61 to -1.39
1 V/div	+3.00 V	+2.89 to +3.11	+2.85 to +3.15
	-3.00 V	-3.11 to -2.89	-3.15 to -2.85
2 V/div	+6.00 V	+5.85 to +6.15	+5.76 to +6.24
	-6.00 V	-6.15 to -5.85	-6.24 to -5.76
5 V/div	+15.0 V	+14.2 to +15.8	+13.9 to +16.1
	-15.0 V	-15.8 to -14.2	-16.1 to -13.9
10 V/div	+30.0 V	+28.9 to +31.1	+28.5 to +31.5
	-30.0 V	-31.1 to -28.9	-31.5 to -28.5
20 V/div	+60.0 V	+58.5 to +61.5	57.6 to 62.4
	-60.0 V	-61.5 to -58.5	-62.4 to -57.6
50 V/div	+150 V	+142 to +158	+139 to +161
	-150 V	-158 to -142	-161 to -139
100 V/div	+300 V	+289 to +311	+285 to +315
	-300 V	-311 to -289	-315 to -285

Input A, B, C, D AC Voltage Accuracy Test (LF)

Note

The test steps for channel C and D are only for the models 190-104, 190-204, and 190-504.

This procedure tests the Volts ac accuracy with dc-coupled inputs up to 50 kHz. The high frequencies are tested in sections, *Input A AC Voltage Accuracy (HF) & Bandwidth Test* and *Input B AC Voltage Accuracy (HF) & Bandwidth Test*.

⚠⚠ Warning

To prevent possible electrical shock, fire, or personal injury, ensure that the calibrator is in standby mode before making any connection between the calibrator and the Test Tool. Dangerous voltages are present on the calibration source and connection cables during these steps.

Proceed as follows to test the Input A, B, C, and D automatic scope ac Voltage measurement accuracy:

1. Connect the Test Tool to the 5502A as shown in Figure 4-4.
2. Select the Test Tool setup:
 - a) Recall the created setup (*Creating a Standard Test Tool Setup*). Press **SAVE**, **F2** (RECALL) and select **SETUP**, press **ENTER**, select the setup name, and press **ENTER** to recall the setup.
 - b) Press **A**, then press **F4** (INPUT A OPTIONS ...).
 - c) Select **Attenuator: Normal | Bandwidth: 10 kHz** or **20 kHz** for the available setting in the ScopeMeter (2 mV/d and 5 mV/d) or | **Bandwidth: 20 MHz** (other ranges).
 - d) Press **B**, then press **F4** (INPUT B OPTIONS ...).
 - e) Select **Attenuator: Normal | Bandwidth: 10 kHz** or **20 kHz** for the available setting in the ScopeMeter (2 mV/d and 5 mV/d) or | **Bandwidth: 20 MHz** (other ranges).
 - f) Press **C**, and then press **F4** (INPUT C OPTIONS ...).
 - g) Select **Attenuator: Normal | Bandwidth: 10 kHz** or **20 kHz** for the available setting in the ScopeMeter (2 mV/d and 5 mV/d) or | **Bandwidth: 20 MHz** (other ranges).
 - h) Press **D**, then press **F4** (INPUT D OPTIONS ...).
 - i) Select **Attenuator: Normal | Bandwidth: 10 kHz** or **20 kHz** for the available setting in the ScopeMeter (2 mV/d and 5 mV/d) or | **Bandwidth: 20 MHz** (other ranges).
 - j) Press **CLEAR** to clear the softkey menu and see the full 8-divisions display.
3. Press **SCOPE**.
4. Press **F2** (– READING ...) and select with **F1** (– READINGS) and the **▲ ▼**:
Reading 1, on A, V ac
Reading 2, on B, V ac
Reading 3, on C, V ac
Reading 4, on D, V ac



5. Use  to change the time base and lock on 20 μ s/div for the 20 kHz signal and on 10 ms/div for the 60 Hz signal.
6. Use  and  to select the manual vertical ranging. Set the input A and B sensitivity range to the first test point in Table 4-4.
The sensitivity ranges are indicated in the lower display edge.
7. Set the 5502A to source the appropriate ac voltage.
8. Observe readings **A, B, C,** and **D** and check to see if they are within the range shown under the appropriate column.
9. Continue through the test points.
10. When you are finished, set the 5502A to 0 (zero) Volt and Standby.

Table 4-4. Volts AC Measurement Verification Points

Range	5502A output		2 Ch Input Reading	4 Ch Input Reading
	V ac	Frequency		
2 mV/div (Select 10 ms/div)	4 mV	60 Hz	2.9 mV to 5.1 mV	2.9 mV to 5.1 mV
<i>Note</i> Set input A, B, Bandwidth 10 kHz or 20 kHz to prevent OL due to calibrator noise, see step 2.				
5 mV/div	10 mV	60 Hz	8.8 mV to 11.2 mV	8.7 mV to 11.3 mV
10 mV/div (Select 20 μs/div).	20 mV	20 kHz	18.0 mV to 22.0 mV	17.7 mV to 22.3 mV
<i>Note</i> Set input A, B Bandwidth 20 MHz.				
20 mV/div	40 mV	20 kHz	37.5 mV to 42.5 mV	36.9 mV to 43.1 mV
50 mV/div	100 mV	20 kHz	96.0 mV to 104.0 mV	94.5 mV to 105.5 mV
100 mV/div	200 mV	20 kHz	180 mV to 220 mV	177 mV to 223 mV
200 mV/div	400 mV	20 kHz	375 mV to 425 mV	369 mV to 431 mV
500 mV/div (Select 10 ms/div)	900 mV	60 Hz	876 mV to 924 mV	863 mV to 937 mV
500 mV/div (Select 20 μs/div)	900 mV	20 kHz	862 mV to 938 mV	849 mV to 951 mV
1 V/div	2 V	20 kHz	1.80 V to 2.20 V	1.77 V to 2.23 V
2 V/div	4 V	20 kHz	3.75 V to 4.25 V	3.69 V to 4.31 V
5 V/div	9 V	20 kHz	8.62 V to 9.38 V	8.49 V to 9.51 V
10 V/div	20 V	20 kHz	18.0 V to 22.0 V	17.7 V to 22.3 V
20 V/div	40 V	20 kHz	37.5 V to 42.5 V	36.9 V to 43.1 V
50 V/div	90 V	20 kHz	86.2 V to 93.8 V	84.9 V to 95.1 V
100 V/div	200 V	20 kHz	180 V to 220 V	177 V to 223 V

Input A, B, C, D AC-Coupled Lower Frequency Test

Note

The test steps for channel C and D are only for the models 190-104, 190-204, and 190-504.

To test the ac-coupled input low-frequency accuracy:

1. Connect the Test Tool to the 5502A as for the previous test (see Figure 4-4).
2. Select the Test Tool setup:
 - a) Recall the setup (*Standard Test Tool Setup*). Press **SAVE**, **F2** (RECALL) and select **SETUP**, press **ENTER**, select the setup name, and press **ENTER** to recall the setup.
 - b) Press **SCOPE**.
 - c) Press **F2** (– READING ...) and select with **F1** (– READINGS) and **↑**/**↓**:
 - Reading 1, on A, V ac
 - Reading 2, on B, V ac
 - Reading 3, on C, V ac
 - Reading 4, on D, V ac
 - d) Press **A** and use **F2** to select **COUPLING AC**.
 - e) Press **B** and use **F2** to select **COUPLING AC**.
 - f) Press **C** and use **F2** to select **COUPLING AC**.
 - g) Press **D** and use **F2** to select **COUPLING AC**.
 - h) Press **CLEAR** to clear the softkey menu and see the full display.
3. Use **TIME** to change the time base to lock the time base on 40 ms/div.
4. Use **mV RANGE** and **RANGE V** to set the Input A, B, C and D sensitivity range to 500 mV.
5. Set the 5502A to source the appropriate ac voltage and frequency listed in Table 4-5.
6. Observe the reading **A**, **B**, **C**, and **D** and check that they are within the range shown under the appropriate column.
7. Continue through the test points.
8. When you are finished, set the 5502A to 0 (zero) Volt and Standby.

Table 4-5. Input A, B AC Input Coupling Verification Points

5502A output, V rms	5502A Frequency	2 Ch Reading	4 Ch Reading
900 mV	60 Hz	873 mV to 920 mV	859 mV to 933 mV
900 mV	5 Hz	>630 mV	>630 mV

Input A, B, C, D Peak Measurements Test

Warning

To prevent possible electrical shock, fire, or personal injury, ensure that the calibrator is in standby mode before making any connection between the calibrator and the Test Tool. Dangerous voltages are present on the calibration source and connection cables during these steps.

Note

The test steps for channel C and D are only for the models 190-104, 190-204, and 190-504.

To test the peak measurement accuracy:













1. Connect the Test Tool to the 5502A as shown Figure 4-4.
2. Select the Test Tool setup:
 - a) Recall the setup (see *Standard Test Tool Setup*). Press ,  (RECALL) and select **SETUP**, press , select the setup name, and press  to recall the setup.
 - b) Press .
 - c) Press  (– READING ...) and select with  (– READINGS) and with  :
 - Reading 1, on A, Peak ...** and next **Peak-Peak Reading 2, on B, Peak ...** and next **Peak-Peak Reading 3, on C, Peak ...** and next **Peak-Peak Reading 4, on D, Peak ...** and next **Peak-Peak**
 - d) Press  to clear the softkey menu, and to see the full display.
3. Use  to change the time base and lock the time base on 1 ms/div.
4. Use  and  to set the Input A, B, C, and D sensitivity ranges to 100 mV.
5. Set the 5502A to source the appropriate ac voltage and frequency as listed in Table 4-6.
6. Observe readings **A, B, C,** and **D** and check that they are within the range shown under the appropriate column.
7. When you are finished, set the 5502A to 0 (zero) Volt and Standby.

Table 4-6. Volts Peak Measurement Verification Points

5502A output, V_{rms} (sine)	5502A Frequency	Reading A, B
212.13 mV (0.6 V pp)	1 kHz	0.56 to 0.64

Input A, B, C, D Frequency Measurement Accuracy Test

Note

The test steps for channel C and D are only for the models 190-104, 190-204, and 190-504.

Proceed as follows to test the frequency measurement accuracy:

1. Connect the Test Tool to the 5502A as shown in Figure 4-5. Do not use 50 Ω terminations.

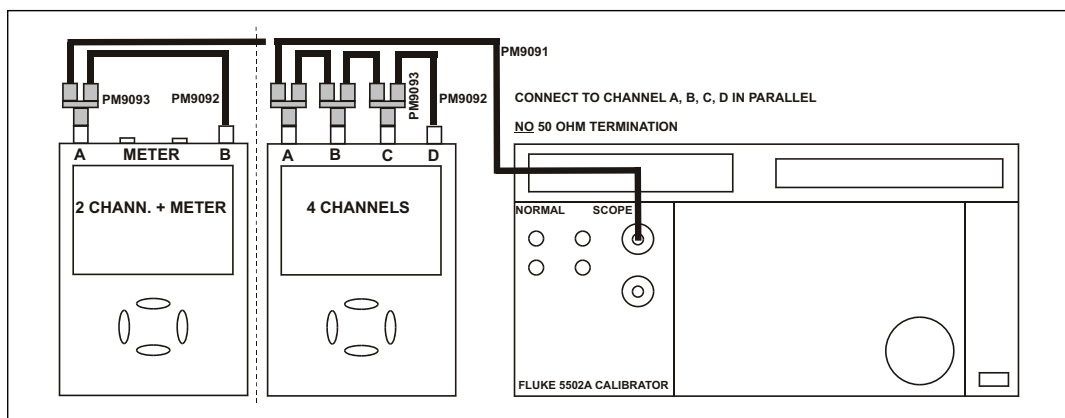

Figure 4-5. 5502A Scope Output to Test Tool Input A, B, C, D

perf-ver-c2.eps

2. Select the following Test Tool setup:

- a) Recall the created setup (see *Standard Test Tool Setup*). Press **SAVE**, **F2** (RECALL) and select **SETUP**, press **ENTER**, select the setup name, and press **ENTER** to recall the setup.

- b) Press **SCOPE**.

- c) Press **F2** (- READING ...) and select with **F1** (- READINGS) and with **↑** **↓**:

Reading 1, on A, Hz

Reading 2, on B, Hz

Reading 3, on C, Hz

Reading 4, on D, Hz

3. Use **mV RANGE** and **RANGE V** to select range 100 mV/div for A, B, C and D.

4. Use **s TIME ns** to select the required time base setting.

5. Set the 5502A to source a sine wave according to the first test point in Table 4-7.

Because no 50 Ω termination is applied, the 5502A leveled sine wave output amplitude is twice the set value.

6. Observe reading **A**, **B**, **C**, and **D** and check that it is within the range shown under the appropriate column.

7. Continue through the test points.
8. When you are finished, set the 5502A to 0 (zero) Volt and Standby.

Table 4-7. Input A, B, C, D Frequency Measurement Accuracy Test

Model	Time base	5502A-SC... MODE	Voltage	Frequency	Input A, B Reading
All	20 ms/div	wavegen, sine	600 mVpp	16 Hz	15.90 to 16.10
190-062	20 ns/div	levsine	600 mVpp	60 MHz	59.68 to 60.32
190-104 190-102	20 ns/div	levsine	600 mVpp	100 MHz	99.3 to 100.7
190-204 190-202	20 ns/div	levsine	600 mVpp	200 MHz	198.8 to 201.2
190-502 190-504	20 ns/div	levsine	600 mVpp	500 MHz	497.3 to 502.7

Note











Because Duty Cycle and Pulse Width measurements are based on the same principles as Frequency measurements, these measurement functions will not be verified separately.

Input A&B / C&D Phase Measurements Test

Note

The test steps for channel C and D are only for the models 190-104, 190-204, and 190-504.

Proceed as follows to test the phase measurement accuracy:

1. Connect the Test Tool to the 5502A as shown in Figure 4-5.
2. Select the Test Tool setup:
 - d) Recall the created setup (see *Standard Test Tool Setup*). Press ,  (RECALL) and select **SETUP**, press , select the setup name, and press  to recall the setup.
 - e) Press .
 - f) Press  (- READING ...) and select with  (- READINGS) and :
 - Reading 1, on A, Phase**
 - Reading 2, on B, Phase**
 - Reading 3, on C, Phase**
 - Reading 4, on D, Phase**
3. Use  and  to select range 100 mV/div for A, B, C and D.
4. Use  to select the required time base setting.

- Set the 5502A to source a sine wave according to the first test point in Table 4-8.

Because no 50 Ω termination is applied, the 5502A leveled sine wave output amplitude will be twice the set value.

- Observe the readings **A**, **B**, **C**, and **D** and check that they are not outside the range shown under the appropriate column.
- Continue through the test points.
- When you are finished, set the 5502A to 0 (zero) Volt and Standby.

Table 4-8. Phase Measurement Verification Points

Time base	5502A-SC... MODE	Frequency	Voltage	Input A, B, C, D Reading ... Deg
20 ms/div	wavegen, sine, 1 MΩ	10 Hz	600 mVpp	-2 to +2
200 ns/div	levsine	1 MHz	300 mVpp	-2 to +2
20 ns/div	levsine	10 MHz	300 mVpp	-3 to +3

Time Base Test

Proceed as follows to test the time base accuracy:

- Connect the Test Tool to the 5502A as shown in Figure 4-6.

For the Fluke 190-502 and 190-504 you must use the Fluke TRM50 50 Ω terminator.

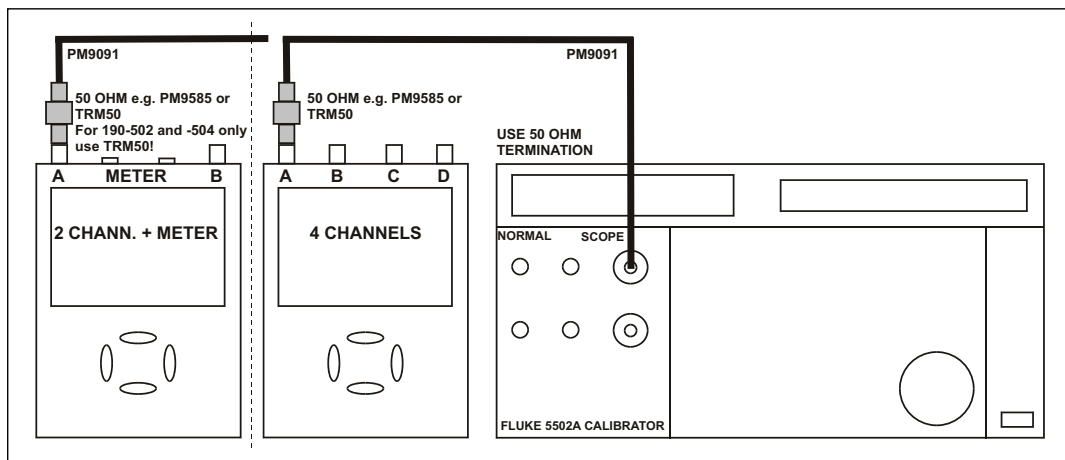







Figure 4-6. 5502A Scope Output to Test Tool Input A

perf-ver-d2.eps

- Set the 5502A to source an 8 ms time marker (MODE marker).

3. Select the Test Tool setup:
 - a) Reset the Test Tool.
 - b) Use  and  to select manual vertical ranging, and set the Input A sensitivity range to 5 V/div (10:1 probe) or 500 mV/div (probe A factor is 1:1).
 - c) Use  to change the time base to select manual time base ranging and lock the time base on 10 ms/div).
 - d) Use  to move the trace to the left. Once the trigger point is shifted across the left hand border of the display, going off display, the trigger delay time with respect to the first vertical grid line will be indicated in the lower right of the display, see Figure 4-7.
Adjust the trigger delay time to 8.000 ms (A.J → 8.00 ms).
 - e) Use  to set the time base on 10 μs/div.
4. Use  to move the trace to the right until the indicated trigger delay is 7.940 ms.
5. Examine the rising edge of the time marker pulse at the height of the trigger level indicator top. Verify that the rising edge is at the center grid line. The allowed deviation is ±3 pixels, see Figure 4-7.

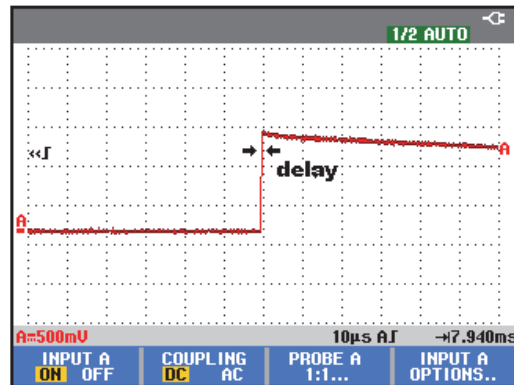





Figure 4-7. Time Base Verification

190c-tb3.bmp

Input A Trigger Sensitivity Test

Proceed as follows to test the Input A trigger sensitivity:

1. Connect the Test Tool to the 5502A as shown in Figure 4-6.
2. Reset the Test Tool to select the Test Tool setup.
3. Use  and  to change the sensitivity range to select manual sensitivity ranging, and lock the Input A sensitivity range on 2 V/div.
4. Use  to select the time base indicated under the second column of Table 4-9.



5. Set the 5502A to source the leveled sine wave for the appropriate Test Tool model.
6. Adjust the 5502A output voltage until the displayed trace has the trigger amplitude indicated under the last column of Table 4-9.
7. Verify that the signal is well triggered.
If not, press **TRIGGER** and use **F3** to enable   for manual Trigger Level adjustment. Adjust the trigger level and verify that the signal is triggered. The trigger icon () indicates the trigger level.
8. Continue through the test points.
9. When you are finished, set the 5502A to Standby.

Table 4-9. Input A Trigger Sensitivity Test Points

UUT Model	UUT Time base	5502A SC...	MODE levsine	UUT Trigger Amplitude
		Initial Input Voltage	Frequency	
All	200 ns/div	100 mV pp	5 MHz	0.5 div
190-062	10 ns/div	400 mV pp	60 MHz	1 div
	10 ns/div	800 mV pp	100 MHz	2 div
190-102 190-104	10 ns/div	400 mV pp	100 MHz	1 div
	10 ns/div	800 mV pp	150 MHz	2 div
190-202 190-204	10 ns/div	400 mV pp	200 MHz	1 div
	10 ns/div	800 mV pp	250 MHz	2 div
190-502 190-504	2 ns/div	400 mV pp	500 MHz	1 div
	2 ns/div	800 mV pp	600 MHz	2 div

Input A AC Voltage Accuracy (HF) and Bandwidth Test

Proceed as follows to test the Input A high frequency automatic scope ac voltage measurement accuracy and the bandwidth:











1. Connect the Test Tool to the 5502A as shown in Figure 4-6.
2. Select the Test Tool setup:
 - a) Recall the setup (see *Standard Test Tool Setup*). Press ,  (RECALL) and select **SETUP**, press , select the setup name, and press  to recall the setup.
 - b) Press , then press  (- READING...) and select  (READINGS) on **A | V ac**.
 - c) Press  to select autoranging (**AUTO** in upper right LCD edge).
 - d) Use  and  to change the sensitivity range to select manual sensitivity ranging, and lock the Input A sensitivity range on 500 mV/div. **AUTO** in upper right LCD edge becomes ½ **AUTO**.
 - e) Use  to move the Input A trace zero to the center grid line.
3. Set the 5502A to source a sine wave and to the first test point in Table 4-10.
4. Observe the Input A reading and check that it is within the range shown under the appropriate column.
5. Continue through the test points.
6. When you are finished, set the 5502A to Standby.

Table 4-10. HF AC Voltage Verification Points

UUT Model	5502A SC... MODE levsine		UUT Reading A
	Voltage	Frequency	
All	2.545 Vpp	1 MHz	835 mV to 965 mV
All	2.545 Vpp	25 MHz	790 mV to 1.010 V
190-062	2.545 Vpp	60 MHz	>630 mV
190-104, -102	2.545 Vpp	100 MHz	>630 mV
190-204, -202	2.545 Vpp	200 MHz	>630 mV
190-502; -504	2.545 Vpp	500 MHz	>630 mV

Input B Trigger Sensitivity Test

Proceed as follows to test the Input B trigger sensitivity:

1. Connect the Test Tool to the 5502A as shown in Figure 4-8.

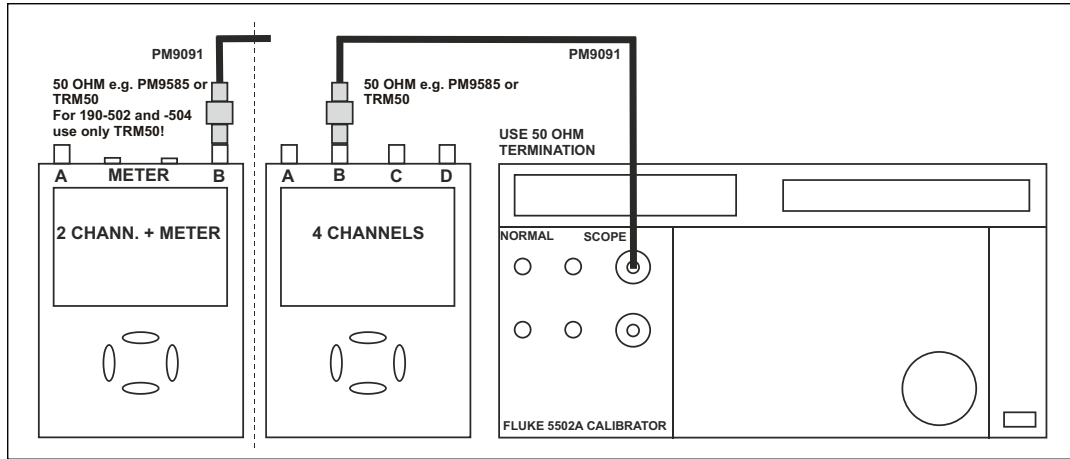

Figure 4-8. 5502A Scope Output to Test Tool Input B

perf-ver-e2.eps

2. Reset the Test Tool to select the Test Tool setup:
3. Press **B** to turn Input B on.
4. Press **TRIGGER** and use **F1** to select Input B as trigger source.
5. Use **RANGE** and **RANGE** to change the sensitivity range to select manual sensitivity ranging, and lock the Input B sensitivity range on 2 V/div.
6. Use **TIME** to select the time base listed in Table 4-11.
7. Set the 5502A to source the leveled sine wave given in the first row of Table 4-10.
8. Adjust the 5502A output voltage until the displayed trace has the amplitude indicated under the appropriate column of Table 4-11.
9. Verify that the signal is well triggered.



If not, press **TRIGGER** and use **F3** to enable  for manual Trigger Level adjustment. Adjust the trigger level and verify that the signal will be triggered now. The trigger icon () indicates the trigger level.
10. Continue through the test points.
11. When you are finished, set the 5502A to Standby.

Table 4-11. Input B Trigger Sensitivity Test Points

UUT Model	UUT Time base	5502A SC... MODE levsin		UUT Trigger Amplitude
		Initial Input Voltage	Frequency	
190-502	200 ns/div	100 mV pp	5 MHz	0.5 div
190-062	10 ns/div	400 mV pp	60 MHz	1 div
	10 ns/div	800 mV pp	100 MHz	2 div
190-102	10 ns/div	400 mV pp	100 MHz	1 div
190-104	10 ns/div	800 mV pp	150 MHz	2 div
190-202	10 ns/div	400 mV pp	200 MHz	1 div
190-204	10 ns/div	800 mV pp	250 MHz	2 div
190-502	2 ns/div	400 mV pp	500 MHz	1 div
190-504	2 ns/div	800 mV pp	600 MHz	2 div

Input B AC Voltage Accuracy (HF) and Bandwidth Test

Proceed as follows to test the Input B high frequency automatic scope ac voltage measurement accuracy and the bandwidth:

1. Connect the Test Tool to the 5502A as shown in Figure 4-8.
2. Select the Test Tool setup:
 - a) Recall the setup (see *Standard Test Tool Setup*). Press **SAVE**, **F2** (RECALL) and select **SETUP**, press **ENTER**, select the setup name, and press **ENTER** to recall the setup.
 - b) Press **SCOPE**, then press **F2** (READING...), select **F1** (READINGS 2), and select **on B | V ac**.
 - c) Press **MANUAL AUTO** to select autoranging (**AUTO** in upper right LCD edge).
 - d) Use **mV RANGE** and **RANGE V** to change the sensitivity range to select manual sensitivity ranging and lock the Input B sensitivity range on 500 mV/div.
 - e) Press **TRIGGER** and use **F1** to select Input B as trigger source.
3. Set the 5502A to source a sine wave at the first test point in Table 4-12.
4. Observe the Input B reading and check that it is within the range shown under the appropriate column of Table 4-12.
5. Continue through the test points.

6. When you are finished, set the 5502A to Standby.

Table 4-12. HF AC Voltage Verification Points

UUT Model	5502A SC...	MODE levsine	UUT Reading B
	Voltage	Frequency	
All	2.545 Vpp	1 MHz	835 mV to 965 mV
All	2.545 Vpp	25 MHz	790 mV to 1.010 V
190-062	2.545 Vpp	60 MHz	>630 mV
190-104, -102	2.545 Vpp	100 MHz	>630 mV
190-204, -202	2.545 Vpp	200 MHz	>630 mV
190-502; -504	2.545 Vpp	500 MHz	>630 mV

Input C Trigger Sensitivity Test

Note

The test steps for channel C are only for the models 190-104, 190-204, and 190-504.

Proceed as follows to test the Input C trigger sensitivity:

1. Connect the Test Tool to the 5502A as shown in Figure 4-9.

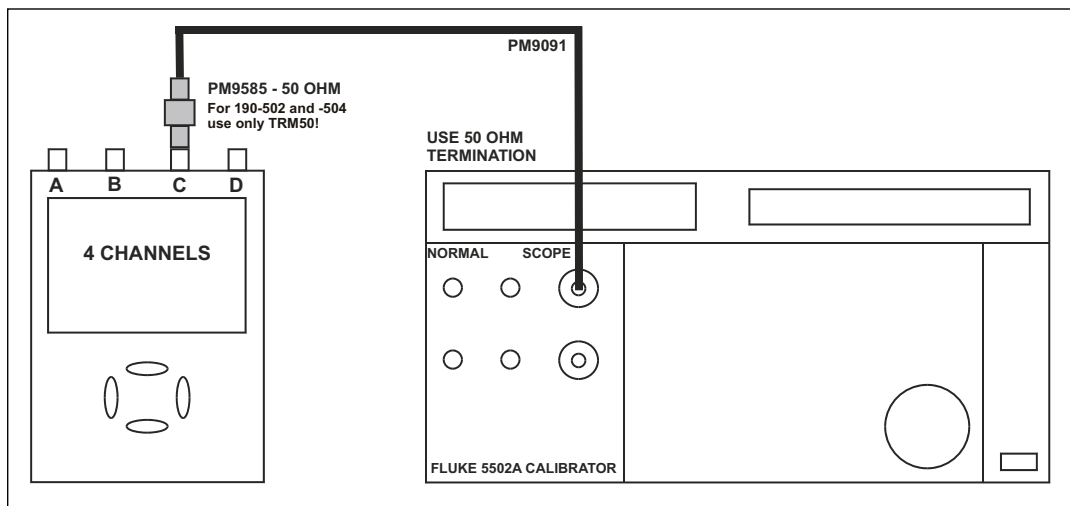

Figure 4-9. 5502A Scope Output to Test Tool Input C

perf-ver-f2.eps

2. Reset the Test Tool to select the Test Tool setup.
3. Press **C** to turn Input C on.
4. Press **C** and use **MOVE** to move the Input C trace zero to the center grid line.
5. Press **TRIGGER** and use **F1** to select Input C as trigger source.
6. Use **mV RANGE** and **RANGE V** to change the sensitivity range to select manual sensitivity ranging and lock the Input C sensitivity range on 2 V/div.
7. Use **s TIME ns** to select the time base in Table 4-13.
8. Set the 5502A to source the leveled sine wave given in the first row of Table 4-13.
9. Adjust the 5502A output voltage until the displayed trace has the amplitude indicated under the appropriate column of Table 4-13.
10. Verify that the signal is well triggered.



If not, press **TRIGGER** and use **F3** to enable the   for manual Trigger Level adjustment. Adjust the trigger level and verify that the signal is triggered. The trigger icon (J) indicates the trigger level.
11. Continue through the test points.
12. When you are finished, set the 5502A to Standby.

Table 4-13. Input C Trigger Sensitivity Test Points

UUT Model	UUT Time base	5500A SC...	MODE levsin	UUT Trigger Amplitude
		Initial Input Voltage	Frequency	
ALL	200 ns/div	100 mV pp	5 MHz	0.5 div
190-104	10 ns/div	400 mV pp	100 MHz	1 div
	10 ns/div	800 mV pp	150 MHz	2 div
190-204	10 ns/div	400 mV pp	200 MHz	1 div
	10 ns/div	800 mV pp	250 MHz	2 div
190-504	2 ns/div	400 mV pp	500 MHz	1 div
	2 ns/div	800 mV pp	600 MHz	2 div

Input C AC Voltage Accuracy (HF) and Bandwidth Test

Note

The test steps for channel C are only for the models 190-104, 190-204, and 190-504.

Proceed as follows to test the Input C high frequency automatic scope ac voltage measurement accuracy and bandwidth:

1. Connect the Test Tool to the 5502A as shown in Figure 4-9.













2. Select the Test Tool setup:
 - a) Recall the setup (see *Standard Test Tool Setup*). Press ,  (RECALL) and select **SETUP**, press , select the setup name, and press  to recall the setup.
 - b) Press , then press  (READING...) and select **READINGS 3 on C | V ac**.
 - c) Press  to select autoranging (**AUTO** in upper right LCD edge).
 - d) Use  and  to change the sensitivity range to select manual sensitivity ranging and lock the Input C sensitivity range on 500 mV/div.
 - e) Use  to move the Input C trace zero to the center grid line.
 - f) Press  and use  to select Input C as trigger source.
3. Set the 5502A to source a sine wave and to the first test point in Table 4-14.
4. Observe the Input C reading and check that it is within the range shown under the appropriate column of Table 4-14.
5. Continue through the test points.
6. When you are finished, set the 5502A to Standby.

Table 4-14. HF AC Voltage Verification Points

UUT Model	5500A SC...	MODE levsine	UUT Reading A
	Voltage	Frequency	
all	2.545 Vpp	1 MHz	835 mV to 965 mV
all	2.545 Vpp	25 MHz	790 mV to 1.010 V
190-104	2.545 Vpp	100 MHz	>630 mV
190-204	2.545 Vpp	200 MHz	>630 mV
190-504	2.545 Vpp	500 MHz	>630 mV

Input D Trigger Sensitivity Test

Note

The test steps for channel D are only for the models 190-104, 190-204, and 190-504.

Proceed as follows to test the Input D trigger sensitivity:

1. Connect the Test Tool to the 5502A as shown in Figure 4-10.

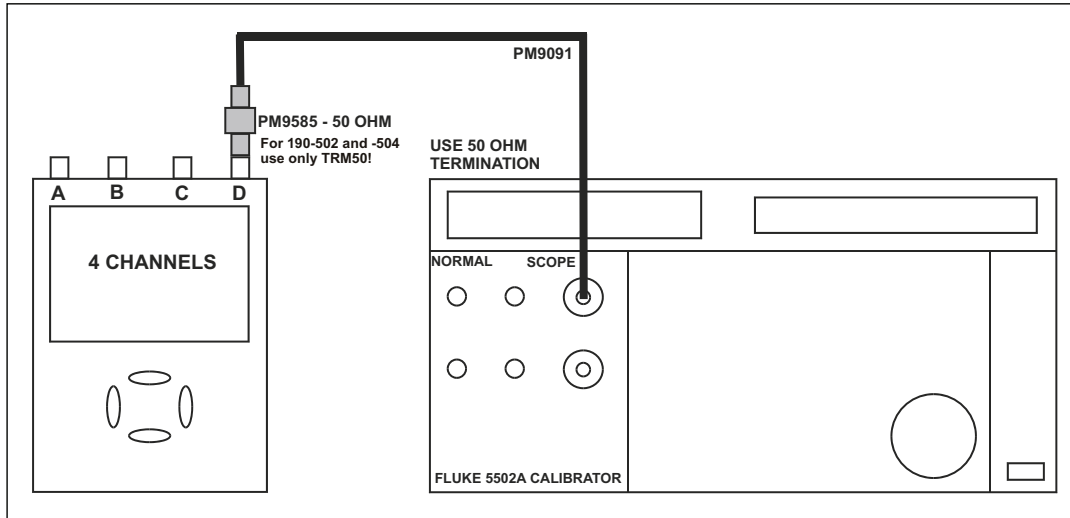

perf-ver-g2.eps

Figure 4-10. 5502A Scope Output to Test Tool Input D

2. Reset the Test Tool to select the Test Tool setup.
3. Press **D** to turn Input D on.
4. Use **MOVE** to move the Input D trace zero to the center grid line.
5. Press **TRIGGER** and use **F1** to select Input D as trigger source.
6. Use **mV RANGE** and **RANGE V** to change the sensitivity range to select manual sensitivity ranging and lock the Input D sensitivity range on 2 V/div.
7. Use **s TIME ns** to select the time base indicated in Table 4-15.
8. Set the 5502A to source the leveled sine wave given in the first row of Table 4-14.
9. Adjust the 5502A output voltage until the displayed trace has the amplitude indicated under the appropriate column of Table 4-15.
10. Verify that the signal is well triggered.
 - If not, press **TRIGGER** and use **F3** to enable the **▲ ▼** for manual Trigger Level adjustment. Adjust the trigger level and verify that the signal is triggered. The trigger icon (J) indicates the trigger level.
11. Continue through the test points.

12. When you are finished, set the 5502A to Standby.

Table 4-15. Input D Trigger Sensitivity Test Points

UUT Model	UUT Time base	5500A SC...MODE levsin		UUT Trigger Amplitude
		Initial Input Voltage	Frequency	
ALL	200 ns/div	100 mV pp	5 MHz	0.5 div
190-104	10 ns/div	400 mV pp	100 MHz	1 div
	10 ns/div	800 mV pp	150 MHz	2 div
190-204	10 ns/div	400 mV pp	200 MHz	1 div
	10 ns/div	800 mV pp	250 MHz	2 div
190-504	2 ns/div	400 mV pp	500 MHz	1 div
	2 ns/div	800 mV pp	600 MHz	2 div

Input D AC Voltage Accuracy (HF) and Bandwidth Test

Note

The test steps for channel C are only for the models 190-104, 190-204, and 190-504.

Proceed as follows to test the Input D high frequency automatic scope ac voltage measurement accuracy and the bandwidth:

1. Connect the Test Tool to the 5502A as shown in Figure 4-10.
2. Recall the setup (see *Standard Test Tool Setup*) to select the Test Tool setup.
3. Press **SAVE**, **F2** (RECALL) and select **SETUP**, press **ENTER**, select the setup name, and press **ENTER** to recall the setup.
4. Press **SCOPE**, then press **F2** (READING...), and select **READINGS 4 on D | V ac**.
5. Press **MANUAL AUTO** to select autoranging (**AUTO** in upper right LCD edge).
6. Use **mV RANGE** and **RANGE V** to change the sensitivity range to select manual sensitivity ranging and lock the Input D sensitivity range on 500 mV/div.
7. Use **MOVE** to move the Input D trace zero to the center grid line.
8. Press **TRIGGER** and use **F1** to select Input D as trigger source.
9. Set the 5502A to source a sine wave and to the first test point in Table 4-16.
10. Observe the Input D reading and check that it is within the range shown under the appropriate column of Table 4-16.
11. Continue through the test points.
12. When you are finished, set the 5502A to Standby.

Table 4-16. HF AC Voltage Verification Points

UUT Model	5500A SC...MODE levsine		UUT Reading A
	Voltage	Frequency	
all	2.545 Vpp	1 MHz	835 mV to 965 mV
all	2.545 Vpp	25 MHz	790 mV to 1.010 V
190-104	2.545 Vpp	100 MHz	>630 mV
190-204	2.545 Vpp	200 MHz	>630 mV
190-504	2.545 Vpp	500 MHz	>630 mV

Video Test with SC600 Scope Calibration Option

Only one of the video systems (NTSC, PAL, PALplus, or SECAM) has to be verified.

To verify:

1. Connect the Test Tool to the calibrator as shown in Figure 4-11.

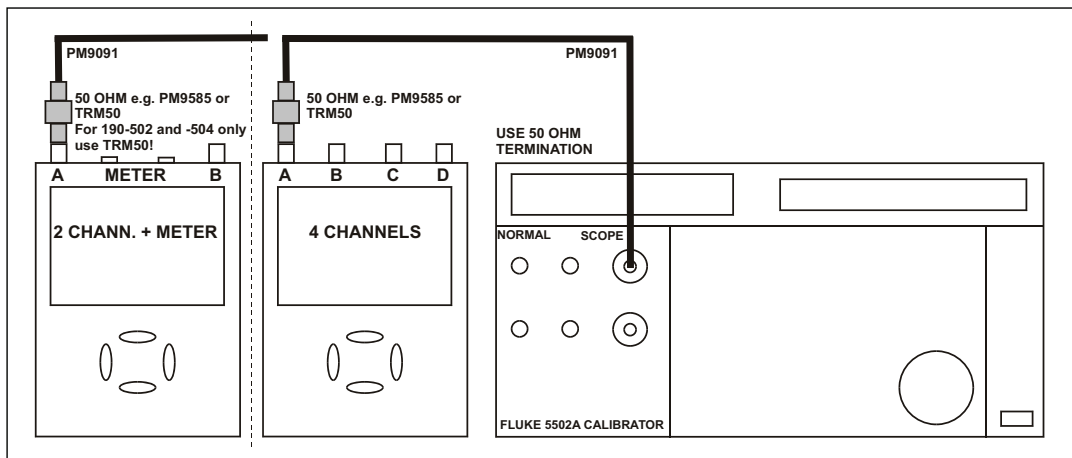









Figure 4-11. Test Tool Input A to TV Signal Generator

perf-ver-d2.eps

2. Reset the Test Tool to select the Test Tool setup.
3. Press **TRIGGER** and then press **F4** to open the Trigger Options menu.
4. Choose **VIDEO on A...** and choose from the shown menu:
Polarity: POSITIVE | PAL (or NTSC or PALplus or SECAM)
5. Press **F2** to select **ALL LINES**.
6. Press **F3** to enable **▲ ▼** to select the video line number.
7. Use **▲ ▼** to select line number:
 - 622 for PAL, PALplus, or SECAM
 - 525 for NTSC
8. Use **MOVE** to move the Input A trace zero to the center grid line.

9. Use  and  to set the Input A sensitivity to 2 V/div (the actual probe setting is 10:1).
10. Use  to select the time base to 20 μ s/div.
11. Set the calibrator to video mode with amplitude +100 %. Set format and marker line number to:
 - PAL 622 (even) for PAL and PALplus
 - SECAM 622 (even) for SECAM
 - NTSC 262 even for NTSC
12. Observe the trace and check if the Test Tool triggers on the negative pulse before the marker pulse (see Figure 4-12).
13. Use   to select Test Tool line number:
 - 310 for PAL, PALplus, or SECAM
 - 262 for NTSC
14. Set the calibrator format and marker line number to:
 - PAL 310 (odd) for PAL and PALplus
 - SECAM 310 (odd) for SECAM
 - NTSC 262 odd for NTSC

15. Observe the trace and check if the Test Tool triggers on the negative pulse before the marker.
16. Select the Test Tool setup and press **F4** to open the Trigger Options menu.
17. Choose **VIDEO on A...** and from the opened menu choose:
Polarity: NEGATIVE | PAL (or NTSC or PALplus or SECAM)
18. Set the calibrator video trigger output signal to -100 %
19. Use   to select line number 310 (PAL, PALplus, or SECAM) or 262 (NTSC).
20. Set the calibrator format and marker line number to:
 - PAL 310 (odd) for PAL and PALplus
 - SECAM 310 (odd) for SECAM
 - NTSC 262 odd for NTSC
21. Observe the trace and check if the Test Tool triggers on the positive pulse before the marker.

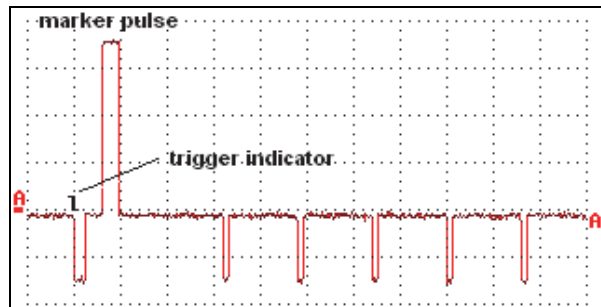

Figure 4-12. SC600 Marker Pulse

video-sc600.bmp

External Trigger Level Test

Note

The external trigger level test is for the models 190-062, 190-102, 190-202, and 190-502.

To test the external trigger level:

1. Connect the Test Tool to the 5502A as shown in Figure 4-13.

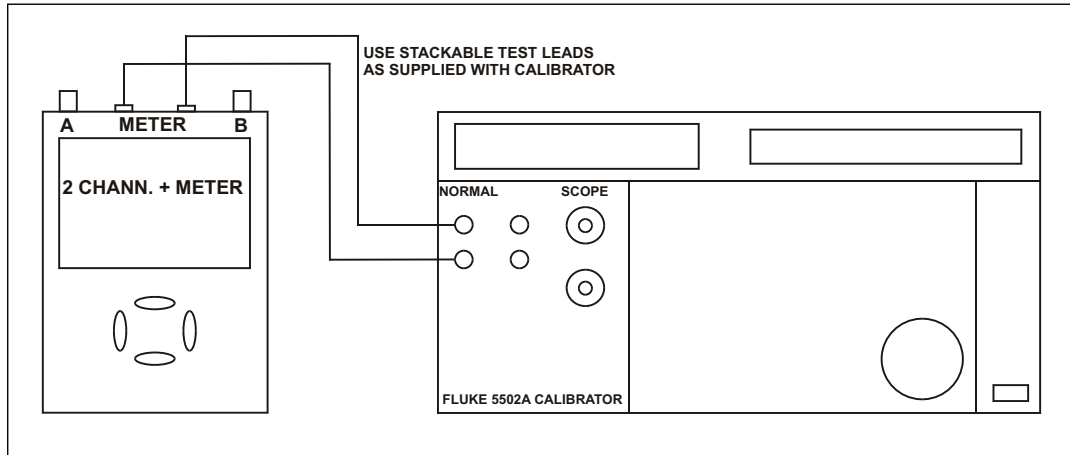

Figure 4-13. Test Tool Meter/Ext Input to 5502A Normal Output

perf-ver-x2.eps

2. Reset the Test Tool to select the Test Tool setup.
3. Press **TRIGGER**.
4. Use **F4** to select the **TRIGGER OPTIONS...** menu.
5. Select **On Edges...** from the **TRIGGER OPTIONS** menu.
6. Press **ENTER**.
7. Select **Update: Single Shot** **ENTER**, **Trigger Filter: Noise Reject** **ENTER**, **NCycle: Off** **ENTER**.
8. Use **F1** (EDGE TRIG) to select **Ext**.
9. Use **F2** (SLOPE) to select positive slope triggering (trigger icon \lceil).
10. Use **F3** (Ext LEVEL) to select **1.2 V**.
11. Set the 5502A to source 0.4 V dc.
12. Verify that no trace is shown on the Test Tool display and that the status line at the display top shows **SINGLE MANUAL** or **SINGLE WAITING**.

If the display shows the trace and status as **SINGLE HOLD**, press **HOLD RUN** to re-arm the Test Tool for a trigger.

13. Set the 5502A to source 1.7 V.
14. To verify that the Test Tool is triggered, check that the trace becomes visible. To repeat the test, start at step 3.
15. Set the 5502A to Standby.

Meter Tests

Note

The following tests are for the models 190-062, 190-102, 190-202, and 190-502.

Meter DC Voltage Accuracy Test

Warning

To prevent possible electrical shock, fire, or personal injury, ensure that the calibrator is in standby mode before making any connection between the calibrator and the Test Tool.

Dangerous voltages are present on the calibration source and connection cables during these steps.

Proceed as follows to test the meter dc voltage measurement accuracy:







1. Connect the Test Tool to the 5502A as shown in Figure 4-13.
2. Select the Test Tool setup.
3. Press .
4. Press  to open the Measurement menu and select **V dc**.
5. Press .
6. Press  to select MANUAL ranging. Use  and  to select the ranges.
7. Set the range to the first test point in Table 4-17.
8. Set the 5502A to source the appropriate dc voltage.
9. Observe the reading and check to see if it is within the range shown under the appropriate column.
10. Continue through the test points.
11. When you are finished, set the 5502A to 0 (zero) Volt and Standby.

Table 4-17. Meter Volts dc Measurement Verification Points

Range	5502A output V dc	Meter Reading
500.0 mV	+ 500 mV	497.0 to 503.0
	- 500 mV	-497.0 to -503.0
	0 mV	-0.5 to +0.5
5.000 V	+ 5.000 V	4.970 to 5.030
	- 5.000 V	-4.970 to -5.030
50.00 V	+ 50.00 V	49.70 to 50.30
	- 50.00 V	-49.70 to -50.30
500.0 V	+ 500.0 V	497.0 to 503.0
	- 500.0 V	-497.0 to -503.0
1100 V	+ 1000 V	0.990 to 1.010
	- 1000 V	-0.990 to -1.010

Meter AC Voltage Accuracy and Frequency Response Test

Warning

To prevent possible electrical shock, fire, or personal injury, ensure that the calibrator is in standby mode before making any connection between the calibrator and the Test Tool. Dangerous voltages are present on the calibration source and connection cables during these steps.

Proceed as follows to test the ac voltage measurement accuracy:







1. Connect the Test Tool to the 5502A as shown in Figure 4-13.
2. Select the Test Tool setup.
3. Press .
4. Press  to open the Measurement menu and select **V ac**.
5. Press .
6. Press  to select MANUAL ranging. Use  and  to select the ranges.
7. Set the range to the first test point in Table 4-18.
8. Set the 5502A to source the appropriate ac voltage.
9. Observe the reading and check that it is within the range shown under the appropriate column.
10. Continue through the test points.
11. When you are finished, set the 5502A to 0 (zero) Volt and Standby.

Table 4-18. Meter Volts AC Measurement Verification Points

Range	5502A output V ac	Frequency	Meter Reading
500.0 mV	500.0 mV	60 Hz	494.0 to 506.0
		1 kHz	486.0 to 514.0
		3 kHz	>350.0
5.000 V	5.000 V	60 Hz	4.940 to 5.060
		1 kHz	4.860 to 5.140
		3 kHz	>3.500
50.00 V	50.00 V	60 Hz	49.40 to 50.60
		1 kHz	48.60 to 51.40
		3 kHz	>35.00
500.0 V	500.0 V	60 Hz	494.0 to 506.0
		1 kHz	486.0 to 514.0
		3 kHz	>350.0
1100 V (1.1 kV)	1000 V	60 Hz	0.980 to 1.020
		1 kHz	0.960 to 1.040
		3 kHz	> 0.700

Continuity Function Test

To test the continuity function:

1. Select the Test Tool setup.
2. Press **METER**.
3. Press **F1** to open the Measurement menu and select **Continuity**.
4. Connect the Test Tool to the 5502A as shown in Figure 4-13.
5. Set the 5502A to 20 Ω . Use the 5502A "COMP OFF" mode.
6. Listen to hear that the beeper is on.
7. Set the 5502A to 80 Ω .
8. Listen to hear that the beeper is off.
9. When you are finished, set the 5502A to Standby.

Diode Test Function Test

To do the diode test function:

1. Select the Test Tool setup.
2. Press **METER**.
3. Press **F1** to open the Measurement menu and select **Diode**.
4. Connect the Test Tool to the 5502A as shown in Figure 4-13.

5. Set the 5502A to **1 k Ω** . Use the 5502A “COMP OFF” mode.
6. Observe the main reading and check that it is within **0.4 V** and **0.6 V**.
7. Set the 5502A to **1 V dc**.
8. Observe the main reading and check that it is within **0.975 V** and **1.025 V**.
9. When you are finished, set the 5502A to Standby.

Ohms Measurements Test

To test the Ohms measurement accuracy:

1. Connect the Test Tool to the 5502A as shown in Figure 4-14.

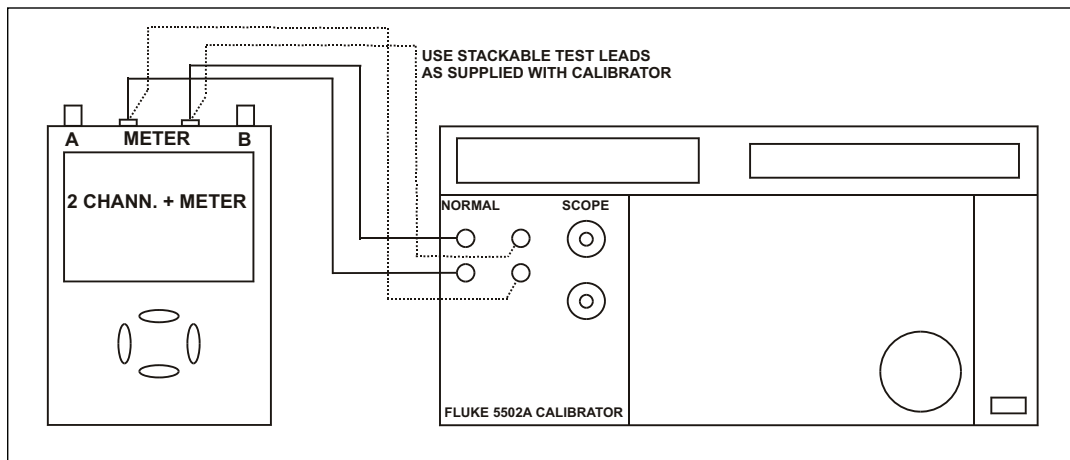

Figure 4-14. Test Meter Tool Input to 5502A Normal Output 4-Wire

perf-ver-z2.eps

2. Select the Test Tool setup.
3. Press **METER**.
4. Press **F1** to open the Measurement menu and select **Ohms**.
5. Press **MANUAL** / **AUTO** to select AUTO ranging.
6. Set the 5502A to source the appropriate resistance value for the first test point in Table 4-19.
7. Use the 5502A “COMP 2 wire” mode for the verifications up to and including 50 k Ω . For the higher values, the 5502A will turn off the “COMP 2 wire” mode.
8. Observe the reading and check that it is within the range shown under the appropriate column.
9. Continue through the test points.
10. When you are finished, set the 5502A to Standby.

Table 4-19. Resistance Measurement Verification Points

5502A output	Meter Reading (COMP 2 wire)
0 Ω	0.0 to 0.5 (COMP 2 wire)
400 Ω	397.1 to 402.9 (COMP 2 wire)
4 k Ω	3.971 to 4.029 (COMP 2 wire)
40 k Ω	39.71 to 40.29 (COMP 2 wire)
400 k Ω	397.1 to 402.9 (off)
4 M Ω	3.971 to 4.029 (off)
30 M Ω	29.77 to 30.23 (off)

Probe Calibration Generator Test

To calibrate, connect a 10:1 probe as supplied with the Test Tool to input A (red probe). Connect the probe tip and the probe ground lead with the probe cal terminals on the lower left side of the Test Tool as shown in Figure 4-15 (the figure is universal and shows a Test Tool with four oscilloscope channels such as the model 190-204).

1. Reset the Test Tool.
2. Press **A** to show the input A key labels.
3. Press **F3** (- PROBE A 10:1).
4. Press **F1** (- PROBE CAL...) and follow the instructions on the display.
5. Press **F4** to start the probe calibration. The first step is to manually adjust the square wave response to a pure square wave (pulse top must be straight). The trimmer is located in the probe housing and can be reached by rotating the center part of the housing. For further information refer to the probe instruction sheet.
6. When done, press **F4** to start the DC calibration automatically. The Probe Calibration is OK if all instructions shown on the display are finished successfully.

Close the hole of the trimmer by rotating the center part of the housing. This is important for safe use of the probe at high input voltages.

7. Repeat the procedure for channel B (blue probe). For the 4-Channel Test Tools (190-104, 190-204, 190-504), repeat the procedure for channel C (gray probe) and channel D (green probe).

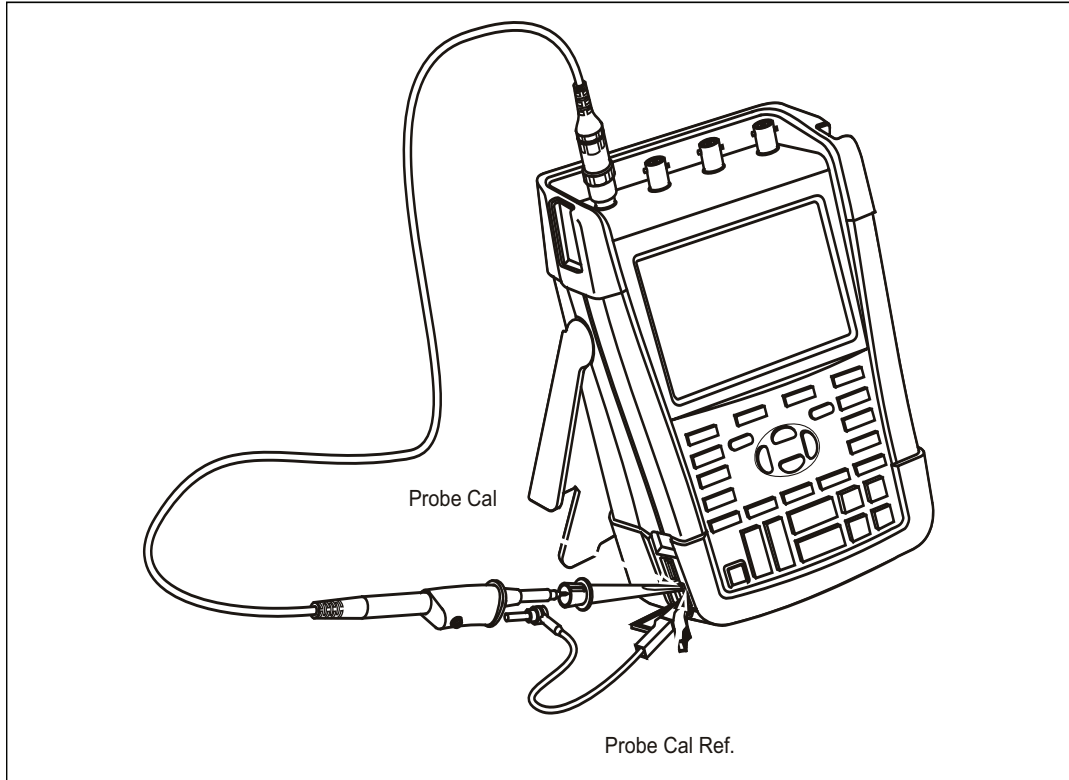

Figure 4-15. Probe Calibration

sl8416_t.eps

This is the end of the Performance Verification Procedure.

Chapter 5

Calibration Adjustment

Title	Page
Introduction	5-3
General	5-4
Calibration Number and Date	5-4
General Instructions	5-4
Equipment Required For Calibration.....	5-5
Calibration Procedure Steps	5-5
How to Start the Calibration	5-6
Contrast Calibration Adjustment	5-7
Warming-Up and Pre-Calibration.....	5-9
Final Calibration For v11.10 and later.....	5-10
Warming-Up 2, Warm-Up Final, and ADC Timing	5-11
Input A LF-HF Gain	5-12
Input B LF-HF Gain	5-14
Input C LF-HF Gain.....	5-16
Input D LF-HF Gain.....	5-18
Input AB Position	5-20
Input AB LF-HF Gain and Position.....	5-20
Input Pos ABCD (AB) Calibration	5-22
Input ABCD (AB) Noise F FBW Calibration	5-22
Input AB Volt Gain	5-22
Multimeter Meter Zero.....	5-24
Multimeter Volt Gain	5-24
Multimeter Ohm Gain.....	5-26

Final Calibration (Firmware: V10.9 and Lower)	5-28
Error Messages	5-28
Warm-Up Final and ADC Timing	5-28
Input A LF-HF Gain	5-29
Input B LF-HF Gain	5-31
Input C LF-HF Gain	5-33
Input D LF-HF Gain	5-35
Input ABCD (AB) LF-HF Gain.....	5-36
Input ABCD (AB) Position.....	5-38
Input ABCD (AB) Volt Gain.....	5-38
Input ABCD (AB) Zero	5-39
Multimeter Volt Gain	5-40
Multimeter Numeric Zero	5-41
Multimeter Ohm Gain	5-41
Save Calibration Data and Exit.....	5-43
Probe Calibration.....	5-44

Introduction

This section provides the complete Calibration Adjustment procedure for the Test Tool.

The Test Tool allows closed-case calibration with known reference sources. It measures the reference signals, calculates the correction factors, and stores the correction factors in RAM. When the calibration is complete, the correction factors can be stored in FlashROM.

The Test Tool should be calibrated after repair or if it fails the Performance Verification. The Test Tool has a normal calibration cycle of one year.

Because the hardware and firmware has changed over the life of the Product, development of a second version of the adjust procedure has been necessary. This section has both adjust procedures.

To identify the procedure version you need:

1. Check that the serial number is 25375604 or higher. If yes, use the first procedure.
2. If no, evaluate the firmware and Subversion. Press in sequence, USER, F3 VERSION & CAL. If the firmware version is V11.00 or lower, use the second procedure.

If the firmware is V11.10 or higher:

3. In the same popup menu, check under Subversions that the last datablock is x5xx (for instance 2516). This value determines the higher frequency adjust point that should be used.

In the tables when red or blue values are listed:

- 5: The *Final Calibration for V11.10 and later* procedure should be done. Use the levels in Red.
- 2: The *Final Calibration for V11.10 and later* procedure should be done. Use the levels in Blue.

General

Calibration Number and Date

When storing valid calibration data in FlashROM after the calibration adjustment procedure is complete, the calibration date is set to the actual Test Tool date, and the calibration number increments by one. To show the calibration date and number:

1. Press **USER**, then press **F3** to see the version and calibration data (Figure 5-1).
2. Press **F4** to close the version and calibration menu.

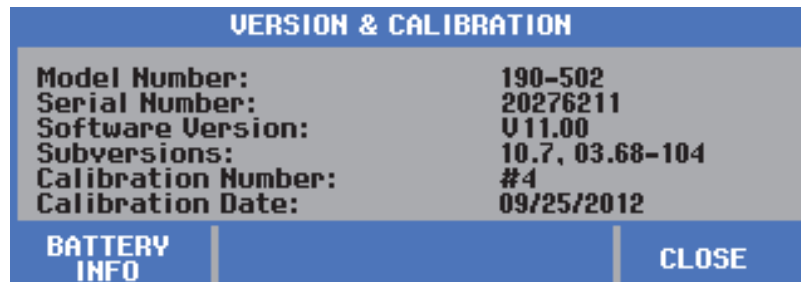

version-calibration-3.bmp

Figure 5-1. Version and Calibration Data (example)

Note

The calibration date and calibration number do not change if you do only the Contrast Calibration Adjustment and/or the Probe Calibration.

General Instructions

Follow these general instructions for all-calibration steps:

- Allow the specified warm-up period for the 5502A. For each calibration point, wait for the 5502A to settle.
- The required warm-up period for the Test Tool is included in the Warming-Up and Pre-Calibration step.
- Ensure that the Test Tool battery is charged sufficiently.
- Power the Test Tool with the BC190 Power Adapter.
- This procedure is for all models. Test steps that are not applicable to the Test Tool to be adjusted can be skipped. For example, the adjustment of the meter with banana jacks can be skipped in instruments with four scope (BNC) inputs.
- The figures that show how to interconnect Signal Source and Test Tool are for 2 Scope Inputs + Meter Input and for 4 Scope Inputs.

Equipment Required For Calibration

The primary source instrument used in the calibration procedures is the Fluke 5502A. If a 5502A is not available, you can substitute another calibrator that meets the minimum test requirements.

- Fluke 5502A Multi-Product Calibrator, including SC600 Oscilloscope Calibration Option.
- Stackable test leads (4x) as supplied with the 5502A (required for Test Tools with banana jacks and 2 BNC oscilloscope inputs).
- 50 Ω Coax Cables (4x): use Fluke PM9091 (1.5 m, 3 pcs.) and PM9092 (0.5 m, 3 pcs.). For Test Tools with banana jacks and 2 BNC oscilloscope inputs 2 Coax Cables are sufficient.
- 50 Ω feed through termination, Fluke TRM50 (4x for Test Tools with 4 BNC oscilloscope inputs; 2x for Test Tools with banana jacks and 2 BNC oscilloscope inputs). The use of model TRM50 is mandatory for Fluke 190-502.
- Male BNC to Dual Female BNC adapter (3x), Fluke PM9093/001.
- Dual Banana Plug to Female BNC Adapter (1x), Fluke PM9081/001.

Calibration Procedure Steps

To do a complete calibration adjustment you must do all steps:

1. Select the Calibration Mode.
2. Do the Contrast Calibration Adjustment.
3. Do the Warming-Up and Pre-Calibration.
4. Do the *Final Calibration for V11.10 and Later* section or *Final Calibration (Firmware: V10.9 and Lower)*. If the installed firmware is **V09.00, V10.00 or V10.4x** you must do the steps in the *Final Calibration (Firmware: V10.9 And Lower)* section.

If the installed firmware is **V11.10** you must do the steps in the *Final Calibration For V11.10 and later* section.

5. Save the Calibration Data and Exit the calibration mode.
6. Do the probe calibration.

The following partial calibrations are allowed:

- Contrast calibration, do the above-mentioned steps 1, 2, and 5. If during normal operation the display cannot be made dark or light enough, or if the display after a Test Tool reset is too light or too dark, you can do this calibration.
- Probe calibration, do the above-mentioned step 6. The probe calibration matches the probe to the used input channel.

How to Start the Calibration

To start the calibration:

1. Power the Test Tool with the power adapter input and the BC190 power adapter.
2. Check the actual Test Tool date and adjust the date if necessary (the calibration date will become the Test Tool date when saving the calibration data):
 - a. Press **USER** (toggles the menu bar on and off).
 - b. Press **F1** to open the **OPTIONS** menu.
 - c. Use **▲▼** to select the **DATE ADJUST...** option.
 - d. Press **ENTER** to open the **DATE ADJUST** menu.
 - e. If necessary, adjust the date with **▲▼**. Press **ENTER** to activate all selections and leave the menu.
3. Select the calibration mode.

The Calibration Adjustment Procedure uses built-in calibration setups that can be accessed in the calibration mode.

To enter the calibration mode proceed as follows:

- Press and hold **USER**, press and release **CLEAR**, and release **USER**.

The display shows the **CAL MODE** (Calibration Adjustment) screen.

The display shows the calibration step **WarmingUp (CL 0200)**, the calibration status **:IDLE (valid)** or **:IDLE (invalid)**, and the softkey menu.

Continue as indicated in the *Calibration Procedure Steps* section.

You can exit the calibration mode without changing the calibration data by turning the Test Tool off.

Explanation of Display Messages and Key Functions

When the Test Tool is in the calibration mode, only the **F1** to **F4** softkeys, the **ⓘ** key, and the **CLEAR** key are active, unless otherwise stated.

The calibration adjustment menu shows the actual calibration step (name and number) and its status: **Cal Name (CL nnnn) :Status (...)**

Cal Name Name of the selected calibration step, for example, **WarmingUp**

(CL nnnn) Number of the calibration step

Status (...) can be:

IDLE (valid) After (re)entering this step, the calibration process is not started. The calibration data of this step are valid. This means that the last time this step was done, the calibration was successful. It does not necessarily mean that the unit meets the specifications related to this step.

IDLE (invalid) After (re)entering this step, the calibration process is not started. The calibration data are invalid. This means that the last time this step was done, the calibration was not successful. Most probably the unit will not meet the specifications if the actual calibration data are saved.

BUSY aaa% bbb% Calibration adjustment step in progress; progress % for Input A and Input B. During Warming-Up, the elapsed time is shown.

READY Calibration adjustment step finished.

Error :xxxx Calibration adjustment failed, due to wrong input signal(s) or because the Test Tool is defective.

If the error code is <5000 you can repeat the failed step.

If the error code is ≥5000 you must repeat the complete final calibration (start at *Warming-Up 2, Warm-Up Final, and ADC Timing*).

The functions of the keys are:

F1	PREVIOUS	select the previous step
F2	NEXT	select the next step
F3	CALIBRATE	start the calibration adjustment of the actual step
F4	EXIT	leave the calibration mode







Contrast Calibration Adjustment

After you enter the calibration mode, the display shows:

WarmingUp (CL 0200):IDLE (valid)

Do not press **F3**. If you do, turn off and turn on the Test Tool and enter the calibration mode again.

To adjust the maximum display darkness (CL 0100), the default contrast (CL 0110), and the maximum display brightness (CL 0120):

1. Press **F1** three times to select maximum darkness calibration **Contrast (CL 0100)**.
 2. Press **F3** (CALIBRATE). The display shows a dark test pattern, see Figure 5-2.
 3. Use   to adjust the display to the maximum darkness where the test pattern is only just visible.
 4. Press **F3** to return to the softkey menu.
 5. Press **F2** to select default contrast calibration **Contrast (CL 0110)**:
 6. Press **F3** (CALIBRATE). The test pattern shows on the display at default contrast.
 7. Use   to set the display to optimal (this setting becomes the default) contrast.
 8. Press **F3** to return to the softkey menu.
 9. Press **F2** to select maximum brightness calibration **Contrast (CL 0120)**:
 10. Press **F3** (CALIBRATE). The display shows a bright test pattern.
 11. Use   to adjust the display to the maximum brightness where the test pattern is only just visible.
 12. Press **F3** to return to the softkey menu.
 13. Now you can either
 - Exit, if only the Contrast had to be adjusted. Continue at the *Save Calibration Data and Exit* section.
- or**
- Do the complete calibration. Press **F2** to select the next step (Warming-Up) and continue.

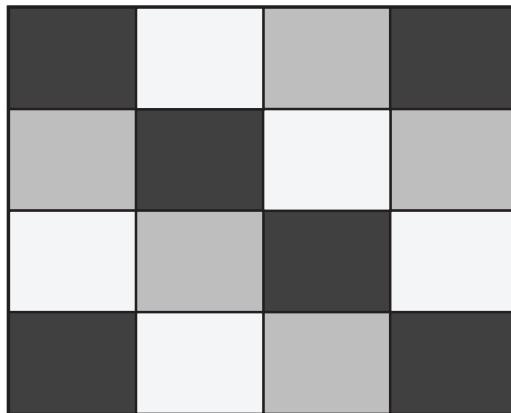

Figure 5-2. Display Test Pattern

hpp204.eps

Warming-Up and Pre-Calibration

The Warming-Up and Pre-Calibration state is entered after the calibration mode, or after selecting the next step if you have done the Contrast Calibration step, CL 120. The display will show **WarmingUp (CL 0200):IDLE (valid)** or **(invalid)**.

Unless you want to calibrate the display contrast only, you must always start the calibration adjustment at the **WarmingUp (CL 0200)** step. Starting at another step will make the calibration invalid.

The Warming-Up and Pre-Calibration consists of a 30 minutes warming-up period, followed by several internal calibration adjustment steps that do not require input signals. The total process takes about 75 minutes.

To do the Warming-Up and Pre-Calibration:

1. Remove all input connections from the Test Tool.

2. Press **F3** to start the Warming-Up and Pre-Calibration.

The display shows the calibration step in progress and its status.

The first step is **WarmingUp (CL 0200) :BUSY 00:29:59** or **WarmingUp1 (CL 0200) :BUSY 00:09:59**. The warming-up period is counted down to 00:00:00. Then the remaining pre-calibration steps are performed automatically. The entire procedure takes about 60 minutes.

3. Wait until the display shows **End Precal: READY**.

The PreCal data have now been stored in FlashROM.

If you turn off the Test Tool now by accident, turn it on again immediately and select the calibration mode. Continue with step 5 below.

4. Press **F2** (NEXT) several times, see *Final Calibration*.

If you turn off the Test Tool now, and you do not turn on immediately, the Test Tool has cooled down, and you must repeat the Warming-Up and Pre-Calibration (select the calibration mode and start at CL 0200).

5. Press **F2** (NEXT) and continue at the *Final Calibration* section.

Error Messages

If error message **1000** is displayed during Warming-Up or Pre-Calibration step CL 0215, the Main PCA hardware version is not suitable for the installed software version. Other error messages during Warming-Up or Pre-Calibration indicate that the Test Tool is defective, and should be repaired.

Final Calibration For v11.10 and later

Before you start the final calibration, do the Warming-Up and Pre-Calibration.

The final calibration requires input conditions that are described in each step. After a step starts, steps that require the same input conditions are done automatically. For example, if you start calibration step CL 0850, the calibration can include step CL 0869 and at the end the display shows **CL 0799: READY**.

Note

You must always start the Final Calibration at the first step. See the Warming-Up 2, Warm-Up Final, and ADC Timing section. Starting at another step will make the calibration invalid.

If you do calibration step N (for example, step CL 0581), then return to a previous step (for example, step CL 0580), and then calibrate this step, the complete final calibration becomes invalid; then you must repeat the calibration starting at the *Warming-Up 2, Warm-Up Final, and ADC Timing* section.

It is allowed to repeat a step that shows the status :READY by pressing  again.

Error messages

Proceed as follows if an error message **ERROR: nnnn** shows on the display during calibration:

- if **nnnn** <5000, check input signal and test leads and press  to repeat the current step.
- if **nnnn** ≥5000, check input signal and test leads and repeat the final calibration in the *Warming-Up 2, Warm-Up Final, and ADC Timing* section.

If the error persists, the Test Tool is defective.

Warming-Up 2, Warm-Up Final, and ADC Timing

The Warming-Up 2 step (**CL 0500**) must be done with open inputs:

1. Press **F3** to start the calibration.
2. Wait until the display shows calibration status **End Precal:READY**.
3. Press **F2** to select the next calibration step (**CL 201, WarmUpFinal**).
4. Press **F3** to start the calibration.
5. Wait until the display shows calibration ready. Press **F2** to select the next calibration step (**CL 0570, ADC Timing**).
6. Connect Ch. A of the Test Tool to the 5502A SCOPE output as shown in Figure 5-3. Use a 50 Ω termination.
7. Set the 5502A to generate a sine wave 50 MHz / 0.5 V pp (mode LEVSINE) at the SCOPE output.
8. Set the 5502A in operate (OPR).
9. Press **F3** to start the calibration.
10. Wait until the display shows calibration status **:READY**.
11. Set the 5502A in standby (STBY).
12. Continue at the *Input A LF-HF Gain* section.

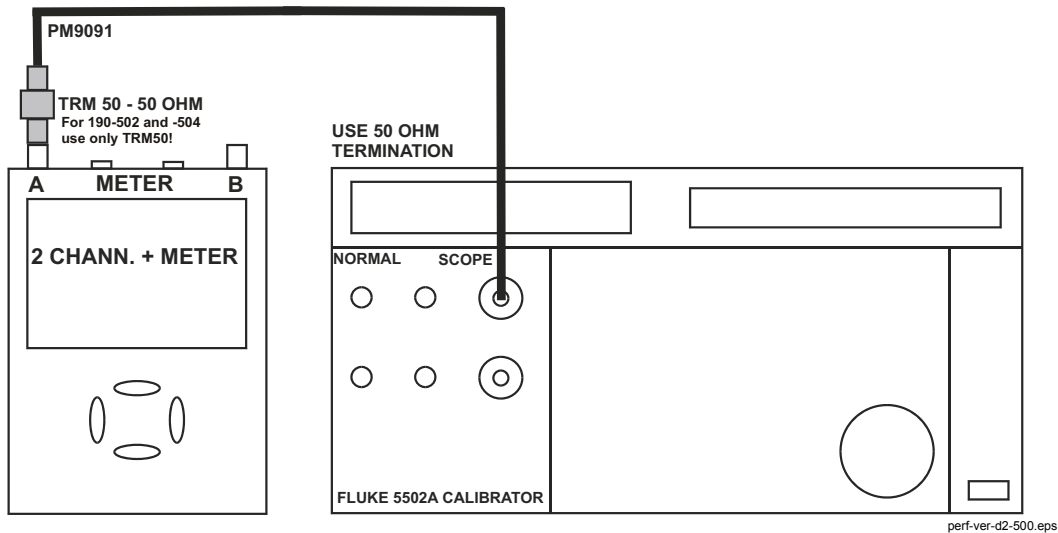

Figure 5-3. 5502A SCOPE Output to Test Tool Input A

Input A LF-HF Gain

To do the Input A LF-HF Gain calibration:

1. Connect Ch. A of the Test Tool to the 5502A as shown in Figure 5-3.
2. The display must show step CL 0654 (Pos A Fast). If it does not, then press **F1** or **F2** to select the first calibration step in Table 5-1.
3. Set the 5502A SCOPE output to source the signal required for the first calibration point in Table 5-1.
4. Set the 5502A in operate (OPR) or standby (STBY) as indicated.
5. Press **F3** to start the calibration.
6. Wait until the display shows calibration status **:READY**.
7. Press **F2** to select the next calibration step, set the 5502A to the next calibration point signal, and start the calibration.
Continue through all calibration points of Table 5-1.
8. When you are finished, set the 5502A to Standby.
9. Continue at the *Input B LF-HF Gain* section.

Table 5-1. Input A LF-HF Gain Calibration Points

Cal step	UUT input signal	5502A Setting
CL 0654	0.5 Vpp square wave, 1 kHz	SCOPE edge, 0.5 Vpp, 1 kHz
CL 0415	100 mVpp square wave, 1 kHz	SCOPE edge, 100 mVpp, 1 kHz
CL 0510	2.5 Vpp square wave, 1 kHz	SCOPE edge, 2.5 Vpp, 1 kHz
CL 0580	2.5 Vpp sine wave, 50 kHz	SCOPE levsine, 2.5 Vpp, 50 kHz
CL 0581	2.5 Vpp sine wave Red subversion 5; Blue Subversion 2 Fluke 190-502/504: 501 MHz Fluke 190-202/204: 381 MHz Fluke 190-102/104: 151 MHz Fluke 190-062: 111 MHz	SCOPE levsine, 2.5 Vpp, 501 MHz 381 MHz 151 MHz 111 MHz
CL 0480	500 mVpp sine wave, 50 kHz	SCOPE levsine, 500 mVpp, 50 kHz
CL 0481	0.5 Vpp sine wave Red subversion 5; Blue Subversion 2 Fluke 190-502/504: 501 MHz Fluke 190-202/204: 381 MHz Fluke 190-102/104: 151 MHz Fluke 190-062: 111 MHz Fluke 190-202/204: 221 MHz Fluke 190-102/104: 141 MHz Fluke 190-062: 91 MHz	SCOPE levsine, 0.5 Vpp, 501 MHz 381 MHz 151 MHz 111 MHz 221 MHz 141 MHz 91 MHz
CL 0460	100 mVpp sine wave, 50 kHz	SCOPE levsine, 100 mVpp, 50 kHz
CL 0461	100 mVpp sine wave Red subversion 5; Blue Subversion 2 Fluke 190-502/504: 501 MHz Fluke 190-202/204: 381 MHz Fluke 190-102/104: 151 MHz Fluke 190-062: 111 MHz Fluke 190-202/204: 221 MHz Fluke 190-102/104: 141 MHz Fluke 190-062: 91 MHz	SCOPE levsine, 100 mVpp, 501 MHz 381 MHz 151 MHz 111 MHz 221 MHz 141 MHz 91 MHz

Input B LF-HF Gain

To do the Input B LF-HF Gain calibration:

1. Press **F2** to select the first calibration step in Table 5-2.
2. Connect Ch. B of the Test Tool to the 5502A as shown in Figure 5-4.
3. Set the 5502A SCOPE output to source the signal required for the first calibration point in Table 5-2 (CL 0674, Pos B Fast).
4. Set the 5502A to operate (OPR) or standby (STBY) as indicated.
5. Press **F3** to start the calibration.
6. Wait until the display shows calibration status :READY.
7. Press **F2** to select the next calibration step, set the 5502A to the next calibration point signal, and start the calibration.

Continue through all calibration points of Table 5-2.

8. When you are finished, set the 5502A to Standby.
9. Continue at the *Input C LF-HF Gain* section.

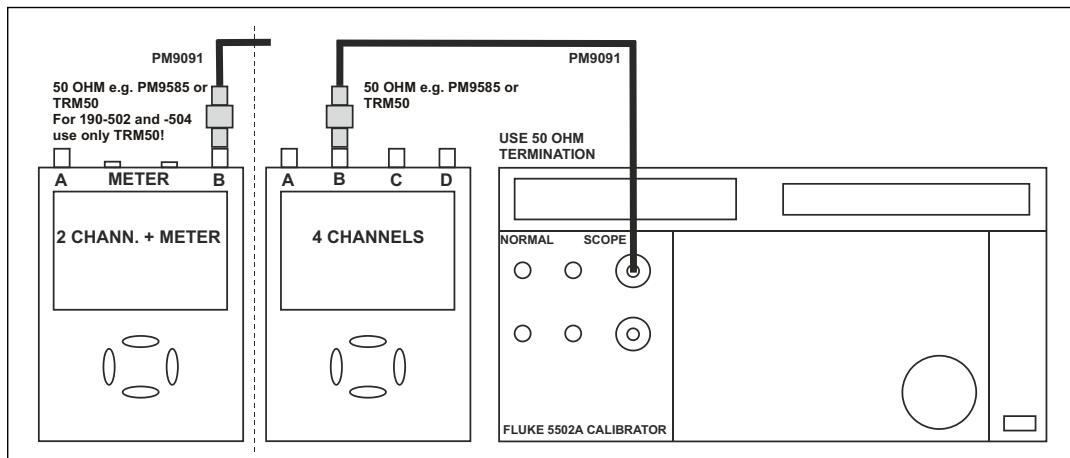

Figure 5-4. 5502A SCOPE Output to Test Tool Input B

Perf-Ver-E2.eps

Table 5-2. Input B LF-HF Gain Calibration Points

Cal step	UUT input signal	5502A Setting
CL 0674	0.5 Vpp square wave, 1 kHz	SCOPE edge, 0.5 Vpp, 1 kHz
CL 0435	100 mVpp square wave, 1 kHz	SCOPE edge, 100 mVpp, 1 kHz
CL 0530	2.5 Vpp square wave, 1 kHz	SCOPE edge, 2.5 Vpp, 1 kHz
CL 0582	2.5 Vpp sine wave, 50 kHz	SCOPE levsine, 2.5 Vpp, 50 kHz
CL 0583	2.5 Vpp sine wave Red subversion 5; Blue Subversion 2 Fluke 190-502/504: 501 MHz Fluke 190-202/204: 381 MHz Fluke 190-102/104: 151 MHz Fluke 190-062: 111 MHz	SCOPE levsine, 2.5 Vpp, 501 MHz 381 MHz 151 MHz 111 MHz
CL 0482	500 mVpp sine wave, 50 kHz	SCOPE levsine, 500 mVpp, 50 kHz
CL 0483	0.5 Vpp sine wave Red subversion 5; Blue Subversion 2 Fluke 190-502/504: 501 MHz Fluke 190-202/204: 381 MHz Fluke 190-102/104: 151 MHz Fluke 190-062: 111 MHz Fluke 190-202/204: 221 MHz Fluke 190-102/104: 141 MHz Fluke 190-062: 91 MHz	SCOPE levsine, 0.5 Vpp, 501 MHz 381 MHz 151 MHz 111 MHz 221 MHz 141 MHz 91 MHz
CL 0462	100 mVpp sine wave, 50 kHz	SCOPE levsine, 100 mVpp, 50 kHz
CL 0463	100 mVpp sine wave Red subversion 5; Blue Subversion 2 Fluke 190-502/504: 501 MHz Fluke 190-202/204: 381 MHz Fluke 190-102/104: 151 MHz Fluke 190-062: 111 MHz Fluke 190-202/204: 221 MHz Fluke 190-102/104: 141 MHz Fluke 190-062: 91 MHz	SCOPE levsine, 100 mVpp, 501 MHz 381 MHz 151 MHz 111 MHz 221 MHz 141 MHz 91 MHz

Input C LF-HF Gain

Sections *Input C LF-HF Gain* and *Input D LF-HF Gain* are for 4-channel ScopeMeters (190-104, 190-204, and 190-504 models). For 2-channel models, proceed to the *Input AB Position* section.

To do the Input C LF-HF Gain calibration on 190-104, 190-204, and 190-504 models:

1. Connect Ch. C of the Test Tool to the 5502A as shown in Figure 5-5.
2. The display must show step CL 0694 (Pos C Fast). If it does not, then press **F1** or **F2** to select the first calibration step in Table 5-3.

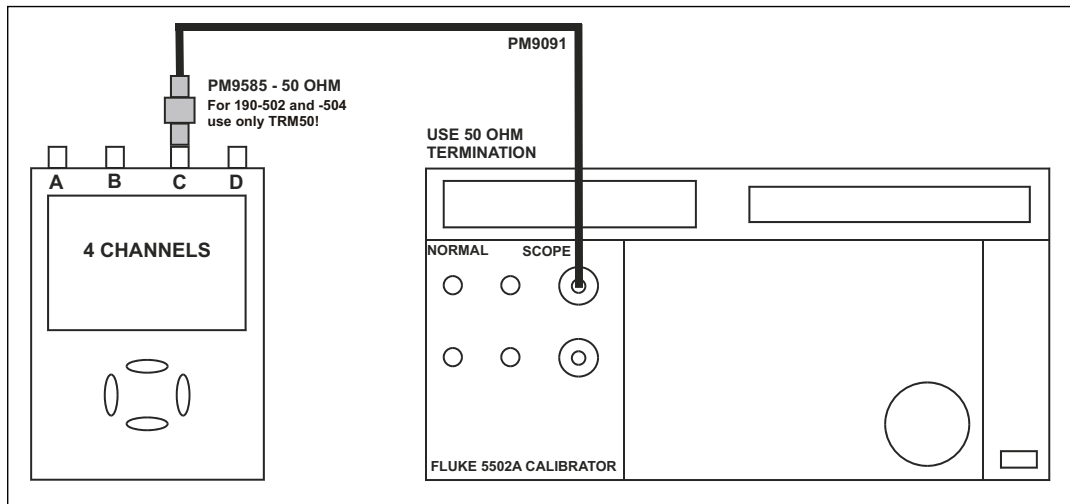

Perf-Ver-F2.eps

Figure 5-5. 5502A SCOPE Output to Test Tool Input C

3. Set the 5502A SCOPE output to source the signal required for the first calibration point in Table 5-3.
4. Set the 5502A to operate (OPR) or standby (STBY) as indicated.
5. Press **F3** to start the calibration.
6. Wait until the display shows calibration status **:READY**.
7. Press **F2** to select the next calibration step, set the 5502A to the next calibration point signal, and start the calibration.
Continue through all calibration points of Table 5-3.
8. When you are finished, set the 5502A to Standby.
9. Continue at the *Input D LF-HF Gain* section.

Table 5-3. Input C LF-HF Gain Calibration Points

Cal step	UUT input signal	5502A Setting
CL 0694	0.5 Vpp square wave, 1 kHz	SCOPE edge, 0.5 Vpp, 1 kHz
CL 0455	100 mVpp square wave, 1 kHz	SCOPE edge, 100 mVpp, 1 kHz
CL 0550	2.5 Vpp square wave, 1 kHz	SCOPE edge, 2.5 Vpp, 1 kHz
CL 0584	2.5 Vpp sine wave, 50 kHz	SCOPE levsine, 2.5 Vpp, 50 kHz
CL 0585	2.5 Vpp sine wave Red subversion 5; Blue Subversion 2 Fluke 190-502/504: 501 MHz Fluke 190-202/204: 381 MHz Fluke 190-102/104: 151 MHz Fluke 190-062: 111 MHz	SCOPE levsine, 2.5 Vpp, 501 MHz 381 MHz 151 MHz 111 MHz
CL 0484	500 mVpp sine wave, 50 kHz	SCOPE levsine, 500 mVpp, 50 kHz
CL 0485	0.5 Vpp sine wave Red subversion 5; Blue Subversion 2 Fluke 190-502/504: 501 MHz Fluke 190-202/204: 381 MHz Fluke 190-102/104: 151 MHz Fluke 190-062: 111 MHz Fluke 190-202/204: 221 MHz Fluke 190-102/104: 141 MHz Fluke 190-062: 91 MHz	SCOPE levsine, 0.5 Vpp, 501 MHz 381 MHz 151 MHz 111 MHz 221 MHz 141 MHz 91 MHz
CL 0464	100 mVpp sine wave, 50 kHz	SCOPE levsine, 100 mVpp, 50 kHz
CL 0465	100 mVpp sine wave Red subversion 5; Blue Subversion 2 Fluke 190-502/504: 501 MHz Fluke 190-202/204: 381 MHz Fluke 190-102/104: 151 MHz Fluke 190-062: 111 MHz Fluke 190-202/204: 221 MHz Fluke 190-102/104: 141 MHz Fluke 190-062: 91 MHz	SCOPE levsine, 100 mVpp, 501 MHz 381 MHz 151 MHz 111 MHz 221 MHz 141 MHz 91 MHz

Input D LF-HF Gain

To do the Input D LF-HF Gain calibration:

1. Press **F2** to select the first calibration step in Table 5-4.
2. Connect Ch. D of the Test Tool to the 5502A as shown in Figure 5-6.
3. Set the 5502A SCOPE output to source the signal required for the first calibration point in Table 5-4 (CL 0675, Pos D Fast).
4. Set the 5502A to operate (OPR) or standby (STBY) as indicated.
5. Press **F3** to start the calibration.
6. Wait until the display shows calibration status :READY.
7. Press **F2** to select the next calibration step, set the 5502A to the next calibration point signal, and start the calibration.

Continue through all calibration points of Table 5-4.

8. When you are finished, set the 5502A to Standby.
9. Continue at the *Input AB Position* section.

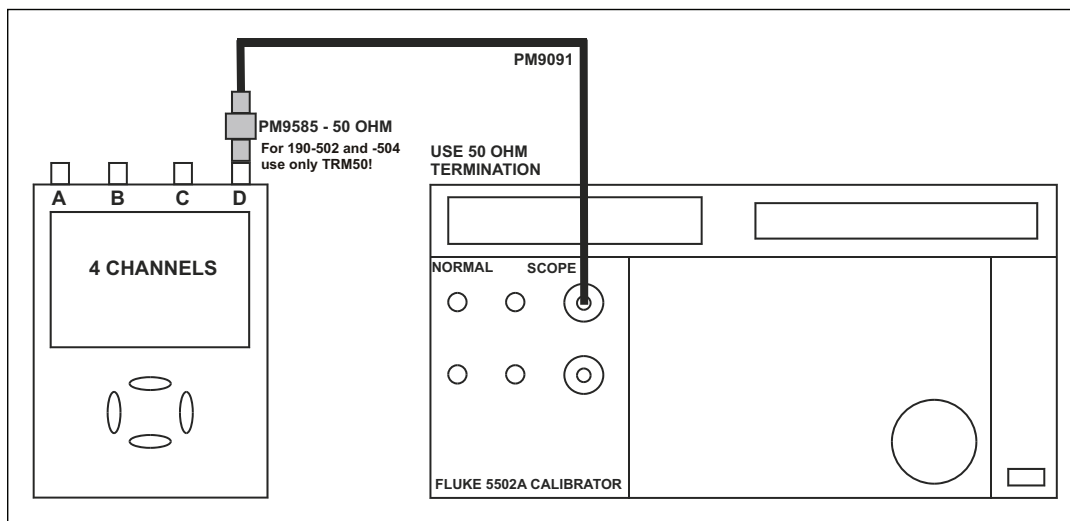

Figure 5-6. 5502A SCOPE Output to Test Tool Input D

Perf-Ver-G2.eps

Table 5-4. Input D LF-HF Gain Calibration Points

Cal step	UUT input signal	5502A Setting
CL 0675	0.5 Vpp square wave, 1 kHz	SCOPE edge, 0.5 Vpp, 1 kHz
CL 0475	100 mVpp square wave, 1 kHz	SCOPE edge, 100 mVpp, 1 kHz
CL 0590	2.5 Vpp square wave, 1 kHz	SCOPE edge, 2.5 Vpp, 1 kHz
CL 0586	2.5 Vpp sine wave, 50 kHz	SCOPE levsine, 2.5 Vpp, 50 kHz
CL 0587	2.5 Vpp sine wave Red subversion 5; Blue Subversion 2 Fluke 190-502/504: 501 MHz Fluke 190-202/204: 381 MHz Fluke 190-102/104: 151 MHz Fluke 190-062: 111 MHz	SCOPE levsine, 2.5 Vpp, 501 MHz 381 MHz 151 MHz 111 MHz
CL 0486	500 mVpp sine wave, 50 kHz	SCOPE levsine, 500 mVpp, 50 kHz
CL 0487	0.5 Vpp sine wave Red subversion 5; Blue Subversion 2 Fluke 190-502/504: 501 MHz Fluke 190-202/204: 381 MHz Fluke 190-102/104: 151 MHz Fluke 190-062: 111 MHz Fluke 190-202/204: 221 MHz Fluke 190-102/104: 141 MHz Fluke 190-062: 91 MHz	SCOPE levsine, 0.5 Vpp, 501 MHz 381 MHz 151 MHz 111 MHz 221 MHz 141 MHz 91 MHz
CL 0466	100 mVpp sine wave, 50 kHz	SCOPE levsine, 100 mVpp, 50 kHz
CL 0467	100 mVpp sine wave Red subversion 5; Blue Subversion 2 Fluke 190-502/504: 501 MHz Fluke 190-202/204: 381 MHz Fluke 190-102/104: 151 MHz Fluke 190-062: 111 MHz Fluke 190-202/204: 221 MHz Fluke 190-102/104: 141 MHz Fluke 190-062: 91 MHz	SCOPE levsine, 100 mVpp, 501 MHz 381 MHz 151 MHz 111 MHz 221 MHz 141 MHz 91 MHz

Input AB Position

To do the Input AB Position calibration:

1. Press **F2** to select calibration adjustment step **CL 0637** (Pos AB).
2. Remove all Input A, B connections (open inputs).
3. Press **F3** to start the calibration.
4. Wait until the display shows calibration status **:READY**.
5. Continue at the *Input AB LF-HF Gain and Position* section.

Input AB LF-HF Gain and Position

To do the Input AB LF-HF Gain calibration:

1. Press **F2** to select the first calibration step in Table 5-5 for the subversion.
2. Connect Ch. A and B of the Test Tool to the 5502A as shown in Figure 5-7.

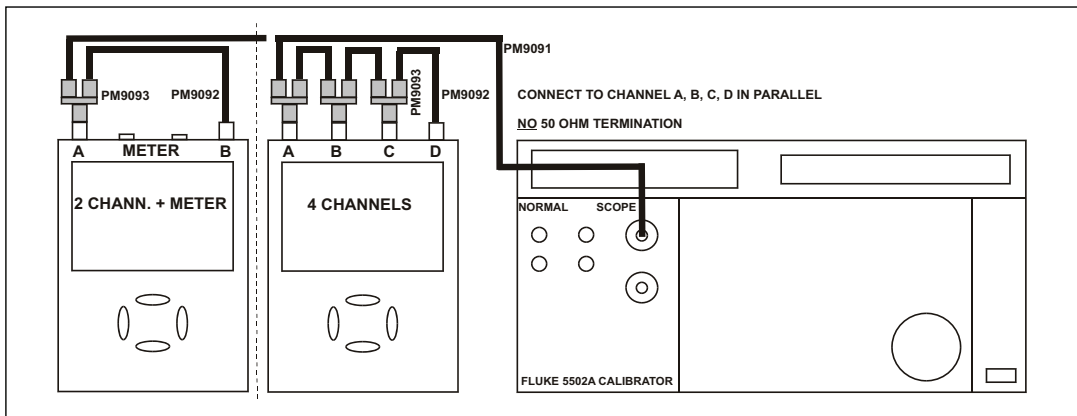

Figure 5-7. Test Tool Input ABCD to 5502A SCOPE Output

3. Set the 5502A to supply a 1 kHz square wave (SCOPE, MODE volt, SCOPE Z 1 M Ω), of 500 mV to channel A and B.

⚠ ⚠ Warning

To prevent possible electrical shock, fire, or personal injury, ensure that the calibrator is in standby mode before making any connection between the calibrator and the Test Tool. Dangerous voltages are present on the calibration source and connection cables during these steps.

4. Set the 5502A to operate (OPR).
5. Press **F3** to start the calibration.
6. Wait until the display shows calibration status **:READY**.

7. Press **F2** to select the next calibration step, set the 5502A to the next calibration point, and start the calibration. Continue through all calibration points of Table 5-5.
8. Set the 5502A to Standby, and continue at the *Input Pos ABCD (AB) Calibration* section.

Table 5-5. Input AB Gain and Position Calibration Points

Cal step	UUT input value (5502A SCOPE, MODE volt, SCOPE Z 1 MΩ, 1 kHz)
CL 0504	500 mV, 1 kHz, MODE VOLT
CL 0624	Open inputs, Calibrator STBY
CL 0673	50 V, 1 kHz, MODE volt
CL 0660	300 mV
CL 0604	500 mV
CL 0637	none (5500 standby)
CL 0504	500 mV
CL 0624	none (5500 standby)
CL 0599	10 mV
CL 0600	25 mV
CL 0601	50 mV
CL 0602	100 mV
CL 0622	none (5500 standby)
CL 0603	250 mV
CL 0662	2 V
CL 0605	1 V
CL 0606	2.5 V
CL 0607	5 V
CL 0664	20 V
CL 0608	10 V
CL 0609	25 V
CL 0610	50 V (set 5502A to OPR!)

Input Pos ABCD (AB) Calibration

To do the Input Pos AB calibration:

1. Press **F2** to select calibration adjustment step CL 0619.
2. Remove all Input A, B connections (Calibrator STBY).
3. Press **F3** to start the calibration.
4. Wait until the display shows calibration status **:READY**.
5. Continue at the *Input ABCD (AB) NoiseF FBW Calibration* section.

Input ABCD (AB) Noise F FBW Calibration

To do the Input AB NoiseF FBW Calibration:

1. Press **F2** to select calibration adjustment step CL 0850.
2. Connect 50 Ω feed through terminations to all BNC Inputs A, B, (C, and D).
3. Press **F3** to start the calibration.
4. Wait until the display shows calibration status **:READY**.
5. Continue at the *Input AB Volt Gain* section.

Input AB Volt Gain

⚠ ⚠ Warning

To prevent possible electrical shock, fire, or personal injury, ensure that the calibrator is in standby mode before making any connection between the calibrator and the Test Tool. Dangerous voltages are present on the calibration source and connection cables during these steps.

To do the Input AB Volt Gain calibration:

1. Press **F2** to select the first calibration step in Table 5-6.
2. Connect Ch. A and B of the Test Tool to the 5502A NORMAL output as shown in Figure 5-8.

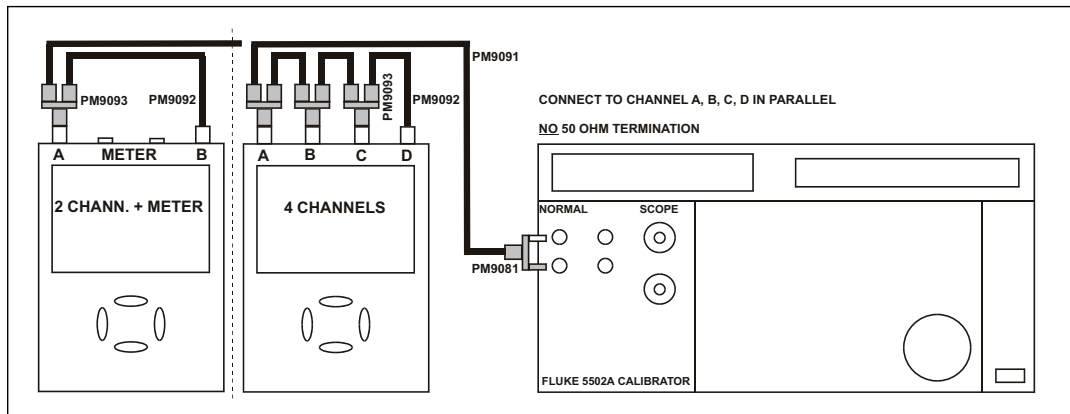

Figure 5-8. Test Tool Input AB to 5502A Normal Output

Perf-Ver-B2.eps

3. Set the 5502A to supply a DC voltage (NORMAL output), to the first calibration point in Table 5-6.

4. Set the 5502A to operate (OPR).
5. Press **F3** to start the calibration.
6. Wait until the display shows calibration status :**READY**.
7. Press **F2** to select the next calibration step, set the 5502A to the next calibration point, and start the calibration. Continue through all calibration points of Table 5-6.
8. Set the 5502A to Standby, and continue at the *Multimeter (DMM) Meter Zero* section.

Table 5-6. Input ABCD Gain Calibration Points

Cal step	UUT input value (5502A NORMAL, dc output)
CL 0799	5 mV
CL 0800	12.5 mV
CL 0801	25 mV
CL 0802	50 mV
CL 0803	125 mV
CL 0804	250 mV
CL 0805	500 mV
CL 0806	1.25 V
CL 0807	2.5 V
CL 0808	5 V
CL 0809	12.5 V
CL 0810	25 V
CL 0811	50 V (set 5502A to OPR!)
CL 0812	125 V
CL 0813	250 V

Multimeter Meter Zero

Note

The adjustment steps for the meter section are only for the models 190-062, 190-102, and 190-202. For 4-Channel ScopeMeters, go to the Save Calibration Data and Exit section.

Proceed as follows to do the Multimeter (DMM) Zero calibration:

1. Press **F2** to select calibration adjustment step CL 0890.
2. Short circuit (interconnect) the banana jack Meter inputs. Use a test lead as **short as possible**.
3. Press **F3** to start the zero calibration.
4. Wait until the display shows the status **:READY**.
5. Remove the input terminations.
6. Continue at the *Multimeter (DMM) Volt Gain* section.

Multimeter Volt Gain

Warning

To prevent possible electrical shock, fire, or personal injury, ensure that the calibrator is in standby mode before making any connection between the calibrator and the Test Tool. Dangerous voltages are present on the calibration source and connection cables during these steps.

Note

The adjustment steps for the meter section are only for the models 190-062, 190-102, 190-202, and 190-502.

To do the DMM Volt Gain calibration:

1. Press **F2** to select the first calibration step in Table 5-7.
2. Connect the Test Tool to the 5502A as shown in Figure 5-9.

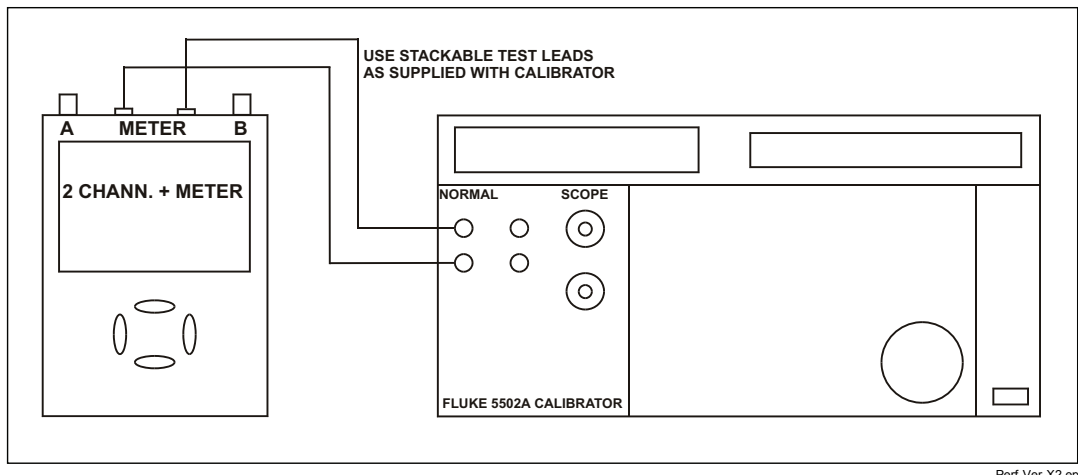

Figure 5-9. 5502A NORMAL Output to Test Tool Banana Input

3. Set the 5502A to supply a DC voltage to the first calibration point in Table 5-7.
4. Set the 5502A to operate (OPR).
5. Press **F3** to start the calibration.
6. Wait until the display shows calibration status :READY.
7. Press **F2** to select the next calibration step, set the 5502A to the next calibration point, and start the calibration. Continue through all calibration points of Table 5-7.
8. Set the 5502A to Standby, and continue at the *Multimeter (DMM) Ohm Gain* section.

Table 5-7. DMM Volt Gain Calibration Points

Cal step	UUT input value (5502A NORMAL, dc output)
CL 0840	500 mV
CL 0849	2.5 V
CL 0841	5 V
CL 0842	50 V (set 5502A to OPR!)
CL 0843	500 V
CL 0844	1000 V

Multimeter Ohm Gain

Note

The adjustment steps for the meter section are only for the models 190-062, 190-102, 190-202, and 190-502.

To do the DMM Ohm Gain calibration:

1. Press **F2** to select the first calibration adjustment step in Table 5-8.
2. Connect the Test Tool to the 5502A as shown in Figure 5-10. Notice that the sense leads must be connected directly to the Test Tool inputs.

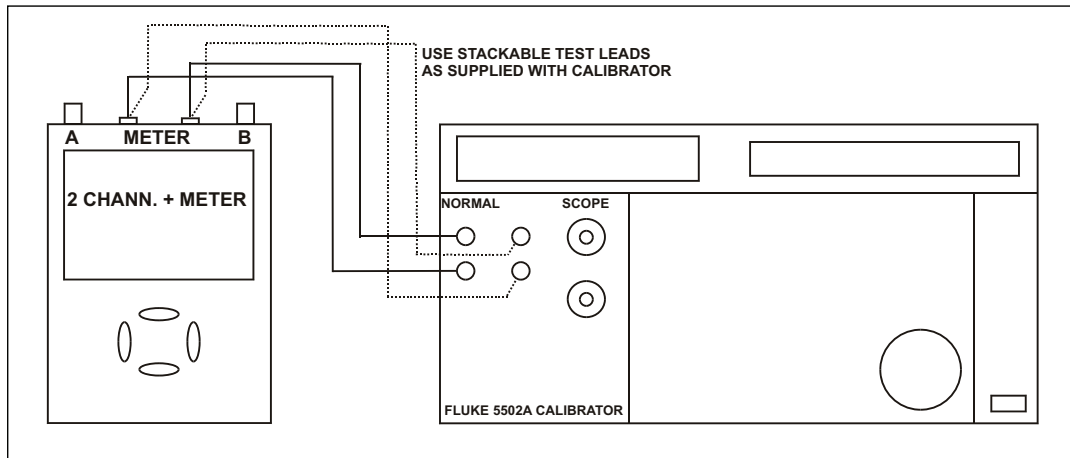

Figure 5-10. Four-wire Ohms Calibration Connections

Perf-Ver-Z2.eps

3. Set the 5502A to the first test point in Table 5-8. Use the 5502A “COMP 2 wire” mode for the calibration adjustments up to and including 100 k Ω . For the higher values, the 5502A will turn off the “COMP 2 wire” mode.
4. Set the 5502A to operate (OPR).

5. Press **F3** to start the calibration.
6. Wait until the display shows the calibration status **:READY**.
7. Press **F2** to select the next calibration step, set the 5502A to the next calibration point, and start the calibration. Continue through all calibration points.
8. When you are finished, set the 5502A to Standby.
9. Continue at the *Save Calibration Data and Exit* section.

Table 5-8. Ohm Gain Calibration Points

Cal Step	UUT input Value (5500 NORMAL)
CL 0910	100 Ω
CL 0911	1 k Ω
CL 0912	10 k Ω
CL 0913	100 k Ω
CL 0914	1 M Ω
CL 0915	10 M Ω

Final Calibration (Firmware: V10.9 and Lower)

The Final Calibration steps depend on the software that is installed in your Test Tool.

To view the software version installed on your Test Tool:

1. Press **USER**.
2. Press **F3** and – **VERSION & CAL**

If the installed firmware is **V09.00**, **V10.00** or **V10.4x**, do the steps in this *Final Calibration (Firmware: V10.9 and Lower)* section. For firmware **V11.10**, do the steps in *Final Calibration For V11.10 and later* section.

Before you start the final calibration, do the steps in the Warming-Up and Pre-Calibration section.

The final calibration requires input conditions that will be described in each step. After starting a step, several steps that require the same input conditions are done automatically. For example, if you start calibration step CL 0852, the calibration can include step CL 0929 and at the end the display shows CL 0929: READY.

Note

You must always start the Final Calibration at the first step. See the Warm Up Final and ADC Timing section. Starting at any other step will make the calibration invalid.

If you proceed to calibration step N (for example step CL 0481), then return to a previous step (for example step CL 0480), and then calibrate this step, the complete final calibration becomes invalid. You must repeat the calibration starting at *Warm-Up Final and ADC Timing*.

It is allowed to repeat a step that shows the status **:READY** by pressing **F3** again.

Error Messages

Proceed as follows if an error message **ERROR: nnnn** is displayed during calibration:

- if **nnnn** <5000, check the input signal and test leads and press **F2** again to repeat the current step.
- if **nnnn** ≥5000, check the input signal and test leads and repeat the final calibration at the *Warm-Up Final and ADC Timing* section.

If the error persists, the Test Tool is defective.

Warm-Up Final and ADC Timing

The Warm-Up Final step (CL 0201) must be done with open inputs:

1. Press **F3** to start the calibration.
2. Wait until the display shows calibration status **:READY**.
3. Press **F2** to select the next calibration step (CL 0570).

4. Connect the Test Tool to the 5502A SCOPE output as shown in Figure 5-11. Use the 50 Ω termination.
5. Set the 5502A to generate a sine wave 50 MHz / 0.5 V pp (mode LEVSINE) at the SCOPE output.
6. Set the 5502A to operate (OPR).
7. Press **F3** to start the calibration.
8. Wait until the display shows calibration status :READY.
9. Set the 5502A to standby (STBY).
10. Continue at the *Input A LF-HF Gain* section.

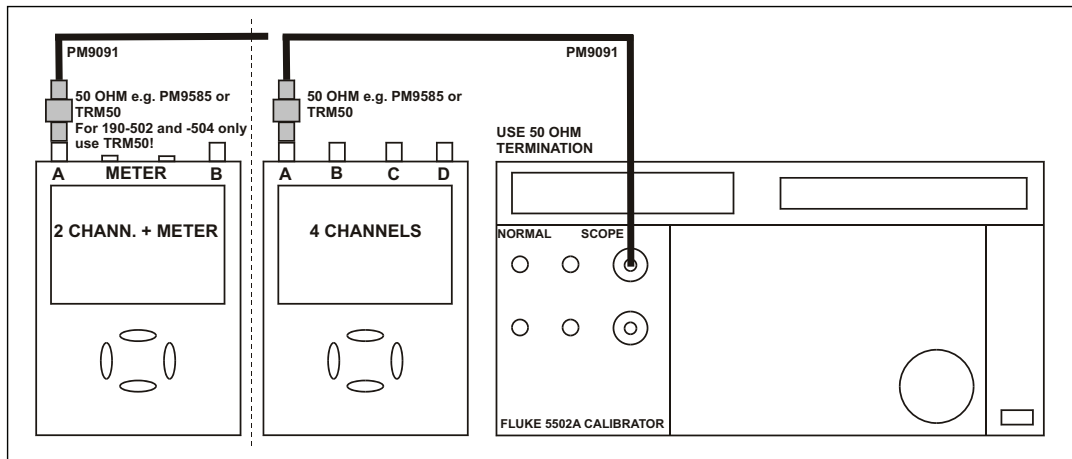

Figure 5-11. 5502A SCOPE Output to Test Tool Input A

Perf-Ver-D2.eps

Input A LF-HF Gain

To do the Input A LF-HF Gain calibration:

1. Connect the Test Tool to the 5502A as shown in Figure 5-11.
2. The display must show step CL 0654. If it does not, press **F2** or **F1** to select the first calibration step in Table 5-9.
3. Set the 5502A SCOPE output to source the signal required for the first calibration point in Table 5-9.
4. Set the 5502A to operate (OPR) or standby (STBY) as indicated.
5. Press **F3** to start the calibration.

6. Wait until the display shows calibration status :READY.
7. Press **F2** to select the next calibration step, set the 5502A to the next calibration point signal, and start the calibration.
Continue through all calibration points of Table 5-9 and Table 5-10.
8. When you are finished, set the 5502A to Standby.
9. Continue at the *Input B LF-HF Gain* section.

Table 5-9. Input A LF-HF Gain Calibration Points

Cal step	UUT input signal	5502A Setting
CL 0654	0.5 Vpp square wave, 1 kHz	SCOPE edge, 0.5 Vpp, 1 kHz
CL 0480	0.62 Vpp sine wave, 50 kHz	SCOPE levsine, 0.62 Vpp, 50 kHz
CL 0481	0.62 Vpp sine wave Fluke 190-202/204: 221 MHz Fluke 190-102: 151 MHz Fluke 190-104: 121 MHz Fluke 190-062: 81 MHz	SCOPE levsine, 0.62 Vpp, 221 MHz 151 MHz 121 MHz 81 MHz

Table 5-10. Input A LF-HF Gain Calibration Points (Extra steps for 190-104/204, V10.4x firmware *)

Cal step	UUT input signal	5502A Setting
CL 0460	124 mVpp sine wave, 50 kHz	SCOPE levsine, 124 mVpp, 50 kHz
CL 0461	124 mVpp sine wave Fluke 190-204: 221 MHz Fluke 190-104: 121 MHz	SCOPE levsine, 124 mVpp, 221 MHz 121 MHz
<p><i>* Four channel instruments (190-104/204) with firmware V10.4x require the extra steps CL 460 and CL 461. Installed firmware version can be checked via key sequence: USER key, F3 – VERSION & CAL, Software Version ...</i></p>		

Input B LF-HF Gain

To do the Input B LF-HF Gain calibration:

1. Press **F2** to select the first calibration step in Table 5-11.
2. Connect the Test Tool to the 5502A as shown in Figure 5-12.

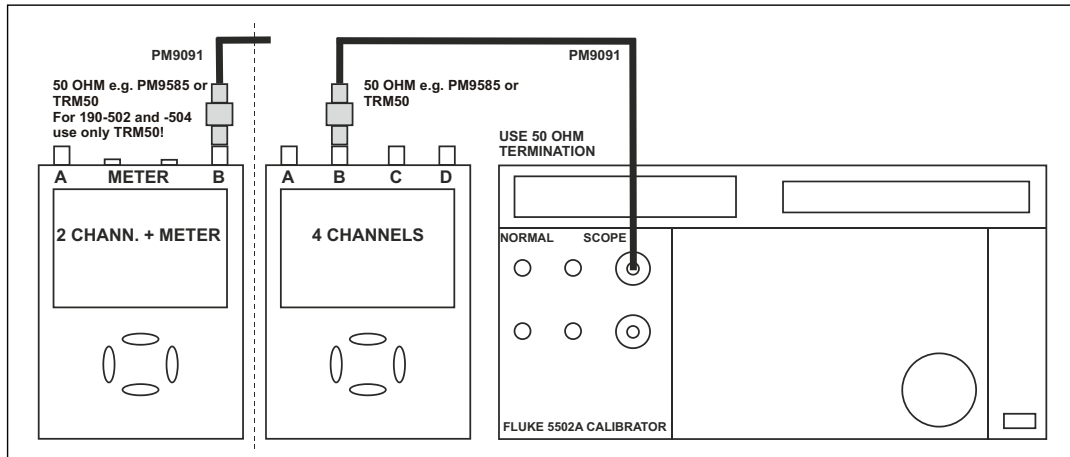

Figure 5-12. 5502A SCOPE Output to Test Tool Input B

Perf-Ver-E2.eps

3. Set the 5502A SCOPE output to source the signal required for the first calibration point in Table 5-11.
4. Set the 5502A to operate (OPR) or standby (STBY) as indicated.
5. Press **F3** to start the calibration.
6. Wait until the display shows calibration status **:READY**.
7. Press **F2** to select the next calibration step, set the 5502A to the next calibration point signal, and start the calibration.

Continue through all calibration points of Table 5-11 and Table 5-12.

8. When you are finished, set the 5502A to Standby.
9. Continue at the *Input C LF-HF Gain* section.

Table 5-11. Input B LF-HF Gain Calibration Points

Cal step	UUT input signal	5502A Setting
CL 0674	0.5 Vpp square wave, 1 kHz	SCOPE edge, 0.5 Vpp, 1 kHz
CL 0482	0.62 Vpp sine wave, 50 kHz	SCOPE levsine, 0.62 Vpp, 50 kHz
CL 0483	0.62 Vpp sine wave Fluke 190-202/204: 221 MHz Fluke 190-102: 151 MHz Fluke 190-104: 121 MHz Fluke 190-062: 81 MHz	SCOPE levsine, 0.62 Vpp, 221 MHz 151 MHz 121 MHz 81 MHz

Table 5-12. Input B LF-HF Gain Calibration Points (Extra steps for 190-104/204, V10.4x firmware *)

Cal step	UUT input signal	5502A Setting
CL 0462	124 mVpp sine wave, 50 kHz	SCOPE levsine, 124 mVpp, 50 kHz
CL 0463	124 mVpp sine wave Fluke 190-204: 221 MHz Fluke 190-104: 121 MHz	SCOPE levsine, 124 mVpp, 221 MHz 121 MHz
<p>* Four channel instruments (190-104/204) with firmware V10.4x require the extra steps CL 462 and CL 463. Installed firmware version can be checked via key sequence: USER key, F3 – VERSION & CAL, Software Version: ...</p>		

Input C LF-HF Gain

Note

The adjustment steps for channel C are only for the models 190-104 and 190-204.

Proceed as follows to do the Input C LF-HF Gain calibration:

1. Press **F2** to select the first calibration step in Table 5-13.
2. Connect the Test Tool to the 5502A as shown in Figure 5-13.

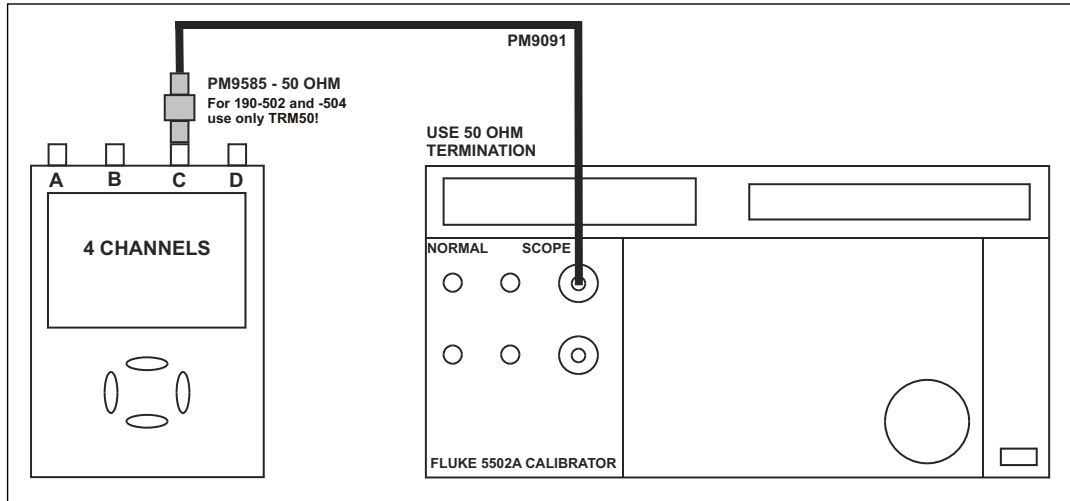

Figure 5-13. 5502A SCOPE Output to Test Tool Input C

Perf-Ver-F2.eps

3. Set the 5502A SCOPE output to source the signal required for the first calibration point in Table 5-13.
4. Set the 5502A in operate (OPR) or standby (STBY) as indicated.
5. Press **F3** to start the calibration.
6. Wait until the display shows calibration status **:READY**.
7. Press **F2** to select the next calibration step, set the 5502A to the next calibration point signal, and start the calibration.
Continue through all calibration points of Table 5-13 and Table 5-14.
8. When you are finished, set the 5502A to Standby.
9. Continue at the *Input D LF-HF Gain* section.

Table 5-13. Input C LF-HF Gain Calibration Points

Cal step	UUT input signal	5502A Setting
CL 0656	0.5 Vpp square wave, 1 kHz	SCOPE edge, 0.5 Vpp, 1 kHz
CL 0484	0.62 Vpp sine wave, 50 kHz	SCOPE levsine, 0.62 Vpp, 50 kHz
CL 0485	0.62 Vpp sine wave Fluke 190-204: 221 MHz Fluke 190-104: 121 MHz	SCOPE levsine, 0.62 Vpp, 221 MHz 121 MHz

Table 5-14. Input C LF-HF Gain Calibration Points (Extra steps for 190-104/204, V10.4x firmware *)

Cal step	UUT input signal	5502A Setting
CL 0464	124 mVpp sine wave, 50 kHz	SCOPE levsine, 124 mVpp, 50 kHz
CL 0465	124 mVpp sine wave Fluke 190-204: 221 MHz Fluke 190-104: 121 MHz	SCOPE levsine, 124 mVpp, 221 MHz 121 MHz
<p>* Four channel instruments (190-104/204) with firmware V10.4x require the extra steps CL 464 and CL 465. Installed firmware version can be checked via key sequence: USER key, F3 – VERSION & CAL, Software Version: ...</p>		

Input D LF-HF Gain

Note

The adjustment steps for channel D are only for the models 190-104 and 190-204.

To do the Input D LF-HF Gain calibration:

1. Press **F2** to select the first calibration step in Table 5-15.
2. Connect the Test Tool to the 5502A as shown in Figure 5-14.

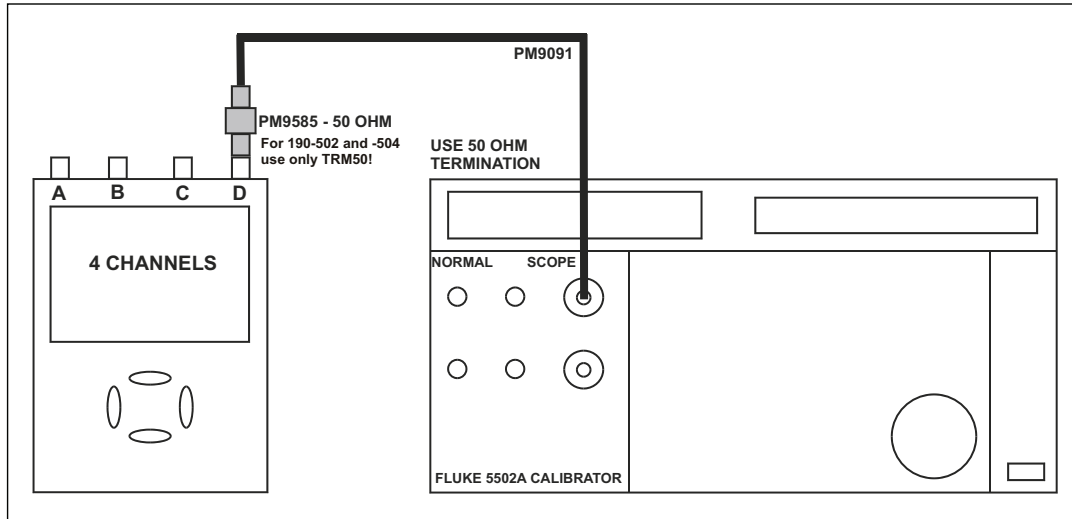

Figure 5-14. 5502A SCOPE Output to Test Tool Input D

Perf-Ver-G2.eps

3. Set the 5502A SCOPE output to source the signal required for the first calibration point in Table 5-15.
4. Set the 5502A in operate (OPR) or standby (STBY) as indicated.
5. Press **F3** to start the calibration.
6. Wait until the display shows calibration status **:READY**.
7. Press **F2** to select the next calibration step, set the 5502A to the next calibration point signal, and start the calibration.
Continue through all calibration points of Table 5-15 and Table 5-16.
8. When you are finished, set the 5502A to Standby.
9. Continue at the *Input ABCD (AB) LF-HF Gain* section.

Table 5-15. Input D LF-HF Gain Calibration Points

Cal step	UUT input signal	5502A Setting
CL 0675	0.5 Vpp square wave, 1 kHz	SCOPE edge, 0.5 Vpp, 1 kHz
CL 0486	0.62 Vpp sine wave, 50 kHz	SCOPE levsine, 0.62 Vpp, 50 kHz
CL 0487	0.62 Vpp sine wave Fluke 190-204: 221 MHz Fluke 190-104: 121 MHz	SCOPE levsine, 0.62 Vpp, 221 MHz 121 MHz

Table 5-16. Input D LF-HF Gain Calibration Points (Extra steps for 190-104/204, V10.4x firmware *)

Cal step	UUT input signal	5502A Setting
CL 0466	124 mVpp sine wave, 50 kHz	SCOPE levsine, 124 mVpp, 50 kHz
CL 0467	124 mVpp sine wave Fluke 190-204: 221 MHz Fluke 190-104: 121 MHz	SCOPE levsine, 124 mVpp, 221 MHz 121 MHz

* Four channel instruments (190-104/204) with firmware V10.4x require the extra steps CL 466 and CL 467. Installed firmware version can be checked via key sequence: USER key, F3 – VERSION & CAL, Software Version: ...

Input ABCD (AB) LF-HF Gain

Note

The adjustment steps for channel C and D are only for the models 190-104 and 190-204.

To do the Input ABCD LF-HF Gain calibration:

1. Press **F2** to select the first calibration step in Table 5-17.
2. Connect the Test Tool to the 5502A as shown in Figure 5-15.

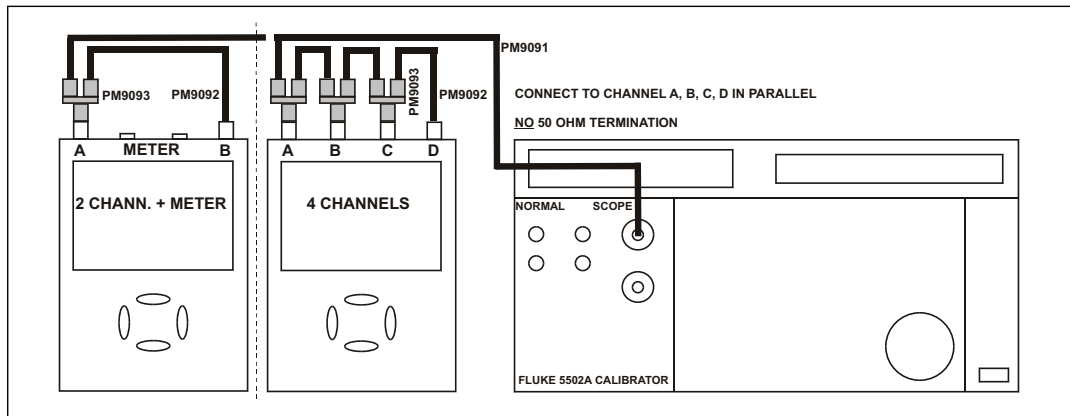

Figure 5-15. Test Tool Input ABCD to 5502A SCOPE Output

3. Set the 5502A to supply a 1 kHz square wave (SCOPE, MODE volt, SCOPE Z 1 MΩ) to the first calibration point in Table 5-17.

⚠ ⚠ Warning

To prevent possible electrical shock, fire, or personal injury, ensure that the calibrator is in standby mode before making any connection between the calibrator and the Test Tool. Dangerous voltages are present on the calibration source and connection cables during these steps.

4. Set the 5502A to operate (OPR).
5. Press **F3** to start the calibration.
6. Wait until the display shows calibration status :**READY**.
7. Press **F2** to select the next calibration step, set the 5502A to the next calibration point, and start the calibration. Continue through all calibration points of Table 5-17.
8. Set the 5502A to Standby, and continue at the *Input ABCD (AB) Position* section.

Table 5-17. Input ABCD Gain Calibration Points

Cal step	UUT input value (5502A SCOPE, MODE volt, SCOPE Z 1 MΩ, 1 kHz)
CL 0660	300 mV
CL 0604	500 mV
CL 0637	none (5500 standby)
CL 0504	500 mV
CL 0624	none (5500 standby)
CL 0599	10 mV
CL 0600	25 mV
CL 0601	50 mV
CL 0602	100 mV
CL 0622	none (5500 standby)
CL 0662	2 V
CL 0605	1 V
CL 0606	2.5 V
CL 0607	5 V
CL 0664	20 V
CL 0608	10 V
CL 0609	25 V
CL 0610	50 V (set 5502A to OPR)

Input ABCD (AB) Position

To do the Input ABCD (AB) Position calibration:

1. Press **F2** to select calibration adjustment step **CL 0619**.
2. Remove all Input A, B, C, D (A, B) connections (open inputs).
3. Press **F3** to start the calibration.
4. Wait until the display shows calibration status **:READY**.
5. Continue at the *Input ABCD (AB) Volt Gain* section.

Input ABCD (AB) Volt Gain

⚠⚠ Warning

To prevent possible electrical shock, fire, or personal injury, ensure that the calibrator is in standby mode before making any connection between the calibrator and the Test Tool. Dangerous voltages are present on the calibration source and connection cables during these steps.

Note

The adjustment steps for channel C and D are only for the models 190-104 and 190-204.

To do the Input ABCD (AB) Volt Gain calibration:

1. Press **F2** to select the first calibration step in Table 5-18.
2. Connect the Test Tool to the 5502A as shown in Figure 5-16.

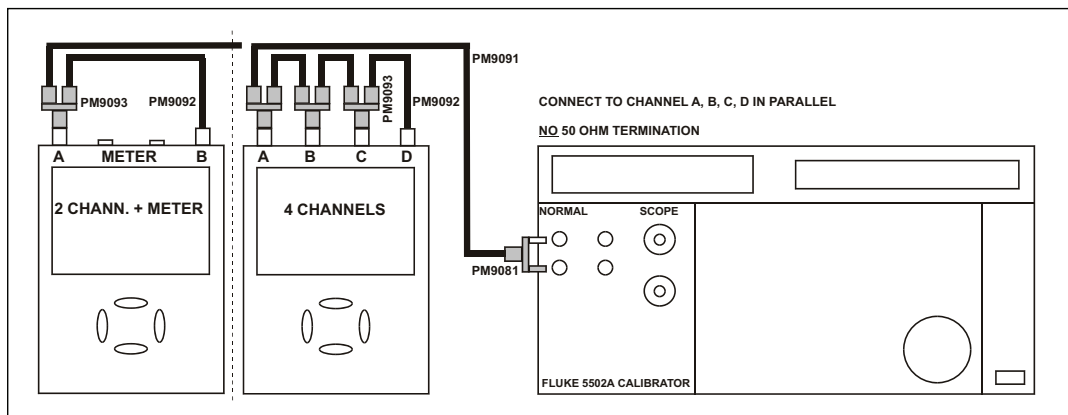

Figure 5-16. Test Tool Input ABCD to 5502A Normal Output

3. Set the 5502A to supply a DC voltage (NORMAL output) to the first calibration point in Table 5-18.
4. Set the 5502A to operate (OPR).
5. Press **F3** to start the calibration.
6. Wait until the display shows calibration status **:READY**.

7. Press **F2** to select the next calibration step, set the 5502A to the next calibration point, and start the calibration. Continue through all calibration points of Table 5-18.
8. Set the 5502A to Standby and continue at the *Input ABCD (AB) Zero* section.

Table 5-18. Input ABCD Gain Calibration Points

Cal step	UUT input value (5502A NORMAL)
CL 0799	5 mV
CL 0800	12.5 mV
CL 0801	25 mV
CL 0802	50 mV
CL 0803	125 mV
CL 0804	250 mV
CL 0805	500 mV
CL 0806	1.25 V
CL 0807	2.5 V
CL 0808	5 V
CL 0809	12.5 V
CL 0810	25 V
CL 0811	50 V (set 5502A to OPR!)
CL 0812	125 V
CL 0813	250 V

Input ABCD (AB) Zero

To do the Input ABCD (AB) Zero calibration:

1. Press **F2** to select calibration adjustment step CL 0852.
2. Short circuit Input A, B, C, D (A, B) with 50 Ω feed through terminations.
3. Press **F3** to start the zero calibration.
4. Wait until the display shows the status **:READY**.
5. Remove the input terminations.
6. For Fluke 190-062, 190-102, and 190-202: continue at the *Multimeter (DMM) Volt Gain* section. For Fluke 190-104 and 190-204: continue at the *Save Calibration Data and Exit* section.

Multimeter Volt Gain

⚠⚠ Warning

To prevent possible electrical shock, fire, or personal injury, ensure that the calibrator is in standby mode before making any connection between the calibrator and the Test Tool. Dangerous voltages are present on the calibration source and connection cables during these steps.

Note

The adjustment steps for the meter section are only for the models 190-062, 190-102, and 190-202.

To do the DMM Volt Gain calibration:

1. Press **F2** to select the first calibration step in Table 5-19.
2. Connect the Test Tool to the 5502A as shown in Figure 5-17.

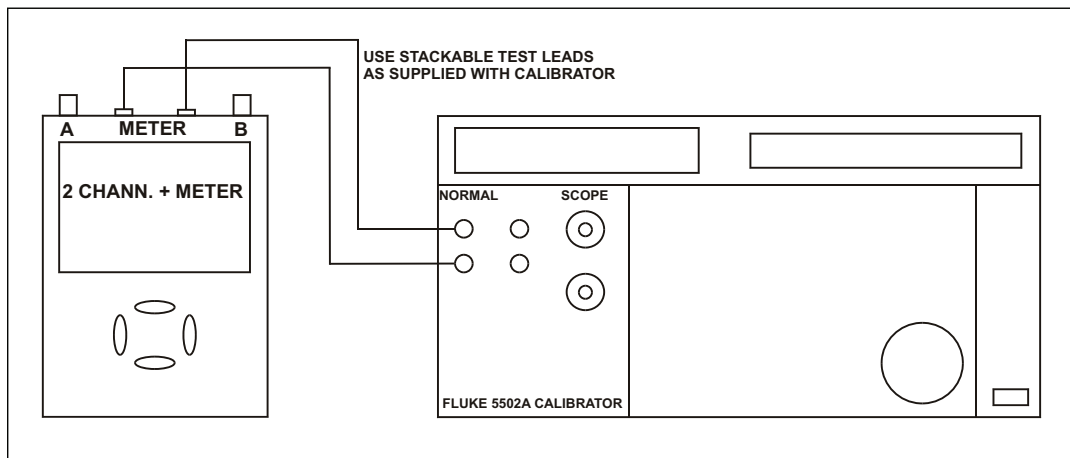

Perf-Ver-X2.eps

Figure 5-17. 5502A NORMAL Output to Test Tool Banana Input

3. Set the 5502A to supply a DC voltage, to the first calibration point in Table 5-19.
4. Set the 5502A to operate (OPR).
5. Press **F3** to start the calibration.
6. Wait until the display shows calibration status **:READY**.
7. Press **F2** to select the next calibration step, set the 5502A to the next calibration point, and start the calibration. Continue through all calibration points in Table 5-19.
8. Set the 5502A to Standby and continue at the *Multimeter (DMM) Numeric Zero* section.

Table 5-19. DMM Gain Calibration Points

Cal step	UUT input value (5502A NORMAL)
CL 0840	500 mV
CL 0849	2.5 V
CL 0841	5 V
CL 0842	50 V (set 5502A to OPR!)
CL 0843	500 V
CL 0844	1000 V

Multimeter Numeric Zero

Note

The adjustment steps for the meter section are only for the models 190-062, 190-102, and 190-202.

To do the Multimeter (DMM) Zero calibration:

1. Press **F2** to select calibration adjustment step CL 0890.
2. Short circuit the banana jack Meter inputs properly (calibration includes Ohms zero). Use a test lead as short as possible.
3. Press **F3** to start the zero calibration.
4. Wait until the display shows the status **:READY**.
5. Remove the input terminations.
6. Continue at the *Multimeter (DMM) Ohm Gain* section.

Multimeter Ohm Gain

Note

The adjustment steps for the meter section are only for the models 190-062, 190-102, and 190-202.

To do the DMM Ohm Gain calibration:

1. Press **F2** to select the first calibration adjustment step in Table 5-20.
2. Connect the Test Tool to the 5502A as shown in Figure 5-18. Notice that the sense leads must be connected directly to the Test Tool.

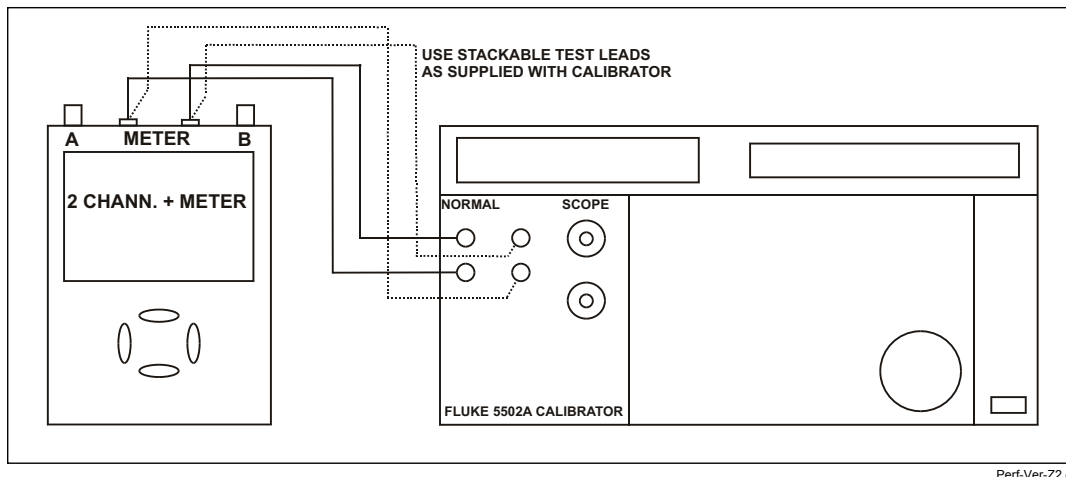

Figure 5-18. Four-wire Ohms Calibration Connections

Perf-Ver-Z2.eps

3. Set the 5502A to the first test point in Table 5-20. Use the 5502A “COMP 2 wire” mode for the calibration adjustments up to and including 100 k Ω . For the higher values, the 5502A will turn off the “COMP 2 wire” mode.
4. Set the 5502A to operate (OPR).
5. Press **F3** to start the calibration.
6. Wait until the display shows the calibration status :READY.
7. Press **F2** to select the next calibration step, set the 5502A to the next calibration point, and start the calibration. Continue through all calibration points.
8. When you are finished, set the 5502A to Standby.
9. Continue at the *Save Calibration Data and Exit* section.

Table 5-20. Ohm Gain Calibration Points

Cal Step	UUT input Value (5500 NORMAL)
CL 0910	100 Ω
CL 0911	1 k Ω
CL 0912	10 k Ω
CL 0913	100 k Ω
CL 0914	1 M Ω
CL 0915	10 M Ω

Save Calibration Data and Exit

To save the calibration data and exit the Maintenance mode:

1. Remove all test leads from the Test Tool inputs.
2. Press **F4** (EXIT). The Test Tool shows on the display:

Calibration data valid.

Save data and exit maintenance mode?

Note

Calibration data valid indicates that the calibration adjustment procedure is performed correctly. It does not necessarily mean that the Test Tool meets the specifications listed in Chapter 2.

3. Press **F4** (YES) to save and exit.

Note

After saving the calibration data, the calibration number and date updates if the calibration data changes and the data are valid.

The calibration number and date do not change if:

- *the calibration mode is entered and left without doing a calibration adjustment.*
- *only the contrast calibration adjustment and/or the probe calibration are done.*

*If you press **F3** (NO), the Test Tool returns to the calibration mode.*

*You can either calibrate the Test Tool again, or press **F4** (EXIT), **F4** (YES) to save and exit.*

Error messages:

WARNING: Calibration data not valid.
Save data and exit maintenance mode?

If you did the Warming-Up and Pre-Calibration successfully and you want to store the Pre-Calibration data before continuing with the Final Calibration:

1. Press **F4** (YES).

When you turn off and turn on the Test Tool again, it will show the message:

The instrument needs calibration.
Please contact your service center.

The calibration date and number do not update. You must continue with the Final Calibration.

To return to the Maintenance mode and repeat the complete calibration:

1. Press **F3** (NO).
2. Press **F1** until the display shows **WarmingUp (CL 0200):IDLE**, and calibrate the Test Tool, starting at *Warming-Up and Pre-Calibration*.

If you want to exit and maintain the old calibration data:

1. Turn the Test Tool off.

Probe Calibration

To meet full user specifications, you need to adjust the supplied red (R), blue (B), gray (G) and green (V) VPS410-II 10:1 voltage probes for optimal response.

To adjust the VPS410-II probes:

1. Connect the red probe from the red Input A BNC to the banana jack. See Figure 5-19.

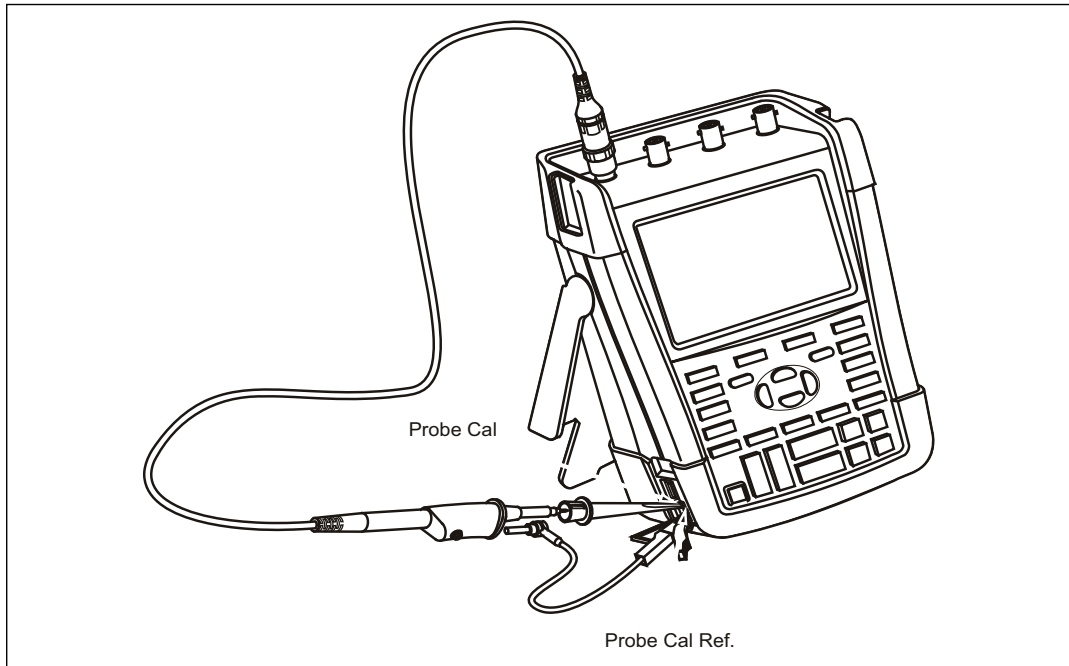

Figure 5-19. 10:1 Probe Calibration Connection

st8416_t.eps

2. Press **A** and then **F3** to open the **Probe on A** menu.
3. Select Probe Type: **Voltage** | Attenuation: **10:1**.
4. Press **ENTER**.
5. Press **F3** - **PROBE A**.
6. Press **F1** - **PROBE CAL** and follow the instructions shown on the display.

7. Press **F4** to start the probe calibration.

The first step is to manually adjust the square wave response to a pure square wave (pulse top must be straight, see Figure 5-20). The trimmer is located in the probe housing and is reached by rotating the center part of the housing. For more information, see the instruction sheet for the probe.

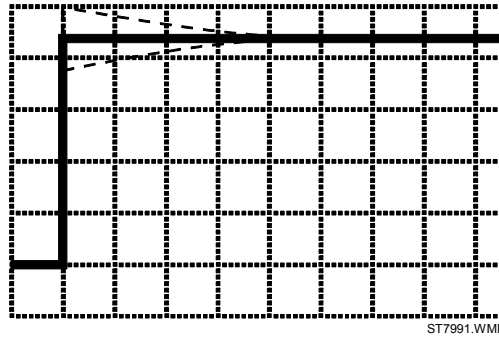

Figure 5-20. 10:1 Probe Calibration

8. When done, press **F4** to start the DC calibration automatically.
 The Probe Calibration is OK if all instructions shown on the display are finished successfully.
9. Close the hole of the trimmer by rotating the center part of the housing: this is important for safe use of the probe at high input voltages.
10. Repeat the procedure for the blue VPS410-II-B probe that is connected between the blue Input B BNC and the probe calibration terminals on the left side of the instrument.

Chapter 6

Disassembly

Title	Page
Introduction	6-3
Disassembly and Reassembly Procedures	6-3
Required Tools	6-3
Remove the Tilt Stand, Hang Strap, and Side Strap	6-3
Open the Test Tool, Remove the Battery Pack	6-4
How to Access the Top Side of PCA	6-5
How to Access the Bottom Side of PCA	6-5
Access to LCD, Keypad Foil, and Keypad	6-6
Disassembly Steps	6-6

Introduction

This section provides the required disassembly procedures. The printed circuit assembly removed from the Test Tool must be adequately protected against damage.

The Test Tool contains static sensitive components. Handling and servicing these components should be done only at a static free workstation by qualified personnel.

The Test Tool contains a Li-ion battery pack. See Section 1 for instructions on how to safely handle and use this battery pack. The Users Manual is available at www.fluke.com.

The Test Tool uses self-tapping screws. For longer life, use a hand-operated screwdriver to reinsert the screws into the same screw-hole threads on the case.

At the end of this chapter, see Figures 6-2, 6-3, and 6-4 for disassembly.

⚠⚠ Warning

To prevent electric shock, disconnect test leads, probes and power supply from any live source and from the Test Tool itself. Always remove the battery pack before completely disassembling the Test Tool. Only qualified personnel using customary precautions against electric shock should work on a disassembled unit with power on.

Disassembly and Reassembly Procedures

Required Tools

To access all the assemblies, you need:

- Static-free work surface and anti-static wrist wrap
- #10 Torx screwdriver
- A small screwdriver or pair of tweezers to unlock flat cables from their connector
- Cotton gloves (to avoid contaminating the lens and the PCA)

Remove the Tilt Stand, Hang Strap, and Side Strap

To separate the tilt stand from the rear case: gently bend one rotation point away from the rear case and move the stand away from the housing. There is no need to remove screws or other fixing devices.

Before opening the Test Tool, you must remove the hang strap and the side strap. How to remove and install the hang strap is explained in the Users Manual in the “Tips” Chapter. The grip of the side strap consists of two halves kept together with Velcro tape. After having opened it, the straps can be taken apart and be removed from their fixing dowels in the side of the Test Tool. Before you do this, take careful notice on the correct position of the strap. To install, work in reverse order.

Open the Test Tool, Remove the Battery Pack

Proceed as follows:

1. Turn the plastic battery door screws one-quarter turn counterclockwise with a standard blade screwdriver.
2. Remove the battery access door.
3. Remove the battery from the instrument.

Note

Do not short circuit the battery contacts. Do not open or damage the battery housing.

4. If attached, remove the hang strap and the side strap (see the *Removing the Tilt Stand, Hang Strap, and Side Strap* section).
5. Loosen the two black self-tapping screws that fasten the grey/yellow input cover around the BNC input and banana sockets.
6. Remove the cover.

Note

When reinstalling the input cover do not forget to reinstall the flexible sealing strip around the input sockets. The holes in this strip have a flat side that must align with the flat side of the BNC input sockets. The strip has six holes.

When reinstalling the input cover, reinstall the four steel pins (2x17 mm) in the left side and right side of the Test Tool. The pins are used to attach the hang strap and the side strap.

7. Remove the two screws M3x10 (total length) from the bottom holster. The screws fit into square nuts that fit into the rear case.
8. Remove the bottom holster.

Note

When reinstalling the holster, reinstall the two steel pins (2x17 mm) in the left side and right side of the instrument. The pins are used to attach the side strap. Take care that the yellow covers for the DC input and USB inputs are in place correctly.

9. Remove the four self-tapping screws 16 mm long (total length) that attach the rear case. Two of these screws are located in the battery compartment.
10. Remove the rear case.

Note

When reinstalling the rear case, do not forget to put the steel plate 16x17 mm in place again. This plate is in the cavity on the right-hand side of the Test Tool and can be used to attach a Kensington Lock.

When reinstalling the bottom case, take care that the flat cables to the LCD and keyboard are not damaged between the case parts.

How to Access the Top Side of PCA

Most of the measurement points are located on the top side of the PCA. For access to this side, remove the upper plate (shielding lid):

1. Remove the four screws M3x6.5 (total length) with a spring-washer (left side, right side, and bottom side).
2. Remove the four screws M3x10 (total length) that are grouped in a square around the sampling chip N2000.
3. Observe how the screening plate fits onto the lower chassis before you remove this plate to access the top side of the PCA.

How to Access the Bottom Side of PCA

To avoid contaminating the flex cable contacts with grease from your fingers, do not touch these contacts or wear cotton gloves. Contaminated contacts may not cause immediate instrument failure. Failures typically show up when contaminated instruments are operated in humid areas.

1. Unlock both flat cables by shifting the connector latch at the left and right edge with a small screwdriver. The latch is an integral part of the connector body. See Figure 6-1.

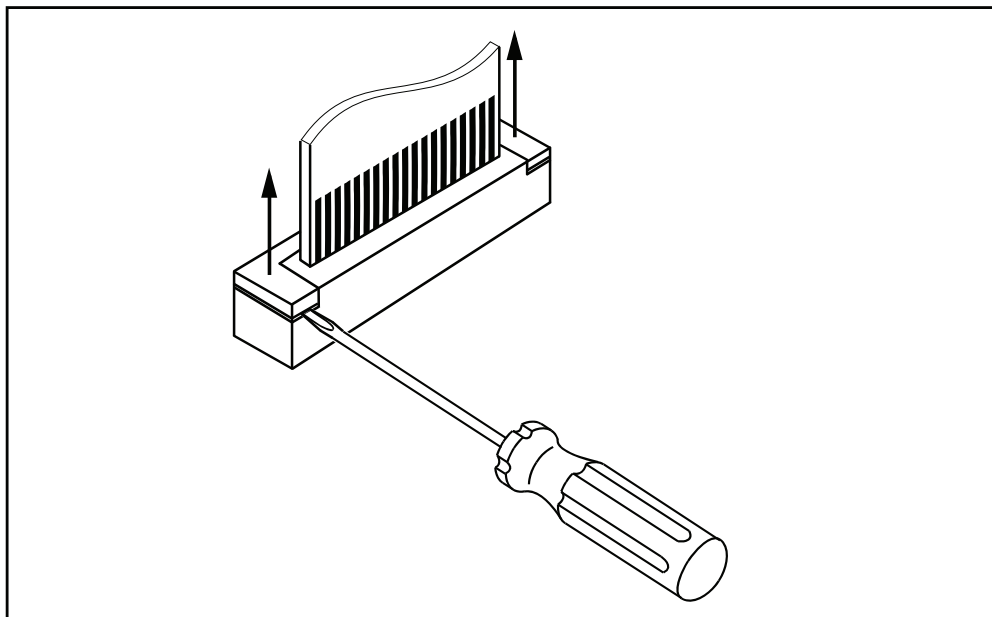

Figure 6-1. Flat Cable Connector

st8682.eps

2. Remove the flat cables from connector X9303 (to LCD), J9414 (to keyboard), J9415 (to LCD backlight).
3. Remove the four screws M3x10 that fix the PCA to the lower chassis (shielding assembly).
4. Carefully slide the PCA out of the holes for the BNCs and Banana Jacks (2-ch Test Tools). The A, B, and Meter input circuits are covered with an isolation foil.
5. Take careful notice on how the foil is positioned around the PCA before you remove the foil as far as required to repair a defective channel.

6. Remove a screw M3x22 that fixes the top and bottom screening of the suspected channel.
7. Reinsert the flat cables if you want to measure the bottom side of the PCA under working condition. See Figures 6-2, 6-3, and 6-4 at the end of this chapter.

Note

Before you attach the PCA again to the lower chassis plate, it is advised to place the isolation foils around the channels.

Access to LCD, Keypad Foil, and Keypad

Proceed as follows:

1. Unlock both flat cables by shifting the connector latch at the left and right edge using a small screwdriver. The latch is an integral part of the connector body.
2. Remove the flat cables from connector X9303 (to LCD), J9414 (to keyboard), J9415 (to LCD backlight).
3. Remove 6 self-tapping screws 10 mm long (total length) that fix the Main PCA module to the top case assembly.
4. Separate the Main PCA module from the top case.
Now you have access to LCD-module, keypad foil and keypad. They can be separated from the top case without the removal of screws or clamps.
5. To prevent contamination, do not touch contact areas with your hands or wear cotton gloves.

Note

When installing the LCD-module into the top case, take care that no dust or dirt is present between module and the window/decal.

Before reinstalling the Main PCA module on to the top case, place the grey plastic strip around the BNC inputs.

Disassembly Steps

See Figures 6-2, 6-3, and 6-4 for guidance on disassembly.

Note

Pictures may be subject to minor changes without prior notice.

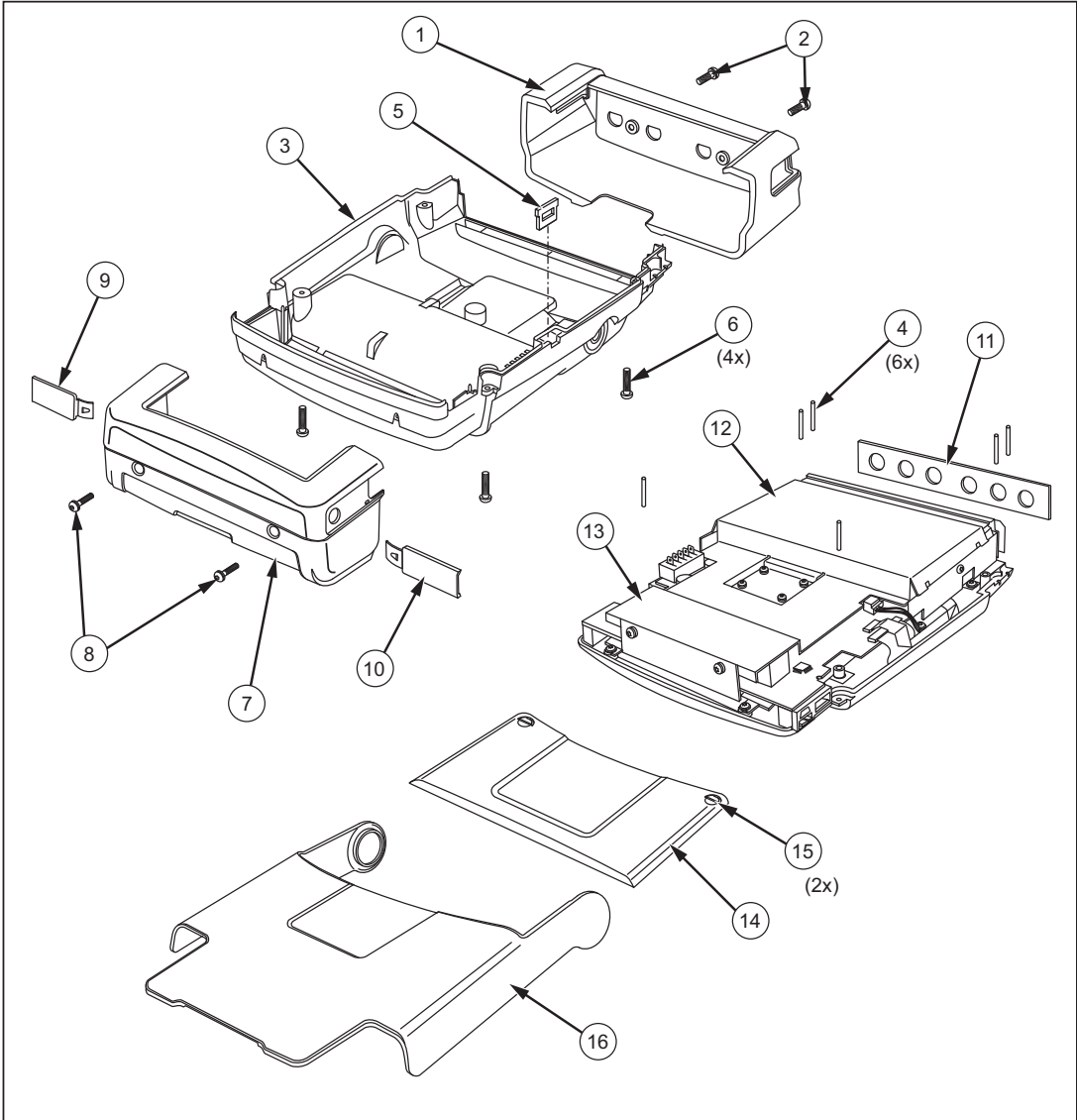

hpp201.eps

Figure 6-2. Opened Case and Screws

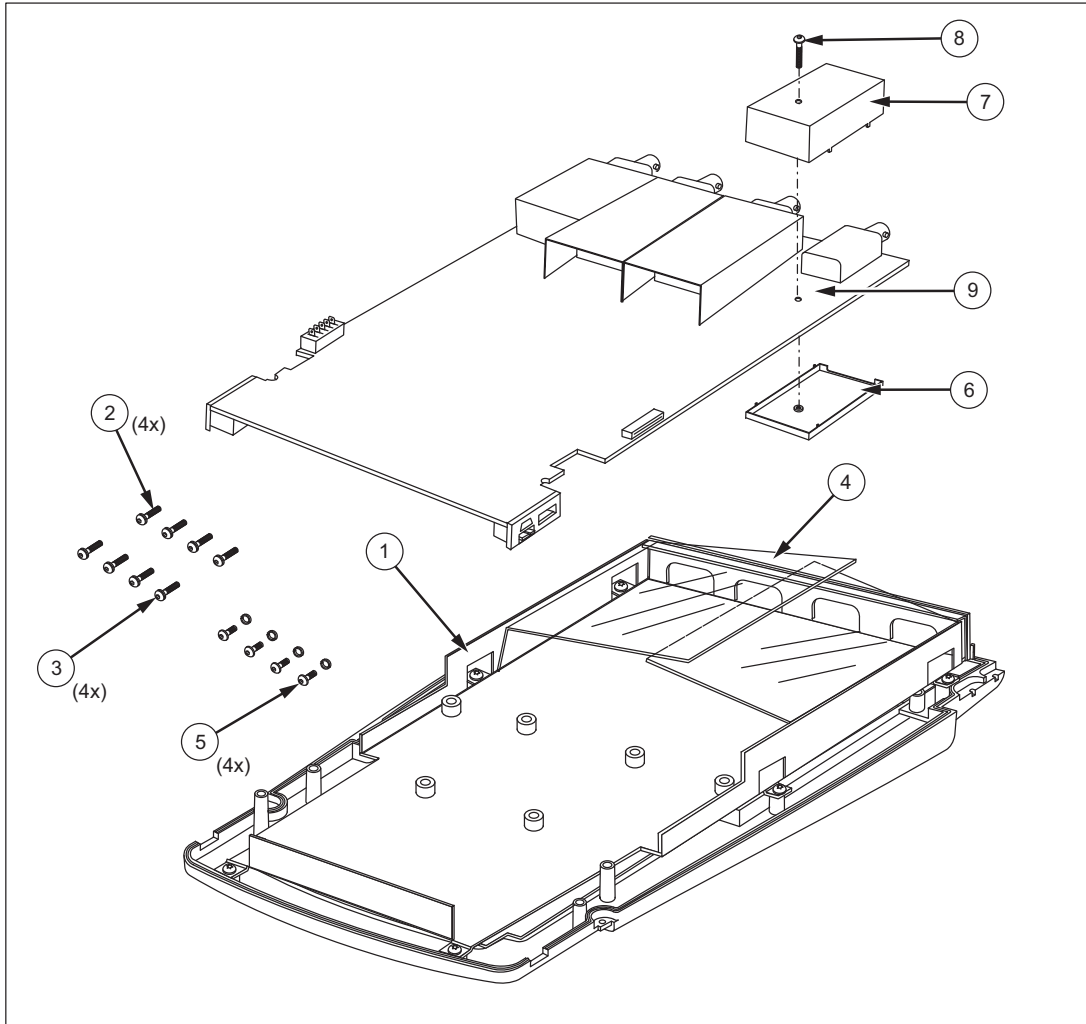

Figure 6-3. Screening Plate Removed and Screws

hpp202.eps

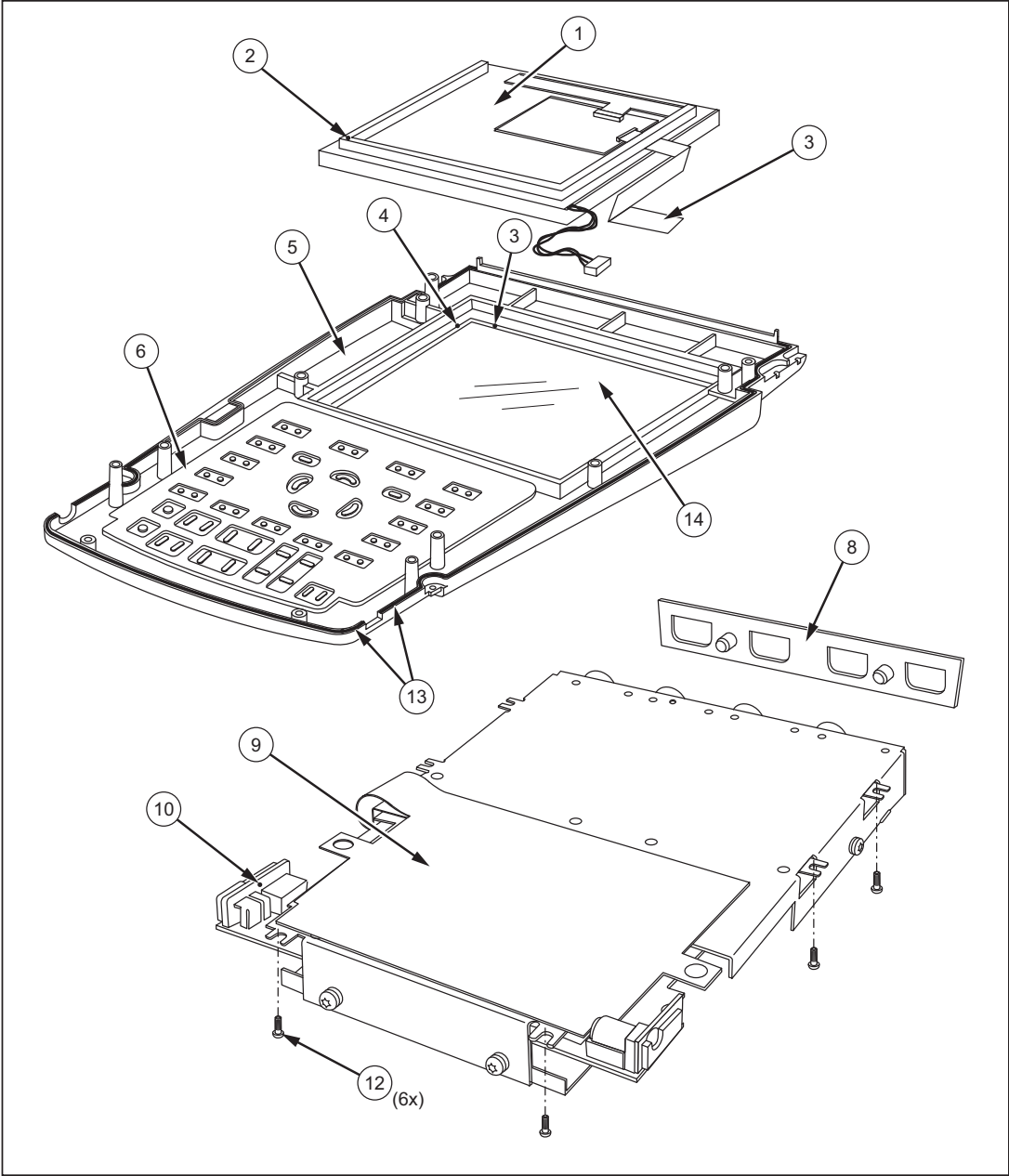

Figure 6-4. PCA Removed from Chassis, Bottom Side Visible

hpp203.eps

