

# Contents

1. Part Names
2. Basic Operation
3. Menu Operation
4. USB Media
5. Connecting Other Devices
6. Operating the Monitor Using a PC (IP control)
7. Troubleshooting
8. Specifications, etc.

Ver. 1.00



# SHARP

- Please choose your favorite page from the content.  
If you want to close the operation manual, press the **MENU** button.  
Also, if you want to return to the previously displayed page, press the **RETURN** button.

## LCD MONITOR

---

### OPERATION MANUAL

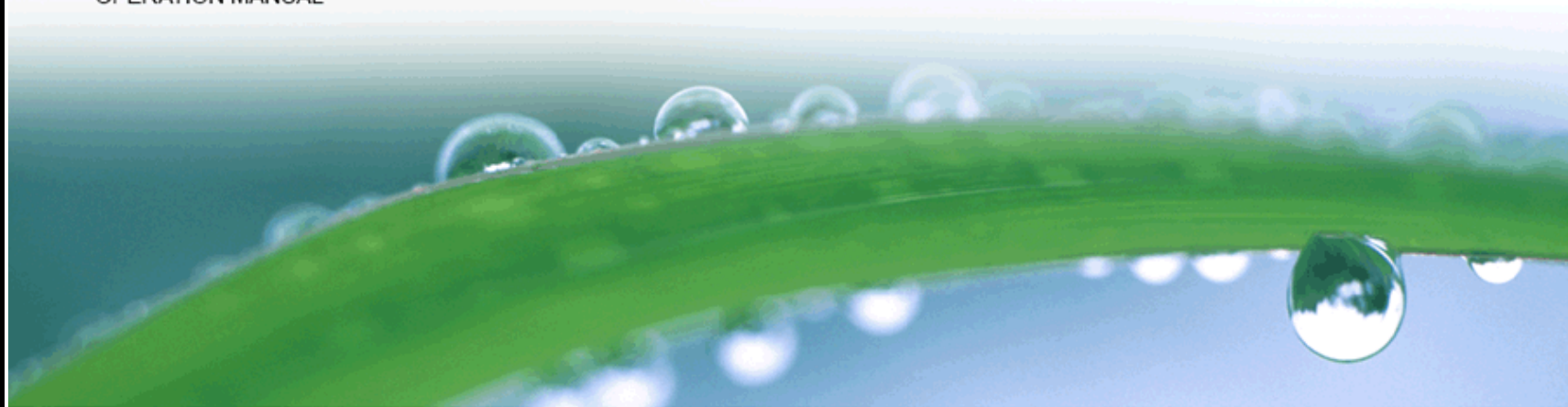

 DOLBY AUDIO™

 HIGH DEFINITION MULTIMEDIA INTERFACE

# Contents

1. Part Names
2. Basic Operation
3. Menu Operation
4. USB Media
5. Connecting Other Devices
6. Operating the Monitor Using a PC (IP control)
7. Troubleshooting
8. Specifications, etc.

Ver. 1.00



## Contents

1. Part Names
  - 1-1. Monitor
  - 1-6. Name of Remote Control Buttons
2. Basic Operation
  - 2-1. Initial Installation
  - 2-3. Basic Operation
  - 2-4. Listening with Headphones
3. Menu Operation
  - 3-1. How to Use Menu
  - 3-2. How to Use Setup Menu
  - 3-3. List of Setup Menu Items
  - 3-44. How to Use Application Menu
  - 3-45. Entering Letters (Software Keyboard)
4. USB Media
  - 4-1. Before Using USB Media
  - 4-7. Enjoying Photo
  - 4-21. Enjoying Music
  - 4-24. Enjoying Video
5. Connecting Other Devices
  - 5-1. Connecting 8K output compatible Device/Quad-screen display (4K or less)
  - 5-5. Connecting 4K output compatible Device
  - 5-7. Viewing HDR Video (INPUT1, INPUT7, INPUT8)
  - 5-9. Using the HDMI CEC
  - 5-11. Connecting Recorder, Player, etc.
  - 5-21. Connecting Audio Device
  - 5-22. Connecting PC
6. Operating the Monitor Using a PC (IP control)
  - 6-1. Connecting the Monitor and PC
  - 6-3. Settings to operate the Monitor
  - 6-4. Command list
7. Troubleshooting
  - 7-1. If You Suspect a Problem
  - 7-9. If Error Message Appears
  - 7-11. What If
8. Specifications, etc.
  - 8-1. PC Supported signal timing
  - 8-2. AV Supported signal timing
  - 8-4. Dimensional Drawing
  - 8-5. Software License

# Contents

1. Part Names

1. Monitor

6. Name of Remote Control Buttons

2. Basic Operation

3. Menu Operation

4. USB Media

5. Connecting Other Devices

6. Operating the Monitor Using a PC (IP control)

7. Troubleshooting

8. Specifications, etc.

Ver. 1.00



## Part Names

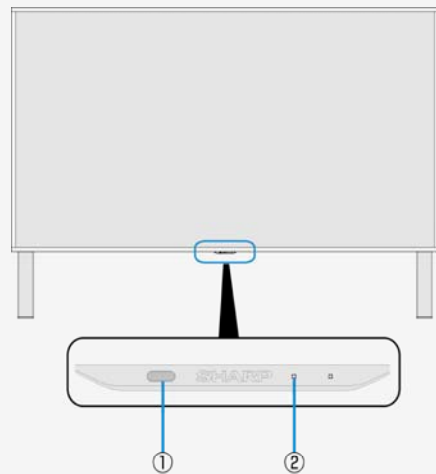

### Monitor

#### Front

	Name	Page
1	Remote control light receiving section <ul style="list-style-type: none"><li>Point the remote control toward this section.</li></ul>	—
2	POWER lamp <ul style="list-style-type: none"><li>Lit white: operating state</li><li>Unlit: power-off state</li></ul>	<a href="#">2-3</a>

# Contents

1. Part Names

1. Monitor

6. Name of Remote Control Buttons

2. Basic Operation

3. Menu Operation

4. USB Media

5. Connecting Other Devices

6. Operating the Monitor Using a PC (IP control)

7. Troubleshooting

8. Specifications, etc.

Ver. 1.00



## Part Names

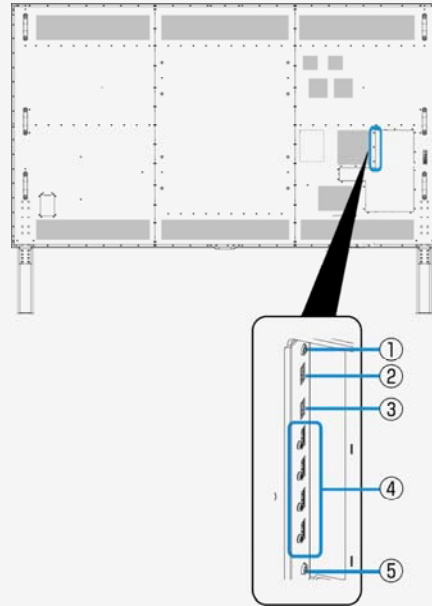

### Monitor

#### Rear

	Name	Page
1	Headphone terminal (Ø 3.5, stereo mini jack) <ul style="list-style-type: none"><li>It allows sounds to come out from the speakers even after headphones are connected.</li></ul>	<a href="#">3-34</a>
2	USB1 terminal <ul style="list-style-type: none"><li>Connect USB memory.</li><li>You can enjoy photo / music / video files stored in USB memory on the Monitor.</li><li>You can use the multimedia auto play function.</li></ul>	<a href="#">3-4</a> , <a href="#">4-1</a>
3	USB2 terminal <ul style="list-style-type: none"><li>Connect USB memory.</li><li>You can enjoy photo / music / video files stored in USB memory on the Monitor.</li><li>You can use the multimedia auto play function.</li></ul>	—
4	INPUT 1 to 4 (HDMI) (INPUT 1: (4K)~4:4:4, INPUT 2/3/4: (4K)~4:2:0) <ul style="list-style-type: none"><li>Connect 4K or 2K output HDMI compatible device.</li></ul>	<a href="#">5-5</a> , <a href="#">5-6</a> , <a href="#">5-11</a> , <a href="#">5-13</a> , <a href="#">5-14</a> , <a href="#">5-27</a> , <a href="#">5-28</a>
5	AUDIO OUTPUT 3.5mm stereo	<a href="#">5-21</a>



# Contents

1. Part Names

1. Monitor

6. Name of Remote Control Buttons

2. Basic Operation

3. Menu Operation

4. USB Media

5. Connecting Other Devices

6. Operating the Monitor Using a PC (IP control)

7. Troubleshooting

8. Specifications, etc.

Ver. 1.00



## Part Names

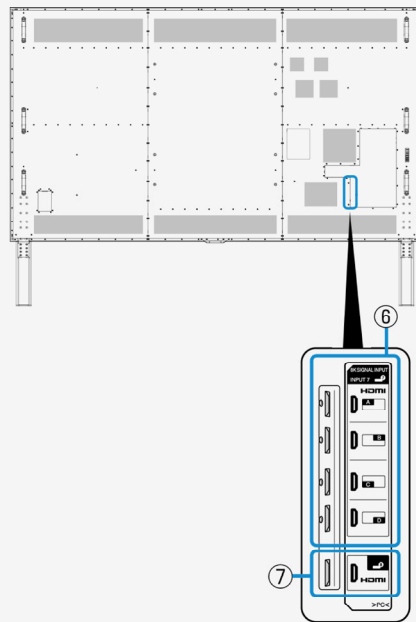

### Monitor

Rear

	Name	Page
6	INPUT 7 A to D (8K, HDMI x 4)	<a href="#">5-1</a> , <a href="#">5-2</a>
7	INPUT 8 (8K, HDMI)	

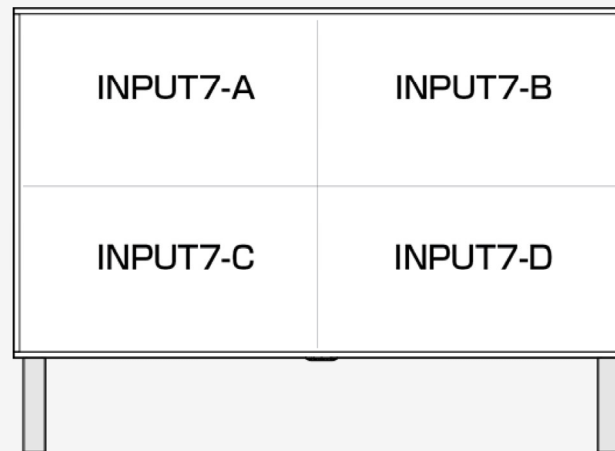

# Contents

1. Part Names
  1. Monitor
  6. Name of Remote Control Buttons
2. Basic Operation
3. Menu Operation
4. USB Media
5. Connecting Other Devices
6. Operating the Monitor Using a PC (IP control)
7. Troubleshooting
8. Specifications, etc.

Ver. 1.00



## Part Names

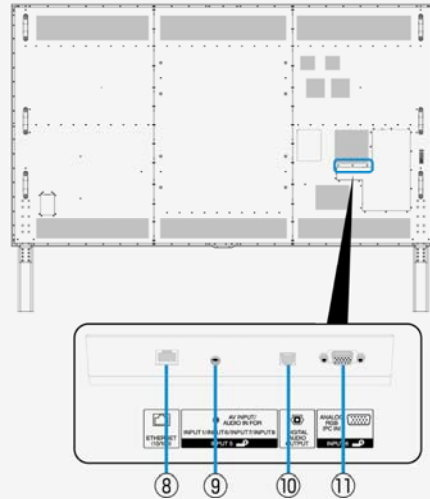

### Monitor

#### Rear

	Name	Page
8	LAN terminal (10BASE-T / 100BASE-TX) <ul style="list-style-type: none"><li>Used for IP Control, etc.</li></ul>	—
9	INPUT 5 <ul style="list-style-type: none"><li>AV INPUT/AUDIO IN FOR INPUT1/INPUT6/INPUT7/INPUT8</li></ul>	<a href="#">3-35</a> , <a href="#">3-36</a> , <a href="#">5-15</a> , <a href="#">5-27</a> , <a href="#">5-28</a> , <a href="#">5-29</a>
10	Digital audio output (optical) terminal <ul style="list-style-type: none"><li>Connect the audio device.</li></ul>	<a href="#">5-21</a>
11	INPUT 6 (Analog RGB) <ul style="list-style-type: none"><li>Connect with the analog RGB terminal for a computer.</li></ul>	<a href="#">5-29</a>

# Contents

1. Part Names
  1. Monitor
  6. Name of Remote Control Buttons
2. Basic Operation
3. Menu Operation
4. USB Media
5. Connecting Other Devices
6. Operating the Monitor Using a PC (IP control)
7. Troubleshooting
8. Specifications, etc.

Ver. 1.00



## Part Names

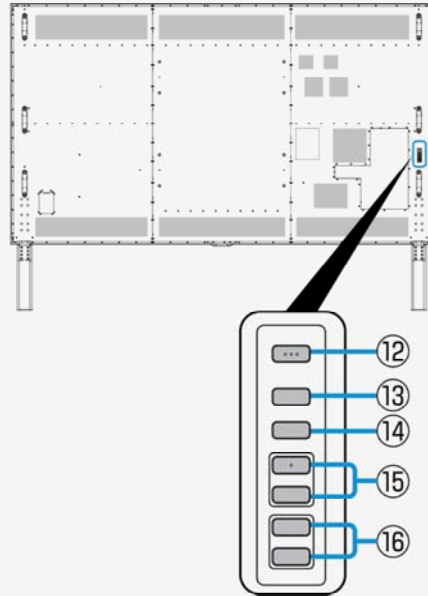

### Monitor

#### Rear

	Name	Page
12	Power button	<a href="#">2-3</a>
13	MENU button <ul style="list-style-type: none"><li>• Displays the menu.</li></ul>	<a href="#">3-2</a>
14	INPUT button <ul style="list-style-type: none"><li>• When in the Menu, this functions as the OK button.</li></ul>	—
15	▲ forward / ▼ backward button <ul style="list-style-type: none"><li>• When Menu is operated, it is used as ▲ and ▼ cursor.</li></ul>	—
16	Volume (+ / -) button <ul style="list-style-type: none"><li>• When Menu is operated, it is used as right-left cursor.</li><li>• When in the Menu, this functions as the right-left cursor.</li></ul>	—

# Contents

1. Part Names
  1. Monitor
  6. Name of Remote Control Buttons
2. Basic Operation
3. Menu Operation
4. USB Media
5. Connecting Other Devices
6. Operating the Monitor Using a PC (IP control)
7. Troubleshooting
8. Specifications, etc.

Ver. 1.00



## Part Names

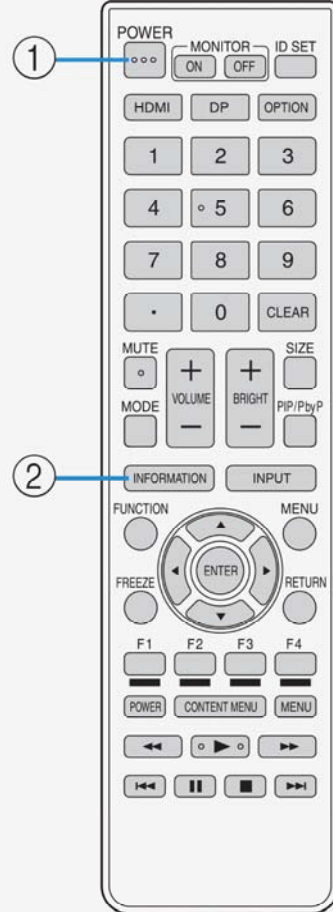

### Name of Remote Control Buttons

	Button name	Page
1	<b>POWER</b>	<a href="#">2-3</a>
2	<b>INFORMATION</b> <ul style="list-style-type: none"><li>• Display the information.</li></ul>	—

# Contents

1. Part Names
  1. Monitor
  6. Name of Remote Control Buttons
2. Basic Operation
3. Menu Operation
4. USB Media
5. Connecting Other Devices
6. Operating the Monitor Using a PC (IP control)
7. Troubleshooting
8. Specifications, etc.

Ver. 1.00



## Part Names

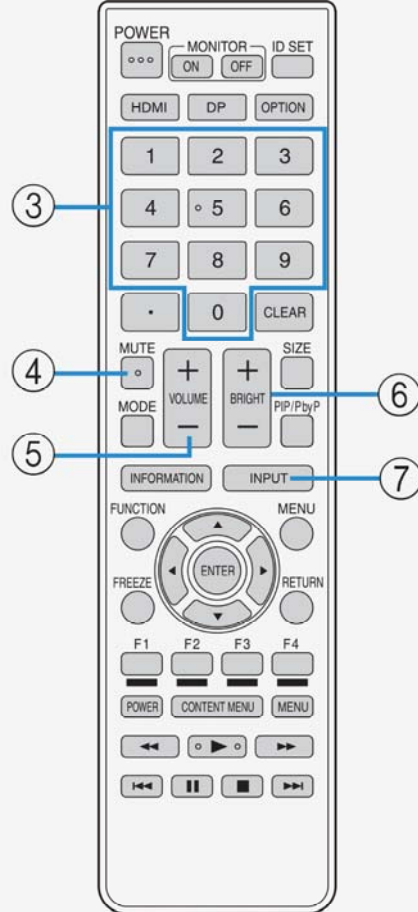

## Name of Remote Control Buttons

	Button name	Page
3	<b>Number</b> <ul style="list-style-type: none"><li>Also used to enter characters or numbers and perform the setup operations.</li></ul>	—
4	<b>MUTE</b>	—
5	<b>VOLUME +/-</b>	—
6	<b>BRIGHT +/-</b>	—
7	<b>INPUT</b> <ul style="list-style-type: none"><li>Also used to change the input source to PC, USB media, etc.</li></ul>	<a href="#">5-18</a> , <a href="#">5-26</a>

# Contents

1. Part Names
  1. Monitor
  6. Name of Remote Control Buttons
2. Basic Operation
3. Menu Operation
4. USB Media
5. Connecting Other Devices
6. Operating the Monitor Using a PC (IP control)
7. Troubleshooting
8. Specifications, etc.

Ver. 1.00



## Part Names

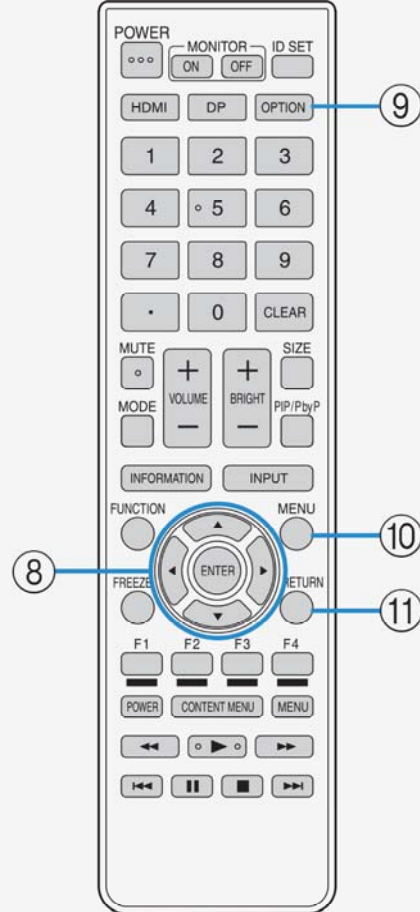

### Name of Remote Control Buttons

	Button name	Page
8	 , <b>ENTER</b> <ul style="list-style-type: none"><li>Used for the menu, character entry, etc.</li></ul>	<a href="#">3-2</a> , <a href="#">3-45</a>
9	<b>OPTION</b>	<a href="#">3-44</a>
10	<b>MENU</b>	<a href="#">3-2</a>
11	<b>RETURN</b> <ul style="list-style-type: none"><li>Used for the menu, character entry, etc.</li></ul>	<a href="#">3-2</a> , <a href="#">3-45</a>

# Contents

## 1. Part Names

### 1. Monitor

### 6. Name of Remote Control Buttons

## 2. Basic Operation

## 3. Menu Operation

## 4. USB Media

## 5. Connecting Other Devices

## 6. Operating the Monitor Using a PC (IP control)

## 7. Troubleshooting

## 8. Specifications, etc.

Ver. 1.00



# Part Names

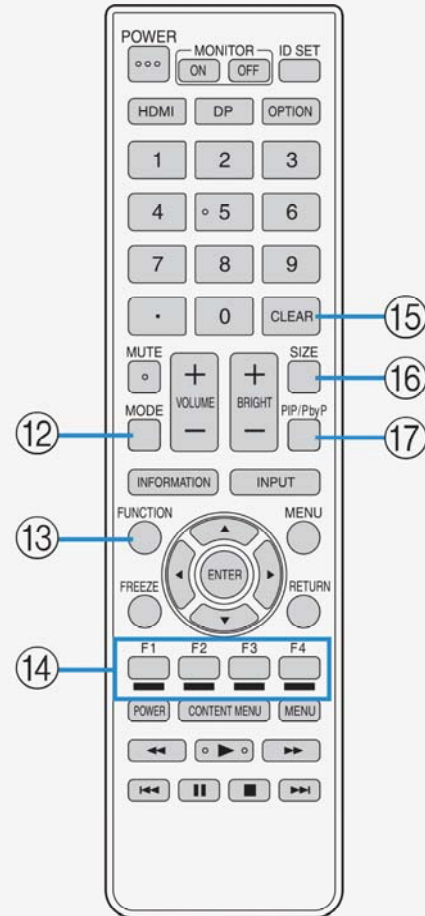

## Name of Remote Control Buttons

	Button name	Page
12	<b>MODE</b>	<a href="#">3-8</a>
13	<b>FUNCTION</b>	<a href="#">3-27</a>
14	<b>F1 / F2 / F3 / F4</b> • Operation for character entry	<a href="#">3-45</a>
15	<b>CLEAR</b>	<a href="#">5-4</a>
16	<b>SIZE</b>	<a href="#">5-25</a>
17	<b>PIP/PbP</b>	<a href="#">5-3</a>

### NOTE

- The following buttons are not used on this monitor.  
**MONITOR ON, MONITOR OFF, ID SET, HDMI, DP, .., FREEZE**

# Contents

1. Part Names
  2. Basic Operation
    1. Initial Installation
  3. Basic Operation
  4. Listening with Headphones
- 
3. Menu Operation
  4. USB Media
  5. Connecting Other Devices
  6. Operating the Monitor Using a PC (IP control)
  7. Troubleshooting
  8. Specifications, etc.

Ver. 1.00



## Basic Operation

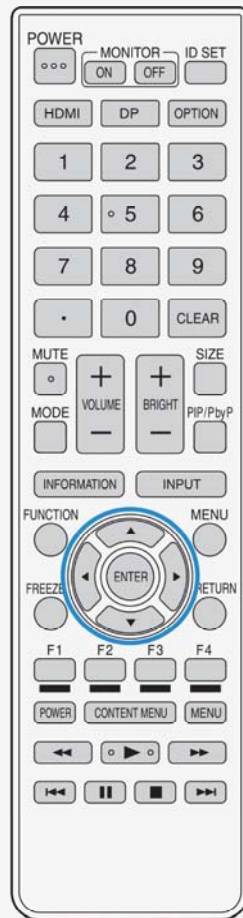

### Initial Installation

Perform the following steps before you press **POWER** on the remote control unit.

1. Insert the batteries into the remote control unit.
2. Plug in the AC cord to the AC outlet.

### Language (Language setting)

1. Press to select the desired language listed on the screen, and then press **ENTER**.





# Contents

1. Part Names
  2. Basic Operation
    1. Initial Installation
  3. Basic Operation
  4. Listening with Headphones
- 
3. Menu Operation
  4. USB Media
  5. Connecting Other Devices
  6. Operating the Monitor Using a PC (IP control)
  7. Troubleshooting
  8. Specifications, etc.

Ver. 1.00



## Basic Operation

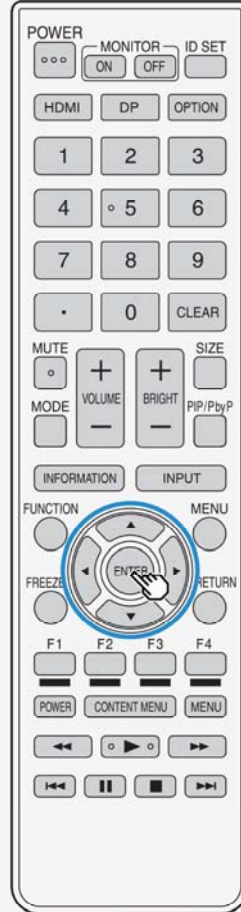

### Initial Installation (Continue)

#### No operation off

Enter standby automatically if no operation continues for the set time.

2. Press to select setting, and then press **ENTER**.



#### No signal off

Enter standby automatically if no signal is received for 10min.

3. Press to select setting, and then press **ENTER**.

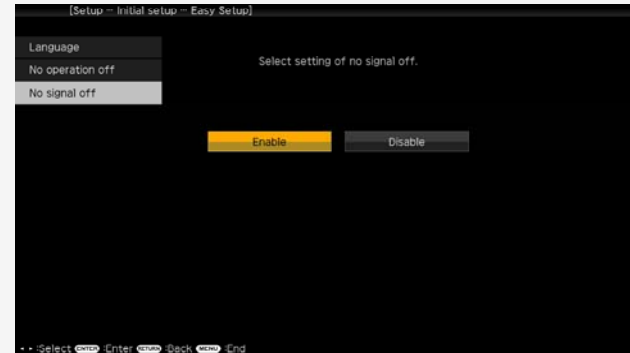

# Contents

1. Part Names

2. Basic Operation

1. Initial Installation

3. Basic Operation

4. Listening with Headphones

3. Menu Operation

4. USB Media

5. Connecting Other Devices

6. Operating the Monitor Using a PC (IP control)

7. Troubleshooting

8. Specifications, etc.

Ver. 1.00



## Basic Operation

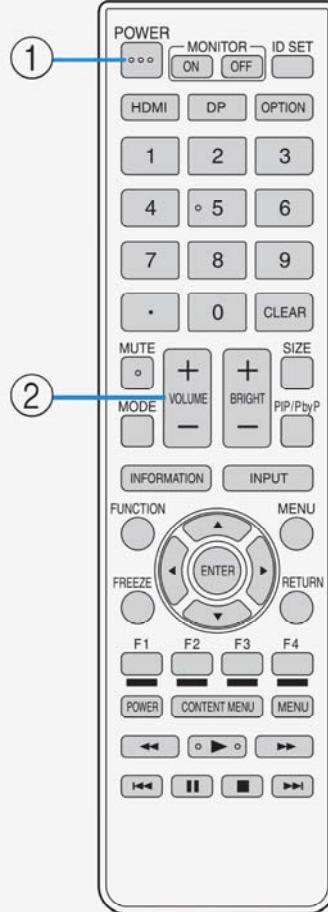

### Basic Operation

1. Turn on the Monitor
  - Each time you press the power button on the remote control turn on or off the Monitor.
  - After pressing the power button on the rear side of the Monitor to turn "ON", the POWER lamp turns white.
2. Adjust the volume
  - Press "+" to turn the volume up, and "-" to turn it down.

### Front side of the Monitor



POWER lamp

# Contents

1. Part Names

2. Basic Operation

1. Initial Installation

3. Basic Operation

4. Listening with Headphones

3. Menu Operation

4. USB Media

5. Connecting Other Devices

6. Operating the Monitor Using a PC (IP control)

7. Troubleshooting

8. Specifications, etc.

Ver. 1.00

>

<

## Basic Operation

### Listening with Headphones

#### Setting up the headphones

- Sets the audio sound that comes out of the speakers / headphone terminal during the use of headphones.
1. Press **MENU** to display the home screen
  2. Press **▲▼/◀▶** to select "**Setup**", and then press **ENTER**
  3. Press **▲▼/◀▶** to select "**Option**" - "**Terminal setting**", and then press **ENTER**
  4. Press **▲▼** to select "**Headphone**", and then press **ENTER**
  5. Press **▲▼** to select any of "**Mode1**" or "**Mode2**", and then press **ENTER**
- For information on how to adjust the sound / volume of the speakers or headphone jack, see the following.

Headphone terminal  
( $\phi$  3.5, stereo mini jack)

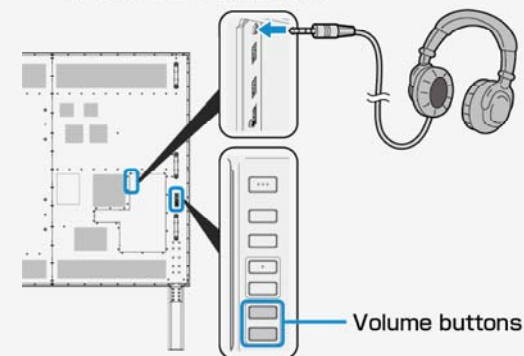

Setup	Sound output		Volume control method
	Headphone	Monitor's speaker	
<b>Mode1</b>	Yes	No	Adjust the volume by using the volume button on the remote control or the Monitor
<b>Mode2</b>	Yes	Yes	Adjust the headphone volume by using the volume button on the Monitor
			Adjust the speaker volume of the Monitor by using the volume button on the remote control

# Contents

1. Part Names
2. Basic Operation
3. Menu Operation
  1. How to Use Menu
  2. How to Use Setup Menu
  3. List of Setup Menu Items
  44. How to Use Application Menu
  45. Entering Letters (Software Keyboard)
4. USB Media
5. Connecting Other Devices
6. Operating the Monitor Using a PC (IP control)
7. Troubleshooting
8. Specifications, etc.

Ver. 1.00



## Menu Operation

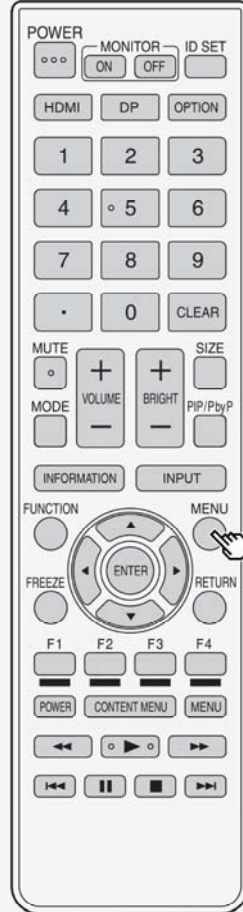

### How to Use Menu

- The screen that serves as a gateway to operating the Monitor is called the "Menu".
- This section describes how to use Menu.



#### NOTE

- You can also use the buttons on the Monitor to operate the Menu.(page [1-5](#))

# Contents

1. Part Names
2. Basic Operation
3. Menu Operation
  1. How to Use Menu
  2. How to Use Setup Menu
  3. List of Setup Menu Items
44. How to Use Application Menu
45. Entering Letters (Software Keyboard)
4. USB Media
5. Connecting Other Devices
6. Operating the Monitor Using a PC (IP control)
7. Troubleshooting
8. Specifications, etc.

Ver. 1.00



## Menu Operation

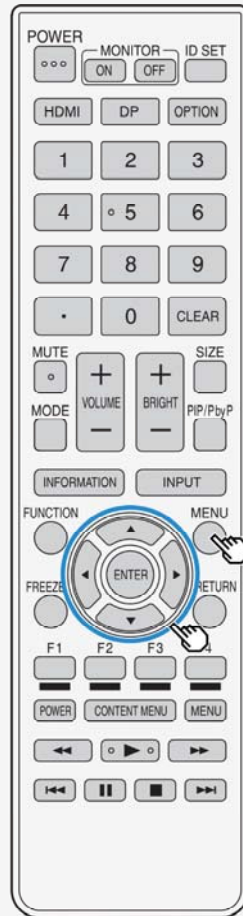

### How to Use Setup Menu

Basic operation for using the setup menu

1. Press **MENU** to display the Menu, press to select "**Setup**", and then press **ENTER**
  - If button is pressed, the Menu item can be selected as follows.

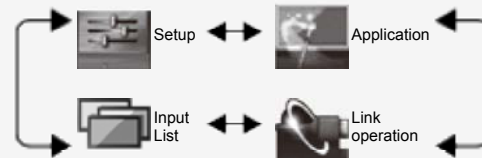

2. Press // to select a desired item, and then press **ENTER**.
  - Depending on the selected item, there may be further options to select from.

e.g.: for "**Setup**"

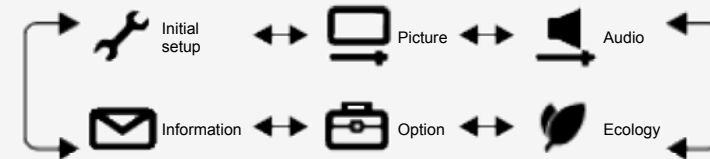

- To select the Menu item (step 1) again, press **RETURN**.

# Contents

- 1. Part Names
- 2. Basic Operation
- 3. Menu Operation
  - 1. How to Use Menu
  - 2. How to Use Setup Menu
  - 3. List of Setup Menu Items
- 44. How to Use Application Menu
- 45. Entering Letters (Software Keyboard)
- 4. USB Media
- 5. Connecting Other Devices
- 6. Operating the Monitor Using a PC (IP control)
- 7. Troubleshooting
- 8. Specifications, etc.

Ver. 1.00



## Menu Operation

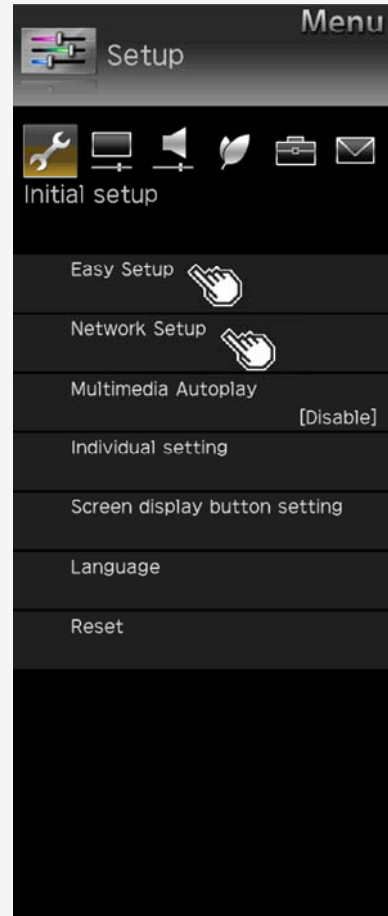

### List of Setup Menu Items

#### Easy Setup

When you turn on the Monitor for the first time, the “Easy Setup” screen appears. Configure the setting by following onscreen instructions.

Menu item names
Language
No operation off
No signal off

#### Network setup

#### IP Control setup

- This setting is necessary when operating Monitor remotely using a mobile device or a personal computer.

Menu item names			Setup
Ethernet setup	Change	IP address	DNS IP address
	Initialize		Test, Complete
IP Control setup	IP Control setup		Enable, Disable, Login ID, Password, Control port, Power Save Mode
	Detail setting	Change	Login ID, Password, Control port
		Initialize	

# Contents

1. Part Names
2. Basic Operation
3. Menu Operation
  1. How to Use Menu
  2. How to Use Setup Menu
  3. List of Setup Menu Items
44. How to Use Application Menu
45. Entering Letters (Software Keyboard)
4. USB Media
5. Connecting Other Devices
6. Operating the Monitor Using a PC (IP control)
7. Troubleshooting
8. Specifications, etc.

Ver. 1.00



## Menu Operation

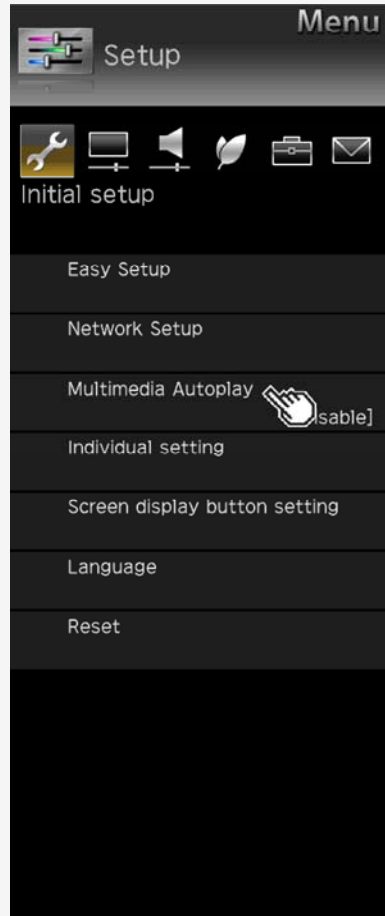

### List of Setup Menu Items

#### Multimedia Autoplay

Playback the pictures in the USB memory automatically when power is turned on. Create a folder and name it as "autoplay", then put pictures into this folder.

# Contents

1. Part Names
  2. Basic Operation
  3. Menu Operation
    1. How to Use Menu
    2. How to Use Setup Menu
    3. List of Setup Menu Items
  44. How to Use Application Menu
  45. Entering Letters (Software Keyboard)
4. USB Media
  5. Connecting Other Devices
  6. Operating the Monitor Using a PC (IP control)
  7. Troubleshooting
  8. Specifications, etc.

Ver. 1.00



## Menu Operation

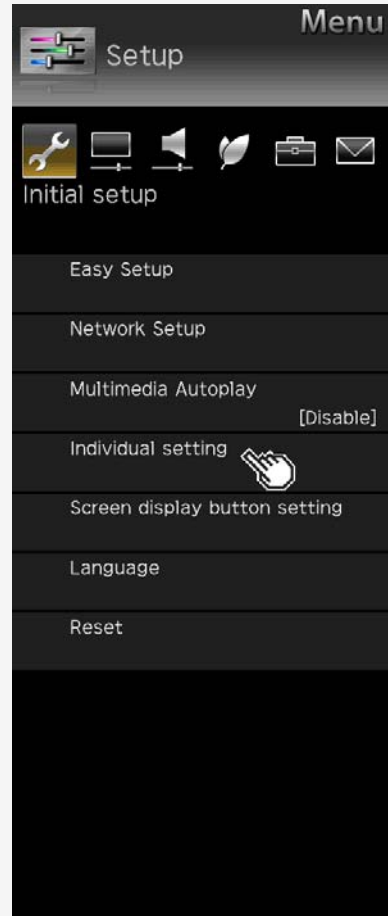

### List of Setup Menu Items

#### Individual setting

##### Power Save Mode

Menu item name	Setup	
Power Save Mode	On	Go into normal standby.
	Off	The standby power consumption will increase when "Off" is selected. IP Control is active even during standby.

##### USB memory setting

- This setting allows you to select a USB memory to copy pictures.

Menu item name	Setup	
USB memory setting	Select USB memory	Select USB memory to use for copy
	Remove selected USB memory	Remove the selected USB memory

##### Power indicator off setting

- Turns off POWER lamp during operation.

Menu item name	Setup
Power indicator off setting	Enable
	Disable

#### Front side of the Monitor



POWER lamp



# Contents

1. Part Names
2. Basic Operation
3. Menu Operation
  1. How to Use Menu
  2. How to Use Setup Menu
  3. List of Setup Menu Items
  44. How to Use Application Menu
  45. Entering Letters (Software Keyboard)
4. USB Media
5. Connecting Other Devices
6. Operating the Monitor Using a PC (IP control)
7. Troubleshooting
8. Specifications, etc.

Ver. 1.00



## Menu Operation

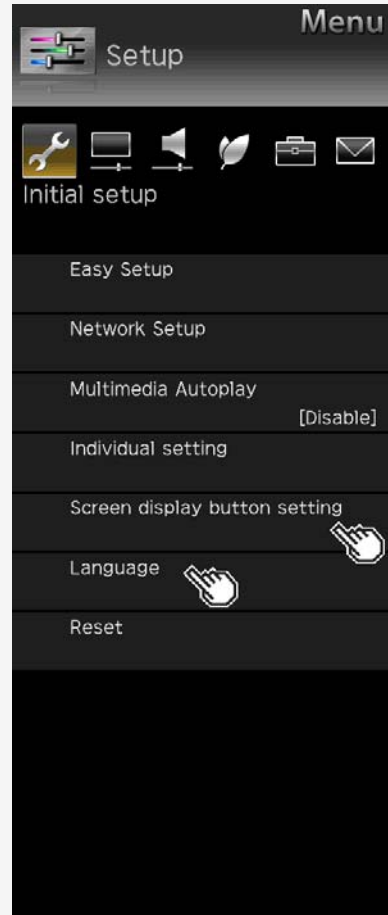

### List of Setup Menu Items

#### Screen display button setting

- This setting allows you to choose the displayed information when you press **INFORMATION**.

Menu item name	Setup
Input display	Yes, During Input select, No
Input detail	Yes, During Input select, No
Sound/Screen info. display	Yes, During Input select, No

#### Language

- Using the Menu screen, you can switch the on-screen display language to other languages.

Setup
English, Deutsch, Français, Italiano, Español, Русский

# Contents

1. Part Names
2. Basic Operation
3. Menu Operation
  1. How to Use Menu
  2. How to Use Setup Menu
  3. List of Setup Menu Items
44. How to Use Application Menu
45. Entering Letters (Software Keyboard)
4. USB Media
5. Connecting Other Devices
6. Operating the Monitor Using a PC (IP control)
7. Troubleshooting
8. Specifications, etc.

Ver. 1.00



## Menu Operation

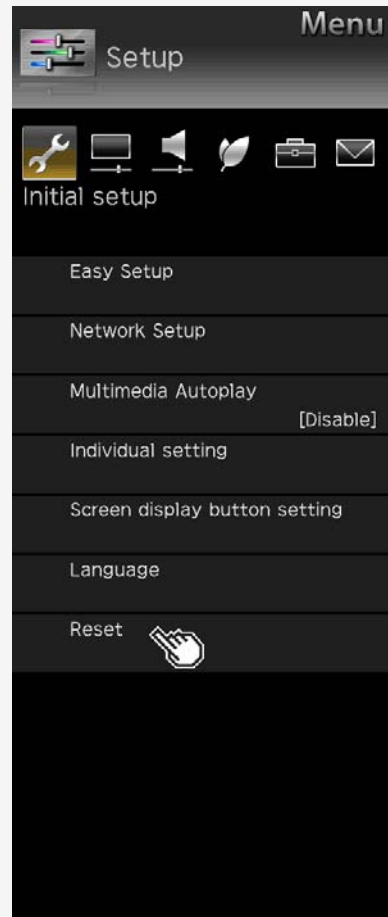

### List of Setup Menu Items

#### Reset

- Before transferring or disposing the Monitor, erase all of your personal information. The information (various adjustment values, LAN setup, passwords, etc.) will be erased.

# Contents

1. Part Names
  2. Basic Operation
  3. Menu Operation
    1. How to Use Menu
    2. How to Use Setup Menu
    3. List of Setup Menu Items
  44. How to Use Application Menu
  45. Entering Letters (Software Keyboard)
4. USB Media
  5. Connecting Other Devices
  6. Operating the Monitor Using a PC (IP control)
  7. Troubleshooting
  8. Specifications, etc.

Ver. 1.00



## Menu Operation

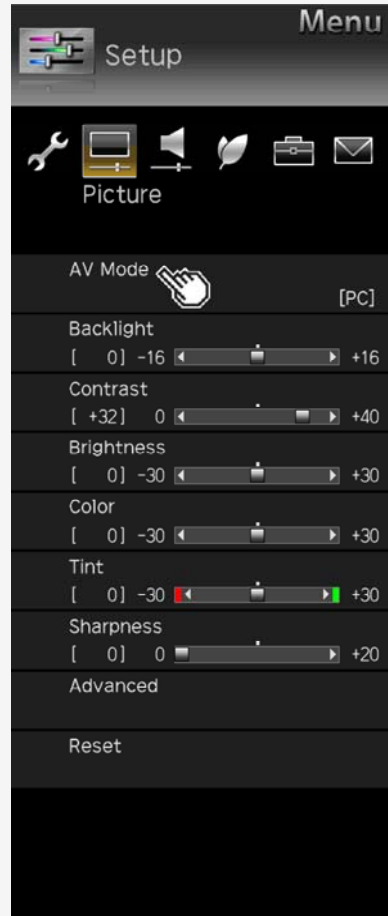

### List of Setup Menu Items

#### AV Mode

- This function allows you to switch the video and sound to be more suitable.

Setup

USER 1, USER 2, USER 3, PC, PC2, sRGB, DYNAMIC

You can also configure these settings from the Application menu([page 3-44](#))

# Contents

1. Part Names
2. Basic Operation
3. Menu Operation
  1. How to Use Menu
  2. How to Use Setup Menu
  3. List of Setup Menu Items
44. How to Use Application Menu
45. Entering Letters (Software Keyboard)
4. USB Media
5. Connecting Other Devices
6. Operating the Monitor Using a PC (IP control)
7. Troubleshooting
8. Specifications, etc.

Ver. 1.00



## Menu Operation

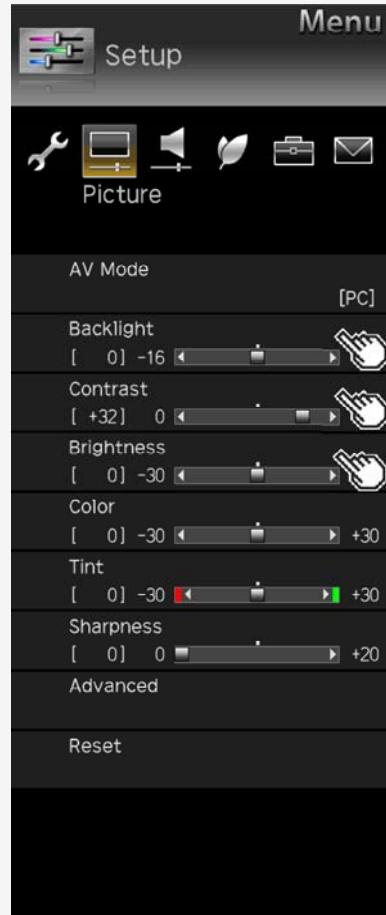

### List of Setup Menu Items

#### Backlight

- You can adjust the backlight brightness.

Setup

-16 to 0 to +16

#### Contrast

- You can adjust the contrast.

Setup

0 to +40

#### Brightness

- You can adjust the brightness.

Setup

-30 to 0 to +30

# Contents

1. Part Names
2. Basic Operation
3. Menu Operation
  1. How to Use Menu
  2. How to Use Setup Menu
  3. List of Setup Menu Items
44. How to Use Application Menu
45. Entering Letters (Software Keyboard)
4. USB Media
5. Connecting Other Devices
6. Operating the Monitor Using a PC (IP control)
7. Troubleshooting
8. Specifications, etc.

Ver. 1.00



## Menu Operation

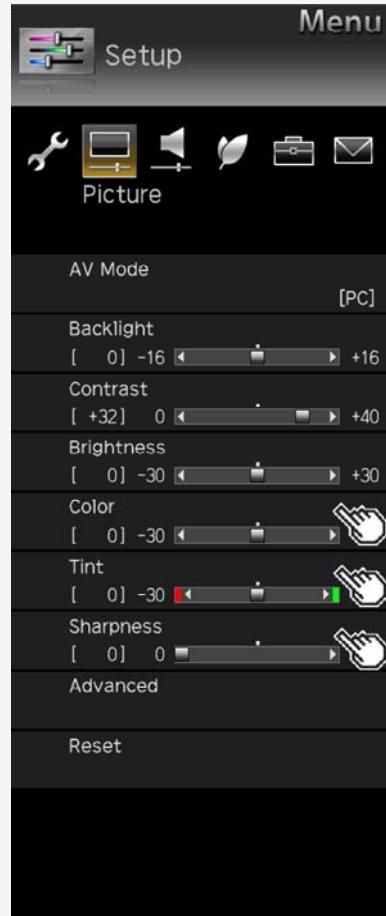

### List of Setup Menu Items

#### Color

- You can adjust the color saturation.

Setup

-30 to 0 to +30

#### Tint

- You can adjust the color tint.

Setup

-30 to 0 to +30

#### Sharpness

- You can adjust the sharpness.

Setup

0 to +20

# Contents

1. Part Names
2. Basic Operation
3. Menu Operation
  1. How to Use Menu
  2. How to Use Setup Menu
  3. List of Setup Menu Items
44. How to Use Application Menu
45. Entering Letters (Software Keyboard)
4. USB Media
5. Connecting Other Devices
6. Operating the Monitor Using a PC (IP control)
7. Troubleshooting
8. Specifications, etc.

Ver. 1.00



## Menu Operation

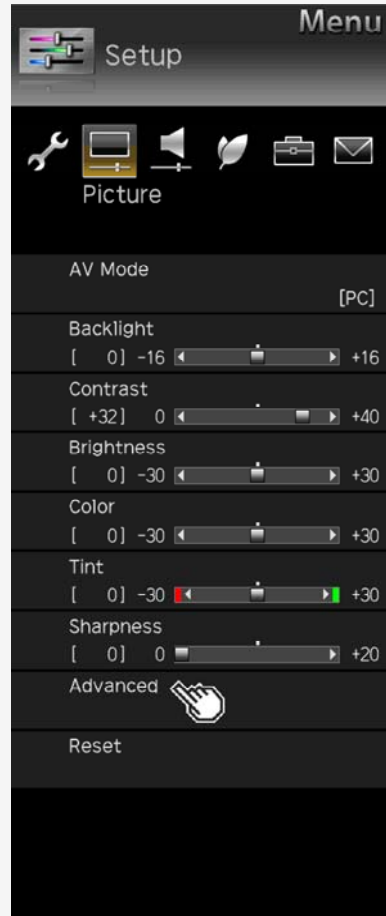

### List of Setup Menu Items

#### Advanced

##### C.M.S.-hue

- Adjusts six-color hue.

Menu item name	Setup
C.M.S.-hue	<b>R</b> -30 to 0 to +30
	<b>Y</b> -30 to 0 to +30
	<b>G</b> -30 to 0 to +30
	<b>C</b> -30 to 0 to +30
	<b>B</b> -30 to 0 to +30
<b>M</b> -30 to 0 to +30	
Reset	

##### C.M.S.-saturation

- Adjusts six-color saturation.

Menu item name	Setup
C.M.S.-saturation	<b>R</b> -15 to 0 to +15
	<b>Y</b> -15 to 0 to +15
	<b>G</b> -15 to 0 to +15
	<b>C</b> -15 to 0 to +15
	<b>B</b> -15 to 0 to +15
<b>M</b> -15 to 0 to +15	
Reset	

# Contents

1. Part Names
2. Basic Operation
3. Menu Operation
  1. How to Use Menu
  2. How to Use Setup Menu
  3. List of Setup Menu Items
44. How to Use Application Menu
45. Entering Letters (Software Keyboard)
4. USB Media
5. Connecting Other Devices
6. Operating the Monitor Using a PC (IP control)
7. Troubleshooting
8. Specifications, etc.

Ver. 1.00



## Menu Operation

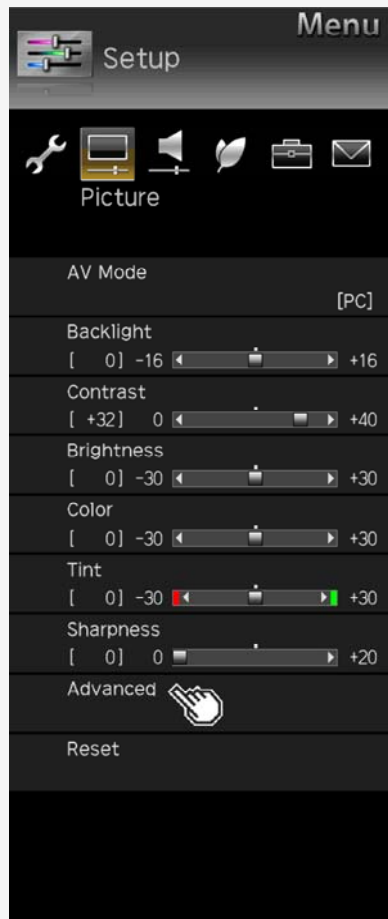

### List of Setup Menu Items

#### Advanced (Continue)

##### C.M.S.-value

- Adjusts six-color image value.

Menu item name	Setup	
C.M.S.-value	R	-30 to 0 to +30
	Y	-30 to 0 to +30
	G	-30 to 0 to +30
	C	-30 to 0 to +30
	B	-30 to 0 to +30
	M	-30 to 0 to +30
Reset		

##### Color Adjustment Table

- Sets the color reproduction range to be displayed.

Steps
Advanced, Standard, Custom*

#### NOTE

\*ICC profile is necessary.  
For the ICC profile, consult your authorized SHARP dealer.

# Contents

1. Part Names
2. Basic Operation
3. Menu Operation
  1. How to Use Menu
  2. How to Use Setup Menu
  3. List of Setup Menu Items
44. How to Use Application Menu
45. Entering Letters (Software Keyboard)
4. USB Media
5. Connecting Other Devices
6. Operating the Monitor Using a PC (IP control)
7. Troubleshooting
8. Specifications, etc.

Ver. 1.00

## Menu Operation

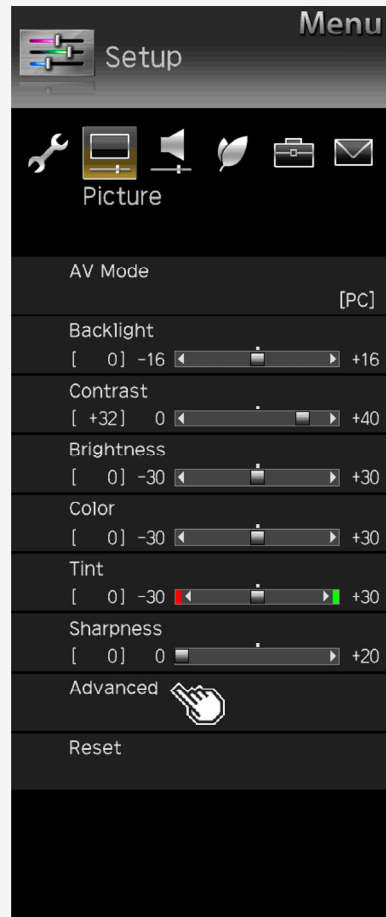

### List of Setup Menu Items

#### Advanced (Continue)

##### Color temp.

- You can make adjustments to make the color blueish white (color temperature; high) or redish white (color temperature: low). In addition, you can adjust the white balance by changing the R / G / B gain values on a per-color temperature basis.

Menu item name	Setup	
Color temp.	<b>Color temp.</b>	<b>12000K, 9300K, 6500K, THRU</b>
	<b>R Gain(LO)</b>	-30 to 0 to +30
	<b>G Gain(LO)</b>	-30 to 0 to +30
	<b>B Gain(LO)</b>	-30 to 0 to +30
	<b>R Gain(HI)</b>	-30 to 0 to +30
	<b>G Gain(HI)</b>	-30 to 0 to +30
	<b>B Gain(HI)</b>	-30 to 0 to +30
	<b>Reset</b>	

##### Video Compensation

- Use Motion Enhancement to view fast action video more clearly.

Menu item name	Setup
Video Compensation	High double speed drive
	Double speed drive
	Off



# Contents

- 1. Part Names
- 2. Basic Operation
- 3. Menu Operation
  - 1. How to Use Menu
  - 2. How to Use Setup Menu
  - 3. List of Setup Menu Items
  - 44. How to Use Application Menu
  - 45. Entering Letters (Software Keyboard)
- 4. USB Media
- 5. Connecting Other Devices
- 6. Operating the Monitor Using a PC (IP control)
- 7. Troubleshooting
- 8. Specifications, etc.

Ver. 1.00



## Menu Operation

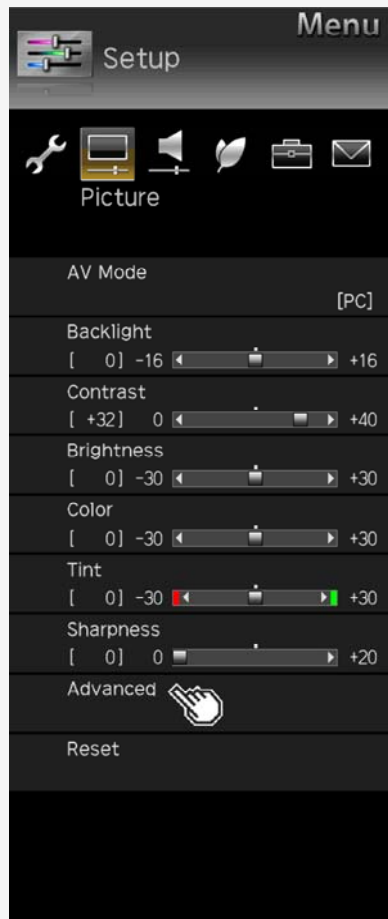

### List of Setup Menu Items

#### Advanced (Continue)

#### Dynamic range expansion setting

- Sets the local dimming control and the peak brightness.  
Enhances the contrast through the use of area-driven backlight.

Setup
0 to +6

# Contents

1. Part Names
2. Basic Operation
3. Menu Operation
  1. How to Use Menu
  2. How to Use Setup Menu
  3. List of Setup Menu Items
44. How to Use Application Menu
45. Entering Letters (Software Keyboard)
4. USB Media
5. Connecting Other Devices
6. Operating the Monitor Using a PC (IP control)
7. Troubleshooting
8. Specifications, etc.

Ver. 1.00



## Menu Operation

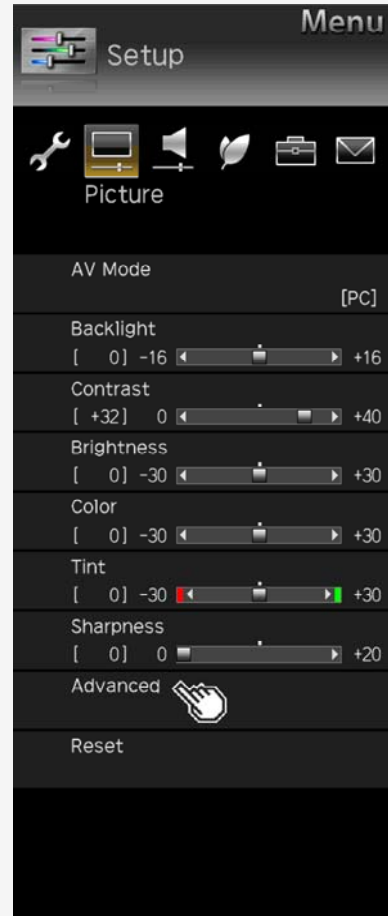

### List of Setup Menu Items

#### Advanced (Continue)

Menu item name	Setup	
Gamma adjustment*	-3 to 0 to +3	The difference in tone between the bright and dark sections of a video image can be adjusted.
HDR(PQ) Gamma Setting*	-2 to 0 to +2	

#### NOTE

\*Not selectable depending on INPUT or AV mode.

# Contents

1. Part Names
2. Basic Operation
3. Menu Operation
  1. How to Use Menu
  2. How to Use Setup Menu
  3. List of Setup Menu Items
44. How to Use Application Menu
45. Entering Letters (Software Keyboard)
4. USB Media
5. Connecting Other Devices
6. Operating the Monitor Using a PC (IP control)
7. Troubleshooting
8. Specifications, etc.

Ver. 1.00



## Menu Operation



### List of Setup Menu Items

#### Advanced (Continue)

#### Film dejudder<sup>\*1\*2\*3\*4\*5</sup>

- Intended to play back videos, such such as films on a DVD, whose original signal is 24 images per second at high image quality.

#### Noise Reduction<sup>\*1\*4\*5</sup>

- This function reduces the noise in the video, smoothing the video.

Menu item name	Setup
Film dejudder	High smooth, Smooth, Off
Noise Reduction	Auto, High, Middle, Low, Off

#### NOTE

\*1 Not selectable depending on INPUT or AV mode.

\*2 This is not selectable at any time when the input signal is progressive (480p, 720p, 1080p, 2160p).

\*3 This is not selectable at any times when the input signal is PC signal.

\*4 Not selectable depending on the screen viewed.

\*5 The effect may not be available depending on the input signal type or video contents.

# Contents

1. Part Names
2. Basic Operation
3. Menu Operation
  1. How to Use Menu
  2. How to Use Setup Menu
  3. List of Setup Menu Items
44. How to Use Application Menu
45. Entering Letters (Software Keyboard)
4. USB Media
5. Connecting Other Devices
6. Operating the Monitor Using a PC (IP control)
7. Troubleshooting
8. Specifications, etc.

Ver. 1.00



## Menu Operation

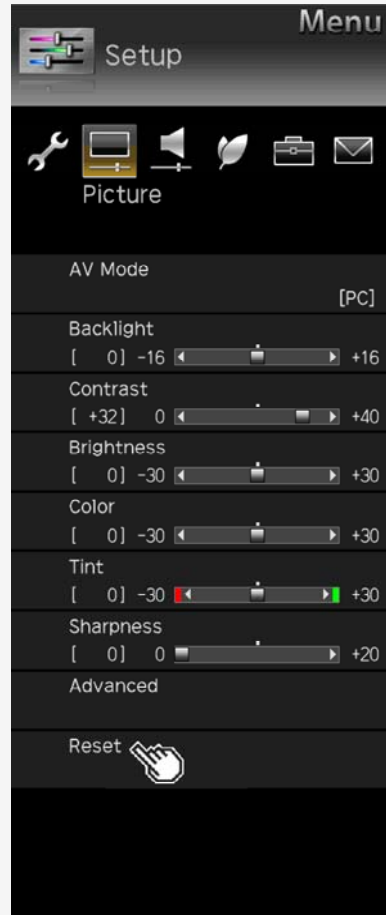

### List of Setup Menu Items

#### Reset

- Resets all video adjustments to factory defaults.

Setup

Yes, No

# Contents

1. Part Names
  2. Basic Operation
  3. Menu Operation
    1. How to Use Menu
    2. How to Use Setup Menu
    3. List of Setup Menu Items
  44. How to Use Application Menu
  45. Entering Letters (Software Keyboard)
4. USB Media
  5. Connecting Other Devices
  6. Operating the Monitor Using a PC (IP control)
  7. Troubleshooting
  8. Specifications, etc.

Ver. 1.00

## Menu Operation

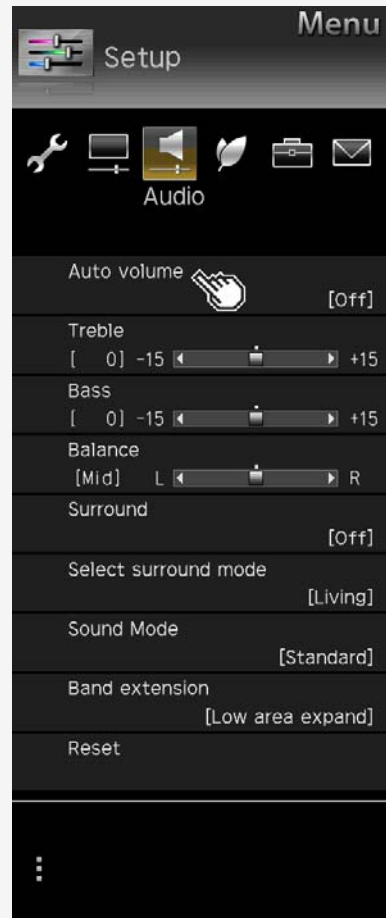

### List of Setup Menu Items

#### Auto volume

- If the volume level differs in the same input, you can set to adjust the volume automatically.

Setup	
<b>High</b>	Volume range will be kept very narrow.
<b>Middle</b>	Volume range will be kept narrow.
<b>Low</b>	Volume range will be kept slightly narrow.
<b>Off</b>	This function is disabled. Volume range will be kept as original.

#### NOTE

- If the **Clear voice** setup is set to "Standard", "Mild" or "Clear", **Auto volume** is automatically set and cannot be changed.
- This function works only for the audio sounds output from the Monitor's speakers. It does not work for any audio sounds from headphones or external speakers.
- This function may not be effective enough depending on the contents.

# Contents

1. Part Names
  2. Basic Operation
  3. Menu Operation
    1. How to Use Menu
    2. How to Use Setup Menu
    3. List of Setup Menu Items
  44. How to Use Application Menu
  45. Entering Letters (Software Keyboard)
4. USB Media
  5. Connecting Other Devices
  6. Operating the Monitor Using a PC (IP control)
  7. Troubleshooting
  8. Specifications, etc.

Ver. 1.00



## Menu Operation

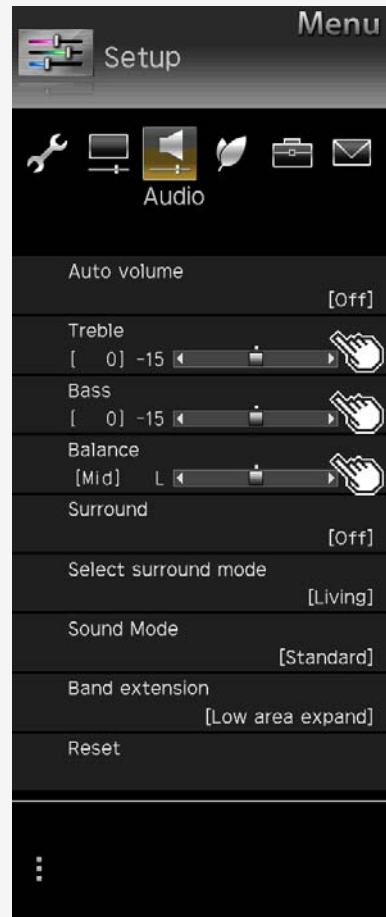

### List of Setup Menu Items

#### Treble

- You can adjust Treble

Setup

-15 to 0 to +15

#### Bass

- You can adjust Bass

Setup

-15 to 0 to +15

#### Balance

- You can adjust the balance of the speaker volume for both left and right.

Setup

L30 to Mid to R30

# Contents

1. Part Names
2. Basic Operation
3. Menu Operation
  1. How to Use Menu
  2. How to Use Setup Menu
  3. List of Setup Menu Items
44. How to Use Application Menu
45. Entering Letters (Software Keyboard)
4. USB Media
5. Connecting Other Devices
6. Operating the Monitor Using a PC (IP control)
7. Troubleshooting
8. Specifications, etc.

Ver. 1.00



## Menu Operation

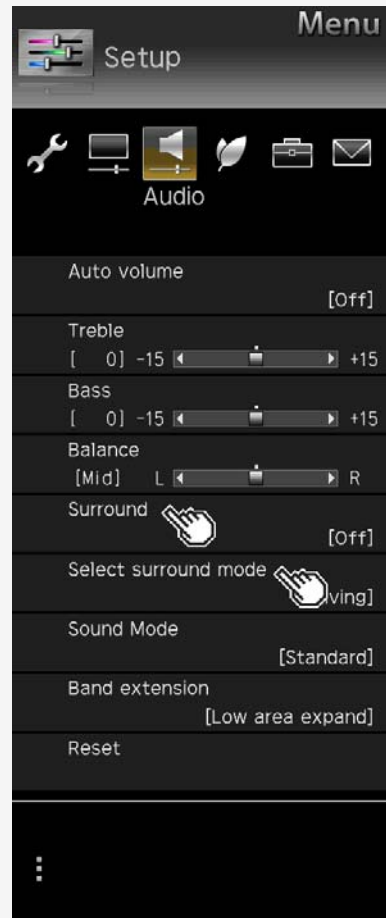

### List of Setup Menu Items

#### Surround

- Recreates an environment where audio appears to come from all directions via the built-in speakers.

Setup

Auto, On, Off

#### Select surround mode

- Select the mode when surround setting is enabled.

Setup

Living	Enjoy three dimensional sound.
Theater	Enjoy realistic sound like a theater.
3D Hall	Enjoy sound surrounding like a hall.

# Contents

1. Part Names
2. Basic Operation
3. Menu Operation
  1. How to Use Menu
  2. How to Use Setup Menu
  3. List of Setup Menu Items
44. How to Use Application Menu
45. Entering Letters (Software Keyboard)
4. USB Media
5. Connecting Other Devices
6. Operating the Monitor Using a PC (IP control)
7. Troubleshooting
8. Specifications, etc.

Ver. 1.00



## Menu Operation

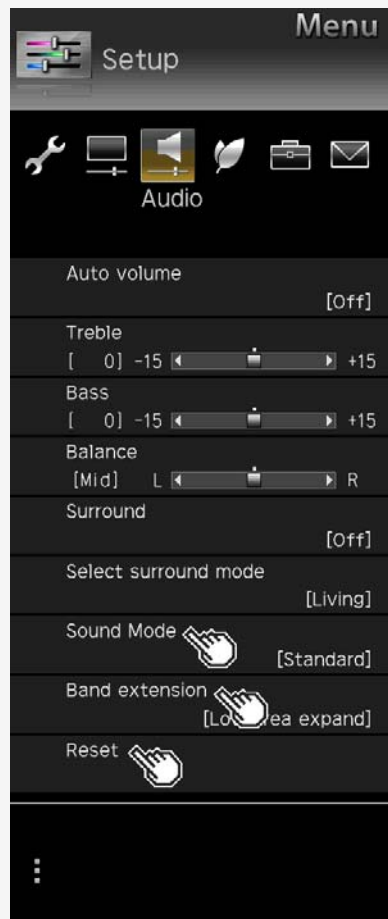

### List of Setup Menu Items

#### Sound Mode

- This function enables you to set the sound quality of the AV mode selected.

Setup	
Standard	Standard setting.
Dynamic	Dynamic sound setting.

#### Band extension

- Expands band area.

Setup	
Low + high area, Low area, No	

#### Reset

- Resets the audio adjustment settings to factory defaults

Setup	
Yes, No	



# Contents

1.	Part Names
2.	Basic Operation
3.	Menu Operation
1.	How to Use Menu
2.	How to Use Setup Menu
3.	List of Setup Menu Items
44.	How to Use Application Menu
45.	Entering Letters (Software Keyboard)
4.	USB Media
5.	Connecting Other Devices
6.	Operating the Monitor Using a PC (IP control)
7.	Troubleshooting
8.	Specifications, etc.

Ver. 1.00



## Menu Operation

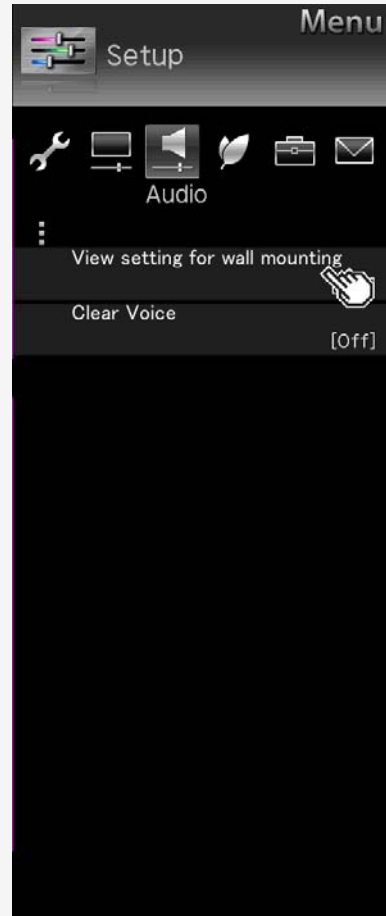

### List of Setup Menu Items

#### View setting for wall mounting

- This function is intended to set the sound quality suitable for the wall mount.

Menu item name	Setup
View setting for wall mounting	Yes, No

#### NOTE

- View setting for wall mounting** is intended to set the sound of Monitor typically mounted on wall; however, this setting may not be applicable depending on the wall material quality or the setting conditions. In such a case, from the Menu, adjust "**Setup**" - "**Audio**".
- If **Clear voice** is set to "**Standard**", "**Mild**" or "**Clear**", the view setting is not selectable.
- This function works only for the audio sounds output from the Monitor's speakers. It does not work for any audio sounds from headphones or external speakers.

# Contents

1. Part Names
2. Basic Operation
3. Menu Operation
  1. How to Use Menu
  2. How to Use Setup Menu
  3. List of Setup Menu Items
44. How to Use Application Menu
45. Entering Letters (Software Keyboard)
4. USB Media
5. Connecting Other Devices
6. Operating the Monitor Using a PC (IP control)
7. Troubleshooting
8. Specifications, etc.

Ver. 1.00



## Menu Operation

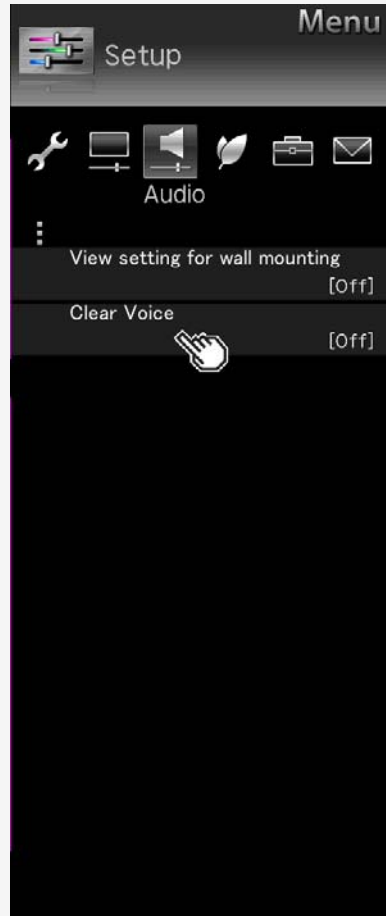

### List of Setup Menu Items

#### Clear voice

- When it is difficult to hear the dialog of a drama or a movie, this setting makes it easier to hear and understand by emphasizing the human voice range.

Setup	
<b>Standard</b>	This audio setting sets the audio volume to that of the standard sound quality.
<b>Mild</b>	It makes sound quality milder than the standard. Making it easier to listen to dialog by decreasing sounds effect and noise other than the lines.
<b>Clear</b>	It makes sound quality clearer than the Standard. Making it easier to hear and understand by clearing the speech quality of the spoken dialog.
<b>Off</b>	This function is disabled. (factory default)

#### NOTE

- This function works only for the audio sounds output from the Monitor's speakers. It does not work for any audio sounds from headphones or external speakers.

# Contents

1. Part Names
2. Basic Operation
3. Menu Operation
  1. How to Use Menu
  2. How to Use Setup Menu
  3. List of Setup Menu Items
  44. How to Use Application Menu
  45. Entering Letters (Software Keyboard)
4. USB Media
5. Connecting Other Devices
6. Operating the Monitor Using a PC (IP control)
7. Troubleshooting
8. Specifications, etc.

Ver. 1.00



## Menu Operation

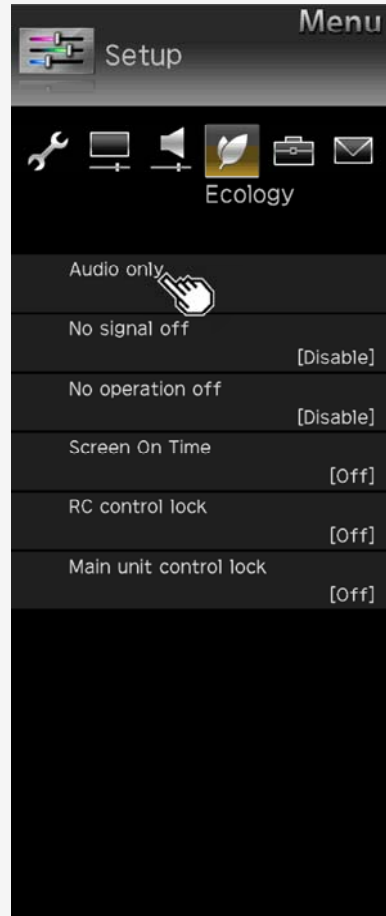

### List of Setup Menu Items

#### Audio only

- You can hear only audio sound with no video playing.

Setup

On, Off

#### NOTE

- It is automatically set to "Off" if you operate to restore video or turn the power off once.

To restore video

- Perform operations other than "Volume adjustment" or "Mute".

# Contents

1. Part Names
2. Basic Operation
3. Menu Operation
  1. How to Use Menu
  2. How to Use Setup Menu
  3. List of Setup Menu Items
44. How to Use Application Menu
45. Entering Letters (Software Keyboard)
4. USB Media
5. Connecting Other Devices
6. Operating the Monitor Using a PC (IP control)
7. Troubleshooting
8. Specifications, etc.

Ver. 1.00



## Menu Operation

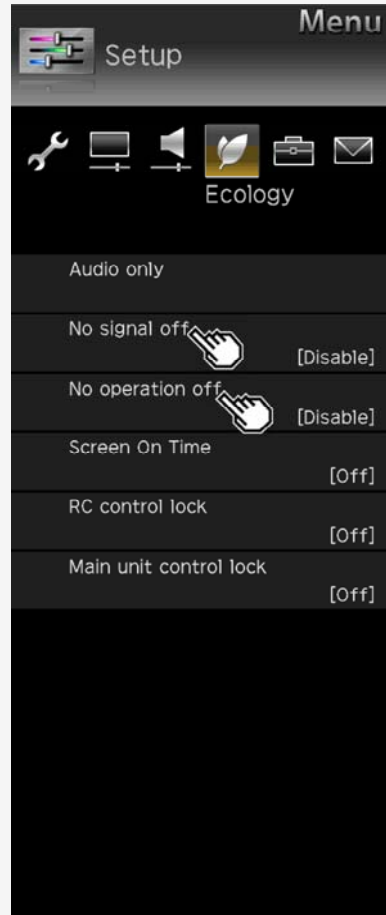

### List of Setup Menu Items

#### No signal off

- Enter standby automatically if no signal is received for 10min.

Setup

Enable, Disable

#### No operation off

- Enter standby automatically if no operation occurs for a preset period.

Setup

Disable, 0hr.30min., 1hr.00min., 2hr.00min., 4hr.00min.

# Contents

1. Part Names
2. Basic Operation
3. Menu Operation
  1. How to Use Menu
  2. How to Use Setup Menu
  3. List of Setup Menu Items
44. How to Use Application Menu
45. Entering Letters (Software Keyboard)
4. USB Media
5. Connecting Other Devices
6. Operating the Monitor Using a PC (IP control)
7. Troubleshooting
8. Specifications, etc.

Ver. 1.00



## Menu Operation

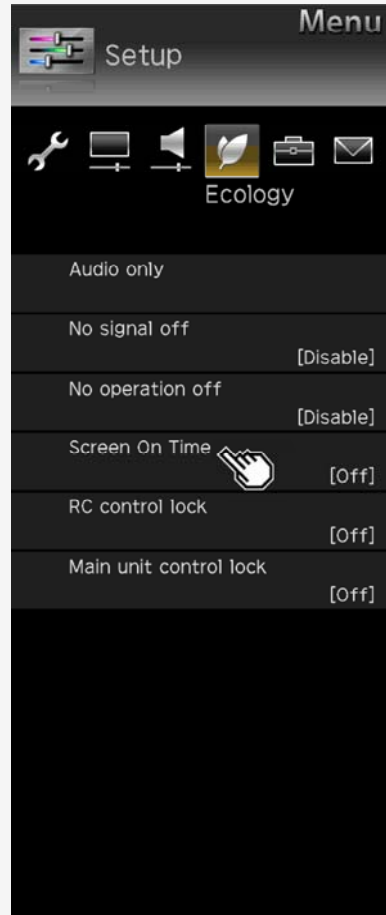

### List of Setup Menu Items

#### Screen On Time

- It is a function that displays the play time every 30 minutes to prevent her / him from losing track of time playing games
- It is displayed when the input is changed to INPUT1 to INPUT6.

Setup
On, Off

# Contents

1.	Part Names
2.	Basic Operation
3.	Menu Operation
1.	How to Use Menu
2.	How to Use Setup Menu
3.	List of Setup Menu Items
44.	How to Use Application Menu
45.	Entering Letters (Software Keyboard)
4.	USB Media
5.	Connecting Other Devices
6.	Operating the Monitor Using a PC (IP control)
7.	Troubleshooting
8.	Specifications, etc.

Ver. 1.00



## Menu Operation

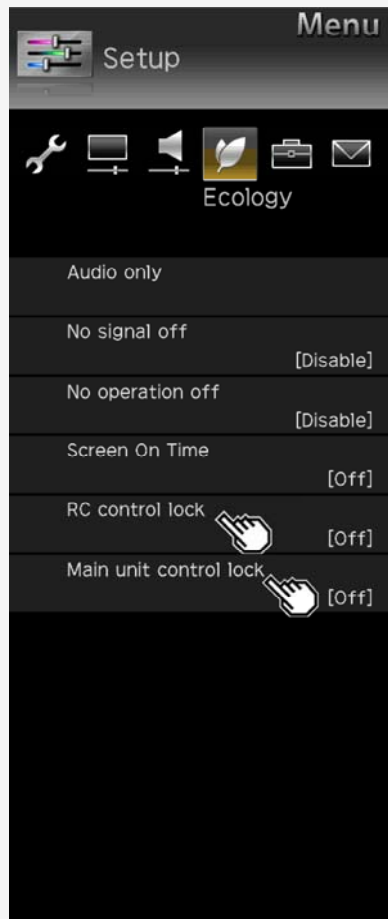

### List of Setup Menu Items

#### RC control lock

- You can lock the operation of the remote control.

Setup

Off, Lock, Lock except power, Lock except volume

#### NOTE

- To release the lock, press **FUNCTION**, **▲**, **▼**, **◀** and **▶** on the remote control unit in this sequence.

#### Main unit control lock

- You can lock the operation of the control buttons of the monitor.

Setup

Off, Lock

#### NOTE

- To release the lock, press **FUNCTION**, **▲**, **▼**, **◀** and **▶** on the remote control unit in this sequence.

# Contents

1. Part Names
2. Basic Operation
3. Menu Operation
  1. How to Use Menu
  2. How to Use Setup Menu
  3. List of Setup Menu Items
44. How to Use Application Menu
45. Entering Letters (Software Keyboard)
4. USB Media
5. Connecting Other Devices
6. Operating the Monitor Using a PC (IP control)
7. Troubleshooting
8. Specifications, etc.

Ver. 1.00



## Menu Operation

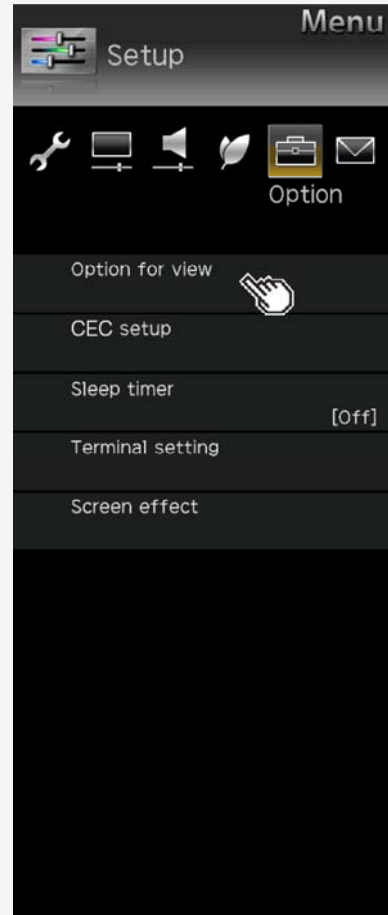

### List of Setup Menu Items

#### Option for view

Menu item name

<b>Multi-audio</b>	When a program has multiple audio channels, you can switch between the audio channels.
--------------------	--

# Contents

1. Part Names
2. Basic Operation
3. Menu Operation
  1. How to Use Menu
  2. How to Use Setup Menu
  3. List of Setup Menu Items
44. How to Use Application Menu
45. Entering Letters (Software Keyboard)
4. USB Media
5. Connecting Other Devices
6. Operating the Monitor Using a PC (IP control)
7. Troubleshooting
8. Specifications, etc.

Ver. 1.00



## Menu Operation

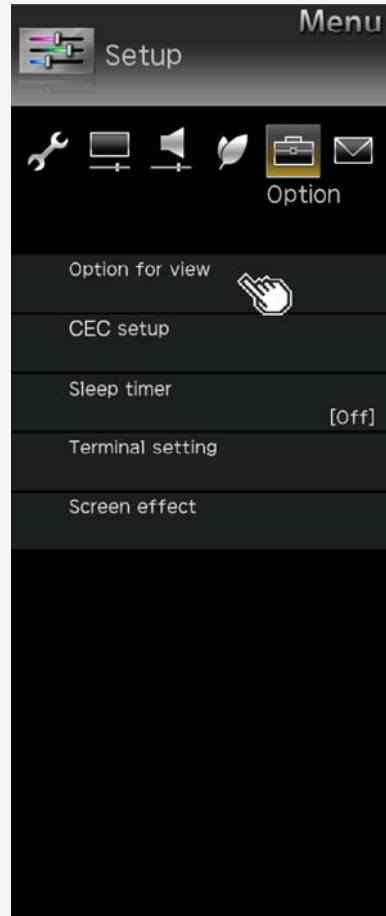

### List of Setup Menu Items

#### Option for view (Continue)

Menu item name	
<b>Wide mode</b>	Depending on the type of content, the black borders around the monitor can be removed by changing the horizontal or vertical width in the " <b>Wide Mode</b> " setting. This operation can also be performed from the Application. (page <a href="#">3-44</a> ) (For information on changing the screen size, see page <a href="#">5-25</a> .)

About "Screen size"

- While displaying images from USB memory, the screen size cannot be changed.



# Contents

1. Part Names
2. Basic Operation
3. Menu Operation
  1. How to Use Menu
  2. How to Use Setup Menu
  3. List of Setup Menu Items
  44. How to Use Application Menu
  45. Entering Letters (Software Keyboard)
4. USB Media
5. Connecting Other Devices
6. Operating the Monitor Using a PC (IP control)
7. Troubleshooting
8. Specifications, etc.

Ver. 1.00



## Menu Operation

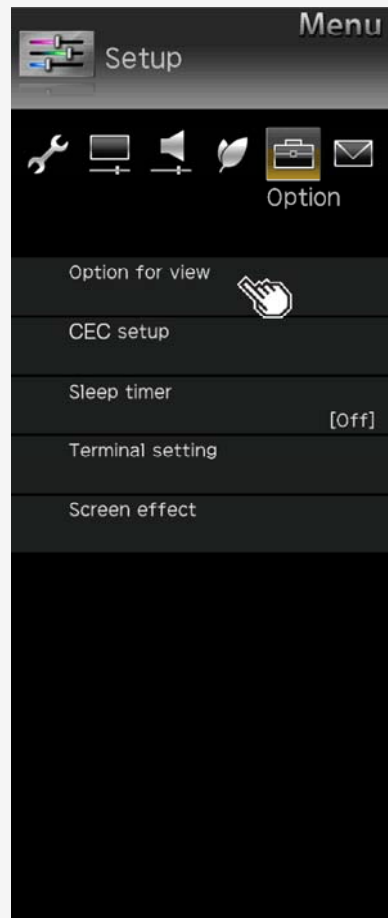

### List of Setup Menu Items

#### Option for view (Continue)

Menu item name	
CEC control	Enables operation of an HDMI CEC device.
Manual	Displays the built-in Operation Manual.

#### NOTE

\*This is not selectable while the manual is displayed. Exit the manual before selecting this.

# Contents

- 1. Part Names
- 2. Basic Operation
- 3. Menu Operation
  - 1. How to Use Menu
  - 2. How to Use Setup Menu
  - 3. List of Setup Menu Items
- 44. How to Use Application Menu
- 45. Entering Letters (Software Keyboard)
- 4. USB Media
- 5. Connecting Other Devices
- 6. Operating the Monitor Using a PC (IP control)
- 7. Troubleshooting
- 8. Specifications, etc.

Ver. 1.00

## Menu Operation

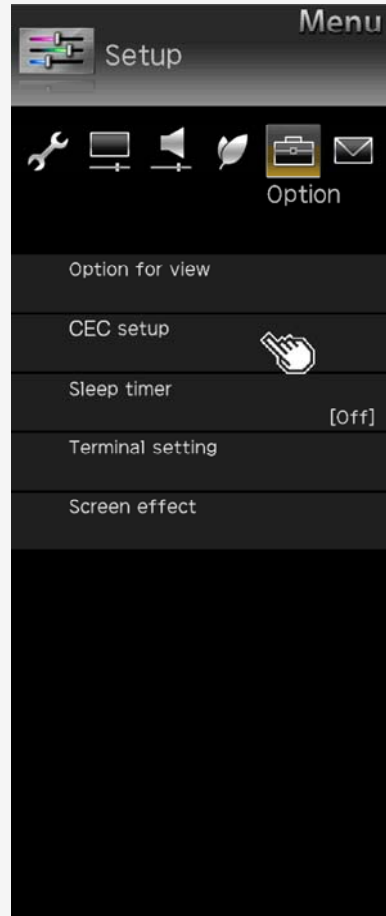

### List of Setup Menu Items

#### CEC setup

Menu item name	Setup	
CEC control	On, Off	Set it to "Off" if the power supply is turned on or the channel changes automatically when connecting a device that is not HDMI CEC enabled.
Auto power on	Yes, No	Set it to turn on automatically once an HDMI CEC-enable device is operated.
Selecting channel key	INPUT1	Auto, On, Off
	INPUT2	Auto, On, Off
	INPUT3	Auto, On, Off
	INPUT4	Auto, On, Off
	INPUT7	Auto, On, Off
INPUT8	Auto, On, Off	
Audio return channel	Auto, Off	"ARC (Audio Return Channel)" is the function to transmit sound from the monitor to the AV amplifier, etc. using an HDMI cable. If you set "Audio return channel" to "Auto", you can connect to an ARC compatible audio device with a HDMI cable. This function is available only when it is connected to INPUT 2 terminal.

You can also setup from the Application menu (page [3-44](#))

# Contents

1. Part Names
2. Basic Operation
3. Menu Operation
  1. How to Use Menu
  2. How to Use Setup Menu
  3. List of Setup Menu Items
  44. How to Use Application Menu
  45. Entering Letters (Software Keyboard)
4. USB Media
5. Connecting Other Devices
6. Operating the Monitor Using a PC (IP control)
7. Troubleshooting
8. Specifications, etc.

Ver. 1.00



## Menu Operation

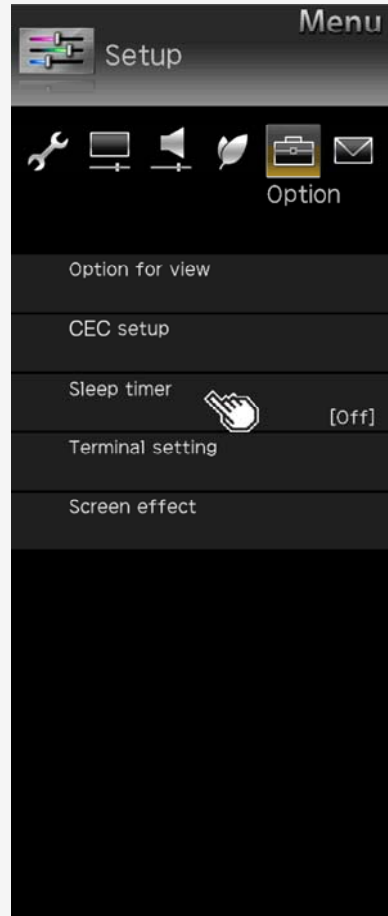

### List of Setup Menu Items

#### Sleep timer

- Turn the power off after the specified time has elapsed

Setup	
Change	Off, 0hr.30min., 1hr.00min., 1hr.30min., 2hr.00min., 2hr.30min.
No	

# Contents

1. Part Names
2. Basic Operation
3. Menu Operation
  1. How to Use Menu
  2. How to Use Setup Menu
  3. List of Setup Menu Items
44. How to Use Application Menu
45. Entering Letters (Software Keyboard)
4. USB Media
5. Connecting Other Devices
6. Operating the Monitor Using a PC (IP control)
7. Troubleshooting
8. Specifications, etc.

Ver. 1.00



## Menu Operation

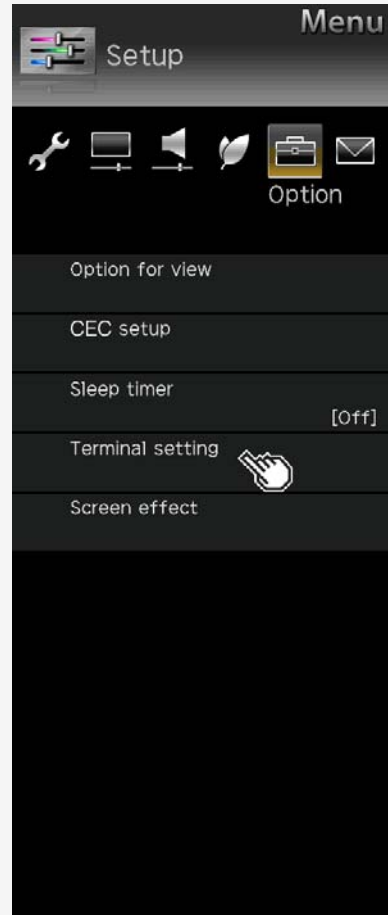

### List of Setup Menu Items

#### Terminal setting

##### Color gamut range<sup>\*1</sup>

- Sets color gamut range for INPUT7-A,B,C,D and INPUT8

Setup	
Auto	Selects color gamut range by automatic detection
BT.709	Sets to BT.709
BT.2020	Sets to BT.2020

#### NOTE

\*1 It is displayed when the input is changed to INPUT7 or 8.

##### HDR-SDR Switch<sup>\*2</sup>

- Sets dynamic range for INPUT7-A,B,C,D and INPUT8

Setup	
Auto	Selects dynamic range mode by automatic detection
HLG	Sets to HLG
PQ	Sets to PQ
SDR	Sets to SDR

#### NOTE

\*2 It is displayed when the input is changed to INPUT7 or 8.

##### Input range setting<sup>\*3</sup>

- Sets input range for INPUT7-A,B,C,D and INPUT8

Setup	
Auto	Selects input range mode by automatic detection
Full	Sets to Full mode
Limited	Sets to Limited mode

#### NOTE

\*3 It is displayed when the input is changed to INPUT7 or 8.

# Contents

1. Part Names
2. Basic Operation
3. Menu Operation
  1. How to Use Menu
  2. How to Use Setup Menu
  3. List of Setup Menu Items
44. How to Use Application Menu
45. Entering Letters (Software Keyboard)
4. USB Media
5. Connecting Other Devices
6. Operating the Monitor Using a PC (IP control)
7. Troubleshooting
8. Specifications, etc.

Ver. 1.00



## Menu Operation

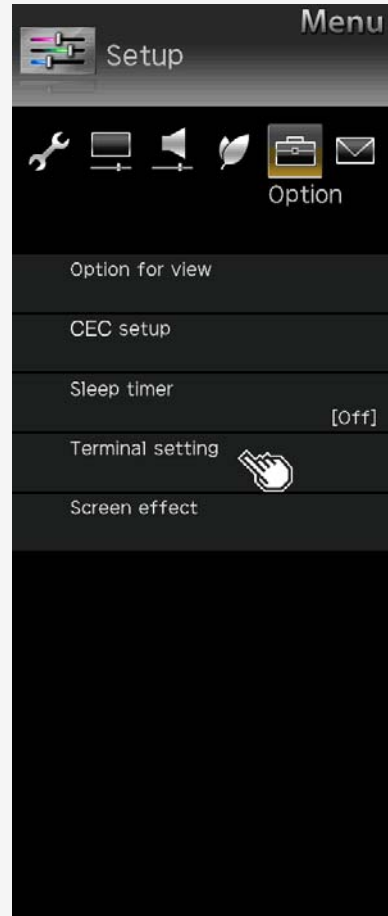

### List of Setup Menu Items

#### Terminal setting (Continue)

#### Headphone

- Switches the audio sound between speakers and headphones during the use of the headphones.

Menu item name	Setup	
Headphone	Mode1	This is intended to listen to the Monitor with the headphones alone. Once you connect the headphones, no sound will come out of the speakers.
	Mode2	Sound comes out of the speakers even after the headphones are connected. This is useful for two people with different needs (one having difficulty listening to the Monitor with the speakers alone and the other not wanting the volume of the speakers to be too loud) to enjoy watching the Monitor together.

#### NOTE

About volume adjustment during "Mode2"

- The speaker volume is adjusted by using the remote control.
- The headphone volume is adjusted by using the volume (+ / -) button on Monitor.
- Even if the **MUTE** button on the remote control is pressed, the volume of the headphones would not become "0".

# Contents

1. Part Names
2. Basic Operation
3. Menu Operation
  1. How to Use Menu
  2. How to Use Setup Menu
  3. List of Setup Menu Items
44. How to Use Application Menu
45. Entering Letters (Software Keyboard)
4. USB Media
5. Connecting Other Devices
6. Operating the Monitor Using a PC (IP control)
7. Troubleshooting
8. Specifications, etc.

Ver. 1.00



## Menu Operation

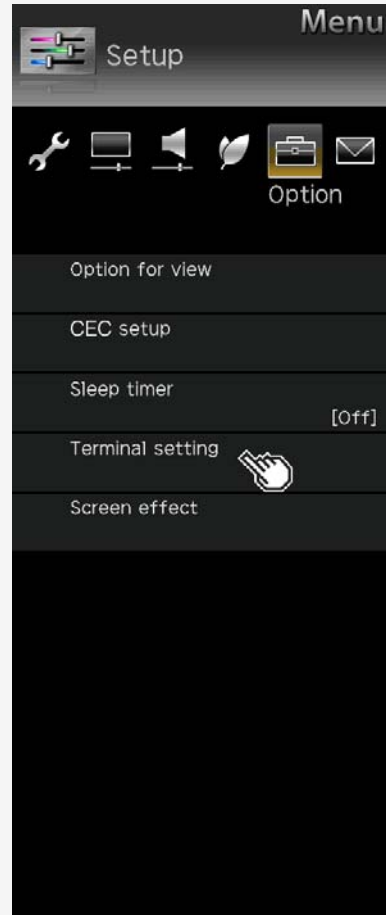

### List of Setup Menu Items

#### Terminal setting (Continue)

#### Analog Audio output setting

- Changes the analog audio output setting.

#### INPUT1 audio setting<sup>\*1</sup>

- Switches the audio input terminal for INPUT 1.

#### INPUT6 audio setting<sup>\*2</sup>

- Sets the audio input for INPUT 6.

Menu item name	Setup		
Analog Audio output setting	Mode1	On, Off	Set to the audio output (fixed). Sounds also come out of the speakers.
	Mode2	On, Off	Set to the audio output (variable). Normally, no sounds come out of the speakers.
	Mode3	On, Off	Set to the audio output (variable). Sounds also come out of the speakers.
INPUT1 audio setting	HDMI		Switches the audio input terminal for INPUT 1.
	Analog audio input		
INPUT6 audio setting	Analog audio input		Sets the audio input for INPUT 6.
	No		

#### NOTE

\*1 It is displayed when the input is changed to INPUT1.

\*2 It is displayed when the input is changed to INPUT6.

# Contents

1. Part Names
2. Basic Operation
3. Menu Operation
  1. How to Use Menu
  2. How to Use Setup Menu
  3. List of Setup Menu Items
44. How to Use Application Menu
45. Entering Letters (Software Keyboard)
4. USB Media
5. Connecting Other Devices
6. Operating the Monitor Using a PC (IP control)
7. Troubleshooting
8. Specifications, etc.

Ver. 1.00

## Menu Operation

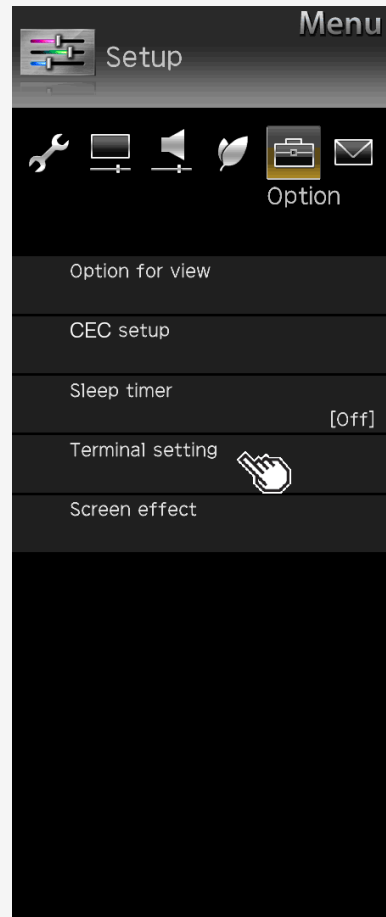

### List of Setup Menu Items

#### Terminal setting (Continue)

#### INPUT7 audio setting<sup>\*1</sup>

- Sets the audio input for INPUT 7.

#### INPUT8 audio setting<sup>\*2</sup>

- Switches the audio input terminal for INPUT 8.

#### Digital audio output<sup>\*3</sup>

- Sets the signal format for digital sound

Menu item name	Setup	
INPUT7 audio setting	INPUT7-A	Uses the INPUT7-A sound.
	INPUT7-B	Uses the INPUT7-B sound.
	INPUT7-C	Uses the INPUT7-C sound.
	INPUT7-D	Uses the INPUT7-D sound.
	Audio input terminal	Uses the Audio input terminal sound.
INPUT8 audio setting	HDMI	Switches the audio input terminal for INPUT 8.
	Analogue audio input	
Digital audio output	PCM	When connecting a device that does not support AAC / Dolby Digital, set it to "PCM" (page 5-14). The same sound (Main, sub, M/S) as the program which is being viewed will be the output.
	Bit Stream	To connect an amplifier that supports AAC / Dolby Digital, set it to "Bit Stream". Both the main and sub sound will be simultaneously output.

#### NOTE

\*1 It is displayed when the input is changed to INPUT7.

\*2 It is displayed when the input is changed to INPUT8.

\*3 It is displayed when the input is changed to INPUT1,2,3,4.

# Contents

1. Part Names
2. Basic Operation
3. Menu Operation
  1. How to Use Menu
  2. How to Use Setup Menu
  3. List of Setup Menu Items
44. How to Use Application Menu
45. Entering Letters (Software Keyboard)
4. USB Media
5. Connecting Other Devices
6. Operating the Monitor Using a PC (IP control)
7. Troubleshooting
8. Specifications, etc.

Ver. 1.00



## Menu Operation

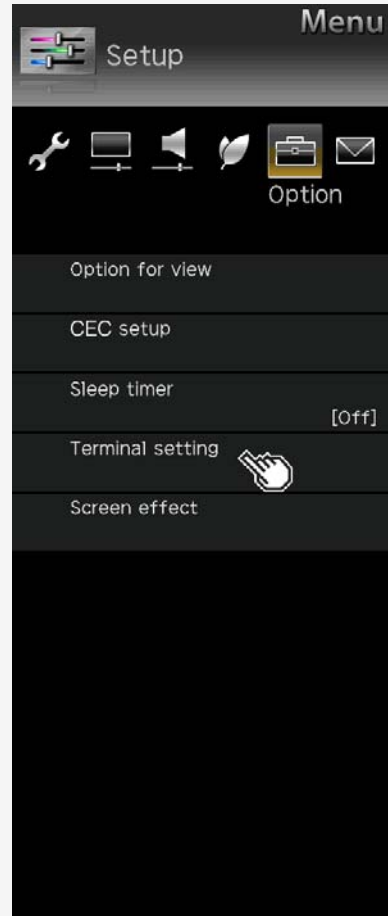

### List of Setup Menu Items

#### Terminal setting (Continue)

##### Input skip

- Unused inputs (INPUT1 to 4, INPUT6, INPUT7, INPUT8) can be skipped during input change.

Menu item name	Setup	
Input skip	INPUT1 (HDMI)	Yes, No
	INPUT2 (HDMI)	Yes, No
	INPUT3 (HDMI)	Yes, No
	INPUT4 (HDMI)	Yes, No
	INPUT6 (PC)	Yes, No
	INPUT7 (8K)	Yes, No
	INPUT8 (8K)	Yes, No

##### Input Signal info

- Displays details of the 8K input signal.  
It is displayed when the input is changed to INPUT7 or 8.



# Contents

1. Part Names
2. Basic Operation
3. Menu Operation
  1. How to Use Menu
  2. How to Use Setup Menu
  3. List of Setup Menu Items
  44. How to Use Application Menu
  45. Entering Letters (Software Keyboard)
4. USB Media
5. Connecting Other Devices
6. Operating the Monitor Using a PC (IP control)
7. Troubleshooting
8. Specifications, etc.

Ver. 1.00



## Menu Operation

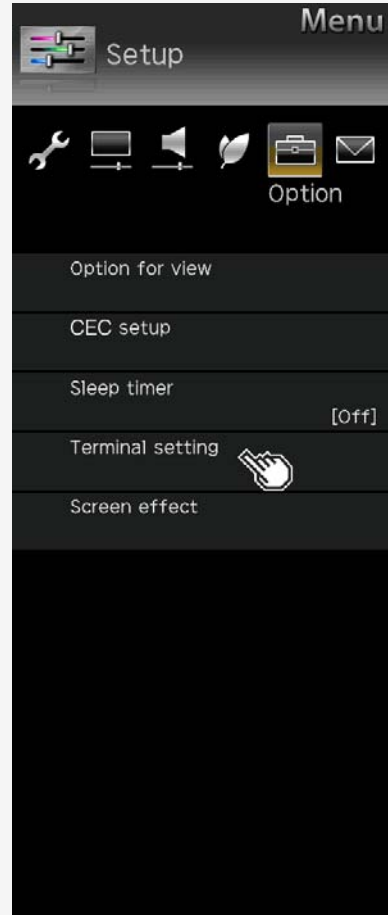

### List of Setup Menu Items

#### Terminal setting (Continue)

##### Input label

- The device names displayed in the input menu, etc. can be changed to the names of the devices connected to INPUT 1 to 8.

Menu item name	Setup
Input label <sup>*1</sup>	(Entry depends on selection) <b>User Setting: EDIT</b>

##### NOTE

\*1 It is displayed when the input is changed to INPUT1 to INPUT8.

# Contents

1. Part Names
  2. Basic Operation
  3. Menu Operation
    1. How to Use Menu
    2. How to Use Setup Menu
    3. List of Setup Menu Items
  44. How to Use Application Menu
  45. Entering Letters (Software Keyboard)
4. USB Media
  5. Connecting Other Devices
  6. Operating the Monitor Using a PC (IP control)
  7. Troubleshooting
  8. Specifications, etc.

Ver. 1.00



## Menu Operation

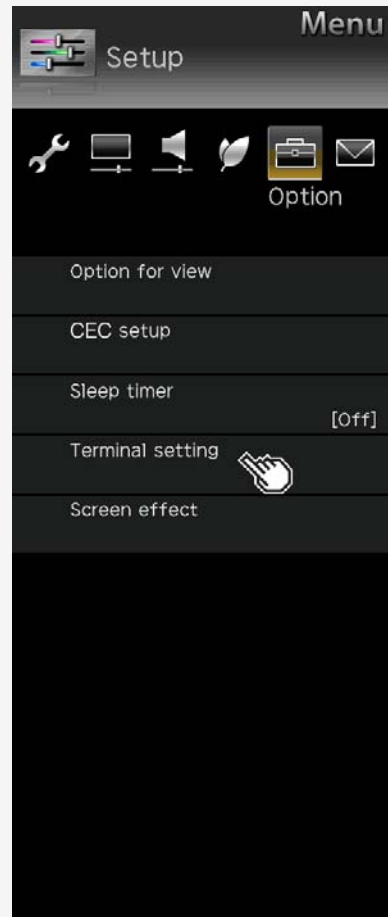

### List of Setup Menu Items

#### Terminal setting (Continue)

#### Suitable mode for signals

- Changes the suitable mode for signals in order to maintain compatibility with connected devices. (INPUT 1 only)

Menu item name	Setup	
Suitable mode for signals	<b>Full mode (HDR)</b>	The mode is intended for connected devices that provide support for the high definition (4:4:4/4:2:2) / wide color gamut (BT.2020) / high contrast (HDR) of 4K video.
	<b>Full mode</b>	The mode is intended for connected devices that provide support for the high definition (4:4:4/4:2:2) / wide color gamut (BT.2020) of 4K video.
	<b>Compatibility mode 1</b>	The mode is intended for connected devices that provide support for the high definition (4:4:4/4:2:2) of 4K video.
	<b>Compatibility mode 2</b>	The mode is intended to place high priority on compatibility with connected devices.

# Contents

1. Part Names
2. Basic Operation
3. Menu Operation
  1. How to Use Menu
  2. How to Use Setup Menu
  3. List of Setup Menu Items
44. How to Use Application Menu
45. Entering Letters (Software Keyboard)
4. USB Media
5. Connecting Other Devices
6. Operating the Monitor Using a PC (IP control)
7. Troubleshooting
8. Specifications, etc.

Ver. 1.00



## Menu Operation

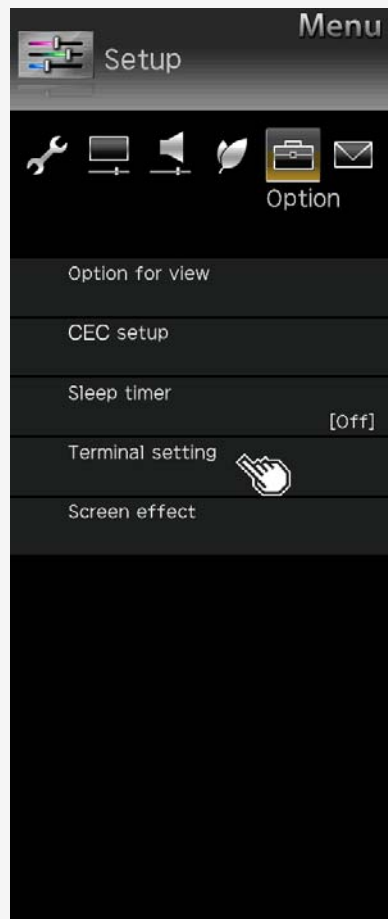

### List of Setup Menu Items

#### Terminal setting (Continue)

##### PC input

- Set the analog RGB input.
- It is displayed when the input is changed to INPUT6.

##### Input Signal

- Set the resolution of video input signal.

Menu item name	Setup
Input Signal	Auto, 1024 x 768, 1366 x 768

##### Auto sync.

- Adjust the screen automatically. (Adjustment may not be possible depending on the input signal.)

Menu item name	Setup
Auto sync.	Yes, No

##### Fine sync.

- Adjust the screen manually.

Menu item name	Setup	
Fine sync.	H-Pos.	Adjust the horizontal position of the image.
	V-Pos.	Adjust the vertical position of the image.
	Clock	Adjust when there is flickering in the form of vertical stripes.
	Phase	Useful when small characters appear with low contrast and/or there are flickers at corners.
	Reset	Resets to factory default.

# Contents

1. Part Names
  2. Basic Operation
  3. Menu Operation
    1. How to Use Menu
    2. How to Use Setup Menu
    3. List of Setup Menu Items
  44. How to Use Application Menu
  45. Entering Letters (Software Keyboard)
4. USB Media
  5. Connecting Other Devices
  6. Operating the Monitor Using a PC (IP control)
  7. Troubleshooting
  8. Specifications, etc.

Ver. 1.00



## Menu Operation

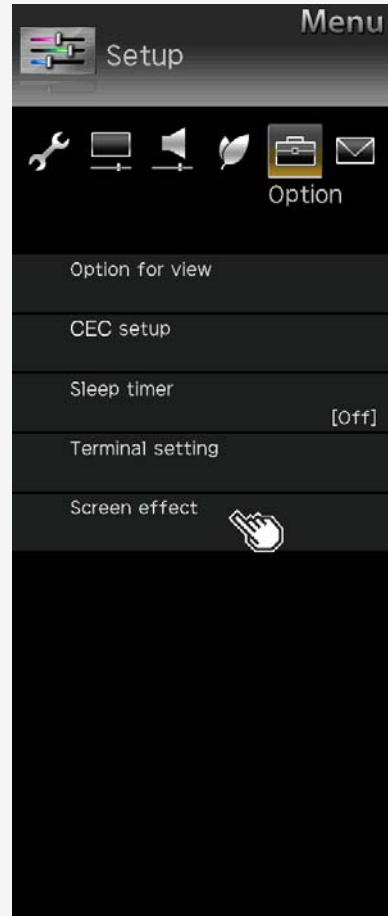

### List of Setup Menu Items

#### Screen effect

Menu item name		Setup
Position	H-Pos.	Adjusts the position of a left-aligned or right-aligned image using  button.
	V-Pos.	Adjusts the position of an image positioned too high or low using  button.
	Reset	Resets to factory default.

# Contents

- 1. Part Names
- 2. Basic Operation
- 3. Menu Operation
  - 1. How to Use Menu
  - 2. How to Use Setup Menu
  - 3. List of Setup Menu Items
- 44. How to Use Application Menu
- 45. Entering Letters (Software Keyboard)
- 4. USB Media
- 5. Connecting Other Devices
- 6. Operating the Monitor Using a PC (IP control)
- 7. Troubleshooting
- 8. Specifications, etc.

Ver. 1.00



## Menu Operation

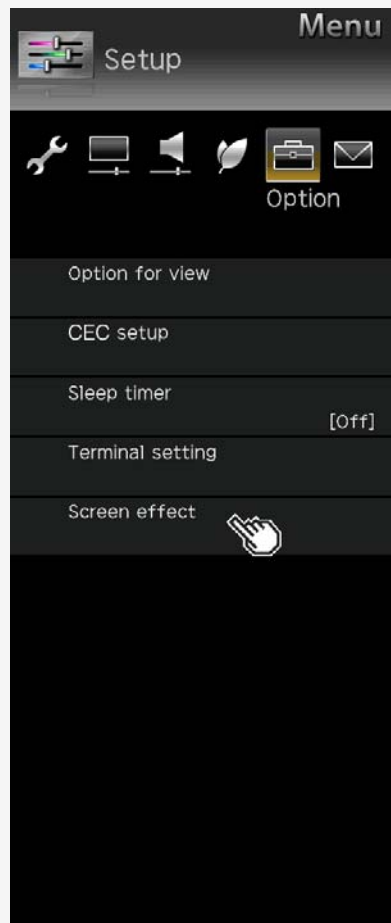

### List of Setup Menu Items

#### Screen effect (Continue)

##### Auto Wide

- According to the type of original video, you can display the video on the screen of the size most suitable for the video.

Menu item name		Setup	
Auto Wide	Auto Mode	Yes, No	In the presence of black curtains / bars at the top and bottom of the video (screen) input from INPUT1 to 5, the screen size will be automatically switched to "Zoom".
	HDMI Signal	Enable, Disable	If any screen size control signal is included in a video input from INPUT1 to 4, the screen size will be automatically optimized.

# Contents

1. Part Names
  2. Basic Operation
  3. Menu Operation
    1. How to Use Menu
    2. How to Use Setup Menu
    3. List of Setup Menu Items
  44. How to Use Application Menu
  45. Entering Letters (Software Keyboard)
4. USB Media
  5. Connecting Other Devices
  6. Operating the Monitor Using a PC (IP control)
  7. Troubleshooting
  8. Specifications, etc.

Ver. 1.00



## Menu Operation

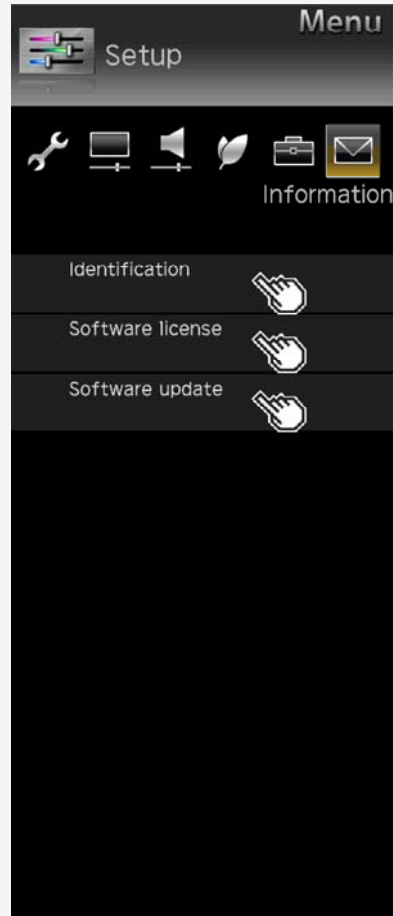

### List of Setup Menu Items

#### Identification

- Displays the system status

Setup

**Start, Test pattern**

#### Software license

- Displays software licenses

#### Software update

#### USB update

- Updates software.

#### Import ICC

- Import ICC profile data.  
For the ICC profile, consult your authorized SHARP dealer.

Menu item name	Setup
<b>USB update</b>	Check
	Back
<b>Import ICC</b>	Yes
	No

# Contents

1. Part Names
2. Basic Operation
3. Menu Operation
  1. How to Use Menu
  2. How to Use Setup Menu
  3. List of Setup Menu Items
  44. How to Use Application Menu
  45. Entering Letters (Software Keyboard)
4. USB Media
5. Connecting Other Devices
6. Operating the Monitor Using a PC (IP control)
7. Troubleshooting
8. Specifications, etc.

Ver. 1.00



## Menu Operation

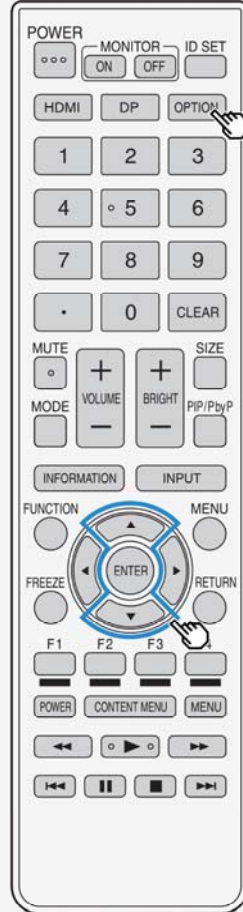

### How to Use Application Menu

Basic procedure for using the Application

1. Press **OPTION** to display the Application.
  - You can also use the Application menu by selecting "**Application**" of the Menu item.
2. Press **▲▼** to select a desired item, and then press **ENTER**
  - You can also select an item by using a number button on the remote control.
3. Press **▲▼** to select another desired item, and then press **ENTER**
  - Depending on the item selected, you may have to make further item selections.

#### NOTE

- The items in the Application menu vary depending on the currently-displayed screen

# Contents

1. Part Names
2. Basic Operation
3. Menu Operation
  1. How to Use Menu
  2. How to Use Setup Menu
  3. List of Setup Menu Items
  44. How to Use Application Menu
  45. Entering Letters (Software Keyboard)
4. USB Media
5. Connecting Other Devices
6. Operating the Monitor Using a PC (IP control)
7. Troubleshooting
8. Specifications, etc.

Ver. 1.00

## Menu Operation

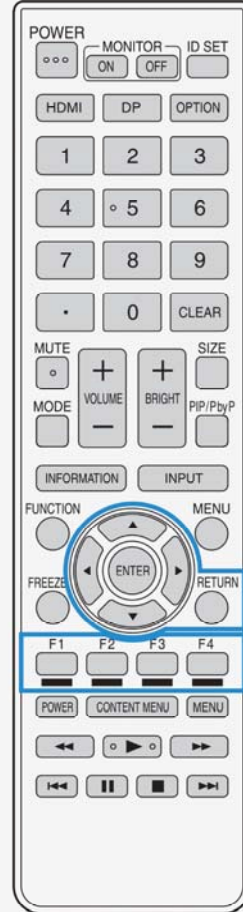

### Entering Letters (Software Keyboard)

- If you are required to enter letters, use on-screen software keyboard for entry.
- The software keyboard will be displayed if you select an entry field and press **ENTER**.

Software keyboard screen example

You can select any letter or function with the **▲/▼/◀/▶** and **ENTER** buttons. The functions with button name, such as "Complete" can be directly selected with the buttons on the remote control.



**Character type**  
Selectable characters depend on the entry field.

**Characters that can be entered**  
The characters that can be entered vary depending on the character type or the entry field.



# Contents

1. Part Names
2. Basic Operation
3. Menu Operation
4. USB Media
  1. Before Using USB Media
  7. Enjoying Photo
  21. Enjoying Music
  24. Enjoying Video
5. Connecting Other Devices
6. Operating the Monitor Using a PC (IP control)
7. Troubleshooting
8. Specifications, etc.

Ver. 1.00



## USB Media

### Before Using USB Media

What you can do with USB Media

- You can play the photo, music or video files stored on USB memory. In addition, you can copy photos to a USB memory .

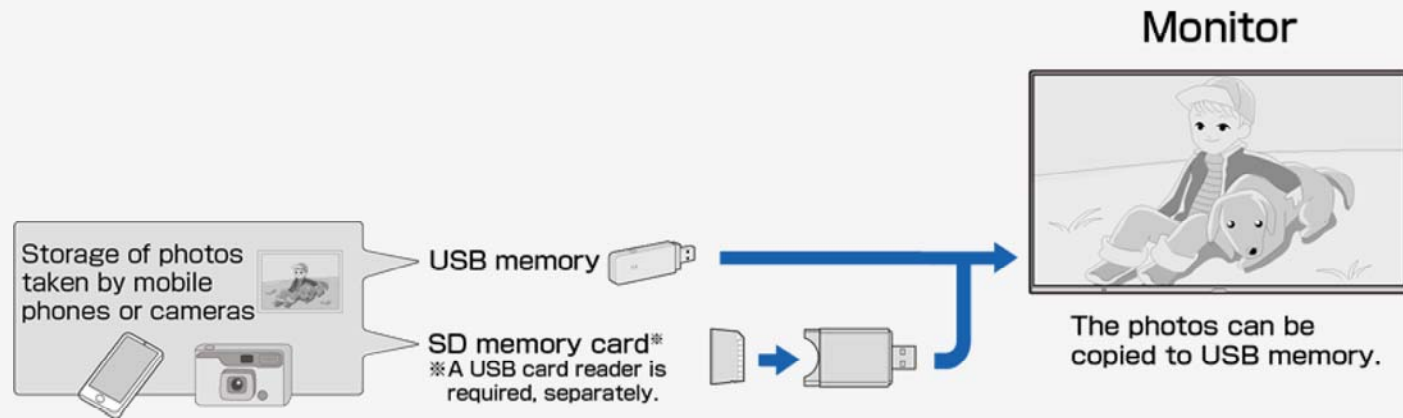

# Contents

- 1. Part Names
- 2. Basic Operation
- 3. Menu Operation
- 4. USB Media
  - 1. Before Using USB Media
  - 7. Enjoying Photo
  - 21. Enjoying Music
  - 24. Enjoying Video
- 5. Connecting Other Devices
- 6. Operating the Monitor Using a PC (IP control)
- 7. Troubleshooting
- 8. Specifications, etc.

Ver. 1.00



## USB Media

### Before Using USB Media

About USB memories that can be attached to Monitor

Devices that can be connected to USB terminal

- USB memory, USB card reader (mass storage class)

File system

- FAT, FAT32

#### NOTE

- If you attach a USB memory to Monitor with the power on, the USB Media will be displayed.

# Contents

1.	Part Names
2.	Basic Operation
3.	Menu Operation
4.	USB Media
1.	Before Using USB Media
7.	Enjoying Photo
21.	Enjoying Music
24.	Enjoying Video
5.	Connecting Other Devices
6.	Operating the Monitor Using a PC (IP control)
7.	Troubleshooting
8.	Specifications, etc.

Ver. 1.00



## USB Media

### Before Using USB Media

#### About USB memories attached to Monitor

##### How to attach / remove USB memory

- Do not remove the USB memory from Monitor while transferring files, viewing slide shows, switching screens or before exiting "**USB Media**" at the input selection menu.
- Do not insert and remove a USB memory repeatedly without any reason.
- When using a USB card reader, make sure to insert a memory card in the USB card reader before connecting it to the Monitor.
- Do not use any USB extension cable to connect USB memory into the USB terminal on the Monitor. The Monitor may fail to operate properly if you do so.
- Turn off the Monitor before removing the USB memory.

# Contents

- 1. Part Names
- 2. Basic Operation
- 3. Menu Operation
- 4. USB Media
  - 1. Before Using USB Media
  - 7. Enjoying Photo
  - 21. Enjoying Music
  - 24. Enjoying Video
- 5. Connecting Other Devices
- 6. Operating the Monitor Using a PC (IP control)
- 7. Troubleshooting
- 8. Specifications, etc.

Ver. 1.00



## USB Media

### Before Using USB Media

About files in USB memory that can be played on Monitor

Photo file format

- JPEG (jpg) (DCF2.0-compliant)
- Maximum resolution (image size): 16384 x 16384 pixels
- Minimum resolution (image size): 32 x 32 pixels
- If a JPEG still image file is large in size, the file may require time to display the photo.

# Contents

1.	Part Names
2.	Basic Operation
3.	Menu Operation
4.	USB Media
1.	Before Using USB Media
7.	Enjoying Photo
21.	Enjoying Music
24.	Enjoying Video
5.	Connecting Other Devices
6.	Operating the Monitor Using a PC (IP control)
7.	Troubleshooting
8.	Specifications, etc.

Ver. 1.00



## USB Media

### Before Using USB Media

About files in USB memory that can be played on Monitor

Music file format

- FLAC (.fla)  
Bit rate: 128k to 2304kbps  
Sampling frequency: 8k, 16k, 22.05k, 24k, 32k, 44.1k, 48k, 88.2k, 96k, 192kHz  
Quantization bit rate: 8bit, 16bit, 24bit
- MP3 (.mp3)  
Bit rate: 32 to 320kbps  
Sampling frequency: 32k, 44.1k, 48kHz
- WAV (.wav)  
Bit rate: 64 to 1536kbps (LPCM)  
Sampling frequency: 32k, 44.1k, 48kHz
- WMA (.wma)  
Bit rate: 32 to 384kbps  
Sampling frequency: 8k, 11.025k, 16k, 22.05k, 32k, 44.1k, 48kHz
- AAC (.m4a / .aac)  
Bit rate: 1 to 1728kbps  
Sampling frequency:  
8k, 11.025k, 12k, 16k, 22.05k, 24k, 32k, 44.1k, 48kHz (AAC)  
16k, 22.05k, 24k, 32k, 44.1k, 48kHz (HE-AAC)

# Contents

- 1. Part Names
- 2. Basic Operation
- 3. Menu Operation
- 4. USB Media
  - 1. Before Using USB Media
  - 7. Enjoying Photo
  - 21. Enjoying Music
  - 24. Enjoying Video
- 5. Connecting Other Devices
- 6. Operating the Monitor Using a PC (IP control)
- 7. Troubleshooting
- 8. Specifications, etc.

Ver. 1.00



## USB Media

### Before Using USB Media

About files in USB memory that can be played on Monitor

Video file format

- m2ts, mp4, 3gp (AVC, H.264/MP3, AAC)

#### NOTE

- jpeg files in progressive format cannot be supported.
- 3D-form photos cannot be supported.
- Music files in USB1.1 device may not be played properly.
- Depending on a certain type of USB memory devices, the stored data may not be recognized in Monitor.
- The file name may not be displayed if length of the file name exceeds 80 characters.
- Files may not be played properly even if their file format is supported.
- Music files which are subject to copyright protection may not be played properly.

# Contents

- 1. Part Names
- 2. Basic Operation
- 3. Menu Operation
- 4. USB Media
  - 1. Before Using USB Media
  - 7. Enjoying Photo
  - 21. Enjoying Music
  - 24. Enjoying Video
- 5. Connecting Other Devices
- 6. Operating the Monitor Using a PC (IP control)
- 7. Troubleshooting
- 8. Specifications, etc.

Ver. 1.00



## USB Media

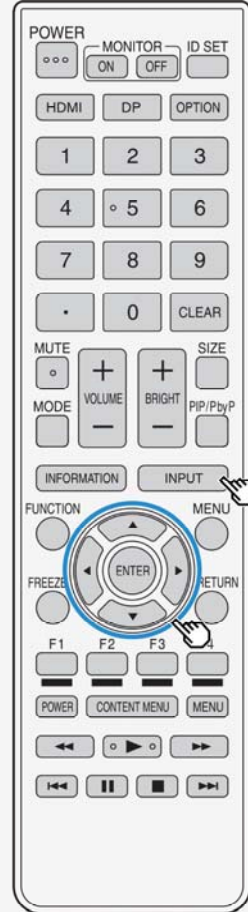

### Enjoying Photo

#### Displaying photo

#### About this function

- You can display photos on USB memory.

#### NOTE

- It may take more than 20 seconds to display a photo depending on the pixel size.

#### How to operate

1. Press **INPUT**, use the **▲/▼** button to select "**USB media**", and then press **ENTER**
- Once USB memory is connected, "**USB media**" will be automatically displayed.
2. Press **◀▶** to select "**Photo mode**", and then press **ENTER**

# Contents

1.	Part Names
2.	Basic Operation
3.	Menu Operation
4.	USB Media
1.	Before Using USB Media
7.	Enjoying Photo
21.	Enjoying Music
24.	Enjoying Video
5.	Connecting Other Devices
6.	Operating the Monitor Using a PC (IP control)
7.	Troubleshooting
8.	Specifications, etc.

Ver. 1.00



## USB Media

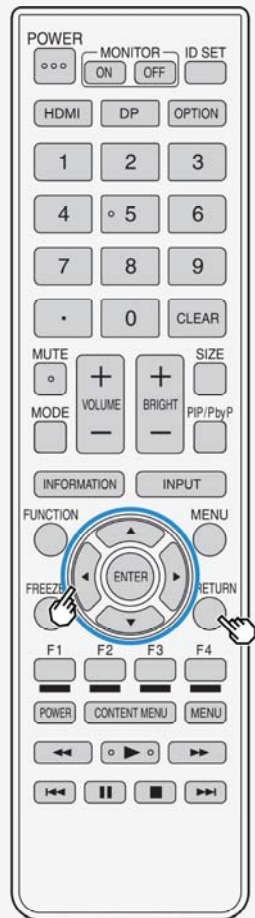

### Enjoying Photo

#### Displaying photo

3. Press to select a folder, and then press **ENTER**
4. Press /// to select photo, and then press **ENTER**
  - The photo appears full-screen.
  - If you select a folder, all images in the folder will be displayed.
  - By pressing **RETURN**, you can return to photo select screen.

#### NOTE

- If there is an invalid photo file, X mark is played on the thumbnail.
- At the bottom left corner of the photo select screen, file name, photo data\*, pixel / file size, and remaining capacity of the media are displayed.  
\*Only EXIF file format data can be shown.
- Depending on a certain photo data, they may not be displayed as thumbnail.
- When any photo is not shown but an error message appears, see "Message concerning USB Media" (pages [7-9](#) to [7-10](#)).



# Contents

1. Part Names
2. Basic Operation
3. Menu Operation
4. USB Media
  1. Before Using USB Media
  7. Enjoying Photo
  21. Enjoying Music
  24. Enjoying Video
5. Connecting Other Devices
6. Operating the Monitor Using a PC (IP control)
7. Troubleshooting
8. Specifications, etc.

Ver. 1.00



## USB Media

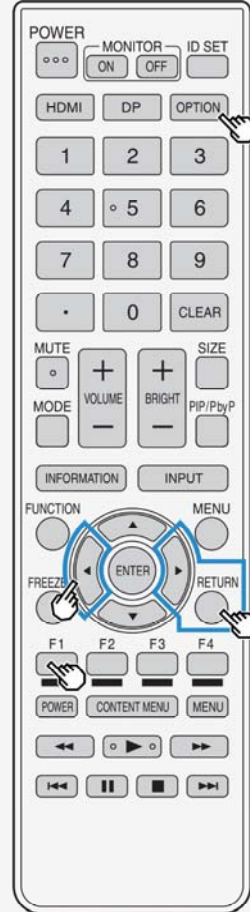

### Enjoying Photo

Operation during photo display

About this function

- When viewing photos, you can switch to the next photo.
- A guidance (operation guide) indicating the operation method is displayed at the bottom of the screen. Press the buttons according to the guidance display to operate.

#### NOTE

- Photos cannot be rotated.

◀▶: Switch to previous or next photo in the same folder.

**F1**: Toggles between displaying and not displaying the operation guide.

**OPTION**: Displays the function menu.

**RETURN**: Returns to the display list.

# Contents

- 1. Part Names
- 2. Basic Operation
- 3. Menu Operation
- 4. USB Media
  - 1. Before Using USB Media
  - 7. **Enjoying Photo**
  - 21. Enjoying Music
  - 24. Enjoying Video
- 5. Connecting Other Devices
- 6. Operating the Monitor Using a PC (IP control)
- 7. Troubleshooting
- 8. Specifications, etc.

Ver. 1.00



## USB Media

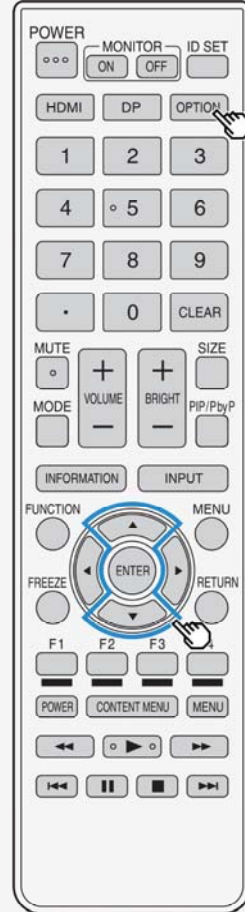

### Enjoying Photo

Switching photo display mode



About this function

- You can switch the photo display mode

How to operate

1. During the display of photo, press **OPTION**, use the **▲/▼** button to select "**Screen Size**", and then press **ENTER**
2. Use the **▲/▼** button to specify the desired setting, and then press **ENTER**

About display mode switch item and photo display

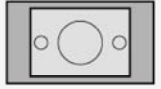
Image size	Normal	Dot by Dot
Image with a dot size over 7680x4320		
Image with a dot size up to 7680x4320		

# Contents

1.	Part Names
2.	Basic Operation
3.	Menu Operation
4.	USB Media
1.	Before Using USB Media
7.	Enjoying Photo
21.	Enjoying Music
24.	Enjoying Video
5.	Connecting Other Devices
6.	Operating the Monitor Using a PC (IP control)
7.	Troubleshooting
8.	Specifications, etc.

Ver. 1.00

>

<

## USB Media

### Enjoying Photo

Enjoying slide show

About this function

- Photos can be displayed as a slide show.
- The photos from USB memory can be selected to be displayed as slide show.

# Contents

- 1. Part Names
- 2. Basic Operation
- 3. Menu Operation
- 4. USB Media
  - 1. Before Using USB Media
  - 7. Enjoying Photo
  - 21. Enjoying Music
  - 24. Enjoying Video
- 5. Connecting Other Devices
- 6. Operating the Monitor Using a PC (IP control)
- 7. Troubleshooting
- 8. Specifications, etc.

Ver. 1.00



## USB Media

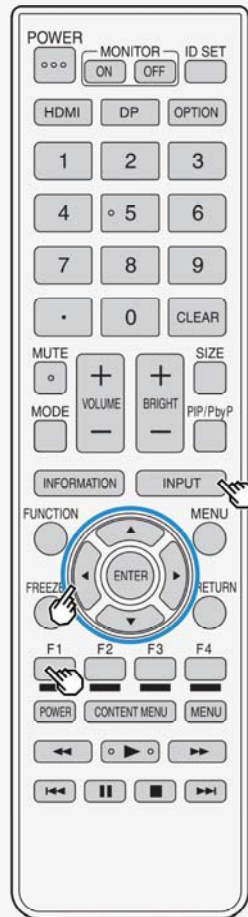

### Enjoying Photo

#### Enjoying slide show

To play a slide show based on photo list

1. Press **INPUT**, followed by **▲/▼** to select "**USB media**" and then press **ENTER**
2. If more than one USB memory are connected, select desired memory with **F1**
3. Press **◀▶** to select "**Photo Mode**", and then press **ENTER**

# Contents

- 1. Part Names
- 2. Basic Operation
- 3. Menu Operation
- 4. USB Media
  - 1. Before Using USB Media
  - 7. **Enjoying Photo**
  - 21. Enjoying Music
  - 24. Enjoying Video
- 5. Connecting Other Devices
- 6. Operating the Monitor Using a PC (IP control)
- 7. Troubleshooting
- 8. Specifications, etc.

Ver. 1.00



## USB Media

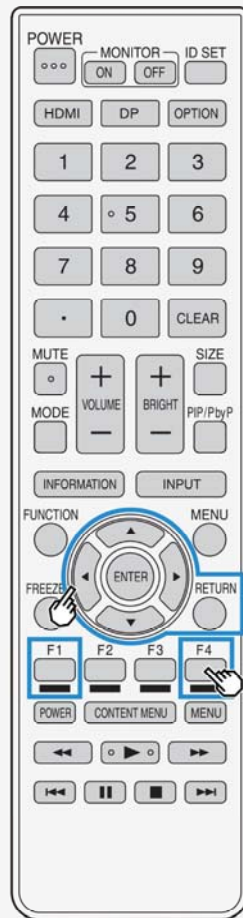

### Enjoying Photo

#### Enjoying slide show

To play a slide show based on a photo list.

4. Press to select a folder, and then press **ENTER**
5. Press **F1**
  - Photo selection mode will be used to display photos. Press /// to select the photos to be displayed as a slide show. Press **F4** to toggle between selecting / deselecting the photos. To select / deselect photos all at once, press **OPTION**, and then choose between "**Set all slide show image**" or "**Reset all slide show image**" from the function menu. Press **F1** to start slide show.
  - To quit the slide show, press **RETURN**.

# Contents

- 1. Part Names
- 2. Basic Operation
- 3. Menu Operation
- 4. USB Media
  - 1. Before Using USB Media
  - 7. **Enjoying Photo**
  - 21. Enjoying Music
  - 24. Enjoying Video
- 5. Connecting Other Devices
- 6. Operating the Monitor Using a PC (IP control)
- 7. Troubleshooting
- 8. Specifications, etc.

Ver. 1.00



## USB Media

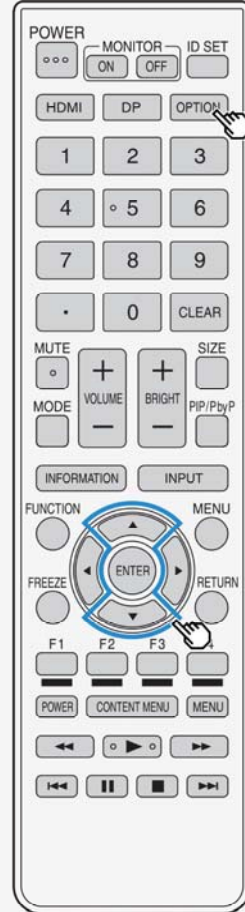

### Enjoying Photo

#### Setting up slide show

1. Press **OPTION** on the photo list screen to display the function menu.
2. Press **▲/▼** to select "**Slide Show Setup**", and then press **ENTER**
3. Press **▲/▼** to select the setting, and then press **ENTER**

#### Slide show interval

- Set the time duration before switching to the next picture.
- Depending on the photo, the display may not be switched according to the set time.

#### Slide show off timer setting

- Set the timer for the slide show. The power will automatically turn off after the set time duration.
- This is a function that can be helpful should you forget to turn off the power supply when using this machine as a large screen photo frame.
- The timer will start only during slide show operation.

#### Low brightness mode

- Reduces glare so that the slide show can be enjoyed better.
- Even when displaying a slide show for a long duration, the power consumption can be reduced to a certain degree.  
(The power consumption reduction depends on the environment and the photos.)

# Contents

- 1. Part Names
- 2. Basic Operation
- 3. Menu Operation
- 4. USB Media
  - 1. Before Using USB Media
  - 7. Enjoying Photo
  - 21. Enjoying Music
  - 24. Enjoying Video
- 5. Connecting Other Devices
- 6. Operating the Monitor Using a PC (IP control)
- 7. Troubleshooting
- 8. Specifications, etc.

Ver. 1.00



## USB Media

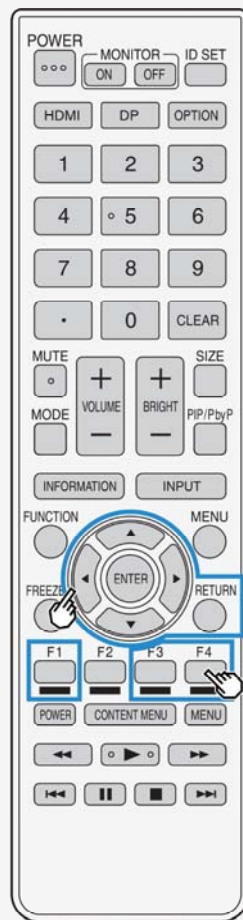

### Enjoying Photo

#### Selecting BGM for a slide show

##### About this function

- Choosing the music (BGM) that will be played when displaying the slide show.
  - The music stored in the USB memory can be used as BGM.
1. Press **F3** in the slide show picture selection mode.
  2. Press **▲/▼/◀/▶** to select the media, and then press **ENTER**
  3. Press **◀/▶** to select the folder that contains the audio file to be made as BGM, and then press **ENTER**
  4. Press **▲/▼** to select the audio file that will be made as BGM, and then press **F4** to select / deselect it
  5. Press **RETURN** to return to the screen which is displayed for selecting the folder.
  6. Press **RETURN** to return to the slide show photo selection mode.
  7. Press **F1** in photo selection mode to start the slide show.

##### NOTE

- In initial setting, all music files are selected by default.
- During the display of the slide show, the selected BGM will be repeatedly played back.

# Contents

1. Part Names
2. Basic Operation
3. Menu Operation
4. USB Media
  1. Before Using USB Media
  7. **Enjoying Photo**
  21. Enjoying Music
  24. Enjoying Video
5. Connecting Other Devices
6. Operating the Monitor Using a PC (IP control)
7. Troubleshooting
8. Specifications, etc.

Ver. 1.00



## USB Media

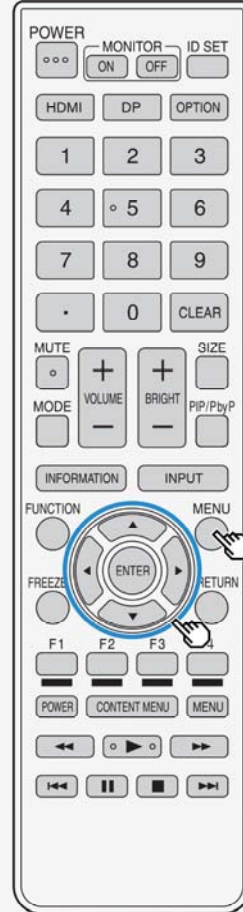

### Enjoying Photo

#### Copying photo

#### About this function

- Copying a photo from USB memory to another memory.
- When copying a photo to an SD memory card, a USB card reader is needed.
- Attach the USB memory to be used for copying to the Monitor in advance.
- Specify the copy destination by using the Setup menu, and then use USB Media to perform copy operation.

To copy photos, more than one USB memories need to be connected. However, only one connection is allowed when setting the USB memory destination.

#### Specify the destination to copy the photo

1. Make sure that only one USB memory is attached to the Monitor.
2. Press **MENU** to display the Menu, press **▲▼/◀▶** to select "**Setup**", and then press **ENTER**
3. Press **▲▼/◀▶** to select "**⚙️ (Initial Setup)**" - "**Individual setting**" - "**USB memory setting**", and then press **ENTER**
4. Press **▲▼** button to select "**Select USB memory**", and then press **ENTER**
5. Press **◀▶** button to select "**Yes**", and then press **ENTER**
  - For information on copy operation, see page [4-17](#).



# Contents

1. Part Names
2. Basic Operation
3. Menu Operation
4. USB Media
  1. Before Using USB Media
  7. **Enjoying Photo**
  21. Enjoying Music
  24. Enjoying Video
5. Connecting Other Devices
6. Operating the Monitor Using a PC (IP control)
7. Troubleshooting
8. Specifications, etc.

Ver. 1.00



## USB Media

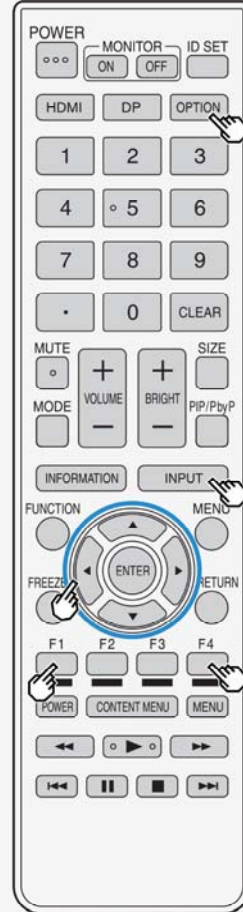

### Enjoying Photo

#### Copying photo

- To copy photos, more than one USB memories need to be connected. However, only one connection is allowed when setting the USB memory destination.
1. Connect the USB memory destination.
  2. If more than one USB memory are connected, select desired memory with **F1**.
  3. Press **▲**, and then press **◀▶** to select a memory on which the target photo is stored, and then press **ENTER**
  4. Press **◀▶** to select "**Photo Mode**", and then press **ENTER**
  5. Press **◀▶** to select the folder containing the target photo, and then press **ENTER**
  6. Press **OPTION** or **F2**, followed by **▲▼** to select "**Copy picture**", and then press **ENTER**
  7. Select the copy source from "**All folder**", "**Current folder**" or "**Selected file**", and then press **ENTER**
    - If you select "**Selected file**", the image selection screen will be displayed. Press **▲▼/◀▶** and **F4** to select the file to be copied, and then press **F2**.
  8. Press **▲▼** to select the destination to save, and then press **ENTER**
  9. Press **▲▼** to select the folder to save the file, and then press **ENTER**
    - If you select "**Create new folder**", you can create a new folder. A software keyboard appears, which you will use to enter the name of the folder.(page [3-45](#))
  10. Use the **▲▼** button to select "**Yes**", and then press **ENTER**
  11. Press **ENTER** on the confirmation screen.

# Contents

- 1. Part Names
- 2. Basic Operation
- 3. Menu Operation
- 4. USB Media
  - 1. Before Using USB Media
  - 7. **Enjoying Photo**
  - 21. Enjoying Music
  - 24. Enjoying Video
- 5. Connecting Other Devices
- 6. Operating the Monitor Using a PC (IP control)
- 7. Troubleshooting
- 8. Specifications, etc.

Ver. 1.00



## USB Media

### Enjoying Photo

#### Copying photo

**NOTE**

- The limit for the file name is up to 80 two-byte or 160 one-byte characters. File names that exceed the limit cannot be copied.
- If the input source is changed during copying photo, the copying operation will be interrupted.
- If there are photos with the same file names, it will be copied up to 10 items, and "(01) to (10)" will be added at the end of the file name by default.
- When "**All folder**" / "**Current folder**" is specified, only the files that does not exist in destination will be copied.

To remove USB memory that is used as copy destination,  
see page [4-19](#).

For information of USB memories that are available for Monitor,  
see page [4-2](#).

# Contents

- 1. Part Names
- 2. Basic Operation
- 3. Menu Operation
- 4. USB Media
  - 1. Before Using USB Media
  - 7. **Enjoying Photo**
  - 21. Enjoying Music
  - 24. Enjoying Video
- 5. Connecting Other Devices
- 6. Operating the Monitor Using a PC (IP control)
- 7. Troubleshooting
- 8. Specifications, etc.

Ver. 1.00



## USB Media

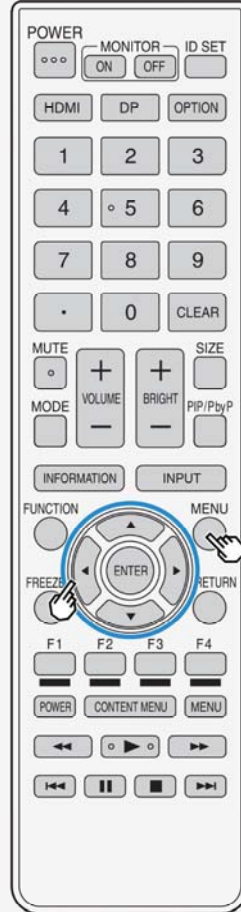

### Enjoying Photo

To remove the USB memory that is used as the copy destination

How to operate

1. Press **MENU** to display the Menu, press **▲▼/◀▶** to select "**Setup**", and then press **ENTER**
2. Press **▲▼/◀▶** to select "**⚙️ (Initial Setup)**" - "**Individual setting**" - "**USB memory setting**", and then press **ENTER**
3. Press **▲▼** to select "**Remove selected USB memory**", and then press **ENTER**
4. Press **ENTER**
5. Press **ENTER**
6. Remove USB memory

#### NOTE

- Even after selecting "**Remove selected USB memory**", data in the USB memory can still be viewed through "**USB Media**" until the USB memory is physically removed.
- After selecting "**Remove selected USB memory**", the copy / delete function will not be available. To enable the copy / delete function, remove and reconnect the USB memory physically. (will be automatically specified again)

# Contents

- 1. Part Names
- 2. Basic Operation
- 3. Menu Operation
- 4. USB Media
  - 1. Before Using USB Media
  - 7. **Enjoying Photo**
  - 21. Enjoying Music
  - 24. Enjoying Video
- 5. Connecting Other Devices
- 6. Operating the Monitor Using a PC (IP control)
- 7. Troubleshooting
- 8. Specifications, etc.

Ver. 1.00



## USB Media

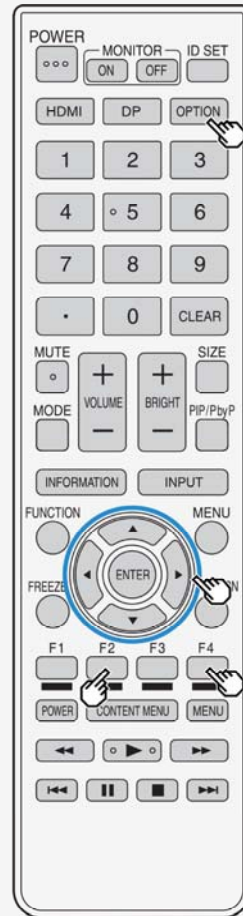

### Enjoying Photo

#### Deleting photo

##### About this function

- You can delete unnecessary photos stored on a USB memory.

##### How to operate

1. Press **OPTION** on the photo list screen to display the function menu.
2. Use the **▲/▼** button to select "**Delete photo**", and then press **ENTER**
3. Use the **▲/▼** button to select the target file from "**All folder**", "**Current folder**" or "**Selected file**", and then press **ENTER**
  - If you select "**Selected file**", the image selection screen is displayed. Use the **▲/▼/◀/▶** button and **F4** to select the target file, and then press **F2**.
4. Use the **▲/▼** button to select "**Yes**", and then press **ENTER**
5. Press **ENTER**

# Contents

- 1. Part Names
- 2. Basic Operation
- 3. Menu Operation
- 4. USB Media
  - 1. Before Using USB Media
  - 7. Enjoying Photo
  - 21. **Enjoying Music**
  - 24. Enjoying Video
- 5. Connecting Other Devices
- 6. Operating the Monitor Using a PC (IP control)
- 7. Troubleshooting
- 8. Specifications, etc.

Ver. 1.00



## USB Media

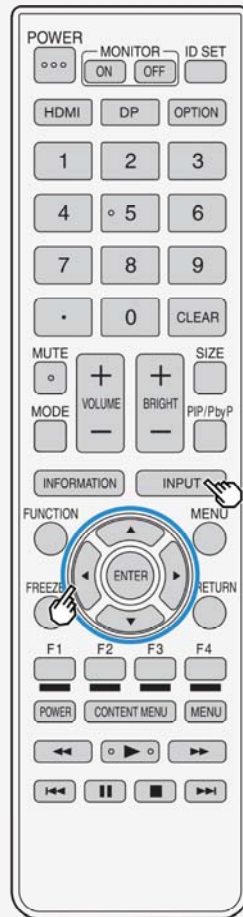

### Enjoying Music

#### Playing back music

##### About this function

- You can play back music file in USB memory.

##### How to operate

1. Press **INPUT**, followed by **▲▼** to select "**USB media**", and then press **ENTER**
2. Press **◀▶** to select "**Music Mode**", and then press **ENTER**
3. Press **▲▼/◀▶** to select a song title, and then press **ENTER**

# Contents

1. Part Names
2. Basic Operation
3. Menu Operation
4. USB Media
  1. Before Using USB Media
  7. Enjoying Photo
  21. **Enjoying Music**
  24. Enjoying Video
5. Connecting Other Devices
6. Operating the Monitor Using a PC (IP control)
7. Troubleshooting
8. Specifications, etc.

Ver. 1.00



## USB Media

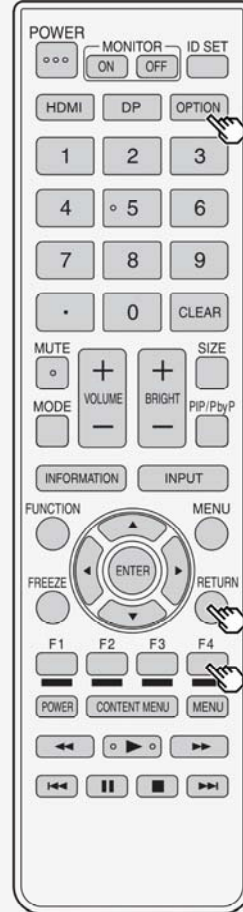

### Enjoying Music

#### Playing music

- Music is played.
- When selecting a folder, music files in that folder will be displayed.
- Press **RETURN** to display the previous screen.
- When there are multiple music files in the same folder being played, the music files in the folder will be played in order.
- Press **F4** to place check mark at the check box which is on the left side of the music file, then only the selected file will be played. If "**Set all auto play**" is selected from the menu which is displayed after pressing **OPTION**, check mark will be placed at all music files, and if "**Reset all auto play**" is selected, check mark will disappear from all music files.
- If "**AV Mode**" is selected from the menu which is displayed after pressing **OPTION**, image and sound quality can be changed.
- For information of the setup items for "**AV Mode**", see page [3-8](#).

#### NOTE

- If there is an invalid music file, an x-mark will be displayed at the file.
- For a variable bit rate file, the playback time displayed may differ from the actual playback time. In addition, playback may stop even if the progress bar display is in progress.

# Contents

1. Part Names
2. Basic Operation
3. Menu Operation
4. USB Media
  1. Before Using USB Media
  7. Enjoying Photo
  21. **Enjoying Music**
  24. Enjoying Video
5. Connecting Other Devices
6. Operating the Monitor Using a PC (IP control)
7. Troubleshooting
8. Specifications, etc.

Ver. 1.00



## USB Media

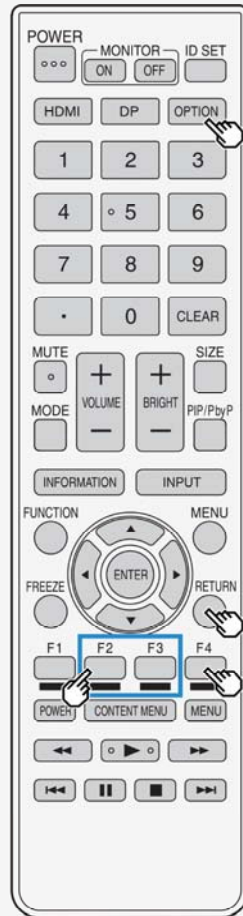

### Enjoying Music

How to operate during the playback of music

Playing music that is store on USB memory.

**RETURN:** Returns to the previous step.

**F2:** Plays / stops music playback.

**F3:** Stops playing music.

**F4:** Selects / deselect the music that will be played.

**OPTION:** Displays the function menu.

# Contents

- 1. Part Names
- 2. Basic Operation
- 3. Menu Operation
- 4. USB Media
  - 1. Before Using USB Media
  - 7. Enjoying Photo
  - 21. Enjoying Music
  - 24. Enjoying Video
- 5. Connecting Other Devices
- 6. Operating the Monitor Using a PC (IP control)
- 7. Troubleshooting
- 8. Specifications, etc.

Ver. 1.00



## USB Media

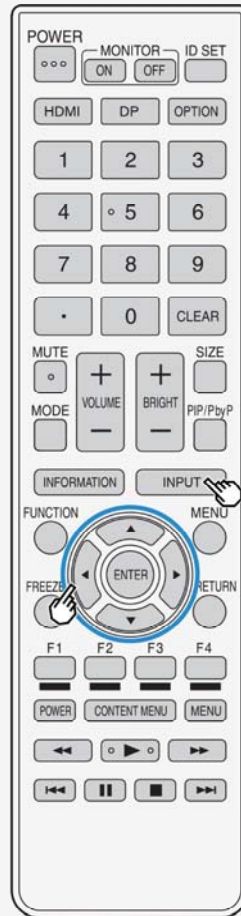

### Enjoying Video

#### Playing video

#### About this function

- You can play a video from USB memory.

#### How to operate

1. Press **INPUT**, use **▲▼** to select "**USB media**", and then press **ENTER**.
- Once USB memory is connected, "**USB media**" will be automatically displayed.
2. Press **◀▶** to select "**Video mode**", and then press **ENTER**



# Contents

- 1. Part Names
- 2. Basic Operation
- 3. Menu Operation
- 4. USB Media
  - 1. Before Using USB Media
  - 7. Enjoying Photo
  - 21. Enjoying Music
  - 24. Enjoying Video
- 5. Connecting Other Devices
- 6. Operating the Monitor Using a PC (IP control)
- 7. Troubleshooting
- 8. Specifications, etc.

Ver. 1.00



## USB Media

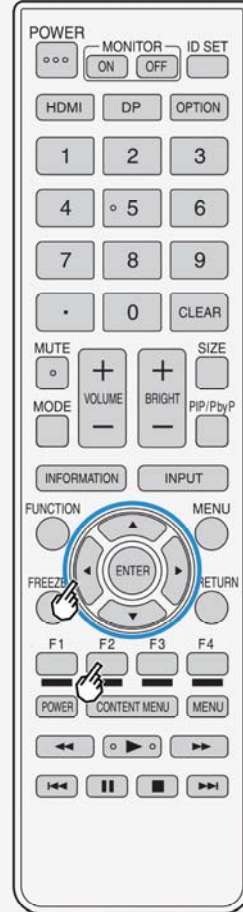

### Enjoying Video

#### Playing video

3. Use the **▲▼◀▶** button to select a video, and then press **ENTER**
  - The video will be played back.
  - If you select a video that you watched halfway through, the video will resume from where you left off.
  - If you select a folder, any videos in the folder will be displayed.
  - **RETURN** allows the preceding screen to be displayed.

#### NOTE

- If there is an invalid video file, an x-mark is displayed at the file.
- For a variable bit rate file, the playback time displayed may differ from the actual playback time. In addition, it may even end halfway through the progress bar.
- A video that cannot be played back on Monitor may be displayed.
- It is not ensured that any videos displayed can be properly played back.

#### Resume playback

- Up to 50 videos, which played back halfway through, can be retained by Monitor in reverse chronological order. If you select this, the video resumes from where you left it off the last time.
- Some types of videos may prevent you from resuming playback.

#### To play back from the beginning

- Use the up / down cursor button to select a video, and press **F2**.

# Contents

- 1. Part Names
- 2. Basic Operation
- 3. Menu Operation
- 4. USB Media
  - 1. Before Using USB Media
  - 7. Enjoying Photo
  - 21. Enjoying Music
  - 24. Enjoying Video
- 5. Connecting Other Devices
- 6. Operating the Monitor Using a PC (IP control)
- 7. Troubleshooting
- 8. Specifications, etc.

Ver. 1.00



## USB Media

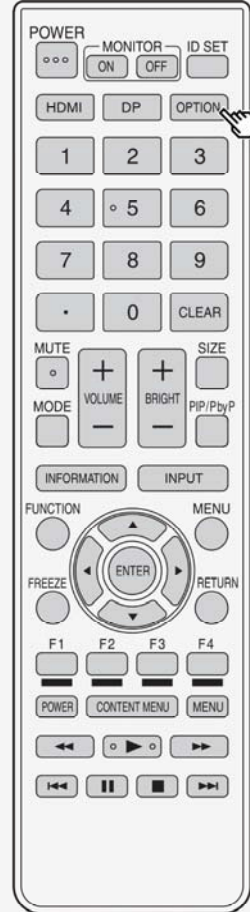

### Enjoying Video

How to operate during the playback of video

1. Press **OPTION** during the playback of VIDEO to the Application menu.
2. Use the **▲▼** button to select "Operation Panel," and then press **ENTER**

How to use the operation panel

Playback time/  
Total title playback time



Progress bar

· If you select this progress bar, you can move the video playback position forward or backward in increments of 5% of the total video length using the ◀▶ button.

Operation button

# Contents

1.	Part Names
2.	Basic Operation
3.	Menu Operation
4.	USB Media
1.	Before Using USB Media
7.	Enjoying Photo
21.	Enjoying Music
24.	Enjoying Video
5.	Connecting Other Devices
6.	Operating the Monitor Using a PC (IP control)
7.	Troubleshooting
8.	Specifications, etc.

Ver. 1.00



## USB Media

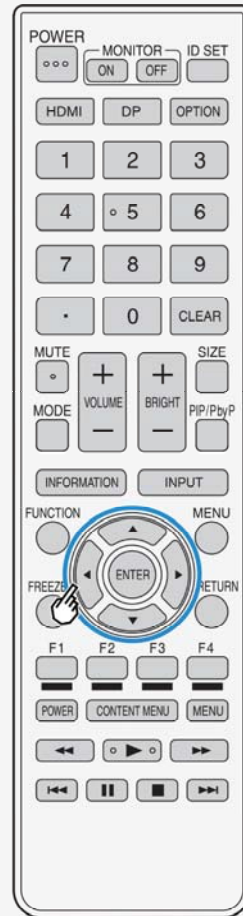

### Enjoying Video

How to operate during the playback of video

Operations during the playback of video

- You can perform operations such as pausing or playing a video.

▶	Plays the video.
⏸	Pauses the video.
⏮	Fast reverses the video. Press the button down again to speed up.(4 steps)
⏪	Returns to the beginning of the chapter being viewed now.
⏩	Fast forward the video. Press the button down again to speed up.(4 steps)
⏭	Locates the beginning of the next chapter.
■	Stops playback of the video, and returns to the video list screen.
-10 SEC	Rewinds the video by 10 seconds.
+30 SEC	Fast forward the video by about 30 seconds.

#### NOTE

- Some types of videos may prevent you from performing certain button operations.
- Available operations vary depending on the video viewed. Unavailable buttons are not displayed.
- Playback time can be navigated using the 10 sec REWIND / 30 SEC FF (approximate time) operations.
- During the speeding up or slowing down of playback, there may be no audio output.

# Contents

1.	Part Names
2.	Basic Operation
3.	Menu Operation
4.	USB Media
5.	Connecting Other Devices
1.	Connecting 8K Output-compatible Device/Quad-screen display (4K or less)
5.	Connecting 4K Output-compatible Device
7.	Viewing HDR Video (INPUT1, INPUT7, INPUT8)
9.	Using the HDMI CEC
11.	Connecting Recorder, Player, etc.
21.	Connecting Audio Device
22.	Connecting PC
6.	Operating the Monitor Using a PC (IP control)
7.	Troubleshooting



## Connecting Other Devices

### Connecting 8K output compatible Device/Quad-screen display ( 4K or less)

- Connects the Monitor to 8K output (7680 × 4320 of resolution output) compatible equipment by using 4 HDMI cables.
  - When connecting an 8K output compatible device to the Monitor, use commercially available premium HDMI cables.
  - Connect the devices properly so that the output signal from the device can be displayed at the appropriate position. Video images from the HDMI input terminal are displayed at the position as shown on the right (default).
  - Multi-screen display by using 8K signal is not supported.
  - In MODE2, 8K display is possible whenever any input signal to INPUT 7 (A to D) is synchronized.
  - Under the factory default setting, INPUT7-A is set as the sound input.
  - To change the factory default setting, switch to INPUT7, select "**Setup**" - " (Option)" - "**Terminal setting**" - "**INPUT7 audio setting**" from the Menu, and then select input for audio sound.
  - Read the operation manual on the device to be connected to the Monitor as well.
- ◆ Important ◆
- Use / connect four HDMI cables of the same type and brand, otherwise performance cannot be guaranteed.
  - In Mode2, input the format 3840×2160 (24Hz, 25Hz, 30Hz, 50Hz, 60Hz) to each terminal of INPUT 7 (A to D).  
If any format other than the above is input, the video or picture may be distorted.

Mode1 (4K x1)

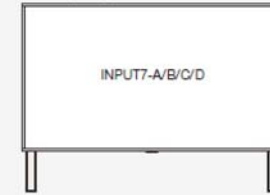

Mode2 (8K)

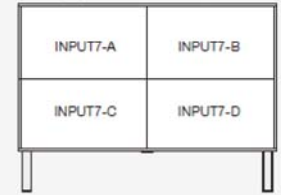

Mode3 (4K x4)

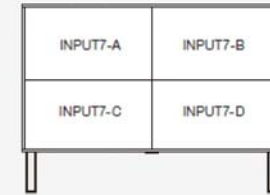

Mode4 (4K x4)

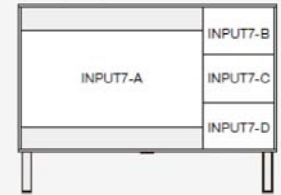

# Contents

1. Part Names
2. Basic Operation
3. Menu Operation
4. USB Media
5. Connecting Other Devices

1. Connecting 8K Output-compatible Device/Quad-screen display (4K or less)

5. Connecting 4K Output-compatible Device

7. Viewing HDR Video (INPUT1, INPUT7, INPUT8)

9. Using the HDMI CEC

11. Connecting Recorder, Player, etc.

21. Connecting Audio Device

22. Connecting PC

6. Operating the Monitor Using a PC (IP control)

7. Troubleshooting



## Connecting Other Devices

### Connecting 8K output compatible Device/Quad-screen display ( 4K or less)

Connect four HDMI cables (8K output compatible device)

- A commercially available premium HDMI cable is required.

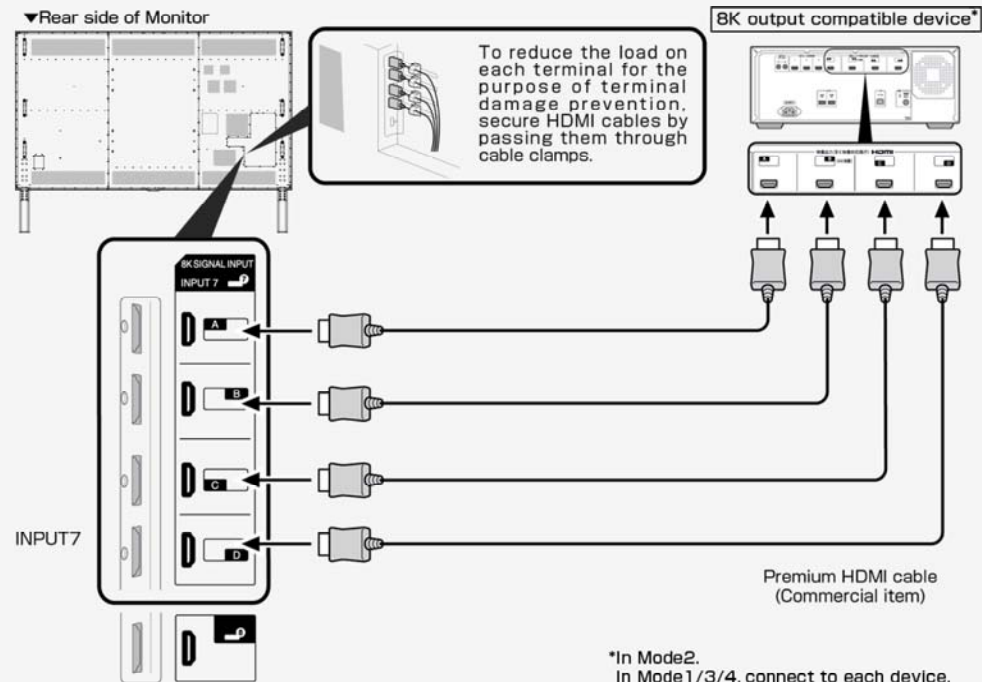

# Contents

1.	Part Names
2.	Basic Operation
3.	Menu Operation
4.	USB Media
5.	Connecting Other Devices
1.	Connecting 8K Output-compatible Device/Quad-screen display (4K or less)
5.	Connecting 4K Output-compatible Device
7.	Viewing HDR Video (INPUT1, INPUT7, INPUT8)
9.	Using the HDMI CEC
11.	Connecting Recorder, Player, etc.
21.	Connecting Audio Device
22.	Connecting PC
6.	Operating the Monitor Using a PC (IP control)
7.	Troubleshooting

## Connecting Other Devices

### Connecting 8K output compatible Device/Quad-screen display ( 4K or less)

#### Supported format in Mode2

- 7680 × 4320 (24Hz, 25Hz, 30Hz, 50Hz, 60Hz)

#### How to switch

- Press **INPUT** on the remote control. During the display of the input change menu, use the ▲/▼ to select "**INPUT7**", and press **ENTER**.

#### Indication when 8K video input is used

- When a synchronizing 8K signal is input to INPUT7 (A to D), the video information is displayed as "**4320p**".

#### NOTE

- "**Out of range**" message will be displayed if an unsupported signal is input. In such situation, refer to the operation manual of the connected device and change to the supported signal.
- Video will not be displayed properly if input signals are not synchronized.

#### How to change the mode

- Each time you press **PIP/PbyP**, the Mode changes in the following order.  
Mode1 -> Mode2 -> Mode3 -> Mode4 -> Mode1...

#### How to change the display in Mode1

- Press the button for the input you want to display.  
INPUT7-A:F1, INPUT7-B:F2, INPUT7-C:F3, INPUT7-D:F4

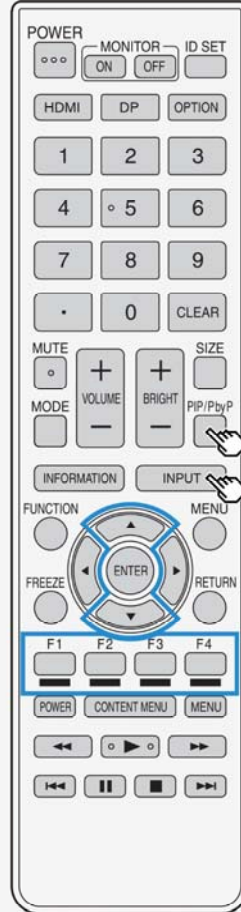

# Contents

1.	Part Names
2.	Basic Operation
3.	Menu Operation
4.	USB Media
5.	Connecting Other Devices
1.	Connecting 8K Output-compatible Device/Quad-screen display (4K or less)
5.	Connecting 4K Output-compatible Device
7.	Viewing HDR Video (INPUT1, INPUT7, INPUT8)
9.	Using the HDMI CEC
11.	Connecting Recorder, Player, etc.
21.	Connecting Audio Device
22.	Connecting PC
6.	Operating the Monitor Using a PC (IP control)
7.	Troubleshooting

## Connecting Other Devices

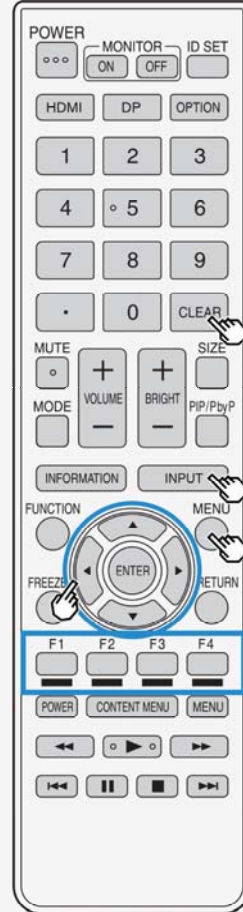

### Connecting 8K output compatible Device/Quad-screen display ( 4K or less)

#### How to change the display position in Mode3/4

- In mode 3, press the button for the input you want to display at the top left. The display position of the selected screen and the upper left screen change.
- In mode 4, press the button for the input you want to display at the left side. The display position of the selected screen and the left side screen change.

INPUT7-A:F1, INPUT7-B:F2, INPUT7-C:F3, INPUT7-D:F4

- To return initial display position, press **CLEAR**.

#### Supported audio sound signals

- Type: Linear PCM
- Sampling frequency: 48kHz / 44.1kHz / 32kHz

#### How to change the input audio sound in Mode2/3/4

- Press **MENU**, followed by **▲/▼/◀/▶** and **ENTER** to select "**Setup**" - "**Option**" - "**Terminal setting**" - "**INPUT7 audio setting**", then select input for audio sound.

#### NOTE

- When "**Audio input terminal**" has been selected for "**INPUT7 audio setting**", no sound will come out of the Monitor if you connect between the Monitor and a typical HDMI compatible device using an HDMI cable instead of an analog audio cable. (An analog audio cable needs to be connected)  
To connect the Monitor to a HDMI compatible device using an HDMI cable alone, select the input to which the device has been connected in "**INPUT7 audio setting**".

# Contents

1. Part Names
2. Basic Operation
3. Menu Operation
4. USB Media
5. Connecting Other Devices
  1. Connecting 8K Output-compatible Device/Quad-screen display (4K or less)
  5. Connecting 4K Output-compatible Device
  7. Viewing HDR Video (INPUT1, INPUT7, INPUT8)
  9. Using the HDMI CEC
  11. Connecting Recorder, Player, etc.
  21. Connecting Audio Device
  22. Connecting PC
6. Operating the Monitor Using a PC (IP control)
7. Troubleshooting



## Connecting Other Devices

### Connecting 4K output compatible Device

Connecting a 4K output compatible BD recorder

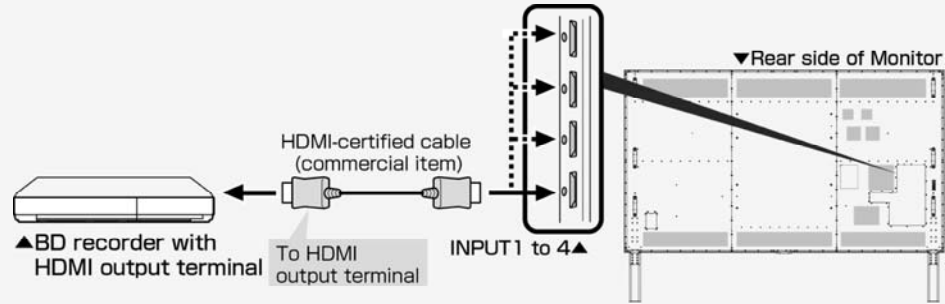

Connecting a 4K output compatible AV amplifier

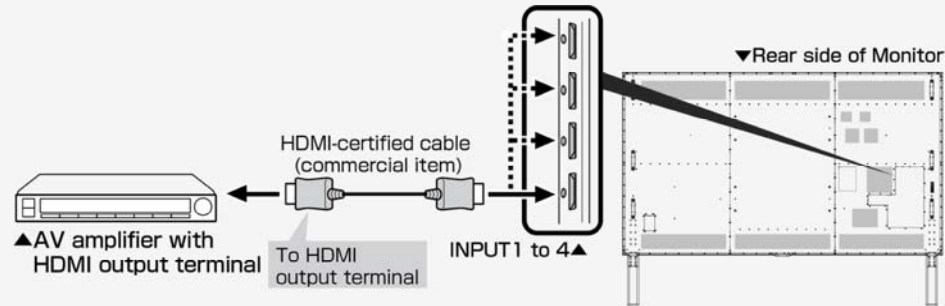

#### NOTE

- A commercially available premium HDMI cable is required.
- Only INPUT 1 supports for 4K50p/60P (4:2:2, 4:4:4) signals.
- Only INPUT 2 supports ARC.



# Contents

1. Part Names
2. Basic Operation
3. Menu Operation
4. USB Media
5. Connecting Other Devices
  1. Connecting 8K Output-compatible Device/Quad-screen display (4K or less)
  5. Connecting 4K Output-compatible Device
  7. Viewing HDR Video (INPUT1, INPUT7, INPUT8)
  9. Using the HDMI CEC
  11. Connecting Recorder, Player, etc.
  21. Connecting Audio Device
  22. Connecting PC
6. Operating the Monitor Using a PC (IP control)
7. Troubleshooting



## Connecting Other Devices

### Connecting 4K output compatible Device

Connecting 4K output compatible device

- Use a PC that supports 4K output (resolution output of 3840 × 2160).

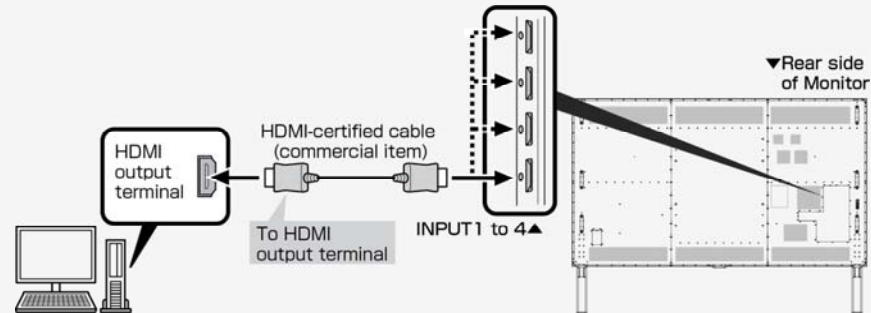

#### NOTE

- A commercially available HDMI-certified cable (Premium HDMI cable) is required.
- Only INPUT 1 supports for 4K50p/60P (4:2:2, 4:4:4) signals.

# Contents

1.	Part Names
2.	Basic Operation
3.	Menu Operation
4.	USB Media
5.	Connecting Other Devices
1.	Connecting 8K Output-compatible Device/Quad-screen display (4K or less)
5.	Connecting 4K Output-compatible Device
7.	Viewing HDR Video (INPUT1, INPUT7, INPUT8)
9.	Using the HDMI CEC
11.	Connecting Recorder, Player, etc.
21.	Connecting Audio Device
22.	Connecting PC
6.	Operating the Monitor Using a PC (IP control)
7.	Troubleshooting

## Connecting Other Devices

### Viewing HDR Video (INPUT1, INPUT7, INPUT8)

- This Monitor provides support for HDR (High Dynamic Range) supported by "ULTRA HD Blu-ray™". Ever-more brightness information is included on HDR video, making it possible to express the gradation of bright and dark areas in the HDR video. This was previously impossible to express in videos such as ones with a high contrast between bright and dark areas, and thereby offering high-contrast, realistic video images.
- To view a HDR video using INPUT 1 of the Monitor, connect a HDR-capable device to INPUT 1, and set "**Suitable mode for signals**" to "**Full mode (HDR)**".
- When **INPUT7** or **8** is selected, you can use a HDR compatible device with the default setting.
  1. Press **INPUT**, use the **▲▼** to select "**INPUT 1**", and then press **ENTER**
  2. Press **MENU** to display the Menu, press **▲▼/◀▶** to select "**Setup**", and then press **ENTER**
  3. Press **▲▼/◀▶** to select "**Option**" - "**Terminal setting**", and press **ENTER**
  4. Press **▲▼** to select "**Suitable mode for signals**", and press **ENTER**
  5. Press **▲▼** to select "**Full mode (HDR)**", and press **ENTER**

#### NOTE

- During "**Full mode (HDR)**" and "**Backlight**" (page [3-9](#)) can be adjusted respectively for HDR and SDR video contents.
- HDR and SDR video content signals are identified automatically.

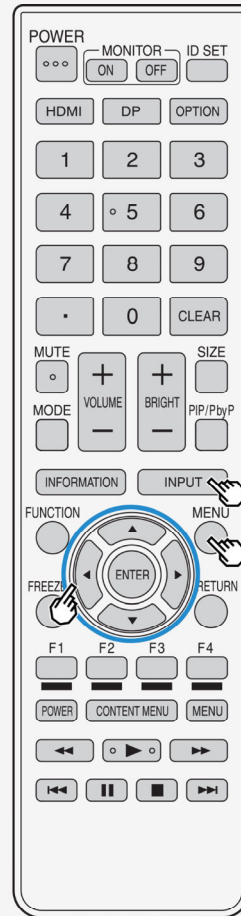

# Contents

1. Part Names
2. Basic Operation
3. Menu Operation
4. USB Media
5. Connecting Other Devices
  1. Connecting 8K Output-compatible Device/Quad-screen display (4K or less)
  5. Connecting 4K Output-compatible Device
  7. Viewing HDR Video (INPUT1, INPUT7, INPUT8)
  9. Using the HDMI CEC
  11. Connecting Recorder, Player, etc.
  21. Connecting Audio Device
  22. Connecting PC
6. Operating the Monitor Using a PC (IP control)
7. Troubleshooting



## Connecting Other Devices

### Viewing HDR Video (INPUT1, INPUT7, INPUT8)

Adjusting an HDR video to be either brightness-oriented or tone-oriented.

1. Press **MENU** to display the Menu, use the **▲▼/◀▶** to select "**Setup**", and then press **ENTER**
2. Press **▲▼/◀▶** to select "**Picture**" - "**Advanced**", and press **ENTER**
3. Press **▲▼** to select "**Dynamic range expansion setting**", and press **ENTER**
4. Make adjustments using the **◀▶** button
  - The video will be brightness-oriented if it is set to a larger value. The video will be tone-oriented if it is set to a smaller value.

#### NOTE

- This selection is only available during the input of HDR signal.
- When HDR video contents are input, the "HDR" icon is displayed on the screen.

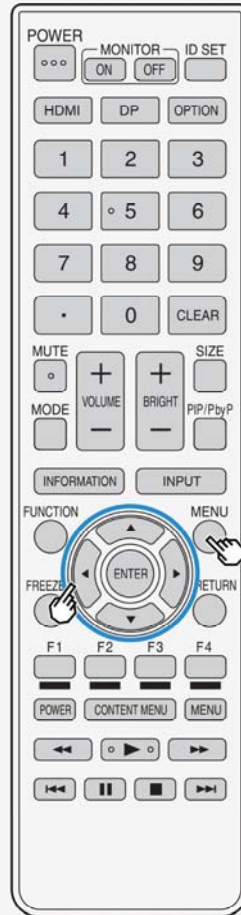

# Contents

1. Part Names
2. Basic Operation
3. Menu Operation
4. USB Media
5. Connecting Other Devices
  1. Connecting 8K Output-compatible Device/Quad-screen display (4K or less)
  5. Connecting 4K Output-compatible Device
  7. Viewing HDR Video (INPUT1, INPUT7, INPUT8)
  9. Using the HDMI CEC
  11. Connecting Recorder, Player, etc.
  21. Connecting Audio Device
  22. Connecting PC
6. Operating the Monitor Using a PC (IP control)
7. Troubleshooting



## Connecting Other Devices

### Using the HDMI CEC

What is HDMI CEC (Consumer Electronics Control)?

- HDMI terminals are not limited to video or audio signals but it permits control signals, which allow for device-to-device control, which is transmitted through the HDMI cable. You can control each other between the compatible devices.

#### NOTE

- To operate HDMI CEC using the remote control, point the remote control at the Monitor.

Easy playback of recorded program

# Contents

1.	Part Names
2.	Basic Operation
3.	Menu Operation
4.	USB Media
5.	Connecting Other Devices
1.	Connecting 8K Output-compatible Device/Quad-screen display (4K or less)
5.	Connecting 4K Output-compatible Device
7.	Viewing HDR Video (INPUT1, INPUT7, INPUT8)
9.	Using the HDMI CEC
11.	Connecting Recorder, Player, etc.
21.	Connecting Audio Device
22.	Connecting PC
6.	Operating the Monitor Using a PC (IP control)
7.	Troubleshooting



## Connecting Other Devices

### Using the HDMI CEC

#### Before using HDMI CEC functions

1. Connect to an HDMI CEC enabled device
  - With a commercially available HDMI-certified cable, connect an HDMI CEC compatible device and the Monitor using a commercially available HDMI-certified cable.
2. Configuring the settings.
  - Settings (page [3-31](#)) have to be configured to use the HDMI CEC compatible device.
  - Settings must also be configured for the recorder. Read the operation manual of the device before configuring the settings.

# Contents

1. Part Names
2. Basic Operation
3. Menu Operation
4. USB Media
5. Connecting Other Devices

1. Connecting 8K Output-compatible Device/Quad-screen display (4K or less)
5. Connecting 4K Output-compatible Device
7. Viewing HDR Video (INPUT1, INPUT7, INPUT8)
9. Using the HDMI CEC
11. Connecting Recorder, Player, etc.
21. Connecting Audio Device
22. Connecting PC

6. Operating the Monitor Using a PC (IP control)
7. Troubleshooting



## Connecting Other Devices

### Connecting Recorder, Player, etc.

To connect through HDMI terminals

- Check the output terminals of your recorder or player, and connect to a terminal that is capable of high definition / high image quality.

#### NOTE

- For information on video types and image quality, page [5-14](#)
- Even with a high-definition- / high-image-quality-capable terminal, a video input of standard image quality will be of standard quality.
- For information on connections, see page [5-13](#).
- When the Monitor is connected to an HDMI CEC compatible recorder, you can operate the recorder with the remote control.
- For information on connection to INPUT 7 (8K signal), see page [5-2](#).

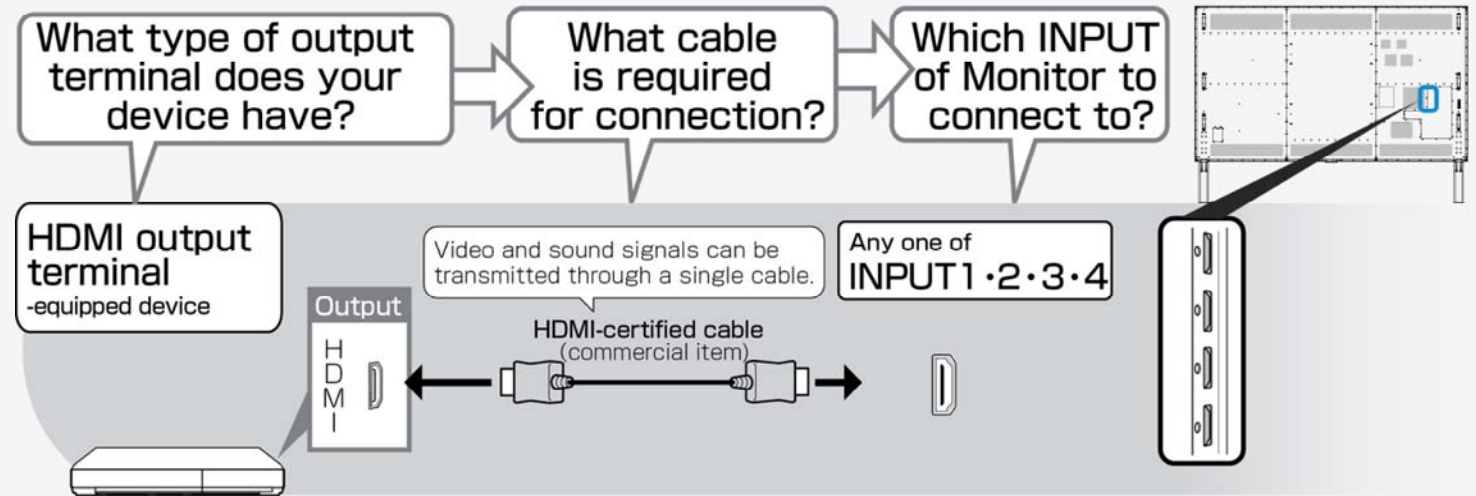

# Contents

1. Part Names
2. Basic Operation
3. Menu Operation
4. USB Media
5. Connecting Other Devices

1. Connecting 8K Output-compatible Device/Quad-screen display (4K or less)

5. Connecting 4K Output-compatible Device

7. Viewing HDR Video (INPUT1, INPUT7, INPUT8)

9. Using the HDMI CEC

11. Connecting Recorder, Player, etc.

21. Connecting Audio Device

22. Connecting PC

6. Operating the Monitor Using a PC (IP control)

7. Troubleshooting



## Connecting Other Devices

### Connecting Recorder, Player, etc.

To connect through video terminals

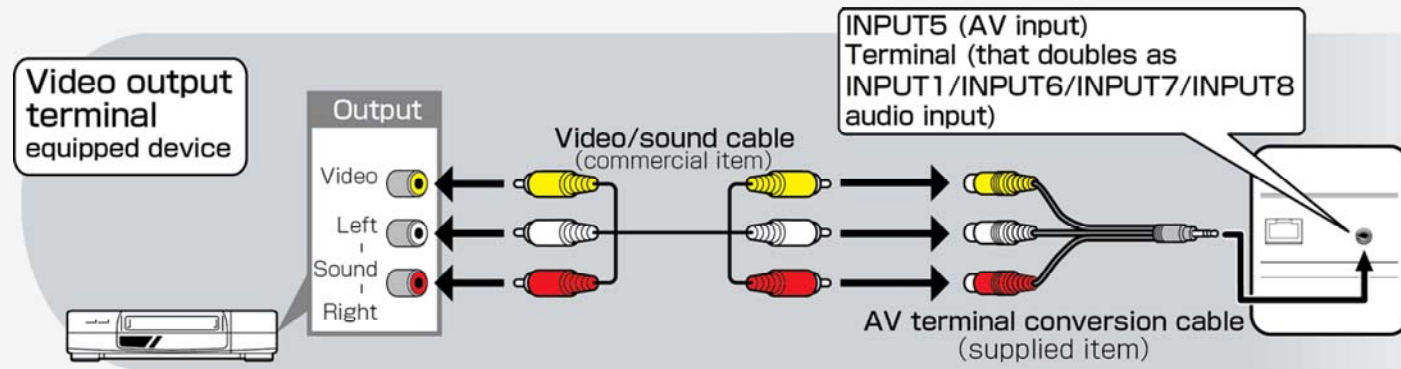

#### NOTE

- Connect each video / audio cable to the terminal of the same color as its tip (yellow cable connects to yellow terminal, and white / red cables to white / red terminals, respectively).
- To play a commercially available Blu-ray Disc in a recorder or player, connect between the recorder or player and the Monitor through an HDMI cable. There may be no video or audio / sound output from a blu-ray disc in a Digital Rights Management-based recorder or player.

# Contents

1. Part Names
2. Basic Operation
3. Menu Operation
4. USB Media
5. Connecting Other Devices

1. Connecting 8K Output-compatible Device/Quad-screen display (4K or less)

5. Connecting 4K Output-compatible Device

7. Viewing HDR Video (INPUT1, INPUT7, INPUT8)

9. Using the HDMI CEC

11. Connecting Recorder, Player, etc.

21. Connecting Audio Device

22. Connecting PC

6. Operating the Monitor Using a PC (IP control)

7. Troubleshooting



## Connecting Other Devices

### Connecting Recorder, Player, etc.

For a device with an HDMI output terminal

- HDMI terminals allow video and audio signals to be transmitted through an HDMI-certified cable (commercial product).
- Be sure to use a commercially available HDMI-certified product.  
If you use a cable that is not HDMI-certified, a malfunction may occur, such as a failure to display a video or operate HDMI CEC, no sound coming from the Monitor, or a noise in video.
- If any of the following apply, use a Premium HDMI cable.
  - When connecting to a device that is 4K2K output compatible
  - When inputting a video signal (1080p)
- For information on connection to INPUT 7 (8K signal), see page [5-2](#).

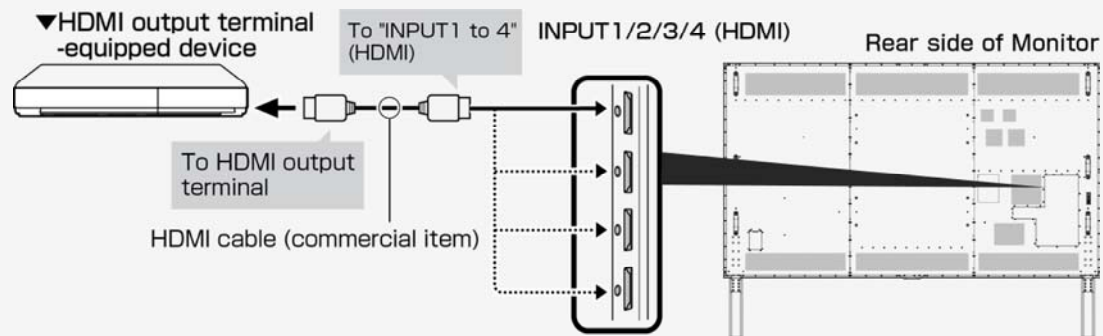

- When playing back a 4K60p video or an HDR video from ULTRA HD Blu-ray™, connect to INPUT1 of the Monitor through a 18Gbps-capable cable certified as a "premium HDMI cable".



# Contents

1.	Part Names
2.	Basic Operation
3.	Menu Operation
4.	USB Media
5.	Connecting Other Devices
1.	Connecting 8K Output-compatible Device/Quad-screen display (4K or less)
5.	Connecting 4K Output-compatible Device
7.	Viewing HDR Video (INPUT1, INPUT7, INPUT8)
9.	Using the HDMI CEC
11.	Connecting Recorder, Player, etc.
21.	Connecting Audio Device
22.	Connecting PC
6.	Operating the Monitor Using a PC (IP control)
7.	Troubleshooting



## Connecting Other Devices

### Connecting Recorder, Player, etc.

For a device with an HDMI output terminal (INPUT 1 / 2 / 3 / 4)

Supported video signals

- 3840 × 2160 (24Hz/25Hz/30Hz/50Hz/60Hz<sup>\*</sup>), 1080p (24Hz/30Hz/50Hz/60Hz), 720p (30Hz/50Hz/60Hz), 1080i, 576p, 576i, 480p, 480i, VGA, SVGA, XGA, WXGA, SXGA, SXGA+

\*Only INPUT 1 supports for 4K50p/60p (4:2:2, 4:4:4) signals.

Supported audio sound signals

- Type: Linear PCM (2ch)<sup>\*1</sup>, AAC<sup>\*2</sup>, Dolby Digital  
sampling frequency: 48kHz / 44.1kHz / 32kHz

\*1 Only Linear PCM is supported (INPUT 7) during viewing 8K video.

\*2 Since digital broadcasting makes efficient use of limited radio waves, videos or sounds are compressed before being transmitted.

AAC is an audio compression format that is used in digital broadcasting, and that, in spite of a high compression ratio, can achieve high sound quality and even support multi-channel audio (5.1 channel surround, etc.).

#### NOTE

- If a device that is not HDMI CEC compatible is connected to the monitor, it may turn on and off, or switch channels on its own. In this case, set "**CEC control**" to "**Off**". (page [3-31](#))

# Contents

1.	Part Names
2.	Basic Operation
3.	Menu Operation
4.	USB Media
5.	Connecting Other Devices
1.	Connecting 8K Output-compatible Device/Quad-screen display (4K or less)
5.	Connecting 4K Output-compatible Device
7.	Viewing HDR Video (INPUT1, INPUT7, INPUT8)
9.	Using the HDMI CEC
11.	Connecting Recorder, Player, etc.
21.	Connecting Audio Device
22.	Connecting PC
6.	Operating the Monitor Using a PC (IP control)
7.	Troubleshooting



## Connecting Other Devices

### Connecting Recorder, Player, etc.

For a device with a video output terminal (connection for playback)

- Do not turn on the Monitor and recoding device before completing connection between the Monitor and the recording device.

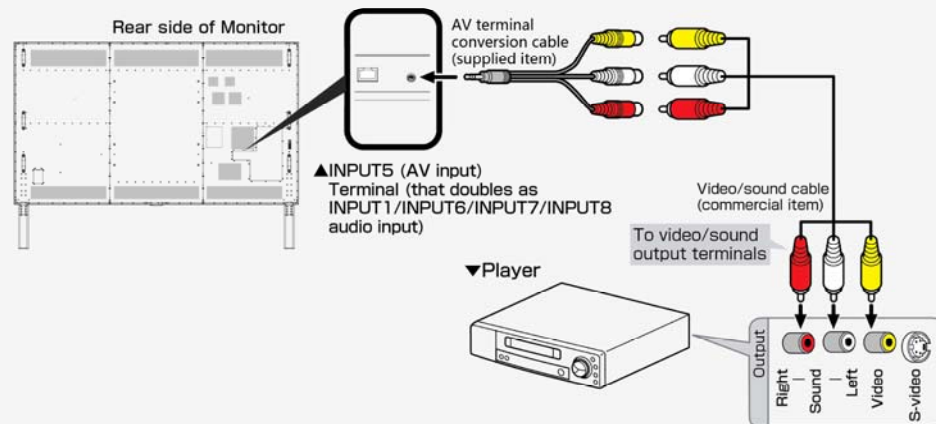

- Connect each video / audio cable to the terminal of the same color as its tip (yellow cable connects to yellow terminal, and white / red cables to white / red terminals, respectively).
- Be sure to use the supplied conversion cable. When using any conversion cable other than the supplied one, the Monitor may not operate properly, or breakages may occur.

# Contents

- 1. Part Names
- 2. Basic Operation
- 3. Menu Operation
- 4. USB Media
- 5. Connecting Other Devices
  - 1. Connecting 8K Output-compatible Device/Quad-screen display (4K or less)
  - 5. Connecting 4K Output-compatible Device
  - 7. Viewing HDR Video (INPUT1, INPUT7, INPUT8)
  - 9. Using the HDMI CEC
  - 11. Connecting Recorder, Player, etc.
  - 21. Connecting Audio Device
  - 22. Connecting PC
- 6. Operating the Monitor Using a PC (IP control)
- 7. Troubleshooting



## Connecting Other Devices

### Connecting Recorder, Player, etc.

Switching to the screen of a BD recorder, etc.

- Switching to the screen of HDMI output allows you to watch BD or DVD video.

The underlined step describes the operation of an external device such as BD recorder.

1. Connect a BD recorder to the Monitor, and press its power button to turn on the BD recorder
2. Insert a disk you want to play back.
3. Press **INPUT** to display the input change menu.
  - Perform the operation on page [5-17](#) during the display of the menu.

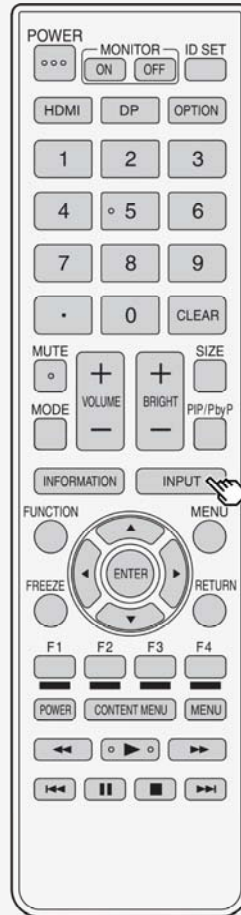

# Contents

1. Part Names
2. Basic Operation
3. Menu Operation
4. USB Media
5. Connecting Other Devices
  1. Connecting 8K Output-compatible Device/Quad-screen display (4K or less)
  5. Connecting 4K Output-compatible Device
  7. Viewing HDR Video (INPUT1, INPUT7, INPUT8)
  9. Using the HDMI CEC
  11. Connecting Recorder, Player, etc.
  21. Connecting Audio Device
  22. Connecting PC
6. Operating the Monitor Using a PC (IP control)
7. Troubleshooting



## Connecting Other Devices

### Connecting Recorder, Player, etc.

Switching to the screen of a BD recorder, etc.

The underlined step describes the operation of an external device such as BD recorder.

4. Press **INPUT** repeatedly to select the name of the input to which the device is connected

- It can also be selected by using the ▲▼ button.

Selectable input

- **"INPUT5"** can be selected only when a video device is connected to the Monitor.

5. Play a video from a BD recorder

- A video is played on the Monitor.
- Some external devices may require a setting be made to output a video. For information on how to make the setting, refer to the operation manual for the BD recorder connected to the Monitor.

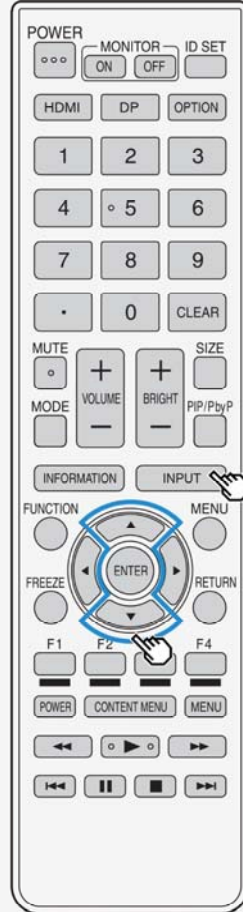

# Contents

1. Part Names
2. Basic Operation
3. Menu Operation
4. USB Media
5. Connecting Other Devices
  1. Connecting 8K Output-compatible Device/Quad-screen display (4K or less)
  5. Connecting 4K Output-compatible Device
  7. Viewing HDR Video (INPUT1, INPUT7, INPUT8)
  9. Using the HDMI CEC
  11. Connecting Recorder, Player, etc.
  21. Connecting Audio Device
  22. Connecting PC
6. Operating the Monitor Using a PC (IP control)
7. Troubleshooting



## Connecting Other Devices

### Connecting Recorder, Player, etc.

Switching to the screen of a BD recorder, etc.

To change displayed name of input source as desired

- The device names displayed in the input menu, etc. can be changed to the names of the devices connected to INPUT1 to 8.
1. Press **INPUT**, followed by **▲▼** to select any input to be renamed (INPUT1 to 8), and then press **ENTER**
  2. Press **MENU** to display the Menu, followed by **▲▼/◀▶** to select "**Setup**", and then press **ENTER**
  3. Press **▲▼/◀▶** to select "**Option**" - "**Terminal setting**"
  4. Press **▲▼** to select "**Input label**", and then select the name to be displayed
    - If you want to input a desired device name, select "**EDIT**" and determine the name. (Entering Letters page [3-45](#))

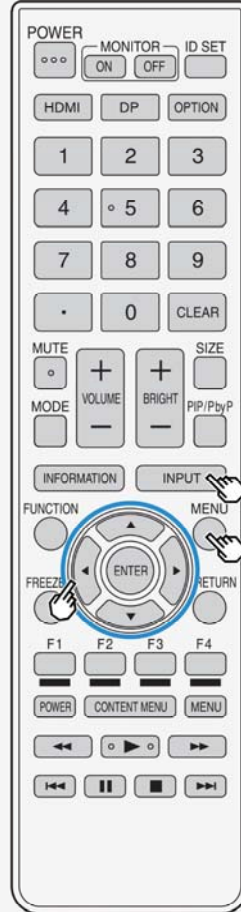

# Contents

- 1. Part Names
- 2. Basic Operation
- 3. Menu Operation
- 4. USB Media
- 5. Connecting Other Devices
  - 1. Connecting 8K Output-compatible Device/Quad-screen display (4K or less)
  - 5. Connecting 4K Output-compatible Device
  - 7. Viewing HDR Video (INPUT1, INPUT7, INPUT8)
  - 9. Using the HDMI CEC
  - 11. Connecting Recorder, Player, etc.
  - 21. Connecting Audio Device
  - 22. Connecting PC
- 6. Operating the Monitor Using a PC (IP control)
- 7. Troubleshooting



## Connecting Other Devices

### Connecting Recorder, Player, etc.

Switching to the screen of a BD recorder, etc.

To skip unused inputs

- Unused inputs (INPUT1 to 4, INPUT6, INPUT7, INPUT8) can be skipped during input change.
1. Press **MENU** to display the Menu, followed by **▲/▼/◀/▶** to select "**Setup**", and then press **ENTER**
  2. Press **▲/▼/◀/▶** to select "**Option**" - "**Terminal setting**"
  3. Press **▲/▼** to select "**Input skip**", and then press **ENTER**
  4. Press **▲/▼** to select an input you want to skip, and then set the input to "**Yes**"
    - To cancel the input skip, select "**No**".

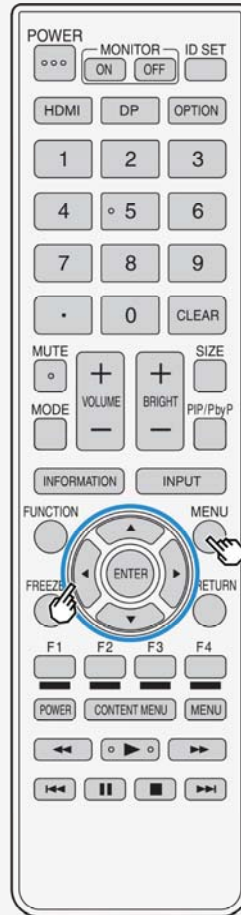

# Contents

1. Part Names
2. Basic Operation
3. Menu Operation
4. USB Media
5. Connecting Other Devices

1. Connecting 8K Output-compatible Device/Quad-screen display (4K or less)

5. Connecting 4K Output-compatible Device

7. Viewing HDR Video (INPUT1, INPUT7, INPUT8)

9. Using the HDMI CEC

11. Connecting Recorder, Player, etc.

21. Connecting Audio Device

22. Connecting PC

6. Operating the Monitor Using a PC (IP control)

7. Troubleshooting

>

<

## Connecting Other Devices

### Connecting Recorder, Player, etc.

Switching to the screen of a BD recorder, etc.

When connecting a video game console.

- You can connect and play video game console in all INPUT. In case you play video game in INPUT7, you can feel better response in PC mode.

# Contents

1.	Part Names
2.	Basic Operation
3.	Menu Operation
4.	USB Media
5.	Connecting Other Devices
1.	Connecting 8K Output-compatible Device/Quad-screen display (4K or less)
5.	Connecting 4K Output-compatible Device
7.	Viewing HDR Video (INPUT1, INPUT7, INPUT8)
9.	Using the HDMI CEC
11.	Connecting Recorder, Player, etc.
21.	Connecting Audio Device
22.	Connecting PC
6.	Operating the Monitor Using a PC (IP control)
7.	Troubleshooting



## Connecting Other Devices

### Connecting Audio Device

- You can connect an audio device to the Monitor and enjoy impressive sound quality and volume.

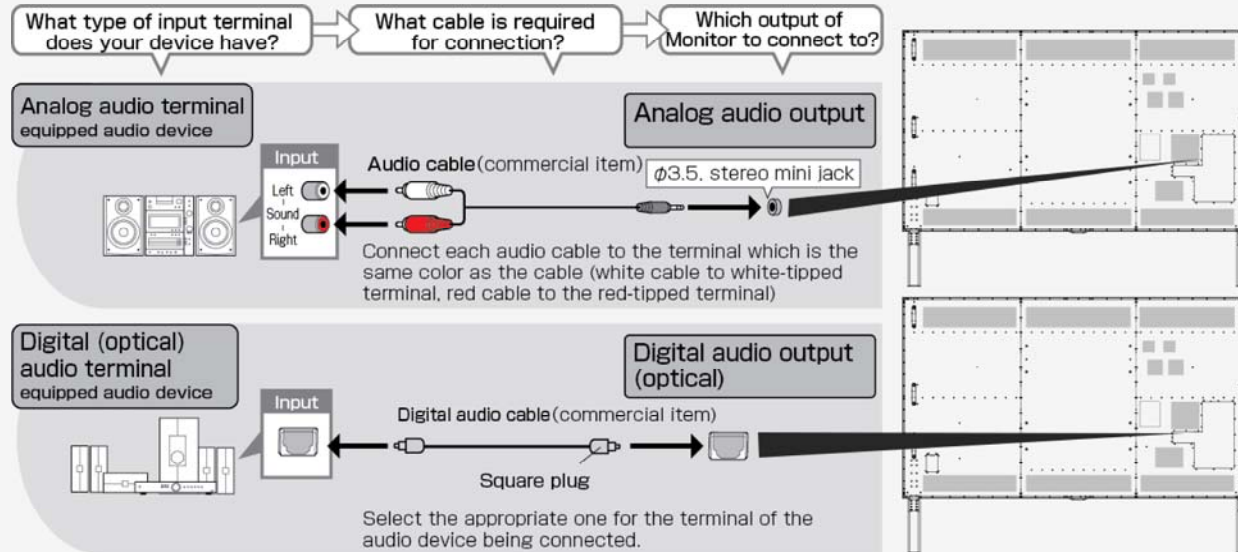

#### NOTE

- The supplied conversion cable cannot be used in analog audio output applications. if the supplied conversion cable is used, one side of the audio will fail to output properly.



# Contents

1.	Part Names
2.	Basic Operation
3.	Menu Operation
4.	USB Media
5.	Connecting Other Devices
1.	Connecting 8K Output-compatible Device/Quad-screen display (4K or less)
5.	Connecting 4K Output-compatible Device
7.	Viewing HDR Video (INPUT1, INPUT7, INPUT8)
9.	Using the HDMI CEC
11.	Connecting Recorder, Player, etc.
21.	Connecting Audio Device
22.	Connecting PC
6.	Operating the Monitor Using a PC (IP control)
7.	Troubleshooting



## Connecting Other Devices

### Connecting PC

#### Using as a monitor for PC

- Before connecting a PC to the Monitor, check the output resolution of the PC. If the PC does not provide support for the following resolutions, the PC screen cannot be displayed on the Monitor.

#### The resolutions supported by this monitor

Resolution (pixel)		Horizontal frequency (kHz)	Vertical frequency (Hz)	VESA standards	Input1	Input2~4	Input6	Input7 A~D	Input8
	720 x 400	31.5	70	No	Yes	Yes	Yes	No	No
VGA	640 x 480	31.5	60	Yes	Yes	Yes	Yes	Yes	Yes
		37.9	72	Yes	Yes	Yes	Yes	No	No
		37.5	75	Yes	Yes	Yes	Yes	No	No
SVGA	800 x 600	35.1	56	Yes	Yes	Yes	Yes	No	No
		37.9	60	Yes	Yes	Yes	Yes	Yes	Yes
		48.1	72	Yes	Yes	Yes	Yes	No	No
XGA	1024 x 768	46.9	75	Yes	Yes	Yes	Yes	No	No
		48.4	60	Yes	Yes	Yes	Yes	Yes	Yes
		56.5	70	Yes	Yes	Yes	Yes	No	No
WXGA	1280 x 768	60.0	75	Yes	Yes	Yes	Yes	No	No
		49.7	60	Yes	Yes	Yes	Yes	Yes	Yes
		47.7	60	Yes	Yes	Yes	Yes	Yes	Yes
SXGA	1280 x 1024	64.0	60	Yes	Yes	Yes	Yes	Yes	Yes
SXGA+	1400 x 1050	65.3	60	Yes	Yes	Yes	Yes	Yes	Yes

# Contents

1.	Part Names
2.	Basic Operation
3.	Menu Operation
4.	USB Media
5.	Connecting Other Devices
1.	Connecting 8K Output-compatible Device/Quad-screen display (4K or less)
5.	Connecting 4K Output-compatible Device
7.	Viewing HDR Video (INPUT1, INPUT7, INPUT8)
9.	Using the HDMI CEC
11.	Connecting Recorder, Player, etc.
21.	Connecting Audio Device
22.	Connecting PC
6.	Operating the Monitor Using a PC (IP control)
7.	Troubleshooting



## Connecting Other Devices

### Connecting PC

Using as a monitor for PC

**The resolutions supported by this monitor**

Resolution (pixel)		Horizontal frequency (kHz)	Vertical frequency (Hz)	VESA standards	Input1	Input2~4	Input6	Input7 A~D	Input8
480p	720 x 480	31.5	60	No	Yes	Yes	No	Yes	Yes
576p	720 x 576	31.3	50	No	Yes	Yes	No	Yes	Yes
1080i	1920 x 1080	28.1	50	No	Yes	Yes	No	Yes	Yes
		33.8	60	No	Yes	Yes	No	Yes	Yes
720p	1280 x 720	22.5	30	No	Yes	Yes	No	No	No
		37.5	50	No	Yes	Yes	No	Yes	Yes
		45.0	60	No	Yes	Yes	No	Yes	Yes
1080p	1920 x 1080	27.0	24	No	Yes	Yes	No	Yes	Yes
		33.8	30	No	Yes	Yes	No	Yes	Yes
		56.3	50	No	Yes	Yes	No	Yes	Yes
4K	3840 x 2160	67.5	60	No	Yes	Yes	Yes	Yes	Yes
		54.0	24	No	Yes	Yes	No	Yes	Yes
		56.3	25	No	Yes	Yes	No	Yes	Yes
		67.5	30	No	Yes	Yes	No	Yes	Yes
		112.5	50	No	Yes	No	No	Yes	Yes
		135.0	60	No	Yes	No	No	Yes	Yes

# Contents

1. Part Names
2. Basic Operation
3. Menu Operation
4. USB Media
5. Connecting Other Devices

1. Connecting 8K Output-compatible Device/Quad-screen display (4K or less)

5. Connecting 4K Output-compatible Device

7. Viewing HDR Video (INPUT1, INPUT7, INPUT8)

9. Using the HDMI CEC

11. Connecting Recorder, Player, etc.

21. Connecting Audio Device

22. Connecting PC

6. Operating the Monitor Using a PC (IP control)

7. Troubleshooting

>

<

## Connecting Other Devices

### Connecting PC

Using as a monitor for PC

#### NOTE

- When a certain type of PC is connected to the Monitor, the PC screen may fail to display properly or completely even if the input signal is supported by the Monitor.
- **"Out of range"** message will be displayed if an unsupported signal is input. In such situation, refer to the operation manual of the connected device and change to the supported signal.
- The selectable screen size may vary depending on the input signal from PC. For information on the screen size types, see page [5-25](#).
- For particular input signals, on-screen letters may appear blurred if certain conditions are met.

# Contents

1.	Part Names
2.	Basic Operation
3.	Menu Operation
4.	USB Media
5.	Connecting Other Devices
1.	Connecting 8K Output-compatible Device/Quad-screen display (4K or less)
5.	Connecting 4K Output-compatible Device
7.	Viewing HDR Video (INPUT1, INPUT7, INPUT8)
9.	Using the HDMI CEC
11.	Connecting Recorder, Player, etc.
21.	Connecting Audio Device
22.	Connecting PC
6.	Operating the Monitor Using a PC (IP control)
7.	Troubleshooting









## Connecting Other Devices

### Connecting PC

Using as a monitor for PC

**Selectable screen size for the Monitor** (The selectable screen sizes may vary depending on the input signal from PC.)

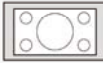
Input signal	Normal	Zoom	Full	Dot by Dot
Video image being vertically longer than 16:9  640×480, 800×600, 1024×768, 1280×1024, etc.	 Appears as shown by the drawing, without disturbing the aspect ratio for the input signal	 Appears enlarged laterally to the limit of the screen. Cuts off the top and bottom of the video image.	 Appears full screen.	 Displayed to the input signal resolution.
16:9 video image 	-	-	 Appears full screen.	 Displayed to the input signal resolution.

# Contents

1.	Part Names
2.	Basic Operation
3.	Menu Operation
4.	USB Media
5.	Connecting Other Devices
1.	Connecting 8K Output-compatible Device/Quad-screen display (4K or less)
5.	Connecting 4K Output-compatible Device
7.	Viewing HDR Video (INPUT1, INPUT7, INPUT8)
9.	Using the HDMI CEC
11.	Connecting Recorder, Player, etc.
21.	Connecting Audio Device
22.	Connecting PC
6.	Operating the Monitor Using a PC (IP control)
7.	Troubleshooting

## Connecting Other Devices

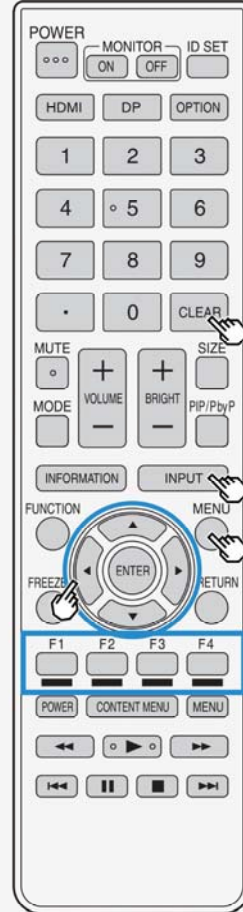

### Connecting PC

Using as a monitor for PC

Displaying the PC screen / selecting the screen size

1. Turn on PC
2. Press **INPUT** to display the input change menu, and after selecting the input to which the PC has been connected with the **▲▼** button, press **ENTER**
  - The PC screen will be displayed.
3. Press **MENU** to display the Menu, select "**Setup**" with the **▲▼/◀▶** and press **ENTER**
4. Press **▲▼/◀▶** to select "**Option**" - "**Option for view**", and press **ENTER**
5. Select "**Wide mode**", and then press **ENTER**
6. Select the desired screen size from the screen size selection menu
  - When you need to adjust the screen, refer to the following.

Adjusting the screen of PC connected to INPUT1 to 4

- Press **MENU** to display the Menu, press **▲▼/◀▶** and **ENTER** to select "**Setup**" - "**Option**" - "**Screen effect**" - "**Position**" to configure the settings. (page [3-41](#))

# Contents

1. Part Names
2. Basic Operation
3. Menu Operation
4. USB Media
5. Connecting Other Devices

1. Connecting 8K Output-compatible Device/Quad-screen display (4K or less)

5. Connecting 4K Output-compatible Device

7. Viewing HDR Video (INPUT1, INPUT7, INPUT8)

9. Using the HDMI CEC

11. Connecting Recorder, Player, etc.

21. Connecting Audio Device

22. Connecting PC

6. Operating the Monitor Using a PC (IP control)

7. Troubleshooting



## Connecting Other Devices

### Connecting PC

When the monitor is connected to a PC with DVI output terminal (digital connection)

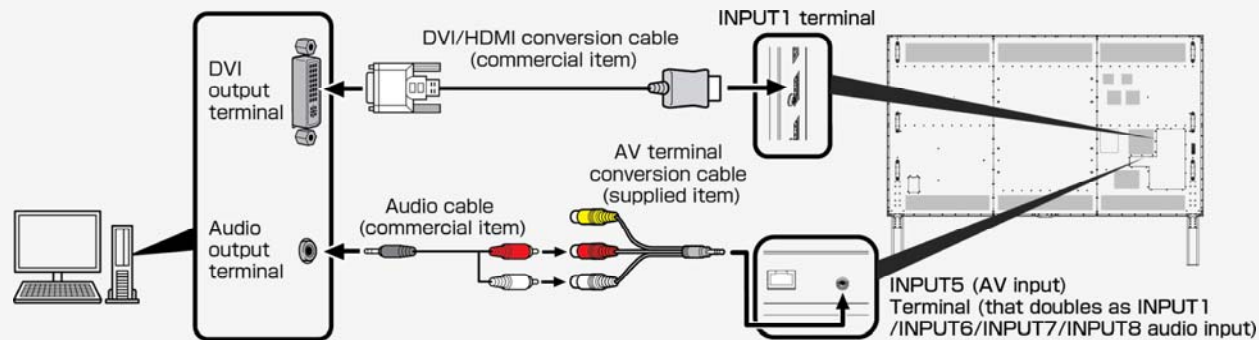

- Be sure to use the supplied conversion cable. When using any conversion cable other than the supplied one, the Monitor may not operate properly, or breakages may occur.
- A commercially available DVI / HDMI conversion cable and an audio cable are required.
- Use an audio cable that is compatible with the terminal of PC.
- The HDMI terminal of the Monitor, and the PC DVI terminal with a conversion cable, the PC screen may not be displayed properly or completely. This is because the cable does not sufficiently meet HDMI standards.
- "This input signal is not supported" message will be displayed when an unsupported signal is input. In such situation, refer to the operation manual of the connected PC and change to the supported signal.
- After switching to INPUT 1, select "**Setup**" - "**Option**" - "**Terminal setting**" - "**INPUT1 audio setting**" from the Menu, and then select "**Analog audio input**".

# Contents

1.	Part Names
2.	Basic Operation
3.	Menu Operation
4.	USB Media
5.	Connecting Other Devices
1.	Connecting 8K Output-compatible Device/Quad-screen display (4K or less)
5.	Connecting 4K Output-compatible Device
7.	Viewing HDR Video (INPUT1, INPUT7, INPUT8)
9.	Using the HDMI CEC
11.	Connecting Recorder, Player, etc.
21.	Connecting Audio Device
22.	Connecting PC
6.	Operating the Monitor Using a PC (IP control)
7.	Troubleshooting



## Connecting Other Devices

### Connecting PC

When the monitor is connected to a PC with HDMI output terminal (digital connection)

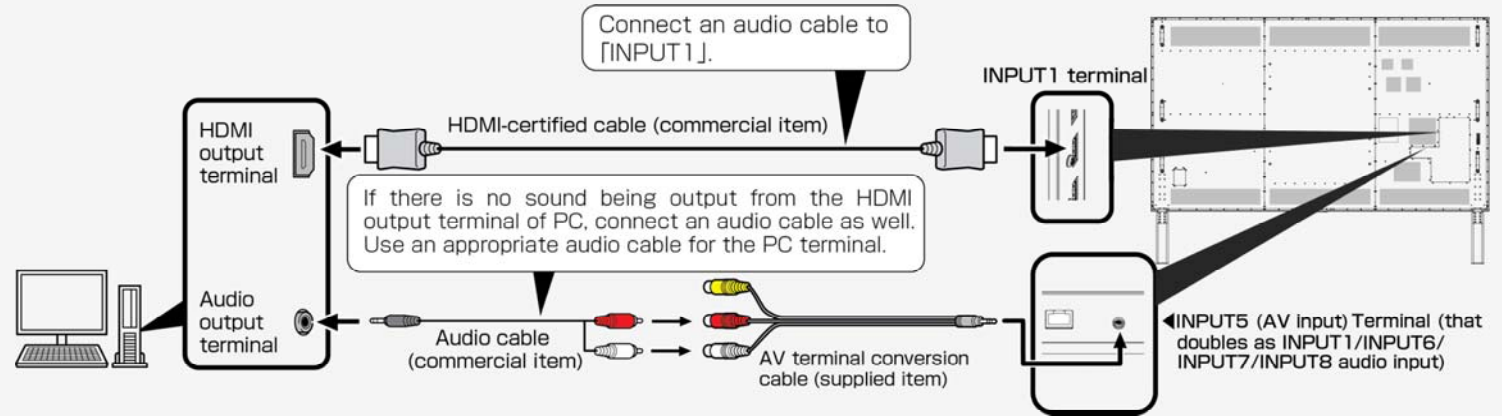

- Be sure to use the supplied conversion cable. When using any conversion cable other than the supplied one, the Monitor may not operate properly, or a part may be broken.
- A commercially available HDMI-certified cable is required.
- After switching to INPUT 1, select **"Setup"** - **"Option"** - **"Terminal setting"** - **"INPUT1 audio setting"** from the Menu, and then select **"Analog audio input"**.

# Contents

1. Part Names
2. Basic Operation
3. Menu Operation
4. USB Media
5. Connecting Other Devices

1. Connecting 8K Output-compatible Device/Quad-screen display (4K or less)

5. Connecting 4K Output-compatible Device

7. Viewing HDR Video (INPUT1, INPUT7, INPUT8)

9. Using the HDMI CEC

11. Connecting Recorder, Player, etc.

21. Connecting Audio Device

22. Connecting PC

6. Operating the Monitor Using a PC (IP control)

7. Troubleshooting



## Connecting Other Devices

### Connecting PC

When the monitor is connected to a PC with analog RGB output terminal (analog connection)

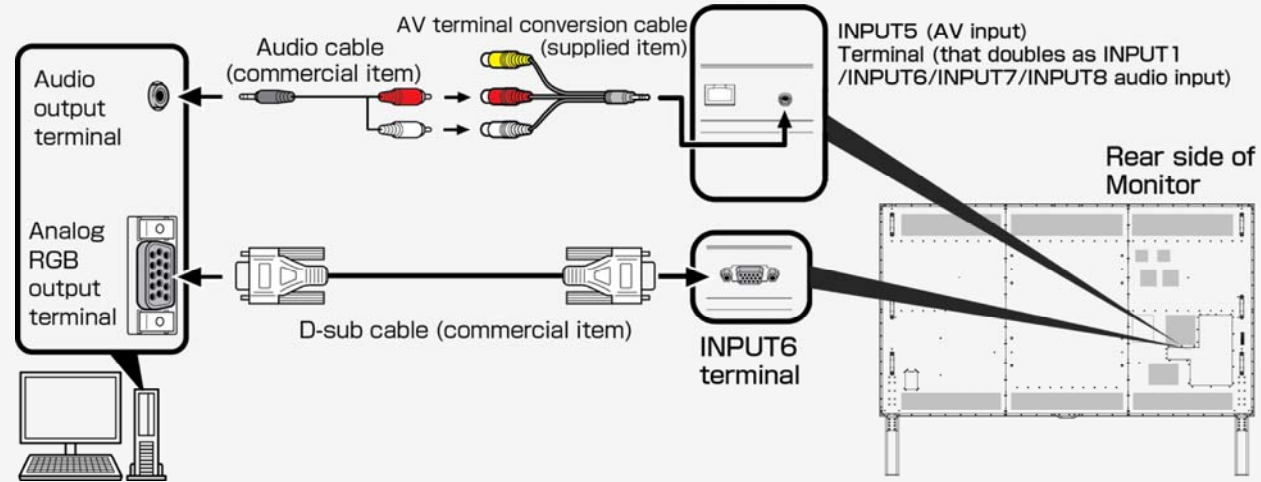

- Be sure to use the supplied conversion cable. When using any conversion cable other than the supplied one, the Monitor may not operate properly, or a part may be broken.
- A commercially available D-sub cable and an audio cable are required.
- Use an audio cable that is compatible with the PC terminal.
- After switching to INPUT 6, select **"Setup"** - **"Option"** - **"Terminal setting"** - **"INPUT6 audio setting"** from the Menu, and then select **"Analog audio input"**.



# Contents

1. Part Names
2. Basic Operation
3. Menu Operation
4. USB Media
5. Connecting Other Devices
6. Operating the Monitor Using a PC (IP control)

1. Connecting the Monitor and PC

3. Settings to operate the Monitor

4. Command list

7. Troubleshooting

8. Specifications, etc.

Ver. 1.00

## Operating the Monitor Using a PC (IP control)

### Connecting the Monitor and PC

- The Monitor is connected using a commercially available LAN cable.

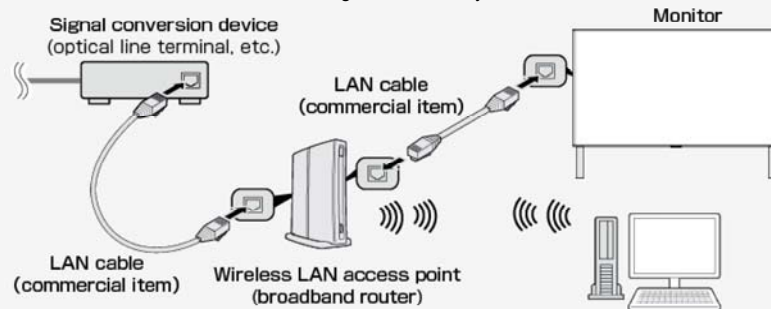

#### NOTE

- When you use a network, your communication data is exposed to the risks of being stolen or illegally accessed. To avoid these risks, you need to use this monitor in a secure network environment.

#### How to communicate

- Send a control command from PC. The Monitor operates according to the transmitted command, and sends a response message back to PC.
- Do not send more than one command at the same time. Send next command from PC after it receives the successful return value (OK).

#### Command (PC to Monitor)

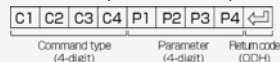

#### Response (Monitor to PC)

When successful



When unsuccessful (in the event of a communication or command error)



# Contents

1. Part Names
2. Basic Operation
3. Menu Operation
4. USB Media
5. Connecting Other Devices
6. Operating the Monitor Using a PC (IP control)

1. Connecting the Monitor and PC

3. Settings to operate the Monitor

4. Command list

7. Troubleshooting

8. Specifications, etc.

Ver. 1.00

>

<

## Operating the Monitor Using a PC (IP control)

### Connecting the Monitor and PC

#### Command and argument

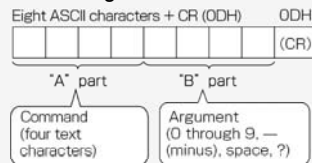

- In the "B" part field, characters should be entered left-aligned, and fill the rest of the field length with spaces. (Must be 4 characters.) If it is outside the settable range, "ERR" is returned.

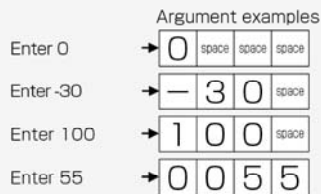

- Any argument shown as "-" in the command list on pages [6-4](#) to [6-7](#) can take on any one of the followings: "0" to "9", "-" (minus), space or "?"
- Certain commands return the currently set value whenever "?" is assigned to their arguments.

#### Argument examples

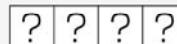
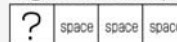

# Contents

1. Part Names
2. Basic Operation
3. Menu Operation
4. USB Media
5. Connecting Other Devices
6. Operating the Monitor Using a PC (IP control)

1. Connecting the Monitor and PC

3. Settings to operate the Monitor

4. Command list

7. Troubleshooting

8. Specifications, etc.

Ver. 1.00



## Operating the Monitor Using a PC (IP control)

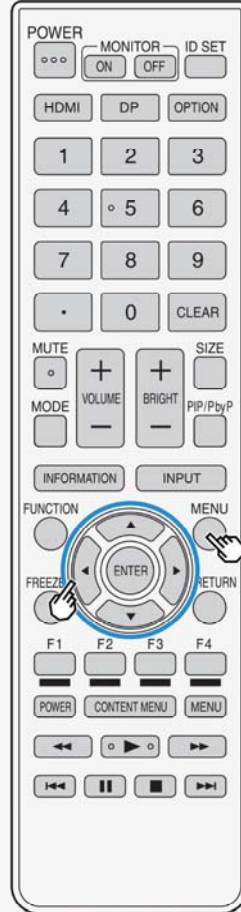

### Settings to operate the Monitor

- This is required to operate the Monitor remotely using a mobile device or PC.
  - Using a terminal emulator, you can perform the Monitor operations, such as volume control and input change.
  - This should be used by those who are computer-literate.
  - For information on connecting to PC, see page [6-1](#).
1. Display the Menu, and select **"Setup"** - **"(Initial setup)"** - **"Network setup"**
  2. Select **"IP Control setup"**
  3. Select **"IP Control setup"**
  4. Select **"Change"** to enable IP control
  5. Select **"Enable"**
  6. Set Login ID and Password
  7. Select **"Next"**
  8. Set Control port
  9. Select **"Next"**
  10. Select **"Completed"**
  11. Follow on-screen instructions to establish the Power Save Mode.
    - To turn on the Monitor using a mobile device or PC while it is in standby mode, you need to set the Power Save Mode to **"Off"**.

# Contents

1. Part Names
2. Basic Operation
3. Menu Operation
4. USB Media
5. Connecting Other Devices
6. Operating the Monitor Using a PC (IP control)
  1. Connecting the Monitor and PC
  2. Settings to operate the Monitor
  3. Settings to operate the Monitor
  4. Command list
7. Troubleshooting
8. Specifications, etc.

Ver. 1.00



## Operating the Monitor Using a PC (IP control)

### Command list

- Any commands not listed in the following table are out of operation guarantee range.

Function		"A"part	"B"part	Part operation description	Remarks
Power		POWR	0	Power off	Transition to standby
			1	Power on	Return from standby*
Input change	Toggle	ITGD	0	(Toggle)	
	INPUT 1 to 4 (HDMI)	IAVD	1 to 4	(Input terminal number)	Change to INPUT 1 to INPUT 4
	INPUT 5 (video)	IAVD	5		Change to INPUT 5
	INPUT 6 (analog RGB)	IAVD	6		Change to INPUT 6
	INPUT 7 (8K: HDMI×4)	IAVD	7		Change to INPUT 7
	INPUT 8 (8K)	IAVD	8		Change to INPUT 8
AV MODE		AVMD	0	(Toggle)	Toggled among currently selectable items
			504	USER1	
			505	USER2	
			506	USER3	
			7	PC	
			500	PC2	
			9	sRGB	
6	DYNAMIC				

# Contents

1. Part Names
2. Basic Operation
3. Menu Operation
4. USB Media
5. Connecting Other Devices
6. Operating the Monitor Using a PC (IP control)

1. Connecting the Monitor and PC

3. Settings to operate the Monitor

4. Command list

7. Troubleshooting

8. Specifications, etc.

Ver. 1.00

>

<

## Operating the Monitor Using a PC (IP control)

### Command list

Function		"A"part	"B"part	Part operation description	Remarks
Picture	Backlight	VLMP	-16 to 16	Backlight setup	
	Contrast	CONT	0 to 40	Contrast setup	
	Brightness	BLVL	-30 to 30	Brightness setup	
	Color	COLR	-30 to 30	Color setup	
	Tint	TINT	-30 to 30	Tint setup	
	Sharpness	SHRP	0 to 20	Sharpness setup	
Volume		VOLM	0 to 100	Volume value	
Balance		SBAL	-30 to 30	Speaker output balance setup	
Screen	Horizontal position	HPOS	*	Moving value	PC input (°)
	Vertical position	VPOS	*	Moving value	PC input (°)
	Clock frequency	CLCK	*	Moving value	PC input (°)
	Clock phase	PHSE	*	Moving value	PC input (°)

\*The range varies depending on input, signal or screen size.

# Contents

1. Part Names
2. Basic Operation
3. Menu Operation
4. USB Media
5. Connecting Other Devices
6. Operating the Monitor Using a PC (IP control)

1. Connecting the Monitor and PC
3. Settings to operate the Monitor
4. Command list

7. Troubleshooting
8. Specifications, etc.

Ver. 1.00



## Operating the Monitor Using a PC (IP control)

### Command list

Function	"A"part	"B"part	Part operation description	Remarks
Screen size	WIDE	0	(Toggle)	Toggles among currently selectable items
		1	Normal	
		2	Smart zoom	
		3	Wide 4:3	
		4	Zoom	
		5	Full	
		6	Full 1	
		7	Full 2	
		8	Underscan	
		9	Dot by Dot	
		10	Wide 16:9	
Mute	MUTE	0	(Toggle)	Toggles between mute states
		1	Mute	
		2	Unmute	
Surround	ACSU	0	(Toggle)	Toggles among surround states
		1	On	
		2	Off	
		3	Auto	
RC control lock	RKLC	0	Off	Unlock "RC control lock"
		1	Lock	Prohibits remote control operation
		2	Lock except power	Prohibits remote control operation except power
		3	Lock except volume	Prohibits remote control operation except volume

# Contents

1.	Part Names
2.	Basic Operation
3.	Menu Operation
4.	USB Media
5.	Connecting Other Devices
6.	Operating the Monitor Using a PC (IP control)
1.	Connecting the Monitor and PC
3.	Settings to operate the Monitor
4.	Command list
7.	Troubleshooting
8.	Specifications, etc.

Ver. 1.00



## Operating the Monitor Using a PC (IP control)

### Command list

Function	"A" part	"B" part	Part operation description	Remarks
Main unit control lock	BKLC	0	Off	Unlock "Main unit control lock"
		1	Lock	Prohibits monitor button operation
Reply product name	RPPN	????		Reply product name
Set displaying OSD	DOSD	0		Display OSD
		1		Not display OSD
Change mode of INPUT 7	CMMD	0	(Toggle)	Toggles among mode 1 ~ 4
		1	Mode1	
		2	Mode2	
		3	Mode3	
		4	Mode4	
		????		Display current mode
Change screen layout of mode1, 3 or 4 of INPUT 7	CMSP	0	(Toggle) or Initialize screen layout	Mode1 : Toggles among INPUT 7-A ~ D Mode3 or 4 : Initialize screen layout
		A		Mode1 : Display screen of INPUT 7-A Mode3 or 4 : Move screen of INPUT 7-A
		B		Mode1 : Display screen of INPUT 7-B Mode3 or 4 : Move screen of INPUT 7-B
		C		Mode1 : Display screen of INPUT 7-C Mode3 or 4 : Move screen of INPUT 7-C
		D		Mode1 : Display screen of INPUT 7-D Mode3 or 4 : Move screen of INPUT 7-D
		****		Mode1 : No operation Mode3 or 4 : Specify INPUT 7-A ~ D any order. (e.g. CMSPBACD)
		????		Mode1 : Check current displaying input Mode3 or 4 : Check current order of inputs

#### NOTE

- For "-" in the "B" part, any of the followings can be entered: "0" to "9", "-" (minus), space or "?".
- The selectable screen size varies depending on the input signal.

# Contents

1. Part Names
2. Basic Operation
3. Menu Operation
4. USB Media
5. Connecting Other Devices
6. Operating the Monitor Using a PC (IP control)
7. Troubleshooting
  1. If You Suspect a Problem
  9. If Error Message Appears
  11. What If
8. Specifications, etc.

Ver. 1.00



## Troubleshooting

### If You Suspect a Problem

- If you encounter a problem, verify the problem before asking for repair.

Check the following;

The power cannot be turned on

Be sure to insert the power cord plug all the way in.



- Place Monitor close to a power outlet so that its power plug is easily accessible.

For power outlet →



# Contents

1. Part Names
2. Basic Operation
3. Menu Operation
4. USB Media
5. Connecting Other Devices
6. Operating the Monitor Using a PC (IP control)
7. Troubleshooting

1. If You Suspect a Problem

9. If Error Message Appears

11. What If

8. Specifications, etc.

Ver. 1.00



## Troubleshooting

### If You Suspect a Problem

Check the following;

The power cannot be turned on (Continue)

If the lamp is not lit, press the power button on the Monitor to turn on the power.

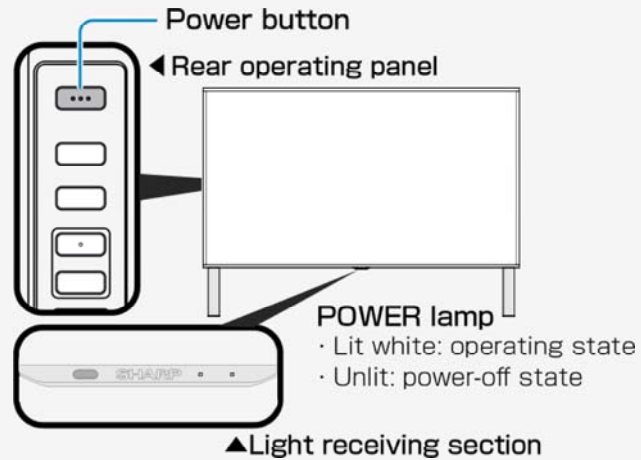

- The POWER lamp stays lit even after the Monitor is turned off by pressing its power button. It can be turned on with the remote control.

# Contents

1. Part Names
2. Basic Operation
3. Menu Operation
4. USB Media
5. Connecting Other Devices
6. Operating the Monitor Using a PC (IP control)
7. Troubleshooting
  1. If You Suspect a Problem
  9. If Error Message Appears
  11. What If
8. Specifications, etc.

Ver. 1.00



## Troubleshooting

### If You Suspect a Problem

#### General

What if	Where to check	Reference page
There is no video and sound output from the Monitor	Is the power plug unplugged from the outlet?	The operation manual supplied with the Monitor "Connecting AC Cord"
	Is the POWER lamp lit white?	<a href="#">2-3</a>
	Is the input changed to a proper source to permit a video from an external device to be played on the Monitor?	<a href="#">5-16</a> to <a href="#">5-17</a>
	Is any connecting cable disconnected?	—
The remote control does not operate	Is the POWER lamp lit white?	<a href="#">2-3</a>
	Isn't the polarity (+, -) of the dry battery reversed?	The operation manual supplied with the Monitor "Preparation and How to Use Remote Control Unit"
	Are the dry batteries for the remote control drained? The higher the use frequency is, the faster the dry batteries may be drained. Whenever there is a sign of draining of a dry battery, such as when the Monitor does not respond to the remote control, replace the dry battery with a new one early.	The operation manual supplied with the Monitor "Preparation and How to Use Remote Control Unit"
	Do you point the remote control toward the light receiving section of the Monitor when using it?	The operation manual supplied with the Monitor "Preparation and How to Use Remote Control Unit"
	You will have difficulty operating the remote control if any of the following apply: <ul style="list-style-type: none"><li>• There is an obstacle between the remote control and the remote control light receiving section of the Monitor.</li><li>• The remote control light receiving section is exposed to direct sunlight or intensified light.</li><li>• Try to angle the light.</li><li>• There is a light source, such as a fluorescent, near the Monitor.</li><li>• A battery terminal is oxidized (darkened)?</li><li>• The room temperature is extremely low.</li></ul>	—

# Contents



- 1. Part Names
- 2. Basic Operation
- 3. Menu Operation
- 4. USB Media
- 5. Connecting Other Devices
- 6. Operating the Monitor Using a PC (IP control)
- 7. Troubleshooting
  - 1. If You Suspect a Problem
  - 9. If Error Message Appears
  - 11. What If
- 8. Specifications, etc.



## Troubleshooting

### If You Suspect a Problem

#### General

What if	Where to check	Reference page
 Video appears on Monitor but no sound comes out of it	Is the volume control set to the minimum level?	<a href="#">2-3</a>
	Is it set to "Mute"?	—
	Is the headphone left plugged into the headphone terminal?	<a href="#">1-2</a>
The audio sound differs in volume level from one input source to another  Video image from a BD player or external device does not appear, or stopped appearing, on the Monitor	Because the input sound level may vary depending on the device connected or the disk played back, the volume can be set per input. Set the volume control for each input.	<a href="#">2-3</a>
	Is the external device unplugged?	—
	Is the external device turned on?	—
	Have you selected the input to which the external device is connected?	<a href="#">5-16</a> to <a href="#">5-17</a>
	For INPUT 5 or INPUT 6, due to the provisions of Advanced Access Content System (AACS), BD videos (commercial blue-ray software) from certain external devices connected to the INPUT cannot be played back on the Monitor.	—
Due to copyright restrictions, videos from certain devices fail to appear on Monitor unless the devices are directly connected to the Monitor through HDMI cable.	—	
 Sound comes out of the Monitor but no video appears on it	Is <b>Audio only</b> set to "On"?	<a href="#">3-24</a>
	Is the video cable disconnected?	<a href="#">5-12</a>
 Faded poorly tinted	Are " <b>Color</b> " and " <b>Tint</b> " for video picture properly adjusted?	<a href="#">3-10</a>
	Due to the viewing angle characteristics of the LC panel, when viewed from an oblique direction, some video pictures may look faded or have a different color tone. This is not a failure.	—

# Contents

1. Part Names
2. Basic Operation
3. Menu Operation
4. USB Media
5. Connecting Other Devices
6. Operating the Monitor Using a PC (IP control)
7. Troubleshooting
  1. If You Suspect a Problem
  9. If Error Message Appears
  11. What If
8. Specifications, etc.

Ver. 1.00

>

<

## Troubleshooting

### If You Suspect a Problem

#### General

What if	Where to check	Reference page
The screen is dim	Change " <b>Picture</b> ".	<a href="#">3-8</a> to <a href="#">3-17</a>
	Adjust " <b>Backlight</b> ".	<a href="#">3-9</a>
	Check " <b>AV Mode</b> ".	<a href="#">3-8</a>
Underexposure	Adjust " <b>Backlight</b> ", " <b>Brightness</b> ", or " <b>Advanced</b> " - " <b>Gamma adjustment</b> ".	<a href="#">3-9</a> , <a href="#">3-15</a>
The display screen increases or decreases in size	Is the Auto Wide function set to " <b>Yes</b> "? Change the setting to " <b>No</b> ".	<a href="#">3-42</a>
The screen flickers or has poor resolution or noise	Set " <b>Noise Reduction</b> " for " <b>Advanced</b> " to " <b>Auto</b> ", " <b>High</b> ", " <b>Middle</b> " or " <b>Low</b> ".	<a href="#">3-16</a>
The monitor gets warm/hot at the top	This is because the Monitor is structured to allow the air heated with the heat from internal circuits to naturally flow out through its top. When the Monitor increases abnormally in temperature, the letters " <b>Temperature</b> " or " <b>Temperature of monitor</b> " blink at the bottom right corner of the screen, causing it to automatically turn off afterwards.	—
The letters " <b>Temperature</b> " or " <b>Temperature of monitor</b> " blink at the bottom right corner of the screen. Subsequent to that, the Monitor turns off automatically.	This is due to an increase in the temperature of the Monitor. Eliminate the cause of the temperature increase.	—
	Check the installation condition or location of the Monitor for potential causes of temperature increase. Install the Monitor so that ventilation holes in its rear are not blocked.	—
	Frequently eliminate any dust settling inside the Monitor or ventilation holes if it is possible to dust from the outside of Monitor.	—

# Contents

1. Part Names
2. Basic Operation
3. Menu Operation
4. USB Media
5. Connecting Other Devices
6. Operating the Monitor Using a PC (IP control)
7. Troubleshooting
  1. If You Suspect a Problem
  9. If Error Message Appears
  11. What If
8. Specifications, etc.

Ver. 1.00

>

<

## Troubleshooting

### If You Suspect a Problem

#### General

What if	Where to check	Reference page
You cannot operate the buttons on the remote control or Monitor	It may be attributable to external or interference noises. Turn off the Monitor with its power button, leave it alone for about a minute after unplugging the power plug, and then plug the power plug back in again to turn its power on.	—
	Isn't the RC control lock set to Lock?	<a href="#">3-27</a>
You hear a crack sometimes	It is a sound of the cabinet slightly expanding or contracting with changes in temperature. It has no impact on performance, etc.	—

# Contents

1. Part Names
2. Basic Operation
3. Menu Operation
4. USB Media
5. Connecting Other Devices
6. Operating the Monitor Using a PC (IP control)
7. Troubleshooting
  1. If You Suspect a Problem
  9. If Error Message Appears
  11. What If
8. Specifications, etc.

Ver. 1.00

>

<

## Troubleshooting

### If You Suspect a Problem

#### General

What if	Where to check	Reference page
Input change does not allow selection	Is the input skip set to "No"?	<a href="#">3-37</a>
The power turns off automatically	Check if the Monitor is in the mode where it is turned off automatically.	—

#### 8K input

What if	Where to check	Reference page
Not shown as 4320p	Check if four HDMI cables are inserted into A to D of INPUT 7. Check the resolution of the output device.	<a href="#">5-1</a> to <a href="#">5-3</a>
No video appears	Any connections to HDMI 1 to 4?	<a href="#">5-1</a> to <a href="#">5-2</a>
No sound is coming out	Go to " <b>INPUT7 audio setting</b> " where you should select the audio input terminal used. The compatible format is Linear PCM only.	<a href="#">5-4</a>

If any problem persists after you try the corresponding solution above, be sure to unplug the power plug and then contact your local distributor.

# Contents

1. Part Names
2. Basic Operation
3. Menu Operation
4. USB Media
5. Connecting Other Devices
6. Operating the Monitor Using a PC (IP control)
7. Troubleshooting
  1. If You Suspect a Problem
  9. If Error Message Appears
  11. What If
8. Specifications, etc.

Ver. 1.00



## Troubleshooting

### If You Suspect a Problem

#### IP control-related

What if	Where to check	Reference page
No IP control	Go to the setup menu, and then "  (Initial Setup)" - "Network Setup" - "IP Control setup". Check if it is set to "Enable".	<a href="#">3-3</a>

# Contents

1. Part Names
2. Basic Operation
3. Menu Operation
4. USB Media
5. Connecting Other Devices
6. Operating the Monitor Using a PC (IP control)
7. Troubleshooting
  1. If You Suspect a Problem
  9. If Error Message Appears
  11. What If
8. Specifications, etc.

Ver. 1.00

>

<

## Troubleshooting

### If Error Message Appears

#### Message concerning USB Media

On-screen error message example	Solution
The power supply requirement of the connected USB device is too large. After turning power off the Monitor, connect only necessary USB devices.	USB inrush current has occurred. It can occur when multiple USB devices are connected to the Monitor. Turn off the Monitor, and then disconnect any unnecessary USB devices.
Cannot display the data.	Data in any format other than JPEG, which is compatible with the Monitor, or corrupted data cannot be displayed.



# Contents

1. Part Names
2. Basic Operation
3. Menu Operation
4. USB Media
5. Connecting Other Devices
6. Operating the Monitor Using a PC (IP control)
7. Troubleshooting
  1. If You Suspect a Problem
  9. If Error Message Appears
  11. What If
8. Specifications, etc.

Ver. 1.00

>

<

## Troubleshooting

### If Error Message Appears

#### Message concerning USB Media

On-screen error message example	Solution
Cannot play. Unable to play this file.	Out-of-spec video data cannot be played back. Check if the video data format can be played back on the Monitor. "About files in USB memory that can be played on Monitor" (see page <a href="#">4-4</a> )
Cannot play. Cannot playback the audio file.	Out-of-spec music data cannot be played back. Check if the music data format can be played back on the Monitor. "About files in USB memory that can be played on Monitor" (see page <a href="#">4-5</a> )

# Contents

1. Part Names
2. Basic Operation
3. Menu Operation
4. USB Media
5. Connecting Other Devices
6. Operating the Monitor Using a PC (IP control)
7. Troubleshooting
  1. If You Suspect a Problem
  9. If Error Message Appears
  11. What If
8. Specifications, etc.

Ver. 1.00



## Troubleshooting

### What If

#### If the Monitor cannot be operated

- If the Monitor is exposed to intensive external noise (very large amount of static electricity, source voltage error caused by lighting strike, etc.), or if you operate the Monitor in an improper manner, an error may result, such as failure to operate or control the Monitor.
- In such a case, press the power button on the Monitor to temporarily turn the power off, and then turn the power back on to retry an operation that previously failed.
- If you still fail to operate the Monitor even after turning the power on again, keep pressing the power button on the Monitor for at least five seconds. That turns off the Monitor. Wait about a minute before pressing the power button to turn the Monitor back on, and then retry the operation again. Even after these button operations above, setting items such as menu are retained.

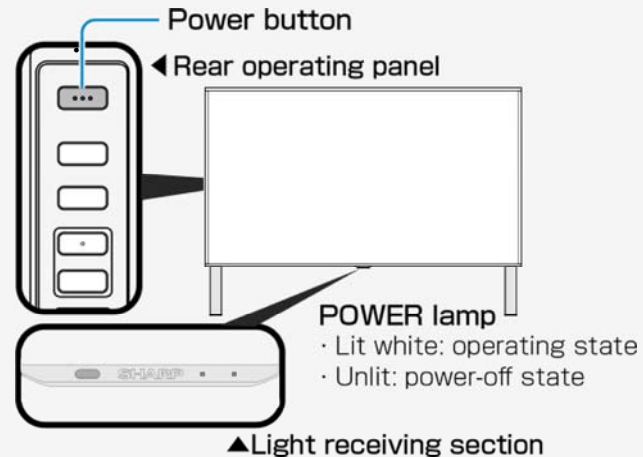

#### NOTE

Since data is loaded into the Monitor immediately after it is turned back on, it takes some time before a screen is displayed.

# Contents

1.	Part Names
2.	Basic Operation
3.	Menu Operation
4.	USB Media
5.	Connecting Other Devices
6.	Operating the Monitor Using a PC (IP control)
7.	Troubleshooting
8.	Specifications, etc.
1.	PC Supported signal timing
2.	AV Supported signal timing
4.	Dimensional Drawing
5.	Software License

Ver. 1.00



## Specifications, etc.

### PC Supported signal timing

Resolution (pixel)		Horizontal frequency (kHz)	Vertical frequency (Hz)	Input1	Input2~4	Input6	Input7 A~D	Input8
VESA	640 x 480	31.5	60	Yes	Yes	Yes	Yes	Yes
		37.9	72	Yes	Yes	Yes	No	No
		37.5	75	Yes	Yes	Yes	No	No
	800 x 600	35.1	56	Yes	Yes	Yes	No	No
		37.9	60	Yes	Yes	Yes	Yes	Yes
		48.1	72	Yes	Yes	Yes	No	No
		46.9	75	Yes	Yes	Yes	No	No
	1024 x 768	48.4	60	Yes	Yes	Yes	Yes	Yes
		56.5	70	Yes	Yes	Yes	No	No
		60.0	75	Yes	Yes	Yes	No	No
	1280 x 800	49.7	60	Yes	Yes	Yes	Yes	Yes
	1366 x 768	47.7	60	Yes	Yes	Yes	Yes	Yes
	1280 x 1024	64.0	60	Yes	Yes	Yes	Yes	Yes
	1400 x 1050	65.3	60	Yes	Yes	Yes	Yes	Yes

- Depending on the PC connected, even the supported signals above may not be transmitted or displayed properly.
- For 8K input, see page [7-7](#).

# Contents

- 1. Part Names
- 2. Basic Operation
- 3. Menu Operation
- 4. USB Media
- 5. Connecting Other Devices
- 6. Operating the Monitor Using a PC (IP control)
- 7. Troubleshooting
- 8. Specifications, etc.
  - 1. PC Supported signal timing
  - 2. AV Supported signal timing
  - 4. Dimensional Drawing
  - 5. Software License



## Specifications, etc.

### AV Supported signal timing

Resolution (pixel)		Horizontal frequency (kHz)	Vertical frequency (Hz)	Input1	Input2~4	Input6	Input7 A~D	Input8
	720 x 400	31.5	70	Yes	Yes	Yes	No	No
480i	720(1440)x480i	15.7	59.94	Yes	Yes	No	No	No
		15.8	60	Yes	Yes	No	No	No
576i	720(1440)x576i	15.6	50	Yes	Yes	No	No	No
480p	720x480	31.5	59.94	Yes	Yes	No	Yes	Yes
		31.5	60	Yes	Yes	No	Yes	Yes
576p	720x576	31.3	50	Yes	Yes	No	Yes	Yes
1080i	1920x1080	28.1	50	Yes	Yes	No	Yes	Yes
		33.7	59.94	Yes	Yes	No	Yes	Yes
		33.8	60	Yes	Yes	No	Yes	Yes
720p	1280x720	22.5	29.94	Yes	Yes	No	No	No
		22.5	30	Yes	Yes	No	No	No
		37.5	50	Yes	Yes	No	Yes	Yes
		45.0	59.94	Yes	Yes	No	Yes	Yes
		45.0	60	Yes	Yes	No	Yes	Yes
1080p	1920x1080	27.0	24	Yes	Yes	No	Yes	Yes
		33.7	29.97	Yes	Yes	No	Yes	Yes
		33.8	30	Yes	Yes	No	Yes	Yes
		56.3	50	Yes	Yes	No	Yes	Yes
		67.4	59.94	Yes	Yes	Yes	Yes	Yes
		67.5	60	Yes	Yes	Yes	Yes	Yes

# Contents

1.	Part Names
2.	Basic Operation
3.	Menu Operation
4.	USB Media
5.	Connecting Other Devices
6.	Operating the Monitor Using a PC (IP control)
7.	Troubleshooting
8.	Specifications, etc.

1.	PC Supported signal timing
2.	AV Supported signal timing
4.	Dimensional Drawing
5.	Software License

Ver. 1.00



## Specifications, etc.

### AV Supported signal timing

Resolution (pixel)		Horizontal frequency (kHz)	Vertical frequency (Hz)	Input1	Input2~4	Input6	Input7 A~D	Input8
4K	3840x2160	54.0	24	Yes	Yes	No	Yes	Yes
		56.3	25	Yes	Yes	No	Yes	Yes
		67.4	29.97	Yes	Yes	No	Yes	Yes
		67.5	30	Yes	Yes	No	Yes	Yes
		112.5	50	Yes	Yes	No	Yes	Yes
		134.9	59.94	Yes	Yes	No	Yes	Yes
8K	7680x4320	220.0	50	No	No	No	No	Yes
		263.7	59.94	No	No	No	No	Yes
		264.0	60	No	No	No	No	Yes

#### DDC (Plug & Play)

- The Monitor supports VESA Display Data Channel (DDC) Standard.
- DDC is a signal standard for Plug and Play between display and PC.
- Information such as the one about resolution, etc. is transmitted between the display and the PC.
- This feature is enabled when PC is DDC-compatible and set to detect a Plug and Play monitor.
- There are different types of DDC, depending on the communication system.
- The Monitor is DDC2B-compliant.

# Contents

1. Part Names
2. Basic Operation
3. Menu Operation
4. USB Media
5. Connecting Other Devices
6. Operating the Monitor Using a PC (IP control)
7. Troubleshooting
8. Specifications, etc.

1. PC Supported signal timing
2. AV Supported signal timing
4. Dimensional Drawing
5. Software License

Ver. 1.00



## Specifications, etc.

### Dimensional Drawing

Note that the values shown are approximate values.

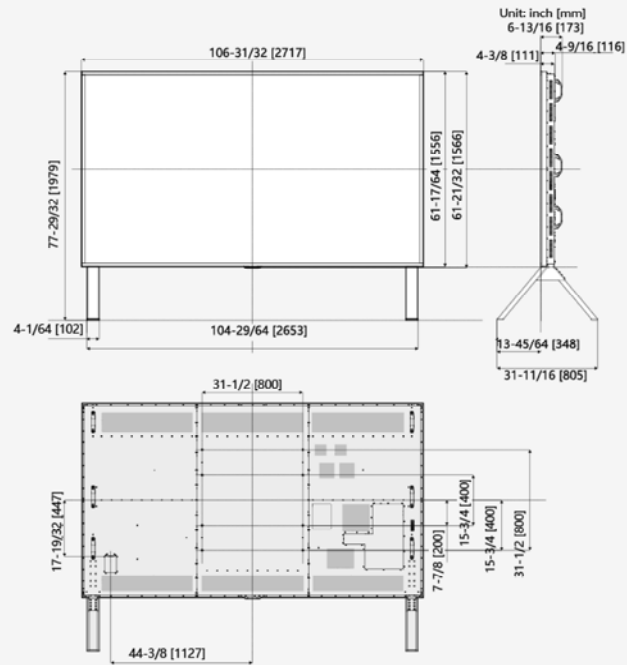

# Contents

1. Part Names
2. Basic Operation
3. Menu Operation
4. USB Media
5. Connecting Other Devices
6. Operating the Monitor Using a PC (IP control)
7. Troubleshooting
8. Specifications, etc.
  1. PC Supported signal timing
  2. AV Supported signal timing
  4. Dimensional Drawing
  5. Software License

Ver. 1.00



## Specifications, etc.

### Software License

Information on the open-source software license.

#### Software composition

The software included in this product is comprised of various software components whose individual copyrights are held by third parties.

This product also makes use of freely distributed software and software components whose copyrights are held by third parties. These include software components covered by a GNU General Public License (hereafter GPL), a GNU Lesser General Public License (hereafter LGPL) or other license agreement.

#### Obtaining source code

Some of the open source software licensors require the distributor to provide the source code with the executable software components. GPL and LGPL include similar requirements. For information on obtaining the source code for the open source software and for obtaining the GPL, LGPL, and other license agreement information, visit the following website.

[https://jp.sharp/business/lcd-display/support/download/source\\_e.html](https://jp.sharp/business/lcd-display/support/download/source_e.html)

We are unable to answer any questions about the source code for the open source software. The source code for the software components whose copyrights are held by SHARP is not distributed.

# Contents

1. Part Names
2. Basic Operation
3. Menu Operation
4. USB Media
5. Connecting Other Devices
6. Operating the Monitor Using a PC (IP control)
7. Troubleshooting
8. Specifications, etc.
  1. PC Supported signal timing
  2. AV Supported signal timing
  4. Dimensional Drawing
  5. Software License

Ver. 1.00



## Specifications, etc.

### Software License

Information on licenses of software used in the Monitor

#### NOTE

- Select "Setup" -  "Information" - "Software license" on the MENU to display the information concerning the licenses of software used for the Monitor.

LCフォント、LCFONT、エルシーフォント and LC logo mark are registered trademarks of SHARP Corporation. This product is embedded with LC Font technology, which was developed by SHARP Corporation for clearly displaying easy-to-read characters on an LCD screen. However, other non-LCD fonts are used for displaying some screen pages.



# Contents

1.	Part Names
2.	Basic Operation
3.	Menu Operation
4.	USB Media
5.	Connecting Other Devices
6.	Operating the Monitor Using a PC (IP control)
7.	Troubleshooting
8.	Specifications, etc.
1.	PC Supported signal timing
2.	AV Supported signal timing
4.	Dimensional Drawing
5.	Software License

Ver. 1.00



## Specifications, etc.

### Software License

Trademark, Registered Trademark, etc.

- Manufactured under license from Dolby Laboratories. Dolby, Dolby Audio and the double-D symbol are trademarks of Dolby Laboratories.
- The terms HDMI, HDMI High-Definition Multimedia Interface, and the HDMI Logo are trademarks or registered trademarks of HDMI Licensing Administrator, Inc.
- VESA is either registered trademark or trademark of Video Electronics Standards Association in the United States and/or other countries.
- All other brand and product names are trademarks or registered trademarks of their respective holders.



<http://www.espial.com>

- THIS PRODUCT IS LICENSED UNDER THE AVC PATENT PORTFOLIO LICENSE FOR THE PERSONAL USE OF A CONSUMER OR OTHER USES IN WHICH IT DOES NOT RECEIVE REMUNERATION TO (i) ENCODE VIDEO IN COMPLIANCE WITH THE AVC STANDARD ("AVC VIDEO") AND/OR (ii) DECODE AVC VIDEO THAT WAS ENCODED BY A CONSUMER ENGAGED IN A PERSONAL ACTIVITY AND/OR WAS OBTAINED FROM A VIDEO PROVIDER LICENSED TO PROVIDE AVC VIDEO. NO LICENSE IS GRANTED OR SHALL BE IMPLIED FOR ANY OTHER USE. ADDITIONAL INFORMATION MAY BE OBTAINED FROM MPEG LA, L.L.C. SEE [HTTP://WWW.MPEGLA.COM](http://www.MPEGLA.COM)
- THIS PRODUCT IS LICENSED UNDER THE MPEG-4 VISUAL PATENT PORTFOLIO LICENSE FOR THE PERSONAL AND NON-COMMERCIAL USE OF A CONSUMER FOR (i) ENCODING VIDEO IN COMPLIANCE WITH THE MPEG-4 VISUAL STANDARD ("MPEG-4 VIDEO") AND/OR (ii) DECODING MPEG-4 VIDEO THAT WAS ENCODED BY A CONSUMER ENGAGED IN A PERSONAL AND NON-COMMERCIAL ACTIVITY AND/OR WAS OBTAINED FROM A VIDEO PROVIDER LICENSED BY MPEG LA TO PROVIDE MPEG-4 VIDEO. NO LICENSE IS GRANTED OR SHALL BE IMPLIED FOR ANY OTHER USE. ADDITIONAL INFORMATION INCLUDING THAT RELATING TO PROMOTIONAL, INTERNAL AND COMMERCIAL USES AND LICENSING MAY BE OBTAINED FROM MPEG LA, L.L.C. SEE [HTTP://WWW.MPEGLA.COM](http://www.MPEGLA.COM)