

SHARP®

AQUOS

LC-70LE660U
LC-60LE660U
LC-80LE661U
LC-70LE661U
LC-60LE661U

LC-70C6600U
LC-60C6600U
LC-70EQ30U
LC-60EQ30U

LIQUID CRYSTAL TELEVISION
TÉLÉVISEUR À CRISTAUX
LIQUIDES
TELEVISOR DE CRISTAL
LÍQUIDO

OPERATION MANUAL
MODE D'EMPLOI
MANUAL DEL USUARIO

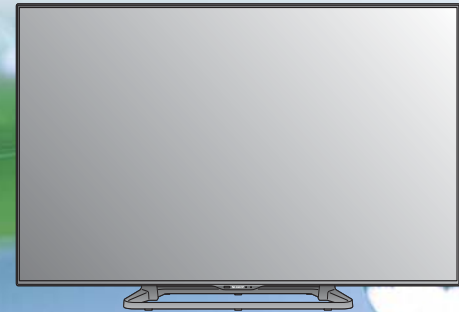

Contents

- 1. Part Names**
 - 1-1. TV
 - 1-2. Remote Control Unit
- 2. Watching TV**
 - 2-1. Displaying an External Equipment Image
 - 2-2. Initial Installation
- 3. Direct Button Operation**
 - 3-1. Changing Channels
 - 3-2. Changing Volume
 - 3-3. MUTE
 - 3-4. FREEZE
 - 3-5. FLASHBACK
 - 3-6. SmartCentral
 - 3-7. NETFLIX
 - 3-8. AUDIO
 - 3-9. Sleep Timer
 - 3-10. AV MODE
 - 3-12. Closed Captions and Digital Closed Captions
 - 3-14. VIEW MODE
- 4. On-Screen Display Menu**
 - 4-1. Introduction
 - 4-3. On-Screen Display Menu Operation
 - 4-4. Menu Operation Buttons
 - 4-5. Initial Setup
 - 4-14. Information
 - 4-17. Picture Settings
 - 4-21. Audio Settings
 - 4-22. Smart TV
 - 4-25. System Options
- 5. Enjoying Photo/Music/Video Playback**
 - 5-1. Preparation
 - 5-2. Selecting the Folders to Play Back
 - 5-4. Playing Back Files on a USB Memory Device/Home Network Server
 - 5-9. Presetting Remote Control Function
 - 5-12. Operating the Connected Equipment
- 6. Using LINK Operation**
 - 6-1. Controlling HDMI Equipment Using LINK Operation
 - 6-3. Link Operation Menu
 - 6-5. Using a Smartphone with the TV
- 7. Using a PC**
 - 7-1. Adjusting the PC Image
 - 7-2. Setting Audio Input
 - 7-3. Control of the TV
 - 7-9. PC Compatibility Chart
- 8. Using the Internet**
 - 8-1. Connecting to the Internet
 - 8-2. Internet Setup
 - 8-5. Entering Text (Software Keyboard)
 - 8-7. Using the Browser
 - 8-11. Using Keyboard and Mouse
 - 8-12. Using Applications via the Internet
 - 8-14. Notes
- 9. Using the Miracast devices**
 - 9-1. Miracast devices
- 10. Appendix**
 - 10-1. Removing the Stand
 - 10-2. Setting the TV on the Wall
 - 10-6. Troubleshooting
- 11. Specifications**
 - 11-1. TV (For LE660 and C6600U models)
 - 11-2. TV (For LE661U model)
 - 11-3. TV (For EQ30U model)
 - 11-4. Wireless LAN
- 12-1. Trademarks**
- 13. Dimensional Drawings**
- 14. SmartCentral Terms of Use / Privacy Policy**
- 15. Software License**

IMPORTANT INFORMATION

IMPORTANT:

To aid reporting in case of loss or theft, please record the TV's model and serial numbers in the space provided. The numbers are located at the rear and left side of the TV.

Model No.:

Serial No.:

WARNING: TO REDUCE THE RISK OF FIRE OR ELECTRIC SHOCK, DO NOT EXPOSE THIS PRODUCT TO RAIN OR MOISTURE.

CAUTION

RISK OF ELECTRIC SHOCK
DO NOT OPEN



The lightning flash with arrow-head symbol, within an equilateral triangle, is intended to alert the user to the presence of uninsulated "dangerous voltage" within the product's enclosure that may be of sufficient magnitude to constitute a risk of electric shock to persons.



The exclamation point within a triangle is intended to alert the user to the presence of important operating and maintenance (servicing) instructions in the literature accompanying the product.

CAUTION: TO REDUCE THE RISK OF ELECTRIC SHOCK,
DO NOT REMOVE COVER (OR BACK).
NO USER-SERVICEABLE PARTS INSIDE.
REFER SERVICING TO QUALIFIED SERVICE
PERSONNEL.

CAUTION: TO PREVENT ELECTRIC SHOCK, MATCH WIDE BLADE OF PLUG TO WIDE SLOT, FULLY INSERT.

WARNING: FCC Regulations state that any unauthorized changes or modifications to this equipment not expressly approved by the manufacturer could void the user's authority to operate this equipment.

CAUTION: This product satisfies FCC regulations when shielded cables and connectors are used to connect the unit to other equipment. To prevent electromagnetic interference with electric appliances such as radios and televisions, use shielded cables and connectors for connections.

DECLARATION OF CONFORMITY:

SHARP LIQUID CRYSTAL TELEVISION, MODEL LC-70LE660U/LC-60LE660U/LC-80LE661U/LC-70LE661U/LC-60LE661U/LC-70C6600U/LC-80C6600U/LC-70EQ30U/LC-80EQ30U
This device complies with Part 15 of the FCC Rules. Operation is subject to the following two conditions:
(1) This device may not cause harmful interference, and (2) this device must accept any interference received, including interference that may cause undesired operation.

RESPONSIBLE PARTY:

SHARP ELECTRONICS CORPORATION
1 Sharp Plaza, Suite 1, Mahwah, NJ 07495-1123
TEL: 1-800-BE-SHARP

For Business Customers: URL <http://www.sharppusa.com>

INFORMATION:

This equipment has been tested and found to comply with the limits for a Class B digital device, pursuant to Part 15 of the FCC Rules. These limits are designed to provide reasonable protection against harmful interference in a residential installation. This equipment generates, uses and can radiate radio frequency energy and, if not installed and used in accordance with the instructions, may cause harmful interference to radio communications. However, there is no guarantee that interference will not occur in a particular installation. If this equipment does cause harmful interference to radio or television reception, which can be determined by turning the equipment off and on, the user is encouraged to try to correct the interference by one or more of the following measures:

- Reorient or relocate the receiving antenna.
- Increase the separation between the equipment and receiver.
- Connect the equipment into an outlet on a circuit different from that to which the receiver is connected.
- Consult the dealer or an experienced radio/TV technician for help.

IMPORTANT INFORMATION

FCC Compliance Statement

This device complies with part 15 of the FCC Rules. Operation is subject to the following two conditions:
(1) This device may not cause harmful interference, and (2) this device must accept any interference received, including interference that may cause undesired operation.

Wireless Radio

For product available in the USA/Canada market, only channel 1–11 can be operated. Selection of other channels is not possible. This device is going to be operated in 2.412–2.462GHz frequency range.

Important: Any changes or modifications not expressly approved by the party responsible for compliance could void the user's authority to operate the equipment.

FCC Radiation Exposure Statement: This equipment complies with FCC radiation exposure limits set forth for an uncontrolled environment. This equipment should be installed and operated with minimum distance 20cm between the radiator & your body.

Industry Canada Statement

This Class B digital apparatus complies with CAN ICES-003(B)/NMB-3(E)

Wireless Radio

For product available in the USA/Canada market, only channel 1–11 can be operated. Selection of other channels is not possible.

The device could automatically discontinue transmission in case of absence of information to transmit, or operational failure.

Note that this is not intended to prohibit transmission of control or signaling information or the use of repetitive codes where required by the technology.

Important: Any changes or modifications not expressly approved by the party responsible for compliance could void the user's authority to operate the equipment.

IC Radiation Exposure Statement: This device complies with IC RSS-210 rules; Operation is subject to the following two conditions:

(1) This device may not cause harmful interference, and (2) this device must accept interference received, including interference that may cause undesired operation.

"Note to CATV system installer: This reminder is provided to call the CATV system installer's attention to Article 820 of the National Electrical Code that provides guidelines for proper grounding and, in particular, specifies that the cable ground shall be connected to the grounding system of the building, as close to the point of cable entry as practical."

This product qualifies for ENERGY STAR when "Home" is selected for "TV Location".
Setting "TV Location" to "Home" allows the TV to achieve an energy-saving status for household use.

DEAR SHARP CUSTOMER

Thank you for your purchase of the Sharp Liquid Crystal Television. To ensure safety and many years of trouble-free operation of your product, please read the Important Safety Instructions carefully before using this product.

IMPORTANT SAFETY INSTRUCTIONS

Electricity is used to perform many useful functions, but it can also cause personal injuries and property damage if improperly handled. This product has been engineered and manufactured with the highest priority on safety. However, improper use can result in electric shock and/or fire. In order to prevent potential danger, please observe the following instructions when installing, operating and cleaning the product. To ensure your safety and prolong the service life of your Liquid Crystal Television, please read the following precautions carefully before using the product.

- 1) Read these instructions.
- 2) Keep these instructions.
- 3) Heed all warnings.
- 4) Follow all instructions.
- 5) Do not use this apparatus near water.
- 6) Clean only with dry cloth.
- 7) Do not block any ventilation openings. Install in accordance with the manufacturer's instructions.
- 8) Do not install near any heat sources such as radiators, heat registers, stoves, or other apparatus (including amplifiers) that produce heat.
- 9) Do not defeat the safety purpose of the polarized or grounding-type plug. A polarized plug has two blades with one wider than the other. A grounding type plug has two blades and a third grounding prong. The wide blade or the third prong are provided for your safety. If the provided plug does not fit into your outlet, consult an electrician for replacement of the obsolete outlet.
- 10) Protect the power cord from being walked on or pinched particularly at plugs, convenience receptacles, and the point where they exit from the apparatus.
- 11) Only use attachments/accessories specified by the manufacturer.
- 12) Use only with the cart, stand, tripod, bracket, or table specified by the manufacturer, or sold with the apparatus. When a cart is used, use caution when moving the cart/apparatus combination to avoid injury from tip-over.
- 13) Unplug this apparatus during lightning storms or when unused for long periods of time.
- 14) Refer all servicing to qualified service personnel. Servicing is required when the apparatus has been damaged in any way, such as power-supply cord or plug is damaged, liquid has been spilled or objects have fallen into the apparatus, the apparatus has been exposed to rain or moisture, does not operate normally, or has been dropped.



Additional Safety Information

- 15) Power Sources— This product should be operated only from the type of power source indicated on the marking label. If you are not sure of the type of power supply to your home, consult your product dealer or local power company. For products intended to operate from battery power, or other sources, refer to the operating instructions.
- 16) Overloading— Do not overload wall outlets, extension cords, or integral convenience receptacles as this can result in a risk of fire or electric shock.
- 17) Object and Liquid Entry— Never push objects of any kind into this product through openings as they may touch dangerous voltage points or short-out parts that could result in a fire or electric shock. Never spill liquid of any kind on the product.
- 18) Damage Requiring Service— Unplug this product from the wall outlet and refer servicing to qualified service personnel under the following conditions:
 - a) When the AC cord or plug is damaged,
 - b) If liquid has been spilled, or objects have fallen into the product,
 - c) If the product has been exposed to rain or water,
 - d) If the product does not operate normally by following the operating instructions.Adjust only those controls that are covered by the operating instructions as an improper adjustment of other controls may result in damage and will often require extensive work by a qualified technician to restore the product to its normal operation,
 - e) If the product has been dropped or damaged in any way, and

IMPORTANT SAFETY INSTRUCTIONS

- f) When the product exhibits a distinct change in performance - this indicates a need for service.
- 19) Replacement Parts— When replacement parts are required, be sure the service technician has used replacement parts specified by the manufacturer or have the same characteristics as the original part. Unauthorized substitutions may result in fire, electric shock, or other hazards.
- 20) Safety Check— Upon completion of any service or repairs to this product, ask the service technician to perform safety checks to determine that the product is in proper operating condition.
- 21) Wall or ceiling mounting— When mounting the product on a wall or ceiling, be sure to install the product according to the method recommended by the manufacturer.

- Outdoor Antenna Grounding — If an outside antenna is connected to the television equipment, be sure the antenna system is grounded so as to provide some protection against voltage surges and built-up static charges. Article 810 of the National Electrical Code, ANSI/NFPA 70, provides information with regard to proper grounding of the mast and supporting structure, grounding of the lead-in wire to an antenna discharge unit, size of grounding conductors, location of antenna-discharge unit, connection to grounding electrodes, and requirements for the grounding electrode.

EXAMPLE OF ANTENNA GROUNDING AS PER NATIONAL ELECTRICAL CODE, ANSI/NFPA 70

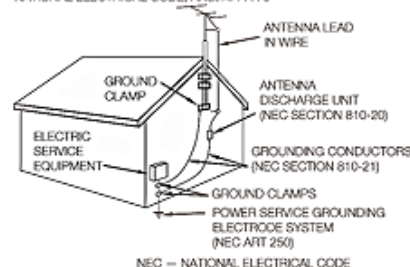

NEC — NATIONAL ELECTRICAL CODE

- Water and Moisture — Do not use this product near water - for example, near a bath tub, wash bowl, kitchen sink, or laundry tub; in a wet basement; or near a swimming pool; and the like.
- Stand — Do not place the product on an unstable cart, stand, tripod or table. Placing the product on an unstable base can cause the product to fall, resulting in serious personal injuries as well as damage to the product. Use only a cart, stand, tripod, bracket or table recommended by the manufacturer or sold with the product. When mounting the product on a wall, be sure to follow the manufacturer's instructions. Use only the mounting hardware recommended by the manufacturer.
- Selecting the location — Select a place with no direct sunlight and good ventilation.
- Ventilation — The vents and other openings in the cabinet are designed for ventilation. Do not cover or block these vents and openings since insufficient ventilation can cause overheating and/or shorten the life of the product. Do not place the product on a bed, sofa, rug or other similar surface, since they can block ventilation openings. This product is not designed for built-in installation; do not place the product in an enclosed place such as a bookcase or rack, unless proper ventilation is provided or the manufacturer's instructions are followed.
- The front panel used in this product is made of glass. Therefore, it can break when the product is dropped or applied with impact. Be careful not to be injured by broken glass pieces in case the panel breaks.
- Heat — The product should be situated away from heat sources such as radiators, heat registers, stoves, or other products (including amplifiers) that produce heat.
- The Liquid Crystal panel is a very high technology product with 2,073,600 pixels, giving you fine picture details. Occasionally, a few non-active pixels may appear on the screen as a fixed point of blue, green or red (LE660U and LE661U models); blue, green, red, or yellow (EQ30U model). Please note that this does not affect the performance of your product.
- Lightning — For added protection for this television equipment during a lightning storm, or when it is left unattended and unused for long periods of time, unplug it from the wall outlet and disconnect the antenna. This will prevent damage to the equipment due to lightning and power-line surges.
- Power Lines — An outside antenna system should not be located in the vicinity of overhead power lines or other electric light or power circuits, or where it can fall into such power lines or circuits. When installing an outside antenna system, extreme care should be taken to keep from touching such power lines or circuits as contact with them might be fatal.
- To prevent fire, never place any type of candle or flames on the top or near the TV set.

IMPORTANT SAFETY INSTRUCTIONS

- Do not display a still picture for a long time, as this could cause an afterimage to remain.
- To prevent fire or shock hazard, do not expose this product to dripping or splashing. No objects filled with liquids, such as vases, should be placed on the product.
- Do not insert foreign objects into the product. Inserting objects in the air vents or other openings may result in fire or electric shock. Exercise special caution when using the product around children.

Precautions when transporting the TV

- When transporting the TV, never carry it by holding or otherwise putting pressure onto the display. Be sure to always carry the TV by two people (80 inch model: three people) holding it with two hands.

Do not install the TV in a location in which it will be subject to water drops such as underneath an air conditioning unit or in the vicinity of a humidifier

- Water drops falling onto the TV and water entering inside it may result in fire, electric shock, or malfunctions.
- We recommend that you install the TV at least 3.3 ft (1m) away from the outlet of an air conditioner.



Caring for the cabinet

- Use a soft cloth (cotton, flannel, etc.) and gently wipe the surface of the cabinet.
 - Using a chemical cloth (wet/dry sheet type cloth, etc.) may deform the components of the main unit cabinet or cause cracking.
 - Wiping with a hard cloth or using strong force may scratch the surface of the cabinet.
 - If the cabinet is very dirty, wipe with a soft cloth (cotton, flannel, etc.) soaked in neutral detergent diluted with water and thoroughly wrung out, and then wipe with a soft dry cloth.
 - Avoid using benzene, thinner, and other solvents, as these may deform the cabinet and cause the paint to peel off.
 - Do not apply insecticides or other volatile liquids.
- Also, do not allow the cabinet to remain in contact with rubber or vinyl products for a long period of time. Plasticizers inside the plastic may cause the cabinet to deform and cause the paint to peel off.

Caring for the front panel

- Turn off the main power and unplug the AC cord from the wall outlet before handling.
- Gently wipe the surface of the front panel with a soft cloth (cotton, flannel, etc.). To protect the front panel, do not use a dirty cloth, liquid cleaners, or a chemical cloth (wet/dry sheet type cloth, etc.). This may damage the surface of the front panel.
- Wiping with a hard cloth or using strong force may scratch the surface of the front panel.
- Use a soft damp cloth to gently wipe the front panel when it is really dirty. (It may scratch the surface of the front panel when wiped strongly.)
- If the front panel is dusty, use an anti-static brush, which is commercially available, to clean it.
- To avoid scratching the frame or screen, please use a soft, lint free cloth for cleaning. Approved cleaning cloths are available directly from Sharp in single (00Z-LCD-CLOTH) or triple (00Z-LCD-CLOTH-3) packs. Call 1-877-PRO-ADV1 (1-877-776-2381) for ordering, or VISIT <http://www.sharpusa.com>.



CHILD SAFETY:

PROPER TELEVISION PLACEMENT MATTERS



THE CONSUMER ELECTRONICS INDUSTRY CARES

- Manufacturers, retailers and the rest of the consumer electronics industry are committed to making home entertainment safe and enjoyable.
- As you enjoy your television, please note that all televisions – new and old – must be supported on proper stands or installed according to the manufacturer's recommendations. Televisions that are inappropriately situated on dressers, bookcases, shelves, desks, speakers, chests, carts, etc., may fall over, resulting in injury.

TUNE IN TO SAFETY

- **ALWAYS** follow the manufacturer's recommendations for the safe installation of your television.
- **ALWAYS** read and follow all instructions for proper use of your television.
- **NEVER** allow children to climb on or play on the television or the furniture on which the television is placed.
- **NEVER** place the television on furniture that can easily be used as steps, such as a chest of drawers.
- **ALWAYS** install the television where it cannot be pushed, pulled over or knocked down.
- **ALWAYS** route cords and cables connected to the television so that they cannot be tripped over, pulled or grabbed.

WALL OR CEILING MOUNT YOUR TELEVISION

- **ALWAYS** contact your retailer about professional installation if you have any doubts about your ability to safely mount your television.
- **ALWAYS** use a mount that has been recommended by the television manufacturer and has a safety certification by an independent laboratory (such as UL, CSA, ETL).
- **ALWAYS** follow all instructions supplied by the television and mount manufacturers.
- **ALWAYS** make sure that the wall or ceiling where you are mounting the television is appropriate. Some mounts are not designed to be mounted to walls and ceilings with steel studs or cinder block construction. If you are unsure, contact a professional installer.
- Televisions can be heavy. A minimum of two people is required for a wall or ceiling mount installation.

MOVING AN OLDER TELEVISION TO A NEW PLACE IN YOUR HOME

- Many new television buyers move their older CRT televisions into a secondary room after the purchase of a flat-panel television. Special care should be made in the placement of older CRT televisions.
- **ALWAYS** place your older CRT television on furniture that is sturdy and appropriate for its size and weight.
- **NEVER** place your older CRT television on a dresser where children may be tempted to use the drawers to climb.
- **ALWAYS** make sure your older CRT television does not hang over the edge of your furniture.

CE.org/safety



IMPORTANT SAFETY INSTRUCTIONS

Wireless LAN

This TV has received the following certifications.

- Wi-Fi CERTIFIED™ (certification program from the Wi-Fi Alliance®)
- Wi-Fi Protected Setup™ (certification program from the Wi-Fi Alliance®)

FCC

This device complies with part 15 of the FCC Rules. Operation is subject to the following two conditions:

(1) This device may not cause harmful interference, and (2) this device must accept any interference received, including interference that may cause undesired operation. Changes or modifications not expressly approved by the party responsible for compliance could void the user's authority to operate the equipment. To comply with the FCC RF exposure compliance requirements, this device and its antenna must not be co-located or operated in conjunction with any other antenna or transmitter.

IFETEL

This equipment operates on a secondary basis and, consequently, must accept harmful interference, including from stations of the same kind, and may not cause harmful interference to systems operating on a primary basis.

CONTAINS TRANSMITTER MODULE IFETEL ID: RCPSHWN14-1198

Brand: SHARP

Model: WN4616L

Part Names

TV

(Front)

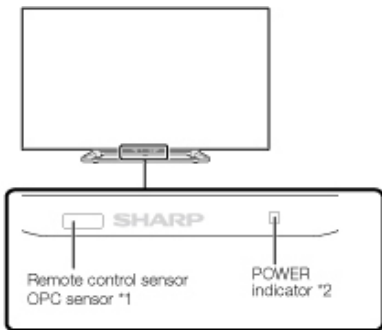

*1 See page 4-18.

*2 See page 4-26.

(Side)

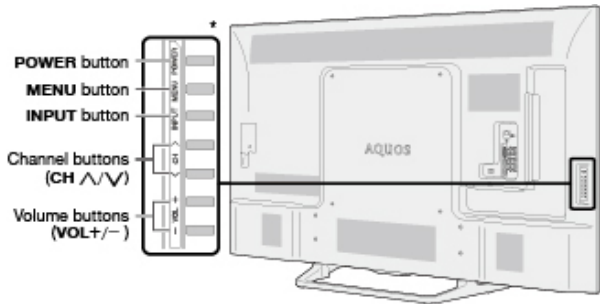

* See pages 2-1 and 4-4 for button operations.

(Rear)

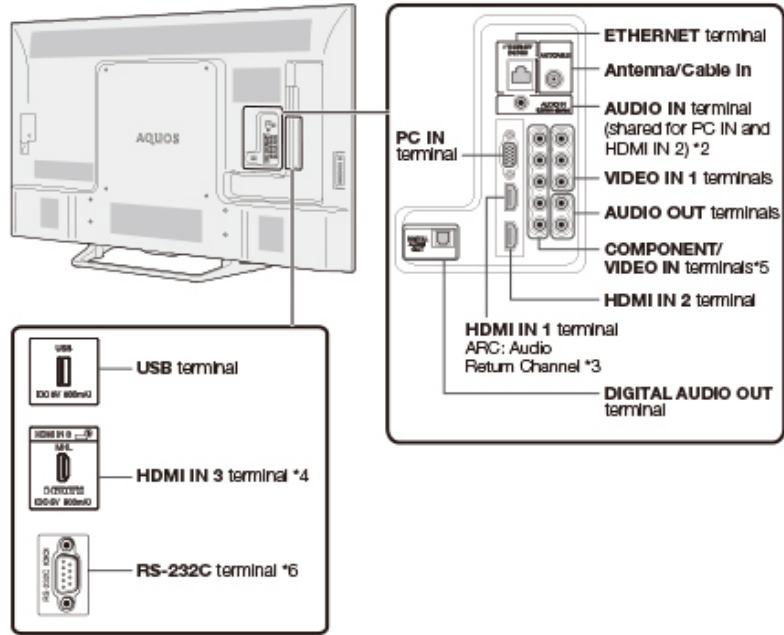

*1 See the Setup Guide.

And see page 6-1 for external equipment connection.

*2 See page 7-2 for details on the Audio Select function.

*3 See page 6-2, for details on the Audio Return Channel.

*4 See page 6-5, for details on the MHL function.

*5 See page 4-12 for details on the Input Select function.

*6 For LE661U and EQ30U models only.

- The illustrations and on-screen displays in this operation manual are for explanation purposes and may vary slightly from the actual operations.
- The examples used throughout this manual are based on the LC-60LE661U model.

Part Names

Remote Control Unit



NOTE

- When using the remote control unit, point it at the TV.
- The appearance of the remote control unit varies by the time when you purchased the product.

1 POWER: Switch the TV power on or enter standby.

2 TV, STB, DVD-VCR, AUDIO: Switches the remote control for TV, STB, BD, DVD, VCR and AUDIO operation.

[\(See pages 5-9 to 5-12 for details.\)](#)

* To enter the code registration mode, you need to press an appropriate button (**STB, DVD-VCR** or **AUDIO**) and **MANUAL** at the same time.

3 External equipment operational buttons: Operate the external equipment.

4 DISPLAY: Display the channel information.

5 OPTION: Display the Link Operation Menu screen. This button will function only when LINK Operation is used.

[\(See pages 6-1 to 6-4 for details.\)](#)

6 SLEEP: Set the sleep timer.

[\(See page 3-9.\)](#)

7 0-9: Set the channel.

[\(See pages 3-1 and 5-12.\)](#)

8 • (DOT): Set the channel.

[\(See pages 3-1 and 5-12.\)](#)

9 CC: Display captions from a closed-caption source.

[\(See page 3-12 to 3-13\)](#)

10 AV MODE: Select an audio or video setting.

[\(See page 3-10.\)](#)

11 MUTE: Mute the sound.

[\(See page 3-3.\)](#)

12 VOL +/-: Set the volume.

[\(See page 3-2.\)](#)

13 MENU: Display the menu screen.

[\(See page 4-1.\)](#)

14 2D/3D: This button is not available.

15 ▲▼/◀▶, ●(ENTER): Select a desired item on the screen.

16 EXIT: Turn off the menu screen.

17 FAV CH: Set the favorite channels.

[\(See page 4-7.\)](#)

18 A, B, C, D: Select 4 preset favorite channels in 4 different categories.

[\(See page 4-7.\)](#)

While watching, you can toggle the selected channels by pressing **A, B, C** and **D**.

19 MANUAL: Display the operation manual.

20 POWER (SOURCE): Turns the power of the external equipment on and off.

Part Names

Remote Control Unit (Continue)



21 FREEZE: Set the still image. Press again to return to normal screen.

[\(See page 3-4.\)](#)

22 AUDIO: Selects the MTS/SAP or the audio mode during multichannel audio broadcasts.

[\(See page 3-8.\)](#)

23 ENT: Jumps to a channel after selecting with the **0–9** buttons.

24 FLASHBACK: Return to the previous channel or external input mode.

[\(See page 3-5.\)](#)

25 VIEW MODE: Select the screen size.

[\(See pages 3-14 to 3-16.\)](#)

26 INPUT: Select a TV input source.

[\(See page 2-1.\)](#)

27 CH/V: Select the channel.

[\(See page 3-1.\)](#)

28 SmartCentral: Display the application window.

[\(See page 3-6.\)](#)

29 RETURN: Return to the previous menu screen.

30 NETFLIX: Display the Netflix screen.

If you press the NETFLIX button when the TV is turned off, the TV turns on and the NETFLIX screen is displayed.

[\(See page 3-7.\)](#)

31 FAV APP 1, 2, 3: You can assign your favorite applications to these buttons.

[\(See page 8-12.\)](#)

NOTE

- When using the remote control unit, point it at the TV.
- The appearance of the remote control unit varies by the time when you purchased the product.

Watching TV

Displaying an External Equipment Image

To view external source images, select the input source by pressing **INPUT** on the remote control unit or on the TV.



Example



- 1 Press **INPUT**.
 - The INPUT list screen displays.
- 2 Press **▲▼** to select the input source.
 - An image from the selected source automatically displays.

- You can also select the input source by pressing **INPUT**.
 - Each time **INPUT** is pressed, the input source toggles.
- TV → HDMI1 → USB → Home Network → Miracast



Initial Installation

Perform the following steps before you press **POWER** on the remote control unit.

1. Insert the batteries into the remote control unit.
2. Connect the antenna cable to the TV.
3. Plug in the AC cord to the AC outlet.

Language (Language setting)

Select from among 3 languages: English, French and Spanish.

- 1 Press **▲▼** to select the desired language listed on the screen, and then press **ENTER**.

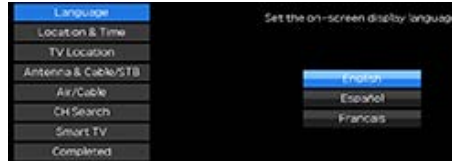

Location & Time

Make settings for the country, area and time zone where you use the TV.

- 2 Press **▲▼** to select "United States", "Canada" or "Mexico", and then press **ENTER**.



- 3 Press **▲▼** to select the time zone where you are using the TV, and then press **ENTER**.

Example

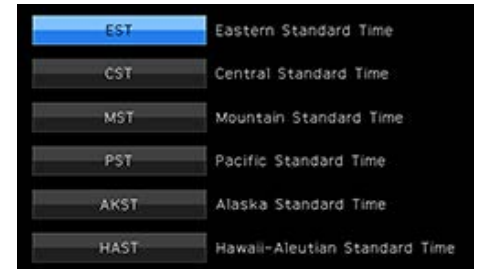

- The time zone differs depending on the selected country.
- The factory preset value is the time zone for the capital of the selected country.



Initial Installation (Continue)

4 Press **▲▼** to select the Daylight Savings Time, and then press **ENTER**.

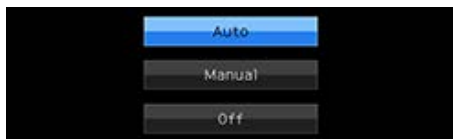

- "Auto" is the default selection.

TV Location

Select "Home" or "Store" for the location where you plan to install the TV. This product qualifies for ENERGY STAR in Home mode default setting.

5 Press **◀▶** to select "Home" or "Store". Press **ENTER** to enter the setting.

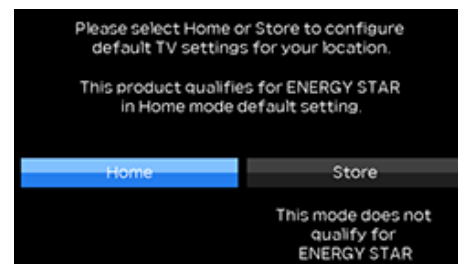

Home: AV MODE is set to "STANDARD (ENERGY STAR)".

Store: AV MODE is set to "DYNAMIC (Fixed)". Picture Reset and Feature Demo can be set.

Picture Reset: AV MODE will be set to "DYNAMIC (Fixed)" regardless of whether Picture Reset is "On" or "Off".

- If you select "On" and there is no operation for 30 minutes:
 - AV MODE will be reset to "DYNAMIC (Fixed)".
- When "Off" is selected:
 - Even after 30 minutes elapses, AV MODE is not reset to "DYNAMIC (Fixed)".

Feature Demo: When "On" is selected, after all the settings are completed, the Feature Demo screen is displayed if there is no operation for several minutes.

NOTE

- ENERGY STAR qualification is based on AV MODE "STANDARD (ENERGY STAR)".



Initial Installation (Continue)

Antenna & Cable/STB

Select the type of connection you will use to watch TV.

6 Press to select "Antenna & Cable" or "Set-top box", and then press **ENTER**.



To watch TV via an antenna or cable connection (without using a set-top box):
Select "Antenna & Cable", and then go to step 7.

To watch TV via a set-top box:

① Select "Set-top box", and then press **ENTER**.

② Check that the set-top box connected to the TV is on.

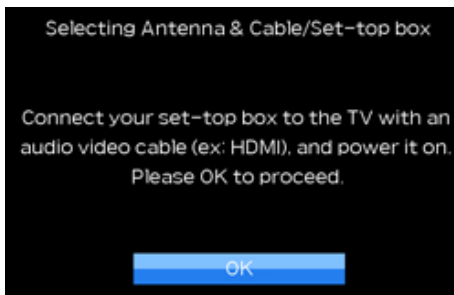

③ To watch TV, select the input source corresponding to the terminal connected to the set-top box.



- See page 4-12 for details on the Input Skip function.
- ④ Press **INPUT** to select the input source corresponding to the terminal connected to the set-top box. Make the necessary settings on the connected external equipment.
- See the operation manual of the connected equipment for setting up the equipment.

Air/Cable (Antenna setting)

Make sure what kind of connection is made with your TV when selecting "Air" or "Cable".

7 Press to select "Air" or "Cable".
Press **ENTER** to enter the setting.





Initial Installation (Continue)

CH Search (Channel search)

Channel auto search makes the TV look for all channels viewable in the set area.

8 When "Air" is selected in Antenna setting:

Press **◀▶** to select "Start", and then press **ENTER**.



When "Cable" is selected in Antenna setting:

Press **▲▼** to select "Analog & Digital Search Start" to search both analog and digital broadcasts, or to select "Analog Search Start" to search only analog broadcasts, and then press **ENTER**.

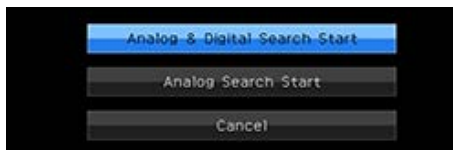

- The Channel search will start automatically.
- To exit the Channel search screen, select "Cancel", and then press **ENTER**.

Smart TV

When you connect to the Internet on the TV, select the desired connection method and follow the instructions shown on the display.

- Wireless LAN connection is possible only when the WPS (push button) method is used. If any other method is used, make settings by Smart TV > Internet Setup.

[\(See pages 8-2 to 8-4.\)](#)

9 Press **◀▶** to select "Yes", and then press **ENTER**.



10 Press **▲▼** to select "Wired" or "Wireless", and then press **ENTER**.





Initial Installation (Continue)

Connection using an ETHERNET cable:

- 1 Select "Wired" and press **ENTER**.
- 2 Confirm that the TV is properly connected with the router, and then press "Next". Follow the instructions on the display to perform the connection test.

Wireless LAN connection by the WPS method:

- 1 Select "Wireless" and press **ENTER**.
- 2 Follow the instructions on the display, and finalize the connection after testing its viability.

NOTE

- After you finish configuring the network settings, configure the "TV Name Setting".
(See pages 4-24, 7-3.)
- When you change the network settings, refer to Smart TV > Internet Setup.
(See pages 8-2 to 8-4.)

Completed

- 11 The settings confirmation screen is displayed. Confirm the information displayed on the screen, and then press **ENTER**.

Examples of the settings confirmation screen

When "Antenna & Cable" was selected in step 6.

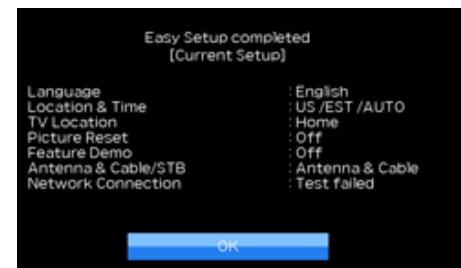



Initial Installation (Continue)

NOTE

- If no channel is found, confirm the type of connection made with your TV and try "Easy Setup" again. (See page 4-5.)

When "Set-top box" was selected in step 6.

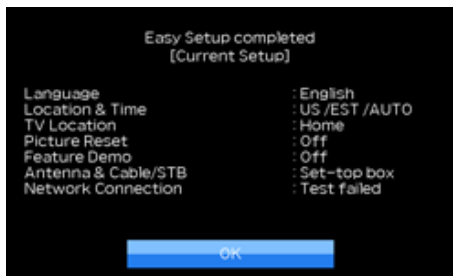

- Click "OK" to display the confirmation screen for input source switching.

Show the input list: You can check the current connection status of external equipment. Confirm which input terminal is connected to the set-top box.

OK: Clicking "OK" will complete the Easy Setup procedure.

NOTE

- For changing the settings of the Initial Installation, perform "Easy Setup" on the Initial Setup menu on [page 4-5](#).



Changing Channels

You can change channels in several ways.

Method 1

Using **CH** on the remote control unit or on the TV.

Method 2

Using remote control buttons **0-9**, **• (DOT)**.

Examples:

To select a 1 or 2-digit channel number (e. g., Channel 5):

Press **5** → **ENTER**

To select a 3-digit channel number (e. g., Channel 115):

Press **1** → **1** → **5** → **ENTER**

To select a 4-digit channel number (e. g., Channel 22.1):

Press **2** → **2** → **• (DOT)** → **1** → **ENTER**

NOTE

- When selecting a 1-digit channel number, it is not necessary to press **0** before the number.
- When you enter **0-9** only, channel selection will be made if there is no operation within a few seconds.
- If you push "0" by itself, nothing will happen.
- Complete the above steps within a few seconds.
- When you enter **0-9** and **• (DOT)**, channel selection will be made if there is no operation within a few seconds.



Changing Volume

You can change the volume by pressing **VOL+/-** on the TV or on the remote control unit.

- To increase the volume, press **VOL +**.
- To decrease the volume, press **VOL -**.



Audio status

Output device	Output Select	
	Fixed	Variable
Speaker	Variable sound	Mute

- When "Output Select" is set to "Variable", the indicator on the screen changes as shown below.



NOTE

- [See page 4-12](#) for details on the Output Select function.



MUTE

Mutes the current sound output.

Press **MUTE**.

- "⊗" will be displayed on the screen for 30 minutes, and the sound is silenced.

NOTE

- Within 30 minutes of pressing **MUTE**, mute can be canceled by pressing **VOL+/-** or **MUTE**.
- Mute will be canceled after 30 minutes have passed. However, the TV will not suddenly output a loud sound as the volume level is set to 0 automatically.



FREEZE

Allows you to capture and freeze a moving image that you are watching.

Press **FREEZE**.

- A moving image is captured.
- Press **FREEZE** again to cancel the function.

NOTE

- When this function is not available, "No displaying still image available." will display.
- If you are using the freeze function and a broadcast activates the V-CHIP BLOCK, the freeze function will be canceled and a V-CHIP BLOCK message will appear.



FLASHBACK

Press **FLASHBACK** to switch to the previously tuned channel or previous input mode.

- Press **FLASHBACK** again to switch back to the currently tuned channel.

NOTE

- **FLASHBACK** will not work if no channel has been changed after the TV is turned on.







SmartCentral

Allows you to directly activate various types of applications.

1 Press **SmartCentral** to display the application window.

- Press **SmartCentral** again to switch back to the currently tuned channel.

2 Press  to select the desired application, and then press **ENTER**.

- If  is displayed, check the USB connection.
- If  or  is displayed, check your TV's network settings and connection.

NOTE

- [See page 5-2, 8-7 to 8-12](#) for details of viewable applications.
- When this function is not available, "Can not operate this function now" will display.



NETFLIX

Displays the Netflix screen.

Press **NETFLIX**.

NOTE

If you press the NETFLIX button when the TV is turned off, the TV turns on and the NETFLIX screen is displayed.

- To enjoy Netflix, you need to make:

- a broadband Internet connection

- [\(See page 8-1.\)](#)

- settings of Internet Setup

- [\(See pages 8-2 to 8-4.\)](#)

- adjustments for Netflix

- [\(See page 8-13.\)](#)



AUDIO

MTS/SAP stereo mode

The TV has a feature that allows reception of sound other than the main audio for the program. This feature is called Multi-channel Television Sound (MTS). The TV with MTS can receive mono sound, stereo sound and Secondary Audio Programs (SAP). The SAP feature allows a TV station to broadcast other information, which could be audio in another language or something completely different like weather information.

You can enjoy Hi-Fi stereo sound or SAP broadcasts where available.

- **Stereo broadcasts:** View programs like live sporting events, shows and concerts in dynamic stereo sound.
- **SAP broadcasts:** Receive TV broadcasts in either MAIN or SAP sound.
 MAIN sound: The normal program soundtrack (either in mono or stereo).
 SAP sound: Listen to a second language, supplementary commentary or other information. (SAP is mono sound.)

If stereo sound is difficult to hear.

- Obtain a clearer sound by manually switching to fixed mono-sound mode.

You can change MTS as shown below to match the television broadcast signal.

Press **AUDIO** to toggle between audio modes.

Examples: when receiving MTS and SAP

STEREO mode: ST(SAP) → SAP(ST) → MONO

STEREO + SAP mode: STEREO ↔ MONO

MAIN + SAP mode: MAIN ↔ SAP

MONO mode: MONO

Digital broadcasting audio mode

The types of audio transmitted in a digital broadcast include SURROUND as well as MONO and STEREO. In addition, it is possible for multiple audio tracks to accompany a single video track.

Press **AUDIO** to toggle between audio modes.

Example: when receiving Digital broadcasting

STEREO (Audio1) → STEREO (Audio2)
 SURROUND (Audio3) ←

NOTE

- MTS only operates while in TV mode.
- You can have the same settings by choosing "Change Audio" on the menu items.
[\(See page 4-25.\)](#)



Sleep Timer

Allows you to set a time when the TV automatically switches to standby.

Press **SLEEP**.

- The remaining time displays when the sleep timer has been set.
- Each time you press **SLEEP**, the remaining time switches as shown below.

Off → 0hr30min → 1hr00min
↑ ↓
2hr30min ← 2hr00min ← 1hr30min

- When set, the time automatically starts counting down.
- If you want to adjust the sleep timer, you can press **SLEEP** twice then change the time setting.
- When it is 5 minutes before the time expires, the remaining time will start to keep appearing every minute.

NOTE

- Select "Off" by pressing SLEEP to cancel the sleep timer.
- The TV will enter standby when the remaining time reaches 0.



AV MODE

AV MODE gives you several viewing options to choose from to best match the surrounding environment of the TV, which can vary due to factors like room brightness, type of program watched or the type of device connected.

You can use USER Mode to create customized settings for each TV input. These settings will be automatically saved on each input for convenience.

Press **AV MODE**. Current AV MODE displays.

- Press **AV MODE** again before the mode displayed on the screen disappears.
- The mode changes as shown below:





AV MODE (Continue)

STANDARD (ENERGY STAR): For a highly defined image in a normal lighting.

MOVIE: For a movie.

PC: For PC.

USER: Allows the user to customize settings as desired. You can set the mode for each input source.

DYNAMIC: For a clear-cut image emphasizing high contrast, useful for sports viewing.

DYNAMIC (Fixed): Changes the image and sound settings to the factory preset values. No adjustments are allowed.

NOTE

- You can select a different AV MODE item for each input mode. (For example, select STANDARD (ENERGY STAR) for TV input and DYNAMIC for COMPONENT.)
- You can have the same settings by choosing "AV MODE" on the menu items.
[\(See page 4-17.\)](#)



Closed Captions and Digital Closed Captions

Your TV is equipped with an internal Closed Caption decoder. It allows you to view conversations, narration and sound effects as subtitles on your TV. Closed Captions are available on some TV programs and on some VHS home video tapes at the discretion of the program provider.

Digital Closed Caption service is a new caption service available only on digital TV programs (also at the discretion of the service provider). It is a more flexible system than the original Closed Caption system, because it allows for a variety of caption sizes and font styles. When the Digital Closed Caption service is in use, it will be indicated by the appearance of a 3-letter abbreviation that also indicates the language of the Digital Closed Captions: ENG (English), SPA (Spanish), FRA (French) or other language codes. Not all programs and VHS videotapes offer closed captions. Please look for the "CC" symbol to ensure that captions will be shown.

In the Closed Caption system, there can be more than one caption service provided. Each is identified by its own number. The "CC1" and "CC2" services display subtitles of TV programs superimposed over the program's picture. In the Closed Caption system, the "Text1" or "Text2" services display text that is unrelated to the program being viewed (e.g., weather or news). These services are also superimposed over the program currently being viewed.

- 1 Press **CC**.
 - This will present the Closed Caption information display.
- 2 Press **CC** while the Closed Caption information is still on the screen.
 - Press repeatedly until you select the desired closed caption service.

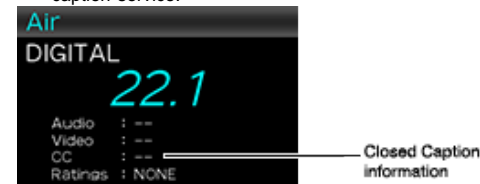

- Depending on the number of caption services in the signal being received, you will see information such as 1/2 or 1/4 displayed. 1/2 means "the first of two services".

Example:

If a program has three services (Digital CC(ENG), CC1 and Text1), the closed caption display will toggle in this sequence:



- The **CC** button keeps a record of the last service selected in its memory. If the last closed caption mode (e.g. 1/3 ENG) you selected is not available for the next program, or on another channel, the closed caption service that is available is automatically selected, and this service appears in parentheses, e.g. "1/3(CC1)". Closed Caption services that appear in parentheses will not be stored in the **CC** button's memory as your last selected service. Only services that you have selected with the **CC** button are stored.



Closed Captions and Digital Closed Captions (Continue)

Examples:

In a case where there are two closed caption services provided (for instance, Digital CC(ENG) and CC1), and Digital CC(ENG) is displayed as your current selection, if Digital CC(ENG) is not broadcast for the next program, the other closed caption service, CC1, will be displayed in parentheses.

A closed caption service appears in parentheses because the service you selected is not available and a different service is displayed on your screen. "1/1(CC1)" is displayed instead of "1/2/ENG".

NOTE

- See [page 4-26](#) for detailed closed caption settings.
- When the program contains no closed caption, "--" displays in the closed caption information.
- If the language code, e.g. "ENG", is not found on Digital TV programs, "--" will be shown.
- Four kinds of closed caption service (CC1, CC2, Text1, Text2) are potentially available, but a broadcast may contain none or only some of these services at the discretion of the program provider.
- When a web page is displayed, Closed Captions are not available.
- You can have the same settings by choosing "Change CC" on the menu items. [\(See page 4-25.\)](#)



VIEW MODE

You can select the screen size.

1 Press **VIEW MODE**.

- The View Mode menu displays.
- The menu lists the View Mode options selectable for the type of video signal currently being received.

2 Press **VIEW MODE** or **▲/▼** while the View Mode menu is displayed to select a desired item on the menu.

- You can sequentially select a View Mode that has its own aspect ratio.

NOTE

- You can have the same settings by choosing "View Mode" on the menu items.
(See page 4-25.)

For HD programs

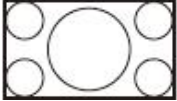
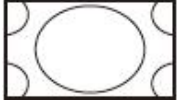
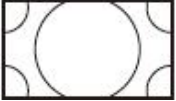
Stretch	Dot by Dot (Full Screen)	S.Stretch (Smart stretch)	Zoom
 <p>Suitable for viewing wide-screen 1.78:1 aspect ratio program, stretch mode will still show very thin black bands at the top and bottom of the screen.</p>	 <p>"Dot by Dot" when the number of pixels on the screen and the resolution of the signal are the same. "Full Screen" when the number of pixels on the screen and the resolution of the signal are different. In either case, the image fully fills the screen.</p>	 <p>Suitable for stretching 4:3 programs to fill the screen.</p>	 <p>Suitable for viewing wide-screen 2.35:1 aspect-ratio programs in full screen.</p>

NOTE



- When using Dot by Dot or Full Screen, it is possible to see noise or bars around different outer portions of the screen. Please change view mode to correct this.

Direct Button Operation



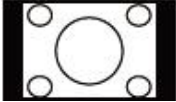

VIEW MODE (Continue)

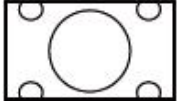
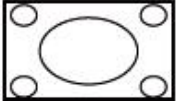
For 4:3 programs
Example: Screen size images

Side Bar	S.Stretch (Smart stretch)	Zoom	Stretch
			
Suitable for viewing conventional 4:3 programs in their normal format.	Suitable for stretching 4:3 programs to fill the screen.	Suitable for viewing wide-screen 2.35:1 anamorphic DVDs in full screen.	This mode is useful for 1.78:1 DVDs. When viewing 1.85:1 DVDs, stretch mode will still show very thin black bands at the top and bottom of the screen.

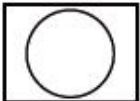
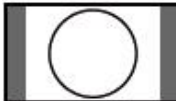
For USB-Video, Home Network Video or Internet applications
Example: Screen size images

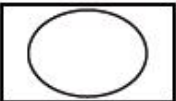
Input signal	Auto	Original	Stretch
			
	Keeps the original aspect ratio in a full screen display.	Displays an image by an original size.	An image fully fills the screen.



VIEW MODE (Continue)

For PC
Example: Screen size images

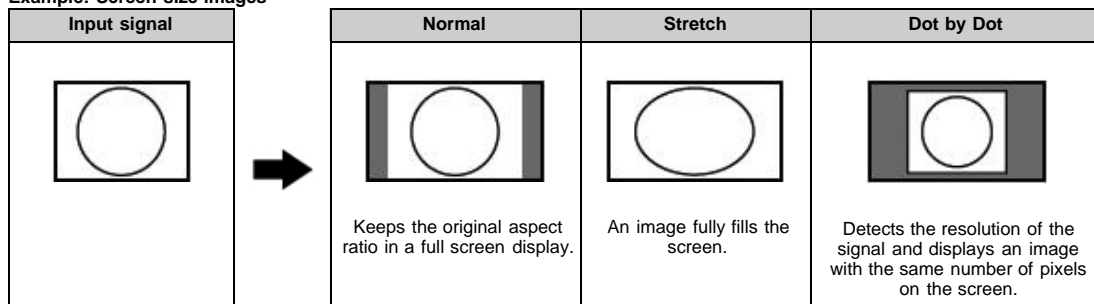

NOTE

- Connect the PC before making adjustments. See the Setup Guide.
- Selectable screen size may vary with input signal type.



Introduction



① Guide display

- This indicates the buttons that can be operated on the displayed screen. The guide display varies depending on the menu setting screen.
- The operations for some selected items may be displayed in the operational guide bar at the bottom of the screen.

② Item displayed in blue

- This indicates the item currently selected.
- Press **ENTER** to go to the adjustment screen for this item.

③ Item in brackets

- This indicates the current setting for the item.

④ Item displayed in white

- This indicates that the item can be selected.

⑤ Item displayed in gray

- This indicates that the item cannot be selected. There are various reasons why the items cannot be selected, but the main reasons are as follows:

- Nothing is connected to the selected input terminal.
- The function is not compatible with the current input signal.
- When this conflicts with other functions, you must change the settings for the other functions.



Introduction (Continue)

About Menu Items

- Some menu items may not be displayed depending on the selected input source.

NOTE

- The screens in the operation manual are for explanation purposes (some are enlarged, others cropped) and may vary slightly from the actual screens.
- The order of explanations for each menu item in the following pages is not necessarily in accordance with the alignment of the items on the screen.



LCFONT:

- This product is embedded with LC Font technology, which was developed by SHARP Corporation for clearly displaying easy-to-read characters on LCD screens.



On-Screen Display Menu Operation

Example

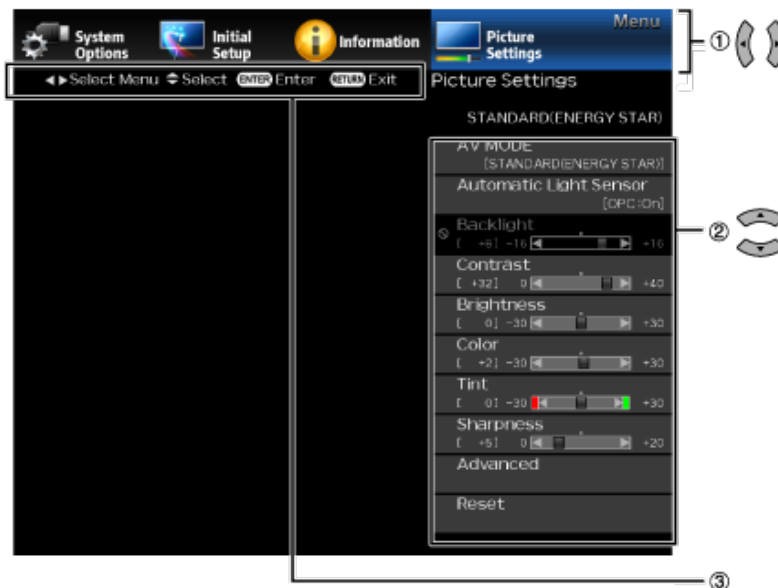

1 Press **MENU** to display the MENU screen.

2 ① Press **◀▶** to select the desired menu.

② Press **▲▼** to select a specific adjustment item, and then press **ENTER**.

- Additional related adjustment items may be displayed. Press **▲▼** to select the desired item.

③ Adjust the item while referring to the guide display.
• Operations vary depending on the function or item. Refer to the guide display corresponding to the menu setting screen for button operations.

3 Press **MENU** to exit.

NOTE

- Menu options differ in the selected input modes, but the operating procedures are the same.



Menu Operation Buttons

Using the remote control

Use the following buttons on the remote control to operate the menu.

MENU: Press to open or close the menu screen.

▲/▼/◀/▶: Press to select a desired item on the screen or adjust a selected item.

ENTER: Press to go to the next step or complete the setting.

RETURN: Press to return to the previous step.

Using the control panel of the TV

You can also operate the menu with the control panel of the TV.

Button operations on the control panel correspond to the ones on the remote control as shown below.

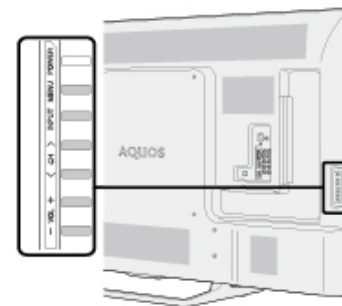

MENU: MENU on the remote control.

INPUT: ENTER on the remote control.

CH/▲/▼: Cursor ▲/▼ on the remote control.

VOL+/-: Cursor ◀/▶ on the remote control.

Example



Initial Setup

NOTE

- For operating the on-screen display menu, [see page 4-3](#).

Easy Setup

You can run Easy Setup again, even after setting up the preset channels.

Language: Select from among 3 languages (English, French and Spanish).

Location & Time: Make settings for the country, area and time zone where you use the TV.

Select your country: Select either "United States", "Canada" or "Mexico".

Select your time zone: Select your time zone. The available settings differ depending on the selected country.

Select DST (Daylight Savings Time): Select "Auto", "Manual" or "Off".

TV Location: Select "Home" or "Store" for the location where you plan to install the TV. This product qualifies for ENERGY STAR in Home mode default setting.

Home: AV MODE is set to "STANDARD (ENERGY STAR)".

Store: AV MODE is set to "DYNAMIC (Fixed)". Picture Reset and Feature Demo can be set.

Picture Reset: AV MODE will be set to "DYNAMIC (Fixed)" regardless of whether Picture Reset is "On" or "Off". If you select "On", AV MODE will be reset to "DYNAMIC (Fixed)" if there is no operation for 30 minutes. When "Off" is selected, even after 30 minutes elapses, AV MODE is not reset to "DYNAMIC (Fixed)".

Feature Demo: When "On" is selected, after all the settings are completed, the Feature Demo screen is displayed if there is no operation for several minutes.

- ENERGY STAR qualification is based on AV MODE "STANDARD (ENERGY STAR)".

Antenna & Cable/STB: Select the type of connection you will use to watch TV.

Air/Cable: Make sure what kind of connection is made with your TV when selecting "Air" or "Cable".

CH Search: Channel auto search makes the TV look for all channels viewable in the set area.

Smart TV: When you connect to the Internet on the TV, confirm the connection method and make adjustments.

- Wireless LAN connection is possible only when the WPS (push button) method is used. If any other method is used, make settings by Smart TV > Internet Setup.

[\(See pages 8-2 to 8-4.\)](#)

Completed: The settings confirmation screen is displayed. Confirm the information displayed on the screen.

NOTE

- See Initial Installation on [pages 2-2 to 2-7](#) for setting each item.
- If no channel is found, confirm the type of connection made with your TV and try "Easy Setup" again.
- If you select "Analog Search Start" and initiate the channel search, the CH Memory for Cable Digital will be deleted.

Example



Initial Setup (Continue)

Language

You can also select a language from the Initial Setup menu. Select from among 3 languages: English, French and Spanish.

NOTE

- To change the language of the manual, select "MENU" > "Initial Setup" > "Language" to change the language. Then, press **MANUAL** again.

TV Channel Setup

Channel Setup

If Initial Installation does not memorize all the channels in your region, follow the instructions below to manually memorize the channels.

Air/Cable: Make sure what kind of connection is made with your TV when selecting "Air" or "Cable".

CH Search: Channel auto search makes the TV look for all channels viewable in the set area.

CH Memory: You can select the channels to skip in each ANALOG (Air), ANALOG (Cable), DIGITAL (Air) and DIGITAL (Cable).

On: Skips channels. (Channel selection disabled using **CH** )

Off: Does not skip channels. (Channel selection enabled using **CH** )

NOTE

- See Initial Installation on [pages 2-2 to 2-7](#) for setting each item.
- If no channel is found, confirm the type of connection made with your TV and try channel search again.
- If you select "Analog Search Start" and initiate the channel search, the CH Memory for Cable Digital will be deleted.

Example



Initial Setup (Continue)

TV Channel Setup

Favorite CH (Favorite Channel Setting)

This function allows you to program 4 favorite channels, in 4 different categories. By setting the favorite channels in advance, you can select your favorite channels easily.

To register your favorite channel:

Select "Register" and then press **ENTER**. Press ▲/▼/◀/▶ to select the position in the category, and then press **ENTER** to register.

To delete your favorite channel:

Select "1 Data Clear" and then press **ENTER**. Press ▲/▼/◀/▶ to select the channel you want to delete, and then press **ENTER**. Select "Yes" and then press **ENTER**.

To delete all the favorite channels, select "All Data Clear".

NOTE

- Before setting the channel, select the channel you want to register as a favorite channel.
- You can display the "Favorite CH" screen by pressing **FAV CH** on the remote control.

Antenna Setup-DIGITAL

In order to receive digital air broadcasts, you need a digital broadcast antenna. You can confirm the antenna configuration through the "Antenna Setup-DIGITAL" screen. If necessary, adjust the direction of the antenna to obtain the maximum signal strength.

Signal Strength: The signal strength of DIGITAL channel is displayed. The signal information is based on the current channel.

Channel Strength: Input the 2-digit channel number to check the signal strength of the selected channel. Make sure the signal is strong enough for each channel.

- This function is available for DIGITAL (Air) only.

Example



Initial Setup (Continue)

Individual Setup

Secret No.

Allows you to use a secret number to protect certain settings from being accidentally changed.

IMPORTANT:

Three conditions must be met to enable the V-Chip

1. Secret No. is registered.
2. V-Chip/V-Chip (DTV Only) settings have been made.
 - The "V-Chip (DTV Only)" will only be selectable when a new rating system can be downloaded via digital broadcasting in the U.S.
3. "Status" is set to "Enable".

Setting Secret No.

You can set and change the secret number by using **0-9**.

New Secret No.: Changes or sets the Secret No.

Confirm Secret No: Enter Secret No. to confirm.

NOTE

- As a precautionary measure, make a note of your secret number and keep it in a familiar place.

Parental Control (Parental Control Setting)

V-Chip

V-CHIP is an electronic filtering device built into your TV. This tool gives parents a great degree of control over broadcasts accessed by their children. It allows parents to select programs judged suitable for child viewing while blocking ones judged not suitable. It does so automatically once you activate the V-CHIP feature in your TV. "V-Chip" and "Status" will not be selectable from the menu if you do not first configure your secret number.

- The U.S. has two rating systems for viewing content: TV Parental Guidelines and movie ratings.
- The TV Parental Guidelines work in conjunction with the V-CHIP to help parents screen out inappropriate television shows from their children.
- Movie ratings are used for original movies rated by the Motion Picture Association of America (MPAA) as watched on cable TV and not edited for television. The V-CHIP can also be set to block MPAA-rated movies.

NOTE

- The setting automatically enters "Block" for any ratings below your selection.
- If Status is not set to "Enable", the configuration settings will not work.

MPAA (Voluntary movie rating system) Example



Press **▲/▼** to adjust the item to your desired position.

"**■**" indicates the item is blocked. Press **MENU** to exit.

G: General audiences. All ages admitted.

PG: Parental guidance suggested. Some material may not be suitable for children.

PG-13: Parents strongly cautioned. Some material may be inappropriate for children under 13.

R: Restricted. Under 17 requires accompanying parent or adult guardian (age varies in some jurisdictions).

NC-17: No one 17 and under admitted.

X: X is an older rating that is unified with NC-17 but may be encoded in the data of older movies.

NOTE

- Voluntary movie rating system only uses an age-based rating.

Example



Initial Setup (Continue)

Individual Setup

Parental Control (Parental Control Setting)

TV Parental Guidelines

Example

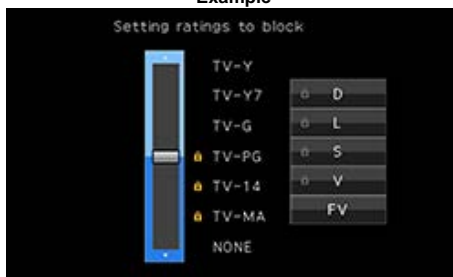

Suggested age

TV-Y: All children.

TV-Y7: Directed to older children.

TV-G: General audience.

TV-PG: Parental Guidance suggested.

TV-14: Parents strongly cautioned.

TV-MA: Mature audience only.

When setting an individual content-based rating item:

- 1 Press **▶** or **ENTER** to access blocked content items from the currently selected age-based rating item.
- 2 Press **▲/▼** to select an individual item, and then press **ENTER** to unblock it ("■" is removed). Repeat the same steps for the other items.
- 3 Press **◀** or **RETURN** to register after all individual content rating items are set.

Content

FV: Fantasy violence.

V: Violence.

S: Sexual situation.

L: Adult language.

D: Sexually suggestive dialog.

Rating	Content					
	FV	V	S	L	D	
Suggested age	TV-Y	☒	☒	☒	☒	☒
	TV-Y7	☒	☒	☒	☒	☒
	TV-G		☒	☒	☒	☒
	TV-PG		☒	☒	☒	☒
	TV-14		☒	☒	☒	☒
TV-MA		☒	☒	☒		

☒ : The content rating can be set, but this rating is not normally broadcast by TV stations.

☒ : Content rating can be set.

Canadian Rating Systems (Canadian English ratings and Canadian French ratings)

- The TV rating systems in Canada are based on the Canadian Radio-Television and Telecommunications Commission (CRTC) policy on violence in television programming.
- While violence is the most important content element to be rated, the structure developed takes into consideration other program content like language, nudity, sexuality and mature themes.
- When setting the V-CHIP on the Canadian system you can choose either the Canadian English ratings or the Canadian French ratings.

Example



Initial Setup (Continue)

Individual Setup

Parental Control (Parental Control Setting)

Canadian English Ratings

- E:** Exempt: Includes news, sports, documentaries and other information programming; talk shows, music videos, and variety programming.
- C:** Children: Intended for younger children under the age of 8 years. Pays careful attention to themes that could threaten their sense of security and well-being.
- C8+:** Children over 8 years old: Contains no portrayal of violence as the preferred, acceptable, or only way to resolve conflict; nor encourage children to imitate dangerous acts which they may see on the screen.
- G:** General: Considered acceptable for all age groups. Appropriate viewing for the entire family, contains very little violence, physical, verbal or emotional.
- PG:** Parental Guidance: Intended for a general audience, but may not be suitable for younger children (under the age of 8) because it could contain controversial themes or issues.
- 14+:** Over 14 years: Could contain themes where violence is one of the dominant elements of the storyline, but it must be integral to the development of plot or character. Language usage could be profane and nudity present within the context of the theme.
- 18+:** Adults: Intended for viewers 18 years and older and might contain depictions of violence, which while related to the development of plot, character or themes, are intended for adult viewing. Could contain graphic language and portrayals of sex and nudity.

Canadian French Ratings

- E:** Exempt programming.
- G:** General: All ages and children, contains minimal direct violence, but may be integrated into the plot in a humorous or unrealistic manner.
- 8ans+:** General but inadvisable for young children: May be viewed by a wide public audience, but could contain scenes disturbing to children under 8 who cannot distinguish between imaginary and real situations.
- Recommended for viewing with parent.
- 13ans+:** Over 13 years: Could contain scenes of frequent violent scenes and therefore recommended for viewing with parent.
- 16ans+:** Over 16 years: Could contain frequent violent scenes and intense violence.
- 18ans+:** Over 18 years: Only for adult viewing. Could contain frequent violent scenes and extreme violence.

How to temporarily release the V-CHIP BLOCK

When the V-CHIP BLOCK is working and censors a broadcast, "V-CHIP HAS BEEN ACTIVATED." displays.

- 1 Press **ENTER** while the V-CHIP is working, and then the secret number setting menu displays.
- 2 Input the 4-digit secret number by using **0-9**. At this time V-CHIP BLOCK temporarily releases.

Example



Initial Setup (Continue)

Individual Setup

Parental Control (Parental Control Setting)

Reactivating the temporarily released V-CHIP BLOCK

You can reactivate the temporarily released V-CHIP BLOCK as shown below.

- Select "Status" setting from the Parental Control menu to reactivate BLOCK.
- Select "V-Chip" setting ("MPAA", "TV Guidelines", "Can. English Ratings" or "Can. French Ratings") from the Parental Control to reactivate BLOCK.
[\(See pages 4-8 to 4-10.\)](#)
- Switch off the TV power. (When "Quick Start Mode" is "OFF".)

NOTE

- Performing any of the three above will activate the V-CHIP BLOCK.

Status

Used to enable or disable the parental control function. This function will not be selectable from the menu if you do not first configure your secret number.

Quick Start Mode

When this function is activated, you can reduce the TV's start-up time or even let the TV in standby mode start displaying images and so on via the connected equipment on the network.

NOTE

- Setting "Quick Start Mode" to "On" consumes more power.

Example



Initial Setup (Continue)

Input Settings

HDMI auto view

When you view images sent from external equipment in an HDMI connection, this function allows the image size on the TV to automatically switch to an appropriate one.

NOTE

- Refer to your external equipment operation manual for the signal type.

Digital Audio Output

You can output digital audio to an AV amplifier or similar device whose DIGITAL AUDIO INPUT terminal is connected to the DIGITAL AUDIO OUT terminal on the TV. Please select an audio output format compatible with the audio format of the program you are watching and the equipment connected.

PCM: For connecting to equipment that does not support Dolby Digital and DTS. The same audio (main, sub, or main/sub) as the audio of the program being viewed is output.

2-channel audio with a sampling rate of 48 kHz or less is output as linear PCM audio.

Bitstream: For connecting to an audio system that supports Dolby Digital and DTS. Audio is output through both the main and sub channels.

NOTE

- Analog channel audio and video input audio are output in PCM mode even when "Bitstream" is selected.
- PCM digital input signals are output in PCM mode even when "Bitstream" is selected.

Audio Select

This function sets the terminal to output the computer audio. The adjustment items vary depending on the input source. Select the input source corresponding to the terminal connected to the PC and then adjust the desired item. To perform the operation, refer to "Initial Setup" > "Input Settings" > "Audio Select".

[\(See page 7-2.\)](#)

Output Select

Allows you to select what controls the audio output.

Fixed: Sound via speaker is adjusted with **VOL+/-** on the remote control unit or on the TV.

Sound via the AUDIO OUT terminal is not adjustable and outputs at a consistent level.

Variable: Sound via the AUDIO OUT terminal is adjusted with **VOL+/-** on the remote control unit or on the TV.

Sound via speaker is muted.

Input Select

For image input applied to the COMPONENT IN or VIDEO IN terminal, switch to "**COMPONENT**" or "**VIDEO**", respectively.

COMPONENT: Select component video

VIDEO: Select composite video.

NOTE

- If no (color) image display, try changing to another signal type.
- Check the operation manual of the external equipment for the signal type.

Input Skip

This setting allows you to skip the TV, HDMI or PC IN Input ("TV, PC IN, COMPONENT, HDMI 1, HDMI 2, HDMI 3 and VIDEO") on the Input Selection operation.

Example



Initial Setup (Continue)

Input Settings

Color System

Select the video signal system compatible with your equipment from the list below:

Auto/NTSC/PAL-M/PAL-N

NOTE

- "Color System" can only be set for the TV or VIDEO IN.

LINK Setup

Make the settings to use LINK Operation.

Set the settings with "Initial Setup" > "Input Settings" > "LINK Setup".

[\(See page 6-2.\)](#)

Fine Sync.

You can adjust the position on the image input from a PC the settings with "Initial Setup" > "Input Settings" > "Fine Sync."

[\(See page 7-1.\)](#)

Reset

If complex adjustments are made and the settings cannot be restored to normal, you can reset the settings to the factory preset values.

- If you have already set the Secret No., input the 4-digit secret number here.

NOTE

- The Channel Setup settings will not be changed.
- The Language settings will not be changed.
- The TV Location settings will not be changed.

Example

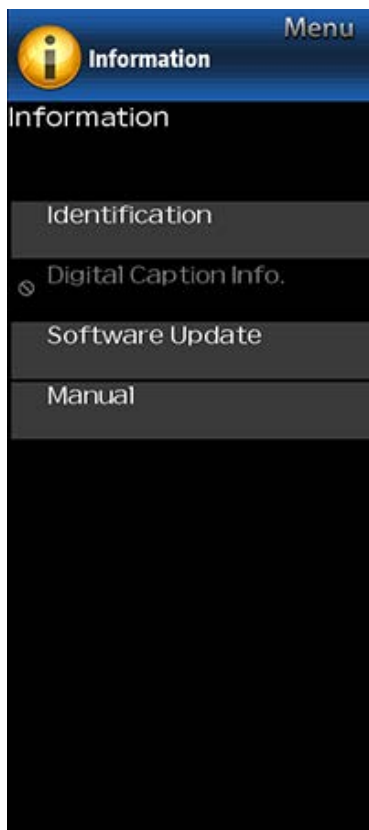

Information

NOTE

- For operating the on-screen display menu, [see page 4-3.](#)

Identification

The current version of the TV software is displayed.

Digital Caption Info. (Digital Caption Information)

This function allows viewing of digital closed caption information for the digital broadcast program being viewed.

NOTE

- This list is not displayed for analog broadcasts or external input audio/video.
- This information is not included in CC1, CC2, Text1, or Text2, and is not displayed in a list.

Software Update

This is used to upgrade the system software to enhance the TV functions.

- 1 Press **MENU** to display the MENU screen, and then press **◀▶** to select "Information".
- 2 Press **▲▼** to select "Software Update", and then press **ENTER**.
- 3 Press **▲▼** to select "Manual Update" or "Auto Update Setting", and then press **ENTER**.
 - The operations thereafter vary depending on the setting.

Auto Update Setting

When the TV is on, or when an Internet application is being accessed, this function enables the TV to connect to the network and check for updates automatically. When an update is available, a message is displayed. Press **◀▶** to select "Yes", and then press **ENTER** to display the download screen. ([See page 4-16.](#))

NOTE

- This function does not work when a broadband connection or Internet Setup is not available.
- A message may also be displayed when an application is running. The message varies depending on the application.

Manual Update

Select the method for manually updating the software.

USB Update: Updates the software using a USB memory device containing the update file. (See "Updating the Software with a USB Memory Device".)

Network Update: Downloads the update file via the network and then updates the software. ([See page 4-16.](#))

NOTE

- A broadband connection and Internet Setup are required to update the software using the network. ([See pages 8-2 to 8-4.](#))
- It may take time to access and download the update depending on the Internet connection and other factors.

Updating the Software with a USB Memory Device

To check for the availability of a software update, visit <http://www.sharpusa.com/products/support/>. If you have any questions, please call 1-800-BE-SHARP (800-237-4277).

Example

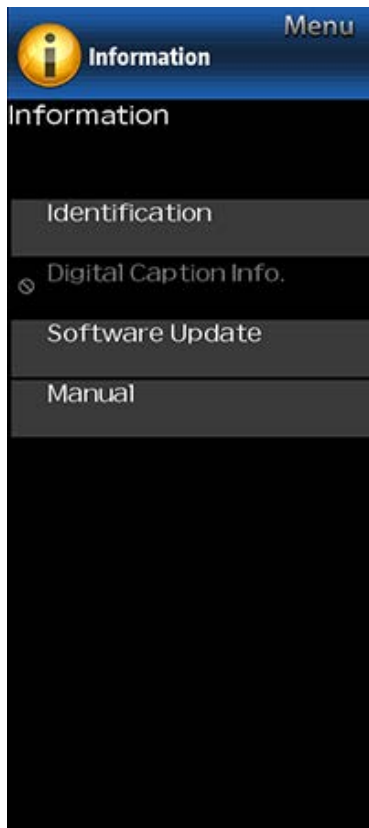

Information (Continue)

Software Update

Manual Update

CAUTION

- Do not remove the USB memory device or unplug the AC cord while the software is being updated.
- Be sure to properly follow the whole procedure described below, step by step. Otherwise, for example, the TV cannot read the data in the USB memory device and software updating will fail.

1 Insert the USB memory device with the update file into the USB terminal on the TV.

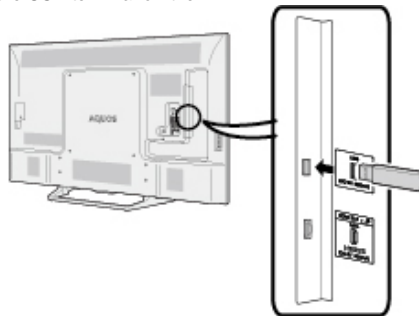

- 2 Press ▲/▼ on the Manual Update screen to select "USB Update", and then press **ENTER**.
- 3 Press **ENTER** to start checking the data in the USB memory device.



- 4 During the data checking, "Checking" blinks.
 - The current version of the TV software and the version of the update file on the USB memory device are displayed.
 - If the USB memory device is not properly installed or the correct update file cannot be found on the USB memory device, an error message is displayed. Check the file on the USB memory device, and then reinsert the USB memory device correctly.

Example

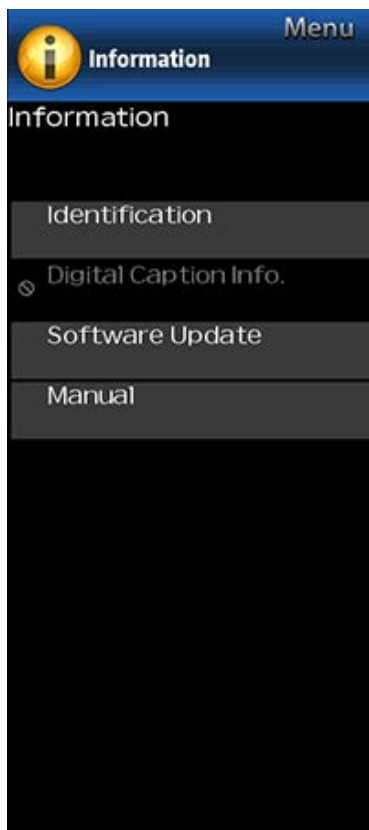

Information (Continue)

Software Update

Manual Update

CAUTION

- Do not remove the USB memory device or unplug the AC cord while the software is being updated.

5 When the software is successfully updated, a screen is displayed indicating that the update process is completed.

After this screen is displayed, the TV automatically turns off and then turns on again.

- If the update has failed, check the file in the USB memory device and try Software Update again.

6 Remove the USB memory device.

Updating the Software via the Network

- 1 Press ▲/▼ on the Manual Update screen to select "Network Update", and then press **ENTER**.
 - The TV connects to the network and checks for updates.
 - To cancel, press **ENTER**.
- 2 The current version of the TV and the latest version of software are displayed. To update the TV software, select "Yes", and then press **ENTER**.
 - When a server connection cannot be established or an update is not available, a message is displayed. If a server connection cannot be established, check the broadband connection and Internet Setup.
- 3 After the update file is downloaded, the software update process begins.

CAUTION

- Do not unplug the AC cord while the software is being updated.
- 4 When the software is successfully updated, a screen is displayed indicating that the update process is completed. A screen indicating that the update is completed is displayed. 4 seconds later, the TV restarts automatically.
 - If the software was not updated successfully, check the broadband connection and Internet Setup, and then try updating the software again.

Manual

Displays the built-in operation manual on the screen. You can read information about how to use this device.

Example



Picture Settings

Adjusts the picture to your preference with the following picture settings.

NOTE

- For operating the on-screen display menu, [see page 4-3](#).

Selected item	◀ button	▶ button
Backlight	The screen dims	The screen brightens
Contrast	For less contrast	For more contrast
Brightness	For less brightness	For more brightness
Color	For less color intensity	For more color intensity
Tint	Skin tones become reddish	Skin tones become greenish
Sharpness	For less sharpness	For more sharpness

- For resetting all Picture adjustment items to the factory preset values, press ▲/▼ to select "Reset", press ENTER, press ▲/▼ to select "Yes", and then press ENTER.

AV MODE (Changing Pic.Quality)

The audio and video settings can be changed to suit the program or input content being watched.

NOTE

- The selectable items vary depending on the input source and on the model of your TV.
- You can select AV MODE by pressing AV MODE on the remote control unit.
[See page 3-10](#) for details of AV MODE settings.

Example



Picture Settings (Continue)

Automatic Light Sensor(Light Sensor)

Automatically adjusts the brightness of the screen.

Off: The brightness is fixed at the value set in "Backlight".

On: Automatically adjusts.

On:Display: Displays the Light Sensor effect on the screen while adjusting the brightness of the screen.

NOTE

- When set to "On", the Light Sensor senses the surrounding light and automatically adjusts the backlight brightness. Make sure nothing obstructs the Light Sensor, which could affect its ability to sense surrounding light.
- When set to "On:Display", Light Sensor effect displays on the screen while the Light Sensor adjusts the screen brightness.



Advanced

Motion Enhancement

Use Motion Enhancement to view fast-action video more clearly.

Selected item	Description
AquoMotion480 (EQ30U only)	Drives precision clarity during fast motion scenes.
AquoMotion240	Turn the LED backlight on or off for 120Hz drive display.
120Hz	For obtaining a clearer image.
Off	Original image.

NOTE

- "Motion Enhancement" may cause image noise. If this occurs, turn the function "Off".

Digital Noise Reduction

Produces a clearer video image.

Auto: Automatically adjusts the level of noise reduction.

High/Middle/Low: You can select a desired level for viewing a clearer video image.

Off: No adjustment.

Example



Picture Settings (Continue)

Advanced

C.M.S. (Color Management System)

Color tone is managed using the six-color adjustment setting.

C.M.S.-Hue: This is a standard to adjust the color either more reddish or more bluish in tone.

C.M.S.-Saturation: Increases or decreases the saturation of a selected color.

C.M.S.-Value: A higher value makes the image brighter. A lower value makes the image darker.

NOTE

- For resetting all adjustment items to the factory preset values, press ▲/▼ to select "Reset", and then press ENTER.

Color Temp. (Color Temperature)

For a better white balance, use color temperature correction.

High: White with bluish tone

Middle:



Low: White with reddish tone

Fine tuning the color temperature

White balance can be adjusted between a maximum of +30 and a minimum of -30 for each color temperature.

NOTE

- For resetting all adjustment items to the factory preset values, press ▲/▼ to select "Reset", and then press ENTER.

Example



Picture Settings (Continue)

Advanced

Active Contrast

Automatically adjusts the image contrast according to the scene.

On: Produces high contrast image.

Off: No adjustment.

Film Mode (3:2 pull-down)

This function provides high-quality playback of images originally encoded at 24 frames/second, such as films.

Advanced: Adjusts effects to reduce judder film contents.

You can select a desired level of judder reduction from 0 to +10.

Standard: Plays back image with equal display time for each frame, reproducing movie theater experience.

Off: Normal viewing mode.

NOTE

- "Film Mode" does not function depending on input signal type.
- "Standard" does not function depending on input signal type.

Monochrome

For viewing a video in monochrome.

Reset

Returns Picture Settings to their factory preset values. To reset, select "YES" and then press **ENTER**.

Example

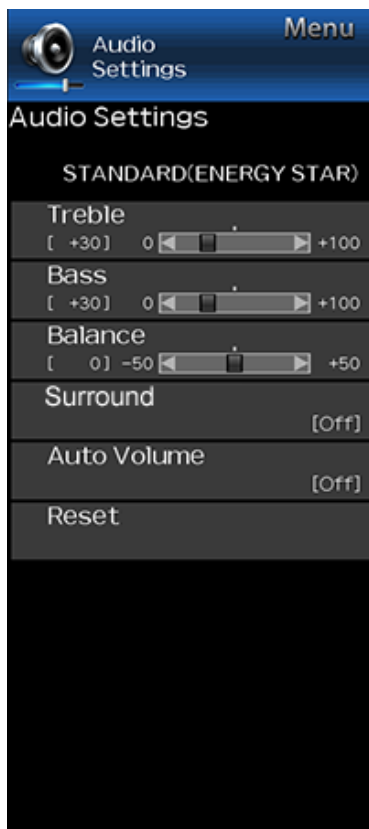

Audio Settings

You can adjust the sound quality to your preference with the following settings.

NOTE

- For operating the on-screen display menu, [see page 4-3.](#)

Selected item	◀ button	▶ button
Treble	For weaker treble	For stronger treble
Bass	For weaker bass	For stronger bass
Balance	Decrease audio from the right speaker	Decrease audio from the left speaker

NOTE

- The Audio menu is grayed out when "Output Select" is set to "Variable". ([See page 4-12.](#))
- For resetting Audio adjustment items to the factory preset values, press ▲/▼ to select "Reset", press **ENTER**, press ▲/▼ to select "Yes", and then press **ENTER**.

Surround

The surround function produces Surround effect from the speakers.

NOTE

- The Audio Settings menu is grayed out when "Output Select" is set to "Variable". ([See page 4-12.](#))
- For some discs, setup may be required on your BD/DVD player. In this case, please refer to the operation manual of your BD/DVD player.

Auto Volume

Different sound sources sometimes do not have the same loudness level, such as a program and its commercial breaks. The Automatic Volume Control(Auto Volume) reduces this problem by equalizing.

ON: Reduces the loudness gaps among different sound source. The result is automatically adjusted according to the sound sources.

OFF: No adjustment.

Reset

Returns Audio Settings to their factory preset values. To reset, select "YES" and then press **ENTER**.

Example



Smart TV

Dashboard

You can display a list of the main Smart TV settings.

Internet Setup

Configures LAN and Internet settings.

[\(See page 8-2 to 8-4.\)](#)

AQUOS Remote Control

Set this function when operating the TV from equipment connected by LAN or wireless LAN.

[\(See page 7-3.\)](#)

Example

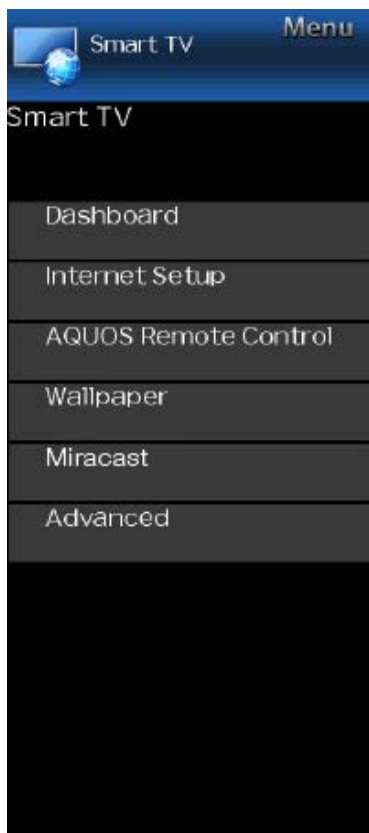

Smart TV (Continue)

Wallpaper

Activating the function will display still images when the TV is in standby mode.

Wallpaper Mode

Configures Wallpaper Mode settings.

Off: Nothing will be displayed.

On: Still images will be displayed when the TV is in standby mode.

Data Source

For the wallpaper, you can select either the still images pre-installed in the TV or your favorite still images stored in the USB memory device.

Pre-Installed: The images pre-installed in the TV will be displayed in a slideshow.

USB: Your favorite images stored for the wallpaper will appear.

If only a single still image is stored in the USB memory device, that image will be displayed as the wallpaper.

When there are multiple still images in the memory, all the images will be displayed in a slideshow.

NOTE

- Images are displayed in 3-minute intervals as a slideshow.

When you display images by using the USB memory device:

- Create a folder named "WP" in the root directory of the USB memory device (the first directory when the USB memory device is opened), and store into the folder the still images you want to display for the wallpaper.
- You must insert the USB memory device to the TV before turning off the TV.
- If there are images on the USB memory device but they do not appear on the screen, switch to USB mode and check whether the image files on the USB memory device are shown correctly.

Timer Setting

You can set the length of time the TV will remain in the Wallpaper Mode.

3 hours/6 hours/12 hours/24 hours

NOTE

- No buttons except for **POWER** work even while the still images are being displayed.
- If the ready-for-use USB memory device is not inserted, the still images pre-installed in the TV will be displayed in a slideshow even when "Data Source" is set to "USB".
- Because the USB memory device cannot be detected immediately after the TV is turned on from standby mode, the wallpaper pre-installed in the TV may be displayed even when "Data Source" is set to "USB".
- The still images will be displayed until the set time has elapsed.

Example



Smart TV (Continue)

Miracast

You can connect a device such as a Miracast-compatible smartphone or tablet to the TV.
([See page 9-1.](#))

Advanced

TV Name Setting

Set this function when operating the TV from equipment connected by LAN or wireless LAN.
([See page 7-3.](#))

Use the software keyboard when you need to input text at TV Name Setting.

Software Keyboard



ABC

Switches character to uppercase. If "abc" is pressed again, switches character to lowercase.
":&12"

Changes character set into the alphabet, numbers, symbols, etc.

OK

Applies the entered information and closes the software keyboard.

space

Enters a space.

DEL

Erases the character string.

Netflix Help

You can deactivate the Netflix function. Refer to "Smart TV" > "Advanced" > "Netflix Help" and select "Deactivate".
([See page 8-13.](#))

VUDU Help

To deactivate the VUDU function, refer to "Smart TV" > "Advanced" > "VUDU Help" and select "Yes".
([See page 8-13.](#))

Example

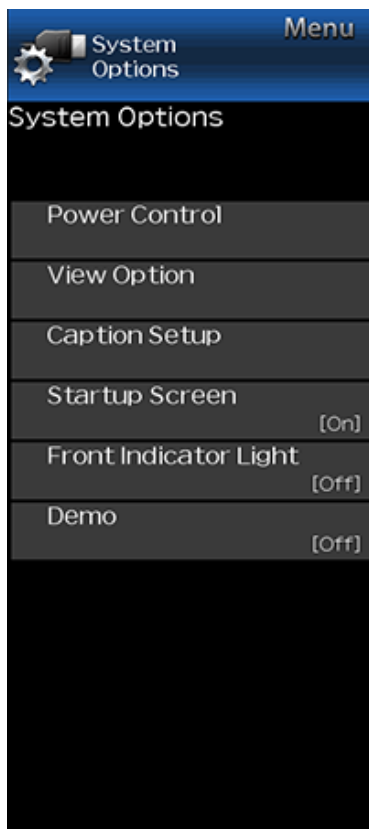

System Options

NOTE

- For operating the on-screen display menu, [see page 4-3](#).

Power Control

Power control setting allows you to save energy.

No Signal Off

When this function is enabled, the TV automatically shuts down if no signal is received for more than 15 minutes.

NOTE

- When it is 5 minutes before the power shuts down, the remaining time will start to keep appearing every minute.
- When a TV program finishes, this function may not operate.

No Operation Off

When you enable this function, the TV automatically shuts down if no operation is performed for more than 3 hours.

NOTE

- When it is 5 minutes before the power shuts down, the remaining time will start to keep appearing every minute.

View option

View Mode

This function changes the screen size. Select "View Option" on the menu to display the View Mode menu screen.

The View Mode menu varies depending on the input source.

Change Audio

MPX

Allows you to change the audio when multiple audio is available for the program you are watching.

NOTE

- You can change Audio by pressing AUDIO on the remote control unit.
[See page 3-8](#) for details of Audio function.

Audio Only

When listening to music from a music program, you can turn the screen off and enjoy audio only.

NOTE

- The screen image will return to normal when a button (except those for audio adjustment, such as **VOL**, **MUTE**) is presses.

Change CC

Allows you to change the Closed Caption display. Select "Change CC" on the menu to display the Closed Caption information.

- The information displayed varies depending on the program you are watching.

NOTE

- You can change Closed Caption by pressing **CC** on the remote control unit.
[See pages 3-12 to 3-13](#) for details of Closed Caption function.

Example

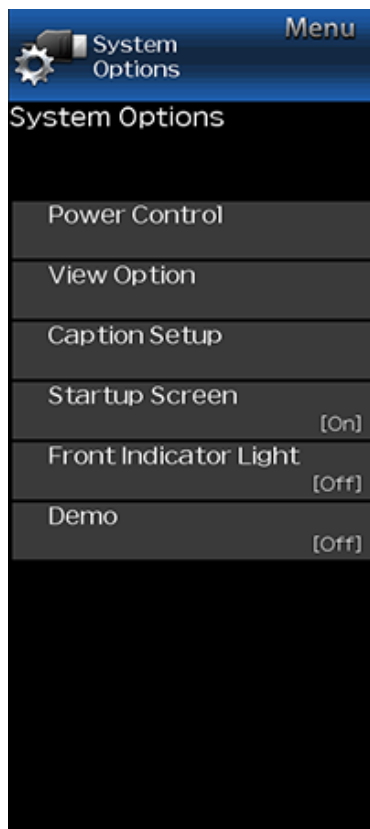

System Options (Continue)

Caption Setup

This function allows you to adjust the closed caption screen appearance to suit your preference.

Size/Edge Effect/Edge Color/Text Color/Background Color/Text Opacity/Background Opacity

NOTE

- The default value depends on the broadcasting station.

Startup Screen

With this function activated, the SHARP logo will be displayed when you turn on the TV.

NOTE

- This function is not available when the TV is set to "Quick Start Mode".

Front Indicator Light

When this function is set to "On", the LED on the front of the TV turns on.

NOTE

- "On" is the factory preset value. If you want to turn off the LED, set the function to "Off".

Demo

You can select the image from several types of demo mode.

NOTE

- What kinds of setting item are available depends on the model of your TV.
- "Demo" may not be selected depending on input signal type or application status.
- "Demo" may be automatically canceled depending on input signal type.

Enjoying Photo/Music/Video Playback

Preparation

You can connect the TV to a USB memory device, USB hard drive or Home Network server to enjoy viewing pictures, listening to music, and watching videos.

NOTE

- Depending on the USB memory device/USB hard drive/Home Network server, the TV may not be able to recognize the recorded data.
- It may take time to read the recorded data if the USB memory device/USB hard drive/Home Network server contains many files or folders.
- Use only alphanumeric characters for naming files.
- File names over 80 characters (may vary depending on character set) may not be displayed.

Connecting a USB Memory Device/USB Hard Drive

Insert the USB memory device with recorded photos, music or videos into the USB terminal on the TV.

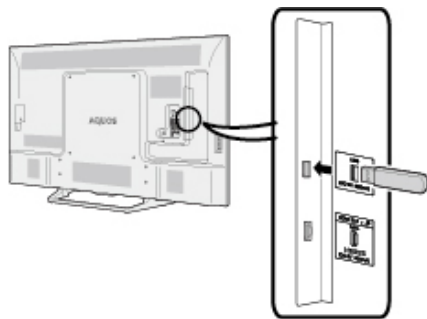

- When connecting a USB hard drive, be sure to use a hard drive with an AC adapter.
- Do not remove a USB memory device or memory card from the TV while transferring files, using the slide show function, or switching screens, or before you exit "USB" from the INPUT list.
- Do not insert and remove a USB memory device/USB hard drive to and from the TV repeatedly.
- When using a card reader, be sure to insert a USB memory device first.

CAUTION

- Do not use a USB extension cable when connecting a USB memory device to the USB terminal on the TV.
- Using a USB extension cable with the USB memory device may prevent the TV from performing correctly.

Connecting a Home Network Server

Connect the TV to the Home Network server using an ETHERNET cable.

- You can also connect a Home Network server by using a wireless LAN.

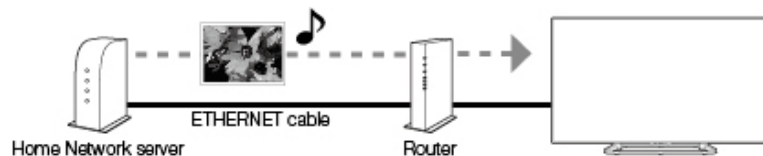

NOTE

- Do not disconnect a Home Network server from the TV while transferring files, when a screen is switching to another or before you exit "Home Network" from the INPUT list.
- Do not connect and disconnect a Home Network server from the TV repeatedly.



Selecting the Folders to Play Back

- To play back data on a USB memory device, insert the USB memory device on the TV.
- Use the following procedure to switch back to USB mode after switching from USB mode to another mode.
 - 1 Select "USB" or "Home Network" from INPUT list screen.
 - 2 Press to select "Photo", "Music" or "Video", and then press **ENTER**.

Example



- 3 Press to select the desired folder, and then press **ENTER**.
 - "VIEW MODE" is fixed during the Music mode. During "Video mode", you can select "Auto", "Original" or "Stretch".
 - During "Video mode", videos that are smaller than the number of pixels on the screen are displayed at their original size. In these cases, switch "VIEW MODE" to "Auto" to have the video fill the screen.

NOTE

- The Media screen can be displayed even by using the application window. To display the application window, press **SmartCentral**. ([See page 3-6.](#))
- 16 is the maximum number of USB drives and 10 is the maximum number of Home Network servers that can be displayed.

USB Device Compatibility

USB device	USB Memory, USB card reader (Mass Storage class), USB hard drive
File system	FAT/FAT32/NTFS (USB hard drive only)
Photo file format	JPEG (.jpg) (DCF2.0 compliant)
Music file format	MP3 (.mp3) Bitrate: 32k, 40k, 48k, 56k, 64k, 80k, 96k, 112k, 128k, 160k, 192k, 224k, 256k, 320kbps Sampling frequency: 32k, 44.1k, 48kHz



Selecting the Folders to Play Back (Continue)

Video file format			
File extension	Container	Video	Audio
.avi	AVI	MPEG-1 MPEG-4 SP/ASP(XviD) MPEG-4 AVC (H.264) Motion JPEG	MPEG-Audio LPCM MS-ADPCM DTS AC3
.mkv	MKV	MPEG-1 MPEG-2 MPEG-4 SP/ASP(XviD) MPEG-4 AVC (H.264)	MPEG-Audio LPCM MS-ADPCM DTS AC3
.asf .wmv	ASF WMV	MPEG-4 SP/ASP(XviD) WMV 7/8/9	LPCM WMA
.mp4	MP4	MPEG-4 SP/ASP(XviD) MPEG-4 AVC (H.264) Motion JPEG	MPEG-Audio LPCM MS-ADPCM AC3
.mpg .mpeg	MPG	MPEG-1 MPEG-2	MPEG-Audio LPCM MS-ADPCM AC3

NOTE

- Progressive format jpeg files are not supported.
- USB 1.1 devices may not be played properly.
- Operation using USB hubs is not guaranteed.
- Some video file formats may not be played depending on the file.
- Some images may not be displayed in the appropriate aspect ratio depending on the file format.

Home Network Server Compatibility

Photo file format	JPEG
Music file format	LPCM, MP3
Video file format	AVI, ASF, MP4, WMV, MPG

NOTE

- Progressive format jpeg files are not supported.
- Some video file formats may not be played depending on the file or the server.



Playing Back Files on a USB Memory Device/Home Network Server

NOTE

- The screen images in this section are for the USB mode. It may be slightly different in the Home Network mode.

Photo Mode

Viewing Thumbnails

Example



Buttons for thumbnail operations

Buttons	Description
▲▼◀▶	Select a desired item.
ENTER	When selecting a folder icon: Enter this directory. When selecting a photo thumbnail: Start the slide show.
RETURN	Return to the previous process.
A (red)	Clear the file information display.
B (green)	
C (blue)	
D (yellow)	

NOTE

- A few seconds after the cursor is positioned on a thumbnail, the file information is displayed on the right of the center of the screen.



Playing Back Files on a USB Memory Device/Home Network Server (Continue)

Slide Show

The photos displayed on the thumbnail selection screen are displayed as a slide show.

Buttons for slide show operation

Buttons	Description
RETURN	Return to the thumbnail selection screen.
B (green)	Previous file
C (blue)	Displaying/hiding operation guidance
D (yellow)	Next file

NOTE

- Rotating photos only applies to the temporarily selected item and this setting is not saved.



Playing Back Files on a USB Memory Device/Home Network Server (Continue)

Music Mode

Example



Buttons for music mode

Buttons	Description
▲▼◀▶	Select a desired item.
ENTER	When selecting a folder icon: Enter this directory. When selecting a music file: Play music.
RETURN	Return to the previous process.
A (red)	Clear the file information display.
B (green)	
C (blue)	
D (yellow)	

NOTE

- The displayed play time may differ slightly from the actual play time depending on the files.
- A few seconds after the cursor is positioned on a thumbnail, the file information is displayed in the right of the center of the screen.



Playing Back Files on a USB Memory Device/Home Network Server (Continue)

Video Mode

Example



Buttons for file selecting operations

Buttons	Description
▲/▼/◀/▶	Select a desired item.
ENTER	When selecting a folder icon: Enter this directory. When selecting a video file: Play the video.
RETURN	Return to the previous process.
A (red)	Clear the file information display.
B (green)	
C (blue)	
D (yellow)	

NOTE

- A few seconds after the cursor is positioned on a thumbnail, the file information is displayed in the right of the center of the screen.

Playing Back Files on a USB Memory Device/Home Network Server (Continue)

Buttons for playing mode

Buttons	Description
▲	Stop playback
▼	Stop playback
▶	Fast forward
◀	Fast rewind
A (red)	Subtitle
B (green)	Previous file
C (blue)	Display/hide operation guide
D (yellow)	Next file
RETURN	Go back to the file selection screen.





Presetting Remote Control Function

You can operate the connected AV products (AV receiver, cable box, SAT tuner, DTV, VCR, BD, DVD, LD) using the presetting manufacturer function of your remote control unit.

Presetting manufacturer codes

- 1 Press an appropriate button (**STB**, **DVD-VCR** or **AUDIO**) to operate the connected equipment.
- 2 Press an appropriate button (**STB**, **DVD-VCR** or **AUDIO**) and **MANUAL** at the same time to enter the code registration mode.
- 3 Press **0-9** to enter the manufacturer code.
 - Preset mode is finished once the LED no longer lights up.
- 4 After registering the code, the LED will stop blinking then turn off after one second. (If you perform an incorrect operation, the LED will blink quickly then turn off.)

Manufacturer codes

STB BRAND	REMOTE CONTROL CODE NUMBER
ANVISION	04, 05
CABLE STAR	04, 05
DISH NETWORK	39, 40
DIRECTV	41
EAGLE	05
G.INSTRUMENT	02, 03, 10, 11, 17, 20
GERROLD	17
JERROLD	02, 03, 10, 11, 12, 20, 25-34
MAGNAVOX	04, 05, 08, 12, 15, 16, 18, 19, 22, 23
MOTOROLA	38
OKA SIGMA	07
PANASONIC	14, 21
PHILIPS	04, 05, 08, 13, 15, 16, 18, 19, 22, 23
PIONEER	07
RANDTEK	04, 05
RCA	14, 36*, 37*
S.ATLANTA	01, 09, 24
VIEWSTAR	04, 05, 08, 13, 15, 16, 18, 19, 22, 23
ZENITH	06, 35

NOTE

- Numbers marked with * are SAT codes, all others are STB codes.



Presetting Remote Control Function (Continue)

BD/DVD/LD BRAND	REMOTE CONTROL CODE NUMBER
DENON	24
JVC	31
KENWOOD	36
MAGNAVOX	26
MARANTZ	26
MITSUBISHI	28
PANASONIC	24, 37
PHILIPS	26, 38
PIONEER	30, 33, 35
PROSCAN	25
RCA	25, 39
SAMSUNG	29, 34
SHARP	23, 32, 41, 42
SONY	27, 40
TOSHIBA	26
YAMAHA	24
ZENITH	26

- Depending on the brand, the codes of some BD players may not be supported.

VCR BRAND	REMOTE CONTROL CODE NUMBER
AUDIO DYNAMICS	09
BROCKSONIC	13
CANON	04
CRAIG	12
CURTIS MATHIS	04
DBX	09
EMERSON	10, 13, 14
GE	04
INSTANT REOLYA	04
JC PENNEY	04
JVC	09, 16, 17, 22
KENWOOD	09
MAGNAVOX	04, 05, 06
MAGNIN	12
MEMOREX	04
MONTGOMERY WARD	02
NEC	09
PANASONIC	04, 18, 19, 20, 21
PENTAX	05
PHILCO	04, 05
PHILIPS	04, 05, 06
QUASAR	04
REALISTIC	01, 02
SAMSUNG	11, 12



Presetting Remote Control Function (Continue)

VCR BRAND	REMOTE CONTROL CODE NUMBER
SHARP	01, 02, 03
SONY	07, 08, 15
SYLVANIA	04, 05, 06
TATUNG	09
TEAC	09
TMK	10
YAMAHA	09

AUDIO BRAND	REMOTE CONTROL CODE NUMBER
SHARP	01
SHARP (SOUND BAR)	02

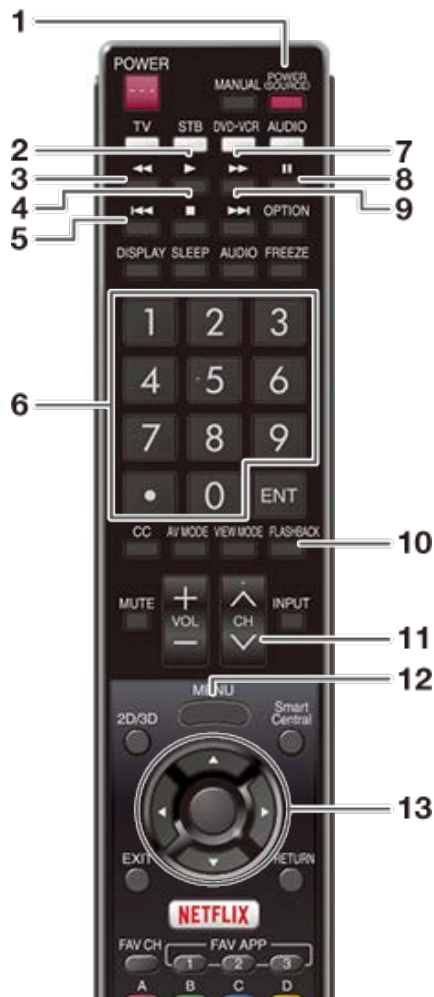

Operating the Connected Equipment

To operate the connected equipment, press **STB**, **DVD•VCR** or **AUDIO** to select your device. (STB (cable/satellite set-top box), BD, DVD, VCR or AUDIO.) The remote control unit button will function as follows.

- When you operate VCR, DVD or BD, press **INPUT** to select the terminal connected to your device.

- CABLE and SAT cannot be selected at the same time.

1 POWER (SOURCE)

- Turns the connected equipment power on and off.

2 ▶

- Starts playback. (VCR, BD, DVD)

3 ◀◀

- Rewinds the tape and allows picture search. (VCR)
- Hold down to go in reverse. (BD, DVD)

4 ■

- Stops the tape transport. (VCR)
- Playback stops when pressed. With some Blu-ray disc/DVD players, pressing the button twice may open the disc tray. (BD, DVD)

5 ◀◀◀

- Pressing quickly once takes you to the start of the chapter currently playing. Each time you press it, you move back to the start of the previous chapter. (BD, DVD)

6 0-9, • (DOT)

- Press a button (or buttons) that corresponds to the channel that you wish to watch. (STB)

7 ▶▶

- Rapidly advances the tape and allows picture search. (VCR)
- Hold down to fast forward. (BD, DVD)

8 ||

- Sets pauses and still pictures. (VCR, BD, DVD)

9 ▶▶▶

- Pressing quickly once takes you to the start of the next chapter. Each time you press it, you move ahead to the start of the next chapter. (BD, DVD)

10 FLASHBACK

- Press to switch between the current channel and the channel you were watching immediately before. Some manufacturers do not preset FLASHBACK. (STB)

11 CH▲▼

- Press **CH▲** or **CH▼** to tune in to a higher or lower channel. (STB)
- Press to select the channel of the TV tuner on the VCR. (VCR)

12 MENU

- When this button is pressed, the BD/DVD menu will display. (BD, DVD)

13 ▲▼◀▶, ENTER

- **▲▼◀▶**: Press the button to select items on the STB GUIDE screen or STB MENU screen. (STB)
- Press the button to select items on the BD/DVD menu screen. (BD, DVD)
- **ENTER**: Press to activate the selected function. (STB, BD, DVD)

Using LINK Operation

Controlling HDMI Equipment Using LINK Operation

What's LINK Operation?

- Using the HDMI CEC (Consumer Electronics Control) protocol, with LINK Operation you can interactively operate compatible system equipment (Blu-ray disc equipment, AV amplifier, DVD).
- LINK Operation allows you to operate the HDMI-connected equipment with one remote control.

NOTE

- For connecting the TV to LINK-compatible equipment, use commercially available cables.
- Point the remote control toward the TV, not to connected HDMI equipment.
- Video noise may occur depending on the type of HDMI cable used. Make sure to use an HDMI-certified cable.
- Up to 3 pieces of HDMI recording equipment and one AV amplifier can be connected using this system.
- These operations affect the HDMI equipment selected as the current input source. If the equipment does not operate, turn on the equipment and select the appropriate input source using **INPUT**.
- The LINK feature may not operate properly when an HDMI splitter or AV selector unit is used. These devices may cause interruptions to the image and/or sound.

Connected LINK-compatible devices can be operated without changing the settings of the remote control unit.

The **OPTION** button will function only when LINK Operation is used.

Control the LINK-compatible audio system

Set the volume of LINK-compatible audio system.

NOTE

- The steps in "LINK Setup" on [page 6-2](#) need to be completed beforehand.
- Refer to this operation manual and the operation manual of the LINK device to be used with this TV.

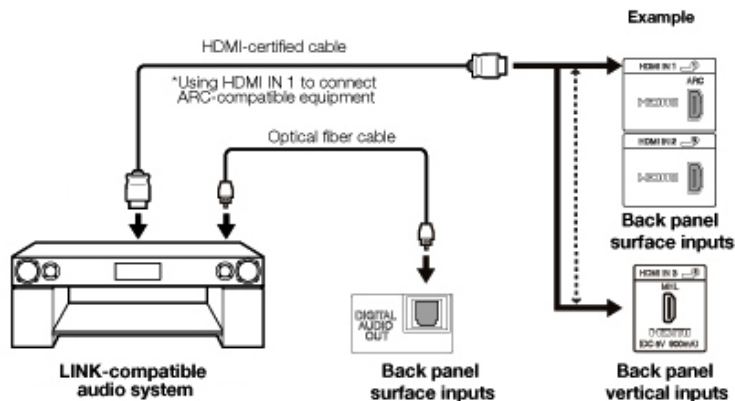



Controlling HDMI Equipment Using LINK Operation (Continue)

LINK Setup

Make the settings to use LINK Operation. Set the settings with "Initial Setup" > "Input Settings" > "LINK Setup".

Link Operation

Select LINK Operation Control to disable the LINK function even when a LINK-compatible HDMI device is connected to the TV. This function prevents the device from starting to operate unexpectedly.

Auto Power On

If this is activated, the One Touch Play function is enabled. While the TV is in standby mode, it automatically turns on and plays back the image from the HDMI source.

Audio Return Channel

This function allows you to listen to the TV audio via audio equipment without using an optical fiber cable, which conventionally is required.

Requirements for using an ARC-compatible AV amplifier:

- ARC-compatible AV amplifier connected to the ARC-compatible HDMI IN terminal. (HDMI IN 1) (Refer to the operation manual of the ARC-compatible equipment for details.)
- Use of an ARC-compatible cable.

Auto: You can listen to the TV audio with ARC-compatible audio equipment.

Off: This function does not work.

NOTE

- If the TV audio cannot be output from the AV amplifier even after making the necessary settings, connect the TV to the AV amplifier with an optical fiber cable and select "Off".



Link Operation Menu



Recorder Power On/Off

You can manually turn on/off the power of the connected LINK-compatible equipment. Each time you press **ENTER**, the connected equipment switches on or off.

The Link Operation Menu allows you to make adjustments during operation of LINK-compatible equipment.

- 1 Press **OPTION** to display the Link Operation Menu.
- 2 Press **▲/▼** to select the desired item, and then press **ENTER**.
 - Specific operations differ depending on the item you select. Following are the basic operations for each item.



Link Operation Menu (Continue)

Show Start Menu

You can call up a setup menu from the connected LINK-compatible equipment.

NOTE

- Depending on the status of the equipment (recording or in standby mode, etc), the setup menu will not be displayed.

Change Audio Output Device

You can select to listen to the TV sound only from the LINK-compatible audio system.

By AQUOS audio SP: The sound from the TV speaker is muted and only the sound from the LINK-compatible audio system is audible.

- You can use **VOL+/-** and **MUTE**.

By AQUOS SP: The sound is output from the TV speaker.

HDMI Device Selection

If multiple HDMI devices are connected in a daisy chain, you can specify which device to control here.

Press **▲/▼** to select the desired device from a list of connected HDMI devices, and then press **ENTER**.

LINK Setup

You can also display the LINK Setup screen from the Link Operation Menu.



Using a Smartphone with the TV

This function enables you to connect the TV to a smartphone that supports Mobile High-Definition Link (MHL™) using an MHL cable.

To connect the TV to your MHL-compatible smartphone, be sure to use an MHL cable (commercially available).

- You can view pictures and video on a large screen.
- You can play back music files.

NOTE

- An MHL-compatible portable device is required to use this function. Connect the device to the HDMI IN 3 terminal.
- This product incorporates MHL 1.

Auto Power On

When an MHL-compatible device is connected to the TV, the TV turns on automatically.

- This function operates when "LINK Operation" is set to "On".

[\(See page 6-2.\)](#)

Auto Input Selection

When an MHL-compatible device is connected while the TV is on, the input mode is selected automatically.

- This function operates when "LINK Operation" is set to "On".

[\(See page 6-2.\)](#)

Operation Using the Remote Control

The remote control of the TV can be used to operate a portable device.

- ▲▼◀▶, ENTER, EXIT, 0-9, • (DOT), ENT, etc.
- The operations vary depending on the connected equipment and content being viewed.

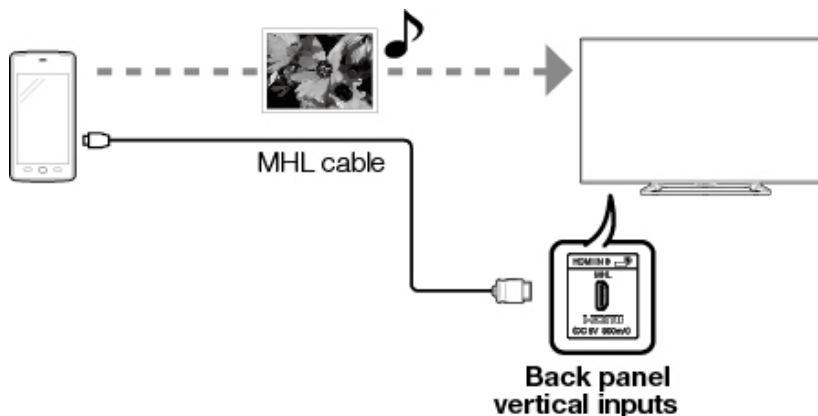

Using a PC

Adjusting the PC Image

You can adjust the position of the image input from a PC by selecting "Initial Setup" > "Input Settings" > "Fine Sync."

Fine Sync.

Ordinarily you can easily adjust the picture as necessary to change image position using "Auto Sync.". In some cases, however, manual adjustment is needed to optimize the image.

Input Signal: Select the input signal.

1024x768

1360x768

Auto Sync.: For automatically adjusting the PC image.

Yes: Auto Sync. starts and "Now adjusting the image." is displayed.

No: This function does not work.

H-Pos.: Centers the image by moving it to the left or right.

V-Pos.: Centers the image by moving it up or down.

Clock: Adjust when the image flickers with vertical stripes.

Phase: Adjust when characters have low contrast or when the image flickers.

NOTE

- "Auto Sync." may fail if the computer image has low resolution, has unclear (black) edges, or is moved while executing "Auto Sync."
- Be sure to connect the PC to the TV and switch it on before starting "Auto Sync."
- It is not necessary to adjust the "Clock" or "Phase" when a digital signal is being input, so it cannot be selected.
- The default cursor position may not be in the center, because the screen position variable ranges may be asymmetrical.
- The screen position variable ranges depend on the View Mode or the signal type. The ranges can be seen on the position-setting screen.

Setting Audio Input

Audio Select

This function sets the terminal to output the computer audio. The adjustment items vary depending on the input source. Select the input source corresponding to the terminal connected to the PC and then adjust the desired item. To perform the operation, refer to "Initial Setup" > "Input Settings" > "Audio Select".

HDMI 2

HDMI2(Digital): Select this when the TV and PC are connected using an HDMI-certified cable and audio is input via the same cable.

HDMI+Analog: Select this when the TV and PC are connected using an HDMI-certified cable and the audio is input via a Ø 3.5 mm stereo minijack.

NOTE

- When "Audio Select" is set to "HDMI+Analog", sound will not be produced if you use only an HDMI-certified cable to connect HDMI-compatible equipment. To produce sound, you should make an analog audio connection.
- If you want to connect HDMI-compatible equipment using only an HDMI-certified cable, set "Audio Select" to "HDMI2(Digital)".

Using a PC

Control of the TV

- The TV can be controlled from a PC, control panels and other devices using the RS-232C or IP.
- Use a cross-type RS-232C cable, ETHERNET cable (commercially available) or wireless LAN for the connections.

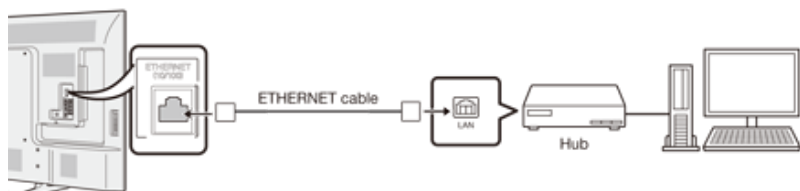
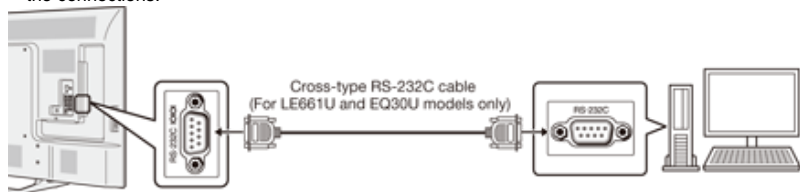

- NOTE**
- This operation system should be used by a person who is accustomed to using computers.

AQUOS Remote Control

Set this function when operating the TV from equipment connected by LAN or wireless LAN. To perform the operation, refer to "Smart TV".

AQUOS Remote Control

When "AQUOS Remote Control" is selected, "Change" will be highlighted. Press **ENTER**.

Detailed Settings

Make the detailed settings (Login ID, password, etc.).
Follow the on-screen instructions to configure the settings.

TV Name Setting

Set the name of the TV displayed on other network devices.

- Use the software keyboard to set the name.
[See page 4-24](#) for details on the software keyboard.

Communication Conditions for IP

Connect to the TV with the following settings made for IP on the PC.

IP protocol:	TCP/IP
Host IP address:	Set the IP address on the TV menu
Service:	None (Do not select Telnet or SSH)
TCP port#:	Set a port number on the TV menu (Control port)

When you set your ID and password on the TV menu, you need to enter them as soon as you connect to the TV.

NOTE

- When you use this function, make settings for "AQUOS Remote Control".
- The connection will be cut off when there has been no communication for 3 minutes.

Communication Conditions for RS-232C (For LE661U and EQ30U models only)

Set the RS-232C communication settings on the PC to match the TV's communication conditions. The TV's communication settings are as follows:

Baud rate:	9,600 bps
Data length:	8 bits
Parity bit:	None
Stop bit:	1 bit
Flow control:	None

Communication procedure

Send the control commands from the PC via the RS-232C or IP.

The TV operates according to the received command and sends a response message to the PC. Do not send multiple commands at the same time.

Wait until the PC receives the OK response before sending the next command.

Using a PC

Control of the TV (Continue)

Command format

Eight ASCII codes +CR

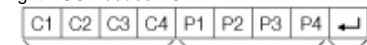

Command 4-digits Parameter 4-digits Return code

Command 4-digits: Command. The text of four characters.

Parameter 4-digits: Parameter 0-9, x, blank, ?

Parameter

Input the parameter values, aligning left, and fill with blank(s) for the remainder. (Be sure that 4 values are input for the parameter.)

When the input parameter is not within an adjustable range, "ERR" returns. (Refer to "Response code format".)

Any numerical value can replace the "x" on the table.

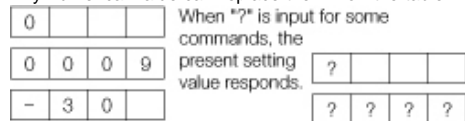

Response code format

Normal response

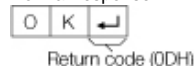

Problem response
(communication error or incorrect command)

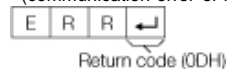

Command table

- Commands not indicated here are not guaranteed to operate.

CONTROL ITEM		COMMAND				PARAMETER				CONTROL CONTENTS	
POWER ON COMMAND SETTING		R	S	P	W	0	-	-	-	Off	The Power On command rejected.
						1	-	-	-	On [RS-232C]	The Power On command accepted. (For LE661U and EQ30U models only)
						2	-	-	-	On [IP]	The Power On command accepted.
POWER SETTING		P	O	W	R	0	-	-	-	Power Off	It shifts to standby.
						1	-	-	-	Power On	Power On *1
INPUT SELECTION	TOGGLE	I	T	G	D	x	-	-	-	(Toggle)	It input-switches by the toggle. (It is the same as an input change key)
	TV	I	T	V	D	0	-	-	-		It input-switches to TV. (A channel remains as it is. (Last memory))

*1 Select "Initial Setup" from the menu screen and set "Quick Start Mode" to "On" to enable the Power On command.

NOTE

- If an underbar (_) appears in the parameter column, enter a space.
- If an asterisk (*) appears, enter a value in the range indicated in brackets under CONTROL CONTENTS.
- Any numerical value can replace the "x" on the table.

Using a PC

Control of the TV (Continue)

CONTROL ITEM		COMMAND				PARAMETER				CONTROL CONTENTS	
INPUT SELECTION	1-6	I	A	V	D	*	-	-	-	1: HDMI IN 1, 2: HDMI IN 2, 3: HDMI IN 3, 4: VIDEO IN 1, 5: COMPONENT/VIDEO IN 2, 6: PC IN	
AV MODE SELECTION		A	V	M	D	*	-	-	-	0: (Toggle), 1: STANDARD (ENERGY STAR), 2: MOVIE, 4: USER, 5: DYNAMIC (Fixed), 6: DYNAMIC, 7: PC	Although it can choose now, it is toggle operation in inside.
VOLUME		V	O	L	M	*	*	*	-	Volume (0-100)	
POSITION	H-POSITION	H	P	O	S	*	*	*	-	(-50-50)	For PC input. The screen position variable ranges depend on the View Mode or the signal type. The ranges can be seen on the position-setting screen.
	V-POSITION	V	P	O	S	*	*	*	-	(-50-50)	
	CLOCK	C	L	C	K	*	*	*	-	(0-100)	
	PHASE	P	H	S	E	*	*	-	-	(0-63)	

CONTROL ITEM	COMMAND				PARAMETER				CONTROL CONTENTS	
VIEW MODE	W	I	D	E	*	*	-	-	0: (Toggle) [AV], 1: Side Bar [AV], 2: S.Stretch [AV], 3: Zoom [AV], 4: Stretch [AV, USB-Video, Home Network Video or Internet applications], 5: Normal [PC], 7: Stretch [PC], 8: Dot by Dot [PC] [AV], 9: Full Screen [AV], 10: Auto [USB-Video, USB-Photo, Home Network Video, Photo or Internet applications], 11: Original [USB-Video, USB-Photo, Home Network Video, Photo or Internet applications]	0: Although it can choose now, it is toggle operation in inside. 1: Only available when 4:3 signal is being input. 5: Only available when 4:3 signal is being input. 8: [PC] Available except when UXGA is being input. [AV] Only available when 1080i/p is being input. 9: Only available when 720p is being input. 10, 11: Available when USB-Video, USB-Photo, Home Network Video, Photo or Internet application is used.
MUTE	M	U	T	E	*	-	-	-	0: (Toggle), 1: On, 2: Off	

NOTE

- If an underbar (_) appears in the parameter column, enter a space.
- If an asterisk (*) appears, enter a value in the range indicated in brackets under CONTROL CONTENTS.
- Any numerical value can replace the "x" on the table.

Using a PC

Control of the TV (Continue)

CONTROL ITEM	COMMAND				PARAMETER				CONTROL CONTENTS
SURROUND	A	C	S	U	*	_	_	_	0: (Toggle), 1: On, 2: Off
AUDIO SELECTION	A	C	H	A	x	_	_	_	(Toggle)
SLEEP TIMER	O	F	T	M	*	_	_	_	0: Off, 1: OFF TIMER - 30 MIN., 2: OFF TIMER - 60 MIN., 3: OFF TIMER - 90 MIN., 4: OFF TIMER - 120 MIN.

CONTROL ITEM		COMMAND			PARAMETER				CONTROL CONTENTS		
CHANNEL	DIRECT CHANNEL (ANALOG)	D	C	C	H	*	*	*	_	The channel number of TV (1-135)	An input change is included if it is not TV display. In Air, 2-69ch is effective. In Cable, 1-135ch is effective.
	DIRECT CHANNEL (DIGITAL)	D	A	2	P	*	*	*	*	(0100-9999)	DIGITAL Air (Two-Part numbers, 2-digit plus 2-digit)
		D	C	2	U	*	*	*	_	(1-999)	DIGITAL Cable (Two-Part numbers, 3-digit plus 3-digit) Front half of DIGITAL CABLE CHANNEL NO. (Designate major channel)
		D	C	2	L	*	*	*	_	(0-999)	DIGITAL Cable (Two-Part numbers, 3-digit plus 3-digit) Rear half of DIGITAL CABLE CHANNEL NO. (Designate minor channel)

NOTE

- If an underbar (_) appears in the parameter column, enter a space.
- If an asterisk (*) appears, enter a value in the range indicated in brackets under CONTROL CONTENTS.
- Any numerical value can replace the "x" on the table.

Using a PC

Control of the TV (Continue)

CONTROL ITEM		COMMAND				PARAMETER				CONTROL CONTENTS	
CHANNEL	DIRECT CHANNEL (DIGITAL)	D	C	1	0	*	*	*	*	(0-9999)	DIGITAL Cable (One-Part numbers, 5-digit, less than 10,000)
		D	C	1	1	*	*	*	*	(0-6383)	DIGITAL Cable (One-Part numbers, 5-digit, more than 10,000)
	CH UP	C	H	U	P	x	-	-	-	The channel number of TV +1	If it is not TV display, it will input-switch to TV. (same function as CH \wedge)
	CH DOWN	C	H	D	W	x	-	-	-	The channel number of TV -1	If it is not TV display, it will input-switch to TV. (same function as CH \vee)
CC	C	L	C	P	x	-	-	-	(Toggle)	Toggle operation of a closed caption.	
DEVICE NAME	T	V	N	M	1	-	-	-		The device name set in "TV Name Setting" is displayed.	
MODEL NAME	M	N	R	D	1	-	-	-		The model name of the TV	













CONTROL ITEM	COMMAND				PARAMETER				CONTROL CONTENTS	
SOFTWARE VERSION	S	W	V	N	1	-	-	-		The current version of the TV software is displayed.
IP PROTOCOL VERSION	I	P	P	V	1	-	-	-		The currently supported version of IP protocol is displayed.

NOTE

- If an underbar (_) appears in the parameter column, enter a space.
- If an asterisk (*) appears, enter a value in the range indicated in brackets under CONTROL CONTENTS.
- Any numerical value can replace the "x" on the table.

Using a PC

Control of the TV (Continue)

CONTROL ITEM	COMMAND				PARAMETER				CONTROL CONTENTS
REMOTE CONTROL BUTTONS	R	C	K	Y	*	*	-	-	0-9: 0-9, 10: DOT, 11: ENT, 12: POWER, 13: DISPLAY, 14: POWER (SOURCE) 15:  , 16:  , 17:  , 18:  , 19:  , 20:  , 21:  , 23: OPTION, 24: SLEEP, 27: CC, 28: AV MODE, 29: VIEW MODE, 30: FLASHBACK, 31: MUTE, 32: VOL -, 33: VOL +, 34: CH  , 35: CH  , 36: INPUT, 38: MENU, 39: SmartCentral, 40: ENTER, 41:  , 42:  , 43:  , 44:  , 45: RETURN, 46: EXIT, 47: FAV CH, 49: AUDIO, 50: A (red), 51: B (green), 52: C (blue), 53: D (yellow), 54: FREEZE, 55: FAV APP 1, 56: FAV APP 2, 57: FAV APP 3, 59: NETFLIX, 60: AAL, 61: MANUAL

NOTE

- If an underbar (_) appears in the parameter column, enter a space.
- If an asterisk (*) appears, enter a value in the range indicated in brackets under CONTROL CONTENTS.
- Any numerical value can replace the "x" on the table.

Using a PC

PC Compatibility Chart

It is necessary to set the PC correctly to display XGA and WXGA signal.

Resolution		Horizontal Frequency	Vertical Frequency	VESA Standard
VGA	720 x 400	31.5 kHz	70 Hz	—
	640 x 480	31.5 kHz	60 Hz	○
		37.9 kHz	72 Hz	○
SVGA	800 x 600	37.5 kHz	75 Hz	○
		35.1 kHz	56 Hz	○
		37.9 kHz	60 Hz	○
		48.1 kHz	72 Hz	○
XGA	1024 x 768	46.9 kHz	75 Hz	○
		48.4 kHz	60 Hz	○
		56.5 kHz	70 Hz	○
WXGA	1360 x 768	60.0 kHz	75 Hz	○
		47.7 kHz	60 Hz	○
SXGA	1280 x 1024	64.0 kHz	60 Hz	○
SXGA+	1400 x 1050	65.3 kHz	60 Hz	○
UXGA	1600 x 1200	75.0 kHz	60 Hz	○
1080p	1920 x 1080	67.5 kHz	60 Hz	—

VGA and XGA are registered trademarks of International Business Machines Corp.

Using the Internet

By connecting your TV to a broadband system, you can access the Internet from the TV.

- You can enjoy a variety of streaming content and Internet applications.
(See pages 8-12 to 8-13.)

Connecting to the Internet

- To connect your TV to the Internet, you must have a broadband Internet connection.
- If you do not have a broadband Internet connection, consult the store where you purchased your TV or ask your Internet service provider or telephone company.
- When an Internet connection is made, an Ethernet and wireless connection cannot be used at the same time. Use only one of the connection types.

Using an ETHERNET cable

Use an ETHERNET cable (commercially available) to connect the ETHERNET terminal on the TV to your broadband router (commercially available).

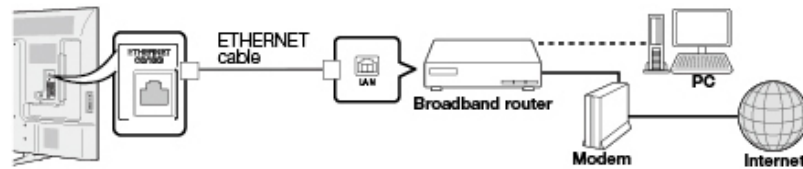

Using the wireless LAN

This TV is equipped with a wireless LAN function.

For a wireless LAN connection, you must use "Wireless Setup" to connect the access point and TV.



NOTE

- This TV has a built-in wireless LAN function. Using a separate wireless USB LAN adapter may result in radio communications that do not comply with regulations on radio communications. Therefore, do not use a separate wireless LAN adapter.
- A wireless LAN connection and performance cannot be guaranteed for all residential environments. In the following cases, the wireless LAN signal may be poor or drop, or the connection speed may become slower.
 - When used in buildings made with concrete, reinforced steel, or metal
 - When placed near objects that obstruct the signal
 - When used with other wireless devices that emit the same frequency
 - When used in the vicinity of microwave ovens and other devices that emit a magnetic field, electrostatic charge, or electromagnetic interference



Internet Setup

Perform the procedure below to make adjustments or to confirm the settings for accessing the Internet.

- 1 Press **MENU** to display the MENU screen, and then press **ENTER**.
- 2 Press **Left Arrow** to select "Smart TV", and then press **ENTER**.
- 3 Press **Up Arrow** to select "Internet Setup", and then press **ENTER**.
- 4 Press **Up Arrow** to select "Connection Type", "Wired Setup" or "Wireless Setup", and then press **ENTER**.
 - Select "Wired Setup" or "Wireless Setup" when you make general adjustments to connect to the Internet.
- 5 Press **Up Arrow** to select a specific item, and then press **ENTER**.
- 6 Press **Up Arrow** (or **Left Arrow**) to select the desired setting, and then press **ENTER**.
- 7 Press **MENU** to exit.

Connection Type

Select the connection type.

Wired: The signal is detected and setup is performed automatically. Use "Wired Setup" to check and change the settings as necessary.

Wireless: Configure the access point settings on "Wireless Setup".



Internet Setup (Continue)

Wireless Setup

Make adjustments and confirm the settings necessary for wireless LAN connection (such as search for the access point and registration of it).

WPS

WPS push button: Allows the TV to automatically establish the connection using a button on the access point.

WPS PIN code: Sets up the connection by registering a PIN code for the access point.

Search: Searches for and selects the access point to be connected.

Manual Setup: Allows you to make the connection by entering an SSID for the access point.

If your access point supports Wi-Fi Protected Setup (WPS push button method), it is recommended that you use this function for the wireless connection. You can press the WPS button on the access point to configure the settings automatically.

- The name of the WPS button function may differ depending on the access point. See the operation manual of the access point for details.

1 Confirm the current settings in "Connection Type".

- If "Wired" is selected, press **▲/▼** to select "Wireless".

2 Select the desired connection method and follow the instructions shown on the display.

3 When a connection is established, the connection details are displayed. Press **ENTER**.

NOTE

- Operations cannot be guaranteed when used with access points that do not have Wi-Fi® certification.
- A wireless LAN router/access point is required to connect the TV to the Internet using a wireless LAN. See the operation manual of your access point for setup.
- If your access point is set to a stealth mode (that prevents detection by other devices), you may not be able to establish a connection. In this case, disable the stealth mode on the access point.
- A stable connection speed is required to play back streaming content. Use an Ethernet connection if the wireless LAN speed is unstable.
- Before transferring to a third party or disposal, be sure to initialize the wireless LAN settings.
- Please follow the legislation in your country when using the wireless LAN outdoors.



Internet Setup (Continue)

Wired Setup

You can make adjustments manually for the IP.

- You can switch the "Connect Type" to "AUTO" or "Manual".
- Check that numbers are displayed for each setting.
- If there are any settings without numbers, specify the numbers by following the on-screen instructions.
- Input the IP address etc by using remote control buttons 0-9.





Entering Text (Software Keyboard)

When you are editing an input screen or specifying the Network settings used for accessing the Internet, enter text from the software keyboard.

NOTE

- You can enter up to 128 characters for text.
- Some special characters or diacritics may not be available depending on where you enter the text.

The text you enter is displayed as you type it in.

To move the cursor (the current input position), use "" or "" on the software keyboard.



While you are entering text, likely input conversion candidates are displayed based on what you typed in.

CapsLock

If "alphabet" is selected, this switches characters between uppercase and lowercase.
Each time you press **ENTER**, the character type switches.

Symbol

Press **ENTER** to select the type of characters entered: alphabet, or sign.

BackSpace/Delete

Erases text one character at a time.



Entering Text (Software Keyboard) (Continue)

Enter

Applies the entered information and closes the software keyboard.

Space

Enters a space.

Clear

Erases the character string.

- When the cursor is somewhere in a line: the character string to the right of the cursor will be erased.
- When the cursor is at the right end of a line: the entire line will be erased.

Close

Closes the software keyboard without applying the entered information.

Buttons on the remote control unit	Description
	Moves the focus. When moved at the far edge, the focus moves to the opposite edge.
ENTER	Performs the processing for the button currently in the focus.
EXIT	Closes the software keyboard without applying the original input elements for the entered text.
RETURN	
0-9	Directly enters the single-byte number for that button.



Using the Browser

1 Press **SmartCentral**, press  to select the browser icon from the application window, and then press **ENTER**.

- Press **SmartCentral** again to switch back to the currently tuned channel.

Buttons for Using the Browser

ENTER, 

- Press  to select a link that you want to jump, and then press **ENTER**.

EXIT

- Press the button to return to the TV screen.

RETURN

- Press the button to return to the previous page.

NOTE

- Restrictions apply to window display.



Using the Browser (Continue)



Selected item	Description
	Allows you to go back to the previous page.
	Allows you to go to the next page.
	Refreshes the page. Interrupts a page while it is loading.
	Displays the home page.

Selected item	Description
	Displays the bookmarks list.
	Displays your browsing history.
	Configures browser settings.

Using the Toolbar

You can use the toolbar to control the browser and to specify settings.

- 1 Press to select a function, and then press **ENTER**.

Browsing Web Contents

You can display the web content you want to enjoy.

- 1 Press to move to the address area in the toolbar, and then press **ENTER**.
 - The Enter Address menu is displayed.
- 2 Enter an address, and then press **ENTER**.
 - The web content you want to view is displayed.



Using the Browser (Continue)

CAUTION

- If the power is cut due to a power failure or the TV being unplugged while you are using the Internet, information such as bookmarks or cookies may not be saved correctly.

To users who access the Internet from a PC

- When you access the Internet from this TV, the procedures may not be the same as regular browser-based access on a PC.
- On some pages, video and audio, text or images may not be displayed correctly.

About links

- Web pages on the Internet often include "links" that allow you to jump to other web pages (or sites).
- "Links" can take various forms, including words or images, but they always work in the same way letting you jump to the link destination when you select them.
- Selected items (such as links of text input fields) are enclosed in a frame.
- You can jump from a "link" to the corresponding link destination.

DISCLAIMERS





SHARP corporation bears no responsibility regarding the content and quality of the content provided by the content serve provider.



Using the Browser (Continue)

Browser Settings

You can check or modify your browser settings from the Browser menu.

- 1 Press  to select "  " in the toolbar, and then press **ENTER**.
- 2 Press    to specify the required setting, and then press **ENTER**.



Using Keyboard and Mouse

You can use a keyboard or mouse for operating the TV while using the browser.

- When you use the USB devices, connect the device to the USB terminal on the TV.

NOTE

- The keyboard and mouse can only be used on a browser screen.

The keyboard or mouse may not operate properly depending on the application being used.



Using Applications via the Internet

By connecting the TV to the Internet, you can enjoy a variety of broadband content, including videos, music and photos.



Please check that the most current software is loaded on TV by selecting "Auto Update Setting" on "Software Update" (see page 4-14) or by visiting <http://www.sharpusa.com/products/support/> to check for a download of the newest software version.

Use the application window to access your favorite Internet applications. Press **SmartCentral** to display the application window.

Follow the on-screen instructions for each application.

- When using this TV to access an Internet application for the first time, the Disclaimer appears on the screen. Press **▲▼** to select "Agree", and then press **ENTER**. (You must select "Agree" to use the application.)
- Check the web site of the provider for details on setup and use of the functions.

NOTE

- If  or  is displayed, check your TV's network settings and connection.
- Additional applications will be available in the future.
- These applications are provided by content providers. The available applications vary depending on your country or region.
- The delivery speed of applications varies depending on the network speed. Check the web site of the provider for details on application setup and other information.

Using the Application Window

During Dock Display

You can move the application icons.

Example

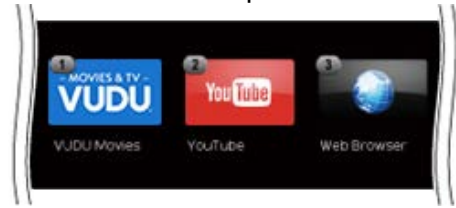

- 1 Select an application, and then press **▲**.
- 2 Press **◀▶** to move the icon to the desired location.

Move the Icons

You can move the icons of the more commonly used applications closer to the left.

Press **◀▶** to move the icon to the desired location.

Saving Favorite Applications

You can set your favorite applications to the **FAV APP1**, **2**, and **3** buttons on the remote control for easier startup.

The applications whose icons are moved onto **1**, **2** and **3** during Dock Display will be assigned to the **FAV APP 1**, **2** and **3** buttons respectively.



Using Applications via the Internet (Continue)

Deactivating Netflix Function

You can deactivate the Netflix function. Refer to "Smart TV" > "Advanced" > "Netflix Help" and select "Deactivate".

- To confirm the Netflix status, check the information displayed on the screen and click "OK".

Deactivating the VUDU Function

To deactivate the VUDU function, refer to "Smart TV" > "Advanced" > "VUDU Help" and select "Yes". When you access the Internet application for the first time, the following appears.

- This message is available only in English.

AQUOS Advantage Live

When you select this app on the SmartCentral screen, you can use the remote support function from the support center and display the network status.

DISCLAIMERS

- This SHARP device facilitates the access to content and services provided by third parties. The content and services accessible via this device belong to and may be proprietary to third parties. Therefore, any use of such third party content and services must be in accordance with any authorization or terms of use provided by such content or service provider. SHARP shall not be liable to you or any third party for your failure to abide by such authorization or terms of use. Unless otherwise specifically authorized by the applicable content or service provider, all third party content and services provided are for personal and non-commercial use; you may not modify, copy, distribute, transmit, display, perform, reproduce, upload, publish, license, create derivative works from, transfer or sell in any manner or medium any content or services available via this device.
- SHARP is not responsible, nor liable, for customer service-related issues related to the third party content or services. Any questions, comments or service-related inquiries relating to the third party content or service should be made directly to the applicable content or service provider.
You may not be able to access content or services from the device for a variety of reasons which may be unrelated to the device itself, including, but not limited to, power failure, other Internet connection, or failure to configure your device properly. SHARP, its directors, officers, employees, agents, contractors and affiliates shall not be liable to you or any third party with respect to such failures or maintenance outages, regardless of cause or whether or not it could have been avoided.
- ALL THIRD PARTY CONTENT OR SERVICES ACCESSIBLE VIA THIS DEVICE IS PROVIDED TO YOU ON AN "AS-IS" AND "AS AVAILABLE" BASIS AND SHARP AND ITS AFFILIATES MAKE NO WARRANTY OR REPRESENTATION OF ANY KIND TO YOU, EITHER EXPRESS OR IMPLIED, INCLUDING, WITHOUT LIMITATION, ANY WARRANTIES OF MERCHANTABILITY, NON-INFRINGEMENT, FITNESS FOR A PARTICULAR PURPOSE OR ANY WARRANTIES OF SUITABILITY, AVAILABILITY, ACCURACY, COMPLETENESS, SECURITY, TITLE, USEFULNESS, LACK OF NEGLIGENCE OR ERROR-FREE OR UNINTERRUPTED OPERATION OR USE OF THE CONTENT OR SERVICES PROVIDED TO YOU OR THAT THE CONTENT OR SERVICES WILL MEET YOUR REQUIREMENTS OR EXPECTATIONS.
- SHARP IS NOT AN AGENT OF AND ASSUMES NO RESPONSIBILITY FOR THE ACTS OR OMISSIONS OF THIRD PARTY CONTENT OR SERVICE PROVIDERS, NOR ANY ASPECT OF THE CONTENT OR SERVICE RELATED TO SUCH THIRD PARTY PROVIDERS.
- IN NO EVENT WILL SHARP AND/OR ITS AFFILIATES BE LIABLE TO YOU OR ANY THIRD PARTY FOR ANY DIRECT, INDIRECT, SPECIAL, INCIDENTAL, PUNITIVE, CONSEQUENTIAL OR OTHER DAMAGES, WHETHER THE THEORY OF LIABILITY IS BASED ON CONTRACT, TORT, NEGLIGENCE, BREACH OF WARRANTY, STRICT LIABILITY OR OTHERWISE AND WHETHER OR NOT SHARP AND/OR ITS AFFILIATES HAVE BEEN ADVISED OF THE POSSIBILITY OF SUCH DAMAGES.

Examples of Application Logos





Miracast devices

When you connect a device such as a Miracast-compatible smartphone or tablet to this TV, you can enjoy video and audio from the device on the TV's large screen and speakers.

- 1 Select the "Smart TV" > "Miracast".
- 2 Enable the Miracast function on the Miracast device and connect to the TV.
(The TV screen changes according to the behavior of the device)

NOTE

- When the TV is turned off or the connection is ended on the device, you must connect the device again.
- For details about the operation of the Miracast-compatible device, check the manual for that device.
- When the Miracast device is connected to the TV over a wireless LAN, Miracast video may be distorted and Miracast audio may be interrupted depending on the status of the TV's connection to the access point.

Removing the Stand

- Before detaching (or attaching) the stand, make sure to turn off the TV and unplug the AC cord.

CAUTION

- Do not remove the stand from the TV unless using an optional wall mount bracket to mount it.

- 1 Unfasten the four screws used to secure the stand in place.

Example

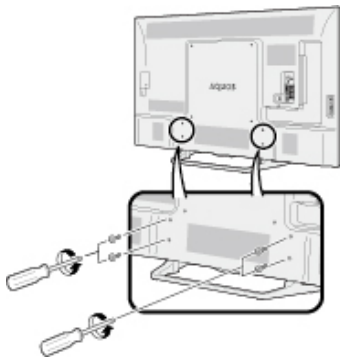

- 2 Detach the stand from the TV.

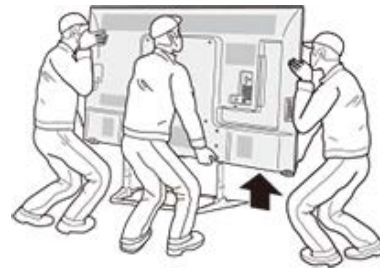

NOTE

- Be sure to always carry the TV by two people (80 inch models: three people) holding it with two hands.
- In the installation procedure, be careful not to catch your fingers between the TV set and the floor.

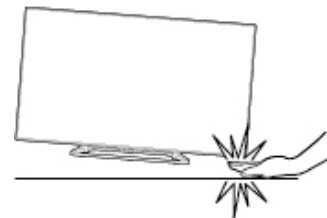

Setting the TV on the Wall

Using an optional bracket to mount the TV

- You can ask a qualified service professional about using an optional AN-52AG4 bracket to mount the TV on the wall.
- Carefully read the instructions that come with the bracket before beginning work.

CAUTION

- This TV should be mounted on the wall only with the wall mount bracket AN-52AG4 (SHARP). The use of other wall mount brackets may result in an unstable installation and may cause serious injuries.
- Installing the TV requires special skill that should only be performed by qualified service personnel. Customers should not attempt to do the work themselves. SHARP bears no responsibility for improper mounting or mounting that results in accident or injury.

The wall mount kit (sold separately) allows you to mount the TV on the wall. For detailed information on installing the wall mount, see the instructions provided with the product. We recommend you to contact a technician for assistance when installing it. SHARP is not responsible for any damage to the product or injury to yourself or others if you elect to install the wall mount on your own.

CAUTION

- Install your wall mount on a solid wall perpendicular to the floor. When you want to attach the wall mount to surfaces other than plaster board, please contact your nearest retailer/adviser for additional information. If you install the TV on a ceiling or slanted wall, it may fall and result in severe personal injury. Always have two people mount the TV on a wall.

NOTE

- Due to the terminal configuration on this TV, when you wall-mount this model, make sure there is enough space between the wall and the TV for the cables.
- To use this TV mounted on a wall, remove the AC cord holder on the rear of the TV, and then use the screws supplied with the wall mount bracket to secure the bracket to the rear of the TV.

Hanging on the wall

AN-52AG4 wall mount bracket.
(See the bracket instructions for details.)

Hanging on the wall

AN-52AG4

LC-70LE660U/LC-70LE661U/
LC-70C6600U/LC-70EQ30U

- The center of the display:
3/32 inch (2mm) above the "c" position.

LC-60LE660U/LC-60LE661U/
LC-60C6600U/LC-60EQ30U

- The center of the display:
31/64 inch (12mm) above the "c" position.

- Refer to the operation manual of AN-52AG4 for details.

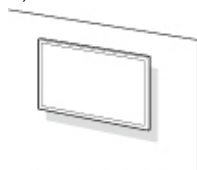

Vertical mounting

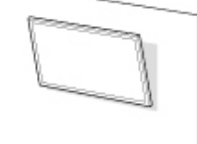

Angular mounting

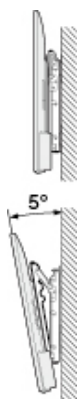

Setting the TV on the Wall(Continue)

LC-80LE661U

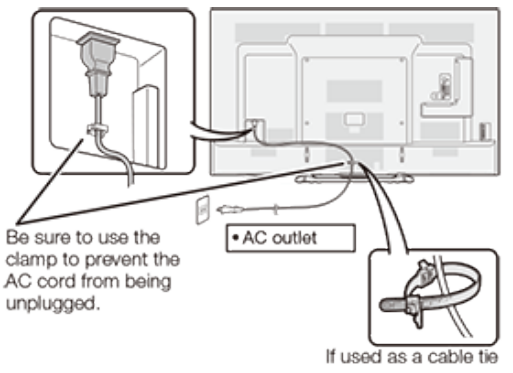

LC-70LE660U/LC-60LE660U/LC-70LE661U/LC-60LE661U/
LC-70C6600U/LC-60C6600U/LC-70EQ30U/LC-60EQ30U

Attached location at shipment (A)

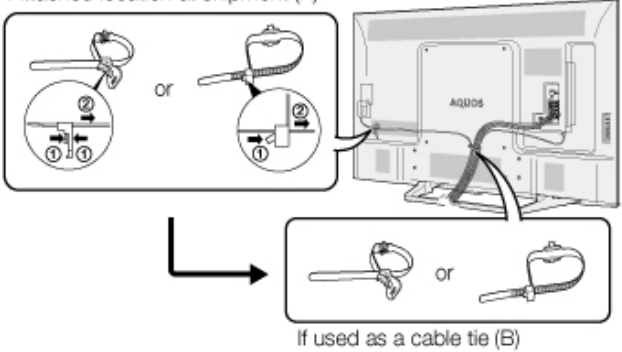

- The location of the AC cord holder differs depending on whether it is in its shipment location (A) or has been used as a cable tie (B).

Setting the TV on the Wall(Continue)

Wall Mount Kit Specifications

Standard dimensions for wall mount kits are shown below.

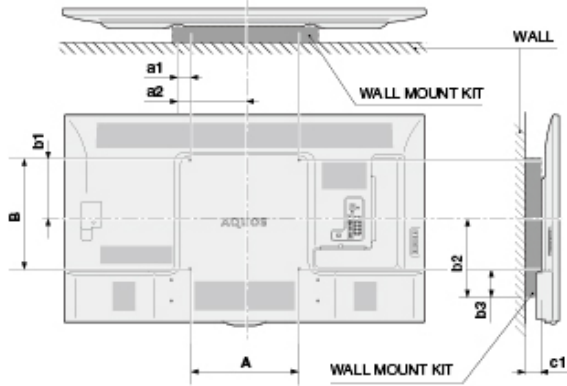

- a1: Maximum distance from the mounting hole
- a2: Maximum distance from the TV's center
- b1: Distance between the TV's center and the mounting hole
- b2: Maximum distance from the TV's center
- b3: Maximum distance from the mounting hole
- c1: Minimum gap

		LC-80LE661U	LC-70LE660U/LC-70LE661U/ LC-70C6600U/LC-70EQ30U	LC-60LE660U/LC-60LE661U/ LC-60C6600U/LC-60EQ30U
VESA screw hole specs (A-B)		23 5/8(600) - 15 3/4(400)	15 3/4(400) - 15 3/4(400)	
Width	a1	1 5/8(41)	2 3/8(60)	
	a2	13 7/16(341)	10 1/4(260)	
Height	b1	8 9/32(210)	8 43/64(220)	
	b2	11 47/64(298)	10 29/32(277)	10 33/64(267)
	b3	4 7/32(107)	3 7/16(87)	
c1	3 13/64(81)	1 15/16(49)	1 31/32(50)	

Appendix

Setting the TV on the Wall(Continue)

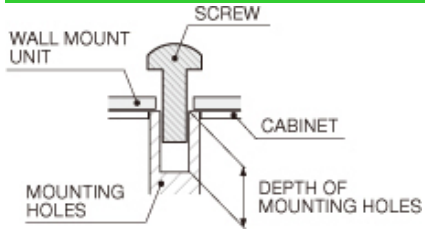

For the screws, refer to the table shown below.

	80 inch models	70/60 inch models
Standard screws	M8 (Use 1.25 pitch screws.)	M6 (Use 1.0 pitch screws.)
Length(Depth of mounting holes)	15/32(12)	15/32 (12)
Quantity	4 pcs.	4 pcs.

NOTE

- To use this TV mounted on a wall, remove the cable tie as needed.
- Do not use screws that do not comply with the VESA standard screw specifications.
- Do not use screws that are longer than the standard length. Screws that are too long may cause damage to the inside of the TV.
- Do not fasten the screws too firmly or loosely. This may damage the product or cause the product to fall, leading to personal injury. SHARP is not liable for these kinds of accidents.
- SHARP is not liable for product damage or personal injury when a non-VESA or non-specified wall mount is used or the consumer fails to follow the product installation instructions.



Do not install the wall mount kit while your TV is turned on. It may result in personal injury due to electric shock.

Appendix

Troubleshooting

Problem	Possible Solution
<ul style="list-style-type: none"> No power 	<ul style="list-style-type: none"> Check if you pressed POWER on the remote control unit. Is the AC cord disconnected? Has the power been turned on?
<ul style="list-style-type: none"> Unit cannot be operated. 	<ul style="list-style-type: none"> External influences such as lightning, static electricity, may cause improper operation. In this case, operate the unit after first turning off the power of the TV or unplugging the AC cord and replugging it in after 1 or 2 minutes.
<ul style="list-style-type: none"> Remote control unit does not operate. 	<ul style="list-style-type: none"> Is the equipment to be operated by the remote control unit set correctly? Press TV to set the remote control unit to the setting for operating the TV. Are batteries inserted with polarity (+, -) aligned? Are batteries worn out? (Replace with new batteries.) Are you using it under strong or fluorescent lighting? Is a fluorescent light illuminated near the remote control sensor?
<ul style="list-style-type: none"> Picture is cut off/with sidebar screen. 	<ul style="list-style-type: none"> Is the image position correct? Page 7-1 Are screen mode adjustments such as picture size made correctly? Pages 3-14 to 3-16
<ul style="list-style-type: none"> Strange color, light color, or color misalignment 	<ul style="list-style-type: none"> Adjust the picture tone. Pages 4-17 to 4-20 Is the room too bright? The picture may look dark in a room that is too bright.
<ul style="list-style-type: none"> Power is suddenly turned off. 	<ul style="list-style-type: none"> Is the sleep timer set? Pages 3-9 Check the power control settings. Page 4-25 The unit's internal temperature has increased. Remove any objects blocking vent or clean.

Problem	Possible Solution
<ul style="list-style-type: none"> No picture 	<ul style="list-style-type: none"> Is connection to other components correct? Is the correct input selected? Pages 2-1 Is "On" selected in "Audio Only"? Page 4-25 If the PC image is not displayed, check the following: <ul style="list-style-type: none"> When connecting a laptop PC to the TV, check that display output mode of the PC is set to external monitor. Check the resolution setting on the PC. Is a non-compatible signal being input? Page 7-9
<ul style="list-style-type: none"> Picture quality of HD programs is poor. 	<ul style="list-style-type: none"> To enjoy HD images from external equipment, you are required to set up HDMI connection or component connection. If the program content is not of HD quality, HD images cannot be displayed. Check that the program you are viewing provides HD images. The HD cable/satellite set-top box may need to be configured to output HD images via cable/satellite. The cable/satellite broadcast may not support a signal resolution of 1080p.
<ul style="list-style-type: none"> The TV sometimes makes a cracking sound. 	<ul style="list-style-type: none"> This is not a malfunction. This happens when the cabinet slightly expands and contracts according to change in temperature. This does not affect the TV's performance.
<ul style="list-style-type: none"> Some Internet functions used on a PC are not available from the TV. 	<ul style="list-style-type: none"> The TV has only limited functions compared with regular PC browsers. Pages 8-7 to 8-9

Troubleshooting (Continue)

Problem	Possible Solution
<ul style="list-style-type: none"> No sound 	<ul style="list-style-type: none"> Is connection to other components correct? Is the volume too low? Page 3-2 Is "Variable" selected in "Output Select"? Page 4-12 Have you pressed MUTE on the remote control unit? Page 3-3 Check the audio output of the connected external equipment. Is the volume too low or muted? When external equipment is connected via an HDMI cable, you may need to configure the audio to be output through the HDMI cable. When audio is not output from external equipment connected to the PC IN or HDMI IN 2 terminal, check the "Audio Select" setting. Page 7-2 Even when external equipment is connected using an HDMI-certified cable, an audio cable connection may be required depending on the type of equipment and the media being played back. In this case, in addition to connecting an HDMI-certified cable to the HDMI IN 2 terminal, connect a Ø 3.5 mm stereo minijack cable to the AUDIO IN terminal and set "Audio Select" to "HDMI+Analog". Page 7-2 When connecting a PC via an HDMI-certified cable, check the following: <ul style="list-style-type: none"> Is the audio output of the PC configured correctly? Check the audio output settings and output audio format in Sound Properties on the PC. The audio formats compatible with this TV are PCM and Dolby Digital. With other formats, audio cannot be output. Depending on the board, only video signals may be output. In this case, in addition to connecting an HDMI-certified cable to the HDMI IN 2 terminal, connect a Ø 3.5 mm stereo minijack cable to the AUDIO IN terminal and set "Audio Select" to "HDMI+Analog". Page 7-2

Problem	Possible Solution
<ul style="list-style-type: none"> Miracast image/audio cannot be output to the TV. 	<ul style="list-style-type: none"> Check pairing.

Cautions regarding use in high and low temperature environments

- When the unit is used in a low temperature space (e.g. room, office), the picture may leave trails or appear slightly delayed. This is not a malfunction, and the unit will recover when the temperature returns to normal.
- Do not leave the unit in a hot or cold location. Also, do not leave the unit in a location exposed to direct sunlight or near a heater, as this may cause the cabinet to deform and the front panel to malfunction.
Storage temperature: -4°F to +140°F (-20°C to +60°C)

Specifications

TV(For LE660U and C6600U models)

Item		Model: LC-70LE660U/LC-70C6600U	Model: LC-60LE660U/LC-60C6600U	
LCD panel	Size	70" Class (69 1/2" Diagonal)	60" Class (60 3/32" Diagonal)	
	Resolution	2,073,600 pixels (1,920 x 1,080)		
TV Function	TV-standard (CCIR)	American TV Standard ATSC/NTSC System		
	Receiving Channel	VHF/UHF	VHF 2-13ch, UHF 14-69ch	
		CATV	1-135ch (non-scrambled channel only)	
		Digital Terrestrial Broadcast (8VSB)	2-69ch	
		Digital cable*1 (64/256 QAM)	1-135ch (non-scrambled channel only)	
Audio multiplex	BTSC System			
Audio out	10W x 2			
Terminals	Back panel vertical side	HDMI IN 3	HDMI in with HDCP, MHL	
		USB	Photo/Music/Video mode, Software update, USB keyboard/mouse, Wallpaper Picture	
		HDMI IN 1	HDMI in with HDCP, ARC	
		HDMI IN 2	HDMI in with HDCP, Audio in (Ø 3.5 mm stereo jack)	
		COMPONENT/VIDEO IN	COMPONENT in, AV in	
		VIDEO IN 1	AV in	
	Back panel surface side	PC IN	ANALOG RGB (PC) in (15-pin mini D-sub female connector), Audio in (Ø 3.5 mm stereo jack)	
		ANT/CABLE	75 Ω Unbalance, F Type x 1 for Analog (VHF/UHF/CATV) and Digital (AIR/CABLE)	
		AUDIO IN	Audio in (Ø 3.5 mm stereo jack)	
		AUDIO OUT	Audio out (RCA)	
		DIGITAL AUDIO OUT	Optical Digital audio out x 1 (PCM/Dolby Digital/DTS)	
		ETHERNET	Network connector	
OSD language	English/French/Spanish			
Power Requirement	AC 120 V, 60 Hz			
On Mode Power	88 W	72 W		
Power Consumption	180 W (0.5 W Standby with AC 120 V)	150 W (0.5 W Standby with AC 120 V)		
Weight	TV + stand	78.3 lbs./35.5 kg	56.2 lbs./25.5 kg	
	TV only	75.0 lbs./34.0 kg	52.9 lbs./24.0 kg	
Dimensions*2 (W x H x D)(inch)	TV + stand	61 35/64 x 37 1/16 x 13 3/4	53 23/64 x 32 31/64 x 13 3/4	
	TV only	61 35/64 x 35 53/64 x 3 7/16	53 23/64 x 31 3/16 x 3 25/64	
Operating temperature	+32°F to +104°F (0°C to +40°C)			

*1 Emergency alert messages via Cable are unreceivable.

- As part of policy of continuous improvement, SHARP reserves the right to make design and specification changes for product improvement without prior notice. The performance specification figures indicated are nominal values of production units. There may be some deviations from these values in individual units.
- On Mode Power Consumption is measured according to Energy Star program requirements for televisions.

Specifications

TV(For LE661U model)

Item		Model: LC-80LE661U	Model: LC-70LE661U	Model: LC-60LE661U
LCD panel	Size	80" Class (80" Diagonal)	70" Class (69 1/2" Diagonal)	60" Class (60 3/32" Diagonal)
	Resolution	2,073,600 pixels (1,920 x 1,080)		
TV Function	TV-standard (CCIR)	American TV Standard ATSC/NTSC System		
	Receiving Channel	VHF/UHF	VHF 2-13ch, UHF 14-69ch	
		CATV	1-135ch (non-scrambled channel only)	
		Digital Terrestrial Broadcast (8VSB)	2-69ch	
Audio multiplex	Digital cable*1 (64/256 QAM)	1-135ch (non-scrambled channel only)		
Audio out		BTSC System 10W x 2		
Terminals	Back panel vertical side	HDMI IN 3	HDMI in with HDCP, MHL	
		USB	Photo/Music/Video mode, Software update, USB keyboard/mouse, Wallpaper Picture	
		RS-232C	9-pin D-sub male connector.	
	Back panel surface side	HDMI IN 1	HDMI in with HDCP, ARC	
		HDMI IN 2	HDMI in with HDCP, Audio in (Ø 3.5 mm stereo jack)	
		COMPONENT/VIDEO IN	COMPONENT in, AV in	
		VIDEO IN 1	AV in	
		PC IN	ANALOG RGB (PC) in (15-pin mini D-sub female connector), Audio in (Ø 3.5 mm stereo jack)	
		ANT/CABLE	75 Ω Unbalance, F Type x 1 for Analog (VHF/UHF/CATV) and Digital (AIR/CABLE)	
		AUDIO IN	Audio in (Ø 3.5 mm stereo jack)	
		AUDIO OUT	Audio out (RCA)	
DIGITAL AUDIO OUT	Optical Digital audio out x 1 (PCM/Dolby Digital/DTS)			
ETHERNET	Network connector			
OSD language		English/French/Spanish		
Power Requirement		AC 120 V, 60 Hz		
On Mode Power		106 W	88 W	72 W
Power Consumption		300 W (0.5 W Standby with AC 120 V)	180 W (0.5 W Standby with AC 120 V)	150 W (0.5 W Standby with AC 120 V)
Weight	TV + stand	114.6lbs./52.0kg	78.3 lbs./35.5 kg	56.2 lbs./25.5 kg
	TV only	110.2lbs./50.0kg	75.0 lbs./34.0 kg	52.9 lbs./24.0 kg
Dimensions*2 (W x H x D)(inch)	TV + stand	71 1/2 x 42 61/64 x 18 5/32	61 35/64 x 37 1/16 x 13 3/4	53 23/64 x 32 31/64 x 13 3/4
	TV only	71 1/2 x 41 35/64 x 4 1/2	61 35/64 x 35 53/64 x 3 7/16	53 23/64 x 31 3/16 x 3 25/64
Operating temperature		+32°F to +104°F (0°C to +40°C)		

*1 Emergency alert messages via Cable are unreceivable.

- As part of policy of continuous improvement, SHARP reserves the right to make design and specification changes for product improvement without prior notice. The performance specification figures indicated are nominal values of production units. There may be some deviations from these values in individual units.
- On Mode Power Consumption is measured according to Energy Star program requirements for televisions.

Specifications

TV(For EQ30U model)

Item		Model: LC-70EQ30U	Model: LC-60EQ30U
LCD panel	Size	70" Class (69 1/2" Diagonal)	60" Class (60 3/32" Diagonal)
	Resolution	2,073,600 pixels (1,920 x 1,080)	
TV Function	TV-standard (CCIR)	American TV Standard ATSC/NTSC System	
	Receiving Channel	VHF/UHF	VHF 2-13ch, UHF 14-69ch
		CATV	1-135ch (non-scrambled channel only)
		Digital Terrestrial Broadcast (8VSB)	2-69ch
	Audio multiplex	Digital cable*1 (64/256 QAM)	1-135ch (non-scrambled channel only)
Audio out	BTSC System		
		10W x 2	
Terminals	Back panel vertical side	HDMI IN 3	HDMI in with HDCP, MHL
		USB	Photo/Music/Video mode, Software update, USB keyboard/mouse, Wallpaper Picture
		RS-232C	9-pin D-sub male connector.
	Back panel surface side	HDMI IN 1	HDMI in with HDCP, ARC
		HDMI IN 2	HDMI in with HDCP, Audio in (Ø 3.5 mm stereo jack)
		COMPONENT/VIDEO IN	COMPONENT in, AV in
		VIDEO IN 1	AV in
		PC IN	ANALOG RGB (PC) in (15-pin mini D-sub female connector), Audio in (Ø 3.5 mm stereo jack)
		ANT/CABLE	75 Ω Unbalance, F Type x 1 for Analog (VHF/UHF/CATV) and Digital (AIR/CABLE)
		AUDIO IN	Audio in (Ø 3.5 mm stereo jack)
		AUDIO OUT	Audio out (RCA)
		DIGITAL AUDIO OUT	Optical Digital audio out x 1 (PCM/Dolby Digital/DTS)
		ETHERNET	Network connector
OSD language	English/French/Spanish		
Power Requirement	AC 120 V, 60 Hz		
On Mode Power	95 W	76 W	
Power Consumption	190 W (0.5 W Standby with AC 120 V)	160 W (0.5 W Standby with AC 120 V)	
Weight	TV + stand	78.3 lbs./35.5 kg	56.2 lbs./25.5 kg
	TV only	75.0 lbs./34.0 kg	52.9 lbs./24.0 kg
Dimensions*2 (W x H x D)(inch)	TV + stand	61 35/64 x 37 1/16 x 13 3/4	53 23/64 x 32 31/64 x 13 3/4
	TV only	61 35/64 x 35 53/64 x 3 7/16	53 23/64 x 31 3/16 x 3 25/64
Operating temperature	+32°F to +104°F (0°C to +40°C)		

*1 Emergency alert messages via Cable are unreceivable.

- As part of policy of continuous improvement, SHARP reserves the right to make design and specification changes for product improvement without prior notice. The performance specification figures indicated are nominal values of production units. There may be some deviations from these values in individual units.
- On Mode Power Consumption is measured according to Energy Star program requirements for televisions.

Specifications

Wireless LAN

Specification	
Standard	IEEE 802.11b/g/n
Frequency Band	2.412-2.462 GHz
Security	64-bit, 128-bit WEP, TKIP, AES, WPA, WPA2, WPS, IEEE802.11i
Modulation	DBPSK @1Mbps DQPSK @2Mbps CCK@5.5/11Mbps BPSK@6/9 Mbps QPSK@12/18Mbps 16-QAM@24Mbps 64-QAM@48/54Mbps

Trademarks

- SmartCentral is a registered trademark of Sharp Corporation.

- Manufactured under license from Dolby Laboratories. Dolby and the double-D symbol are trademarks of Dolby Laboratories.

- The terms HDMI and HDMI High-Definition Multimedia Interface, and the HDMI Logo are trademarks or registered trademarks of HDMI Licensing, LLC in the United States and other countries.

- The Wi-Fi CERTIFIED Logo is a certification mark of the Wi-Fi Alliance.
- The Wi-Fi Protected Setup Mark is a mark of the Wi-Fi Alliance.
- Wi-Fi CERTIFIED Miracast™ and Miracast™ are trademarks of Wi-Fi Alliance.

- This product includes Home Networking Software 'DiXiM' developed by DigiOn, Inc.

- **LCフォント、LCFONT、エルシーフォント** and LC logo mark are registered trademarks of SHARP Corporation. This product is embedded with LC Font technology, which was developed by SHARP Corporation for clearly displaying easy-to-read characters on LCD screens. However, other fonts are used for some screen pages, too.

- Netflix and the Netflix logo are the registered trademarks of Netflix, Inc.

- VUDU™ is a trademark of VUDU, Inc.

- For DTS patents, see <http://patents.dts.com>. Manufactured under license from DTS Licensing Limited. DTS, the Symbol, & DTS and the Symbol together are registered trademarks, and DTS 2.0+Digital Out is a trademark of DTS, Inc. © DTS, Inc. All Rights Reserved.

- MHL, the MHL Logo, and Mobile High-Definition Link are trademarks or registered trademarks of MHL LLC in the United States and other countries.
- MHL™

ENERGY STAR® User Information

- For more information on the ENERGY STAR program, you can refer to energystar.gov.
- Leaving the ENERGY STAR home mode or enabling optional features will cause an increase power consumed.
- This product qualifies for ENERGY STAR when "Home" is selected for "TV Location". Setting "TV Location" to "Home" allows the TV to achieve an energy-saving status for household use.



Products that have earned the ENERGY STAR® are designed to protect the environment through superior energy efficiency.

Dimensional Drawings

LC-80LE661U

Unit: inch (mm)
 Unité: pouce (mm)
 Unidad: pulgada (mm)

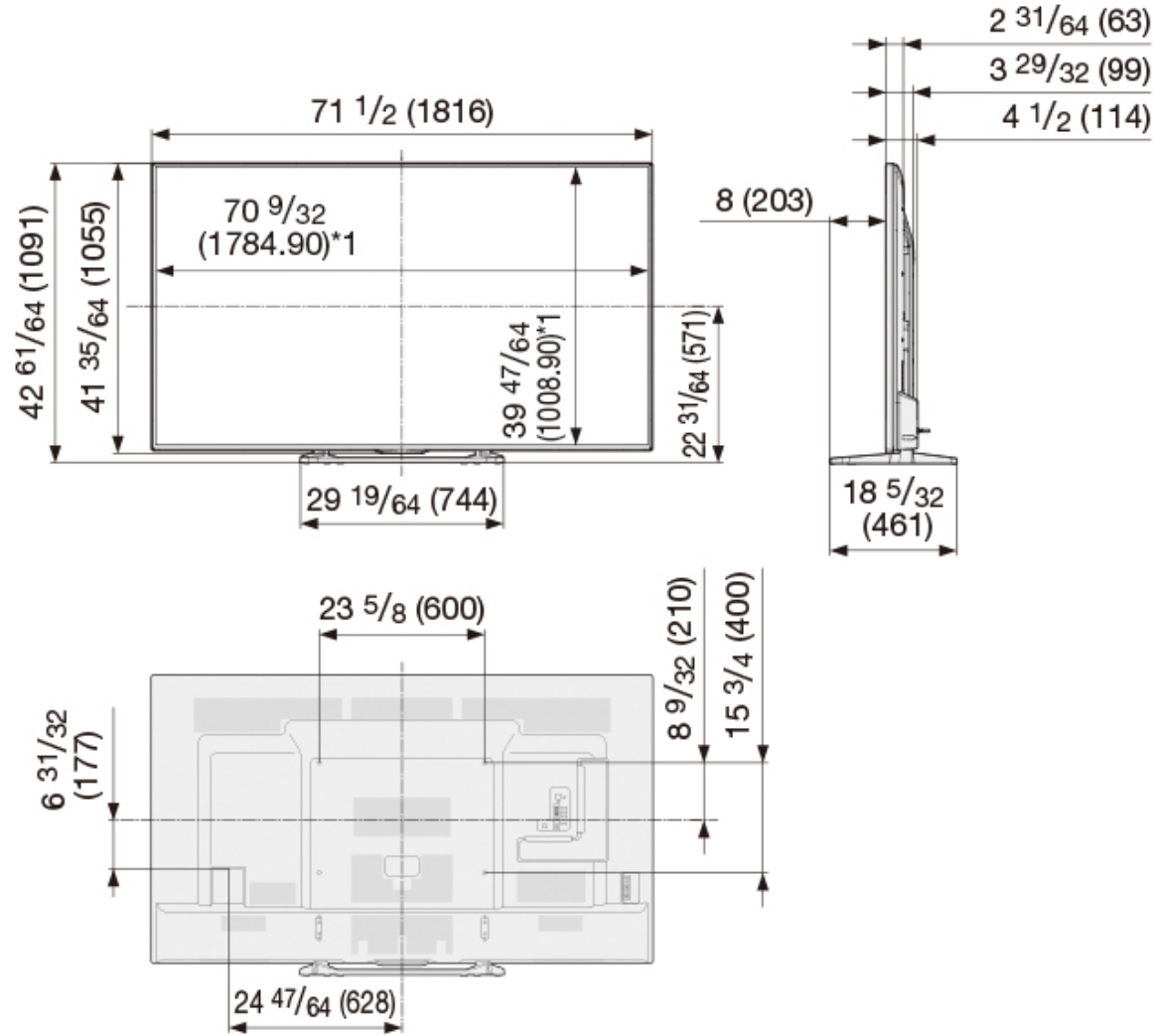

*1 Active area/Área activa/Zone active

*2 Thinnest part/Parte más delgada/Partie la plus mince

*3 Including projecting parts/Incluyendo partes salientes/Parties saillantes incluses

Dimensional Drawings

LC-70LE660U/LC-70LE661U/LC-70C6600U/LC-70EQ30U

Unit: inch (mm)
Unité: pouce (mm)
Unidad: pulgada (mm)

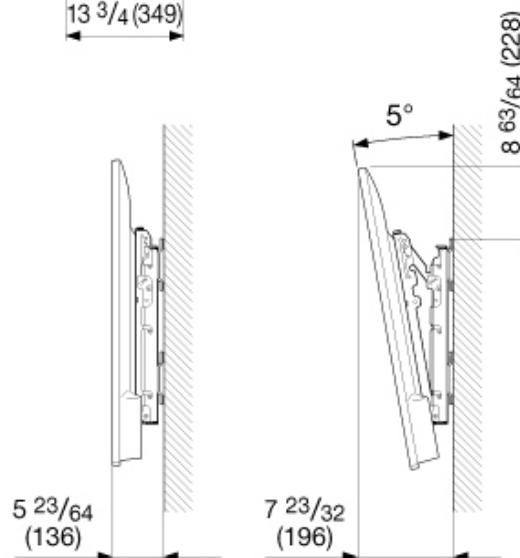
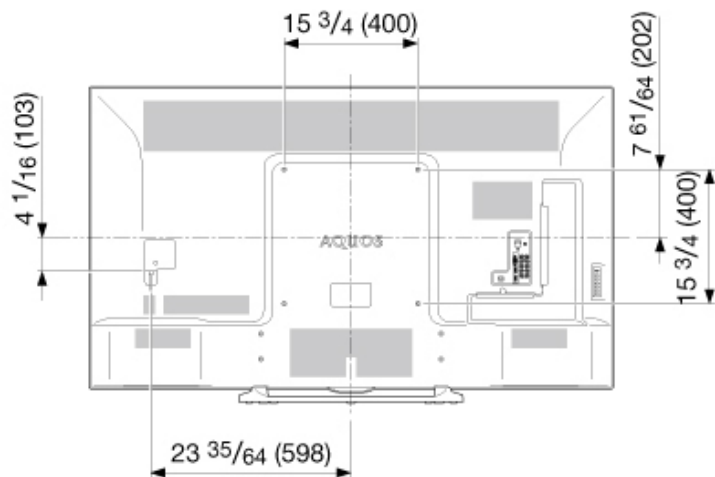
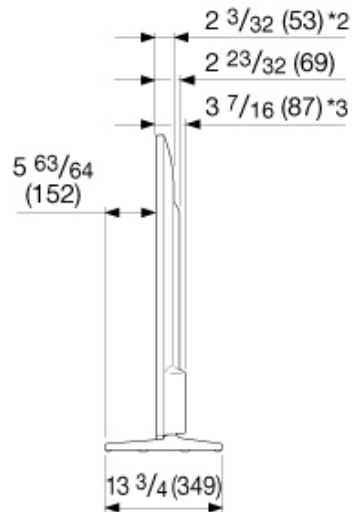
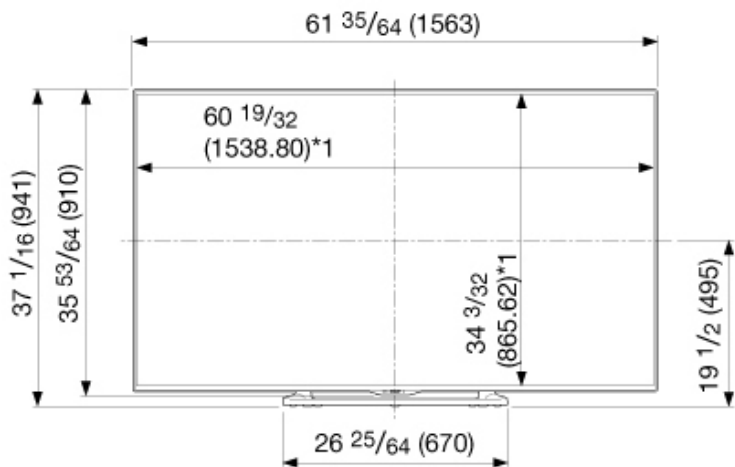

AN-52AG4

*1 Active area/Área activa/Zone active

*2 Thinnest part/Parte más delgada/Partie la plus mince

*3 Including projecting parts/Incluyendo partes salientes/Parties saillantes incluses

Dimensional Drawings

LC-60LE660U/LC-60LE661U/LC-60C6600U/LC-60EQ30U

Unit: inch (mm)
Unité: pouce (mm)
Unidad: pulgada (mm)

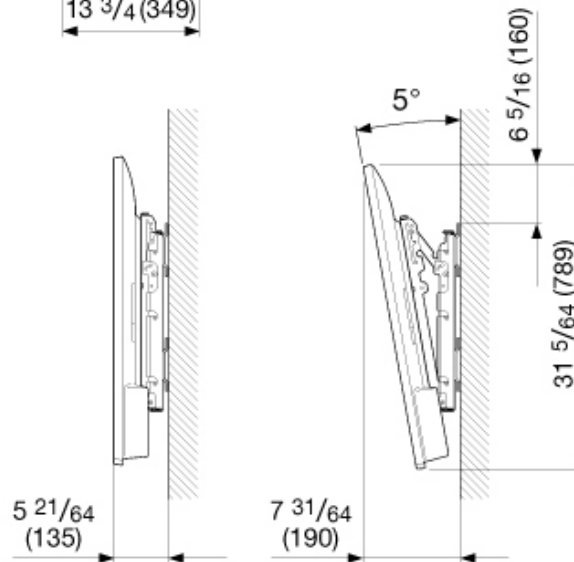
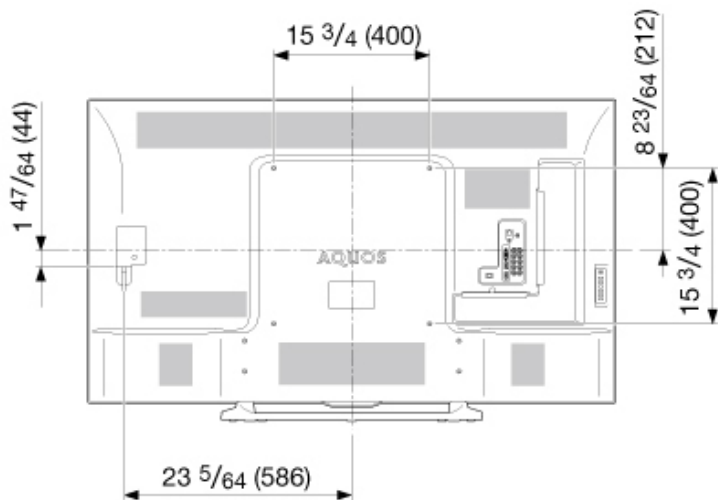
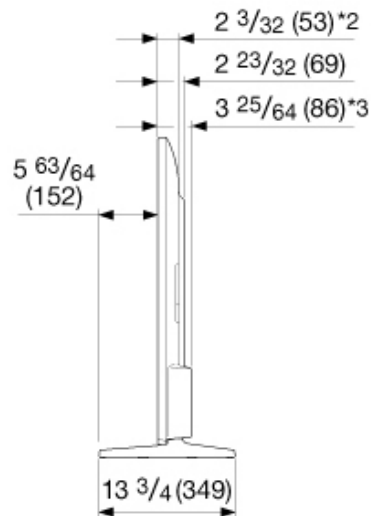
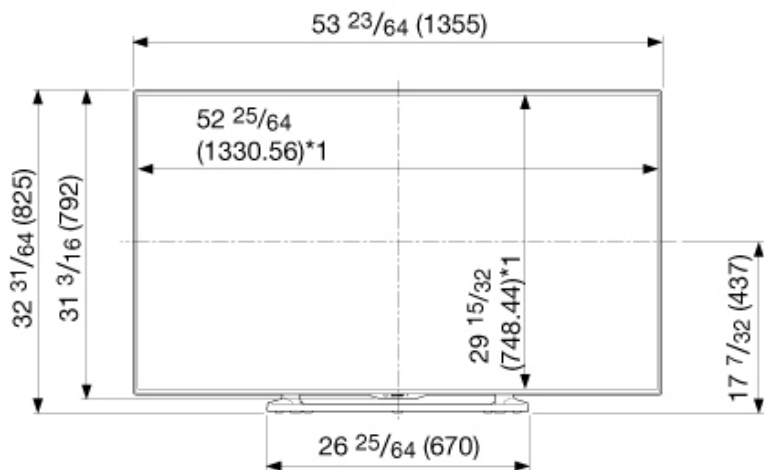

AN-52AG4

*1 Active area/Área activa/Zone active

*2 Thinnest part/Parte más delgada/Partie la plus mince

*3 Including projecting parts/Incluyendo partes salientes/Parties saillantes incluses

SmartCentral Terms of Use / Privacy Policy

SmartCentral Terms of Use

The following SmartCentral Terms of Use, as well as the SmartCentral Privacy Policy available at <https://www.sharpusa.com/SmartCentral/privacypolicy.aspx> (collectively, the "Terms and Conditions") govern Your use of SmartCentral. By using SmartCentral, You agree to be bound by these SmartCentral Terms and Conditions and acknowledge that you have read and understand the SmartCentral Privacy Policy.

1. Definitions

"SmartCentral" is an Internet-based service provided by Sharp Electronics Corporation ("Sharp") which is accessible only via your AQUOS television. SmartCentral consists of information services and other content, including underlying operating systems or platforms (collectively, "Connected Services") which may be provided by Sharp, affiliates of Sharp, including but not limited to its parent corporation or subsidiaries ("Affiliates"), and other third parties ("Third Party Content Providers"). "You", "Your", and "Yourself" shall be synonymous for purposes of these Terms and Conditions and shall mean each person who uses SmartCentral".

2. Use of SmartCentral

By using SmartCentral, You hereby accept these Terms and Conditions as currently constituted and as may be updated from time to time. Sharp shall have the right at any time and in its sole discretion to change or modify the terms and conditions applicable to the use of SmartCentral, or any part thereof, or to impose new conditions, including, but not limited to, adding fees and charges for the use of SmartCentral or any Connected Services provided therein. Such alterations, edits, supplements or amendments shall be effective immediately upon notice thereof, which may be given by posting on SmartCentral. Any use of SmartCentral by You after such notice shall constitute acceptance of any such alterations, edits, supplements or amendments. Please therefore regularly visit these Terms and Conditions so that You are aware of any such additional or revised terms or conditions to which You are bound. If any changes made to these Terms and Conditions are unacceptable to You, You must immediately terminate use of SmartCentral by pressing the "Exit" button. Please note that You may also be required to accept other terms and conditions that govern use of particular services or Connected Services available on your AQUOS television and prior to Your access to or use of such services, including end user license agreements from Third Party Content Providers.

3. Entire Agreement

These Terms and Conditions constitute the entire agreement between You and Sharp concerning the use of SmartCentral and supersede any and all statements or other agreements, whether oral or written, between You and Sharp. These Terms and Conditions may not be altered, edited, supplemented or amended in any manner by You and any such attempted alteration, edit, supplement or amendment shall be null and void, unless first agreed to by an authorized representative of Sharp in writing.

4. Representations and Warranties

You represent and warrant that You (a) are at least 18 years old; (b) have the right, authority and capacity to bind yourself to these Terms and Conditions; (c) have read the SmartCentral Privacy Policy; and (d) have read and agree to these Terms and Conditions.

5. Personal/Non-Commercial Use

Unless otherwise specified, SmartCentral is for personal and non-commercial use. You may not modify, copy, distribute, transmit, display, perform, reproduce, publish, license, create derivative works from, transfer or sell any Connected Services made available through your AQUOS television.

6. Privacy and Protection of Personal Information

At Sharp, we make every effort to maximize and maintain the privacy and security of users. The SmartCentral Privacy Policy is incorporated by reference into these Terms of Use and applies to information submitted or collected via SmartCentral. To view the SmartCentral Privacy Policy, which may be revised by us from time to time, please visit <https://www.sharpusa.com/SmartCentral/privacypolicy.aspx>.

7. Modifications to SmartCentral and/or Resources

Sharp, in its sole discretion, shall control the appearance, development and operation of SmartCentral. Sharp reserves the right, for any reason and in its sole discretion and without notice, to modify, terminate, change, suspend or discontinue any and all aspects of SmartCentral, including, without limitation, available Connected Services, the method of delivery, features, and/or hours of availability. Sharp shall not be liable to You or any third party for such modification, termination, change, suspension or discontinuation, if any.

8. Fees and Equipment

The SmartCentral platform is provided to You at no additional charge. Sharp reserves the right to change prices or institute new charges at any time and in its sole discretion for the use of SmartCentral and/or any Connected Services provided therein. Further, You shall be responsible for obtaining or maintaining all television, Internet hardware, Internet connectivity and other equipment or services needed for access to and use of SmartCentral and all charges related thereto.

9. Availability of SmartCentral

You may not be able to access SmartCentral or the Connected Services for a variety of reasons, including, but not limited to, power failure, other Internet connection failure, or failure to configure Your television properly. Sharp, its directors, officers, employees, agents, contractors and Affiliates shall not be liable to You or any third party with respect to such failures or maintenance outages, regardless of cause or whether it could have been avoided.

10. Accounts, Passwords and Security

Certain features or services offered on or through SmartCentral may require opening an account, which may include, without limitation, setting up an ID, user name and/or password. You are solely and entirely responsible for maintaining the confidentiality of Your account information, including Your password, and for the activity of users utilizing Your account, ID, user name and/or password, whether or not You specifically authorized such transactions. You agree to notify Sharp immediately of any unauthorized use of Your account, ID, user name and/or password, or any other breach of security. You may not use anyone else's account, user name, ID and/or password without the express permission and consent of the holder of that account, ID, user name and/or password. Sharp cannot and will not be liable for any loss or damage arising from the failure to comply with these obligations.

SmartCentral Terms of Use / Privacy Policy

11.No Unlawful or Prohibited Use

You agree that You will not use SmartCentral for any purpose that is unlawful or prohibited by these Terms and Conditions.

You may not use SmartCentral in any manner that could disable, damage, overburden or impair any Sharp server or networks connected to any Sharp server or interfere with any other party's use and enjoyment of SmartCentral. You may not attempt to gain unauthorized access to SmartCentral or to any Connected Services provided therein through hacking or any other means. You may not obtain or attempt to obtain any materials or information through any means not intentionally made available via SmartCentral and/or any Connected Services provided therein.

12.Termination

Sharp reserves the right to terminate Your authorization to use SmartCentral and/or any Connected Services provided therein at any time and for any reason, including, but not limited to, for Your violation of these Terms and Conditions. Upon termination, any provisions of the Terms and Conditions which, by their nature, are intended to survive termination, including, but not limited to, Sections 13, 14, 15, 16, 17, 18, 19, 20, 21, 22, 23, and 25 herein, shall continue to survive.

13.Third Party Content

Some Connected Services provided on or through SmartCentral is provided by Third Party Content Providers. Your use of Connected Services provided via Third Party Content Providers is at Your own risk and subject to any applicable agreement between You and the Third Party Content Provider. Although Sharp reserves the right to do so at any time and in its sole discretion, Sharp is not required to pre-screen or monitor any Connected Services available via SmartCentral from Third Party Content Providers. Unless otherwise specifically authorized by the applicable Third Party Content Providers, all third party content and services provided are for personal and non-commercial use; you may not modify, copy, distribute, transmit, display, perform, reproduce, upload, publish, license, create derivative works from, transfer or sell in any manner or medium any content or services available via this device. You agree that Sharp is not responsible for, makes no representations or warranties regarding, and accepts no liability in respect of Connected Services provided by Third Party Content Providers. You may at times be unable to access Connected Services from the device for a variety of reasons which may be unrelated to the device itself, including, but not limited to, power failure, other Internet connection, or failure to configure your device properly. Sharp, its directors, officers, employees, agents, contractors and affiliates shall not be liable to you or any third party with respect to such failures or maintenance outages, regardless of cause or whether or not it could have been avoided. You agree also that Sharp shall not be liable to you or any third party for your failure to abide by any authorization or terms of use provided by Third Party Content Providers. You agree that Sharp is not responsible, nor liable, for customer service-related issues related to the third party content or services. Any question, comments or service-related inquiries relating to the third party content or service should be made directly to the applicable content or service provider. You acknowledge that Connected Services provided via Third Party Content Providers may be governed by terms and conditions separate and apart from these Terms and Conditions and You expressly agree that Sharp shall not be liable to You or any third party for Your failure to abide by those Third Party Content Providers' terms and conditions.

14.Links to Other Sites

SmartCentral may contain links to other independent third-party Web sites ("Linked Sites"). These Linked Sites are provided solely as a convenience to You. Such Linked Sites are not under Sharp's control, and Sharp is not responsible for and does not endorse the content of such Linked Sites, including, but not limited to, any information or materials contained on such Linked Sites.

15.Disclaimer of Warranties

SMARTCENTRAL, INCLUDING ANY CONNECTED SERVICES PROVIDED THEREIN, IS PROVIDED TO YOU ON AN "AS-IS" AND "AS AVAILABLE" BASIS AND SHARP AND ITS AFFILIATES MAKE NO WARRANTY OR REPRESENTATION OF ANY KIND TO YOU, EITHER EXPRESS OR IMPLIED, INCLUDING WITHOUT LIMITATION, ANY WARRANTIES OF MERCHANTABILITY, NON-INFRINGEMENT OR FITNESS FOR A PARTICULAR PURPOSE OR ANY WARRANTIES OF SUITABILITY, AVAILABILITY, ACCURACY, COMPLETENESS, SECURITY, TITLE, USEFULNESS, LACK OF NEGLIGENCE OR ERROR-FREE OR UNINTERRUPTED OPERATION OR USE OF SMARTCENTRAL AND/OR CONNECTED SERVICES PROVIDED THEREIN, OR THAT SMARTCENTRAL, INCLUDING ANY CONNECTED SERVICES PROVIDED THEREIN, WILL MEET YOUR REQUIREMENTS OR EXPECTATIONS. FURTHER, SHARP AND ITS AFFILIATES MAKE NO WARRANTIES AS TO THE RESULTS THAT MAY BE OBTAINED FROM THE USE OF CONNECTED SERVICES MADE AVAILABLE ON YOUR AQUOS TELEVISION NOR SHALL THEY BE LIABLE TO YOU FOR ANY DECISIONS BASED ON ANY CONNECTED SERVICES PROVIDED. SHARP MAKES NO WARRANTIES OR REPRESENTATIONS AND ASSUMES NO RESPONSIBILITY AND SHALL NOT BE LIABLE FOR ANY DAMAGES RESULTING FROM ANY CONNECTED SERVICES PROVIDED BY THIRD PARTY CONTENT PROVIDERS. SUCH CONNECTED SERVICES PROVIDED BY THIRD PARTIES IS FOR USE AT YOUR OWN RISK. SHARP IS NOT AN AGENT OF AND ASSUMES NO RESPONSIBILITY FOR THE ACTS OR OMISSIONS OF THIRD PARTY CONTENT PROVIDERS NOR ANY ASPECT OF THE CONNECTED SERVICES RELATED TO THOSE THIRD PARTY CONTENT PROVIDERS. SOME JURISDICTIONS DO NOT APPLY THE EXCLUSION OF CERTAIN WARRANTIES SO THE ABOVE LIMITATIONS MAY NOT APPLY TO YOU.

SmartCentral Terms of Use / Privacy Policy

16. Limitation of Liability

IN NO EVENT WILL SHARP AND/OR ITS AFFILIATES BE LIABLE TO YOU OR ANY THIRD PARTY FOR ANY SPECIAL, INCIDENTAL, INDIRECT, PUNITIVE OR CONSEQUENTIAL DAMAGES, INCLUDING, BUT NOT LIMITED TO, LOSS OF PROFITS, DATA OR USE OR OTHER LOSS ARISING OUT OF OR RELATING TO THESE TERMS AND CONDITIONS, SMARTCENTRAL AND/OR ANY CONNECTED SERVICES PROVIDED THEREIN. THIS PARAGRAPH SHALL APPLY REGARDLESS OF WHETHER THE THEORY OF LIABILITY IS BASED ON CONTRACT, TORT, NEGLIGENCE, BREACH OF WARRANTY, STRICT LIABILITY OR OTHERWISE AND WHETHER OR NOT SHARP AND/OR ITS AFFILIATES HAVE BEEN ADVISED OF THE POSSIBILITY OF SUCH DAMAGES. IN NO EVENT SHALL SHARP AND/OR ITS AFFILIATES' AGGREGATE CUMULATIVE LIABILITY TO YOU OR ANY THIRD PARTY ARISING OUT OF OR RELATED TO SMARTCENTRAL AND/OR ANY CONNECTED SERVICES PROVIDED THEREIN EXCEED FIFTY US DOLLARS (\$50). YOU HEREBY RELEASE SHARP AND/OR ITS AFFILIATES FROM ANY AND ALL OBLIGATIONS, LIABILITIES AND CLAIMS IN EXCESS OF THIS LIMITATION.

17. Indemnification

You agree to defend, indemnify and hold harmless Sharp, its directors, officers, employees, agents, contractors and Affiliates from and against all claims, losses, damages, expenses, liabilities and costs, including reasonable attorneys' fees, arising from or relating to Your use of SmartCentral, any Connected Services provided therein, and/or any breach of these Terms and Conditions.

18. Governing Law/Waiver of Jury Trial

These Terms and Conditions shall be governed by and construed under the laws of the State of New York, without regard to conflict of laws rules. You agree to the personal jurisdiction of and venue in the state and federal courts in New York County, New York, and waive any objection to such jurisdiction or venue. Any claim by You under these Terms and Conditions must be brought within one (1) year after the cause of action arises or such claim or cause of action is barred. You and Sharp hereby waive trial by jury with respect to any dispute relating to these Terms and Conditions, SmartCentral and/or any Connected Services provided therein.

19. Trademarks

The trademarks "Sharp," "AQUOS," "SmartCentral," or any other related product names, service names or logos used, quoted and/or referenced on SmartCentral are trademarks, registered trademarks, or service marks of Sharp Corporation and/or its affiliates. All other product names, service names, logos and/or company names appearing on SmartCentral and/or Connected Services provided therein are the property of their respective holders and may be protected as their trademarks, registered trademarks, service marks and/or trade names.

20. Copyright

All Connected Services on or available through SmartCentral are © Sharp Electronics Corporation, its Affiliates and/or Third Party Content Providers. All rights reserved.

21. Notices

Any notices from Sharp to You relating to these Terms and Conditions or SmartCentral shall be posted on SmartCentral. You should therefore regularly visit these Terms and Conditions so that you are aware of any such notices.

Any notices, questions or comments related to these Terms and Conditions should be directed to: Legal Department
ATTN: SmartCentral Terms & Conditions
Sharp Electronics Corporation
One Sharp Plaza
Mahwah, NJ 07430

22. Assignment

Sharp may assign these Terms and Conditions, in whole or in part, to any third party at any time with or without notice to You. You may not assign or transfer these Terms and Conditions.

23. Force Majeure

Sharp shall in no way be liable for any delay or failure in its performance to the extent such delay or failure is caused or is a result of acts beyond Sharp's reasonable control, including, but not limited to, acts of God, fire, flood, earthquake, accident, riot, war, government intervention, terrorism, embargoes, strikes, labor difficulties, equipment failures, or any other causes beyond the control of Sharp.

24. Headings

All section headings used in these Terms and Conditions are for convenience or reference only and in no way shall form a part of these Terms and Conditions or expand, limit, define or interpret the scope of this agreement or any provision hereof.

25. Waiver/Severability

Sharp's waiver of any breach or right under these Terms and Conditions shall not be deemed a waiver of any other or subsequent breach or right. If any provision of these Terms and Conditions is found to be invalid or unenforceable, such provision shall be changed and interpreted so as to best accomplish the original intent of the provision to the fullest extent permitted by law and the remaining provisions shall remain in full force and effect.

SmartCentral Terms of Use / Privacy Policy

SmartCentral Privacy Policy

Sharp Electronics Corporation ("Sharp") is committed to protecting your privacy. Please read the following SmartCentral Privacy Policy ("Privacy Policy") as it applies to data and information obtained through SmartCentral. This Privacy Policy applies only to information submitted or collected through SmartCentral and may differ from other Sharp privacy policies or privacy policies of third party applications or sites accessed on the SmartCentral platform. This Privacy Policy should be read in conjunction with the SmartCentral Terms of Use ("Terms of Use"), available at <http://www.sharpsusa.com/SmartCentral/termsofuse.aspx>, as this Privacy Policy is incorporated therein by reference. All defined terms in the Terms of Use shall have the same meaning in this Privacy Policy.

1. Information We Collect

As part of Your use of SmartCentral and any Sharp services available through SmartCentral, Sharp may ask that you voluntarily provide some types of personally identifiable information to us, including, but not limited to, Your name and contact information. Sharp may also collect and store certain other information through Your use of SmartCentral, including, but not limited to, IP address, MAC address (a unique identifier of the device), other individual device identifiers, individual account information and passwords, application access information, user preferences, usage patterns, cache data, and other actions taken in connection with the use of SmartCentral.

2. Use of Your Information

Sharp collects and may use the information collected to operate and improve SmartCentral, deliver the services and/or Connected Services You have requested or may be interested in, and otherwise enhance Your overall experience with SmartCentral. For instance, Sharp may, without limitation, use the information to provide customer service and support, update You on new products or services, personalize SmartCentral, make new content available to You based on geographic location, interests or preferences, or share information collected with existing or potential Third Party Content Providers to deliver or improve existing or develop new content accessible via SmartCentral. Sharp may further share Your information, including personally identifiable information, with third parties: (1) who perform functions, as our agent or contractor, including, but not limited to, analyzing data, providing marketing assistance, hosting websites and providing customer support; (2) to comply with the law, applicable regulations, court orders or subpoenas, to enforce the Terms and Conditions or other agreements, or to protect our rights, property or safety or the rights, property or safety of our users or others; (3) if the disclosure is done as part of a purchase, transfer or sale of services or assets (e.g., in the event that substantially all of our assets are acquired by another party, customer information may be one of the transferred assets); or (4) as otherwise described in this Privacy Policy. Sharp's agents or contractors who have access to Your personally identifiable information in connection with the above activities are required to keep the information confidential and not to use it for any purpose other than to carry out the services they are performing for Sharp.

3. How We Collect Information

Sharp may utilize standard internet tools such as cookies, tags, caches, and user events to temporarily store or retrieve non-personally identifiable information in connection with your use of SmartCentral. A Cookie is a text-only string of characters which may be temporarily stored in Your SmartCentral television or on Sharp's servers. A Pixel Tag is a graphic on a web page or in an e-mail message designed to track pages viewed and messages opened. Third Party Content Providers may also use Cookies, Pixel Tags, user events, or other tools on their sites and applications available through SmartCentral. Please be aware that any information gathered by sites or applications available through the SmartCentral platform are collected by the Third Party Content Provider and not by Sharp. Sharp has no access to or control over the collection, storage, or use of information gathered by Third Party Content Provider(s). For more information about third party sites, please see Section 4 below.

4. Third Party Sites

This Privacy Policy applies only to information gathered directly by and through the SmartCentral interface and does not pertain to any other site or application, whether owned or operated by Sharp or a Third Party Content Provider, that is accessible or made available through SmartCentral. These other sites and applications may collect personal information about You. The information practices of those sites and applications are not covered by this Privacy Policy and such sites and applications may have their own privacy statements. You will have the opportunity to and should review the privacy policies of those sites and applications before providing any personal information

5. Security

Sharp takes precautions, including administrative, technical and physical measures, to safeguard and help protect personally identifiable information collected from loss, theft and misuse, as well as unauthorized access, disclosure, alteration and destruction. Information collected will be stored on a secure data base. Although we take appropriate measures to safeguard against unauthorized disclosures of information, Sharp cannot assure that personally identifiable information collected will never be disclosed in a manner that is inconsistent with this Privacy Policy.

6. Personal Information of Children

At Sharp, we are committed to protecting the personal information of children. As such, SmartCentral is not meant for use by individuals under the age of 18 and Sharp will not knowingly collect personal information from individuals under such age. If we learn that a child under the age of eighteen has provided any personal information, we will use commercially reasonable efforts to delete such information promptly. Sharp encourages parents and legal guardians to participate in all online activities of their children and instruct them to not provide any personally identifiable information to Sharp via SmartCentral.

SmartCentral Terms of Use / Privacy Policy

7. Opt-Out

You may terminate at any time the collection of personally identifiable and non-personally identifiable information by disabling Your use of SmartCentral.

8. Notice to California Residents - Your California Privacy Rights

If you are a California resident, you have the right to receive: (a) information identifying any third party company(ies) to whom Sharp may have disclosed, within the past year, Your personal information and (b) a description of the categories of personal information disclosed. To obtain such information, please email your request to: SmartCentralPrivacy@SharpUSA.com. You are entitled to request such information once per calendar year.

9. Updating this Policy

Sharp may revise or update this Privacy Policy as we change or add new services or content or develop better ways to serve users of SmartCentral. Please review our Privacy Policy regularly for updates. When we make a change we will post a new effective date on the Privacy Policy. If Your personal information will be used in a manner materially different from that stated at the time of collection, Sharp will notify users via a posting on this page for thirty (30) days before the material change is made.

10. Questions or Concerns

If You have any questions, comments or concerns regarding this Privacy Policy, You may contact Sharp at 1 Sharp Plaza, Mahwah, NJ 07495, or SmartCentralPrivacy@SharpUSA.com . .

NOTE

The Terms of Use and Privacy Policy may be updated or amended from time to time. To view the latest Terms of Use and Privacy Policy now in effect, please visit the following sites from any internet-connected device:
Privacy Policy :<http://www.sharppusa.com/SmartCentral/privacypolicy.aspx>
Terms of Use :<http://www.sharppusa.com/SmartCentral/termsofuse.aspx>

Software License

Information on the open-source software license.

Software composition

The software included in this product is comprised of various software components whose individual copyrights are held by third parties.

This product also makes use of freely distributed software and software components whose copyrights are held by third parties. These include software components covered by a GNU General Public License (hereafter GPL), a GNU Lesser General Public License (hereafter LGPL) or other license agreement.

Obtaining source code

Some of the open source software licensors require the distributor to provide the source code with the executable software components. GPL and LGPL include similar requirements. For information on obtaining the source code for the open source software and for obtaining the GPL, LGPL, and other license agreement information.

Acknowledgements

The following open source software components are included in this product:

```
/bootcode/uboot
/linux-3.7.2
/system/ap/develop/busybox/busybox-1.18.4
/system/lib/develop/e2fsprogs/e2fsprogs-1.42.6
/system/lib/develop/uClibc-0.9.30.3
/system/ap/develop/mtd/util
/system/tools/squashfs
/Platform_Lib/Graphics/FontRenderer/libotf-0.9.9
/Platform_Lib/Graphics/FontRenderer/fribidi-0.10.9
/Platform_Lib/Graphics/FontRenderer/freetype-2.3.5
/Utility/tinyxml
/Application/Win32/RSSClient/tinyxml
/Include/Utility/tinyxml"
```

```
/Utility/wpa_supplicant
/system/tools/lzma
/open_source/icu-54.1
/open_source/harfbuzz/harfbuzz-0.9.35
/open_source/graphite2/graphite2-1.2.4
```

```
/src/Platform_Lib/Graphics/DirectFB/DirectFB-1.4.2
/open_source/curl/curl-7.32.0
/open_source/libwebp/libwebp-0.4.1
/open_source/FastJpegLib/jpeg-6b
/open_source/libmng/libmng-2.0.2
/open_source/Libpng
/open_source/font/freetype-2.4.11
/open_source/c-ares/c-ares-1.10.0
/open_source/openssl-1.0.1j
/open_source/expat
/open_source/zlib-1.2.3
/open_source/Tremor
/open_source/Alsa/alsa-lib-1.0.23
/open_source/picotts
```

```
/Utility/wpa_supplicant
/libmediaplayerservice/wfdisplay/spu/core/bigd*
/open_source/HTTPC
/open_source/upnp
/system/src/Platform_Lib/Graphics/JpegRenderer
/system/open_source/libpng
/system/open_source/gif
/system/open_source/libwebp
http://svnrs.realtek.com.tw/svn/col/DVR/branches/Maria/system/open_source/Alsa/
http://svnrs.realtek.com.tw/svn/col/DVR/branches/Maria/system/open_source/curl/curl-7.28.1/
http://svnrs.realtek.com.tw/svn/col/DVR/branches/Maria/system/open_source/c-ares/c-ares-1.9.1/
http://svnrs.realtek.com.tw/svn/col/DVR/branches/Maria/system/open_source/icu_4_8_1_1/
http://svnrs.realtek.com.tw/svn/col/DVR/branches/Maria/system/open_source/mpg123-1.21.0/
http://svnrs.realtek.com.tw/svn/col/DVR/branches/Maria/system/open_source/fontconfig/
http://svnrs.realtek.com.tw/svn/col/DVR/branches/Maria/system/open_source/expat
http://svnrs.realtek.com.tw/svn/col/DVR/branches/software_branches/software_DTV_QtWebKit/system
everywhere-opensource-src-5.0.0
http://svnrs.realtek.com.tw/svn/col/DVR/branches/Maria/system/open_source/openssl-1.0.1l
```

Software License(Continue)

Software copyrights

Bootcode:
uboot
GPL V2 <http://tv.bobitag.com/LGPL/uboot.tgz>

Kernel:
vmlinux
GPL V2 <http://tv.bobitag.com/LGPL/linux-3.7.2.tgz>

busybox
GPL V2 <http://tv.bobitag.com/LGPL/busybox-1.18.4.tgz>

e2fsprogs
GPL V2 <http://tv.bobitag.com/LGPL/e2fsprogs-1.42.6.tar.gz>
<http://tv.bobitag.com/LGPL/e2fsprogs-libs-1.42.6.tar.gz>

uclibc
LGPL 2.1 <http://tv.bobitag.com/LGPL/uclibc-0.9.30.3.tar.bz2>

mkfs.jffs2
GPL V2 <http://tv.bobitag.com/LGPL/jffs2.tgz>

mksquashfs
GPL V2 <http://tv.bobitag.com/LGPL/squashfs4.2.tar.gz>

Library:
libotf
LGPL V2.1 <http://tv.bobitag.com/LGPL/libotf-0.9.9.tar.gz>

fribidi
LGPL V2.1 <http://tv.bobitag.com/LGPL/fribidi-0.10.9.tar.gz>

freetype
FTL ~ BSD <http://tv.bobitag.com/LGPL/freetype-2.4.11.tar.gz>

tinymce
zlib <http://sourceforge.net/projects/tinymce/files/>

openssl
Apache License 1.0 BSD
<http://tv.bobitag.com/LGPL/openssl-1.0.11.tgz>
<http://tv.bobitag.com/LGPL/openssl-1.0.1j.tar.gz>

Utility:
wpa_supplicant
BSD http://tv.bobitag.com/LGPL/wpa_supplicant-2.4.tar.gz

Izma
public domain <http://tv.bobitag.com/LGPL/izma-4.65.tgz>

Netflix
ICU
Non-restrictive open-source license
<http://tv.bobitag.com/LGPL/icu-4.8.1.1.tgz>
http://tv.bobitag.com/LGPL/icu4c-53_1.tgz
http://tv.bobitag.com/LGPL/icu4c-54_1-src.tgz

Harfbuzz
MIT
<http://tv.bobitag.com/LGPL/harfbuzz-0.9.35.tar.bz2>

Graphite
Apache 2.0 <http://tv.bobitag.com/LGPL/graphite2-1.2.4.tgz>

gperftools
New BSD License <http://tv.bobitag.com/LGPL/gperftools-2.2.tar.gz>

directFB
LGPL V2 <http://tv.bobitag.com/LGPL/DirectFB-1.4.2.tar.gz>

CURL
MIT/X
<http://tv.bobitag.com/LGPL/curl-7.28.1.tgz>
<http://tv.bobitag.com/LGPL/curl-7.32.0.tar.gz>

libwebp
BSD
<http://tv.bobitag.com/LGPL/libwebp-0.4.1.tar.gz>
<http://tv.bobitag.com/LGPL/libwebp-0.4.3.tar.gz>

libjpeg
JPEG

libmng
MNG License

Software License(Continue)

libpng
libpng license.

FreeType
freetype

c-ares
MIT

Miracast:
openssl
OpenSSL/SSLLeay

expat
MIT/X

zlib
Zlib

Tremor
Xiph.org

alsa
LGPL 2.1
<http://tv.bobitag.com/LGPL/alsa-lib-1.0.23.tar.gz>
<http://tv.bobitag.com/LGPL/alsa-lib-1.0.23.tgz>

picoTTS
apache 2
LGPL 2 <http://tv.bobitag.com/LGPL/JavaScriptCore.r118995.tar.gz>
MIT
BSD

Miracast:
openssl
Apache License 1.0
BSD
<http://tv.bobitag.com/LGPL/openssl-1.0.1j.tar.gz>
<http://tv.bobitag.com/LGPL/openssl-1.0.1l.tgz>

BigDigits
<http://www.di-mgt.com.au/bigdigitsCopyright.txt>
<http://tv.bobitag.com/LGPL/bigdigits.tar.gz>

Http:
neon
GPL <http://tv.bobitag.com/LGPL/HTTTPC.tar.bz2>

DLNA:
upnp
No License
<http://tv.bobitag.com/LGPL/upnp.1.6.16.tar.gz>
<http://tv.bobitag.com/LGPL/upnp.tar.bz2>

photo:
jpeg6b
public domain <http://tv.bobitag.com/LGPL/jpegsrc.v6b.tar.gz>

libpng
public domain
<http://tv.bobitag.com/LGPL/libpng-1.6.7.tar.gz>
<http://tv.bobitag.com/LGPL/libpng-1.6.17.tar.gz>

giflib
public domain <http://tv.bobitag.com/LGPL/giflib-5.1.1.tar.bz2>

libwebp
public domain
<http://tv.bobitag.com/LGPL/libwebp-0.4.1.tar.gz>
<http://tv.bobitag.com/LGPL/libwebp-0.4.3.tar.gz>

Others:
alsa
LGPL 2.1
<http://tv.bobitag.com/LGPL/alsa-lib-1.0.23.tar.gz>
<http://tv.bobitag.com/LGPL/alsa-lib-1.0.23.tgz>

curl
MIT/X derivate license
<http://tv.bobitag.com/LGPL/curl-7.28.1.tgz>
<http://tv.bobitag.com/LGPL/curl-7.32.0.tar.gz>

Software License(Continue)

GNU GENERAL PUBLIC LICENSE

Version 2, June 1991

Copyright (C) 1989, 1991 Free Software Foundation, Inc.
51 Franklin Street, Fifth Floor, Boston, MA 02110-1301, USA

Everyone is permitted to copy and distribute verbatim copies of this license document, but changing it is not allowed.

Preamble

The licenses for most software are designed to take away your freedom to share and change it. By contrast, the GNU General Public License is intended to guarantee your freedom to share and change free software--to make sure the software is free for all its users. This General Public License applies to most of the Free Software Foundation's software and to any other program whose authors commit to using it. (Some other Free Software Foundation software is covered by the GNU Lesser General Public License instead.) You can apply it to your programs, too.

When we speak of free software, we are referring to freedom, not price. Our General Public Licenses are designed to make sure that you have the freedom to distribute copies of free software (and charge for this service if you wish), that you receive source code or can get it if you want it, that you can change the software or use pieces of it in new free programs; and that you know you can do these things.

To protect your rights, we need to make restrictions that forbid anyone to deny you these rights or to ask you to surrender the rights. These restrictions translate to certain responsibilities for you if you distribute copies of the software, or if you modify it.

For example, if you distribute copies of such a program, whether gratis or for a fee, you must give the recipients all the rights that you have. You must make sure that they, too, receive or can get the source code. And you must show them these terms so they know their rights.

We protect your rights with two steps: (1) copyright the software, and (2) offer you this license which gives you legal permission to copy, distribute and/or modify the software.

c-ares
C89 compatibility, MIT licensed
<http://tv.bobitag.com/LGPL/c-ares-1.9.1.tgz>
<http://tv.bobitag.com/LGPL/c-ares-1.10.0.tar.gz>

icu
ICU license , a simple, permissive non-copyleft free software license, compatible with the GNU GPL.
<http://tv.bobitag.com/LGPL/icu-4.8.1.1.tgz>
http://tv.bobitag.com/LGPL/icu4c-53_1.tgz
http://tv.bobitag.com/LGPL/icu4c-54_1-src.tgz

mpg123
LGPL 2.1
<http://tv.bobitag.com/LGPL/mpg123-1.21.0.tgz>

fontconfig
Copyright Ac 2000,2001,2002,2003,2004,2006,2007 Keith Packard
Copyright Ac 2005 Patrick Lam
Copyright Ac 2009 Roozbeh Pournader
Copyright Ac 2008,2009 Red Hat, Inc.
Copyright Ac 2008 Danilo A?egan
Copyright Ac 2012 Google, Inc.
<http://tv.bobitag.com/LGPL/fontconfig-2.11.0.tgz>

expat
same as the MIT/X Consortium license.
<http://tv.bobitag.com/LGPL/expat.2.0.1.tar.gz>
<http://tv.bobitag.com/LGPL/expat-1.95.tgz>

QT(including Webkit)
LGPL 2.1 <http://tv.bobitag.com/LGPL/qt-everywhere-opensource-src-5.0.0.tgz>

openssl
Apache License 1.0 BSD
<http://tv.bobitag.com/LGPL/openssl-1.0.1j.tar.gz>
<http://tv.bobitag.com/LGPL/openssl-1.0.1l.tgz>

Software License(Continue)

Also, for each author's protection and ours, we want to make certain that everyone understands that there is no warranty for this free software. If the software is modified by someone else and passed on, we want its recipients to know that what they have is not the original, so that any problems introduced by others will not reflect on the original authors' reputations.

Finally, any free program is threatened constantly by software patents. We wish to avoid the danger that redistributors of a free program will individually obtain patent licenses, in effect making the program proprietary. To prevent this, we have made it clear that any patent must be licensed for everyone's free use or not licensed at all.

The precise terms and conditions for copying, distribution and modification follow.

TERMS AND CONDITIONS FOR COPYING, DISTRIBUTION AND MODIFICATION

0. This License applies to any program or other work which contains a notice placed by the copyright holder saying it may be distributed under the terms of this General Public License. The "Program", below, refers to any such program or work, and a "work based on the Program" means either the Program or any derivative work under copyright law: that is to say, a work containing the Program or a portion of it, either verbatim or with modifications and/or translated into another language. (Hereinafter, translation is included without limitation in the term "modification".) Each licensee is addressed as "you".

Activities other than copying, distribution and modification are not covered by this License; they are outside its scope. The act of running the Program is not restricted, and the output from the Program is covered only if its contents constitute a work based on the Program (independent of having been made by running the Program). Whether that is true depends on what the Program does.

1. You may copy and distribute verbatim copies of the Program's source code as you receive it, in any medium, provided that you conspicuously and appropriately publish on each copy an appropriate copyright notice and disclaimer of warranty; keep intact all the notices that refer to this License and to the absence of any warranty; and give any other recipients of the Program a copy of this License along with the Program.

You may charge a fee for the physical act of transferring a copy, and you may at your option offer warranty protection in exchange for a fee.

2. You may modify your copy or copies of the Program or any portion of it, thus forming a work based on the Program, and copy and distribute such modifications or work under the terms of Section 1 above, provided that you also meet all of these conditions:

- a) You must cause the modified files to carry prominent notices stating that you changed the files and the date of any change.
- b) You must cause any work that you distribute or publish, that in whole or in part contains or is derived from the Program or any part thereof, to be licensed as a whole to all third parties under the terms of this License.
- c) If the modified program normally reads commands interactively when run, you must cause it, when started running for such interactive use in the most ordinary way, to print or display an announcement including an appropriate copyright notice and a notice that there is no warranty (or else, saying that you provide a warranty) and that users may redistribute the program under these conditions, and telling the user how to view a copy of this License. (Exception: if the Program itself is interactive but does not normally print such an announcement, your work based on the Program is not required to print an announcement.)

These requirements apply to the modified work as a whole. If identifiable sections of that work are not derived from the Program, and can be reasonably considered independent and separate works in themselves, then this License, and its terms, do not apply to those sections when you distribute them as separate works. But when you distribute the same sections as part of a whole which is a work based on the Program, the distribution of the whole must be on the terms of this License, whose permissions for other licensees extend to the entire whole, and thus to each and every part regardless of who wrote it.

Thus, it is not the intent of this section to claim rights or contest your rights to work written entirely by you; rather, the intent is to exercise the right to control the distribution of derivative or collective works based on the Program.

In addition, mere aggregation of another work not based on the Program with the Program (or with a work based on the Program) on a volume of a storage or distribution medium does not bring the other work under the scope of this License.

Software License(Continue)

3. You may copy and distribute the Program (or a work based on it, under Section 2) in object code or executable form under the terms of Sections 1 and 2 above provided that you also do one of the following:

- a) Accompany it with the complete corresponding machine-readable source code, which must be distributed under the terms of Sections 1 and 2 above on a medium customarily used for software interchange; or,
- b) Accompany it with a written offer, valid for at least three years, to give any third party, for a charge no more than your cost of physically performing source distribution, a complete machine-readable copy of the corresponding source code, to be distributed under the terms of Sections 1 and 2 above on a medium customarily used for software interchange; or,
- c) Accompany it with the information you received as to the offer to distribute corresponding source code. (This alternative is allowed only for noncommercial distribution and only if you received the program in object code or executable form with such an offer, in accord with Subsection b above.)

The source code for a work means the preferred form of the work for making modifications to it. For an executable work, complete source code means all the source code for all modules it contains, plus any associated interface definition files, plus the scripts used to control compilation and installation of the executable. However, as a special exception, the source code distributed need not include anything that is normally distributed (in either source or binary form) with the major components (compiler, kernel, and so on) of the operating system on which the executable runs, unless that component itself accompanies the executable.

If distribution of executable or object code is made by offering access to copy from a designated place, then offering equivalent access to copy the source code from the same place counts as distribution of the source code, even though third parties are not compelled to copy the source along with the object code.

4. You may not copy, modify, sublicense, or distribute the Program except as expressly provided under this License. Any attempt otherwise to copy, modify, sublicense or distribute the Program is void, and will automatically terminate your rights under this License. However, parties who have received copies, or rights, from you under this License will not have their licenses terminated so long as such parties remain in full compliance.

5. You are not required to accept this License, since you have not signed it. However, nothing else grants you permission to modify or distribute the Program or its derivative works. These actions are prohibited by law if you do not accept this License. Therefore, by modifying or distributing the Program (or any work based on the Program), you indicate your acceptance of this License to do so, and all its terms and conditions for copying, distributing or modifying the Program or works based on it.

6. Each time you redistribute the Program (or any work based on the Program), the recipient automatically receives a license from the original licensor to copy, distribute or modify the Program subject to these terms and conditions. You may not impose any further restrictions on the recipients' exercise of the rights granted herein. You are not responsible for enforcing compliance by third parties to this License.

7. If, as a consequence of a court judgment or allegation of patent infringement or for any other reason (not limited to patent issues), conditions are imposed on you (whether by court order, agreement or otherwise) that contradict the conditions of this License, they do not excuse you from the conditions of this License. If you cannot distribute so as to satisfy simultaneously your obligations under this License and any other pertinent obligations, then as a consequence you may not distribute the Program at all. For example, if a patent license would not permit royalty-free redistribution of the Program by all those who receive copies directly or indirectly through you, then the only way you could satisfy both it and this License would be to refrain entirely from distribution of the Program.

If any portion of this section is held invalid or unenforceable under any particular circumstance, the balance of the section is intended to apply and the section as a whole is intended to apply in other circumstances.

It is not the purpose of this section to induce you to infringe any patents or other property right claims or to contest validity of any such claims; this section has the sole purpose of protecting the integrity of the free software distribution system, which is implemented by public license practices. Many people have made generous contributions to the wide range of software distributed through that system in reliance on consistent application of that system; it is up to the author/donor to decide if he or she is willing to distribute software through any other system and a licensee cannot impose that choice.

This section is intended to make thoroughly clear what is believed to be a consequence of the rest of this License.

Software License(Continue)

8. If the distribution and/or use of the Program is restricted in certain countries either by patents or by copyrighted interfaces, the original copyright holder who places the Program under this License may add an explicit geographical distribution limitation excluding those countries, so that distribution is permitted only in or among countries not thus excluded. In such case, this License incorporates the limitation as if written in the body of this License.

9. The Free Software Foundation may publish revised and/or new versions of the General Public License from time to time. Such new versions will be similar in spirit to the present version, but may differ in detail to address new problems or concerns.

Each version is given a distinguishing version number. If the Program specifies a version number of this License which applies to it and "any later version", you have the option of following the terms and conditions either of that version or of any later version published by the Free Software Foundation. If the Program does not specify a version number of this License, you may choose any version ever published by the Free Software Foundation.

10. If you wish to incorporate parts of the Program into other free programs whose distribution conditions are different, write to the author to ask for permission. For software which is copyrighted by the Free Software Foundation, write to the Free Software Foundation; we sometimes make exceptions for this. Our decision will be guided by the two goals of preserving the free status of all derivatives of our free software and of promoting the sharing and reuse of software generally.

NO WARRANTY

11. BECAUSE THE PROGRAM IS LICENSED FREE OF CHARGE, THERE IS NO WARRANTY FOR THE PROGRAM, TO THE EXTENT PERMITTED BY APPLICABLE LAW. EXCEPT WHEN OTHERWISE STATED IN WRITING THE COPYRIGHT HOLDERS AND/OR OTHER PARTIES PROVIDE THE PROGRAM "AS IS" WITHOUT WARRANTY OF ANY KIND, EITHER EXPRESSED OR IMPLIED, INCLUDING, BUT NOT LIMITED TO, THE IMPLIED WARRANTIES OF MERCHANTABILITY AND FITNESS FOR A PARTICULAR PURPOSE. THE ENTIRE RISK AS TO THE QUALITY AND PERFORMANCE OF THE PROGRAM IS WITH YOU. SHOULD THE PROGRAM PROVE DEFECTIVE, YOU ASSUME THE COST OF ALL NECESSARY SERVICING, REPAIR OR CORRECTION.

12. IN NO EVENT UNLESS REQUIRED BY APPLICABLE LAW OR AGREED TO IN WRITING WILL ANY COPYRIGHT HOLDER, OR ANY OTHER PARTY WHO MAY MODIFY AND/OR REDISTRIBUTE THE PROGRAM AS PERMITTED ABOVE, BE LIABLE TO YOU FOR DAMAGES, INCLUDING ANY GENERAL, SPECIAL, INCIDENTAL OR CONSEQUENTIAL DAMAGES ARISING OUT OF THE USE OR INABILITY TO USE THE PROGRAM (INCLUDING BUT NOT LIMITED TO LOSS OF DATA OR DATA BEING RENDERED INACCURATE OR LOSSES SUSTAINED BY YOU OR THIRD PARTIES OR A FAILURE OF THE PROGRAM TO OPERATE WITH ANY OTHER PROGRAMS), EVEN IF SUCH HOLDER OR OTHER PARTY HAS BEEN ADVISED OF THE POSSIBILITY OF SUCH DAMAGES.

END OF TERMS AND CONDITIONS

How to Apply These Terms to Your New Programs

If you develop a new program, and you want it to be of the greatest possible use to the public, the best way to achieve this is to make it free software which everyone can redistribute and change under these terms.

To do so, attach the following notices to the program. It is safest to attach them to the start of each source file to most effectively convey the exclusion of warranty; and each file should have at least the "copyright" line and a pointer to where the full notice is found.

one line to give the program's name and an idea of what it does.
Copyright (C) yyyy name of author

This program is free software; you can redistribute it and/or modify it under the terms of the GNU General Public License as published by the Free Software Foundation; either version 2 of the License, or (at your option) any later version.

This program is distributed in the hope that it will be useful, but WITHOUT ANY WARRANTY; without even the implied warranty of MERCHANTABILITY or FITNESS FOR A PARTICULAR PURPOSE. See the GNU General Public License for more details.

Software License(Continue)

You should have received a copy of the GNU General Public License along with this program; if not, write to the Free Software Foundation, Inc., 51 Franklin Street, Fifth Floor, Boston, MA 02110-1301, USA.

Also add information on how to contact you by electronic and paper mail.

If the program is interactive, make it output a short notice like this when it starts in an interactive mode:

Gnomovision version 69, Copyright (C) year name of author
Gnomovision comes with ABSOLUTELY NO WARRANTY; for details type `show w'. This is free software, and you are welcome to redistribute it under certain conditions; type `show c' for details.

The hypothetical commands `show w' and `show c' should show the appropriate parts of the General Public License. Of course, the commands you use may be called something other than `show w' and `show c'; they could even be mouse-clicks or menu items--whatever suits your program.

You should also get your employer (if you work as a programmer) or your school, if any, to sign a "copyright disclaimer" for the program, if necessary. Here is a sample; alter the names:

Yoyodyne, Inc., hereby disclaims all copyright interest in the program `Gnomovision' (which makes passes at compilers) written by James Hacker.

signature of Ty Coon, 1 April 1989
Ty Coon, President of Vice

This General Public License does not permit incorporating your program into proprietary programs. If your program is a subroutine library, you may consider it more useful to permit linking proprietary applications with the library. If this is what you want to do, use the GNU Lesser General Public License instead of this License.

SHARP®

SHARP ELECTRONICS CORPORATION

1 Sharp Plaza, Suite 1, Mahwah, NJ 07495-1123

SHARP CORPORATION