

SHARP[®]

PN-CE701H

LCD MONITOR

OPERATION MANUAL

HDMI[™]

IMPORTANT:

To aid reporting in case of loss or theft, please record the product's model and serial numbers in the space provided. The numbers are located in the rear of the product.



Model No.:

Serial No.:

U.S.A. ONLY

IMPORTANT INFORMATION

WARNING: TO REDUCE THE RISK OF FIRE OR ELECTRIC SHOCK, DO NOT EXPOSE THIS PRODUCT TO RAIN OR MOISTURE.

	CAUTION RISK OF ELECTRIC SHOCK DO NOT OPEN	
CAUTION: TO REDUCE THE RISK OF ELECTRIC SHOCK, DO NOT REMOVE COVER. NO USER-SERVICEABLE PARTS INSIDE. REFER SERVICING TO QUALIFIED SERVICE PERSONNEL.		



The lightning flash with arrowhead symbol, within a triangle, is intended to alert the user to the presence of uninsulated “dangerous voltage” within the product’s enclosure that may be of sufficient magnitude to constitute a risk of electric shock to persons.



The exclamation point within a triangle is intended to alert the user to the presence of important operating and maintenance (servicing) instructions in the literature accompanying the product.

WARNING:

FCC Regulations state that any unauthorized changes or modifications to this equipment not expressly approved by the manufacturer could void the user’s authority to operate this equipment.

NOTE:

This equipment has been tested and found to comply with the limits for a Class A digital device, pursuant to Part 15 of the FCC Rules. These limits are designed to provide reasonable protection against harmful interference when the equipment is operated in a commercial environment. This equipment generates, uses, and can radiate radio frequency energy and, if not installed and used in accordance with the instruction manual, may cause harmful interference to radio communications. Operation of this equipment in a residential area is likely to cause harmful interference in which case the user will be required to correct the interference at his own expense.

This product utilizes a CR coin Lithium battery which contains a Perchlorate material. Special handling for this material may apply, California residents, See www.dtsc.ca.gov/hazardouswaste/perchlorate/ Others, consult local environmental officers.

U.S.A. ONLY

To maintain compliance with EMC regulations, use shielded cables to connect to the following terminals: HDMI input terminal, D-sub input/output terminals, Audio input/output terminals, Video input terminal, TOUCH PANEL terminal, and USB port.

DEAR SHARP CUSTOMER

Thank you for your purchase of a SHARP LCD product. To ensure safety and many years of trouble-free operation of your product, please read the Safety Precautions carefully before using this product.

SAFETY PRECAUTIONS

Electricity is used to perform many useful functions, but it can also cause personal injuries and property damage if improperly handled. This product has been engineered and manufactured with the highest priority on safety. However, improper use can result in electric shock and/or fire. In order to prevent potential danger, please observe the following instructions when installing, operating and cleaning the product. To ensure your safety and prolong the service life of your LCD product, please read the following precautions carefully before using the product.

1. Read instructions — All operating instructions must be read and understood before the product is operated.
2. Keep this manual in a safe place — These safety and operating instructions must be kept in a safe place for future reference.
3. Observe warnings — All warnings on the product and in the instructions must be observed closely.
4. Follow instructions — All operating instructions must be followed.
5. Cleaning — Unplug the power cord from the power outlet before cleaning the product. Use a dry cloth to clean the product. Do not use liquid cleaners or aerosol cleaners. Do not use dirty cloths. Doing so may damage the product.
6. Attachments — Do not use attachments not recommended by the manufacturer. Use of inadequate attachments can result in accidents.
7. Water and moisture — Do not use the product near water. Do not install the product in a place where water may splash onto it. Be careful of equipment which drains water such as an air-conditioner.
8. Ventilation — The vents and other openings in the cabinet are designed for ventilation. Do not cover or block these vents and openings since insufficient ventilation can cause overheating and/or shorten the life of the product. Do not place the product on a sofa, rug or other similar surface, since they can block ventilation openings. Do not place the product in an enclosed place such as a bookcase or rack, unless proper ventilation is provided or the manufacturer's instructions are followed.
9. Power cord protection — The power cords must be routed properly to prevent people from stepping on them or objects from resting on them.
10. The screen used in this product is made of glass. Therefore, it can break when the product is dropped or applied with impact. Be careful not to be injured by broken glass pieces in case the screen breaks.
11. Overloading — Do not overload power outlets or extension cords. Overloading can cause fire or electric shock.
12. Entering of objects and liquids — Never insert an object into the product through vents or openings. High voltage flows in the product, and inserting an object can cause electric shock and/or short internal parts. For the same reason, do not spill water or liquid on the product.
13. Servicing — Do not attempt to service the product yourself. Removing covers can expose you to high voltage and other dangerous conditions. Request a qualified service person to perform servicing.
14. Repair — If any of the following conditions occurs, unplug the power cord from the power outlet, and request a qualified service person to perform repairs.
 - a. When the power cord or plug is damaged.
 - b. When a liquid was spilled on the product or when objects have fallen into the product.
 - c. When the product has been exposed to rain or water.
 - d. When the product does not operate properly as described in the operating instructions.

Do not touch the controls other than those described in the operating instructions. Improper adjustment of controls not described in the instructions can cause damage, which often requires extensive adjustment work by a qualified technician.
 - e. When the product has been dropped or damaged.
 - f. When the product displays an abnormal condition. Any noticeable abnormality in the product indicates that the product needs servicing.
15. Replacement parts — In case the product needs replacement parts, make sure that the service person uses replacement parts specified by the manufacturer, or those with the same characteristics and performance as the original parts. Use of unauthorized parts can result in fire, electric shock and/or other danger.
16. Safety checks — Upon completion of service or repair work, request the service technician to perform safety checks to ensure that the product is in proper operating condition.
17. Wall mounting — When mounting the product on a wall, be sure to install the product according to the method recommended by the manufacturer.
18. Heat sources — Keep the product away from heat sources such as radiators, heaters, stoves and other heat-generating products (including amplifiers).

SAFETY PRECAUTIONS (Continued)

19. Batteries — Incorrect use of batteries may cause the batteries to burst or ignite. A leaky battery may corrode the equipment, dirty your hands or spoil your clothing. In order to avoid these problems, make sure to observe the precautions below:
 - Use the specified batteries only.
 - Install the batteries with due attention to the plus (+) and minus (-) sides of the batteries according to the instructions in the compartment.
 - Do not mix old and new batteries.
 - Do not mix batteries of different types. Voltage specifications of batteries of the same shape may vary.
 - Replace an exhausted battery with a new one promptly.
 - If you will not use the remote control for a long time, remove the batteries.
 - If leaked battery fluid gets on your skin or clothing, rinse immediately and thoroughly. If it gets into your eye, bathe your eye well rather than rubbing and seek medical treatment immediately. Leaked battery fluid that gets into your eye or your clothing may cause a skin irritation or damage your eye.
20. Usage of the monitor must not be accompanied by fatal risks or dangers that, could lead directly to death, personal injury, severe physical damage or other loss, including nuclear reaction control in nuclear facility, medical life support system, and missile launch control in a weapon system.
21. Do not stay in contact with the parts of the product that become hot for long periods of time. Doing so may result in low-temperature burns.
22. Do not modify this product.

WARNING:

This is a Class A product. In a domestic environment this product may cause radio interference in which case the user may be required to take adequate measures.

An apparatus with CLASS I construction shall be connected to a MAIN socket outlet with a protective earthing connection.

STABILITY HAZARD

If a monitor is not positioned in a sufficiently stable location, it can be potentially hazardous due to falling. Many injuries, particularly to children, can be avoided by taking simple precautions such as:

- Using fixing devices like wall mount brackets recommended by the manufacturer.
- Only using furniture that can safely support the monitor.
- Ensuring the monitor is not overhanging the edge of the supporting furniture.
- Not placing the monitor on tall furniture (for example, cupboards or bookcases) without anchoring both the furniture and the monitor to a suitable support.
- Not standing the monitors on cloth or other materials placed between the monitor and supporting furniture.
- Educating children about the dangers of climbing on furniture to reach the monitor or its controls.
- This equipment is not suitable for use in locations where children are likely to be present unsupervised.

Especially for child safety

- Don't allow children to climb on or play with the monitor.
- Don't place the monitor on furniture that can easily be used as steps, such as a chest of drawers.
- Remember that children can become excited while watching a program, especially on a "larger than life" monitor. Care should be taken to place or install the monitor where it cannot be pushed, pulled over, or knocked down.
- Care should be taken to route all cords and cables connected to the monitor so that they cannot be pulled or grabbed by curious children.

TIPS AND SAFETY INSTRUCTIONS

- The TFT color LCD panel used in this monitor is made with the application of high precision technology. However, there may be minute points on the screen where pixels never light or are permanently lit. Also, if the screen is viewed from an acute angle there may be uneven colors or brightness. Please note that these are not malfunctions but common phenomena of LCDs and will not affect the performance of the monitor.
- Do not display a still picture for a long period, as this could cause a residual image.
- Never rub or tap the monitor with hard objects.
- Please understand that SHARP CORPORATION bears no responsibility for errors made during use by the customer or a third party, nor for any other malfunctions or damage to this product arising during use, except where indemnity liability is recognized under law.
- This monitor and its accessories may be upgraded without advance notice.
- Do not use the monitor where there is a lot of dust, where humidity is high, or where the monitor may come into contact with oil or steam. Do not use in an environment where there are corrosive gases (sulfur dioxide, hydrogen sulfide, nitrogen dioxide, chlorine, ammonia, ozone, etc.). As this could lead to fire.
- Ensure that the monitor does not come into contact with water or other fluids. Ensure that no objects such as paper clips or pins enter the monitor as this could lead to fire or electric shock.
- Do not place the monitor on top of unstable objects or in unsafe places. Do not allow the monitor to receive strong shocks or to strongly vibrate. Causing the monitor to fall or topple over may damage it.
- Do not use the monitor near heating equipment or in places where there is likelihood of high temperature, as this may lead to generation of excessive heat and outbreak of fire.
- Do not use the monitor in places where it may be exposed to direct sunlight. Risk of cabinet deformation and failure if the monitor is used in direct sunlight.
- Please be sure to constantly remove dust and garbage that has attached to the ventilation opening. If dust collects in the ventilation opening or the inside of the monitor, it may lead to excessive heat, outbreak of fire, or malfunction. Please request a cleaning of the inside of the monitor from an authorized SHARP servicing dealer or service center.
- The power outlet shall be installed near the equipment and shall be easily accessible.
- Continuous operating time and warranty.
This product is designed for a maximum daily use of 16 hours. Continual use in excess of 16 hours per day is not covered by the warranty.
- Do not touch the screen when the monitor power is turned on, it will lead to a malfunction. When this occurs, turn the monitor power off and then on.
- Do not operate the screen with a hard or pointed object such as a fingernail or pencil.
- If another USB device is connected to the computer to which the touch panel is connected, do not operate the USB device during touch panel input. Input may not take place correctly.
- To maintain stable operation, this monitor must be restarted once a day.

- If you or a third party uses the product incorrectly, or if the product is subjected to the effects of static electricity or electrical noise, or if the product malfunctions or is repaired, there is a risk that saved data will be corrupted or lost.
- Always back up important data to a USB flash drive or SD memory card.
- We bear no responsibility for protection of internal memory recorded content or related damages.

The Power Cord

- Use only the power cord supplied with the monitor.
- Do not damage the power cord nor place heavy objects on it, stretch it or over bend it. Also, do not add extension cords. Damage to the cord may result in fire or electric shock.
- Do not use the power cord with a power tap. Adding an extension cord may lead to fire as a result of overheating.
- Do not remove or insert the power plug with wet hands. Doing so could result in electric shock.
- Unplug the power cord if it is not used for a long time.
- Do not attempt to repair the power cord if it is broken or malfunctioning. Refer the servicing to the service representative.

Manual Scope

- Microsoft and Windows are either registered trademarks or trademarks of Microsoft Corporation in the United States and/or other countries.
- Apple, Mac and macOS are trademarks of Apple Inc., registered in the U.S. and other countries.
- The terms HDMI, HDMI High-Definition Multimedia Interface, and the HDMI Logo are trademarks or registered trademarks of HDMI Licensing Administrator, Inc.
- Intel and Intel Core are trademarks or registered trademarks of Intel Corporation or its subsidiaries in the U.S.A. and other countries.
- Google, Chrome OS and Android are trademarks or registered trademarks of Google LLC.
- Ethernet is a registered trademark of Xerox Corporation.
- VESA is either registered trademark or trademark of Video Electronics Standards Association in the United States and/or other countries.
- All other brand and product names are trademarks or registered trademarks of their respective holders.
- Language of OSD menu used in this manual is English by way of example.
- Illustrations in this manual may not exactly represent the actual product or display.

LED Backlight

- The LED backlight in this product has a limited lifetime.
 - * If the screen gets dark or does not turn on, it may be necessary to replace the LED backlight.
 - * This LED backlight is exclusive to this product and must be replaced by an authorized SHARP servicing dealer or service center. Please contact an authorized SHARP servicing dealer or service center for assistance.

MOUNTING PRECAUTIONS

- This product is for indoor use.
- A mounting bracket compliant with VESA specifications is required.
- Since the monitor is heavy, consult your dealer before installing, removing or moving the monitor.
- Mounting the monitor on the wall requires special expertise and the work must be performed by an authorized SHARP dealer. You should never attempt to perform any of this work yourself. Our company will bear no responsibility for accidents or injuries caused by improper mounting or mishandling.
- Use the monitor with the surface perpendicular to a level surface.
- When moving the monitor, be sure to hold the parts marked by  below. Do not grasp the screen or tray. This may cause product damage, failure, or injury.

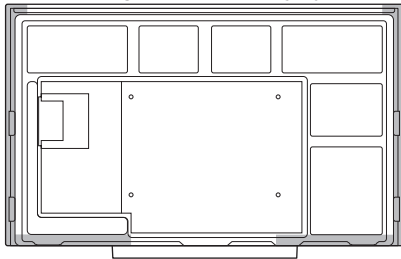

- This monitor should be used at an ambient temperature between 41°F (5°C) and 95°F (35°C). Provide enough space around the monitor to prevent heat from accumulating inside.

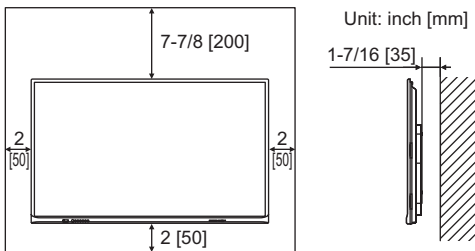

- If it is difficult to provide sufficient space for any reason such as the installation of the monitor inside a housing or of several units side-by-side, or if the ambient temperature may be outside of the range of 41°F (5°C) to 95°F (35°C), install a fan or take other measures to keep the ambient temperature within the required range.
- Temperature condition may change when using the monitor together with the optional equipments recommended by SHARP. In such cases, please check the temperature condition specified by the optional equipments.
- Do not block any ventilation openings. If the temperature inside the monitor rises, this could lead to a malfunction.
- Do not place the monitor on a device which generates heat.
- Do not use the product in locations where the unit is exposed to direct sunlight or other strong light. Since this product operates with infrared rays, such light may cause a malfunction.
- When using multiple monitors closely, be sure the infrared transmitter/receiver does not affect the other ones.

Contents

IMPORTANT INFORMATION	3	Drawing	24
DEAR SHARP CUSTOMER	4	Drawing	25
SAFETY PRECAUTIONS	4	LocalMM	26
TIPS AND SAFETY INSTRUCTIONS	6	Playing files	27
MOUNTING PRECAUTIONS	7	Operations during play	27
Supplied Components	9	File Explorer	28
System Requirements	9	Wireless Display	29
Part Names	10	Menu Items	30
Connecting Peripheral Equipment	12	Displaying the menu screen.....	30
Connecting the Power Cord	14	Menu item details	31
Binding Cables	14	Adjustments for computer screen display	35
Preparing the Remote Control Unit	15	Functional Restriction Setting (Function)	36
Installing the batteries	15	Controlling the Monitor with a computer (RS-232C) ...	37
Remote control operation range.....	15	Computer connection	37
Turning Power On/Off	16	Communication conditions	37
Turning on the main power.....	16	Communication procedure	37
Turning power on/off	16	RS-232C command table.....	39
Touch action	17	Troubleshooting	41
Touch action	17	Specifications	43
Other functions.....	19	Mounting Precautions	
Cautionary points	19	(For SHARP dealers and service engineers)	48
Basic Operation	20		
About the home screen of APPLICATION mode.....	20		
Using the side menu	20		
Using the remote control unit	21		

Supplied Components

If any component should be missing, please contact your dealer.

- Liquid Crystal Display Monitor: 1
- Remote control unit: 1
- Cable clamp (affixing type): 3



- Power cord: 1
- R03 battery ("AAA" size): 2
- CD-ROM (Utility Disk for Windows): 1
- Setup Manual: 1

- Touch pen: 2
- Tray: 1
- Tray mounting screws (M3x15): 5
- USB cable: 1
- Cover SHARP logo: 1
Place this sticker onto the SHARP logo to cover the logo.
- Wireless Adapter: 1

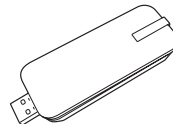

- * SHARP Corporation holds authorship rights to the Utility Disk program. Do not reproduce it without permission.
- * For environmental protection!
Do not dispose of batteries in household waste. Follow the disposal instructions for your area.

System Requirements

Hardware	Must have a USB 2.0 compliant port. CD-ROM drive required for software installation.
Operating system	Windows 8.1 (32-bit or 64-bit version), Windows 10 (32-bit or 64-bit version)
	macOS v10.13, v10.14
	Google Chrome OS Version 74 or later

Requirements when the software (Windows) supplied with this monitor is used.

CPU	Intel Core i5-6360U or faster Intel Core i7-6650U or faster recommended
Video Output	Must be capable of output at a Vsync of 60 Hz or higher
Memory	At least 4 GB
Free space on hard drive	At least 5 GB (free space separately required for data storage)

To use the touch panel, connect the USB cable (supplied) to your computer.

The touch panel operates with the standard driver of each operating system. On the Mac, operation is only possible in mouse mode.

Install Pen Software from the supplied CD-ROM.

When the Information Display Downloader is installed, you can check and download the most recent versions of the software programs.

To install the software, see the manual for each.

Part Names

■ Front view

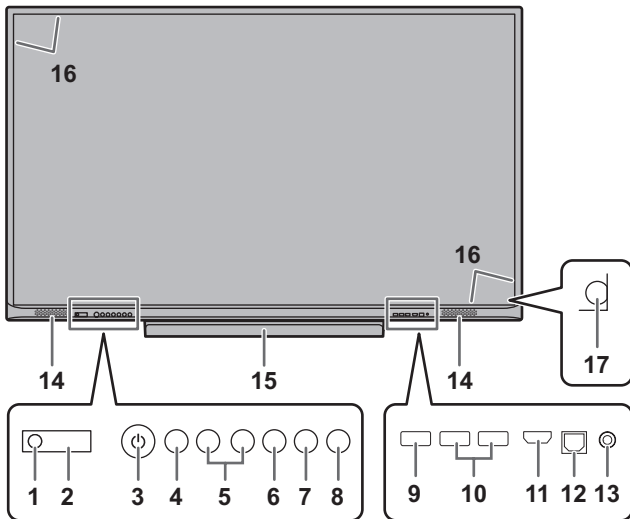

1. **Power LED** (See page 16.)
2. **Remote control sensor** (See page 15.)
3. **POWER button** (See page 16.)
4. **FREEZE button** (See page 21.)
5. **VOLUME +/- (Volume adjustment) buttons** (See page 21.)
6. **Touch On/Off button**
Toggle the touch panel on and off. When turned off, only this button and the POWER button can be used.
7. **MENU button** (See page 22.)
8. **INPUT button** (See page 22.)
9. **USB port (USB 2.0 compliant)** (See page 12.)
10. **USB ports (for Expansion slot) (USB 2.0 compliant)** (See page 12.)
11. **HDMI 1 input terminal** (See page 12.)
12. **TOUCH PANEL terminal 1 (for touch panel)** (See page 13.)
13. **Audio input terminal** (See page 13.)
14. **Speakers**
15. **Tray**
16. **Infrared transmitter/receiver**
17. **Brightness sensor**

■ Rear view

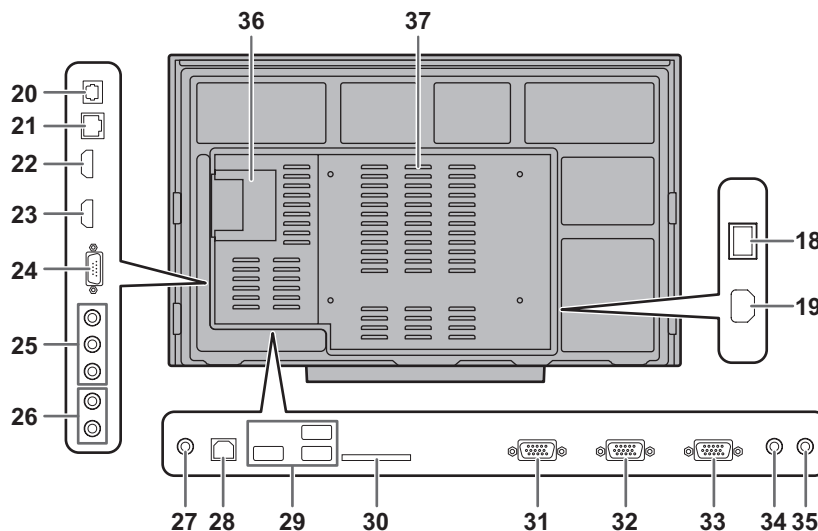

18. **Main power switch** (See page 16.)
19. **AC input terminal** (See page 14.)
20. **Digital audio output (optical) terminal** (See page 13.)
21. **LAN terminal** (See page 13.)
22. **HDMI 2 input terminal** (See page 13.)
23. **HDMI 3 input terminal** (See page 13.)
24. **RS-232C input terminal** (See page 13.)
25. **Component input terminals (AV/YPBPR)** (See page 13.)
26. **Audio input terminals (for component input terminals)** (See page 13.)
27. **Audio output terminal** (See page 13.)
28. **TOUCH PANEL terminal 2 (for touch panel)** (See page 13.)
29. **USB ports (USB 2.0 compliant)** (See page 12.)
30. **SD card slot** (See page 13.)
31. **D-sub 1 input terminal (VGA1)** (See page 13.)
32. **D-sub 2 input terminal (VGA2)** (See page 13.)
33. **D-sub output terminal** (See page 13.)
34. **Audio input terminal 1** (See page 13.)
35. **Audio input terminal 2** (See page 13.)
36. **Expansion slot (OPS)**
This section is used to connect optional hardware for function expansion. Offering this attachment location is not a guarantee that future compatible hardware attachments will be released.
37. **Vents**

! Caution

- Consult your SHARP dealer for attachment/detachment of optional parts.

■ Remote control unit

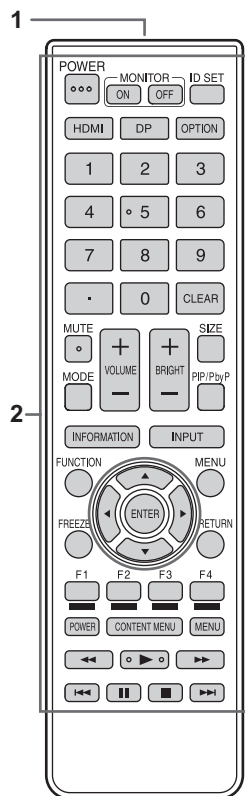

1. Signal transmitter
2. Operation buttons (See page 21.)

Connecting Peripheral Equipment

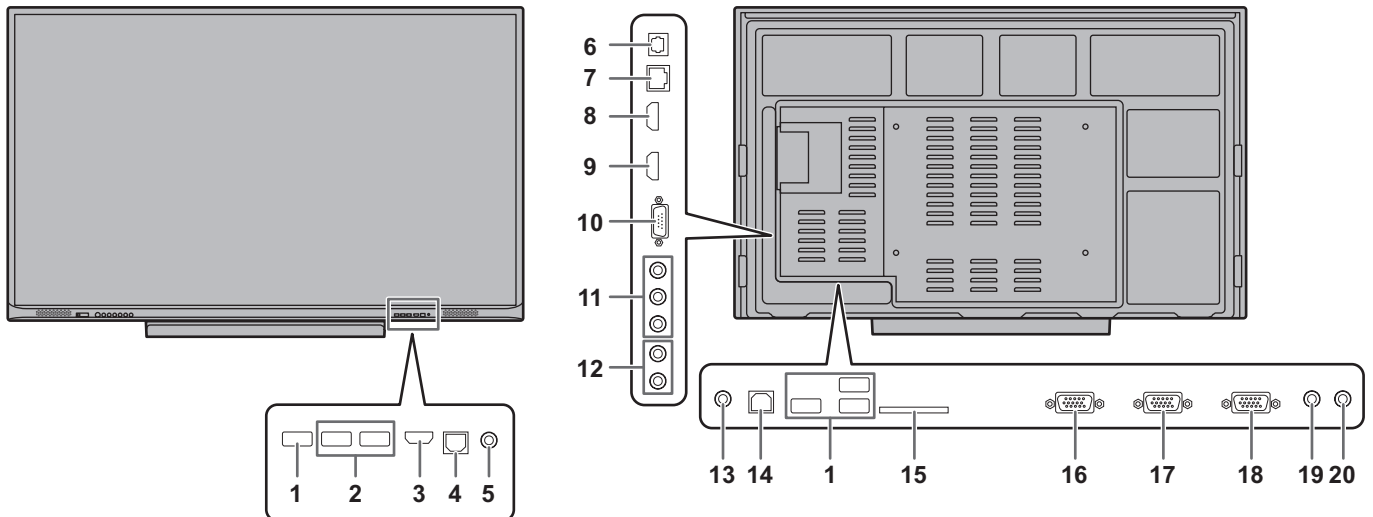

! Caution

- Be sure to turn off the main power switch and disconnect the plug from the power outlet before connecting/disconnecting cables. Also, read the manual of the equipment to be connected.
- Be careful not to confuse the input terminal with the output terminal when connecting cables. Accidentally reversing cables connected to the input and output terminals may cause malfunctions and other problems.
- Do not use any cable that has a damaged or deformed terminal. Using such cables may cause malfunctions.

TIPS

- When using the touch panel, connect the USB cable to the computer.
- Images may not be displayed properly depending on the computer (video card) to be connected.
- Use the automatic screen adjustment when a computer screen is displayed for the first time using VGA(D-SUB) or when the setting of the computer is changed. The screen is adjusted automatically using Auto adjust in PC image adjustment of the Image menu.
- If the audio output from the playback device is connected directly to speakers or other devices, the video on the monitor may appear delayed from the audio portion. Audio should be played through this monitor by connecting the playback device to the monitor's audio input, and connecting the monitor's audio output to the speakers or other devices.

1. USB ports (USB 2.0 compliant) (5 V, 500 mA)

- Connect a USB flash drive to the USB port.
- Do not connect a USB device other than a USB flash drive.
- Before removing a USB flash drive, follow the steps for removal. (See page 13.)

Supported USB flash drives

File System	FAT32
Capacity	Up to 32 GB (maximum file size 4 GB)

- Do not use a USB flash drive with a security function or a write protection function.
- Use a USB flash drive with a shape that can be inserted in the USB port. Some USB flash drives with special shapes cannot be inserted. Do not forcibly insert a USB flash drive. This may damage the connector and cause failure.

2. USB ports (for Expansion slot) (USB 2.0 compliant) (5 V, 500 mA)

- You can connect a commercially available USB mouse or USB keyboard as a USB hub.

! Caution

- Do not connect a storage device such as a hard drive or memory device.

3. HDMI 1 input terminal

- Use a commercially available HDMI cable (conforming to the HDMI standard) that supports 4K.
- This terminal does not support HDMI CEC.

4. TOUCH PANEL terminal 1 (for touch panel)

- To use the touch panel with a computer, connect the touch panel to the computer with a USB cable.
- To use this terminal, connect your computer to the HDMI 1 input terminal on the front of the monitor.

5. Audio input terminal

- Use an audio cable without resistance.
- When using this terminal for input, do not input audio from any other terminals.
- You cannot adjust the volume with volume adjustment. Please control volume on source device.

6. Digital audio output (optical) terminal

- Audio that is input into the monitor is output.
- Connect using a commercially available audio digital cable.
- The output sound varies depending on the input mode.
- You can adjust the volume with volume adjustment.

7. LAN terminal

- When Power Save Mode is Off, you can connect to a network and use the Wake on LAN function.

8. HDMI 2 input terminal

9. HDMI 3 input terminal

- Use a commercially available HDMI cable (conforming to the HDMI standard) that supports 4K.

10. RS-232C input terminal

- You can control the monitor from a computer by connecting a commercially available RS-232 straight cable between these terminals and the computer. The terminal on the monitor is a female-type connector.

11. Component input terminals (AV/YPBPR)

- Change the input mode to YPBPR.
- This can be used as a video input terminal. Connect to the [VIDEO] input terminal, and change the input mode to AV.

12. Audio input terminals (for Component input terminals)

13. Audio output terminal

- The output sound varies depending on the input mode.

14. TOUCH PANEL terminal 2 (for touch panel)

- To use the touch panel with a computer, connect the touch panel to the computer with a USB cable.
- To use this terminal, connect your computer to the video input terminal on the rear of the monitor.

15. SD card slot

- Insert an SD memory card or SDHC memory card. SD memory cards (up to 2GB) and SDHC memory cards (up to 32GB) are supported. The explanations in this manual refer to both SD memory cards and SDHC memory cards as "SD memory cards".
- Before removing an SD memory card, follow the steps for removal. (See page below.)

Supported SD memory cards

File System	FAT32
Capacity	Up to 32 GB (maximum file size 4 GB)

- Do not use an SD memory card with a security function or a write protection function.

16. D-sub 1 input terminal (VGA1)

17. D-sub 2 input terminal (VGA2)



18. D-sub output terminal

19. Audio input terminal 1

20. Audio input terminal 2

- Use an audio cable without resistance.

■ How to remove a USB flash drive or an SD memory card

1. In the home screen of APPLICATION mode, touch  and touch "Storage".
2. Touch  of the device you want to remove.

Connecting the Power Cord

! Caution

- Use only the power cord supplied with the monitor.
1. Turn off the main power switch.
 2. Plug the power cord (supplied) into the AC input terminal.
 3. Plug the power cord (supplied) into the power outlet.

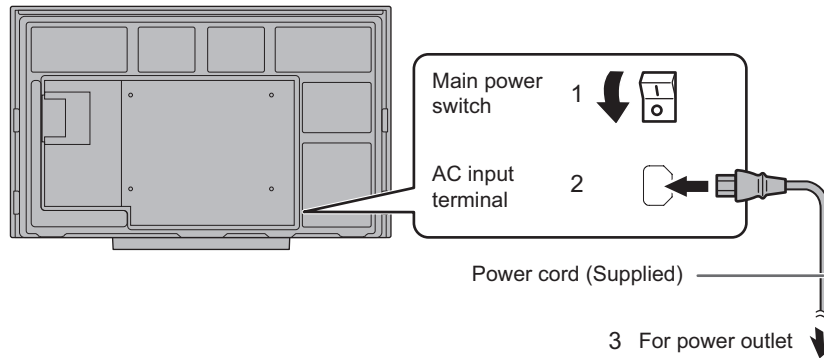

Binding Cables

The supplied cable clamps can be used to clamp the power cord and cables connected to the back of the monitor.

Attach the supplied cable clamps (affixing type) to a flat surface, removing any dust or dirt before attaching. Do not attach over a vent.

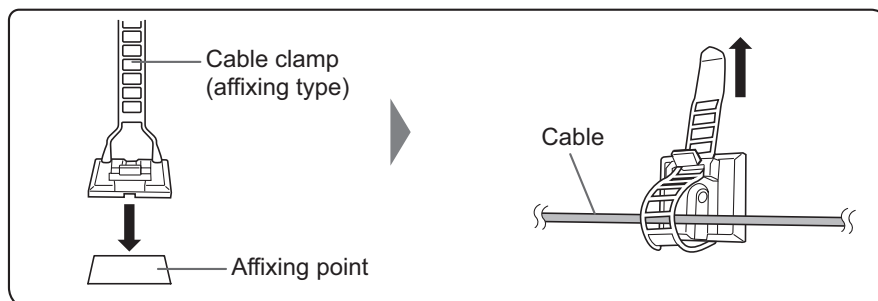

Preparing the Remote Control Unit

Installing the batteries

1. Place your finger on the part marked with the ▲, and then pull the cover off.

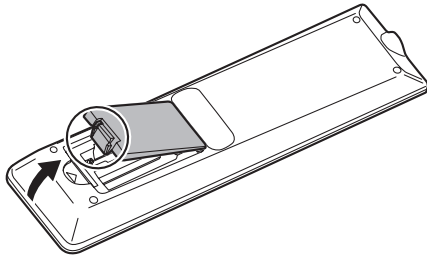

2. See the instructions in the compartment and put in the supplied batteries (R03 ("AAA" size) x 2) with their plus (+) and minus (-) sides oriented correctly.
3. Close the cover.

TIPS

- When the batteries become exhausted, replace them with new (commercially available) batteries.
- The supplied batteries may become exhausted quickly depending on how they are stored.
- If you will not be using the remote control for a long time, remove the batteries.
- Use manganese or alkaline batteries only.

Remote control operation range

The operation range of the remote control unit is approx. 16.4 feet (5 m) at an angle of approx 10° from the center to the top/bottom/right/left of the remote control sensor.

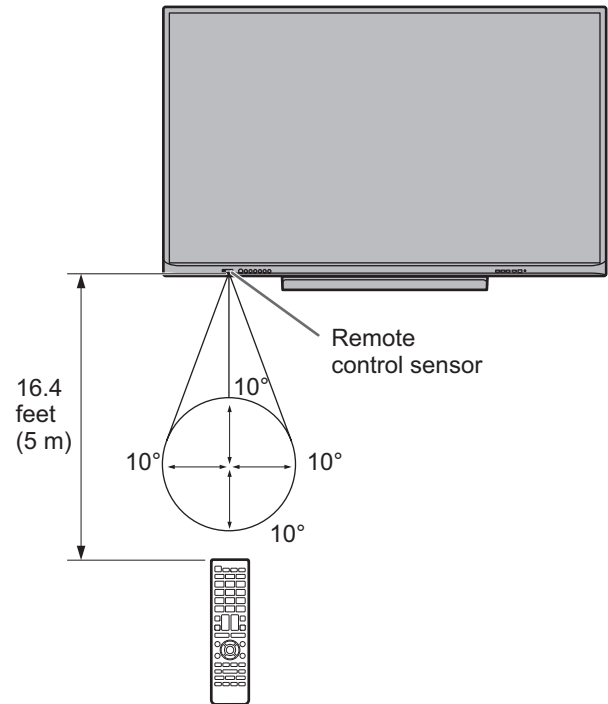

TIPS

- Do not expose the remote control unit to shock by dropping or stepping on it. This could lead to a malfunction.
- Do not expose the remote control unit to liquids, and do not place it in an area with high humidity.
- The remote control unit may not work properly if the remote control sensor is under direct sunlight or strong lighting.
- Objects between the remote control unit and the remote control sensor may prevent proper operation.
- Replace the batteries when they run low as this may shorten the remote control's operation range.
- If a fluorescent light is illuminated near the remote control unit, it may interfere with proper operation.
- Do not use it with the remote control of other equipment such as air conditioner, stereo components, etc.

Turning Power On/Off

! Caution

- Turn on the monitor first before turning on the computer or playback device.
- When switching the main power switch or the POWER button off and back on, always wait for at least 5 seconds. A short interval may result in a malfunction.

Turning on the main power

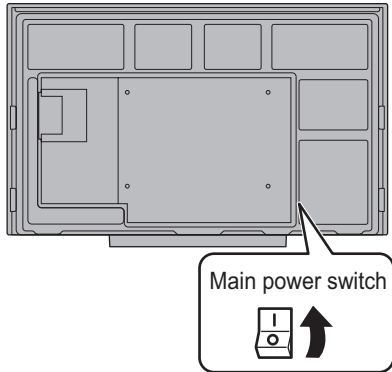

When you turn on the main power, the monitor enters standby mode.

! Caution

- The main power must be turned on/off with the main power switch. Do not connect/disconnect the power cord or turn the breaker on/off while the main power switch is on.
- For a complete electrical disconnection, pull out the main plug.

Turning power on/off

Press the POWER button to turn the power ON/OFF. You can also turn the power ON/OFF by pressing the MONITOR ON button/MONITOR OFF button on the remote control unit.

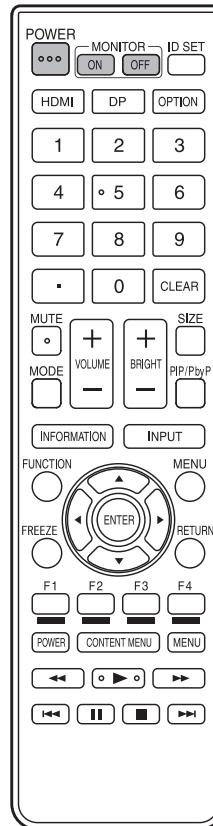

Power LED POWER button

Status	Status of the monitor
Blue lit	Power on
Red lit	Power off (Standby mode)

TIPS

- When the main power switch is off, the monitor cannot be turned on.

Touch action

Touch action

Touch actions that can be used with this monitor differ according to operating system and application. The functions of touch actions are also different. For details, check operating system Help and the application's support documentation.

Touch action	Operating system	
	Windows 8.1 / 10	Chrome OS
Single-tap	Yes	Yes
Double-tap	Yes	Yes
Swipe	Yes	Yes
Swipe from edge of screen	Yes	Yes
Drag-and-drop	Yes	Yes
Flicks	Yes	Yes
Press-and-hold	Yes	Yes
Slide to pan	Yes	Yes
Zoom	Yes	Yes
Press-and-tap	No	Yes
Rotate	Yes	Yes

TIPS

- On the Mac, the actions are the equivalent mouse actions.

■Common finger and touch pen actions

Single-tap

Same action as left-clicking a mouse.
Touch with your finger/touch pen.

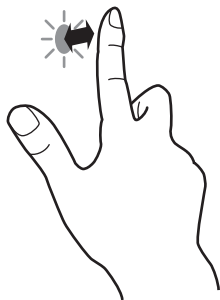

Double-tap

Same action as double-clicking a mouse.
Quickly touch twice with your finger/touch pen.

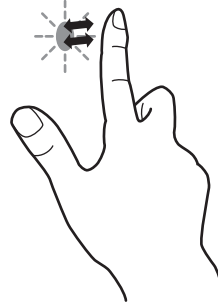

When double-tapping with your finger, be sure to lift your finger sufficiently off the screen after the first tap. If there is insufficient distance between the screen and your finger, double-tap will not take place.

Swipe

Touch the screen with your finger/touch pen, move without lifting, and then stop.

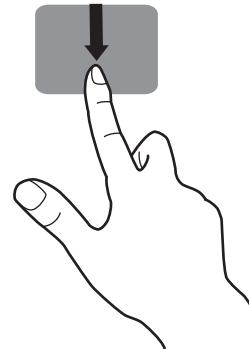

Swipe from edge of screen

After touching the edge of the monitor with your finger/touch pen, move horizontally without releasing your finger/touch pen and then stop.

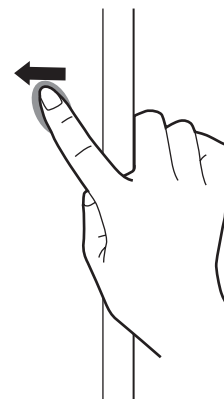

Touch action

Drag-and-drop

Same action as drag-and-drop with a mouse. Touch the screen with your finger/touch pen and move without lifting. When you have finished the movement, lift your finger/touch pen.

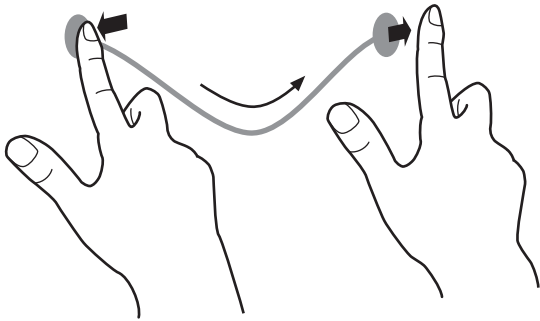

Flicks

Flick your finger/touch pen in the direction of the function you want to use.

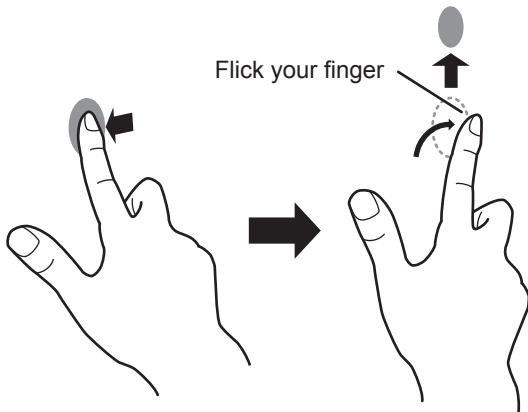

Press-and-hold

Same action as right-clicking a mouse. Press briefly with your finger/touch pen, and then lift your finger/touch pen from the screen.

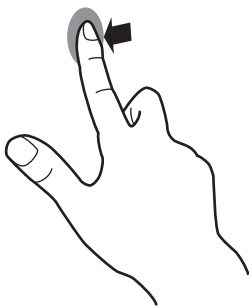

Slide to pan

With your finger/touch pen touching the screen, move it up and down to scroll the screen.

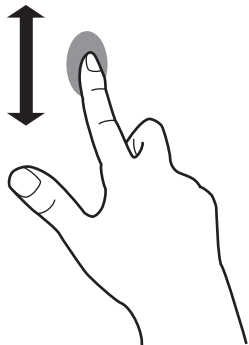

■ Finger actions

Zoom

Use in a screen that is capable of enlargement/reduction. Touch the screen with two fingers and move your fingers closer together to reduce the view, or apart to enlarge the view.

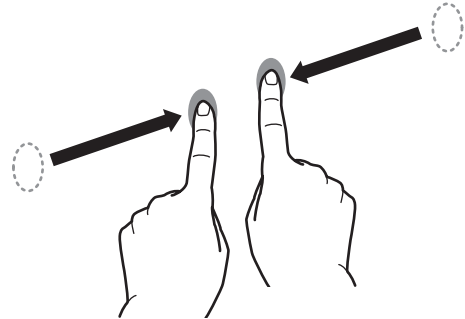

Reduction

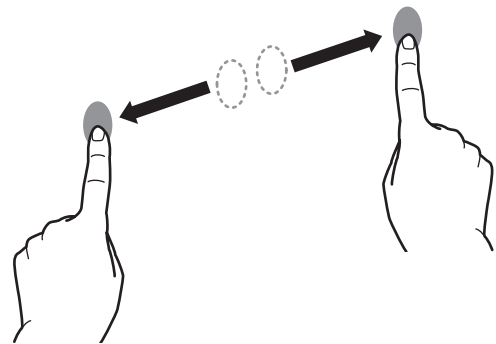

Enlargement

Press-and-tap

Same action as right-clicking a mouse. With one finger touching the screen, tap once (single tap) with another finger.

Tap once (single tap) with another finger

With one finger touching

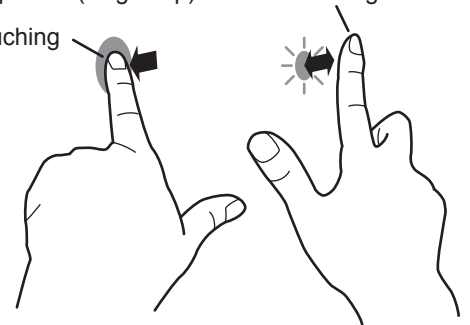

Rotate

Use this action in a screen that is capable of image rotation. Touch the center point of the rotation with one finger. While holding that finger still, move another finger in the desired direction of rotation.

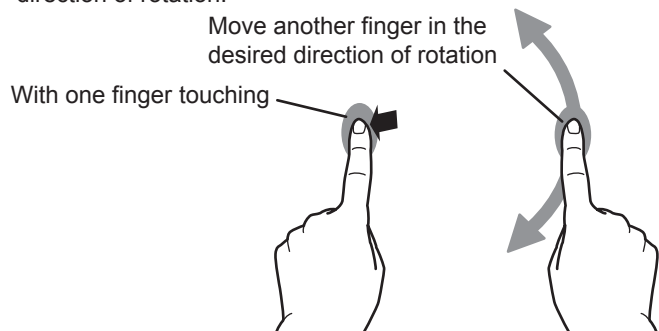
**TIPS**

- The screen may not respond correctly in the following cases:
 - Touch gesture is too quick.
 - The distance between the two points is too short.
 - The two points intersect.

Other functions

In Windows 8.1/10, input panel functions can be used. For details, see Windows Help.

Input panel :

A software keyboard and an input panel with handwriting recognition appear on the screen.

In Windows 8.1/10, the ink function of Microsoft Office can be used.

Handwritten comments can be written, and handwriting can be recognized.

For details, see Microsoft Office Help.

Cautionary points

- Do not use the touch pen for any purpose other than touch panel operation.
- Do not press hard on the pen tip.
- Operation will not take place correctly if there is an obstacle between the infrared transmitter/receiver and the touch pen or your finger. Operation will not take place correctly if your fingers or your sleeve is near the screen.
- If the touch pen is held too flat against the screen, the touch position may not be correctly detected.
- If the touch pen does not work at the edge of the screen, move it slowly.
- If the pen tip becomes worn or damaged, replace the touch pen. To purchase a new touch pen, consult your dealer.
- This may not operate correctly if there is an inverter fluorescent light nearby.
- If there is dirt or foreign matter on the tip of the touch pen, remove it. Foreign matter may damage the screen.
- The touch pen position may occasionally deviate in the login screen. In this case, use the keyboard or mouse.
- If the USB cable becomes disconnected, the touch panel may not operate correctly after the USB cable is reconnected. In this case, restart the computer.
- When removing the pen tip or your finger from the screen, remove a sufficient distance. If the distance is not sufficient, a touch may be detected even if the screen is not touched.





Basic Operation

About the home screen of APPLICATION mode

This appears when the input mode is changed to APPLICATION.









(1) You can check the currently input video.
Change the input terminal with the menu at the bottom. Touch to change to the currently displayed input.

- (2)  : Start the Drawing. (See page 24.)
 : Start LocalMM. (See page 26.)
 : Start File Explorer (See page 28.)
 : Start EShareServer. (See page 29.)
 : Display the Settings screen. (See page 30.)

Using the side menu

To show the menu, swipe from the edge (left or right) of the screen.

-  : Go back to the previous screen.
 : Return to the home screen of APPLICATION mode.
 : Display the change input menu. (See page 22.)
 : Display the video settings menu. (See page 30.)
 : Drawing starts in Overlay mode.
 : Display the volume menu.
 : Display the brightness menu.

Using the remote control unit

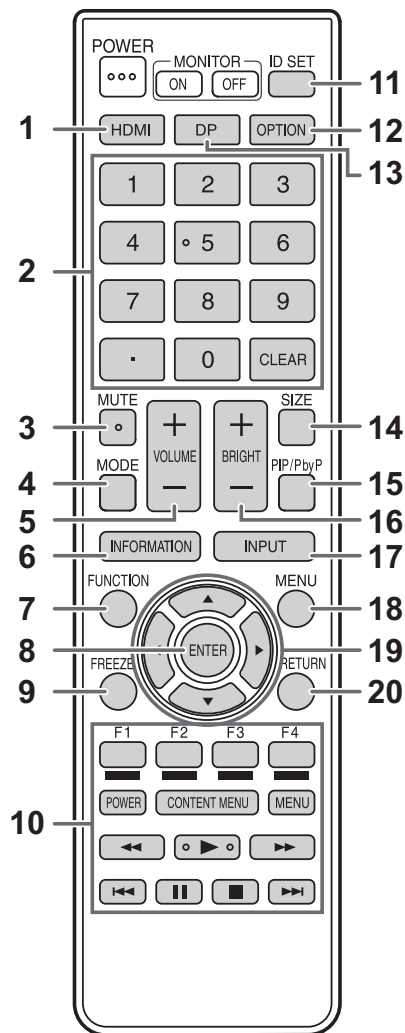

1. HDMI

Switch the input mode to HDMI 1, HDMI 2 or HDMI 3.

2. Numeric input buttons

These buttons are used for setting such as LAN setting.

3. MUTE

Turns off the volume temporarily.

Press the MUTE button again to turn the sound back to the previous level.

4. MODE (Display mode selection)

In video input mode (other than APPLICATION), each time you press this button, the picture mode changes in the following order:

STD (Standard) → Soft → High Illuminance → STD...

- High Illuminance is a display with colors suited to bright locations.

5. VOLUME +/- (Volume adjustment)

Press + or - to adjust the volume.

6. INFORMATION

In video input mode (other than APPLICATION), use this to display the input terminal and the signal.

7. FUNCTION

Use this to display the FUNCTION menu. (See page 36.)

8. ENTER

Confirms the setting.

9. FREEZE

Freezes the video shown on the monitor.

To cancel, press any button other than the POWER button, MUTE button or VOLUME button.

In some cases a residual image may occur. Do not freeze the video for a long time.

10. Buttons for LocalMM or operating the HDMI-connected device

When used in LocalMM, the buttons that can be used vary depending on the file that is played.

When HDMI CEC is set to On, only the POWER button is enabled for the device connected through the HDMI interface.

11. ID SET

This is not used with this monitor.

12. OPTION

Switch the input mode to APPLICATION or OPS.

13. DP (DisplayPort)

This is not used with this monitor.

14. SIZE (Screen size selection)

In video input mode (other than APPLICATION), each time you press this button, screen size is changed. (See page 23.)

15. PIP/PbyP

This is not used with this monitor.

16. BRIGHT +/- (Brightness adjustment)

Press + or - to adjust the brightness.

Basic Operation

17. INPUT (Input mode selection)

The menu is displayed.

Press the ▲ or ▼ button to select the input mode, and press the ENTER button to enter.

Input mode	Video	Audio
APPLICATION	APPLICATION	APPLICATION
OPS	Expansion slot	Expansion slot
HDMI 1	HDMI 1 input terminal	HDMI 1 input terminal
HDMI 2	HDMI 2 input terminal	HDMI 2 input terminal
HDMI 3	HDMI 3 input terminal	HDMI 3 input terminal
VGA1	D-sub 1 input terminal	Audio input terminal 1
VGA2	D-sub 2 input terminal	Audio input terminal 2
AV	VIDEO input terminal	Audio input terminals
YPBPR	Component input terminals	Audio input terminals

18. MENU

Displays the menu screen. (See page 30.)

19. Cursor

These buttons are used to perform operations such as selecting items, changing adjustment values, and moving the cursor.

20. RETURN

Returns to the previous screen.

■ Switching the screen size

Even when the screen size is changed, the display may remain the same depending on the input signal.

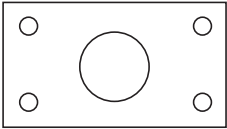
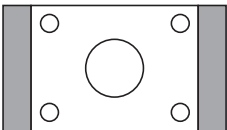
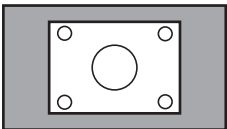
16:9		<p>Displays the image with an aspect ratio of 16:9 so it fills the entire screen. Use with 16:9 signals such as 3840 × 2160, 1920 × 1080 or 1280 × 720.</p>
4:3		<p>Displays the image with an aspect ratio of 4:3 so it fills the entire screen. Use with 4:3 signals such as 640 × 480, 800 × 600, or 1024 × 768. When showing such as 16:9 video, the width of the image will be shrunk.</p>
Dot by Dot		<p>Displays the dots of the input signals as the corresponding dots on the screen.</p>

TIPS

- Using this monitor's screen-size switching function to compress or expand the screen for commercial or public viewing in establishments like cafes or hotels may infringe on the rights of the creators, as protected by Copyright Law, so please be careful.
- The appearance of the original video may change if you select a screen size with a different aspect ratio than the original image (e.g. TV broadcast or video input from external equipment).
- When playing commercial software, parts of the image (like subtitles) may be cropped. In this case select the optimal screen size using the screen-size switching function of this monitor. With some software, there may be noise or distortion at the edges of the screen. This is due to the characteristics of the software, and is not a malfunction.
- Depending on the original video size, black bands may remain at the edges of the screen.

Drawing

For Drawing, there are Whiteboard mode and Overlay mode.
In this application, the data of one screen is referred to as a “sheet”.

Whiteboard mode

You can use the screen as a whiteboard.

There are two drawing modes: pen mode and brush mode. You can draw on up to 10 sheets in pen mode, and up to 5 sheets in brush mode.

Overlay mode

The board is shown as transparent.

Your drawing will appear on the transparent board placed over the screen, so that you can write comments directly on the items displayed on the screen. Note, however, that you cannot operate the screen shown behind the transparent board.

Video input from the HDMI terminals cannot be saved.

Only 1 sheet.

- The drawn lines and the images pasted on the board are handled in the software as an “object”.
- You can display an image file, and write/draw letters and lines on the image.

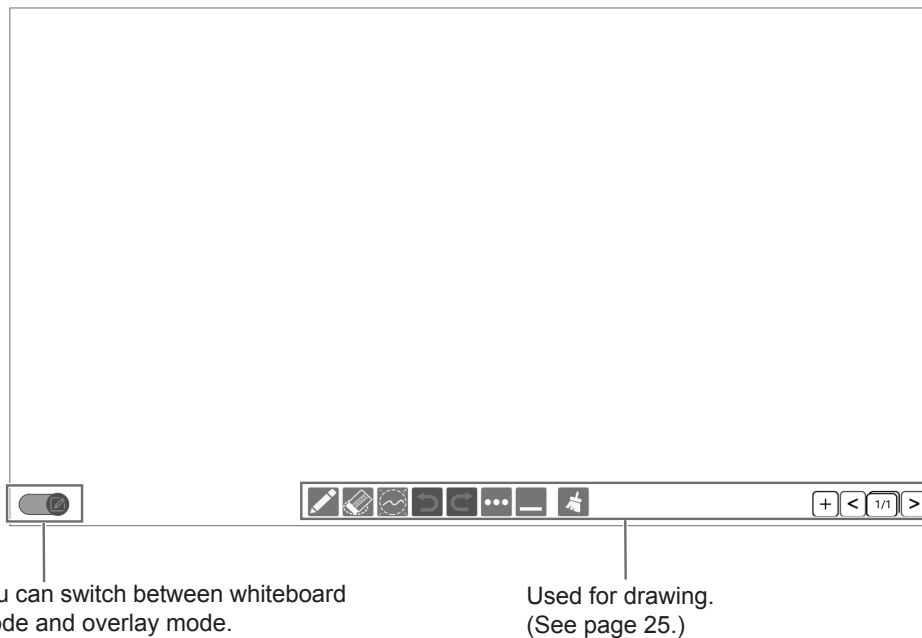





! Caution

- When the power is turned off, any data in Drawing is lost.

Drawing















1. In whiteboard mode, select the pen to be used for drawing (see step 2), and select the sheet to be drawn.

Tool	Function
	Add a new sheet behind the currently displayed sheet.
	Display the previous sheet.
	Shows the current sheet number and the total number of sheets. Touch to show a list (thumbnails) of the sheets on the right side of the screen. You can touch a thumbnail to go to that sheet. To delete that sheet, touch  .
	Display the next sheet.

2. Draw.

Select such as drawing tool to draw. You can perform the following operations.

- The type that can be used varies depending on whiteboard or overlay board and the pen type.

Tool	Function
 Pen	Draw a line of even width. You can change the settings (line width/color). The drawn lines are handled in the software as an “object”. You can touch with the flat part of your finger or palm of your hand to automatically change to an eraser.
 Brush	Brush a line as wide as the part of the screen you are touching. (Whiteboard only)
 Object eraser	Select and delete objects in the selected location. (Only when drawing by “Pen” mode in whiteboard) When selecting, you cannot simply touch the object itself that you want to delete. To select the object, trace over the object.
 Eraser	Erase a drawn line. The size of the eraser varies by the area of the screen touched.
	Select objects in the selected location. You can move or enlarge/reduce the object. (Only when drawing by “Pen” mode in whiteboard)
	Undo the previous drawing or edit. (Only when drawing by “Pen” mode in whiteboard)
	Redo an undone action. (Only when drawing by “Pen” mode in whiteboard)
	The sub-menu will appear.
	Save sheets.
	Read in an image. (Only when drawing by pen mode in whiteboard)
	Exit the application.
	Hide the application.
	Touch  to delete all content from the sheet you are drawing.

3. Touch  to exit.

LocalMM

You can play photo, music, and video files.

■ Supported formats

The types of files that can be played are as follows.

The operation of formats not indicated in the table is not guaranteed.

Photo files

Extension	Max. resolution
.jpg (.jpeg)	3840x2160
*.png	
*.bmp	

Music files

Extension	Sample rate	Maximum bit rate	Audio coding
*.mp3	32/44.1/48kHz	320kbs	MPEG-1,2,2.5 L3

Video files

Extension	Video coding	Max. resolution	Maximum bit rate
.mpg (.mpeg)	MPEG1/2 (MP@HL)	1920x1080@ 30fps	40Mbps
*.mp4	H.264 (MP/HP)	1920x1080@ 60fps	62.5Mbps
	HEVC/H.265 (MP)	4096x2160@ 60fps	100Mbps
	MPEG1/2 (MP@HL)	1920x1080@ 30fps	40Mbps
	MPEG4 (SP/ASP)	1920x1080@ 30fps	
*.mkv	H.264 (MP/HP)	1920x1080@ 60fps	62.5Mbps
	HEVC/H.265 (MP)	4096x2160@ 60fps	100Mbps
	MPEG1/2 (MP@HL)	1920x1080@ 30fps	40Mbps
	MPEG4 (SP/ASP)		
	VP8		
	VP9	4096x2160@ 60fps	100Mbps
*.webm	VP8	1920x1080@ 30fps	20Mbps
	VP9 (Profile0, 2)	4096x2160@ 60fps	100Mbps
*.3gp	H.264 (MP/HP)	1920x1080@ 60fps	62.5Mbps
	MPEG4 (SP/ASP)	1920x1080@ 30fps	40Mbps

Extension	Audio coding	Sample rate	Maximum bit rate
.mpg (.mpeg)	MPEG-1,2,2.5 L3	32/44.1/48kHz	320kbs
	MPEG-1,2 L2	16kHz - 48kHz	385kbs
	LPCM	8kHz - 48kHz	1.5Mbps
*.mp4	AAC, HEAAC	8kHz - 48kHz	AAC-LC: 576kbs V1: 288kbs V2: 144kbs
	MPEG-1,2,2.5 L3	32/44.1/48kHz	320kbs
*.mkv	MPEG-1,2,2.5 L3	32/44.1/48kHz	320kbs
	MPEG-1,2 L2	16kHz - 48kHz	385kbs
	AAC, HEAAC	8kHz - 48kHz	AAC-LC: 576kbs V1: 288kbs V2: 144kbs
*.webm	Vorbis (only stereo)	up to 48kHz	192kbs
*.3gp	AAC, HEAAC	8kHz - 48kHz	AAC-LC: 576kbs V1: 288kbs V2: 144kbs

- Both video codec and audio codec need to be supported.
- In some cases it may not be possible to play the above files.
- A maximum of 32 alphanumeric characters can be used for folder name and file name.
- Do not use a file that is over 4 GB.

Playing files

■ Playing files

1. Touch  in the home screen of APPLICATION mode.
2. Select the media with the file to be played.
3. Display the file you want to play and tap it.

The selected file starts playing.

You can narrow the type of file (photo[picture]/music/video) with the icon on the left side of the screen.

TIPS

- If there are files with same play format, the next file starts playing. The file is played in order of file name.
When playing photos, each photo is displayed at the size of the file's resolution. You can enlarge a photo with the Zoom Out function (see right).
- For operations during play, see right.

















■ To stop play

1. Press the RETURN button on the remote control unit.

Operations during play

When playback starts, you can display the operation bar in the bottom of the screen by swiping from the bottom edge of the screen.

You can perform the actions below while the operation bar is displayed.

Play  / Pause 	Play the current file. If Photo is selected, play slideshow. / Pause the playing file.
FB 	Fast backward playing the file. (Video only)
FF 	Fast forward playing the file. (Video only)
Prev. 	Go to the previous file.
Next 	Go to the next file.
RepeatRandom  / Repeat1file  / RepeatALL 	RepeatRandom: Play and repeat files in the playlist at random. Repeat1file: Play and repeat the current file. RepeatALL: Play and repeat files in order of the playlist. (Music only)
Playlist 	Show Playlist. (Music and Video only)
Info 	Show Playing file information.
Rotate (Clockwise) 	Rotate the current file 90 degrees clockwise temporarily. (Photo only)
Rotate (Anti-Clockwise) 	Rotate the current file 90 degrees Anti-clockwise temporarily. (Photo only)
Zoom In 	The file zooms in. (Photo only)
Zoom Out 	The file zooms out. (Photo only)
Playing settings 	video subtitle: You can change the subtitle display. video track: You can change multiplex audio. (Video only)

File Explorer

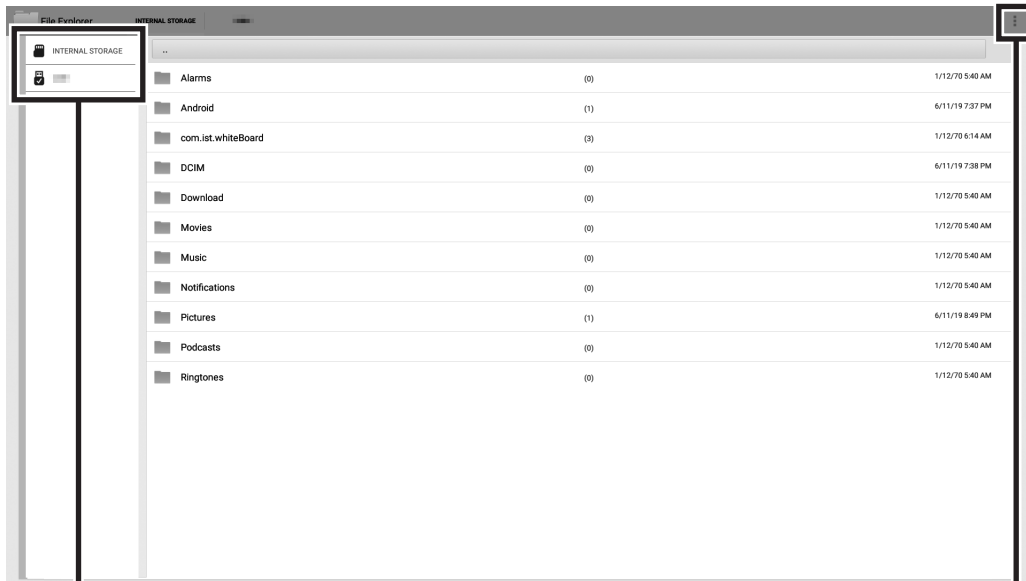

Select the memory you want to display.

Select a menu item.
You can perform actions such as sorting and creating a folder.

You can long press a folder or file to copy, move, rename, or delete.

Wireless Display

- You can display images from other devices on this monitor using wireless LAN.
You can capture the displayed image and set it to the background of a Drawing sheet.
- Software must be downloaded to the other device.
For details, see below.
- Connections to all devices is not guaranteed.

■ Wireless adapter connection

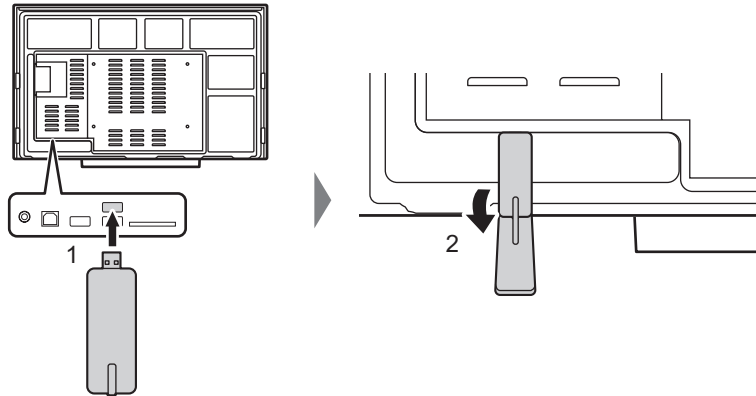

1. Connect the supplied wireless adapter to the USB port indicated below on the rear of the monitor.



! Caution

- When a wireless adapter is connected, please do not connect other USB device to the side USB port. That may cause malfunctions as the terminals may interfere with each other. Please use the front USB port for connecting other device.

■ Wireless LAN connection settings

1. Swipe from the edge (left or right) of the screen, touch  in the menu that appears, and touch .
2. Set Wireless LAN to On.
3. Configure the network connection settings in Wireless Setting.

■ Start EShareServer

1. Touch  in the home screen of APPLICATION mode.

■ Display the image that appears on the other device

The following explanation uses Windows (device) as an example.

1. Access the address shown in EShare on the monitor with your browser, and download the software to the other device whose screen is to be displayed.
2. Install and start the software you downloaded.
3. Check the name of the display shown in EShare on the monitor, select that name on the other device, and select "Share screen".
4. The other device connects to the monitor, and the image from the other device appears on the monitor.
5. Drawings are displayed in overlay mode.
You can draw on the displayed image and save the displayed image.

TIPS

- In Android, audio cannot be sent and touch operation cannot be used.

Menu Items

Displaying the menu screen

Video and audio adjustment and settings of various functions are enabled. This section describes how to use the menu items. See page 31 for details of each menu items.

! Caution

- Do not turn the main power switch off while the menu items are being displayed. Doing so may initialize the settings.

■ Display the video settings menu

1. Change to video input mode (other than APPLICATION).
2. Swipe from the edge (left or right) of the screen to display the menu.
3. Touch  to display the settings menu.

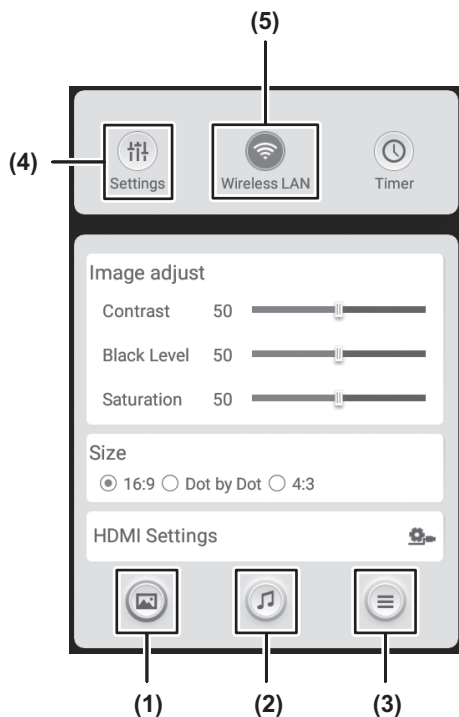

- (1) Image menu (See page 31.)
You can select this in video input mode (other than APPLICATION).
- (2) Sound menu (See page 32.)
- (3) Others menu (See page 32.)
- (4) Settings menu (See page 33.)
- (5) Wireless LAN menu (See page 29.)

In this screen, you can switch 5 menus by touching each icon.

4. Touch the icon of the desired menu.
5. Configure the setting for each item.

TIPS

- The menu will differ depending on the input mode.

■ Display other menus

1. In the home screen of APPLICATION mode, touch .



- Common: Display the Common Settings menu. (See pages 33 and 34.)
- Network: Configure LAN settings.
- Storage: Use to remove external media.
- Date: Set the date and time.
- Language: Set the display language.
- Reset: Execute reset.
- About Device: Show device information.

Menu item details

The menu will differ depending on the input mode.

■ Image ()

Image adjust

Contrast

Adjusts the difference between the bright and dark portions of the image.

Black Level

Adjusts the entire brightness of the video signals.

Saturation

Adjusts the color intensity.

Size

This is the same setting as when SIZE button is pressed. See page 23 for an explanation of the setting.

PC image adjustment (VGA[D-SUB])

Clock

Adjusts frequency for sampling clock for applicable video.

Adjust when there is flickering in the form of vertical stripes.

When using the adjustment pattern (see page 35), make adjustments so that no vertical stripe noise appears in it.

Phase

Adjusts sampling clock phase for applicable video. Useful when small characters appear with low contrast and/or there are flickers at corners. When using the adjustment pattern (see page 35), make adjustments so that no horizontal stripe noise appears in it.

* Adjustments to Phase should be made only after Clock has been correctly set.

H-POS

Adjust the horizontal position of the image.

V-POS

Adjust the vertical position of the image.

Auto adjust

The Clock, Phase, H-POS, and V-POS are automatically adjusted.

Pressing the ENTER button performs adjustment. Use this automatic adjustment when you use the VGA(D-SUB) to display a computer screen for the first time or when you change the setting of the computer. (See page 35.)

HDMI Settings (HDMI)

HDMI Mode

Use Mode1 normally.

If video is not displayed correctly when one of the HDMI1 to HDMI3 input terminals is used, such as when a device that do not support 4K is connected, set to Mode2.

HDMI RGB Input Range

Sets the RGB input signal range.

When using HDMI set to Auto, the RGB input signal range is detected automatically. Use Auto normally.

If the RGB input signal range cannot be set appropriately even when using Auto, set according to the image. When the setting is different, images will be displayed with washed out blacks and compressed gradients.

HDMI CEC

HDMI 1 input terminal does not support HDMI CEC.

On HDMI CEC function is used.

If the device connected to the HDMI input terminal supports CEC, power of the monitor is turned on when playback starts on the device.

Off HDMI CEC function is not used.

System Standby

Set whether the connected device enters standby mode when the monitor enters standby mode.

Device List

The name of the connected device appears.

Menu Items

■ Sound (🎵)

Audio

Bass

Adjusts the volume of bass-level sound.

Treble

Adjusts the volume of treble-level sound.

SPDIF

Set to ON to output PCM format on the digital audio output (optical) terminal.

■ Others (☰)

Source Identify (HDMI)

Set automatic input switching when a signal is input. Set to Auto to switch automatically, or set to Request to show the selection screen.

Eye protection

Set to On to have the screen brightness automatically decrease slightly when you touch the screen. If no action is performed for about 3 seconds, the screen returns to its original brightness.

■ Settings ()

Volume

Adjusts the volume.

Brightness

Set to Standard to fix the brightness. Set to Auto to have the brightness change automatically. Set to Energy Saving to fix the brightness at the middle value. Set to Auto/Energy Saving to change Eye protection to Off.

Startup and Shutdown

Startup Source

You can set the input mode that will be in effect when the power is turned on.

Specified Source

Set the input mode at startup when the Startup Source is set to Specified Source.

OPS boot

Only OPS Source..... When the input mode changes to OPS, turn on the power of the device in the expansion slot.

Any Source..... When the monitor power is turned on, turn on the power of the device in the expansion slot.

Close..... Do not automatically turn on the power of the device in the expansion slot.

Power Save Mode

When OFF is selected, Wake on LAN is enabled. Note, however, that more power will be consumed in standby mode.

When ON is selected, Wake on LAN is disabled. Note, however, that the startup time from standby mode becomes longer.

Time Settings

Automatic date & time

When connected to a LAN, set to On to automatically set the time to the network provided time.

Set date

When Automatic date & time is set to Off, set the date manually.

Set time

When Automatic date & time is set to Off, set the time manually.

Select time zone

Specify your time zone. Daylight saving time will be set automatically.

Use 24-hour format

Switch between 24-hour time and 12-hour time.

Language Settings

Language

Set the display language for the menu screen.

Mute With Freeze

Set whether or not audio turns off during freeze.

Backlight Off

When set to On, the backlight turns off. Audio does not turn off.

Off If No Operation

Off If No Operation

Determines whether or not to set the monitor to go into standby mode when there is no operation by the remote control unit, touch or RS-232C control.

Time

Set the time until standby mode is entered.

Menu Items

■ System setting

The main menu items not found in the setting menu (see page 33) are explained in this section.

Ethernet

Set whether or not to use LAN terminal. Set the IP address, subnet mask, and other settings.

Automatic acquisition of IP

If your LAN has a DHCP server and you wish to obtain an address automatically, select Automatic acquisition of IP.

Static IP

You can configure the following settings.

IP Address, Gateway, Subnet Mask, DNS 1, DNS 2

Proxy

Configure settings to use a proxy server.

Screen Lock Setting

You can lock the monitor with a password when the power is turned on.

Off If No Signal

This setting determines whether or not to set the monitor to go into standby mode if there is no signal or no operation is performed for 15 minutes.



Wallpaper

You can select wallpaper.

Adjustments for computer screen display

■Automatic adjustment

When you use the VGA(D-SUB) to display a computer screen for the first time, or when you change the setting of the computer, use the automatic screen adjustment.

1. **Switch the input to VGA1 or VGA2 and display the adjustment pattern.** (See the description below.)
2. **Swipe from the edge (left or right) of the screen to display the menu, and touch  -  - “PC image adjustment”.**
3. **Touch “Auto adjust”.**
The automatic adjustment is complete in several seconds.
4. **Press the RETURN button to close the menu screen.**

TIPS

- If the screen cannot be adjusted properly with one automatic adjustment, repeat the automatic adjustment two or three times. Try manual adjustment if necessary.

■Screen display for adjustment

Before making adjustments in the Image menu, display an image to brighten the entire screen. If you are using a Windows computer, use the adjustment pattern on the supplied CD-ROM.

Opening the adjustment pattern

The following example is performed in Windows 10.

1. **Load the supplied CD-ROM into the computer’s CD-ROM drive.**
2. **Open [CD Drive] in [This PC].**
3. **Double-click [Adj_uty.exe] in the [Monitor] folder.**
The adjustment pattern will appear.
Adjust the screen automatically or manually.

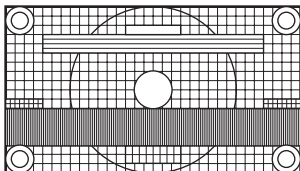

4. **When adjustment is finished, press the [Esc] on the computer’s keyboard to quit the adjustment program.**
5. **Eject the CD-ROM from the CD-ROM drive.**

TIPS

- If the display mode on the computer you are using is 65000 colors, the color levels in the color pattern may appear differently or grayscale may appear to be colored. (This is due to the specifications of the input signal and is not a malfunction.)

Functional Restriction Setting (Function)

You can restrict operations.

1. Press the **FUNCTION** button, and then press the **MENU** button within 10 seconds.



2. Select and set the items.

RC Lock

You can disable the remote control buttons.

OFF Enables operation.

ON 1 Disables all remote control operations.

ON 2 Disables all remote control operations other than POWER button (turning power on/off) and VOLUME +/- button (volume adjustment).

Monitor Lock

You can disable the monitor buttons.

3. Press the **RETURN** button to return to the normal screen.

TIPS

- Even if set RC Lock to ON 1 or Monitor Lock to ON, POWER button is enabled during standby mode.

Controlling the Monitor with a computer (RS-232C)

You can control this monitor from a computer via RS-232C (COM port) on the computer.

Computer connection

Connect with RS-232 straight cable between the computer's COM port (RS-232C connector) and the RS-232C input terminal on the monitor. The terminal on the monitor is a female-type connector.

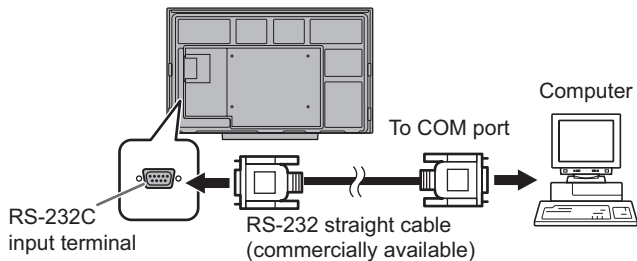

Communication conditions

Set the RS-232C communication settings on the computer to match the monitor's communication settings as follows:

Baud rate	9600bps
Data length	8 bits
Parity bit	None

Stop bit	1 bit
Flow control	None

Communication procedure

■ Command format

When a command is sent from the computer to the monitor, the monitor operates according to the received command and sends a response message to the computer.

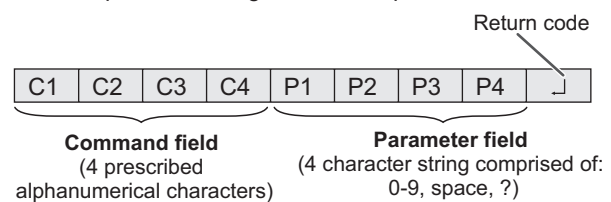

Example: VOLM0030
VOLM _ _ 30

- * Be sure to input 4 characters for the parameter. Pad with spaces (" ") if necessary.
(" " is a return code (0DH, 0AH or 0DH))
Wrong : VOLM30
Right : VOLM _ _ 30

If a command has "R" listed for "Direction" in the "RS-232C command table" on page 39, the current value can be returned by using "?" as the parameter.

Example:

VOLM ? ? ? ? ← From computer to monitor (How much is current volume setting?).

30 ← From monitor to computer (Current volume setting: 30).

TIPS

- Send Command field, Parameter field and Return code at the same time. When sending a command manually in 1 character units and it takes more than 2 seconds, the command function does not work.

Controlling the Monitor with a computer (RS-232C)

■Response code format

When a command has been executed correctly

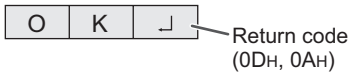

A response is returned after a command is executed.

When a command has not been executed

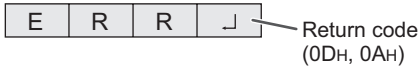

TIPS

- "ERR" is returned when there is no relevant command or when the command cannot be used in the current state of the monitor.
- If communication has not been established for reasons such as a bad connection between the computer and monitor, nothing is returned (not even ERR).
- "ERR" may be returned when a command cannot be received correctly due to interference from the surrounding environment. Please ensure that the system or software resends the command if this occurs.

If execution of the command is taking some time



When the following commands are used, "WAIT" is returned. In this case, a value will be returned if you wait a while. Do not send any command during this period.

- Commands which return WAIT:
RSET, POWR, INPS, WIDE, BOMD

■Communication interval

- After OK or ERR is returned, you must send the following commands.
To set a timeout for the command response, specify 10 seconds or longer.
- Provide an interval of 100 ms or more between the command response and the transmission of the next command.

VOLM0020
OK

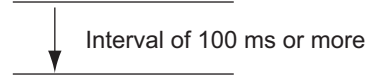

INPS0002
WAIT
OK

TIPS

- When ALL RESET is executed, the monitor enters standby mode. Wait at least 1 minute before sending the next command. If you execute power "On" after ALL RESET, it will take time for the monitor to start up, so wait at least 5 minutes before sending the next command.
- Before sending a power "On" or "Off" command, it is recommended that you perform buffer clear at the sending application side.
- After executing a power "On" or "Off" command, wait at least 1 minute before sending the next command.

RS-232C command table

How to read the command table

- Command: Command field (See page 37.)
- Direction: W When the "Parameter" is set in the parameter field (see page 37), the command functions as described under "Control/Response Contents".
 R The returned value indicated under "Reply" can be obtained by setting "???" or "???" in the parameter field. (See page 37.)
- Parameter: Parameter field (See page 37.)
- Reply: Response (Returned value)

TIPS

- In the standby mode, the only command that is used is Power control.

Power control/Input mode selection

Function	Command	Direction	Parameter	Reply	Control/Response contents	
Power control	POWR	W	0		Switches to standby mode.	
			1		Returns from standby mode.	
		R		0		Standby mode
				1		Normal mode
Input mode selection	INPS	W	0		Toggle change for input mode.	
			2		VGA1	
			3		YPBPR	
			4		AV	
			10		HDMI 1	
			13		HDMI 2	
			16		VGA2	
			18		HDMI 3	
			21		OPS "ERR" when nothing is attached in the expansion slot.	
			24		APPLICATION	
		R	2		VGA1	
			3		YPBPR	
			4		AV	
			10		HDMI 1	
			13		HDMI 2	
			16		VGA2	
			18		HDMI 3	
			24		APPLICATION	

Image menu

Function	Command	Direction	Parameter	Reply	Control/Response contents
BRIGHT	VLMP	WR	0-100	0-100	"ERR" when Auto and Energy Saving are in effect.
SIZE (Screen size selection)	WIDE	W	0	0	Toggle change for input mode.
		WR	1-3	1-3	1: 16:9, 2: Dot by Dot, 3: 4:3

Settings menu

Function	Command	Direction	Parameter	Reply	Control/Response contents
VOLUME	VOLM	WR	0-100	0-100	
MUTE AUDIO	MUTE	WR	0-1	0-1	0: OFF, 1: ON

Controlling the Monitor with a computer (RS-232C)

Others

Function		Command	Direction	Parameter	Reply	Control/Response contents
INFORMATION	Model	INF1	R		Value	
	Serial no.	SRNO	R		Value	
ALL RESET		RSET	W	0		ALL RESET
BACKLIGHT OFF		BOMD	W	0		Turn backlight off
				1		Turn backlight on
		R		0		Backlight off
				1		Backlight on
Check the resolution		PXCK	R		-	Returns current resolution in the form of hhh, vvv.

Troubleshooting

If you are experiencing any problem with your display, before calling for service, please review the following troubleshooting tips.

There is no picture or sound.

- The power LED is off.
 - Is power supplied to this monitor?
 - Is the power cord disconnected? (See page 14.)
 - Is the main power switch off? (See page 16.)
- The power LED lights red.
 - This monitor is in standby mode. Turn on the power. (See page 16.)

Remote control does not work.

- Are the batteries inserted with polarity (+,-) aligned? (See page 15.)
- Are the batteries exhausted?
- Point the remote control unit toward the monitor's remote control sensor. (See page 15.)
- Is operation with the remote control unit disabled? (See page 36.)

The remote control unit's buttons for operating the HDMI-connected device do not work.

- Is HDMI CEC set to On under HDMI Settings on the Image menu?
- On this monitor, only the POWER button is enabled.
- Switch to a different input mode, and then try switching the input mode back to HDMI.

Sound from left and right speakers is reversed.

Sound is heard from only one side.

- Are audio cables connected properly?

There is a picture but no sound.

- Is the sound muted?
- Make sure the volume is not set to minimum.
- Are audio cables connected properly?

Unstable video.

- The signal may be incompatible.
- Try the automatic screen adjustment when VGA(D-SUB) is in use.

The video from the HDMI input terminal does not appear properly.

- Does the HDMI cable support 4K, and is it HDMI standard compliant? The monitor will not work with cables that are not standard compliant.
- Is the input signal compatible with this monitor? (See pages 45 and 46.)
- When connecting a device that does not support 4K Vsync 50/60 Hz signals, set the HDMI Mode to Mode2.

The video from D-Sub input terminal does not appear correctly.

- Is the input signal compatible with this monitor? (See page 45.)

Control buttons do not work.

There is no picture.

- Load noises from outside may be interfering with normal operation. Turn off the main power and turn it on after waiting at least 5 seconds, and then check the operation.

The touch panel does not respond.

- Is the USB cable connected properly?
- Did you connect your computer to the video input terminal on the front when connected to TOUCH PANEL terminal 1 on the front, or to the video input terminal on the rear when connected to TOUCH PANEL terminal 2 on the rear?
- Is the Touch On/Off button set to Off?

Troubleshooting

The response of the touch panel is slow.

Some parts of the screen do not respond.

A different place is touched.

- Is the screen exposed to direct sunlight or other strong light? The touch panel uses infrared rays and thus may not operate correctly.
- Is there an obstacle between the infrared transmitter/receiver and the touch pen or your finger? An obstacle will prevent correct operation. If your fingers or a sleeve are too close to the screen, correct operation will not be possible.
- Is the infrared transmitter/receiver dirty? Gently wipe off any dirt with a soft cloth.
- If the touch panel is touched with a small tip less than about 5/16 inch (8 mm) x 5/16 inch (8 mm), the touch may not be detected by infrared and correct operation will not take place.
- When starting your computer or connecting the USB cable, do not touch the touch panel. If you touch the touch panel, this may be detected as an element failure in the infrared transmitter/receiver and incorrect operation will result.

The monitor makes a cracking sound.

- You may occasionally hear a cracking sound from the monitor. This happens when the cabinet slightly expands and contracts according to change in temperature. This does not affect the monitor's performance.

Specifications

■Product Specifications

Model		PN-CE701H
LCD component		70" Class [69-1/2 inch (176.56 cm) diagonal] TFT LCD
Max. resolution	(pixels)	3840 x 2160
Max. colors		Approx. 1.07 billion colors
Pixel pitch		0.40075 mm (H) × 0.40075 mm (V)
Brightness (typical)		350 cd/m ² *1
Contrast ratio (typical)		4000: 1
Viewing angle		176° right/left/up/down (contrast ratio ≥ 10)
Screen active area	inch (mm)	60-9/16 (W) x 34-1/16 (H) (1538.9 x 865.6)
Computer input signal		Analog RGB (0.7 Vp-p) [75 Ω]
Sync signal		Horizontal/vertical separate (TTL: positive/negative)
Plug and play		VESA DDC2B
Input terminals	Video	Mini D-sub 15 pin, 3 rows x 2 HDMI x 3 AV RCA *2 x 1 Component RCA *2 x 1
	Serial (RS-232C)	D-sub 9 pin x 1
	Audio	3.5 mm mini stereo jack x 3 RCA pin (L/R) x 1
USB		2.0 compliant (Type A) x 4 2.0 compliant (Type A) x 2 (for Expansion slot)
Output terminals	Video	Mini D-sub 15 pin, 3 rows x 1
	Audio	3.5 mm mini stereo jack x 1 Digital audio output (optical) x 1
System	CPU	Arm Cortex - A53 processor (quad core)
	Memory	1.5GB
	Storage	8GB
	SD card slot	SD/SDHC x 1
	LAN terminal	10 BASE-T/100 BASE-TX (Wake on LAN only)
Wireless LAN		IEEE802.11ac/n/a/g/b compliant (When a wireless adapter is connected)
Expansion slot		19 V, 4.74 A (power supplied when expanding the functions with an optional part)
Speaker output		10 W + 10 W
Touch Panel	Detection method	Infrared blocking detection method
	Computer connector	USB (2.0 compliant) (Type B) x 2
Power requirement		AC 100 - 240 V, 4.5 A, 50/60 Hz
Operating temperature *3 *4		41°F to 95°F (5°C to 35°C)
Operating humidity *4		20% to 80% (no condensation)
Power consumption (standby mode *5)		400 W *5 (0.5 W *6)
Dimensions	inch (mm) (excluding protrusions)	Approx. 64-1/8 (W) x 3-15/16 (D) x 39 (H) (1629 x 100 x 990)
Weight	lbs. (kg)	Approx. 119.0 (54)

*1 Brightness will depend on input mode and other picture settings. Brightness level will decrease over time. Due to the nature of the equipment, it is not possible to precisely maintain a constant level of brightness. This is the brightness of the LCD panel, not the brightness of the product.

*2 AV RCA and Component RCA cannot be used simultaneously.

*3 Temperature condition may change when using the monitor together with the optional equipments recommended by SHARP. In such cases, please check the temperature condition specified by the optional equipments.

*4 In addition, check the requirements of the computer and other devices to be connected, and make sure that all requirements are satisfied.

*5 When an option is installed in the expansion slot. When not installed, 295 W.

*6 When Power Save Mode is set to On.

When Power Save Mode is set to Off, and no optional part is attached: 2.0 W

As a part of our policy of continuous improvement, SHARP reserves the right to make design and specification changes for product improvement without prior notice. The performance specification figures indicated are nominal values of production units. There may be some deviations from these values in individual units.

Specifications

■ Dimensional Drawings

Note that the values shown are approximate values.

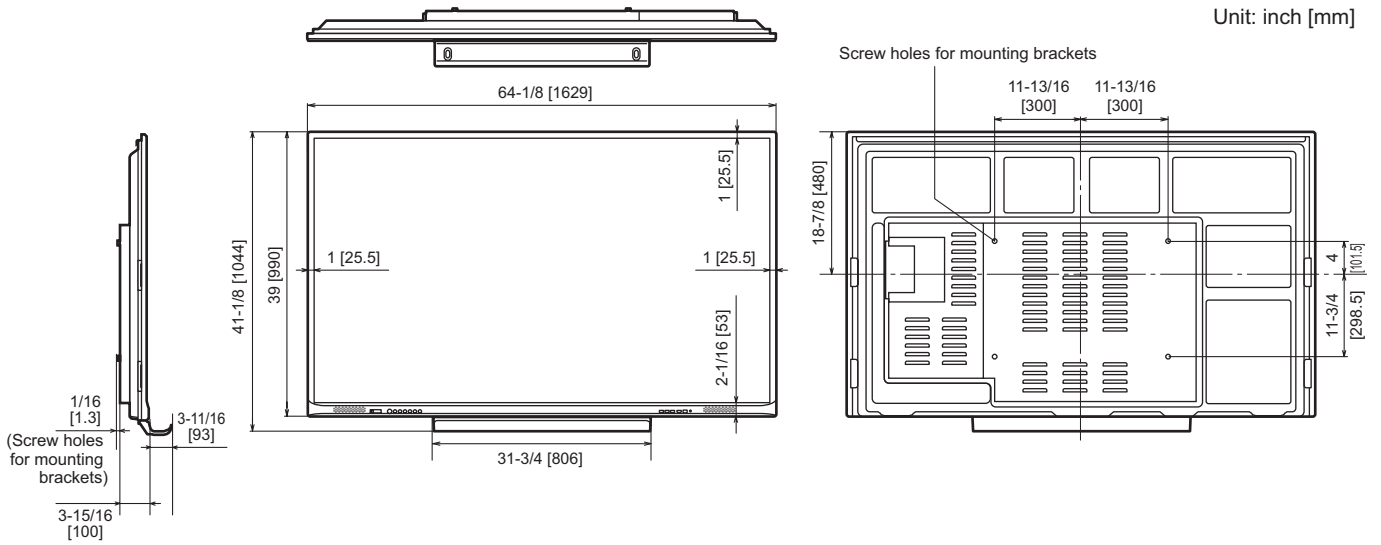

When mounting the monitor, be sure to use a wall-mount bracket that complies with the VESA-compatible mounting method. SHARP recommends using M6 screws and tighten the screws.

Note that screw hole depth of the monitor is 3/8 inch (10 mm). Loose mounting may cause the product to fall, resulting in serious personal injuries as well as damage to the product. The screw and hole should come together with over 5/16 inch (8 mm) length of thread. Use a bracket which has been approved for UL1678 standard, and which can endure at least 4 times or more the weight of the monitor.

■Compatible signal timing (PC)

Screen resolution		Hsync	Vsync	Frequency	Digital	Analog (D-sub)
					HDMI	
VESA	640 × 480	31.5kHz	60Hz	25.175MHz	Yes	Yes
		37.9kHz	72Hz	31.5MHz	Yes	Yes
		37.5kHz	75Hz	31.5MHz	Yes	Yes
	800 × 600	35.1kHz	56Hz	36.0MHz	-	Yes
		37.9kHz	60Hz	40.0MHz	Yes	Yes
		48.1kHz	72Hz	50.0MHz	Yes	Yes
		46.9kHz	75Hz	49.5MHz	Yes	Yes
	848 × 480	31.0kHz	60Hz	33.75MHz	-	Yes
	1024 × 768	48.4kHz	60Hz	65.0MHz	Yes	Yes
		56.5kHz	70Hz	75.0MHz	Yes	Yes
		60.0kHz	75Hz	78.75MHz	Yes	Yes
	1280 × 768	47.8kHz	60Hz	79.5MHz	-	Yes
		60.3kHz	75Hz	102.25MHz	-	Yes
	1280 × 800	49.7kHz	60Hz	83.5MHz	Yes	Yes
	1280 × 960	60.0kHz	60Hz	108.0MHz	Yes	Yes
	1280 × 1024	64.0kHz	60Hz	108.0MHz	Yes	Yes
		80.0kHz	75Hz	135.0MHz	Yes	Yes
	1360 × 768	47.7kHz	60Hz	85.5MHz	Yes	Yes
	1400 × 1050	65.3kHz	60Hz	121.75MHz	Yes	-
	1440 × 900	55.9kHz	60Hz	106.5MHz	Yes	Yes
1600 × 1200	75.0kHz	60Hz	162.0MHz	Yes	Yes	
1680 × 1050	65.3kHz	60Hz	146.25MHz	Yes	-	
1920 × 1200	74.0kHz	60Hz	154.0MHz	Yes	Yes	
Wide	1280 × 720	44.7kHz	60Hz	74.4MHz	Yes	Yes
	1920 × 1080	67.5kHz	60Hz	148.5MHz	Yes	Yes
	3840 × 2160	54.0kHz	24Hz	297.0MHz	Yes	-
		56.3kHz	25Hz	297.0MHz	Yes	-
		67.5kHz	30Hz	297.0MHz	Yes	-
		67.5kHz	50Hz ^{*2}	297.0MHz	Yes	-
		67.5kHz	60Hz ^{*2}	297.0MHz	Yes	-
	4096 × 2160 ^{*1}	54.0kHz	24Hz	297.0MHz	Yes	-
		54.0kHz	25Hz	297.0MHz	Yes	-
		54.0kHz	30Hz	297.0MHz	Yes	-
		54.0kHz	50Hz ^{*2}	297.0MHz	Yes	-
		54.0kHz	60Hz ^{*2}	297.0MHz	Yes	-
	US TEXT	720 × 400	31.5kHz	70Hz	28.3MHz	Yes

*1 Displays a reduced image even if set to Dot by Dot.

*2 Compatible when HDMI Mode is Mode1.

Specifications

Compatible signal timing (AV)

Screen resolution	Frequency	HDMI	Component
4096 × 2160p	24Hz	Yes	-
	25Hz	Yes*	-
	30Hz	Yes*	-
	50Hz	Yes	-
	59.94Hz	Yes	-
	60Hz	Yes	-
3840 × 2160p	24Hz	Yes	-
	25Hz	Yes	-
	30Hz	Yes	-
	50Hz	Yes	-
	59.94Hz	Yes	-
	60Hz	Yes	-
1920 × 1080p	24Hz	Yes	-
	50Hz	Yes	Yes
	59.94Hz	Yes	Yes
	60Hz	Yes	Yes
1920 × 1080i	50Hz	Yes	Yes
	59.94Hz	Yes	Yes
	60Hz	Yes	Yes
1280 × 720p	50Hz	Yes	Yes
	59.94Hz	Yes	Yes
	60Hz	Yes	Yes
720 × 576p	50Hz	Yes	Yes
720 × 480p	59.94Hz	Yes	Yes
	60Hz	Yes	Yes
640 × 480p(VGA)	59.94Hz	Yes	-
	60Hz	Yes	-
720(1440) × 576i	50Hz	Yes	Yes
720(1440) × 480i	59.94Hz	Yes	Yes
	60Hz	Yes	Yes

* Compatible when HDMI Mode is Mode2.

TIPS

- When the signal is displayed with the INFORMATION button during HDMI input, the signal will appear in the format "xxxxp", such as "2160p", rather than the format "3840 × 2160".

DDC (plug and play)

The monitor supports the VESA DDC (Display Data Channel) standard.

DDC is a signal standard for plug and play between monitors and computers. Information about resolution and other parameters is exchanged between the two. This function can be used if the computer supports DDC and it has been configured to detect plug-and-play monitors.

There are several types of DDC, depending on the communication method used. This monitor supports DDC2B.

■ Channels that can be used in wireless LAN

Standard	Channel	Frequency band (center frequency)
IEEE802.11 b/g/n	1-11ch	2412-2462MHz
IEEE802.11 ac/a/n	36/40/44/48ch	5180-5240MHz
	52/56/60/64ch	5260-5320MHz
	100/104/108/112/116/132/136/140ch	5500-5700MHz
	149/153/157/161/165ch	5745-5825MHz

This device is restricted to indoor use due to its operation in the 5.15 GHz to 5.25 GHz frequency range. FCC requires this product to be used indoors for frequency range 5.15 GHz to 5.25 GHz to reduce the potential for harmful interference to co-channel Mobile Satellite systems. High power radars are allocated as primary users of the 5.25 GHz to 5.35 GHz and 5.65 GHz to 5.85 GHz bands. These radar stations can cause interference with and/or damage this device.

Mounting Precautions (For SHARP dealers and service engineers)

- When installing, removing or moving the monitor, ensure that this is carried out by at least 3 people.
- Be sure to use a wall-mount bracket designed or designated for mounting the monitor.
- This monitor is designed to be installed on a concrete wall or pillar. Reinforced work might be necessary for some materials such as plaster / thin plastic board / wood before starting installation.
- This monitor and bracket must be installed on a wall which can endure at least 4 times or more the weight of the monitor. Install by the most suitable method for the material and the structure.
- To attach a VESA-compliant mounting bracket, use M6 screws that are 5/16 inch (8 mm) to 3/8 inch (10 mm) longer than the thickness of the mounting bracket.

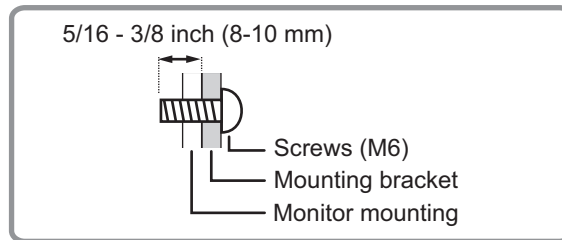

- Do not use an impact driver.
- When moving the monitor, be sure to hold the parts marked by  below. Do not grasp the screen or tray. This may cause product damage, failure, or injury.

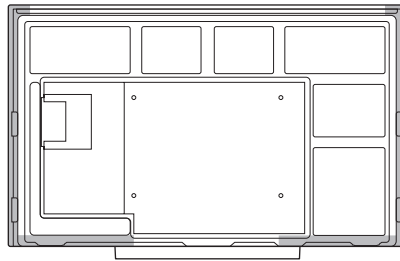

- If you need to temporarily place the monitor on a table or other surface during installation, spread a thick soft cloth on the table to prevent damage to the screen and table.
- Prior to repacking or removal, remove the tray.
- After mounting, please carefully ensure the monitor is secure, and not able to come loose from the wall or mount.
- Do not use any screw holes other than those for mounting brackets, located on the rear of the monitor, for installation.

Mounting Precautions (For SHARP dealers and service engineers)

■Attaching the Tray

Secure the tray using 5 tray mounting screws (M3x15) (supplied).

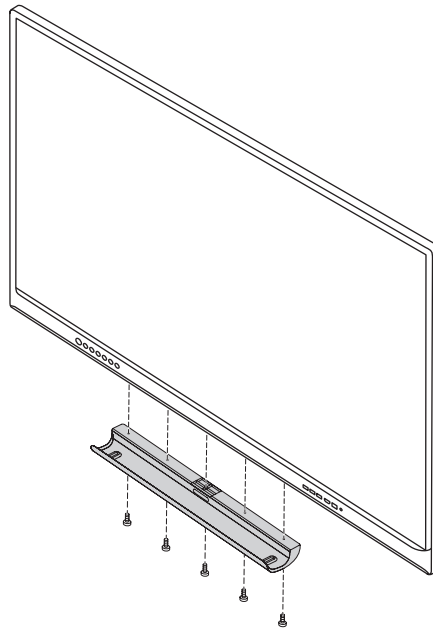

SHARP[®]
SHARP CORPORATION