

SHARP[®]

PN-Y555

PN-Y475

PN-Y425

LCD MONITOR

OPERATION MANUAL

Touchboards

205 Westwood Ave, Long Branch, NJ 07740

Phone: 866-94 BOARDS (26273) / (732)-222-1511

Fax: (732)-222-7088 | E-mail: sales@touchboards.com

HDMI

IMPORTANT:

To aid reporting in case of loss or theft, please record the product's model and serial numbers in the space provided. The numbers are located in the rear of the product.



Model No.:

Serial No.:

U.S.A. ONLY

IMPORTANT INFORMATION

WARNING: TO REDUCE THE RISK OF FIRE OR ELECTRIC SHOCK, DO NOT EXPOSE THIS PRODUCT TO RAIN OR MOISTURE.

	CAUTION RISK OF ELECTRIC SHOCK DO NOT OPEN	
CAUTION: TO REDUCE THE RISK OF ELECTRIC SHOCK, DO NOT REMOVE COVER. NO USER-SERVICEABLE PARTS INSIDE. REFER SERVICING TO QUALIFIED SERVICE PERSONNEL.		



The lightning flash with arrowhead symbol, within a triangle, is intended to alert the user to the presence of uninsulated "dangerous voltage" within the product's enclosure that may be of sufficient magnitude to constitute a risk of electric shock to persons.



The exclamation point within a triangle is intended to alert the user to the presence of important operating and maintenance (servicing) instructions in the literature accompanying the product.

WARNING:

FCC Regulations state that any unauthorized changes or modifications to this equipment not expressly approved by the manufacturer could void the user's authority to operate this equipment.

NOTE:

This equipment has been tested and found to comply with the limits for Class A digital device, pursuant to Part 15 of the FCC Rules. These limits are designed to provide reasonable protection against harmful interference when the equipment is operated in a commercial environment. This equipment generates, uses, and can radiate radio frequency energy and, if not installed and used in accordance with the instruction manual, may cause harmful interference to radio communications. Operation of this equipment in a residential area is likely to cause harmful interference in which case the user will be required to correct the interference at his own expense.

U.S.A. ONLY

DEAR SHARP CUSTOMER

Thank you for your purchase of a SHARP LCD product. To ensure safety and many years of trouble-free operation of your product, please read the Safety Precautions carefully before using this product.

SAFETY PRECAUTIONS

Electricity is used to perform many useful functions, but it can also cause personal injuries and property damage if improperly handled. This product has been engineered and manufactured with the highest priority on safety. However, improper use can result in electric shock and/or fire. In order to prevent potential danger, please observe the following instructions when installing, operating and cleaning the product. To ensure your safety and prolong the service life of your LCD product, please read the following precautions carefully before using the product.

1. Read instructions — All operating instructions must be read and understood before the product is operated.
2. Keep this manual in a safe place — These safety and operating instructions must be kept in a safe place for future reference.
3. Observe warnings — All warnings on the product and in the instructions must be observed closely.
4. Follow instructions — All operating instructions must be followed.
5. Cleaning — Unplug the power cord from the AC outlet before cleaning the product. Use a dry cloth to clean the product. Do not use liquid cleaners or aerosol cleaners.
6. Attachments — Do not use attachments not recommended by the manufacturer. Use of inadequate attachments can result in accidents.
7. Water and moisture — Do not use the product near water. Do not install the product in a place where water may splash onto it. Be careful of equipment which drains water such as an air-conditioner.
8. Ventilation — The vents and other openings in the cabinet are designed for ventilation. Do not cover or block these vents and openings since insufficient ventilation can cause overheating and/or shorten the life of the product. Do not place the product on a sofa, rug or other similar surface, since they can block ventilation openings. Do not place the product in an enclosed place such as a bookcase or rack, unless proper ventilation is provided or the manufacturer's instructions are followed.
9. Power cord protection — The power cords must be routed properly to prevent people from stepping on them or objects from resting on them.
10. The LCD panel used in this product is made of glass. Therefore, it can break when the product is dropped or applied with impact. Be careful not to be injured by broken glass pieces in case the LCD panel breaks.
11. Overloading — Do not overload AC outlets or extension cords. Overloading can cause fire or electric shock.
12. Entering of objects and liquids — Never insert an object into the product through vents or openings. High voltage flows in the product, and inserting an object can cause electric shock and/or short internal parts. For the same reason, do not spill water or liquid on the product.
13. Servicing — Do not attempt to service the product yourself. Removing covers can expose you to high voltage and other dangerous conditions. Request a qualified service person to perform servicing.
14. Repair — If any of the following conditions occurs, unplug the power cord from the AC outlet, and request a qualified service person to perform repairs.
 - a. When the power cord or plug is damaged.
 - b. When a liquid was spilled on the product or when objects have fallen into the product.
 - c. When the product has been exposed to rain or water.
 - d. When the product does not operate properly as described in the operating instructions.

Do not touch the controls other than those described in the operating instructions. Improper adjustment of controls not described in the instructions can cause damage, which often requires extensive adjustment work by a qualified technician.
 - e. When the product has been dropped or damaged.
 - f. When the product displays an abnormal condition. Any noticeable abnormality in the product indicates that the product needs servicing.
15. Replacement parts — In case the product needs replacement parts, make sure that the service person uses replacement parts specified by the manufacturer, or those with the same characteristics and performance as the original parts. Use of unauthorized parts can result in fire, electric shock and/or other danger.
16. Safety checks — Upon completion of service or repair work, request the service technician to perform safety checks to ensure that the product is in proper operating condition.
17. Wall mounting — When mounting the product on a wall, be sure to install the product according to the method recommended by the manufacturer.
18. Heat sources — Keep the product away from heat sources such as radiators, heaters, stoves and other heat-generating products (including amplifiers).

SAFETY PRECAUTIONS (Continued)

19. Batteries — Incorrect use of batteries may cause the batteries to burst or ignite. A leaky battery may corrode the equipment, dirty your hands or spoil your clothing. In order to avoid these problems, make sure to observe the precautions below:
 - Use the specified batteries only.
 - Install the batteries with due attention to the plus (+) and minus (-) sides of the batteries according to the instructions in the compartment.
 - Do not mix old and new batteries.
 - Do not mix batteries of different types. Voltage specifications of batteries of the same shape may vary.
 - Replace an exhausted battery with a new one promptly.
 - If you will not use the remote control for a long time, remove the batteries.
 - If leaked battery fluid gets on your skin or clothing, rinse immediately and thoroughly. If it gets into your eye, bathe your eye well rather than rubbing and seek medical treatment immediately. Leaked battery fluid that gets into your eye or your clothing may cause a skin irritation or damage your eye.
20. Usage of the monitor must not be accompanied by fatal risks or dangers that, could lead directly to death, personal injury, severe physical damage or other loss, including nuclear reaction control in nuclear facility, medical life support system, and missile launch control in a weapon system.
21. Do not stay in contact with the parts of the product that become hot for long periods of time. Doing so may result in low-temperature burns.
22. To prevent fire or shock hazard, do not expose this product to dripping or splashing. No objects filled with liquids, such as vases, should be placed on the product.
23. This product must only be connected to a 100-240V, 50/60Hz, grounded (3-prong) outlet.

WARNING:

- 1) This is a Class A product. In a domestic environment this product may cause radio interference in which case the user may be required to take adequate measures.
- 2) Batteries shall not be exposed to excessive heat such as sunshine, fire or the like.
- 3) To prevent injury, this apparatus must be securely attached to the floor/wall in accordance with the installation instructions.
- 4) An apparatus with CLASS I construction shall be connected to a MAIN socket outlet with a protective earthing connection.

To maintain compliance with EMC regulations, use shielded cables to connect to the following terminals: DVI-D input/output terminals, HDMI input terminal, D-sub input terminal, and RS-232C input/output terminals.

If a monitor is not positioned in a sufficiently stable location, it can be potentially hazardous due to falling. Many injuries, particularly to children, can be avoided by taking simple precautions such as:

- Using fixing devices like wall mount brackets recommended by the manufacturer.
- Only using furniture that can safely support the monitor.
- Ensuring the monitor is not overhanging the edge of the supporting furniture.
- Not placing the monitor on tall furniture (for example, cupboards or bookcases) without anchoring both the furniture and the monitor to a suitable support.
- Not standing the monitors on cloth or other materials placed between the monitor and supporting furniture.
- Educating children about the dangers of climbing on furniture to reach the monitor or its controls.

Especially for child safety

- Don't allow children to climb on or play with the monitor.
- Don't place the monitor on furniture that can easily be used as steps, such as a chest of drawers.
- Remember that children can become excited while watching a program, especially on a "larger than life" monitor. Care should be taken to place or install the monitor where it cannot be pushed, pulled over, or knocked down.
- Care should be taken to route all cords and cables connected to the monitor so that they cannot be pulled or grabbed by curious children.

IMPORTANT SAFETY INSTRUCTIONS

- 1) Read these instructions.
- 2) Keep these instructions.
- 3) Heed all warnings.
- 4) Follow all instructions.
- 5) Do not use this apparatus near water.
- 6) Clean only with dry cloth.
- 7) Do not block any ventilation openings. Install in accordance with the manufacturer's instructions.
- 8) Do not install near any heat sources such as radiators, heat registers, stoves, or other apparatus (including amplifiers) that produce heat.
- 9) Do not defeat the safety purpose of the polarized or grounding-type plug. A polarized plug has two blades with one wider than the other. A grounding type plug has two blades and a third grounding prong. The wide blade or the third prong are provided for your safety. If the provided plug does not fit into your outlet, consult an electrician for replacement of the obsolete outlet.
- 10) Protect the power cord from being walked on or pinched particularly at plugs, convenience receptacles, and the point where they exit from the apparatus.
- 11) Only use attachments/accessories specified by the manufacturer.
- 12) Use only with the cart, stand, tripod, bracket, or table specified by the manufacturer, or sold with the apparatus. When a cart is used, use caution when moving the cart/apparatus combination to avoid injury from tip-over.
- 13) Unplug this apparatus during lightning storms or when unused for long periods of time.
- 14) Refer all servicing to qualified service personnel. Servicing is required when the apparatus has been damaged in any way, such as power-supply cord or plug is damaged, liquid has been spilled or objects have fallen into the apparatus, the apparatus has been exposed to rain or moisture, does not operate normally, or has been dropped.



TIPS AND SAFETY INSTRUCTIONS

- The TFT color LCD panel used in this monitor is made with the application of high precision technology. However, there may be minute points on the screen where pixels never light or are permanently lit. Also, if the screen is viewed from an acute angle there may be uneven colors or brightness. Please note that these are not malfunctions but common phenomena of LCDs and will not affect the performance of the monitor.
- Do not display a still picture for a long period, as this could cause a residual image.
- Never rub or tap the monitor with hard objects.
- Please understand that SHARP CORPORATION bears no responsibility for errors made during use by the customer or a third party, nor for any other malfunctions or damage to this product arising during use, except where indemnity liability is recognized under law.
- This monitor and its accessories may be upgraded without advance notice.
- Do not use the monitor where there is a lot of dust, where humidity is high, or where the monitor may come into contact with oil or steam. Do not use in an environment where there are corrosive gases (sulfur dioxide, hydrogen sulfide, nitrogen dioxide, chlorine, ammonia, ozone, etc.). As this could lead to fire.
- Ensure that the monitor does not come into contact with water or other fluids. Ensure that no objects such as paper clips or pins enter the monitor as this could lead to fire or electric shock.
- Do not place the monitor on top of unstable objects or in unsafe places. Do not allow the monitor to receive strong shocks or to strongly vibrate. Causing the monitor to fall or topple over may damage it.
- Do not use the monitor near heating equipment or in places where there is likelihood of high temperature, as this may lead to generation of excessive heat and outbreak of fire.
- Do not use the monitor in places where it may be exposed to direct sunlight.
- Please be sure to constantly remove dust and garbage that has attached to the ventilation opening. If dust collects in the ventilation opening or the inside of the monitor, it may lead to excessive heat, outbreak of fire, or malfunction. Please request a cleaning of the inside of the monitor from an authorized SHARP servicing dealer or service center.
- Images cannot be rotated on this monitor. When using in portrait orientation, you will need to prepare appropriately orientated content in advance.
- The AC outlet shall be installed near the equipment and shall be easily accessible.

The Power Cord

- Use only the power cord supplied with the monitor.
- Do not damage the power cord nor place heavy objects on it, stretch it or over bend it. Also, do not add extension cords. Damage to the cord may result in fire or electric shock.
- Do not use the power cord with a power tap. Adding an extension cord may lead to fire as a result of overheating.
- Do not remove or insert the power plug with wet hands. Doing so could result in electric shock.
- Unplug the power cord if it is not used for a long time.
- Do not attempt to repair the power cord if it is broken or malfunctioning. Refer the servicing to the service representative.

Manual Scope

- Microsoft, Windows and Internet Explorer are registered trademarks of Microsoft Corporation.
- The terms HDMI and HDMI High-Definition Multimedia Interface, and the HDMI Logo are trademarks or registered trademarks of HDMI Licensing LLC in the United States and other countries.
- Adobe, Acrobat, and Reader are either registered trademarks or trademarks of Adobe Systems Incorporated in the United States and/or other countries.
- All other brand and product names are trademarks or registered trademarks of their respective holders.
- Language of OSD menu used in this manual is English by way of example.
- Illustrations in this manual may not exactly represent the actual product or display.
- This manual assumes use in landscape orientation, except where specifically noted.

LED Backlight

- The LED backlight in this product has a limited lifetime.
 - * If the screen gets dark or does not turn on, it may be necessary to replace the LED backlight.
 - * This LED backlight is exclusive to this product and must be replaced by an authorized SHARP servicing dealer or service center. Please contact an authorized SHARP servicing dealer or service center for assistance.

MOUNTING PRECAUTIONS

- This product is for use indoors.
- A mounting bracket compliant with VESA specifications is required.
- Since the monitor is heavy, consult your dealer before installing, removing or moving the monitor.
- Mounting the monitor on the wall requires special expertise and the work must be performed by an authorized SHARP dealer. You should never attempt to perform any of this work yourself. Our company will bear no responsibility for accidents or injuries caused by improper mounting or mishandling.
- Use the monitor with the surface perpendicular to a level surface. If necessary, the monitor may be tilted up to 20 degrees upward or downward.
- This monitor should be used at an ambient temperature between 32°F (0°C) and 104°F (40°C). Provide enough space around the monitor to prevent heat from accumulating inside.

- Adhere to the following when installing the monitor in its portrait orientation. Failing to adhere to the following may cause malfunctions.
 - Install the monitor such that the power LED is located on the bottom side.
 - Set the THERMAL SENSOR SETTING on the SETUP menu to PORTRAIT. (See page 27.)
- Use the supplied vertical sticker when you install the monitor in portrait orientation.

For the monitor in landscape orientation

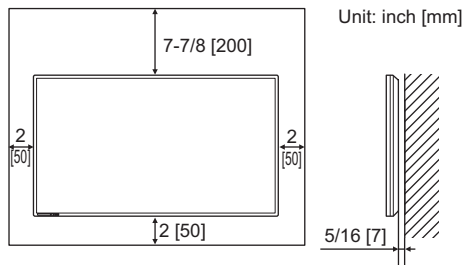

For the monitor in portrait orientation

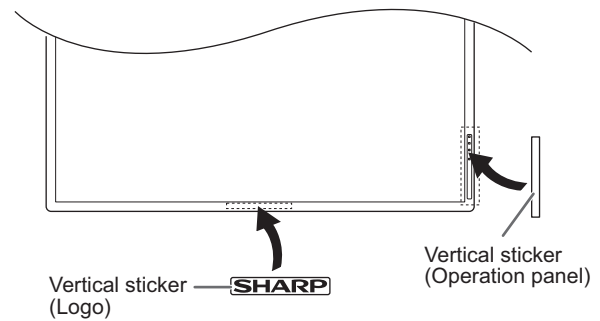
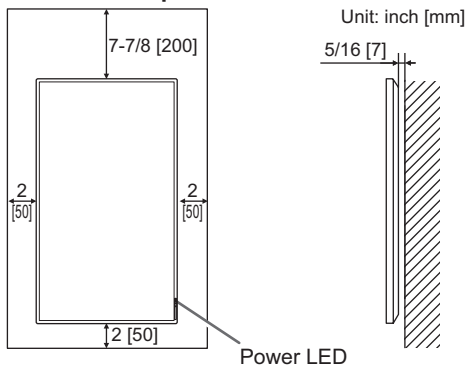

Do not remove the factory-affixed sticker but affix the sticker over it. Be careful not to cover the remote control sensor or buttons.

- If it is difficult to provide sufficient space for any reason such as the installation of the monitor inside a housing, or if the ambient temperature may be outside of the range of 32°F (0°C) to 104°F (40°C), install a fan or take other measures to keep the ambient temperature within the required range.
- Do not block any ventilation openings. If the temperature inside the monitor rises, this could lead to a malfunction.
- Do not place the monitor on a device which generates heat.

Contents

IMPORTANT INFORMATION	3	Playing the Files in a USB Flash Drive	21
DEAR SHARP CUSTOMER	4	Auto playback.....	21
SAFETY PRECAUTIONS	4	Playing files	21
IMPORTANT SAFETY INSTRUCTIONS	6	Playing files using the SCHEDULE function	22
TIPS AND SAFETY INSTRUCTIONS	7	Operations during play	23
MOUNTING PRECAUTIONS	8	Settings	23
Supplied Components	9	Menu Items	25
Part Names	10	Displaying the menu screen.....	25
Connecting Peripheral Equipment	12	Menu item details	26
Connecting the Power Cord	14	Controlling the Monitor with a PC (RS-232C)	32
Binding Cables	14	PC connection.....	32
Setting the USB flash drive cover	15	Communication conditions	32
Affixing the Stand Hole Protection Covers	15	Communication procedure	32
Preparing the Remote Control Unit	16	RS-232C command table.....	36
Installing the batteries	16	Controlling the Monitor with a PC (LAN)	38
Remote control operation range.....	16	Settings to connect to a LAN.....	38
Turning Power On/Off	17	Command-based control.....	39
Turning on the main power.....	17	Troubleshooting	40
Turning power on/off	17	Specifications	42
Basic Operation	19	Mounting Precautions (For SHARP dealers and service engineers)	48

Supplied Components

If any component should be missing, please contact your dealer.

- Liquid Crystal Display Monitor: 1
- Remote control unit: 1
- Cable clamp: 2
- Power cord: 1
- R-6 battery ("AA" size): 2
- CD-ROM (Utility Disk for Windows): 1
- Setup Manual: 1
- Vertical sticker (Logo): 1
- Vertical sticker (Operation panel): 1
- USB flash drive cover: 1
- USB flash drive cover screw: 1
- Model Name / Serial No. label: 1
 Indicates the model name and serial number.
- Cover SHARP logo: 1
 Place this sticker onto the SHARP logo to cover the logo.
- Stand hole protection cover: 2

* SHARP Corporation holds authorship rights to the Utility Disk program. Do not reproduce it without permission.

* For environmental protection!

Do not dispose of batteries in household waste. Follow the disposal instructions for your area.

Part Names

■ Front view

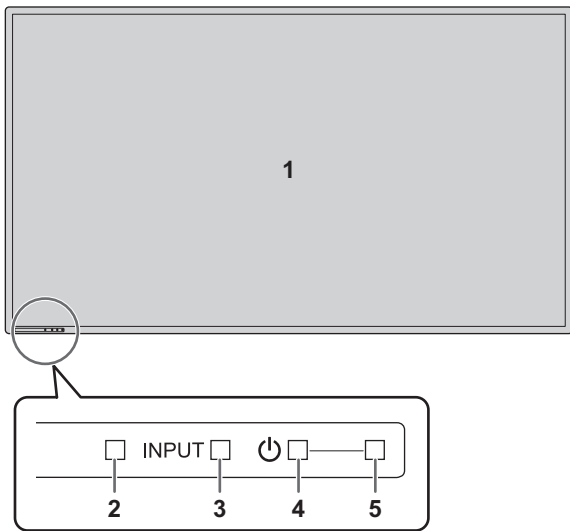

■ Rear view

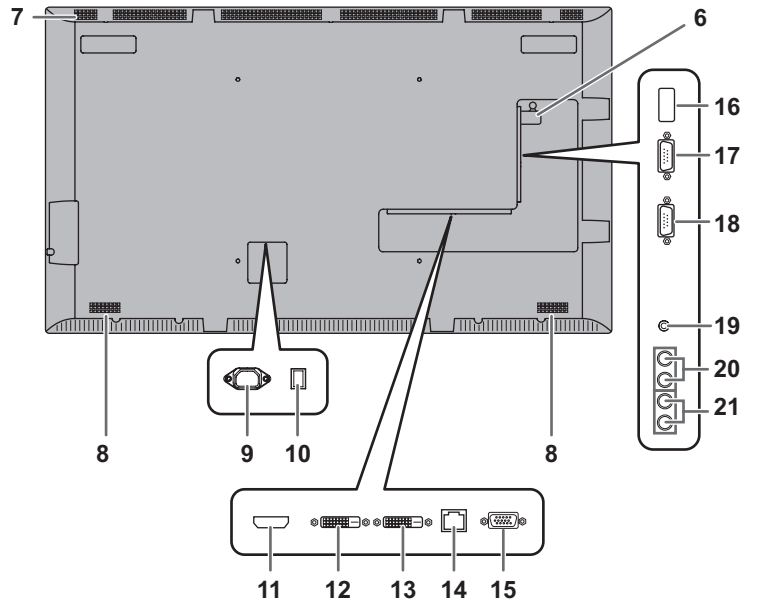

1. LCD panel
2. Remote control sensor (See page 16.)
3. Input switch (See page 19.)
4. Power button (See page 17.)
5. Power LED (See page 17.)

6. USB flash drive cover (See page 15.)
7. Vents
8. Speakers
9. AC input terminal (See page 14.)
10. Main power switch (See page 17.)
11. HDMI input terminal (See page 12.)
12. DVI-D input terminal (See page 12.)
13. DVI-D output terminal (See page 13.)
14. LAN terminal (See page 13.)
15. D-sub input terminal (See page 12.)
16. USB port (See page 12.)
17. RS-232C input terminal (See page 13.)
18. RS-232C output terminal (See page 13.)
19. Audio1 input terminal (See page 13.)
20. Audio output terminals (See page 13.)
21. Audio2 input terminals (See page 13.)

! Caution

- Consult your SHARP dealer for attachment/detachment of optional parts.

■ Remote control unit

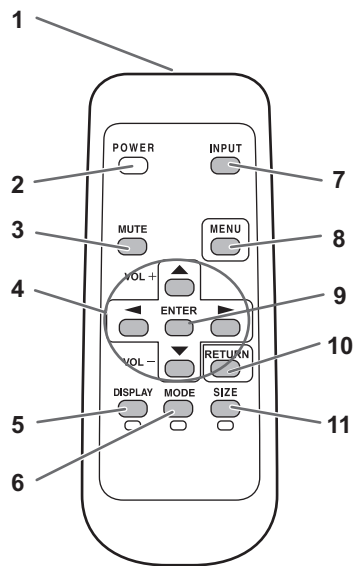

1. Signal transmitter
2. POWER button (See page 17.)
3. MUTE button (See page 19.)
4. VOL +/- buttons (See page 19.)
BRIGHT +/- buttons (See page 19.)
Cursor control (▲ / ▼ / ◀ / ▶) buttons
5. DISPLAY/Red button (See page 19.)
6. MODE/Green button (See page 19.)
7. INPUT button (See page 19.)
8. MENU button (See page 19.)
9. ENTER button (See page 19.)
10. RETURN button (See page 19.)
11. SIZE/Yellow button (See page 19.)

Connecting Peripheral Equipment

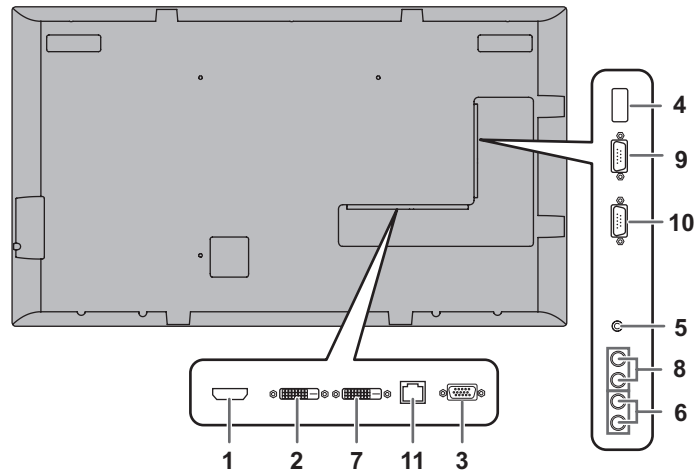

! Caution

- Be sure to turn off the main power switch and disconnect the plug from the power outlet before connecting/ disconnecting cables. Also, read the manual of the equipment to be connected.
- Be careful not to confuse the input terminal with the output terminal when connecting cables. Accidentally reversing cables connected to the input and output terminals may cause malfunctions and the other problems.
- Do not use any cable that has a damaged or deformed terminal. Using such cables may cause malfunctions.

TIPS

- Images may not be displayed properly depending on the computer (video card) to be connected.
- Use the automatic screen adjustment when a PC screen is displayed for the first time using D-SUB, or when the setting of the PC is changed. The screen is adjusted automatically when AUTO in the SCREEN menu is set to ON.
- If the audio output from the playback device is connected directly to speakers or other devices, the video on the monitor may appear delayed from the audio portion. Audio should be played through this monitor by connecting the playback device to the monitor's audio input, and connecting the monitor's audio output to the speakers or other devices.
- The audio input terminals used in each input mode are factory-set as follows.

Input mode	Audio input terminal
DVI-D	Audio1 input terminal
HDMI[PC], HDMI[AV]	HDMI input terminal / Audio1 input terminal
D-SUB[RGB]	Audio1 input terminal
D-SUB[COMPONENT], D-SUB[VIDEO]	Audio2 input terminals
USB	USB port

1. HDMI input terminal

- Use a commercially available HDMI cable (conforming to the HDMI standard).
- Set HDMI of INPUT SELECT on the SETUP menu according to the device to be connected.

2. DVI-D input terminal

- Use a commercially available signal cable (DVI-D 24 pin).

3. D-sub input terminal

- Set D-SUB of INPUT SELECT on the SETUP menu according to the device to be connected.

4. USB port

- Connect a USB flash drive to the USB port.
- Do not connect a USB device other than a USB flash drive.
- Turn off the power of the monitor when removing a USB flash drive.
- After you have connected a USB flash drive, create "data.db" and "db.info" in the root folder.

Supported USB flash drives

File System	FAT32
Capacity	Up to 32 GB (maximum file size 2 GB)

- Do not use a USB flash drive with a security function or a write protection function.
- Use a USB flash drive with a shape that can be inserted in the USB port. Some USB flash drives with special shapes cannot be inserted. Do not forcibly insert a USB flash drive. This may damage the connector and cause failure.

5. Audio1 input terminal

- Use an audio cable without resistance.

6. Audio2 input terminals

7. DVI-D output terminal

- When the input mode is set to DVI-D, the video of the DVI-D input can be output to an external device.
- Outputting HDCP-encrypted video requires an external device which supports HDCP.
- This terminal allows the daisy chain connection of up to 5 monitors by connecting the monitors to each other through the DVI-D input terminal of each monitor.

TIPS

- The length of the signal cables or surrounding environment may affect the image quality.
- When the input mode is set to a mode other than DVI-D, video cannot be output.

8. Audio output terminals

- The output sound varies depending on the input mode.
- It is not possible to control the sound output from the audio output terminals with the AUDIO menu. Set this function with AUDIO OPTION in the SETUP menu. (See page 27.)

9. RS-232C input terminal

10. RS-232C output terminal

- You can control the monitor from a PC by connecting a commercially available RS-232 straight cable between these terminals and the PC.
- PN-Y555/PN-Y475/PN-Y425/PN-Y325 monitors can be connected together in a daisy chain connection.

11. LAN terminal

- You can control the monitor from a PC on a network by connecting a commercially available LAN cable between this terminal and a network.

Connecting the Power Cord

! Caution

- Use only the power cord supplied with the monitor.
1. Turn off the main power switch.
 2. Plug the power cord (supplied) into the AC input terminal.
 3. Plug the power cord (supplied) into the AC power outlet.

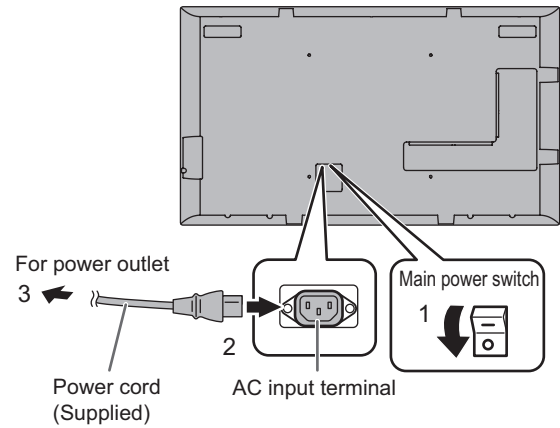

Binding Cables

[PN-Y555]

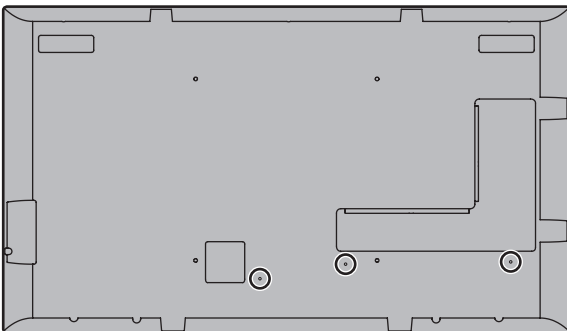

[PN-Y475]

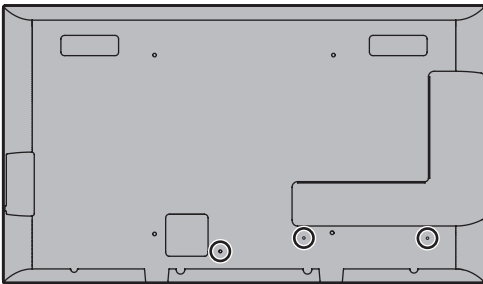

[PN-Y425]

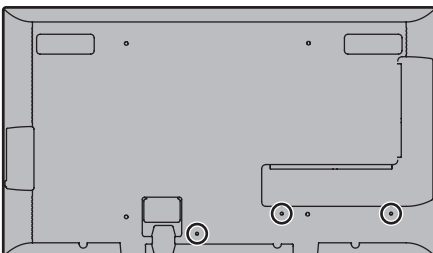

The cables connected to the terminals on the rear of the monitor can be fastened with the cable clamp.

Attach the cable clamp into the cable clamp attachment on the rear of the monitor and fasten the cables.

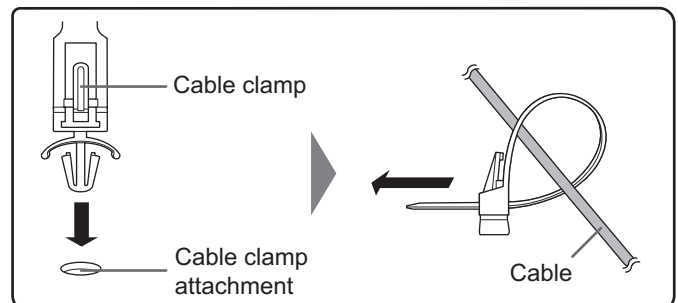

Setting the USB flash drive cover

1. Insert the USB flash drive into the USB port.

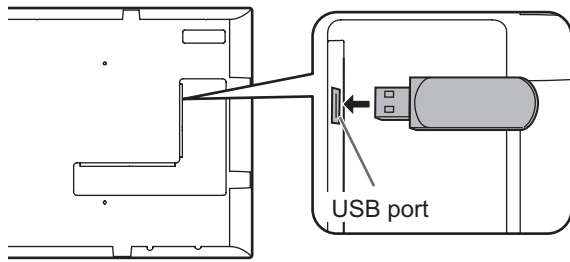

2. Attach the USB flash drive cover and secure with the provided screw.

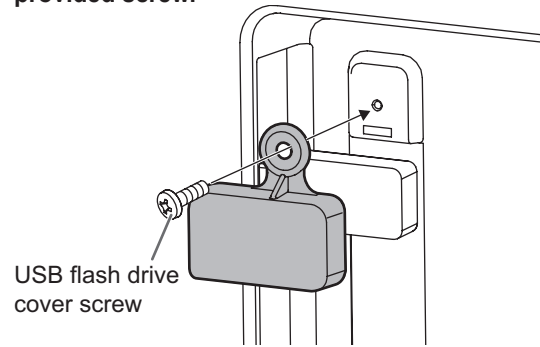

TIPS

- If the USB flash drive will be attached, use a USB flash drive with dimensions no greater than 1-15/16 inch (50 mm) (L) × 13/16 inch (20 mm) (W) × 1/2 inch (12 mm) (H).

Affixing the Stand Hole Protection Covers

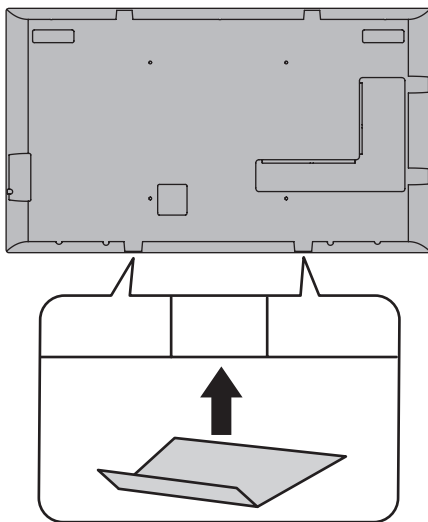

After installing the monitor, affix the stand hole protection covers as necessary.

1. Peel off the backing sheet and affix the cover on the monitor.

Preparing the Remote Control Unit

Installing the batteries

1. Press the cover gently and slide it in the direction of the arrow.

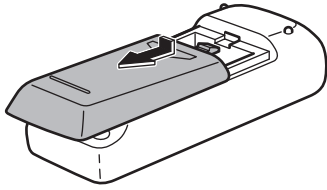

2. See the instructions in the compartment and put in the supplied batteries (R-6 ("AA" size) x 2) with their plus (+) and minus (-) sides oriented correctly.
3. Close the cover.

TIPS

- When the batteries become exhausted, replace them with new (commercially available) batteries.
- The supplied batteries (R-6 ("AA" size) x 2) may become exhausted quickly depending on how they are stored.
- If you will not be using the remote control for a long time, remove the batteries.
- Use manganese or alkaline batteries only.

Remote control operation range

The operation range of the remote control unit is approx. 16.4 feet (5 m) at an angle of approx 10° from the center to the top/bottom/right/left of the remote control sensor.

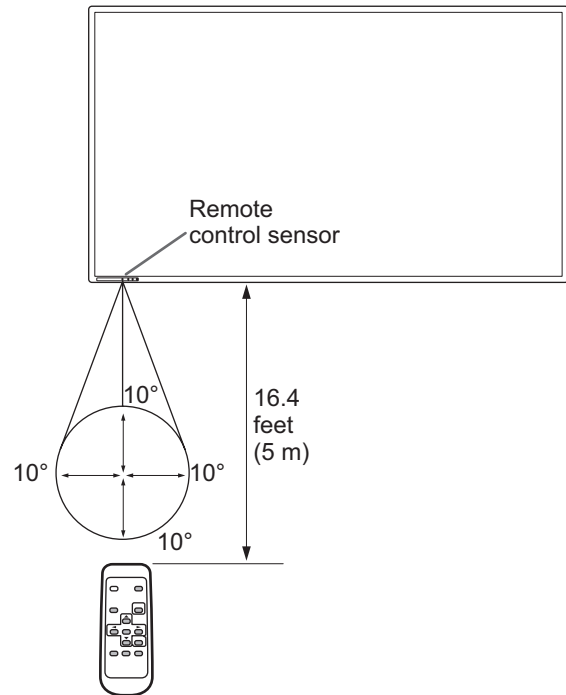

TIPS

- Do not expose the remote control unit to shock by dropping or stepping on it. This could lead to a malfunction.
- Do not expose the remote control unit to liquids, and do not place it in an area with high humidity.
- The remote control unit may not work properly if the remote control sensor is under direct sunlight or strong lighting.
- Objects between the remote control unit and the remote control sensor may prevent proper operation.
- Replace the batteries when they run low as this may shorten the remote control's operation range.
- If a fluorescent light is illuminated near the remote control unit, it may interfere with proper operation.
- Do not use it with the remote control of other equipment such as air conditioner, stereo components, etc.

Turning Power On/Off

! Caution

- Turn on the monitor first before turning on the PC or playback device.

Turning on the main power

When the main power is turned on, the power LED lights. Wait until the screen is displayed.

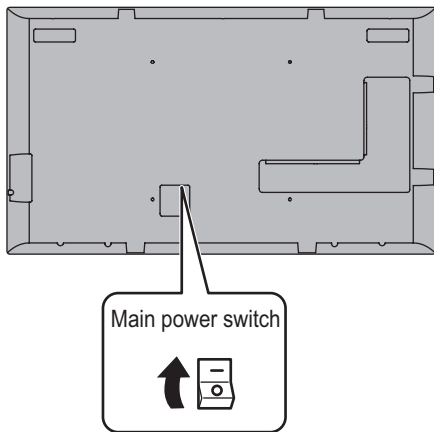

! Caution

- The main power must be turned on/off with the main power switch. Do not connect/disconnect the power cord or turn the breaker on/off while the main power switch is on.
- When switching the main power switch or the POWER button off and back on, always wait for at least 5 seconds. Risk of failure or malfunctioning if the interval is too short.
- For a complete electrical disconnection, pull out the main plug.

Turning power on/off

Press the POWER button to turn the power ON/OFF.

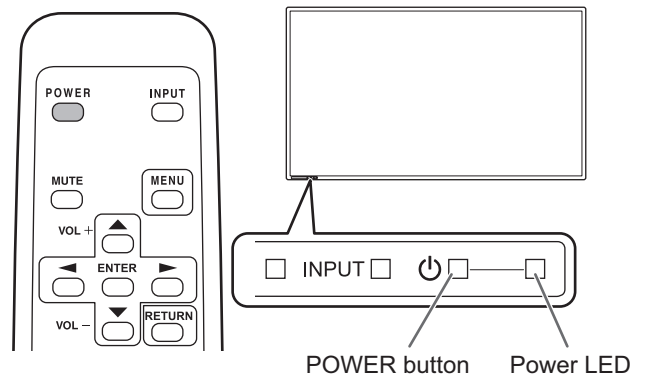

Status	Status of the monitor
Green lit	Power on
Orange lit	Power off (Standby mode)
Green flashing	Input signal waiting mode

! Caution

- When switching the main power switch or the POWER button off and back on, always wait for at least 5 seconds. A short interval may result in a malfunction.

TIPS

- When the main power switch is off, the monitor cannot be turned on.
- If the monitor is in the input signal standby mode and you press the POWER button on the remote control unit, the monitor enters standby mode.
- Setting the SCHEDULE flashes the power LED alternately in red and orange in standby mode.

Turning Power On/Off

■Date/time setting

- If the time has not been set, such as when the monitor is first turned on, set the date and time in DATE/TIME SETTING of the SETUP menu.
Be sure to set the date and time.

TIPS

- Set the time on a 24-hour basis.
- The clock stops if the main power remains off for about 1 week.*
(*Approximate time. The actual time varies depending on the state of the monitor.)

Basic Operation

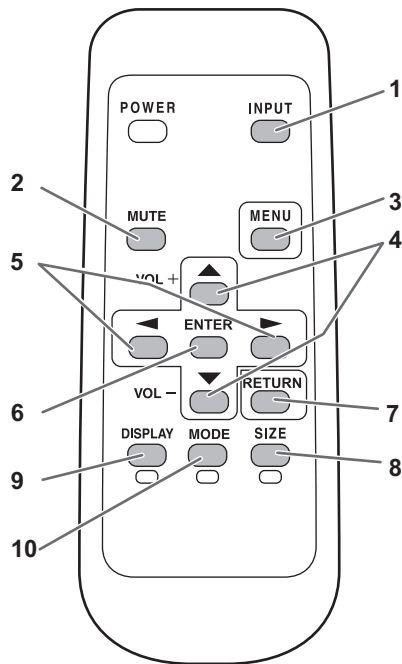

1. INPUT (Input mode selection)

The menu is displayed. Press or to select the input mode, and press to enter.

* You can select the input terminal by pressing the input switch of the monitor.

Input mode	Video	Audio
DVI-D	DVI-D input terminal	Audio1 input terminal
HDMI[AV]	HDMI input terminal	HDMI input terminal / Audio1 input terminal
HDMI[PC]		
D-SUB[RGB]	D-sub input terminal	Audio1 input terminal
D-SUB[COMPONENT]		Audio2 input terminals
D-SUB[VIDEO]		
USB	USB port	USB port

When a USB flash drive is connected, the input mode automatically changes to "USB". The input mode also automatically changes to "USB" if the power is turned on with a USB flash drive connected.

2. MUTE

Turns off the volume temporarily.

Press the MUTE button again to turn the sound back to the previous level.

3. MENU

Displays and turns off the menu screen. (see page 25.)

4. VOL +/- (Volume adjustment)

Pressing or displays the VOLUME menu when the menu screen is not displayed.



Press or to adjust the volume of the sound.

* If you do not press any buttons for about 5 seconds, the VOLUME menu automatically disappears.

* To change the volume of video or music when the input mode is "USB", use "Settings during play". (See page 24.)

5. BRIGHT +/- (Brightness adjustment)

Pressing or displays the BRIGHT menu when the menu screen is not displayed.



Press or to adjust the brightness.

* If you do not press any buttons for about 30 seconds, the BRIGHT menu automatically disappears.

6. ENTER

Confirms the setting.

7. RETURN

Returns to the previous screen.

8. SIZE (Screen size selection)/Yellow

Each time you press this button, the screen size changes in the following order: (See page 20.)

NORMAL → WIDE → Dot by Dot →NORMAL...

9. DISPLAY/Red

Displays monitor information (Input mode, LAN Setup, etc.). The display disappears automatically after about 15 seconds.

10. MODE (Color mode selection)/Green

Each time you press this button, the color mode changes in the following order:

STD (Standard) → VIVID → sRGB → HIGH ILLUMINANCE → USB → STD...

- HIGH ILLUMINANCE is a display with colors suited to bright locations.
- sRGB is for DVI-D, HDMI[PC], and D-SUB[RGB] input only. sRGB is international standard of color representation specified by IEC (International Electrotechnical Commission). Color conversion is made in taking account of liquid crystal's characteristics and represents color tone close to its original image.

! Caution

- When the input mode is [USB], operations 3, 4, 5, 8, 9, and 10 cannot be performed. Change an input mode to other than USB before performing these operations. COLOR MODE, VOLUME and SIZE can be changed while a file in a USB flash drive is being played. (See page 24.)

TIPS

- 8 , 9 , and 10 are also used when playing a file in a USB flash drive and when entering text. Colors and operation names appear in the screen.

Basic Operation

■ Switching the screen size

Even when the screen size is changed, the display may remain the same depending on the input signal.

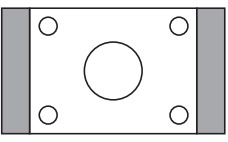
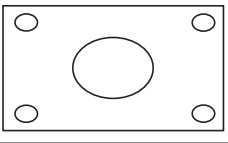
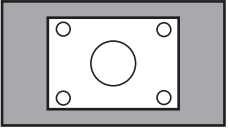
NORMAL		Displays image so it fills the screen without changing the aspect ratio of the input signals.
WIDE		Displays image so it fills the entire screen.
Dot by Dot		Displays the dots of the input signals as the corresponding dots on the screen.

TIPS

- Using this monitor's screen-size switching to compress or expand the screen for commercial or public viewing in establishments like cafes or hotels may infringe on the rights of the creators, as protected by Copyright Law, so please be careful.
- When "Enlarge" is set, the screen size is fixed to WIDE mode.
- The appearance of the original video may change if you select a screen size with a different aspect ratio than the original image (e.g. TV broadcast or video input from external equipment).
- When an ordinary non-wide image (4:3) is viewed with the whole screen using the screen-size switching function of this monitor, the edge of the image may be lost or appear distorted. If you wish to respect the creator's intentions, set the screen size to NORMAL.
- When playing commercial software, parts of the image (like subtitles) may be cropped. In this case select the optimal screen size using the screen-size switching function of this monitor. With some software, there may be noise or distortion at the edges of the screen. This is due to the characteristics of the software, and is not a malfunction.
- Depending on the original image size, black bands may remain at the edges of the screen.

Playing the Files in a USB Flash Drive

A USB flash drive can be inserted in the monitor to display images, videos, and music in the USB flash drive on the monitor. For information on USB flash drive, see page 12.

Auto playback

The image files or video files in a USB flash drive can be automatically played.
 Create a folder with the name "autoplay" in the top level of the USB flash drive.
 Files in the "autoplay" folder that meet the criteria below play automatically. (Supported formats and file names are different from other playback.)

Format	Image files : *.jpg * ¹ or Video files : *.wmv * ¹
File name	001.jpg - 030.jpg * ² or 001.wmv - 030.wmv * ² (Files are played by number in ascending order. If a number is missing in the sequence, that number is skipped.)
Number of files	Up to 30.

*¹ For details, see "Supported formats" at right.
 *² File extension must be in lowercase.

Caution











- Mixed playback of image files and video files is not possible. To display a mix of image files and video files, see "SCHEDULE" (see page 30).

TIPS

- During auto play, it is better to turn the power ON/OFF using the remote control unit. When the power is turned ON/OFF using the main power switch, it takes a longer time until auto play is started. It also takes a longer time for playback to start from STANDBY MODE and LOW POWER.

Preparations

Set the type of files for auto play.

- Change an input mode to other than [USB]. (See page 19.)
- Press  and select SETUP with  or .
- Press  and select AUTO PLAY with  or .
- Press  and select PHOTO or MOVIE with  or .
- Press .
- Press .

Auto playback of files

- Connect a USB flash drive (see page 12) and turn the power ON. You can connect a USB flash drive (see page 12) after turning the power ON.

TIPS

- Auto play will not start if a folder, file format, or file name indicated in "Auto playback" is not correctly set, and if AUTO PLAY is not correctly set in the monitor settings menu.

To stop auto play

- Press .

Playing files

You can play the specified image/video/ audio files in a USB flash drive.

- Insert the USB flash drive into a USB port on the monitor. (See page 12.)
- Change an input mode to [USB]. (See page 19.)
- Select the files to be played, and the play method. (See page 22.)

Supported formats

The types of files that can be played in USB flash drive are as follows:

The operation of formats not indicated in the table is not guaranteed.

Image files

Extension	Display capability
.jpg (.jpeg) * ¹	Size <= 10000 x 10000 Color mode= 444, 422
*.png	4096x3072 4bit, 2730x2500 8bit 2048x1536 16bit, 1500x1200 32bit

*¹ Progressive JPEG files are supported.

Audio files

Extension	Video coding	Audio coding
*.mp3	-	MPEG-1, 2, 2.5 L3
*.wma	-	WMA, WMA Pro

Video files

Extension	Video coding	Audio coding
*.wmv	WMV9	WMA
*.mp4	H.264 BP, MP, HP, MPEG4 SP, ASP, XVID	MP3, ADPCM, AAC
*.ts	MPEG-2, H.264 BP, MP, HP, VC1	AC3, AAC, MP3, DD+, HE-AAC

- In some cases it may not be possible to play the above files.
- A maximum of 32 alphanumeric characters can be used for folder name and file name. A file name or folder name may not display correctly if a space, hyphen (-), or underbar () is used.
- When file names or folder names are long, some characters may not appear in the list screen.
- Do not use a file that is over 2 GB.
- During playback and when a list is displayed, the remote control and some buttons may not respond when operated. This is caused by the heavy image processing load and is not due to a product failure or problem.
- Operation is not assured when a non-supported format is used. The following types of problems may occur:
 - Abnormal play speed
 - Operations cannot be performed during playback
 - Playback stops. The player application restarts.
- When a video file cannot be played, "Unsupported file" appears. With some files, "Video resolution not supported" or "Audio format not supported" may appear.

Playing the Files in a USB Flash Drive

■ Selecting files to be played

1. Insert the USB flash drive into a USB port on the monitor. (See page 12.)

2. Change an input mode to [USB]. (See page 19.)

3. Press .

4. Select an icon with  or  and press .

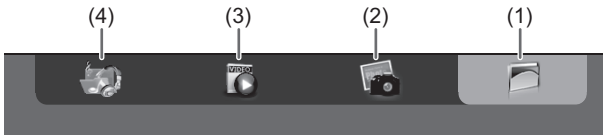

(1) Folder

Folders and files in the USB flash drive are displayed.

(2) Photo

Image files in the USB flash drive are displayed.

(3) Movie

Video files in the USB flash drive are displayed.

(4) Music

Audio files in the USB flash drive are displayed.

5. Select a file.

(1) Folder



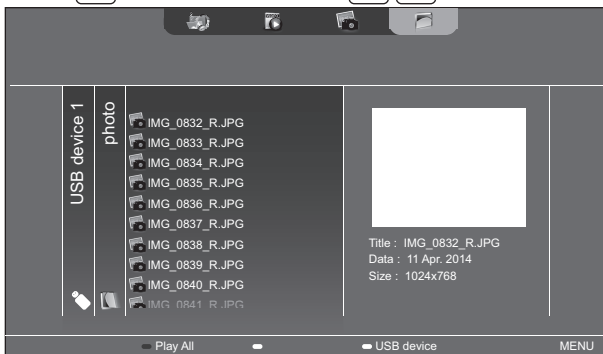





Press  and select a file with  or .



- When the selected item is a folder, the files in the folder are shown on the right. To move to the folder, press .
- When the selected item is a file, the file information appears.

(2) Photo

Select a file with , ,  or .









- Image files are initially grouped by date. To show images of a different date, press , select the date with  or , and press .
 - To change the group of a file, press  (Green) with the file selected. Select one of the items below with  or , and press .
- Date Group by file creation day
 A..Z Group by first letter of file name
 Month Group by file creation month
 Year Group by file creation year

(3) Movie

Select a file with , ,  or .

(4) Music

Select a file with , .

- To move to the file genre menu, press .
 - To narrow down audio files, select with  or  and press .
 - To change the group of a file, press  (Green) with the file selected. Select one of the items below with  or , and press .
- Album Group by album
 Artist Group by artist
 Genre Group by genre
 Track Group by first letter of song title

• A still image can be played while audio is played. (See page 23.)

6. Select the file play method from the following:

- Play a selected file

Press .



- Play all files shown in the list

Press  (Red).

7. To end playback, press .

- When playing music, pause the music before performing the above steps. (See page 23.)

TIPS

- For information on the operations during play, see page 23.
- When playing all files in [Folder], playback starts from the currently selected file, and only files of that type (still image, video, or music) are played. Playback takes place in order of the file names. Even if the files have different formats, the files will be played as long as they are of the same type. Mixed file types are not played.
- To return to the next higher item, press  or .
- When displaying the video file list, the thumbnails of some files may take time to appear. Wait until the thumbnails appear before performing the next operation.

Playing files using the SCHEDULE function

The image files (in .jpg (.jpeg)/.png format) or video files (in .wmv/.mp4/.ts format) in a USB flash drive can be automatically played using the SCHEDULE function. (See page 30.)

Operations during play

■ Image files

Operation is possible using the buttons below.

 /  : Play/Pause a slideshow.

 : Rotate the display 90° clockwise.



 : End playback.

■ Video files

Operation is possible using the buttons below.

 : Move back about 10 seconds.

 : Move forward about 10 seconds.

 : Pause the file that is being played.
To resume playing the paused file, press .

 : Switch between “Play only the file being played” and “Play all”.



 : Select whether the playback order is shuffled or not during continuous playback.

 : End playback.

■ Audio files





 : Move back about 10 seconds.

 : Move forward about 10 seconds.

 : Pause the file that is being played.
To resume playing the paused file, press .

 : Switch between “Play only the file being played” and “Play all”.

 : Select whether the playback order is shuffled or not during continuous playback.

 :  can be pressed during playback of a file to perform an operation without stopping file playback. For example, by displaying a still image file from “Photo” (see page 22) after pressing , you can show a still image while playing music. To stop music, select the original music file and pause. You can also mute the sound with . If  is pressed while the music is paused, playback will end.

TIPS

- To adjust the sound volume for video files and audio files, follow the procedure described in “Settings during play”. (See page 24.)
- If the next operation is performed during processing of an operation that involves a high processing load such as “Move forward about 10 seconds” in a video, the operation will be not processed until the previous processing is completed. Wait until the processing is completed before performing the next operation.
- Processing time varies widely depending on the resolution and file size. For this reason, it is recommended that you keep the resolution at 1920 x 1080 whenever possible.

Settings

■ Settings when the file list is displayed

With a file selected, press .

Select an item with  or  and press .

Shuffle

Select whether or not playback is shuffled during a slideshow or continuous playback.

Repeat

Set whether or not playback of a file, or files in a folder, is repeated.

Slideshow time

(Only during [Folder] or [Photo] display.)

Set the slideshow change time.

This setting is also applied to auto play and schedule play.

The times below are general guidelines, and will vary by file.

Short.....About 3 seconds

Medium....About 6 seconds

Long.....About 9 seconds

Slideshow Transition

(Only during [Folder] or [Photo] display.)

Set how slides are changed in slideshows.

Playing the Files in a USB Flash Drive

■ Settings during play

Press  during playback.

Configure the desired setting with , , , , and .

Options

“Settings when the file list is displayed” (See page 23.) or “Status” (only when playing video) appears.

Picture and sound

COLOR MODE

Changes the color mode on the screen.

VOLUME

Adjust the volume.

SIZE

Changes the screen size of video.

Eco settings

Screen off

Use this during playback of a video or music to turn off the screen and play only the music. The audio of a video or music does not turn off. To show the screen, press  on the remote control.

Clock (Only when playing video or music.)

Clock

A clock can be displayed in the upper right corner of the screen. The clock constantly appears during file playback. To clear the clock display, select [Clock] again and press

.

Touchboards

205 Westwood Ave, Long Branch, NJ 07740

Phone: 866-94 BOARDS (26273) / (732)-222-1511

Fax: (732)-222-7088 | E-mail: sales@touchboards.com

Menu Items

Displaying the menu screen

Video and audio adjustment and settings of various functions are enabled. This section describes how to use the menu items. See pages 26 to 31 for details of each menu item.

! Caution

- Do not turn the main power switch off while the menu items are being displayed. Doing so may initialize the settings.
- This cannot be displayed when the input mode is USB. Change an input mode to other than USB before performing these operations.

■ Example of operation

(Adjusting CONTRAST in the PICTURE menu)

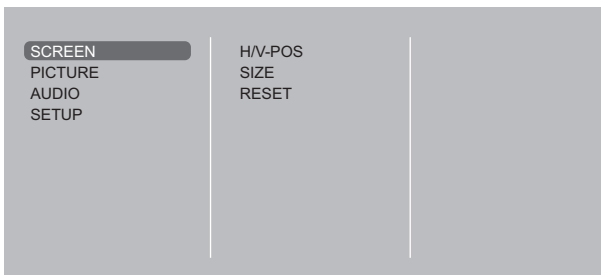

1. Press  to display the menu screen.

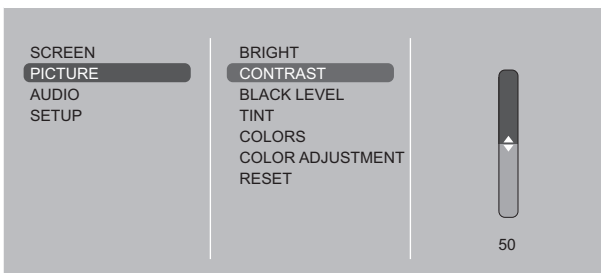

2. Press  or  to select PICTURE, and press .

3. Press  or  to select CONTRAST, and press .



4. Press  or  to adjust the setting, and press .

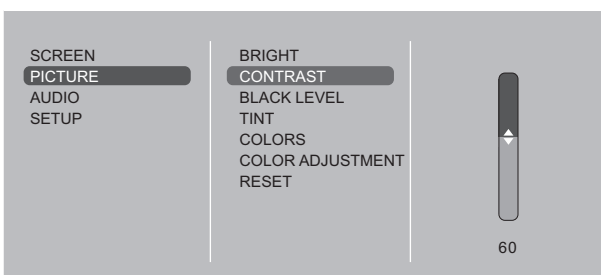

5. Press  to close the menu screen.

TIPS

- The menu will differ depending on the input mode.
- The menu screen will close automatically if no operation is performed for about 1 minute.

■ Menu screen display

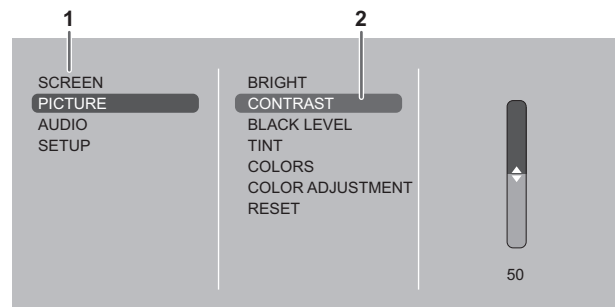

- 1 Name of the menu
- 2 An item being selected (highlighted)

Menu Items

Menu item details

The menu will differ depending on the input mode.

■ SCREEN

AUTO (D-SUB[RGB])

The H/V-POS, etc. are automatically adjusted.

H/V-POS

Adjust the horizontal and vertical position of the image.

SIZE

Changes the screen size. The screen size can also be changed using a remote control unit. (See page 19.)

ZOOM (HDMI[AV]/D-SUB[COMPONENT]/D-SUB[VIDEO])

Enlarge and display part of the image.

INPUT SIGNAL (D-SUB[RGB])

If a computer connected to the D-SUB output any of the following resolution, make a selection from the following options.
768.....1024x768, 1280x768, 1360x768 or 1366x768

RESET

Resets the values of the SCREEN menu items to the factory preset values.

Select "ON" and then press .

■ PICTURE

BRIGHT

Adjusts the backlight brightness.

CONTRAST

Adjusts the difference between the bright and dark portions of the image.

BLACK LEVEL

Adjusts the entire brightness of the video signals.

TINT

Adjusts the hue. Selecting - changes the color towards magenta, and selecting + changes it towards green.

COLORS

Adjusts the color intensity.

SHARPNESS (HDMI[AV]/D-SUB[COMPONENT]/D-SUB[VIDEO])

Adjusts the sharpness of the image.

COLOR ADJUSTMENT

COLOR MODE

Changes the color mode on the screen. The color mode on the screen can also be changed using a remote control unit. (See page 19.)

* sRGB is DVI-D, HDMI[PC], D-SUB[RGB] input only. See page 19 for details.

WHITE BALANCE

THRU Displays the input signal level as is.

PRESET Selects the color temperature using PRESET.

USER Used for adjusting R-/G-/B-GAIN and R-/G-/B-OFFSET respectively.

PRESET

Selects the color temperature when the WHITE BALANCE is set to PRESET.

The setting values are shown for reference. The color temperature of the screen varies over time. This function is not intended to keep the color temperature constant.

GAMMA

Selects the gamma.

ADVANCED

NOISE REDUCTION (HDMI[AV]/D-SUB[COMPONENT]/D-SUB[VIDEO])

Reduce the noise of playback images.

HDMI RGB INPUT RANGE (HDMI[PC]/HDMI[AV])

Sets the RGB input signal range.

RESET

Resets the values of the PICTURE menu items to the factory preset values.

Select "ON" and then press .

■AUDIO**BASS**

Adjusts the volume of bass-level sound.

TREBLE

Adjusts the volume of treble-level sound.

RESET

Resets the values of the AUDIO menu items to the factory preset values.
Select "ON" and then press .

■SETUP**DATE/TIME SETTING**

Set the date and time. Press or to select the date and time, and press or to change the numerical values.
Set the time on a 24-hour basis.

SCHEDULE (See page 30.)

You can turn the power on/off at a specified time.
Files in a USB flash drive can also be played at a specified time.

LANGUAGE

Sets the display language for the menu screen.

INPUT SELECT**HDMI**

Select the input mode to be used in HDMI input terminals.

D-SUB

Select the input mode to be used in D-Sub input terminal. Select SET after selecting the input mode, and then press .

AUDIO OPTION**AUDIO OUTPUT**

Sets the volume of sound output from the audio output terminals.

SPEAKER

Select whether or not speakers are used.

LAN Setup

Configures the settings to control the monitor from the computer via LAN. (See page 38.)

ID SETTING

Assigns ID numbers to monitors connected in a daisy chain (see page 33), using the RS-232 cables.
The numbers 0 to 25 are available for ID numbers.
If "0" is set, the system regards this as the state where no ID number is set.

MULTI**ENLARGE (See page 29.)**

Sets whether or not to use the enlarge function.

ADVANCED (ENLARGE)

ENLARGE H / ENLARGE V

.....Sets the number of screen splits (number of monitors) in the horizontal/vertical direction used for the enlargement.

ENLARGE-POS

.....Specify the split screen to be displayed when the enlargement function is used. (See page 29.)

BEZEL ADJUST

.....When ENLARGE is set to ON, sets whether or not to use the frame correction function.

THERMAL SENSOR SETTING

Select the installation direction of the monitor.

LANDSCAPELandscape orientation

PORTRAITPortrait orientation

STANDBY MODE

When STANDARD is selected, startup time from standby mode is reduced. Note, however that, more power will be consumed in standby mode.

When LOW POWER is selected, current consumption is reduced while the monitor is in standby mode. Note, however, that the startup time from standby mode becomes longer.

If set to LOW POWER, RS-232C commands cannot be used in standby mode and control via LAN is disabled. (See page 32, 38.)

When set to LOW POWER, the monitor enters power standby mode rather than input signal standby mode when there is no input signal, and therefore the monitor does not wake up when a signal is input. (See page 17.)

OFF IF NO OPERATION

Determines whether or not to set the monitor to go into standby mode when there is no operation from the remote control unit, RS-232C commands, or LAN for more than the set time.

Menu Items

POWER ON DELAY

You can delay the screen display after the monitor is turned on. The period can be set up to 60 seconds in units of 1 second. When this function is activated, the power LED flashes (at approx. 1 second interval) in orange.

AUTO INPUT CHANGE

Specify whether to change inputs automatically. When ON is selected and no signal is present in the selected input mode, AUTO INPUT CHANGE automatically changes the selected mode to another mode where a video signal is present.

When video signals exist in multiple input modes, the switching priority is as follows:

DVI-D, HDMI, D-SUB

(Input mode switching may take 15 seconds or more, depending on the connected equipment. When there are no signals at any of the input terminals, switching is continued until an input signal is detected and the monitor does not enter signal standby mode.)

SCAN MODE (HDMI[AV])

Sets the scan mode.

ADJUSTMENT LOCK

You can disable operations on the monitor and the remote control unit that use buttons.

MONITOR BUTTONS

UNLOCKED Enables operation.

LOCK ALL No operations are possible.

LOCK EXCEPT POWER All operations other than turning the power on/off are disabled.





REMOTE CONTROL

UNLOCKED Enables operation.

LOCK ALL No operations are possible.

LOCK EXCEPT VOLUME Only volume adjustment is possible. Other operations are disabled.

LOCK EXCEPT POWER All operations other than turning the power on/off are disabled.

- To disable ADJUSTMENT LOCK, press  until "F" appears in the upper left corner of the screen. Then, press , ,  and  in this sequence before "F" disappears.

LED

Specifies whether to light the power LED.

SCREEN MOTION

Residual images are reduced by moving the screen.

Specify a time period (operating interval) until SCREEN MOTION starts.

POWER MANAGEMENT

POWER MANAGEMENT determines whether or not to switch modes from no signal to the input signal standby mode.

AUTOPLAY (See page 21.)

Set the type of file to be automatically played from a USB flash drive.

ALL RESET

Resets the settings to the factory default settings. (The settings in LAN SETUP are retained.)

TIPS

- If COLOR MODE is set to sRGB, the following items cannot be set.
WHITE BALANCE, PRESET, USER and GAMMA
- When the COLOR MODE is set to HIGH ILLUMINANCE or VIVID, GAMMA can not be adjusted.
- When ENLARGE is used, the SCREEN MOTION function is disabled.
- Even if LED is set to OFF, the power LED lights when a temperature alert occurs.

■Enlarge

- You can align several monitors and integrate them into a single large screen to display.
- Up to 5 monitors can be aligned in both the horizontal and vertical directions.
- Each monitor displays enlarged views of separated images.

(Example)

Horizontal direction: 2 monitors

Vertical direction: 2 monitors

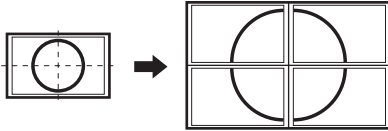

Horizontal direction: 3 monitors

Vertical direction: 2 monitors

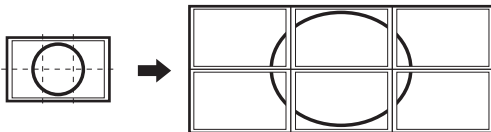

Setting procedure

Set using MULTI in the SETUP menu.

1. Set **ENLARGE** to **ON**.
2. Select **ADVANCED**.
3. Set the number of monitors aligned in the horizontal direction in **ENLARGE H**.
4. Set the number of monitors aligned in the vertical direction in **ENLARGE V**.
5. Set the section of the separated image to be displayed on each monitor in **ENLARGE-POS**.

1) Press **ENTER**.

2) Press **▲** or **▼** to select position, then press **MENU**.

Enlarge

You can align 4, 9, 16, or 25 monitors and integrate them into a single large screen to display.

Enlarged views of separated images are displayed in each monitor.

In horizontal orientation

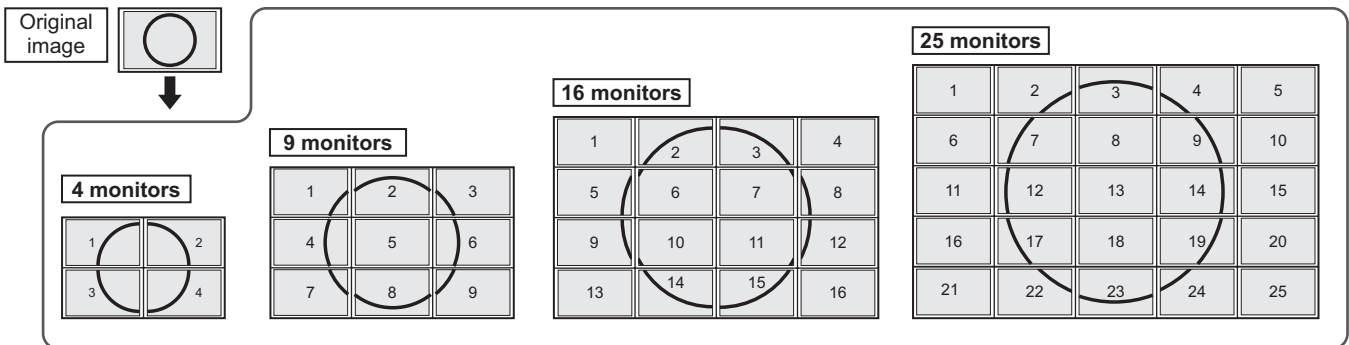

In vertical orientation

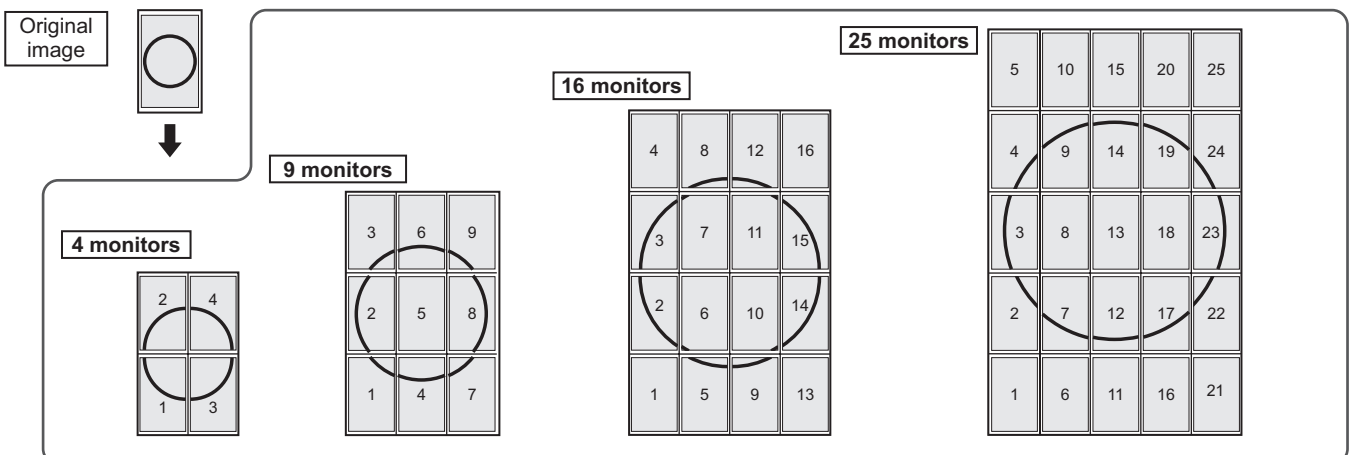

■ SCHEDULE

You can set the time to switch the motion on and off. A file in a USB flash drive can also be played at a specified time. Set "INPUT" in SCHEDULE to "USB", and create a playlist.

Set this function with SCHEDULE in the SETUP menu. (See page 27.)

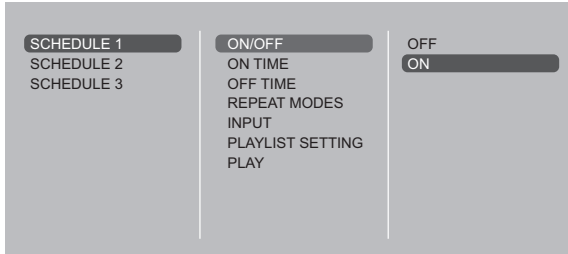

1. Insert the USB flash drive into a USB port on the monitor. (See page 12.)
2. Press or to select the SCHEDULE number, and press .
3. Set the SCHEDULE. (See below)
Move through the items with or , and display the settings of an item with .
4. Press .
SCHEDULE becomes effective.

(1) ON/OFF

Enable/disable the SCHEDULE.

(2) ON TIME

Specify the time the power turns on with or .
Set the time on a 24-hour basis.

When you have finished, select [OK] with or and press .

(3) OFF TIME

Specify the time the power turns off with or .
Set the time on a 24-hour basis.

When you have finished, select [OK] with or and press .

(4) REPEAT MODES

Select the day of the week the schedule will be executed with or , and specify with .

- ONLY ONCE
The SCHEDULE will be executed once only regardless of the day of the week.
- EVERY SUN - EVERY SAT
Executes the SCHEDULE on the specified day every week.
Multiple days of the week can be specified.

(5) INPUT

Specify the input mode at power on with or .

(6) PLAYLIST SETTING

This only appears when INPUT is set to [USB]. Use to create a playlist for automatic display/playback of files in a USB flash drive.

- Image files and video files can be combined in the same playlist.
- Audio files cannot be used.

1. Select the type of file to be set in the list with or , and press .
2. Select a file with or , and press to set the file.
 - A list of folders or files of the selected type (Photo/Video) appears.
 - When a file is selected and set, it appears in the left area.
 - When you select a file in the left area and press , it disappears from the left area.
 - To move up a folder, select [..] and press .
 - To change the file type, press [..] to return to the selection screen, or press (Red), select [Media Type] with or , and press . When [Photo] is selected, image files appear, and when [Video] is selected, only video files appear.
 - To sort the files in the folder, press (Red), select [Sort] with or , and press . Press or to select an item from the following, and press .
 - Type Sorts the files according to the type of video files. This item does not appear for image files.
 - Date Sorts the files according to the modified date and time.
 - Name ... Sorts the files according to their names.
 - To change the file view, press (Red), select [Normal Parser] or [Recursive Parser] with or , and press . When an option is selected, the file view changes as follows:
 - Normal Parser
Folders and files are displayed in the hierarchy of the USB flash drive.
 - Recursive Parser
All image files or all video files are shown together, regardless of the hierarchy of the USB flash drive.
3. Press (Red).
4. Press or to select [Save list], and press .
 - The list displayed in the left area is saved as playlist. If you make changes to a playlist, use [Save list] to save the changed list.
5. Press (Yellow).

(7) PLAY

It appears only after the playlist is saved. It starts the playlist. Press to pause the playlist.

Caution

- Do not switch off the main power after setting the SCHEDULE.
- Set the time for both power-on and power-off. The time for either only cannot be set.
Schedule ON and then OFF only take place in power standby mode and signal standby mode.
- Specify the correct date and time. (See page 27.)
SCHEDULE does not function unless the date and time are specified.
- Check regularly that the set date and time are correct.
- If there is a file in the play list that is not in the USB flash drive, the file is skipped during playback.
- If none of the files in the play list are in the USB flash drive, the screen will turn black. Press to exit.
- Before configuring playlist settings, be sure to insert a USB flash drive.

TIPS

- Up to 3 SCHEDULE items can be registered.
- Setting the SCHEDULE flashes the power LED alternately in red and orange in standby mode.
- A SCHEDULE that has a small number has precedence over that of a large number when schedules overlap.
- The play list is saved in "usb_schedulinglist.txt" in the USB flash drive.

Screen display for adjustment

Before making adjustments in the SCREEN menu or PICTURE menu, display an image to brighten the entire screen. If you are using a Windows PC, use the adjustment pattern on the supplied CD-ROM.

Opening the adjustment pattern

The following example is performed in Windows 7.

1. Load the supplied CD-ROM into the computer's CD-ROM drive.
2. Open [CD Drive] in [Computer].
3. Double-click [Adj_uty.exe].

The adjustment pattern will appear.

Adjust the screen automatically or manually.

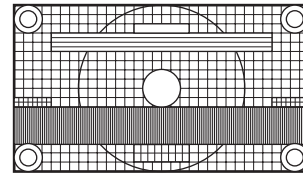

4. When adjustment is finished, press the [Esc] on the computer's keyboard to quit the adjustment program.
5. Eject the CD-ROM from the CD-ROM drive.

TIPS

- If the display mode on the computer you are using is 65,000 colors, the color levels in the color pattern may appear differently or grayscale may appear to be colored. (This is due to the specifications of the input signal and is not a malfunction.)

Controlling the Monitor with a PC (RS-232C)

You can control this monitor from a PC via RS-232C (COM port) on the PC.

You can also connect multiple monitors via a daisy chain by using a PC. By assigning ID numbers to each monitor (see page 33), you can make input mode selection/adjustment or can check the status of a specific monitor.

TIPS

- To control the monitor via RS-232C, set STANDBY MODE to STANDARD.

PC connection

One-to-one connection with a PC

Connect with RS-232 straight cable between the PC's COM port (RS-232C connector) and the RS-232C input terminal on the monitor.

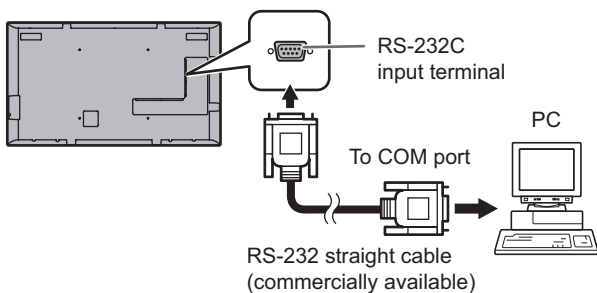

Daisy chain connection... **Advanced operation**

PN-Y555/PN-Y475/PN-Y425/PN-Y325 monitors can be connected together in a daisy chain connection. Connect with RS-232 straight cable between the PC's COM port (RS-232C connector) and the RS-232C input terminal on the first monitor.

Next, connect RS-232 straight cable to the first monitor's RS-232C output terminal and to the second monitor's RS-232C input terminal. Connect in the same way to the third and subsequent monitors.

Up to 25 monitors can be connected. (Depending on the length of the cable used and the surrounding environment.)

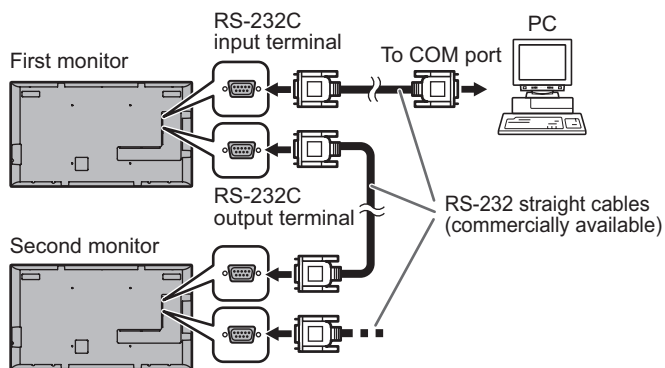

Communication conditions

Set the RS-232C communication settings on the PC to match the monitor's communication settings as follows:

Baud rate	9600bps	Stop bit	1 bit
Data length	8 bits	Flow control	None
Parity bit	None		

Communication procedure

Command format

When a command is sent from the PC to the monitor, the monitor operates according to the received command and sends a response message to the PC.

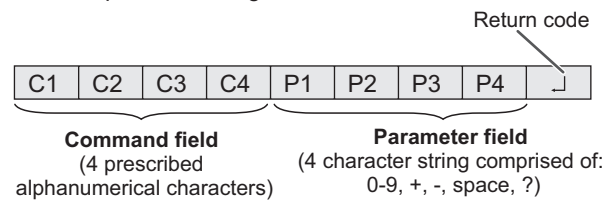

Example: VOLM0030
VOLM _ _ _ 30

- * Be sure to input 4 characters for the parameter. Pad with spaces (" ") if necessary. (" " is a return code (0DH, 0AH or 0DH))
Wrong : VOLM30
Right : VOLM _ _ _ 30

Do not use spaces for DATE. Specify parameters using a specified number of characters.

If a command has "R" listed for "DIRECTION" in the "RS-232C command table" on page 36, the current value can be returned by using "?" as the parameter.

Example:

VOLM ? ? ? ? ← From PC to monitor (How much is current volume setting?).

30 ← From monitor to PC (Current volume setting: 30).

- * If an ID number (see page 33) has been assigned (For example, ID number = 1).

VOLM _ _ _ ? ← From PC to monitor.

30 _ _ 001 ← From monitor to PC.

Response code format

When a command has been executed correctly

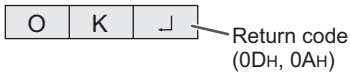

A response is returned after a command is executed.

- * If an ID number has been assigned

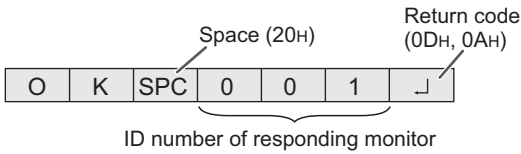

When a command has not been executed

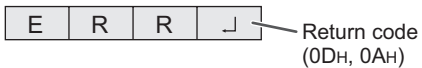

- * If an ID number has been assigned

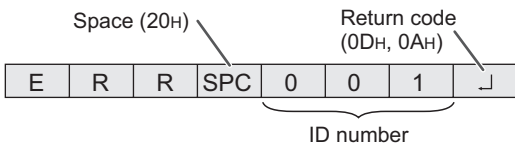

TIPS

- “ERR” is returned when there is no relevant command or when the command cannot be used in the current state of the monitor.
- If communication has not been established for reasons such as a bad connection between the PC and monitor, nothing is returned (not even ERR).
- “ERR” may be returned when a command cannot be received correctly due to interference from the surrounding environment.
Please ensure that the system or software retries the command if this occurs.
- If no monitor has been assigned the designated ID number (e.g. if the command IDSL0002 is used, but no monitor with ID number: 2 is found), no response is returned.

If execution of the command is taking some time

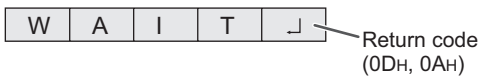

When the following commands are used, “WAIT” is returned. In this case, a value will be returned if you wait a while. Do not send any command during this period.

No ID number is attached to WAIT response.

- Commands which return WAIT:
 1. When repeater control is used
 2. When an IDSL or IDLK command is used
 3. When one of the following commands is used: RSET, INPS, ASNC, WIDE, POWR, EMHV, EPHV, ESHV, ENLG

Communication interval

- After OK or ERR is returned, you must send the following commands.

To set a timeout for the command response, specify 10 seconds or longer.

When connecting multiple monitors in a daisy chain, set the timeout to at least the product of the monitor’s position from the computer multiplied by 10 seconds.

Example) 3rd monitor from computer: 30 seconds or longer.

- Provide an interval of 100 ms or more between the command response and the transmission of the next command.

VOLM0020

OK

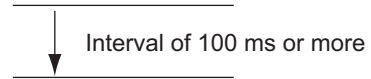

INPS0001

WAIT

OK

TIPS

- When turning the power on while the POWER ON DELAY function is in use, set the timeout period to the POWER ON DELAY period + 10 seconds or longer.

Advanced operation

This section explains commands for daisy chain connection.

The basic communication procedure is the same as in the “One-to-one connection with a PC” section.

ID SETTING

You can assign a unique ID number to each monitor (see page 27). This allows you to control a particular monitor in a daisy chain of monitors.

You can assign ID numbers either from the menu screen or from the PC using RS-232 cable.

[Example]

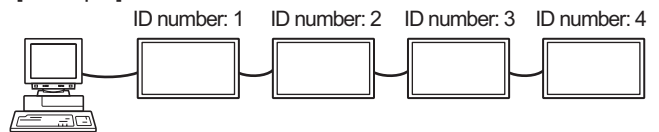

If monitors are connected as shown above, you can execute commands like “Set the volume of the monitor with ID 4 to 20”.

When designating ID numbers for a set of monitors linked in a daisy chain, you should basically avoid any duplication of ID numbers.

ID numbers do not have to be assigned in ascending order starting from the PC. They can also be connected as shown below.

[Example]

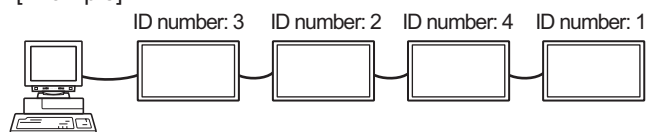

Controlling the Monitor with a PC (RS-232C)

■ Commands for ID control

The command examples shown on this page assume the following connection and ID SETTING.

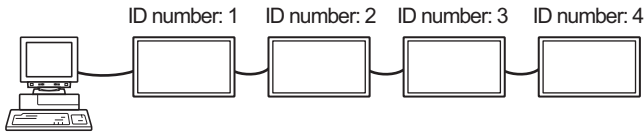

IDSTA monitor receiving this command sets its own ID number in the parameter field.

Example:

IDST0001

OK _ 001 ← The ID number of this monitor is set to 1.

TIPS

You can automatically assign ID numbers by using the IDST command with the Repeater control (see “Repeater control” on page 35).

For example, using the command “IDST001+” automatically sets the ID numbers, as shown below.

[Example]

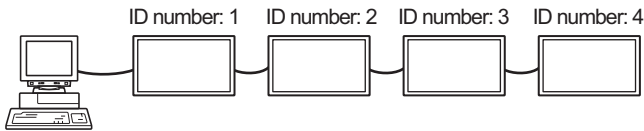

IDST001 + ← ID setting command with repeater control

WAIT

OK _ 001 ← “OK” response from ID number: 1

OK _ 002 ← “OK” response from ID number: 2

OK _ 003 ← “OK” response from ID number: 3

OK _ 004 ← “OK” response from ID number: 4 (End)

IDSLThe parameter of this command sets the ID number of the monitor. The monitor is subject to the next command.

Example:

IDSL0002 ← The next command is for the monitor with ID number: 2.

WAIT ← Searching for monitor with ID number: 2

OK _ 002 ← Found monitor with ID number: 2

VOLM0030 ← Sets volume of monitor with ID number: 2 to 30.

WAIT ← Processing

OK _ 002 ← OK response from monitor with ID number: 2

VOLM0020 ← Sets volume to 20.

OK _ 001 ← The volume of the monitor with ID number: 1 (the one directly connected to the PC) is set to 20.*

* The IDSL command is effective only once, for the immediately succeeding command.

IDLKThe parameter of this command sets the ID number of the monitor. The monitor is subject to all subsequent commands.

Example:

IDLK0002 ← Following commands are for the monitor with ID number: 2.

WAIT ← Searching for monitor with ID number: 2

OK _ 002 ← Found monitor with ID number: 2

VOLM0030 ← Sets volume of monitor with ID number: 2 to 30.*

WAIT ← Processing

OK _ 002

VOLM0020 ← Sets volume of monitor with ID number: 2 to 20.*

WAIT

OK _ 002

IDLK0000 ← Canceling fixed ID number setting

WAIT ← Canceling IDLK

OK _ 002 ← Cancellation complete

VOLM0010

OK _ 001 ← The volume of the monitor with ID number: 1 (the one directly connected to the PC) is set to 10. (IDLK is canceled.)

* The IDLK command remains effective until it is canceled, or power is shut off.

■ Repeater control

This system has a function to allow setting of multiple monitors connected in a daisy chain using a single command. This function is called repeater control. You can use Repeater control function without assigning ID numbers.

[Example]

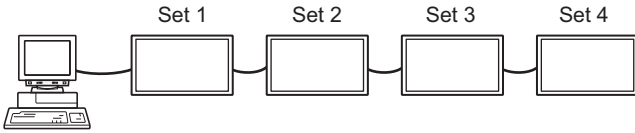

* If monitors are connected as shown above, you can execute a command like "Set all monitors' input settings to D-SUB".

■ Repeater control command

Repeater control is achieved by setting the FOURTH CHARACTER of the parameter to "+".

Example:

VOLM030 + ← Sets volume of all monitors to 30.

In repeater control, responses are returned by all the connected monitors.

If you want to determine that a value has been returned by a specific set, assign ID numbers to each monitor in advance. When some monitors do not return their responses, the probable cause is that the monitors could not receive the command or command processing is not complete. Do not send a new command.

Example: (When 4 monitors are connected, and assigned ID numbers: 1 through 4)

```
VOLM030 +
WAIT
OK _ 001
OK _ 002
OK _ 003
OK _ 004 ← If 4 monitors are connected in
              a chain, reliable operation can
              be ensured by sending a new
              command only after a reply
              has been returned by 4th (last)
              monitor.
```

Repeater control can also be used for reading settings.

Example:

```
VOLM ??? +
WAIT
10 _ 001
20 _ 002
30 _ 003
30 _ 004
```

Volume settings for all monitors are returned.

TIPS

- If repeater control is used during ID designation (IDSL, IDLK), the ID designation is canceled.

Controlling the Monitor with a PC (RS-232C)

RS-232C command table

How to read the command table

- Command: Command field (See page 32.)
 Direction: W When the "Parameter" is set in the parameter field (see page 32), the command functions as described under "Control/Response Contents".
 R The returned value indicated under "Reply" can be obtained by setting "????", "____?" or "???" (repeater control) in the parameter field (see page 32).
 Parameter: Parameter field (See page 32.)
 Reply: Response (Returned value)
 * : "o" indicates a command which can be used in power standby mode.
 "—" indicates a command which cannot be used in power standby mode.
 (When STANDBY MODE is STANDARD. When set to LOW POWER, RS-232C commands cannot be used.)

Power control/Input mode selection

Function	Command	Direction	Parameter	Reply	Control/Response contents	*	
POWER CONTROL	POWR	W	0		Switches to standby mode.		
			1		Returns from standby mode.		
		R	0		Standby mode		
			1		Normal mode		
			2		Input signal waiting mode		
INPUT MODE SELECTION	INPS	W	0		Toggle change for input mode.	o	
			1		DVI-D		
			2		D-SUB[RGB]		
			3		D-SUB[COMPONENT]		
			4		D-SUB[VIDEO]		
			9		HDMI[AV]		
			10		HDMI[PC]		
			11		USB		
			R	1			DVI-D
				2			D-SUB[RGB]
				3			D-SUB[COMPONENT]
		4			D-SUB[VIDEO]		
		9			HDMI[AV]		
		10			HDMI[PC]		
		11			USB*		

* If power standby mode is entered when the input mode is USB, the input terminal that was used prior to switching to USB will respond, not USB.

SCREEN menu

Function	Command	Direction	Parameter	Reply	Control/Response contents	*
SIZE (DVI-D, HDMI[PC], D-SUB[RGB])	WIDE	WR	1-3	1-3	1: WIDE, 2: NORMAL, 3: Dot by Dot	
SIZE (HDMI[AV], D-SUB[COMPONENT], D-SUB[VIDEO], USB)	WIDE	WR	1, 4, 5	1, 4, 5	1: WIDE, 4: NORMAL, 5: Dot by Dot	-
AUTO	ASNC	W	1		When the input mode is D-SUB.	

PICTURE menu

Function	Command	Direction	Parameter	Reply	Control/Response contents	*
BRIGHT	VLMP	WR	0-31	0-31		
COLOR ADJUSTMENT	BMOD	WR	0	0	STD	o
			2	2	VIVID	
			3	3	sRGB (When the input mode is DVI-D, D-SUB[RGB], HDMI[PC])	
			4	4	HIGH ILLUMINANCE	
			5	5	USB	

Controlling the Monitor with a PC (RS-232C)

SETUP menu

Function		Command	Direction	Parameter	Reply	Control/Response contents	*
DATE/TIME SETTING		DATE	WR	AABBCCDDEE	AABBCCDDEE	AA: Year, BB: Month, CC: Day, DD: Hour, EE: Minute	
ID SETTING	ID NO.SETTING	IDST	W	0-25		Sets the monitor's ID number. ("0" means "no ID number".)	
			R		0-25	Returns the monitor's ID number.	
	ID NO. SETTING (ONCE)	IDSL	W	1-25		Sets a monitor ID number. This ID number is only effective for the command immediately after this command.	
				0		Clears the ID number if one has been designated.	
	ID NO. SETTING (SUBSEQUENT)	IDLK	W	1-25		Sets a monitor ID number. This ID number is effective for the next and all subsequent commands after this command.	
0					Clears the ID number if one has been designated.		
MULTI	ENLARGE	ENLG	WR	0-1	0-1	0: OFF, 1: ON	
	ENLARGE MODE	EMHV	WR	11-55	11-55	1 x 1 (OFF) to 5 x 5 ("m x n" is expressed as "mn", where m and n are the numbers of monitors specified for the longest direction and the shortest direction respectively.)	○
	IMAGE POSITION (M x N)	EPHV	WR	11-55	11-55	Specifies values in the order of IMAGE POSITION IN LONGEST/ SHORTEST DIRECTION.	
	BEZEL ADJUST	BZCO	WR	0-1	0-1	0: OFF, 1: ON	
	ENLARGE/ IMAGE POSITION SETTING	ESHV	WR	XXYY	XXYY	XX: ENLARGE MODE (Same as EMHV), YY: IMAGE POSITION (Same as EPHV)	
THERMAL SENSOR SETTING		STDR	WR	0-1	0-1	0: LANDSCAPE, 1: PORTRAIT	
ADJUSTMENT LOCK	MONITOR BUTTONS	ALCM	WR	0-1, 3	0-1, 3	0: UNLOCKED, 1: LOCK ALL, 3: LOCK EXCEPT POWER	
	REMOTE CONTROL	ALCR	WR	0-3	0-3	0: UNLOCKED, 1: LOCK ALL, 2: LOCK EXCEPT VOLUME, 3: LOCK EXCEPT POWER	

Others

Function		Command	Direction	Parameter	Reply	Control/Response contents	*
VOLUME		VOLM	WR	0-31	0-31		○
MUTE		MUTE	WR	0-1	0-1	0: OFF, 1: ON	-
INFORMATION	MODEL	INF1	R		Value		
	SERIAL NO	SRNO	R		Value		
TEMPERATURE SENSOR		DSTA	R		0	Internal temperature normal	
					1	Internal temperature abnormal has occurred and the monitor is in standby mode	
					2	Internal temperature abnormal occurred (To delete the information of temperature abnormal, turn off the main power.)	
					3	Internal temperature abnormal has occurred and backlight brightness is dimmed	
					4	Temperature sensor abnormal	
TEMPERATURE ACQUISITION		ERRT	R		Value	Returns the temperature at the temperature sensors in the following format. [Sensor 1]	
CAUSE OF LAST STANDBY MODE		STCA	W	0		Initialization	
			R		0	No detectable error has occurred	
					1	Standby mode by POWER button	
					3	Standby mode by RS-232C or LAN	
					4	Input signal waiting mode by No Signal	
					6	Standby mode by abnormal temperature	
					8	Standby mode by SCHEDULE setting	
		20	Standby mode by OFF IF NO OPERATION setting				
LAN SETUP	USERNAME	USER	WR	XXXXXXXX	XXXXXXXX	X: Eight characters or less; half-width alphanumeric characters, "-", and "_". (The field can be left blank, but spaces cannot be entered.)	
	PASSWORD	PASS	WR	XXXXXXXX	XXXXXXXX	X: Eight characters or less; half-width alphanumeric characters, "-", and "_". (The field can be left blank, but spaces cannot be entered.)	

TIPS

- Some menu setting items do not have a command. Set with the remote control during installation.

Controlling the Monitor with a PC (LAN)

Your monitor can be connected to a LAN allowing you to control it from a PC on the LAN. The connection requires a commercially available LAN cable (UTP cable, Category 5, straight through).

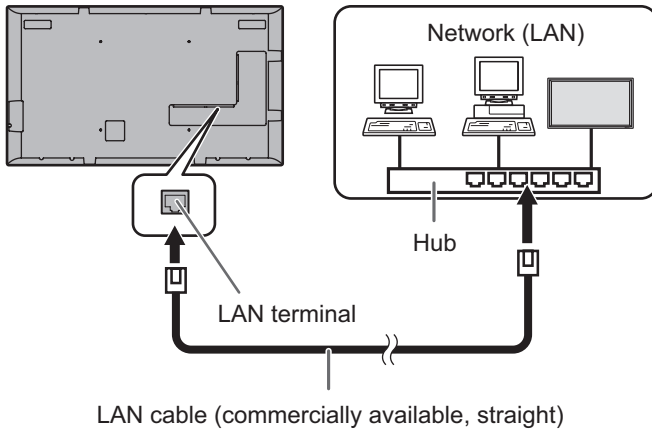

TIPS

- You must assign an IP address to the monitor by following the procedures in "Settings to connect to a LAN". (See the description on the right.)
- To control the monitor via LAN, set STANDBY MODE to STANDARD.
- If you will use RS-232C and LAN control simultaneously, maintain an interval of at least 100 ms between commands.

Settings to connect to a LAN

Set the monitor's IP address and subnet mask to match the settings of your LAN.

The settings depend on the configuration of your LAN. Ask your LAN administrator for details.

■ To set on the monitor

Set the LAN SETUP options. (See page 27.)

After setting each item, press .

DHCP CLIENT

If your LAN has a DHCP server and you wish to obtain an address automatically, change this setting to ON.

To set the address manually, set this to OFF.

IP ADDRESS

If the DHCP CLIENT is set to OFF, specify an IP address.

SUBNET MASK

If the DHCP CLIENT is set to OFF, specify the subnet mask.

DEFAULT GATEWAY

If the DHCP CLIENT is set to OFF, specify the default gateway.

If you are not using a gateway, specify "0.0.0.0".

DNS 1

DNS 2

Specify the DNS server address if the DHCP CLIENT is set to OFF.

If you are not using a DNS server, specify "0.0.0.0".

NETWORK NAME

Enter the device name.

■ Character input

Input characters as follows when it is necessary.

Press to display the text entry table.

Select a character with , and press to enter. To change the characters entered, press (Red), (Green), (Yellow).

To delete the previous character, press .

When you are done entering characters, select [OK] and press .

Command-based control

You can control the monitor using RS-232C commands (see page 36) via terminal software and other appropriate applications.

Read the manual for the terminal software for detailed instructions.

(1) Connect the PC to the monitor.

1. Specify the IP address and data port number (fixed at "10008"), and connect the PC to the monitor.

When connection has been established successfully, [Login:] is returned as response.

2. Enter the user name and password.

(The default settings are blank.)

(2) Send commands to control the monitor.

- The commands used are the same as those for RS-232C. Refer to the communication procedure (see page 32) for operation.
- Usable commands are provided in the RS-232C command table (see page 36).

(3) Disconnect the connection with the monitor and quit the function.

1. Send [BYE].

When the transmission is successful, [goodbye] is returned and the connection is disconnected.

TIPS

- The connection is automatically disconnected if there is no communication for about 5 minutes.

Troubleshooting

If you are experiencing any problem with your display, before calling for service, please review the following troubleshooting tips.

There is no picture or sound.

- Is the power cord disconnected? (See page 14.)
- Is the main power switch off? (See page 17.)
- Is the monitor in standby mode (the power LED illuminating in orange)? (See page 17.)
- Make sure correct input mode is selected. (See page 19.)
- If any external equipment is connected, make sure the equipment is operating (playing back).

Remote control does not work.

- Are the batteries inserted with polarity (+,-) aligned? (See page 16.)
- Are the batteries exhausted?
- Point the remote control unit toward the monitor's remote control sensor. (See page 16.)
- Is operation disabled? (See page 28.)

Sound from left and right speakers is reversed.

- Are audio cables connected properly?

There is a picture but no sound.

- Is the sound muted?
- Make sure the volume is not set to minimum.
- Are audio cables connected properly?
- Is AUDIO OUTPUT or SPEAKER correctly set on the SETUP menu? (See page 27.)

Unstable video.

- The signal may be incompatible.

The video from the HDMI input terminal does not appear properly.

- Is the HDMI cable HDMI standard compliant? The monitor will not work with cables that are not standard compliant.
- Is the input signal compatible with this monitor? (See page 45.)
- If an AV signal such as 1920 x 1080i, 720(1440) x 576i, or 720 (1440) x 480i is displayed using the HDMI[PC] input, display problems such as faint colors may occur. Display using HDMI[AV].

The video from the DVI-D input terminal does not appear properly.

- Is the input signal compatible with this monitor? (See page 45.)
- Turn off the power to the connected equipment and then turn the power on again.
- If the monitors are connected in a daisy chain, turn off the power to all the monitors connected in a daisy chain and then turn the power on again.
- If an AV signal such as 1920 x 1080i, 720(1440) x 576i, or 720 (1440) x 480i is displayed using the DVI-D input, display problems such as faint colors may occur. Display using HDMI[AV], D-SUB[COMPONENT] or D-SUB[VIDEO].

The video from D-Sub input terminal does not appear properly.

- Is the input signal compatible with this monitor? (See page 45.)

Control buttons do not work.

There is no picture.

- Load noises from outside may be interfering with normal operation. Turn off the power and turn it on after waiting at least 5 seconds, and then check the operation.

The monitor makes a cracking sound.

- You may occasionally hear a cracking sound from the monitor. This happens when the cabinet slightly expands and contracts according to change in temperature. This does not affect the monitor's performance.

It takes a longer time until the monitor starts up.

- When a USB flash drive is connected, it is better to turn the power ON/OFF using the remote control unit. When the power is turned ON using the main power switch with a USB flash drive connected, the monitor startup takes a longer time because the monitor checks USB terminal connection after checking other terminal connections.

A file in the USB flash drive does not play properly.

- Is the file in a supported format? (See page 21.)
The following problems may occur if a non-supported format is used:
 - The file does not play properly.
 - Pausing or Move forward/back cannot be performed during playback.
 - Abnormal play speed
 - Operations cannot be performed during playback
 - Playback stops. The player application restarts.

The screen turns black when a file in a USB flash drive is played.

- The screen will turn black if none of the files in the play list are in the USB flash drive. Press  to exit.

The Power LED is flashing in red and green alternately.

- When the internal temperature of the monitor rises excessively, the brightness of the backlight decreases automatically in order to prevent high-temperature-related problems. When this occurs, the Power LED flashes red and green alternately.
- If the internal temperature rises further, the monitor automatically enters standby mode. (The Power LED continues flashing red and green alternately.)
- Remove the cause of the excessive temperature rise.
 - If the monitor enters standby mode due to a rise in temperature, to return to normal display, turn the power switch off and then back on again. The monitor, however, will enter standby mode again if the cause of the temperature rise is not eliminated. (See page 8.)
 - Check whether the monitor is placed at a location where a quick rise in temperature is likely. Internal temperature rises quickly if the vents on the monitor are blocked.
 - Internal temperature rises quickly if dust accumulates inside the monitor or around the vents. Remove dust if possible. Ask SHARP dealer about removing internal dust.

Specifications

■Product Specifications

Model	PN-Y555	PN-Y475	PN-Y425
LCD component	55" Class [54-5/8 inch (138.8cm) diagonal] TFT LCD	47" Class [46-15/16 inch (119.3cm) diagonal] TFT LCD	42" Class [42 inch (106.7cm) diagonal] TFT LCD
Max. resolution (pixels)	1920 x 1080		
Max. colors	Approx. 1.06 billion colors		
Pixel pitch	0.630 mm (H) × 0.630 mm (V)	0.542 mm (H) × 0.542 mm (V)	0.485 mm (H) × 0.485 mm (V)
Viewing angle	178° right/left/up/down (contrast ratio ≥ 10)		
Screen active area inch (mm)	47-5/8 (W) x 26-13/16 (H) (1209.6 x 680.4)	40-15/16 (W) x 23 (H) (1039.7 x 584.8)	36-5/8 (W) x 20-5/8 (H) (930.2 x 523.3)
Computer input signal	Digital (DVI 1.0 standard-compliant), Analog RGB (0.7 Vp-p) [75 Ω]		
Sync signal	Horizontal/vertical separate (TTL: positive/negative)		
Video color system	NTSC (3.58MHz)/NTSC (4.43MHz)/PAL/PAL-60/SECAM		
Plug and play	VESA DDC2B		
Power management	VESA DPMS, DVI DMPM		
Input terminals	PC/AV	HDMI x 1	
	PC	Mini D-sub 15 pin, 3 rows x 1 DVI-D 24 pin (HDCP compatible) x 1	
	Audio	3.5 mm mini stereo jack x 1 RCA pin (L/R) x 1	
	Serial (RS-232C)	D-sub 9 pin x 1	
	USB flash drive	x 1	
Output terminals	PC	DVI-D 24 pin (HDCP compatible) x 1	
	Audio	RCA pin (L/R) x 1	
	Serial (RS-232C)	D-sub 9 pin x 1	
LAN terminal	10 BASE-T/100 BASE-TX		
Speaker output	7 W + 7 W		
Power requirement	AC 100 - 240 V, 1.7 A, 50/60 Hz	AC 100 - 240 V, 1.5 A, 50/60 Hz	AC 100 - 240 V, 1.4 A, 50/60 Hz
Operating temperature *1	32°F to 104°F (0°C to 40°C)		
Operating humidity	20% to 80% (no condensation)		
Power consumption (Input signal waiting mode / standby mode *2)	150 W (16 W / 16 W)	135 W (16 W / 16 W)	120 W (16 W / 16 W)
Dimensions (excluding protrusions) inch (mm)	Approx. 49-3/16 (W) x 2-5/8 (D) x 28-5/16 (H) (1249 x 66 x 719)	Approx. 42-3/8 (W) x 2-5/8 (D) x 24-1/2 (H) (1077 x 66 x 622)	Approx. 38-1/8 (W) x 2-5/8 (D) x 22-1/16 (H) (968 x 66 x 561)
Weight lbs. (kg)	Approx. 55.2 (25.0)	Approx. 36.4 (16.5)	Approx. 32.0 (14.5)

*1 Temperature condition may change when using the monitor together with the optional equipments recommended by SHARP. In such cases, please check the temperature condition specified by the optional equipments.

*2 When STANDBY MODE is set to STANDARD. When STANDBY MODE is set to LOW POWER: 0.5 W

As a part of our policy of continuous improvement, SHARP reserves the right to make design and specification changes for product improvement without prior notice. The performance specification figures indicated are nominal values of production units. There may be some deviations from these values in individual units.

■ Dimensional Drawings

Note that the values shown are approximate values.

[PN-Y555]

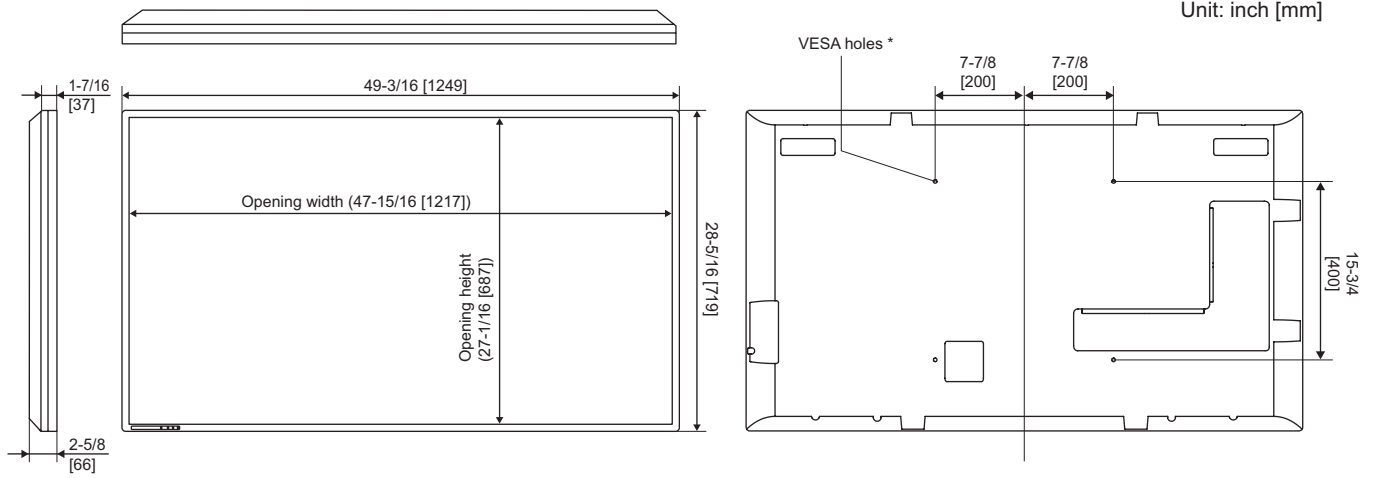

[PN-Y475]

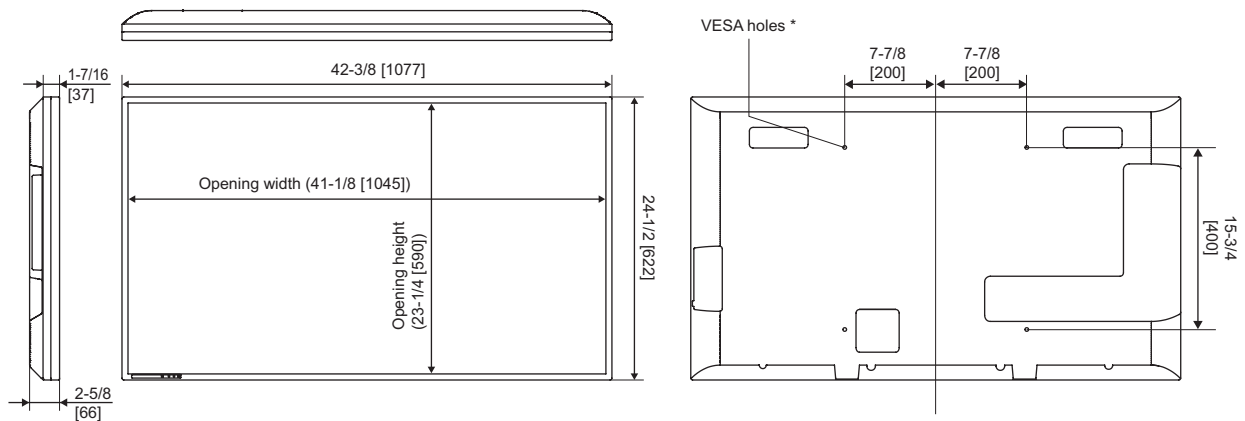

[PN-Y425]

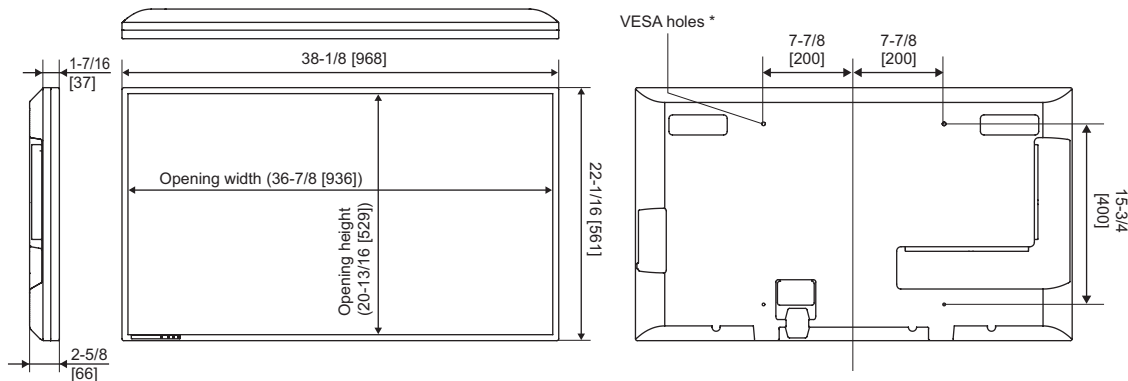

When mounting the monitor, be sure to use a wall-mount bracket that complies with the VESA-compatible mounting method. SHARP recommends using M6 screws and tighten the screws.
 Note that screw hole depth of the monitor is 3/8 inch (10 mm). Loose mounting may cause the product to fall, resulting in serious personal injuries as well as damage to the product. The screw and hole should come together with over 5/16 inch (8 mm) length of thread. Use a bracket which has been approved for UL1678 standard, and which can endure at least 4 times or more the weight of the monitor.

Specifications

■ Power management

This monitor conforms to VESA DPMS and DVI DMPM. Both your video card and computer must support the same standard in order for the monitor's power management function to work.

DPMS: Display Power Management Signaling

DPMS	Screen	Power consumption*	Hsync	Vsync
ON STATE	Display	150 W	Yes	Yes
		135 W		
		120 W		
STANDBY	No display	16 W	No	Yes
SUSPEND		16 W	Yes	No
OFF STATE		16 W	No	No

DMPM: Digital Monitor Power Management

DMPM	Screen	Power consumption*
Monitor ON	Display	150 W
		135 W
		120 W
Active OFF	No display	16 W
		16 W
		16 W

* Values of the PN-Y555, PN-Y475, and PN-Y425 in that order from the top.

■ DDC (plug and play)

The monitor supports the VESA DDC (Display Data Channel) standard.

DDC is a signal standard for plug and play between monitors and computers. Information about resolution and other parameters is exchanged between the two. This function can be used if the computer supports DDC and it has been configured to detect plug-and-play monitors.

There are several types of DDC, depending on the communication method used. This monitor supports DDC2B.

■Compatible signal timing (PC)

Screen resolution		Hsync	Vsync	Dot frequency	Digital		Analog (D-SUB)
					DVI-D	HDMI	
VESA	640 × 480	31.5kHz	60Hz	25.175MHz	Yes	Yes	Yes
		37.9kHz	72Hz	31.5MHz	Yes	Yes	Yes
		37.5kHz	75Hz	31.5MHz	Yes	Yes	Yes
	800 × 600	35.1kHz	56Hz	36.0MHz	-	-	Yes
		37.9kHz	60Hz	40.0MHz	Yes	Yes	Yes
		48.1kHz	72Hz	50.0MHz	Yes	Yes	Yes
		46.9kHz	75Hz	49.5MHz	Yes	Yes	Yes
	1024 × 768	48.4kHz	60Hz	65.0MHz	Yes	Yes	Yes
		56.5kHz	70Hz	75.0MHz	Yes	Yes	Yes
		60.0kHz	75Hz	78.75MHz	Yes	Yes	Yes
	1280 × 768	47.8kHz	60Hz	79.5MHz	Yes	-	Yes
	1280 × 800	49.7kHz	60Hz	83.5MHz	Yes	Yes	Yes
	1280 × 960	60.0kHz	60Hz	108.0MHz	Yes	Yes	Yes
	1280 × 1024	64.0kHz	60Hz	108.0MHz	Yes	Yes	Yes
		80.0kHz	75Hz	135.0MHz	Yes	Yes	Yes
	1360 × 768	47.7kHz	60Hz	85.5MHz	Yes	Yes	Yes
	1400 × 1050	65.3kHz	60Hz	121.75MHz	Yes	Yes	Yes
	1440 × 900	55.9kHz	60Hz	106.5MHz	Yes	Yes	Yes
1600 × 1200*	75.0kHz	60Hz	162.0MHz	Yes	Yes	Yes	
1920 × 1200*	74.0kHz	60Hz	154.0MHz	Yes	Yes	Yes	
Wide	1280 × 720	44.7kHz	60Hz	74.4MHz	Yes	Yes	Yes
	1366 × 768	47.7kHz	60Hz	85.383MHz	Yes	Yes	Yes
	1920 × 1080	67.5kHz	60Hz	148.5MHz	Yes	Yes	Yes
US TEXT	720 × 400	31.5kHz	70Hz	28.3MHz	Yes	Yes	Yes

* Displays a reduced image, except in Dot by Dot. In Dot by Dot, the image will be cut down to panel size then displayed.

- Depending on the connected PC, images may not be displayed properly even if the compatible signal described above is input.

■Compatible signal timing (AV)

Screen resolution	Frequency	HDMI	Component
1920 × 1080p	24Hz	Yes	-
	50Hz	Yes	Yes
	59.94Hz	Yes	Yes
	60Hz	Yes	Yes
1920 × 1080i	50Hz	Yes	Yes
	59.94Hz	Yes	Yes
	60Hz	Yes	Yes
1280 × 720p	50Hz	Yes	Yes
	59.94Hz	Yes	Yes
	60Hz	Yes	Yes
720 × 576p	50Hz	Yes	Yes
720 × 480p	59.94Hz	Yes	Yes
	60Hz	Yes	Yes
640 × 480p(VGA)	59.94Hz	Yes	-
	60Hz	Yes	-
720(1440) × 576i	50Hz	Yes	Yes
720(1440) × 480i	59.94Hz	Yes	Yes
	60Hz	Yes	Yes

Specifications

■DVI-D input terminal pins

(DVI-D 24 pin)

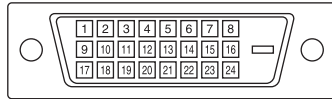

No.	Function	No.	Function
1	TMDS data 2-	13	N.C.
2	TMDS data 2+	14	+5V
3	TMDS data 2/4 shield	15	GND
4	N.C.	16	Hot-plug detection
5	N.C.	17	TMDS data 0-
6	DDC clock	18	TMDS data 0+
7	DDC data	19	TMDS data 0/5 shield
8	N.C.	20	N.C.
9	TMDS data 1-	21	N.C.
10	TMDS data 1+	22	TMDS clock shield
11	TMDS data 1/3 shield	23	TMDS clock+
12	N.C.	24	TMDS clock-

■HDMI input terminal pins

(HDMI™ Connector)



No.	Function	No.	Function
1	TMDS data 2+	11	TMDS clock shield
2	TMDS data 2 shield	12	TMDS clock-
3	TMDS data 2-	13	CEC
4	TMDS data 1+	14	N.C.
5	TMDS data 1 shield	15	SCL
6	TMDS data 1-	16	SDA
7	TMDS data 0+	17	GND
8	TMDS data 0 shield	18	+5V
9	TMDS data 0-	19	Hot-plug detection
10	TMDS clock+		

■D-sub input terminal pins

(Mini D-sub 15 pin)

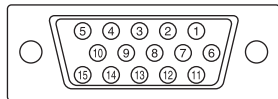

No.	Function	No.	Function
1	Red video signal input	9	+5V
2	Green video signal input	10	GND
3	Blue video signal input	11	N.C.
4	N.C.	12	DDC data
5	N.C.	13	Hsync signal input
6	GND for red video signal	14	Vsync signal input
7	GND for green video signal	15	DDC clock
8	GND for blue video signal		

■RS-232C input terminal pins

(D-sub 9 pin)

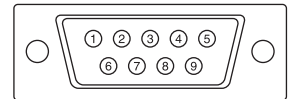

No.	Function	No.	Function
1	N.C.	6	N.C.
2	Transmitted data	7	N.C.
3	Received data	8	N.C.
4	N.C.	9	N.C.
5	GND		

■DVI-D output terminal pins

(DVI-D 24 pin)

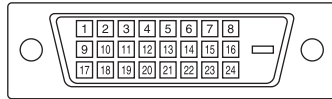

No.	Function	No.	Function
1	TMDS data 2-	13	N.C.
2	TMDS data 2+	14	+5V
3	TMDS data 2/4 shield	15	GND
4	N.C.	16	Hot-plug detection
5	N.C.	17	TMDS data 0-
6	DDC clock	18	TMDS data 0+
7	DDC data	19	TMDS data 0/5 shield
8	N.C.	20	N.C.
9	TMDS data 1-	21	N.C.
10	TMDS data 1+	22	TMDS clock shield
11	TMDS data 1/3 shield	23	TMDS clock+
12	N.C.	24	TMDS clock-

■RS-232C output terminal pins

(D-sub 9 pin)

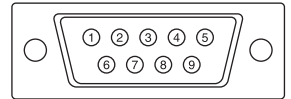

No.	Function	No.	Function
1	N.C.	6	N.C.
2	Received data	7	N.C.
3	Transmitted data	8	N.C.
4	N.C.	9	N.C.
5	GND		

Mounting Precautions (For SHARP dealers and service engineers)

- When installing, removing or moving the monitor, ensure that this is carried out by at least 2 people.
- Be sure to use a wall-mount bracket designed or designated for mounting the monitor.
- This monitor is designed to be installed on a concrete wall or pillar. Reinforced work might be necessary for some materials such as plaster / thin plastic board / wood before starting installation.
- This monitor and bracket must be installed on a wall which can endure at least 4 times or more the weight of the monitor. Install by the most suitable method for the material and the structure.
- To attach a VESA-compliant mounting bracket, use M6 screws that are 5/16 inch (8 mm) to 3/8 inch (10 mm) longer than the thickness of the mounting bracket.
- Do not use an impact driver.
- When moving the monitor, hold the parts marked by  below. Do not hold the LCD panel. This may cause product damage, failure, or injury.

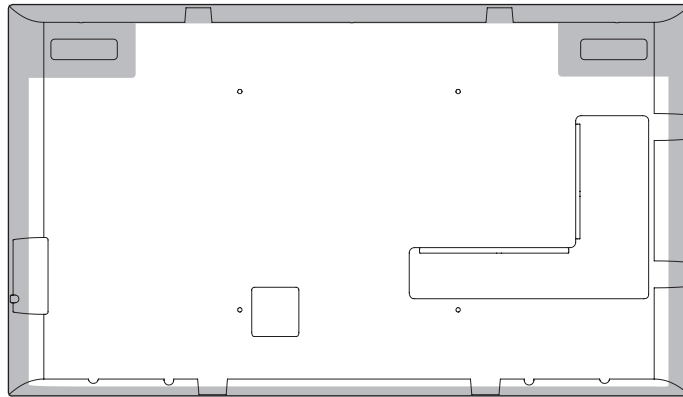

- After mounting, please carefully ensure the monitor is secure, and not able to come loose from the wall or mount.
- Do not use any screw holes other than VESA holes for installation.

Touchboards

205 Westwood Ave, Long Branch, NJ 07740

Phone: 866-94 BOARDS (26273) / (732)-222-1511

Fax: (732)-222-7088 | E-mail: sales@touchboards.com

SHARP[®]
SHARP CORPORATION