

SHARP®

Touchboards

205 Westwood Ave, Long Branch, NJ 07740
Phone: 866-94 BOARDS (26273) / (732)-222-1511
Fax: (732)-222-7088 | E-mail: sales@touchboards.com

SHARP Display Connect Version 2.1

Operation Manual

Contents

Introduction.....	3	Transferring files between clients.....	27
Operating Environment.....	4	Receiving-side operation.....	27
Installing the software.....	6	Sending-side operation	27
Host.....	6	Opening files.....	28
Client.....	6	Android/iOS device	28
Starting the application.....	8	Windows/Mac OS device	30
Host.....	8	Viewing Operation Guide.....	31
Client	9	Connecting hosts	32
Screen guide.....	10	Connecting to another host.....	32
Main screen on host (Host menu).....	10	Operations when connected	32
Main screen on client	11	Configuring host settings.....	33
Sharing screen display	13	Configuring client settings (Windows/Mac OS device)	37
Sharing client screen display (Screen sharing)		Exiting the application	39
(Windows device)	14	Host (full version only).....	39
Setting public files.....	15	Client.....	39
Operating a monitor from a client.....	16	Uninstalling the software.....	40
Handwriting on the screen of the monitor	18	Host.....	40
Handwriting by importing the screen	19	Client.....	40
Sending files from the host to the client.....	21	Trademarks	42
Host operation.....	21		
Client operation	21		
Sending files from the client to the host.....	22		
Client operation (Android/iOS Device)	22		
Client operation (Windows/Mac OS device).....	25		
Host operation.....	26		

Introduction

SHARP Display Connect is software that allows you to send and receive files between a monitor and a mobile device such as a tablet device and to share and operate a screen on a network.

- You can operate and write to the screen of a monitor from a mobile device.
- You can capture and handwrite memos on the screen of a monitor with a mobile device.
- You can transfer files between a monitor and a mobile device. You can set the files to use in advance and receive these files on a mobile device.
- You can transfer files between mobile devices.
- You can share the screen of a monitor in a remote location. (This software is additionally required by the connected devices.)

■ Important Information

- This software has been shipped after strict quality control and product inspection. If, however, you find any failure or malfunction, contact your product dealer.
- Please understand that SHARP CORPORATION bears no responsibility for errors made during use by the customer or a third party, nor for any other malfunctions or damage to this software arising during use, except where indemnity liability is recognized under law.
- Transcribing or duplicating part or all of this manual and/or this software without permission from our company is not permitted.
- As a part of our policy of continuous improvement, SHARP reserves the right to make design and specification changes for product improvement without prior notice.
- File names and numbers of characters that can be handled by this software comply with the specifications of Windows, Mac OS, Android, and iOS.
- Use this software according to the license agreements of the OS you are using and of the installed applications.

■ Notation Conventions

- Keystrokes are indicated with square brackets.
E.g. [Home] key, [Back] key, etc.
- Menus, windows, dialog boxes, buttons, and tabs etc are indicated with square brackets.
E.g. **1. Tap the [Show host menu tag] on the desktop.**
The Host menu appears.
- Items, check boxes, and option buttons, etc., are indicated with quotation marks.
E.g. "Detect Paper", "Verify by connection ID", etc.
- This manual assumes that this software has been installed in the following location.
If you have installed this software in a different location, this can be interpreted to refer to the folder where you installed it.
C:\Program Files\SHARP\SHARP Display Connect (default)
- The screenshots and operational procedures in this manual are only examples.
These may change depending on your monitor, screen settings, or the version of the OS you are using and other factors.
Unless otherwise specified, the explanations use screens from Android/Windows devices.
- This manual does not contain basic operating manuals for Windows, Mac OS, Android, and iOS.
- In this manual, the terms "microSD memory card" and "microSDHC memory card" are shortened to "SD card".
- The version of this software that is installed and used on your computer is referred to as the "full version".
- The version of this software that is preinstalled on the monitor is referred to as the "lite version".
- The following devices are referred to as the "host" in this manual.
 - A computer that is connected to a applicable monitor and that has this software installed on it. (When differentiating between this host and the below host, this host is referred to as the "full version host".)
 - A monitor with this software preinstalled on it.
(When differentiating between this host and the above host, this host is referred to as the "lite version host".)
- The following mobile devices are referred to as the "client" in this manual.
 - Android devices, iOS devices, Windows devices, and Mac OS devices with this software (client version) installed on it.
- In this manual, the operation to select a menu or other item on the screen is called a "tap".
When using the mouse on a Windows computer, please left click.
When using the mouse on a Mac OS computer, please click.

Operating Environment

A host with this software installed on it is required.

A client with this software (client version) installed on it is required.

Example System Configuration

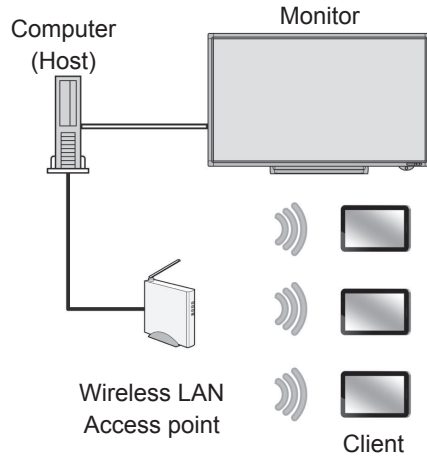

Monitor preinstalled with this software
(Host [lite version host])

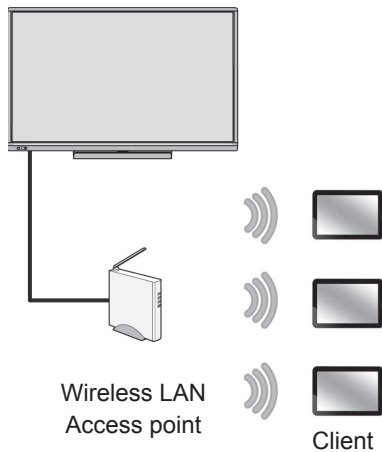

You can transfer files between clients.

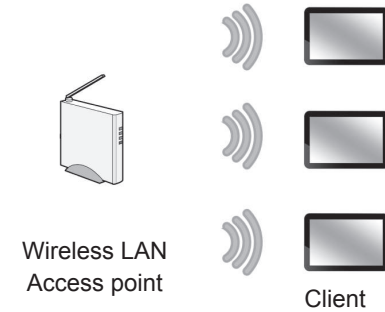

Monitor

SHARP monitors (as of August 2016)

(Available models differ according to region.)

- For the PN-60TA3 / PN-70TA3 / PN-L603A / PN-L703A, this software is preinstalled on the monitor. (Lite version)

For a lite version host, a maximum of 20 clients can be connected at the same time.

Host

The computer must fulfill the requirements below. (as of August 2016)

CPU	Intel Celeron or AMD Sempron 1.6 GHz or faster Intel Core 2 Duo or AMD Athlon II X2 2.8 GHz or faster recommended
OS	Windows Vista (32-bit or 64-bit version), Windows 7 (32-bit or 64-bit version), Windows 8.1 (32-bit or 64-bit version), Windows 10 (32-bit or 64-bit version)
Memory	At least 2 GB
Free space on hard drive	At least 100 MB (At least 100 MB are separately required when installing the Pen Software.)
CD-ROM drive	Required during installation

Pen Software version 2.9 or later must be installed in order to use Pen Software functions.

■ Client

Android devices (as of August 2016)

The smartphone or tablet must fulfill the requirements below.

OS	Android 2.3.3 - 6.0 with English language support
----	---

- * Insert an SD card if you are using a device which has an SD card slot. The software may not function properly if an SD card is not inserted.
- * When the user is changed in Android 4.2.2 or later, the connection with the previous user is ended.

iOS devices (as of August 2016)

The Apple iPhone or iPad must fulfill the requirements below.

OS	iOS 6 - 9 with English language support
----	---

Windows devices (as of August 2016)

The computer or tablet must fulfill the requirements below.

CPU	Intel Celeron or AMD Sempron 1.6 GHz or faster Intel Core 2 Duo or AMD Athlon II X2 2.8 GHz or faster recommended
OS	Windows 7 (32-bit or 64-bit version), Windows 8.1 (32-bit or 64-bit version), Windows 10 (32-bit or 64-bit version)
Memory	At least 2 GB
Free space on hard drive	At least 100 MB

Mac OS devices (as of August 2016)

An Apple MacBook Pro or MacBook Air must fulfill the requirements below.

CPU	Intel Core 2 Duo or faster
OS	Mac OS X v10.7, v10.8, v10.9, v10.10, v10.11
Memory	At least 2 GB
Free space on hard drive	At least 100 MB

■ LAN environment

Ensure that the host and the client are ready to connect to the same local network. For the connection settings, refer to the manuals for the devices.

TIPS

- The maximum number of clients that can be connected to a single host at the same time is 50*.
 - * Ensure that the number of client connections for one access point is 25 or fewer clients.
When connecting 26 or more clients, add an access point and cascade them.
- Depending on the network environment, the number of clients that can be connected may decrease or the amount of time for processing may increase.
- If latency or other similar problems occur with multiple clients connected, connect them through the IEEE 802.11a/11n interface.
- If this application goes into standby mode because a client is locked, the Home button is pressed, another application is started, or a similar event occurs while this application is running, the following happens:

Android device

The current process is canceled.
File transmission and reception is processed in the background.
To start using the software again, reconnect to the host.

iOS device

The current process is canceled.
File transmission and reception continues but is interrupted once the time that iOS can process background tasks (maximum 10 minutes) has elapsed.
To start using the software again, reconnect to the host.

Windows device

The current process continues, but if the network adapter stops due to the device settings, communication is ended.
To start using the software again, reconnect to the host.

Mac OS device

The current process is canceled.
To start using the software again, reconnect to the host.

- If you cannot connect to a mobile device, turn off the device's mobile network communication.

Installing the software

Host

Ensure you are logged in with administrator privileges.
The license code is required for installation.

1. **Exit all application software.**
2. **Insert the supplied CD-ROM into the CD-ROM drive of the computer.**
3. **Open the CD-ROM in “Computer”.**
4. **Double-tap the “SHARPDDisplayConnect” folder.**
5. **Double-tap the setup program “Setup.exe”.**
6. **Follow the instructions on the screen.**
 - If a “User Account Control” window appears, tap [Yes] (or [Allow]).
 - If a security warning saying (“The publisher could not be verified.”) is displayed, tap [Run].
 - If you do not want the application to start automatically when the computer starts up, clear the “Automatically start SHARP Display Connect” check box.

For the PN-SL2A, you must enter the license code for the PN-SL01.

Client

Android device

Download and install the application from Google Play.

TIPS

- Refer to the manuals that came with your Android device.
1. **Tap [Google Play] or [Play Store].**
When the Details screen is displayed, check the app's functions, developer, and other detailed information.
 2. **Tap the search field, type “SHARP Display Connect”, and tap [Search].**
 3. **Tap the [SHARP Display Connect] that appears in the search results.**
 4. **Tap [Install].**
 5. **If you agree to the security permissions that the app requires, tap [Accept & download].**
The download will start.

If the previous version is installed, tap [Google Play] or [Play Store], and then upgrade the client-side application. For details, refer to the manuals that came with your Android device.

■ iOS device

Download and install the application from the App Store.

TIPS

- Refer to the manuals that came with your iOS device.

1. Tap **[App Store]**.
2. Tap the search field, type “SHARP Display Connect”, and tap **[Search]**.
3. Tap the **[SHARP Display Connect]** that appears in the search results.
4. Tap the **[FREE]** icon.
5. Tap the **[INSTALL APP]** icon.
The installation will start.

If the previous version is installed, tap **[App Store]**, and then upgrade the client-side application. For details, refer to the manuals that came with your iOS device.

■ Windows device

For how to obtain the setup program, contact your product dealer.

TIPS

- Refer to the manuals that came with your Windows device.
- A host can also be used as a client.

1. **Exit all application software.**
2. **Double-tap the setup program "Setup.exe".**
3. **Follow the instructions on the screen.**
 - If a "User Account Control" window appears, tap **[Yes]** (or **[Allow]**).
 - If a security warning saying ("The publisher could not be verified.") is displayed, tap **[Run]**.
 - If you do not want the application to start automatically when the computer starts up, clear the "Automatically start SHARP Display Connect" check box.

■ Mac OS device

Download and install the application from the Mac App Store.

TIPS

- To install, an administrator name (user name) and password are required.
- Refer to the manuals that came with your Mac OS device.

1. Tap **[App Store]**.
2. Tap the search field, type “SHARP Display Connect”, and tap **[Search]**.
3. Tap the **[SHARP Display Connect]** that appears in the search results.
4. Tap the **[FREE]** icon.
5. Tap the **[INSTALL APP]** icon.
The installation will start.

If the previous version is installed, tap **[Mac App Store]**, and then upgrade the client-side application. For details, refer to the manuals that came with your Mac OS device.

Starting the application

Host

1. Tap [SHARP Display Connect] () on the taskbar.

The start menu appears.

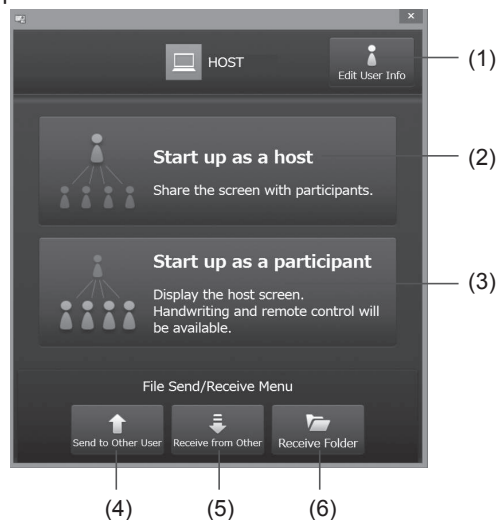

(1) **Edit User Info:** Sets the host name and icon. (page 33)

(2) **Start up as a host:** Starts the host.

(3) **Start up as a participant:** Starts the client. (page 9)

(4) **Send to Other User:** Sends a file to another client. (page 27)

(5) **Receive from Other:** Receives a file from another client. (page 27)

(6) **Receive Folder:** Opens the folder that stores received files.

2. Tap [Start up as a host].

The Host menu appears. (page 10)

TIPS

- To start the application manually, follow the procedure below.
 - Double-tap the "SHARP Display Connect shortcut" () on the desktop and tap [Start up as a host].
 - From the [Start] button on the Windows taskbar, tap [All Programs] - [SHARP Display Connect] - [SHARP Display Connect], and then tap [Start up as a host].
- When the application is started for the first time, if a message saying "Windows Firewall has blocked some features of this program" appears, select all of the check boxes, and then select "Allow access".
- This software automatic start setting is set for each login user. When logged in as a different user, check the "Auto Start" setting from [Settings] on the Host menu. (page 35)
- The Host menu can be displayed from the toolbar. Check the "Minimized" setting from [Settings] on the Host menu. (page 35)
- When the computer is started and the "Failed to initialize CPCP. Check settings?" message is displayed, tap "Yes", and then check the "Network Adaptor" settings on the "Others" tab. (page 35)
 - If a message is displayed even though the settings are correct, check that the network adapter is connected to the network and that a correct IP address has been assigned. After you have checked these items, exit the host and client, and then restart them. For a lite version host, tap "Restart CPCP" on the "Others" tab to restart.
- If the message "SHARP Display Connect Service is not running. Start the SHARP Display Connect Service from Service Menu." is displayed, start "SHARP Display Connect Service".
 - "SHARP Display Connect Service" is displayed under "Services (Local)".
 - Enter "service" in the Control Panel search box to display "Services (Local)".

For a lite version host, start from the launcher screen.

1. Tap "Attended Users" on the launcher screen.

Client

TIPS

- Refer to the manuals that came with the client.

1. **Android/iOS device:** Tap [SDConnect].
Windows device: Tap [SHARP Display Connect] on the desktop and tap [Start up as a participant].

Mac OS device: Double-tap [SHARP Display Connect] in the application folder.

This software starts and a list of hosts connected to the same network is displayed.

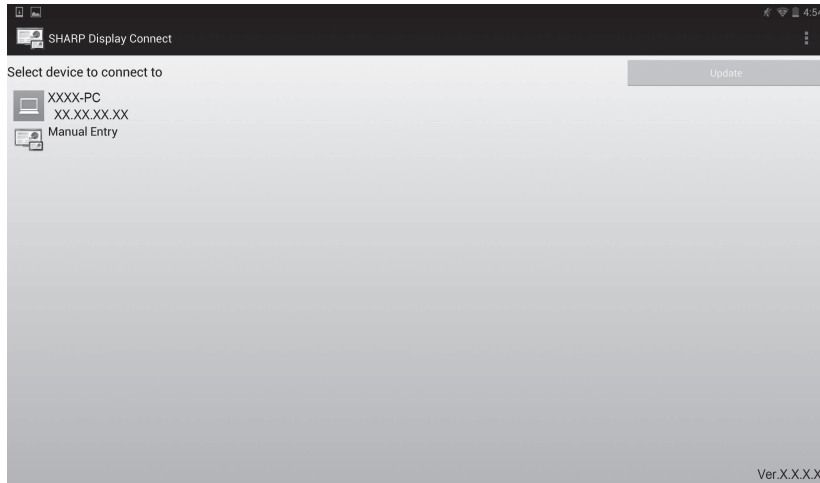

2. **Tap a host that you want to connect to.**
To manually enter the IP address of a host, tap [Manual Entry].

A login information screen appears.

3. Enter login information.

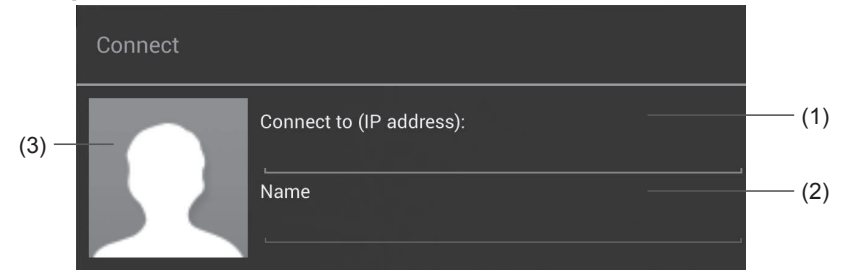

- (1) **Connect to**
Do not enter this information if you selected a host in step 2.
If you selected [Manual Entry] in step 2, enter the IP address of the host that you want to connect to.
- (2) **Name**
Enter a user name. (Maximum length: 12 half-width characters/6 full-width characters)
The name you enter will be displayed on the host (monitor).
* On a Windows/Mac OS device, configure the settings under Edit User Profile in advance. (page 37)
- (3) **Icon**
Set an image that will be displayed on the host (monitor) when logging in.
To change the image, tap the icon and select a different image.
* On a Windows/Mac OS device, configure the settings under Edit User Profile in advance. (page 37)

4. When you have completed the settings, tap [Connect].

The main screen on the client appears. (pages 11 to 12)

TIPS

- When authentication via connection ID is set, a connection ID entry screen appears.
Enter the connection ID displayed in "Connection ID" on the Host menu.

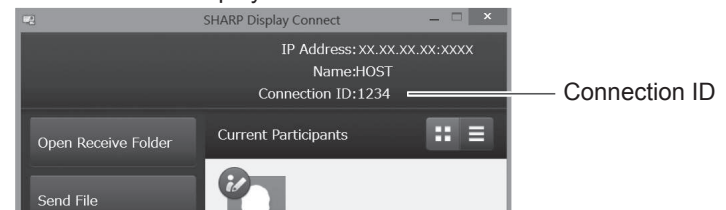

- When the application is started for the first time, if a message saying "Windows Firewall has blocked some features of this program" appears, select all of the check boxes, and then select "Allow access".

Screen guide

Main screen on host (Host menu)

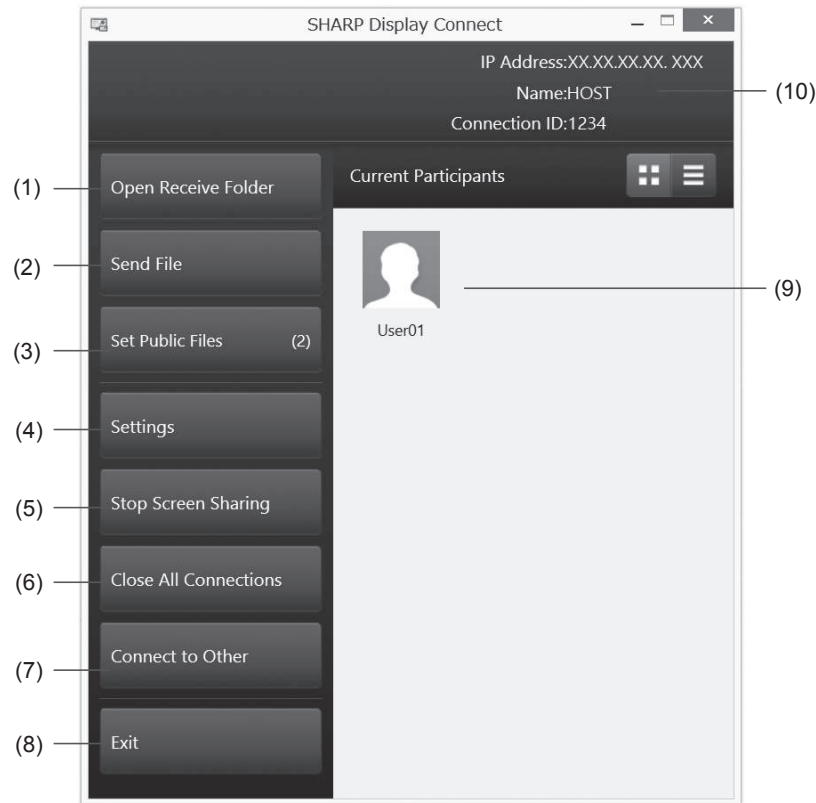

When a current participant is selected

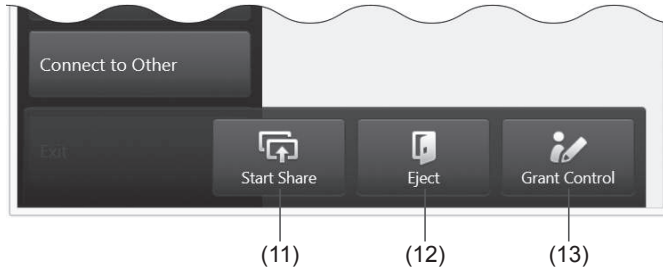

- (1) **Open Receive Folder**
Opens the folder where files downloaded from the client are stored.
- (2) **Send File**
Sends files to the client. (page 21)
- (3) **Set Public Files**
Sets the file to make public on the client. (page 15)
- (4) **Settings**
Configures host operation settings. (page 33)
- (5) **Start (Stop) Screen Sharing**
The host screen can be displayed on the client. (page 13)
When it can be displayed, [Stop Screen Sharing] is displayed. If you do not want to display the screen on the client, tap [Stop Screen Sharing].
- (6) **Close All Connections**
Forcibly ends the connections with all connected clients.
- (7) **Connect to Other**
Connects to another host. (page 32)
- (8) **Exit (full version only)**
Exits the host application.
- (9) **Current Participants**
Displays the connected clients.
When granting a client operation permission, tap the participant and then tap [Grant Control].
The (🔒) icon is displayed for the client with operation permission.
When cancel the client's operation permission, tap the participant and then tap [Cancel Control].
When disconnecting a client, tap the participant and then tap [Eject].
- (10) **Name/Connection ID**
Displays the name and connection ID set for the host. (page 33)
- (11) **Start Share**
Shares the client's screen. (page 14)
- (12) **Eject**
Forcibly terminates the connection to the selected client.
- (13) **Grant Control**
Grants the selected client operation permission.

Main screen on client

Tap [Open menu] to display the menu.
Tap [Close menu] to close the menu.

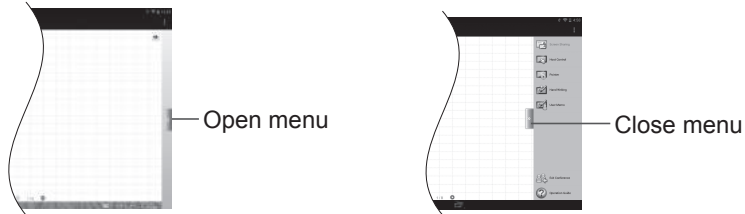

Android device



iOS device

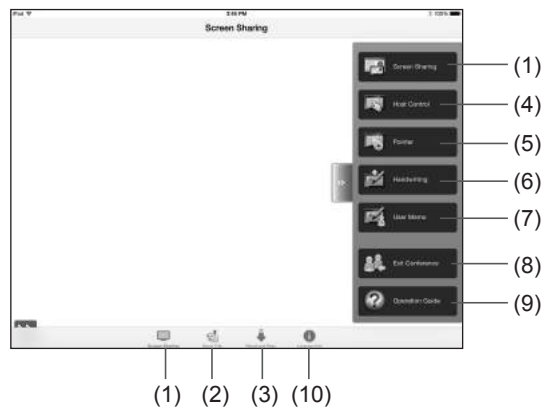

- (1) **Screen Sharing**
Displays the host screen on the client screen. (page 13)
- (2) **Send File**
Sends client files to the host or another client. (page 22, page 27)
- (3) **Received Files**
Used to operate files sent from the host to the client. (page 28)
- (4) **Host Control**
Used to operate the host from the client. (page 16)
- (5) **Pointer**
Displays the pointer on the host. (page 17)
- (6) **Hand Writing**
Used to draw on the host screen. (page 18)
- (7) **User Memo**
Used to capture the host screen and import it into the client. (page 19)
- (8) **Join Conference/Exit Conference**
To end the connection with the host without exiting the application, tap [Exit Conference].
To reconnect, tap [Join Conference] and select a host to connect to. (page 9)
- (9) **Operation Guide**
Displays operation guides. (page 31)
- (10) **License Information**
Displays the license information for this software.

The first time the application is used, an operation guide will appear when a function button is tapped.

Tapping the screen closes the operation guide.

To see operation guides again tap [Open menu] and then [Operation Guide].

Windows Device

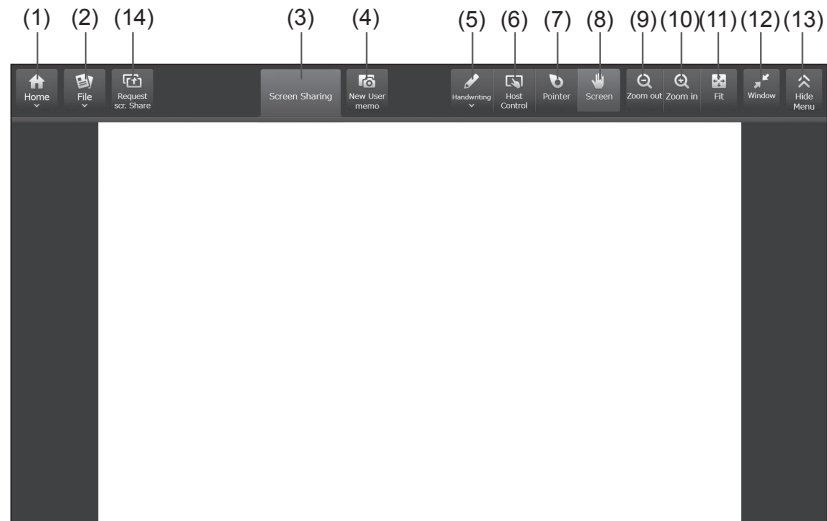

Mac OS Device

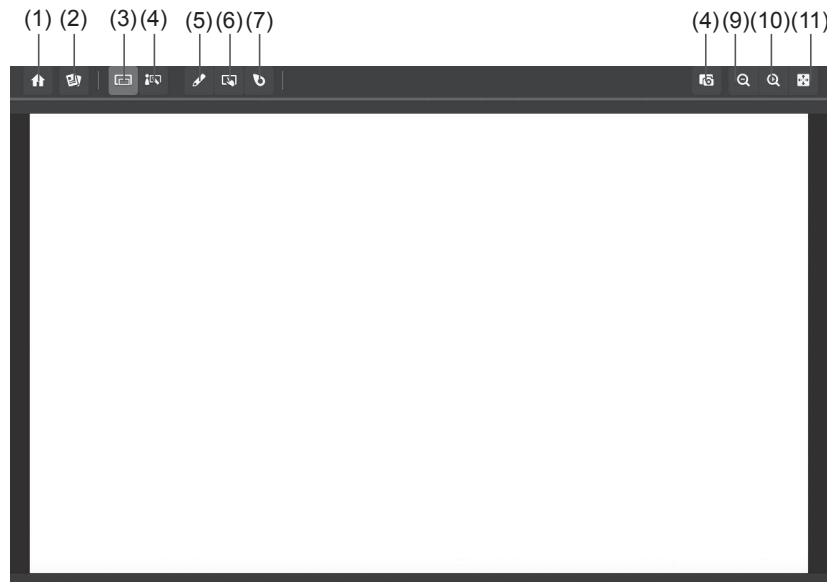

(1) Home

Operation Guide: Displays operation guides. (page 31)

Join Conference/Exit Conference:

To end the connection with the host without exiting the application, tap [Exit Conference].

To reconnect, tap [Join Conference] and select a host to connect to. (page 9)

Settings: Configures client operation settings. (page 37)

Exit: Exits this software. (Windows devices only)

Resize Menu: Changes the size of the menu. (Windows devices only)

(2) File

Send to Host: Sends a file to the host. (page 22)

Send to Other Users: Sends a file to another client. (page 27)

Receive from Other Users: Receives a file from another client. (page 27)

Open Receive Folder: Opens the folder that stores received files.

Get Public File: Obtains the public file that has been set by the host. (page 15)

(3) Screen Sharing:

Displays the host screen on the client screen. (page 13)

(4) User memo:

Used to capture the host screen and import it into the client. (page 19)

(5) Handwriting:

Used to draw on the host screen. (page 18)

(6) Host Control:

Used to operate the host from the client. (page 16)

(7) Pointer:

Displays the pointer on the host. (page 17)

(8) Screen:

Adjusts which portion of the host screen that is displayed on the client side to display.

(9) Zoom out:

Reduces the current screen.

(10) Zoom in:

Enlarges the current screen.

(11) Fit:

Returns the screen from an enlarged or reduced state to its normal size.

The entire screen is displayed maintaining its aspect ratio.

(12) Window:

Maximizes the window. Restores a maximized window to a window.

(13) Show Menu/Hide Menu:

Shows/hides the menu.

(14) Request scr. Share (Windows devices only):

Requests client screen sharing to the host. (page 14)

Sharing screen display

When join conference and screen sharing is allowed on the host, you can display the host screen on client screens.

1. **Android/iOS device:** On the main screen on the client, tap [Open menu] - [Screen Sharing].

Windows/Mac OS device: On the main screen on the client, tap [Screen Sharing].

The monitor screen appears on client.

Android/iOS Device



(1)(2)(3)(4)(5)(6)(7)

You can zoom in or out by pinching in or out.

You can scroll by dragging.

Windows/Mac OS Device

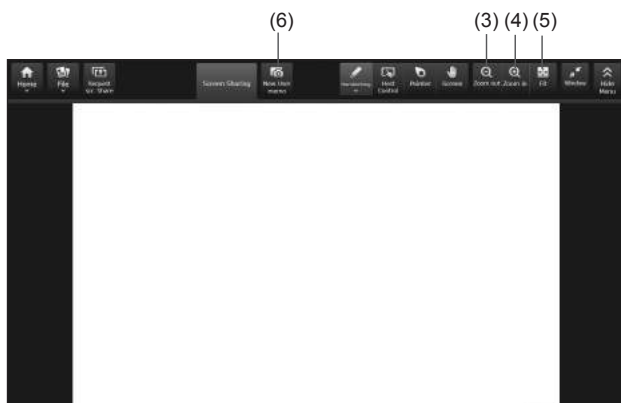

- (1) **Show/Hide operation menu**
Shows/hides the operation menu.
- (2) **Change operation menu position**
Changes the display position of the operation menu.
- (3) **Zoom out**
Reduces the current screen.
- (4) **Zoom in**
Enlarges the current screen.
- (5) **Fit**
Returns the screen from an enlarged or reduced state to its normal size.
The entire screen is displayed maintaining its aspect ratio.
- (6) **User Memo**
Used to capture the host screen and draw on it with the client screen. (page 19)
- (7) **Get Public File**
Obtains the file that was set by the host in advance. (page 15)

TIPS

- If “Stop Screen Sharing” is selected in the Host menu on the host, screen display is not synchronized.

Sharing client screen display (Screen sharing) (Windows device)

You can display the screen of a client joining the meeting* on the host.

* On a Windows device, this is only possible when the screen sharing has been allowed.

■ Specifying the client for screen sharing from the host

1. On the main screen on the host, select a connected client, and then tap [Start Share].

2. On the client, tap [Yes].

The screen of the selected client is displayed on the host.

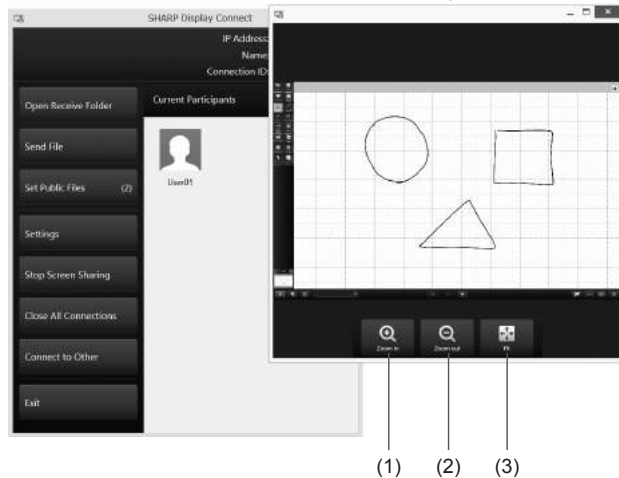

It is also displayed on other clients that are displaying the host screen.

■ Requesting screen sharing from a client to the host

1. On the main screen on the client, tap [Request scr. Share].

Requests from clients are displayed on the host.

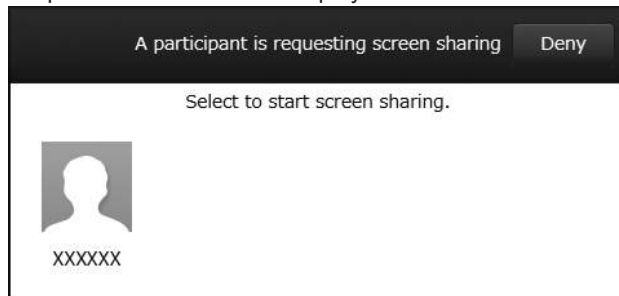

2. On the host, touch a client.

The screen of the selected client is displayed on the host.

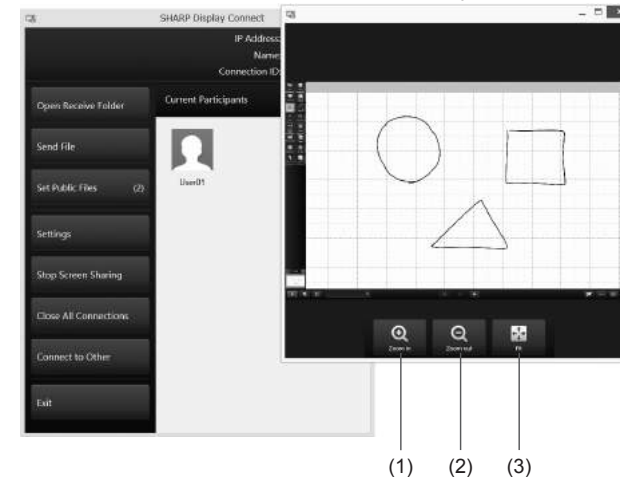

It is also displayed on other clients that are displaying the host screen.

- (1) **Zoom in**
Enlarges the client screen displayed on the host.
- (2) **Zoom out**
Reduces the client screen displayed on the host.
- (3) **Fit**
Returns the zoom ratio of the client screen displayed on the host to 100%.

TIPS

- You can scroll through the client screen displayed on the host by dragging.
- On clients that are performing screen sharing, the host monitor disappears, and [Disconnect] is displayed.
Tap [Disconnect] to stop screen sharing.

Setting public files

You can set public files in advance and obtain these files when the client joins a meeting. When the client logs in at a later point in time, the client can obtain the files without the host having to send them again.

■ Host operation (Setting public files)

1. On the Host menu, tap [Set Public Files].

The public files appear.

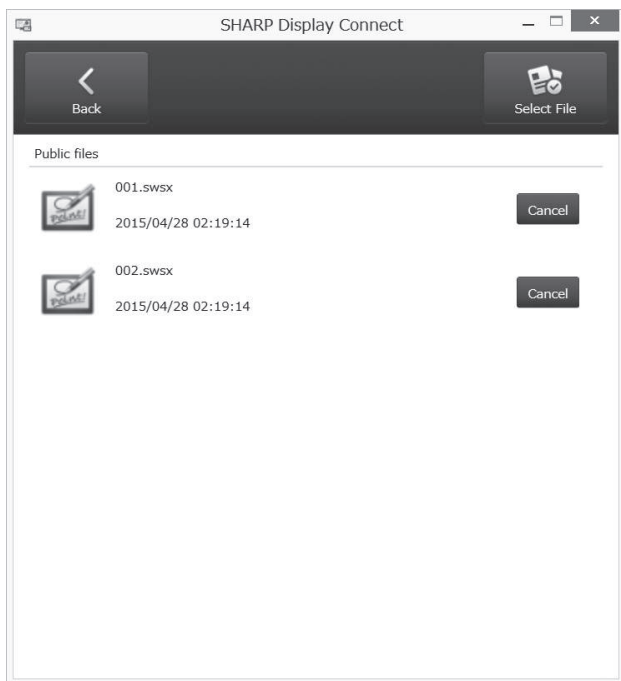

2. Tap [Select File], select the files to make public (multiple files can be selected), and then tap [Open].
3. Tap [Back] to close the screen.

TIPS

- Even after the client joins a meeting, you can add and change the public files.
- To stop the publication of the files, tap [Cancel] in the file list. Display of the file disappears from the list.

■ Client operation (Obtaining public files)

1. **Android/iOS device:** On the main screen on the client, tap [Open menu] - [].
Windows/Mac OS device: On the main screen on the client, tap [File] - [Get Public File].
A list of public files appears.

Android/iOS Device

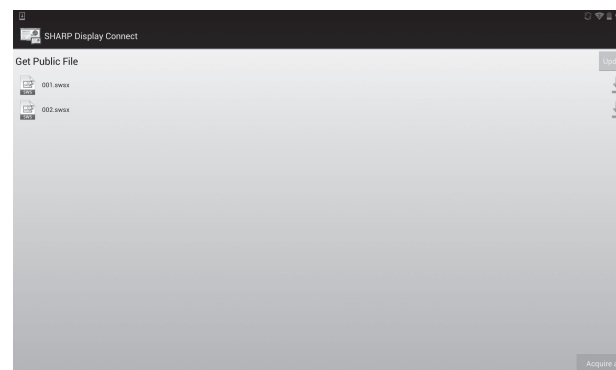

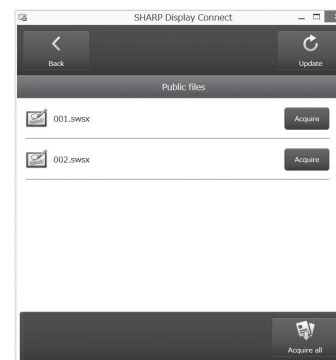

Windows/Mac OS Device



2. Select the file, tap [Acquire], and then tap [Open].

TIPS

- If the files are updated on the host during a meeting, notifications will be sent to the clients.
- Icons are used to indicate the availability of updates for public files.
(Update found:  /No update found: )
- To acquire all the files that have not yet been acquired, tap [Acquire all] in the list of public files.

Operating a monitor from a client

You can operate the host from a client.

Remote operation (Host Control mode)

You can operate the host from a client.

1. **Android/iOS device:** On the main screen on the client, tap [Open menu] - [Host Control].

Windows/Mac OS device: On the main screen on the client, tap [Host Control].

The host control mode screen appears.

Android/iOS Device

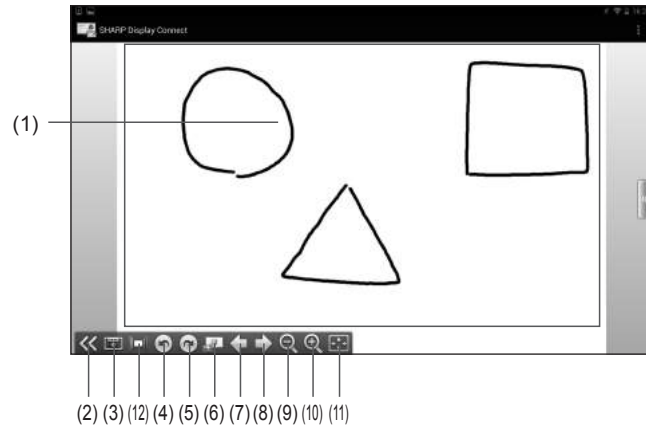

Windows/Mac OS Device

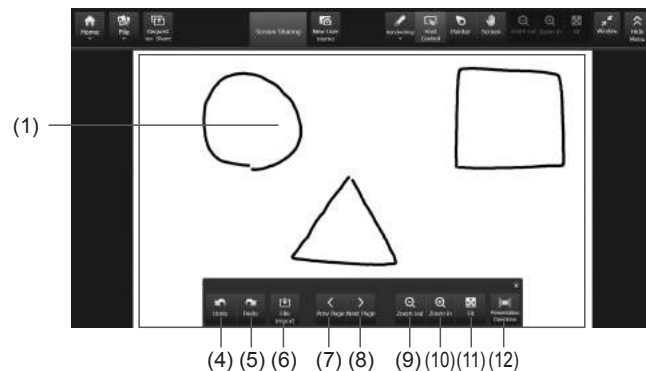

- (1) **Remote operation area**
Operate the host with this area. (Tap: left click, long touch: right click, drag: drag)
- (2) **Show/Hide operation menu**
Shows/hides the operation menu.
- (3) **Change operation menu position**
Changes the display position of the operation menu.
- (4) **Undo**
Undoes the previous operation.
- (5) **Redo**
Redoes the operation that was previously undone.
- (6) **File Import**
Imports a file with Pen Software.
- (7) **Display previous sheet**
Displays the previous sheet. Cannot be tapped when the first sheet is displayed.
- (8) **Display next sheet**
Displays the next sheet. Cannot be tapped when the last sheet is displayed.
- (9) **Zoom out**
Reduces the current sheet.
- (10) **Zoom in**
Enlarges the current sheet.
- (11) **Fit**
Returns the zoom ratio of the current sheet to 100%.
- (12) **Presentation operations**
Operates the host's Pen Software presentation support tool.

TIPS

- In host control mode, operation permission is automatically obtained from the host.
- When "Do not allow remote control" is selected in "Control Setting" for the host (page 33), remote operation is not possible.
- If you want to write with the host's Pen Software, use "Hand Writing". (page 18)

■ Remote operation (Pointer mode)

Displays the pointer on the host.

1. **Android/iOS device:** On the main screen on the client, tap [Open menu] - [Pointer].
Windows/Mac OS device: On the main screen on the client, tap [Pointer].

The client enters pointer mode. When you tap the client, the pointer is displayed at the corresponding part of the host.

Android/iOS Device

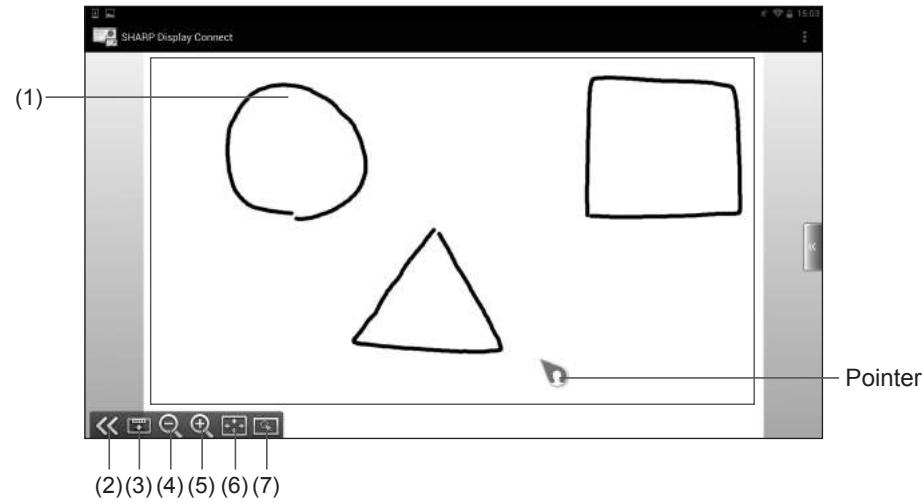

- (1) **Remote operation area**
Drag this area to move the position of the pointer on the monitor.
- (2) **Show/Hide operation menu**
Shows/hides the operation menu.
- (3) **Change operation menu position**
Changes the display position of the operation menu.
- (4) **Zoom out**
Reduces the current screen.
- (5) **Zoom in**
Enlarges the current screen.
- (6) **Fit**
Returns the zoom ratio of the current screen to 100%.
- (7) **Highlight pointer**
Highlights the position of the pointer on the host (monitor).

Windows/Mac OS Device

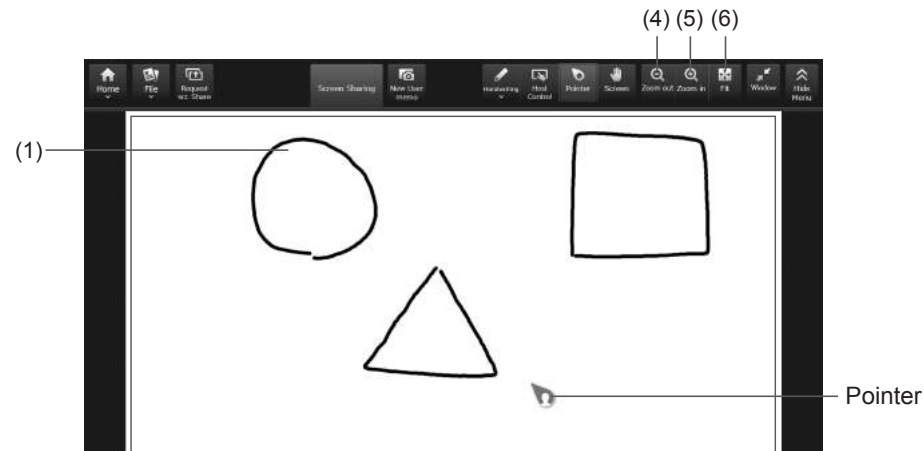

Handwriting on the screen of the monitor

You can handwrite a memo on the Pen Software screen of the host with a client.

1. **Android/iOS device: On the main screen on the client, tap [Open menu] - [Hand Writing].**
Windows/Mac OS device: On the main screen on the client, tap [Handwriting], and then select a pen.
2. **Draw on the handwriting area.**
 When you handwrite on the screen displayed on the client, the content that you write appears on the Pen Software screen of the host.

Android/iOS Device

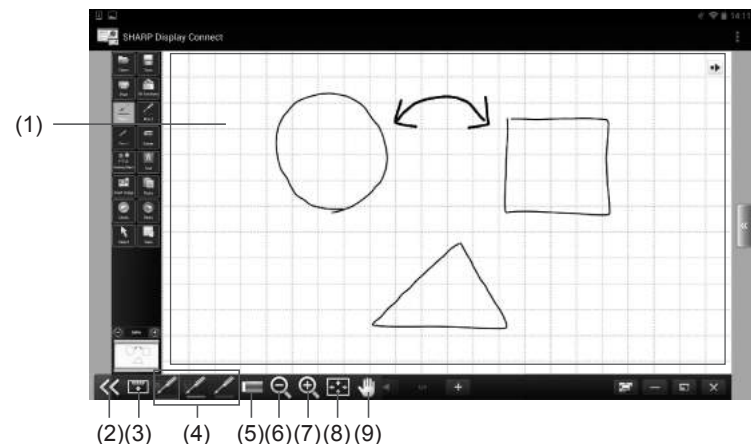

Windows/Mac OS Device

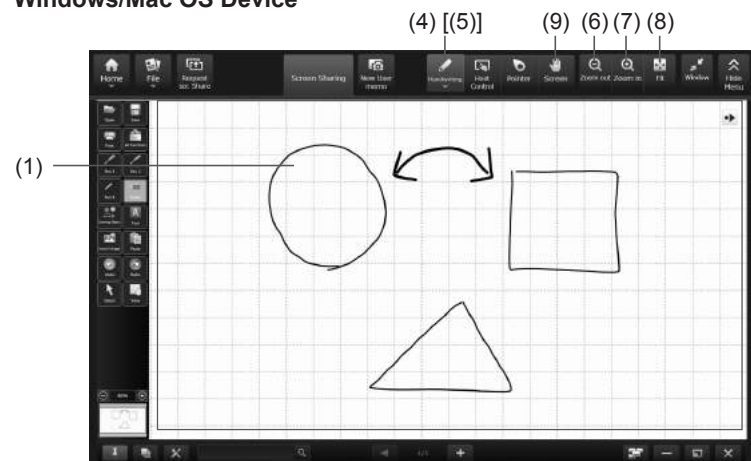

- (1) **Handwriting area:** The area where handwriting operations are possible.
- (2) **Show/hide operation menu:** Shows/hides the operation menu.
- (3) **Change operation menu position:** Changes the display position of the operation menu.
- (4) **Pen:** Configures the pens and draws text and graphics. (page 20)
 For Windows devices, touch and select the pen type from the displayed pull-down menu.
- (5) **Eraser:** Deletes a drawn line.
 For Windows devices, touch and select "Eraser" from the displayed pull-down menu.
- (6) **Zoom out:** Reduces the current screen.
- (7) **Zoom in:** Enlarges the current screen.
- (8) **Fit:** Returns the screen from an enlarged or reduced state to its normal size.
 The entire screen is displayed maintaining its aspect ratio.
- (9) **Screen:** Adjusts which portion of the screen to display.

TIPS

- In handwriting mode, operation permission is automatically obtained from the host.
- When "Do not allow remote control" is selected in "Control Setting" for the host (page 33), remote operation is not possible.
- Pen Software version 3.3 or later must be installed in order to use the Eraser function.

Handwriting by importing the screen

You can capture the screen displayed on the host, import it into the client, and draw on it with the client.

1. **Android/iOS device:** On the main screen on the client, tap [Open menu] - [User Memo].

Windows/Mac OS device: On the main screen on the client, tap [User Memo].

The screen displayed on the host is imported into the client.

2. **Draw on the handwriting area.**

Android/iOS Device

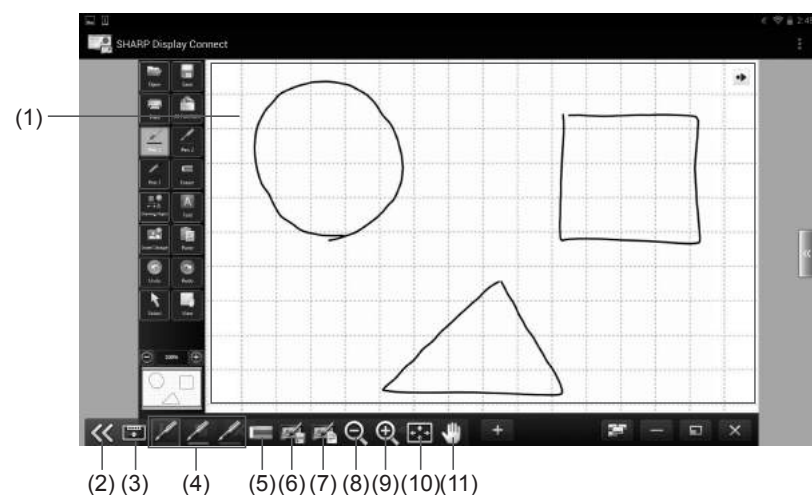

Windows/Mac OS Device

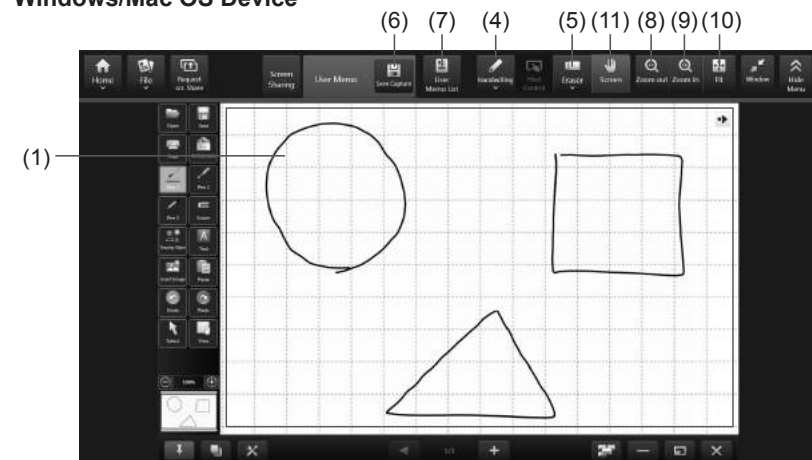

- (1) **Handwriting area:** The area where handwriting operations are possible.
- (2) **Show/hide operation menu:** Shows/hides the operation menu.
- (3) **Change operation menu position:** Changes the display position of the operation menu.
- (4) **Pen:** Configures the pens and draws text and graphics. (page 20)
For Windows devices, touch and select the pen type from the displayed pull-down menu.
- (5) **Eraser:** Deletes a drawn line.
- (6) **Save:** Saves the User Memo. (Save format: JPG)
- (7) **User Memo List:** Displays the history of User Memo. (page 20)
- (8) **Zoom out:** Reduces the current screen.
- (9) **Zoom in:** Enlarges the current screen.
- (10) **Fit:** Returns the screen from an enlarged or reduced state to its normal size.
The entire screen is displayed maintaining its aspect ratio.
- (11) **Screen:** Adjusts which portion of the screen to display.

TIPS

- When the “Prohibit acquisition of user memos” (page 33) check box is selected, you cannot import screen images.

■ Configuring the pen

Configure the pen settings when using the pen function in User Memo or handwriting.

1. **Android/iOS/Mac OS device: On the User Memo or handwriting screen, tap [Pen].**
Windows device: On the User Memo or handwriting screen, tap [Handwriting], and tap [Edit] for "Pen1 - 3".

The pen settings dialog appears.

2. **Configure the pen settings.**

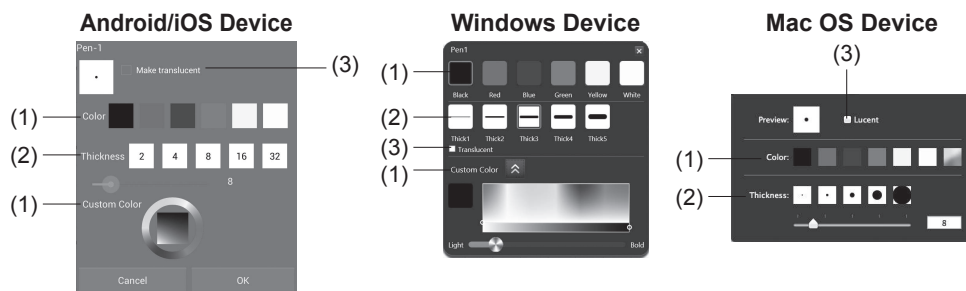

- (1) **Color/Custom Color**
Selects the line color.
- (2) **Thickness**
Selects the line thickness.
- (3) **Make translucent**
Select this check box to make the line translucent.

3. **Android/iOS device: When finished configuring the settings, tap [OK].**
Windows device: When finished configuring the settings, tap [X].
Mac OS device: When finished configuring the settings, tap [Pen].

■ Viewing past User Memo

A list of User Memos saved in the past can appear.

1. **On the User Memo screen, tap [User Memo List].**
The User Memo List appears.

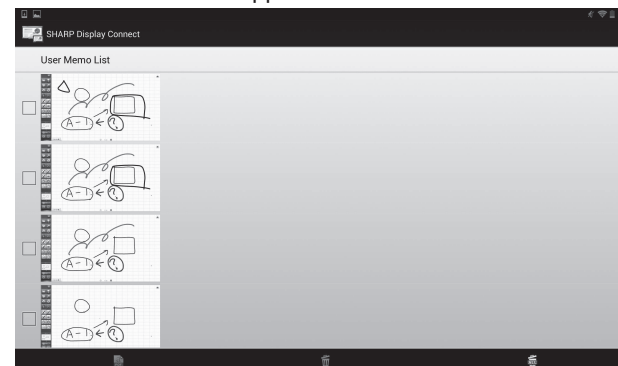

Saving

User Memo can be saved as PDF files.

Android/iOS device

1. **On the User Memo List, tap the image you want to save. (You can select multiple images)**
2. Tap [Output PDF] (PDF icon).

Windows/Mac device

1. Tap [Output PDF] (PDF icon).

Deleting (Android/iOS devices only)

1. **On the User Memo List, tap the image you want to delete. (You can select multiple images)**
2. Tap [Delete] (trash icon).

To delete all of the images, tap [Clear All] (ALL icon).

Sending files from the host to the client

You can send files from the host to the client. (Recommended file size: 10MB or less)
It is possible to send images, documents, and other data files.

Host operation

You can send files from the host to the client.

1. In the Host menu, tap [Send File].
2. Tap [Select File], select files to transfer (multiple files can be selected), and tap [Open].
Or select files to transfer using a drag-and-drop operation.

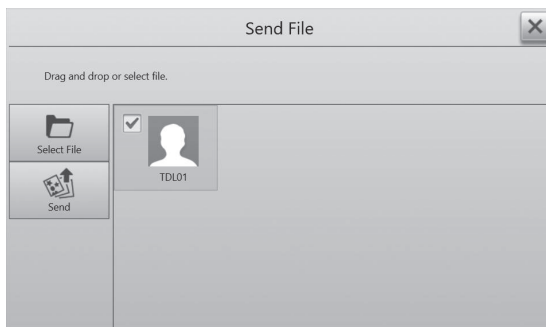

3. Select a destination user.
Tapping [Select All] selects all destination users. To cancel, tap [Cancel All].
4. Tap [Send].
The selected files are sent to the client.

Client operation

1. **Android/iOS device:** On the main screen on the client, tap [Open menu] - [Received Files].
Windows/Mac OS device: On the main screen on the client, tap [File] - [Open Receive Folder].

A list of files received from the host appears.

Android Device

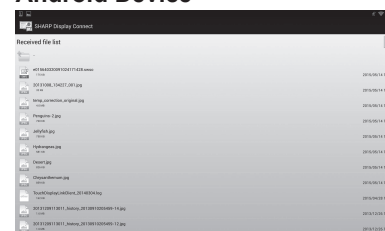

iOS Device

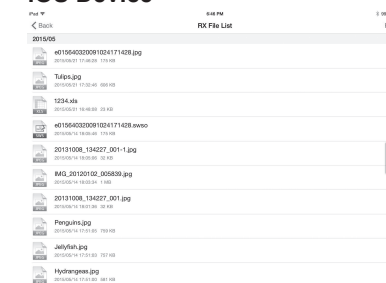

Windows Device

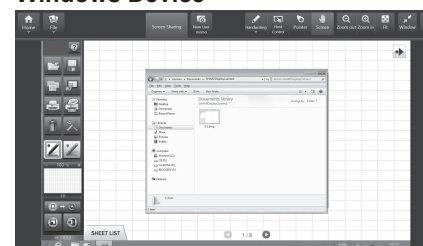

Mac OS Device

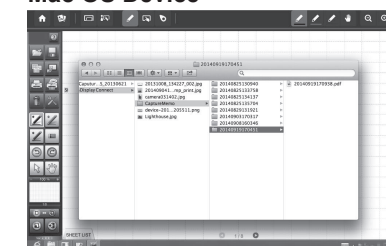

Sending files from the client to the host

You can send files from the client to the host. (Recommended file size: 10MB or less)
It is possible to send images, documents, and other data files.

Client operation (Android/iOS Device)

1. On the main screen on the client, tap [Send File].
2. Tap [Open menu] on the right of the screen.
A menu appears.

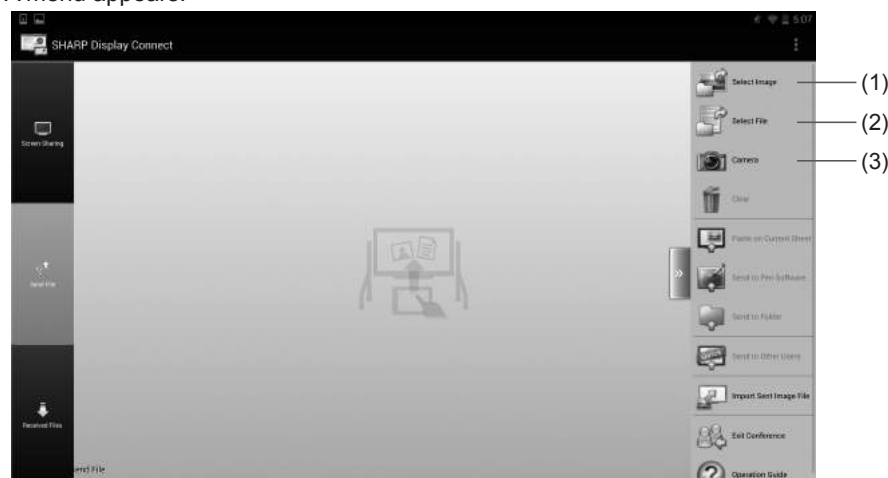

3. Select the files you want to send.

(1) Select Image

Selects images saved on the client.

→Selecting images (See the description on the right.)

(2) Select File

Selects files saved on the client.

→Selecting files (page 24)

(3) Camera

Starts the camera and selects captured data as images.

→Camera (page 23)

When a file is selected, the selected file appears.

To cancel selected files, tap [Clear].

4. Select a transfer method and send the files. (page 24)

TIPS

While a client is sending files to the host, other clients cannot send files to the same host.

Selecting images

You can send image files to the host.

1. From the Send File screen, tap [Open menu] and then tap [Select Image].

2. Select images.

If using an Android device, select images from “Gallery”.

If using an iOS device, select images from “Photos”.

Image previews are displayed for JPEG and PNG files. For other image files, an icon

 is displayed. (page 24)

TIPS

- For details on selecting images, refer to the client manual.

■ Scan by camera (iOS Device)

When you take a picture of paper documents or other materials, scan by camera can detect the dimensions of the paper and make an image with only that area.

TIPS

- The normal camera starts for models that do not support scan by camera. The captured image is displayed in the preview area. (page 24)

1. **From the Send File screen, tap [Open menu] and then [Camera].**
Scan by camera is started.

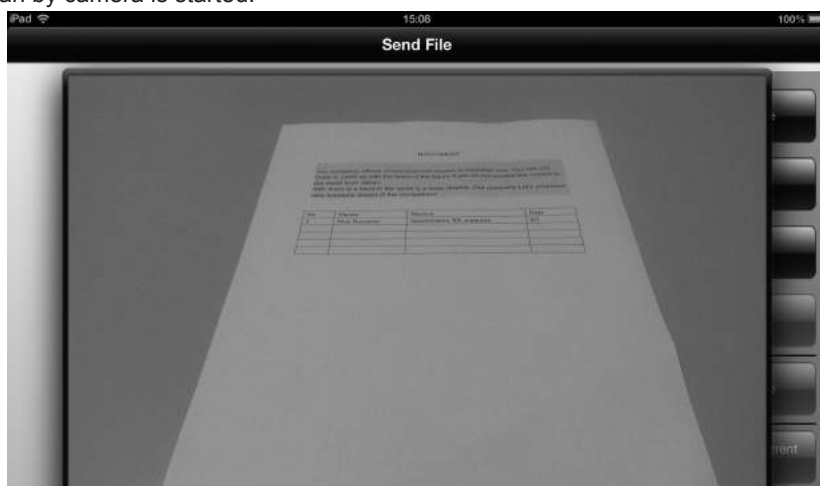

2. **Tap [Take photo].**

- If the "Detect Paper" check box is selected, a cropping frame (purple) is displayed at the portion where the paper is detected in the image.
When the paper detection is successful, [?] in the upper right of the screen changes to [OK].
- If the "Auto Shutter" check box is selected, the image is captured automatically when the paper is successfully detected.
This option can only be selected when "Detect Paper" is enabled.

3. **Correct the image.**

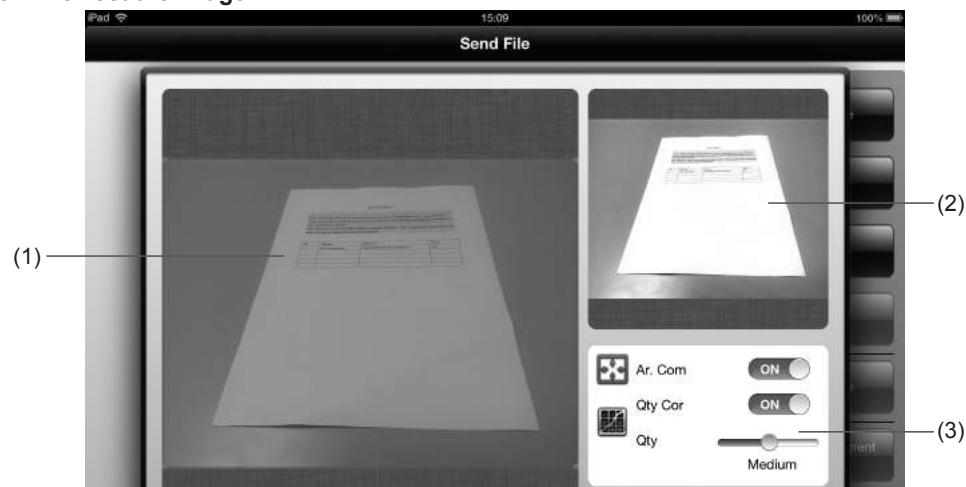

- (1) **Original image display area**
Shows the original image before it is corrected.
When "Ar. Com" is enabled, the cropping frame (purple) for the portion detected as the paper is displayed. The cropping frame area can be modified by dragging it.
 - (2) **Corrected preview display area**
Shows the preview of the image after correction.
 - (3) **Adjust image quality level**
When "Qty Cor" is enabled, you can adjust the image quality level.
Drag the slider to the left and right to adjust.
4. **Tap [OK].**
The image preview appears. (page 24)

TIPS

- It may not be possible to properly correct the image depending on the capturing environment and the original document.

■ Selecting files



You can send files saved on a client to the host.

1. From the Send File screen, tap [Open menu] and then [Select File].

A list of files appears.



2. Select files.

- Tapping a folder () displays a list of the files in the folder in question.
Tapping  displays a list of files in the folder above the current folder.
(Above functions only available on Android devices.)
- When an image file (JPEG or PNG) is selected, an image preview is displayed. (See the description on the right.)
- When an image file (except for a JPEG or PNG) or non-image file is selected, a file icon is displayed in the preview display area.
- If the file extension is not recognized by the client, the default icon () is displayed.

■ Sending selected files

When files to be sent are selected, a preview screen is displayed.

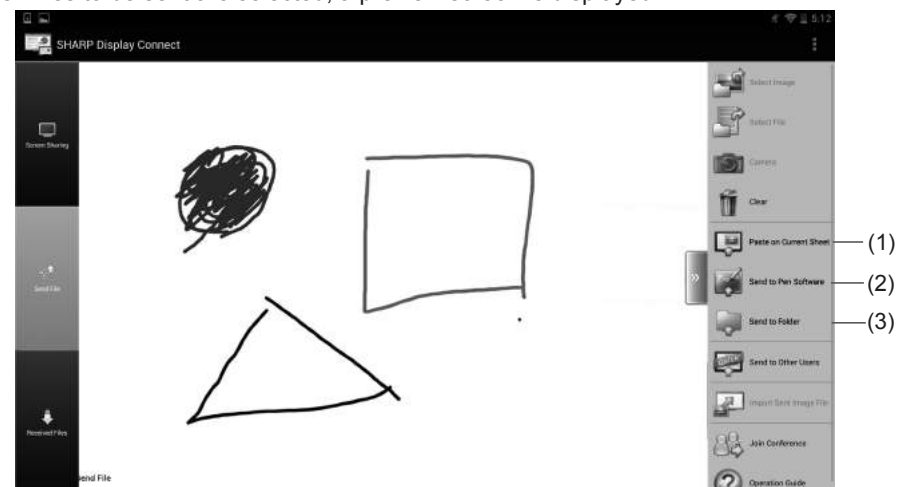

1. Tap [Open menu].

2. Select a transfer method and send the files.

- (1) Paste on Current Sheet
The selected images are pasted to the current sheet of the whiteboard in Pen Software.
- (2) Send to Pen Software
Imports selected files as images just like those printed on a printer to the whiteboard in Pen Software.
- (3) Send to Folder
Sends and saves selected files to a specified host folder.

TIPS

- If you tap "Adjust Image", you can correct the selected image. (page 23)

* The method by which a file can be sent differs according to file type.

Paste on Current Sheet	JPEG (.jpe, .jpeg, .jpg), PNG (.png)
Send to Pen Software	JPEG (.jpe, .jpeg, .jpg), PNG (.png), TIFF (.tif, .tiff), PDF (.pdf)*1*3, Excel (.xls, .xlsx)*2*3, Word (.doc, .docx)*2*3, PowerPoint (.ppt, .pptx)*2*3
Send to Folder	All types (It is not possible to send certain file types.)

*1: Requires that Adobe Reader is installed on the host.

*2: Requires that Microsoft Office is installed on the host.

Password-Protected Files and macro-enabled files will not work correctly.

*3: Files cannot be sent to a lite version host.

TIPS

- When the image displayed on the preview screen is flicked up, it can be sent using "Paste on Current Sheet".
- When the "Shake to Send File" check box is selected, you can send an image with "Paste on Current Sheet" by holding the client on the preview screen and gently shaking it.
- * Take care not to drop the device.
- Files cannot be sent if the "Accept file" check box on the host is not selected.
- Pen Software may operate slowly if high-resolution images are used.
- When sending PDF files to Pen Software, ensure that the Adobe Reader license agreement and dialog is not displayed. If they are displayed, the application will not function correctly.

CAUTION

- Do not change the name of "Send print data to SHARP Pen Software" in "Devices and Printers". If the name is changed, the application will not function correctly.

Client operation (Windows/Mac OS device)

1. On the main screen on the client, tap [File].
2. Tap [Send to Host].
3. Select the file and tap [Open].
4. Select a transfer method and send the files.

Windows Device

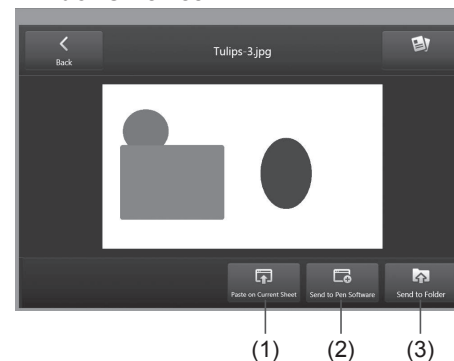

Mac OS Device

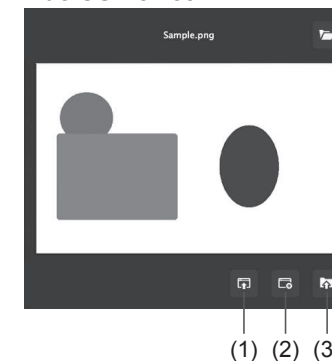

- (1) Paste on Current Sheet
The selected images are pasted to the current sheet of the whiteboard in Pen Software.
- (2) Send to Pen Software
Imports selected files as images just like those printed on a printer to the whiteboard in Pen Software.
- (3) Send to Folder
Sends and saves selected files to a specified host folder.

Host operation

Files sent using “Paste on Current Sheet”

- Images received from a client are pasted to the Pen Software whiteboard.

Files sent using "Send to Pen Software"

- When data is received from a client, "Import images" () in Pen Software (whiteboard mode) flashes. Tapping “Import images” imports the data.
- For Pen Software version 3.0, the receive data dialog box is displayed. Tap the dialog box to import the data.

TIPS

- Refer to “Importing a Document as an Image (Pen Software Printer Driver)” in the Pen Software Operation Manual.
- You can also import data by tapping "Import Sent Image File" in the client menu.
- When sending a PDF file from the client and pasting it into Pen Software, configure the print settings in Adobe Reader as follows in advance. If you do not configure the settings, the PDF file may not be pasted in the intended direction.
 - Select the [Choose Paper Source by PDF page size] check box
 - Clear the [Auto-Rotate and Center] check box or select [Auto portrait/landscape] in [Orientation]

The name of the item differs according to the version of Adobe Reader. Refer to the Adobe Reader manual.

Files sent using “Send to Folder”

- Tapping [Open Receive Folder] in the Host menu opens the folder where files received from the client are stored.

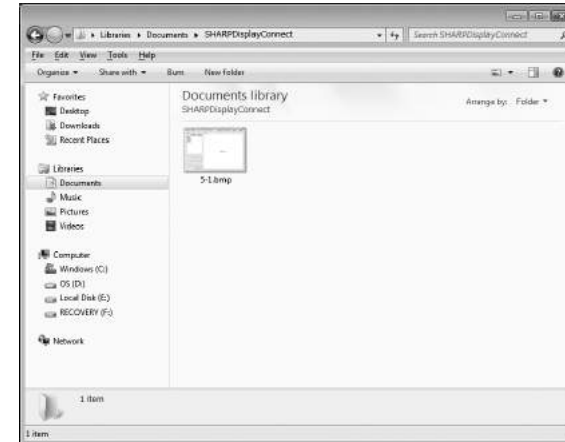

Transferring files between clients

You can transfer files between clients without them being connected to the host. First set the client that will receive the file to the standby to receive state, and then send the file from the other client. (Recommended file size: 10MB or less)

Receiving-side operation

Android/iOS device

1. On the receiving-side client, tap [Received Files].
2. Tap [Open menu] on the right of the screen.
3. Tap [Receive from Others].

The client enters the standby to receive state.

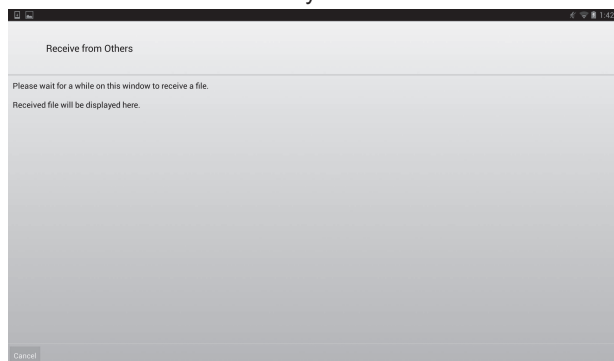

When a file is received, you are notified of that on the screen. You can view the received file in the received folder. (page 28)

Tap [Cancel] to end the standby to receive state.

Windows/Mac OS device

1. On the main screen on the receiving-side client, tap [File].
2. Tap [RX from Other Users].
The client enters the standby to receive state.

When a file is received, you are notified of that on the screen. You can view the received file in the received folder. (page 30)

Tap  to end the standby to receive state.

Sending-side operation

TIPS

- Do not send files from multiple devices at the same time. Depending on the network environment, this may not work correctly.

Android/iOS device

1. On the sending-side client, tap [Send File].
2. Tap [Open menu] on the right of the screen.
3. Select the file to send. (page 22)
You cannot send an adjusted image file.
4. Tap [Open menu] - [Send to Other Users].
Clients in the standby to receive state are displayed in a list.
5. Tap the destination.
6. Tap [OK].
7. Tap [Yes].

Windows/Mac OS device

1. On the main screen on the sending-side client, tap [File] - [Send to Other Users].
2. Select the file to send.
Clients in the standby to receive state are displayed in a list.
3. Tap the destination.
4. Tap [↑].

Opening files

You can open files received.

On Android devices you operate files in the Downloads folder on the SD card.

On iOS devices you operate files saved on the device's own memory

Android/iOS device

1. On the main screen on the client, tap [Received Files].
2. Select the list to display.
The selected file list appears.



- (1) Displays the folder that is up one level in the folder hierarchy.
- (2) You can select and delete files.

TIPS

- If the file extension is not recognized by the client, the default icon () is displayed in a list.

3. Select file.

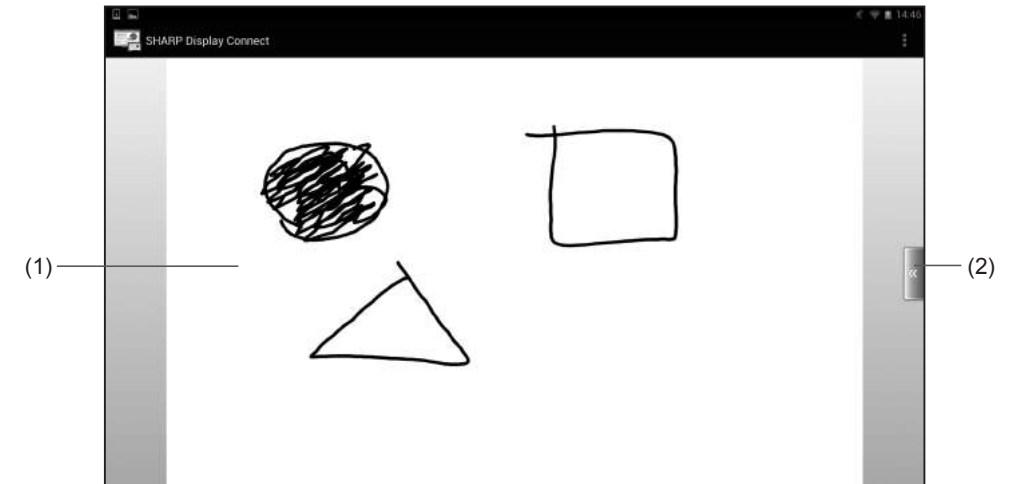

- (1) **Preview area**
The area where a preview of the selected file is displayed.
Zoom in or out by pinching in or out.
If previews cannot be displayed, an icon image for each type of data is displayed.
Android devices can display previews of JPEG and PNG files.
iOS devices can display previews of JPEG, PNG, TIFF, PDF, Excel (.xls/.xlsx), Word (.doc/.docx), and PowerPoint (.ppt/.pptx) files. (Layouts may not be displayed correctly.)
- (2) **Open/Close menu**
Shows/hides the Preview screen menu.

4. Tap [Open menu].

The file open menu appears.

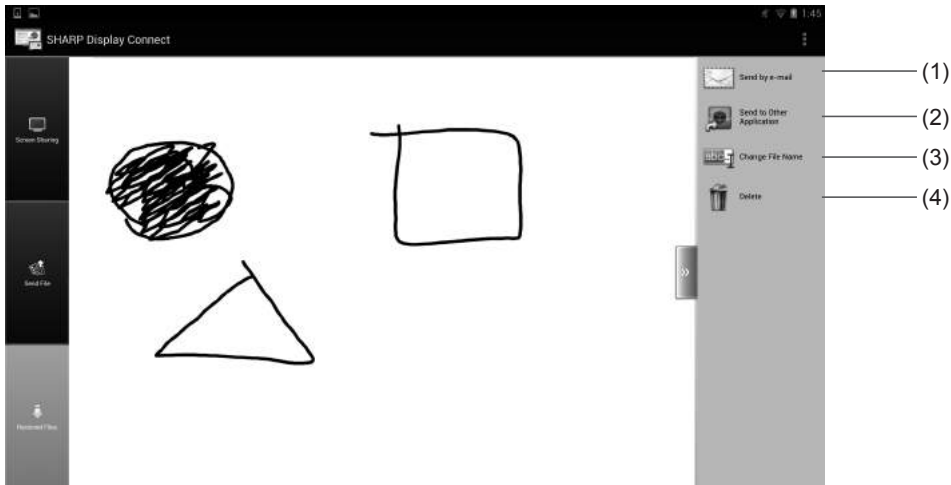

- (1) **Send by e-mail**
Attaches the selected files to an e-mail. (See the description on the right.)
- (2) **Send to Other Application**
Displays the selected files in the specified application. (page 30)
- (3) **Change File Name**
Edits the name of the selected file. (page 30)
- (4) **Delete**
Deletes selected files (page 30)

TIPS

- The above actions can also be made by long-pressing a file name from the list and displaying a popup menu. (Android devices only)

■ Sending files by e-mail

You can send a selected file as an e-mail attachment.

The e-mail application installed on the client is started up.

1. From the file operation screen, tap [Open menu] and then tap [Send by e-mail].



2. Enter the necessary details and send the e-mail.

For details on sending e-mail, refer to the client manual.

TIPS

- If several applications are installed, a message prompting you to select an application may appear.

■ Sending files to an application

You can open the selected file in an application.

1. From the file operation screen, tap [Open menu] and then tap [Send to Other Application].

If the file can be opened in multiple applications, a message saying prompting you to select an application may appear.

Select an application.

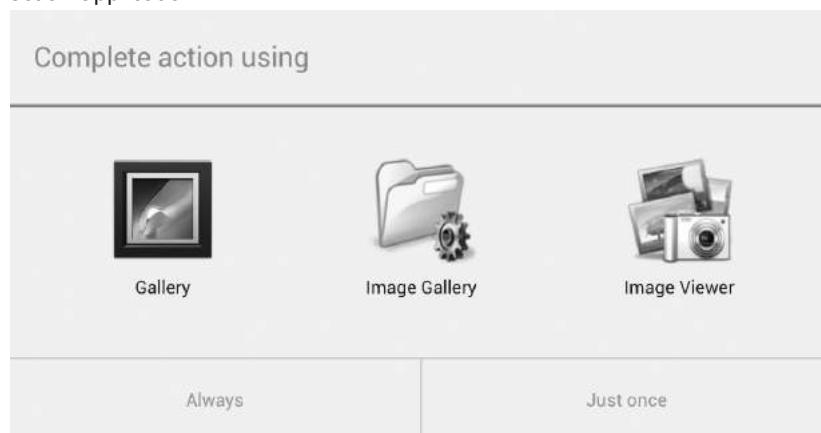

TIPS

- The applications displayed will differ depending on the applications installed on the client.

■ Editing file names

You can edit the name of the selected file.

1. From the file operation screen, tap [Open menu] and then [Change filename].

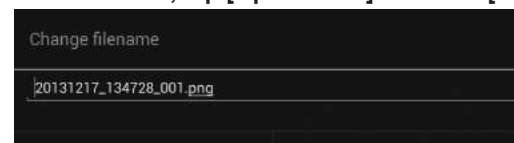

2. Edit the name of the file in the file name entry field.
3. Tap [Yes].

■ Deleting files

You can delete the selected files.

1. Tap [Edit].
2. Select the file you want to delete.
3. Tap [Delete].
4. Tap [Yes].

Windows/Mac OS device

1. On the main screen on the client, tap [File] - [Open Receive Folder].
The folder that stores received files opens.

Viewing Operation Guide

You can display operation guides.

1. **Android/iOS Device: Tap [Open menu].**
Windows/Mac OS Device: Tap [Home].
2. **Tap [Operation Guide].**

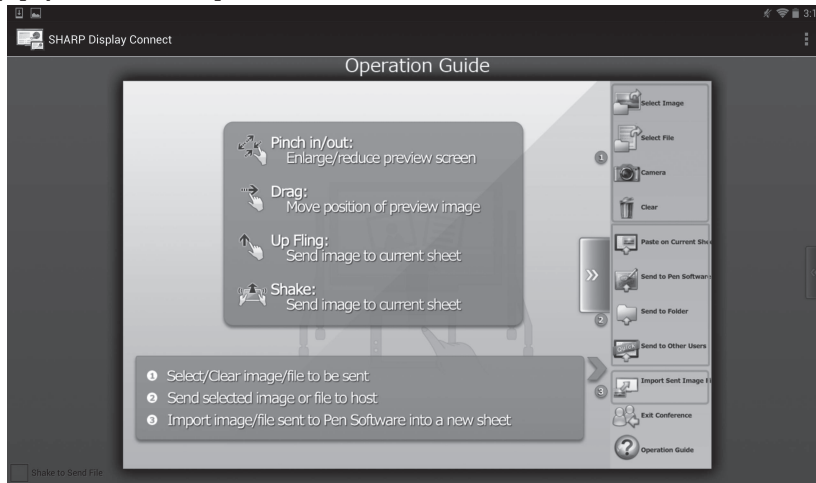

To close the screen,

Android/iOS device: Tap the screen.

Windows device: Tap .

Mac OS device: Tap .

Connecting hosts

- You can connect hosts on the same network to share screens and perform remote operation.
- Depending on the network environment, the amount of time for processing may increase.

Connecting to another host

1. On the Host menu, tap [Connect to Other].
For a lite version host, tap [Remote Meeting] on the launcher screen.
The connection selection screen appears.
2. Tap [Manual Input] and enter the IP address and name of the host.

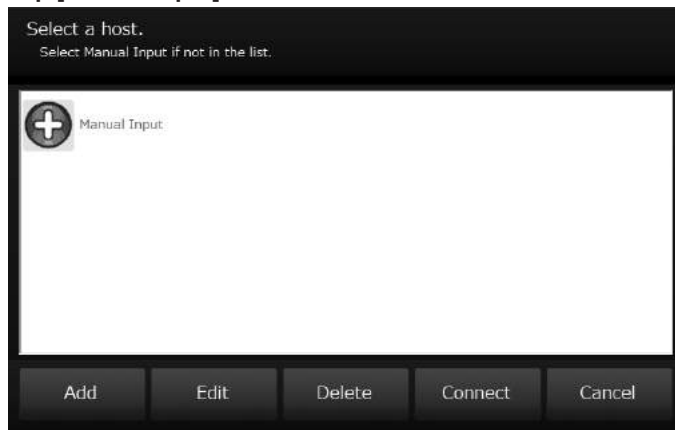

When the “Add to the list of hosts” check box is selected, the entered host is displayed in the connection selection screen from the next time.

3. Tap [Connect].

TIPS

- To create a new connection, tap [Add].
- To edit/delete a connection, select the connection, and then tap [Edit]/[Delete].
- Connection between hosts is possible using a VPN. Consult your network administrator for the settings when using a VPN.

Operations when connected

You can operate the connected host.

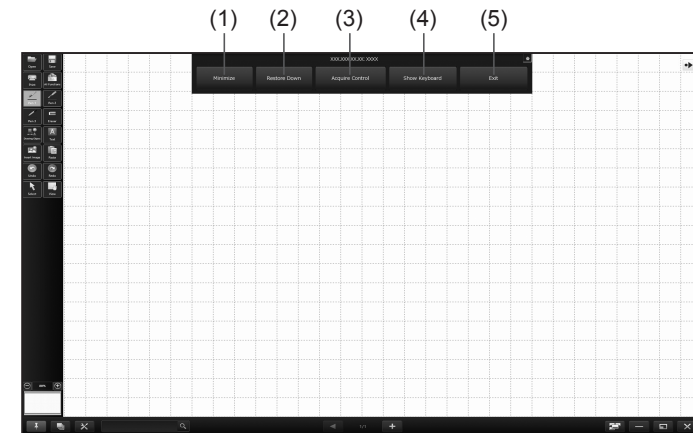

- (1) **Minimize**
Minimizes the screen.
- (2) **Maximize/Restore Down**
Maximizes the screen. When the screen is maximized, this restores the screen to its previous size.
- (3) **Acquire Control/Release Control**
Tap [Acquire Control] when obtaining remote operation permission for the connected host. When you obtain operation permission, you can operate the screen displayed on the connected host.
Tap [Release Control] to release the obtained operation permission.
- (4) **Show Keyboard**
Displays the software keyboard to enable character input.
Input is possible when you have obtained operation permission.
- (5) **Exit**
Ends the connection with the host.

TIPS

- To operate the Pen Software on the connected device, change the Pen Software settings.
 - For Pen Software version 3.0 or later, in the Pen Software settings, set the “Touch Pen” setting to “Finger or Other Pen”.
 - For Pen Software version 2.9, set “Pen Drawing” to “Both touch pen and finger” and clear the “Use auto switching” check box.
- Operating connected host from multiple hosts simultaneously may result in erratic behavior.

Configuring host settings

You can configure a variety of settings including those for the host name, communications, security, and action when a file is received.

TIPS

- Before adjusting these settings, consult the network administrator.

1. Tap the **[Settings]** on the Host menu.
The settings screen appears.
2. Set the options as necessary. (See the description below.)
3. When you have completed the settings, tap **[Apply]**.

■ [Basic Setting] tab

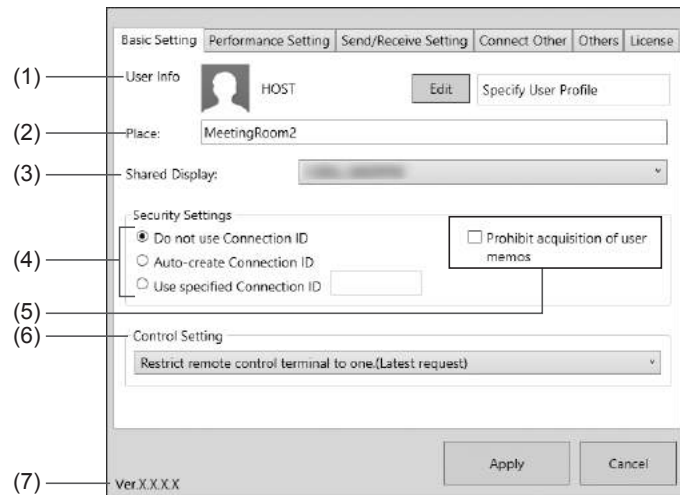

- (1) **User Info**
Tap **[Edit]** and set the host name and icon. (Up to 6 full-width or 12 half-width characters)
This name and icon is displayed on the client when logging in.
- (2) **Place**
Sets the location of the host. (Up to 50 half-/full-width characters)
Content entered here is displayed on the client's login screen.
- (3) **Shared Display**
Selects the display for which the screen will be shared with the client.
- (4) **Connection ID**
Do not use Connection ID
Does not restrict the connected clients.
Auto-create Connection ID
Restricts the connected clients to only those that enter the connection ID.
Automatically creates a connection ID for each conference.
Use specified Connection ID
Restricts the connected clients to only those that enter the connection ID.
Sets the connection ID. (Up to 8 half-width alphanumeric characters)
- (5) **Prohibit acquisition of user memos**
Prevents the client from managing user memos.
- (6) **Control Setting**
Allow remote control from multiple computers
Remote control is possible from multiple clients at the same time.
Restrict remote control terminal to one. (Latest request)
Remote control is only possible for the client that obtains operation permission.
Restrict remote control terminal to one. (Admittion by host)
Remote control is only possible for the client that the host grants operation permission to.
Do not allow remote control
Remote control is not possible from a client.
- (7) **Version**
Shows the software version.

■ [Performance Setting] tab

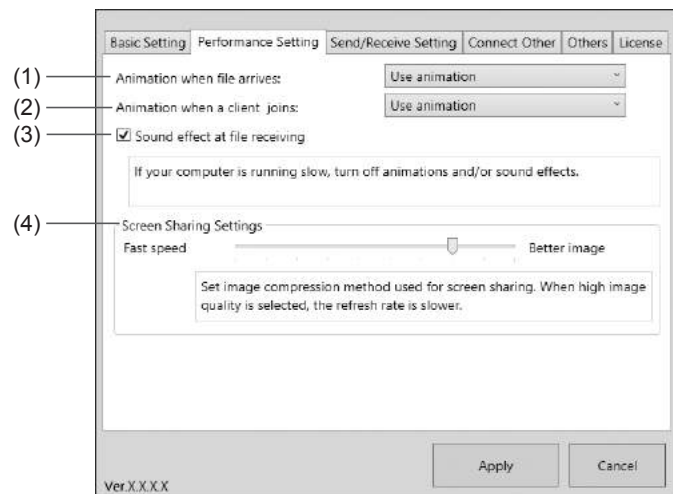

- (1) **Animation when file arrives**
Selects whether to use animation when a file is received.
- (2) **Animation when a client joins**
Selects whether to use animation when a user joins a meeting.
If the computer is slow, select "Do not use animation".
- (3) **Sound effect at file receiving**
Select this option if you want a sound effect to be played when a file is received.
- (4) **Screen Sharing Settings**
Adjusts whether to give priority to speed (low image quality) or image quality (slow speed) when screen sharing.
Drag the slider in either direction to adjust.

■ [Send/Receive Setting] tab

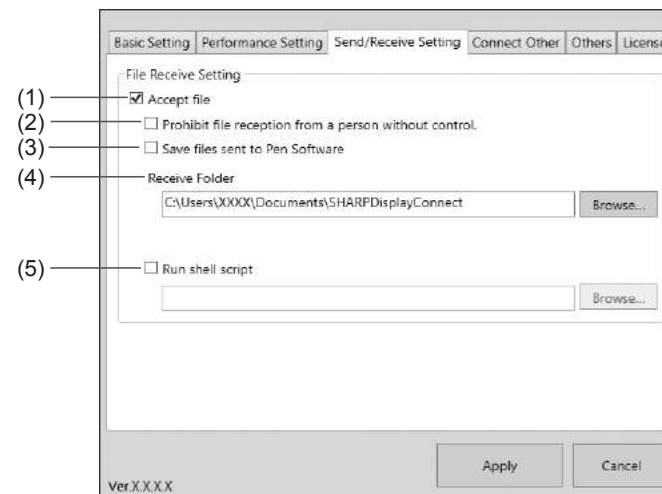

- (1) **Accept file**
Clear this check box if you want to prevent clients from sending files to the host.
- (2) **Prohibit file reception from a person without control.**
Select this check box to disallow receiving files from clients that have not obtained operation permission.
- (3) **Save files sent to Pen Software**
Select this check box to save files sent from a client to the host using "Paste on Current Sheet" or "Send to Pen Software".
If this check box is selected, files are saved in the folder specified in "Receive Folder".
- (4) **Receive Folder**
Specifies the host folder in which to save received files when sending a file using "Send to Folder".
- (5) **Run shell script**
Sets whether to run a shell script on received files.
To run a shell script, select the "Run shell script" check box, and select a script.
The number of characters in the file path and file name may differ depending on the type of computer used.
For details, refer to the computer manual.

■ [Connect Other] tab

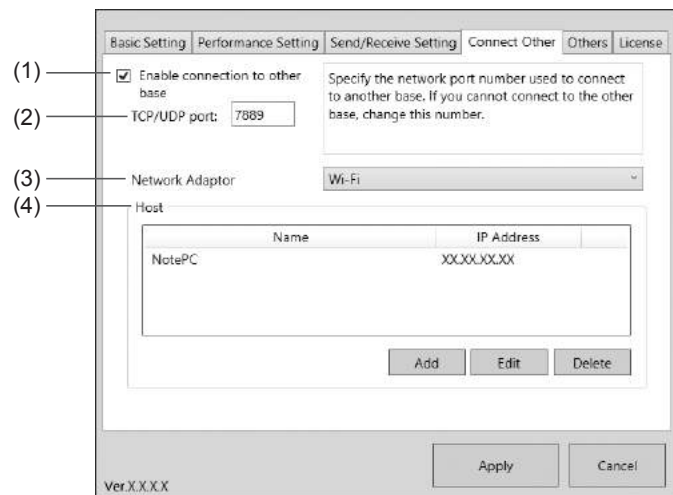

- (1) **Enable connection to other base**
Enables or disables connections with other hosts.
To disallow connections from other hosts, clear this check box.
- (2) **TCP/UDP port**
Sets the port number to use for TCP/IP communication with other hosts.
- (3) **Network Adaptor**
Selects the network adaptor to use for connecting to other hosts.
- (4) **Host**
Enters or deletes connection information (name, IP address).
The entered information is displayed in the connection selection screen on the Connect to Other function.

■ [Others] tab

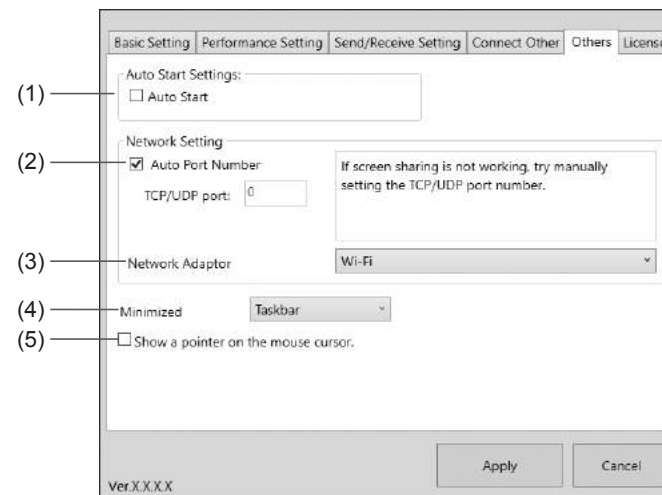

- (1) **Auto Start**
Select this check box to start this software (host) automatically when the computer starts.
This setting is set for each login user.
- (2) **TCP/UDP port**
Sets the port number to use for communicating with clients.
You should normally select the “Auto Port Number” check box. This automatically sets the port number.
To set an arbitrary port number, clear the “Auto Port Number” check box, and enter a port number (from 0 to 65535) in the “TCP/UDP port” box.
- (3) **Network Adaptor**
Selects the network adaptor to use for connecting to clients.
- (4) **Minimized**
Selects whether to store the host menu when minimized in the taskbar/toolbar.
- (5) **Show a pointer on mouse cursor.**
Select this check box to display a pointer at the mouse cursor position.

■ [License] tab

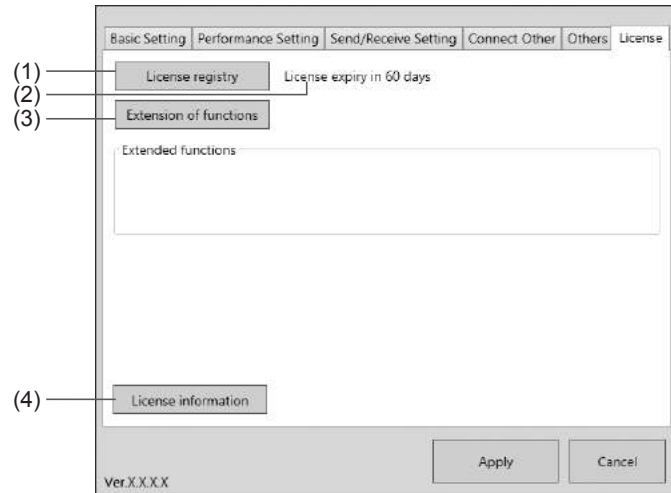

- (1) **License registry**
To officially register software that has already been registered with a trial license, enter a license code.
- (2) **Remaining number of days in trial period**
Shows the number of days of the trial period remaining if the software is registered with a trial license.
- (3) **Extension of functions**
Use an extension license code (sold separately) to extend the functions of this software.
(This is not a guarantee that extension license codes will be provided in the future.)
Extended functions are displayed under “Extended functions”.
- (4) **License information**
Shows software license information.

Configuring client settings (Windows/Mac OS device)

1. Tap [Home].
2. Tap [Settings].
3. Set the options as necessary.
4. **Windows device:** When you have completed the settings, tap [Apply].

Mac OS device: When you have completed the settings, tap [OK].



■ [Basic Setting] tab (Windows Device)

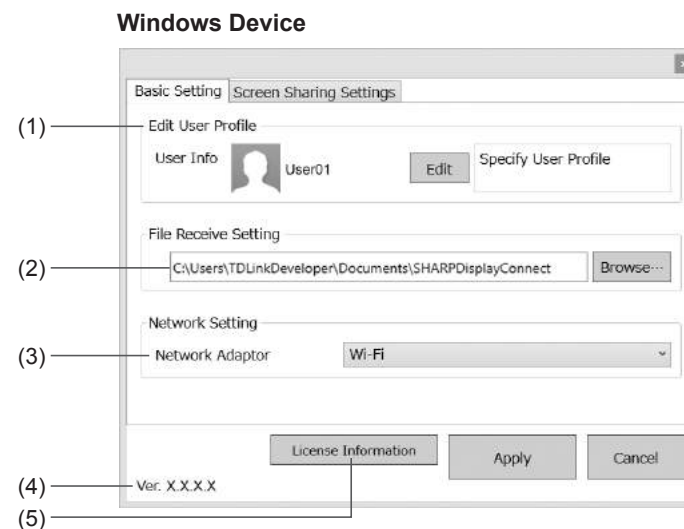

- (1) **Edit User Profile**
Set the name and icon. (Up to 6 full-width or 12 half-width characters)
This name and icon is displayed on the host when logging in.
This setting is shared with the host. (Windows devices only)
On a Windows device, tap [Edit].
To change the icon on a Mac OS device, tap the icon.
- (2) **Receive Folder**
Specifies the folder in which to save files received from the host or other client.
This setting is shared with the host. (Windows devices only)
- (3) **Network Adaptor**
Selects the network adaptor to use for connecting to host.
- (4) **Version**
Shows the software version.
- (5) **License Information**
Displays the license information for this software.

■ [Screen Sharing Settings] tab (Windows Device)

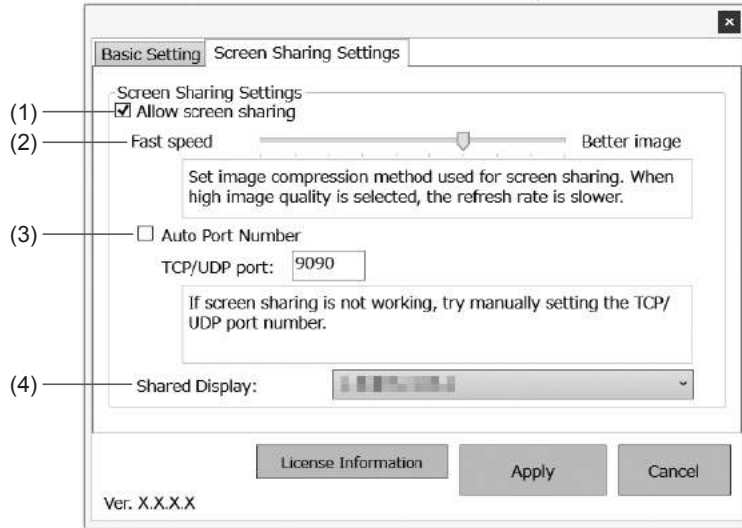

- (1) **Allow screen sharing**
Select this check box to allow screen sharing. (page 14)
- (2) **Performance Setting**
Adjusts whether to give priority to speed (low image quality) or image quality (slow speed) when allowing screen sharing.
Drag the slider in either direction to adjust.
- (3) **Auto Port Number**
Sets the port number to use for communicating with clients.
You should normally select the “Auto Port Number” check box. This automatically sets the port number.
To set an arbitrary port number, clear the “Auto Port Number” check box, and enter a port number (from 0 to 65535) in the “TCP/UDP port” box.
- (4) **Shared Display**
Selects the monitor for which the screen will be shared during screen sharing.

Exiting the application

Host (full version only)

1. Tap [Exit] on the Host menu screen.

TIPS

- If public files have been set, a dialog box confirming that you want to delete the public files appears. If you want to delete the files, tap [Delete and exit]. If you do not want to delete the files, tap [Exit w/o delete].

Client

Android device

1. Press the [Back] key twice.

iOS device

1. Press the [Home] key.
2. Press the [Home] key on the Home screen twice.
A list of currently running applications appears at the bottom of the screen.
3. Long-press [SDConnect].
The icon vibrates.
4. Tap [-] at the top left.

Windows device

1. Tap [Home].
2. Tap [Exit].

Mac OS device

1. Tap [SHARP Display Connect] on the menu bar.
2. Tap [Quit SHARP Display Connect].

Uninstalling the software

Host

TIPS

- Ensure you are logged in with administrator privileges.
- This operation is only for the full version.

1. **Exit all application software.**
2. **From the “Start” menu, select “Control Panel”.**
3. **Tap “Uninstall a program”.**
In icon display mode (classic view), double-tap “Programs and Features”.
4. **Select [SHARP Display Connect] and then tap [Uninstall].**
5. **Follow the instructions on the screen.**
If a User Account Control window appears, tap [Continue].

This completes the uninstallation process.

Client

Android device

1. **Press the [Menu] key, and then tap [Settings], [Applications], and [Manage applications].**
2. **In the list of applications, tap [SHARP Display Connect].**
3. **Tap [Uninstall].**

iOS device

1. **Long-press [SDConnect].**
The icon vibrates.
2. **Tap the black [x] at the top left.**
A confirmation dialog appears.
3. **Tap [Delete].**

■ Windows device

TIPS

- Ensure you are logged in with administrator privileges.
1. **Exit all application software.**
 2. **From the "Start" menu, select "Control Panel".**
 3. **Tap "Uninstall a program".**
In icon display mode (classic view), double-tap "Programs and Features".
 4. **Select [SHARP Display Connect] and then tap [Uninstall].**
 5. **Follow the instructions on the screen.**
If a User Account Control window appears, tap [Continue].

■ Mac OS device

TIPS

- To uninstall, an administrator name (user name) and password are required.
1. **Start Launch Pad.**
 2. **Long-press [SHARP Display Connect].**
 3. **Tap [x] at the top left.**
A confirmation dialog appears.
 4. **Tap [Delete].**
When the screen for entering the name and password appears, enter the name and password of the administrator, and then tap "OK".

Trademarks

- Microsoft, Windows, Windows Vista, Excel, and PowerPoint are either registered trademarks or trademarks of Microsoft Corporation in the United States and/or other countries.
- Apple, App Store, Mac, Mac OS, MacBook Pro and MacBook Air are trademarks of Apple Inc., registered in the U.S. and other countries. iPad and iPhone are trademarks of Apple Inc.
- Google, Android and Google Play are trademarks or registered trademarks of Google Inc.
- The trademark, Android, is used under license from Google Inc.
- Adobe, Acrobat, and Reader are either registered trademarks or trademarks of Adobe Systems Incorporated in the United States and/or other countries.
- microSD and microSDHC are trademarks of the SD Association.
- The trademark, iOS, is used under license from Cisco Systems, Inc., in the U.S. and other countries.
- Intel, Celeron, and Intel Core are trademarks or registered trademarks of Intel Corporation or its subsidiaries in the U.S.A. and other countries.
- AMD, AMD Sempron, AMD Athlon, and combinations thereof are trademarks of Advanced Micro Devices, Inc.
- This software uses the ImageKit7 technology. ImageKit7 Copyright © 2005 Newton Corp.
- All other brand and product names are trademarks or registered trademarks of their respective holders.

OpenCV License Agreement

License Agreement
For Open Source Computer Vision Library

Copyright (C) 2000-2008, Intel Corporation, all rights reserved.
Copyright (C) 2008-2010, Willow Garage Inc., all rights reserved.
Third party copyrights are property of their respective owners.

Redistribution and use in source and binary forms, with or without modification, are permitted provided that the following conditions are met:

- * Redistribution's of source code must retain the above copyright notice, this list of conditions and the following disclaimer.
- * Redistribution's in binary form must reproduce the above copyright notice, this list of conditions and the following disclaimer in the documentation and/or other materials provided with the distribution.
- * The name of the copyright holders may not be used to endorse or promote products derived from this software without specific prior written permission.

This software is provided by the copyright holders and contributors "as is" and any express or implied warranties, including, but not limited to, the implied warranties of merchantability and fitness for a particular purpose are disclaimed.

In no event shall the Intel Corporation or contributors be liable for any direct, indirect, incidental, special, exemplary, or consequential damages (including, but not limited to, procurement of substitute goods or services; loss of use, data, or profits; or business interruption) however caused and on any theory of liability, whether in contract, strict liability, or tort (including negligence or otherwise) arising in any way out of the use of this software, even if advised of the possibility of such damage.

libtiff

Copyright (c) 1988-1997 Sam Leffler
Copyright (c) 1991-1997 Silicon Graphics, Inc.

Permission to use, copy, modify, distribute, and sell this software and its documentation for any purpose is hereby granted without fee, provided that (i) the above copyright notices and this permission notice appear in all copies of the software and related documentation, and (ii) the names of Sam Leffler and Silicon Graphics may not be used in any advertising or publicity relating to the software without the specific, prior written permission of Sam Leffler and Silicon Graphics.

THE SOFTWARE IS PROVIDED "AS-IS" AND WITHOUT WARRANTY OF ANY KIND, EXPRESS, IMPLIED OR OTHERWISE, INCLUDING WITHOUT LIMITATION, ANY WARRANTY OF MERCHANTABILITY OR FITNESS FOR A PARTICULAR PURPOSE.

IN NO EVENT SHALL SAM LEFFLER OR SILICON GRAPHICS BE LIABLE FOR ANY SPECIAL, INCIDENTAL, INDIRECT OR CONSEQUENTIAL DAMAGES OF ANY KIND, OR ANY DAMAGES WHATSOEVER RESULTING FROM LOSS OF USE, DATA OR PROFITS, WHETHER OR NOT ADVISED OF THE POSSIBILITY OF DAMAGE, AND ON ANY THEORY OF LIABILITY, ARISING OUT OF OR IN CONNECTION WITH THE USE OR PERFORMANCE OF THIS SOFTWARE.

libjpeg

This software is based in part on the work of the Independent JPEG Group.

SHARP[®]
SHARP CORPORATION