

**SHARP**<sup>®</sup>

# **PN-CD701**

**LCD MONITOR**

**OPERATION MANUAL**

**HDMI**<sup>™</sup>

**IMPORTANT:**

To aid reporting in case of loss or theft, please record the product's model and serial numbers in the space provided. The numbers are located in the rear of the product.



Model No.:

Serial No.:

U.S.A. ONLY

# IMPORTANT INFORMATION

**WARNING:** TO REDUCE THE RISK OF FIRE OR ELECTRIC SHOCK, DO NOT EXPOSE THIS PRODUCT TO RAIN OR MOISTURE.

	<b>CAUTION</b> RISK OF ELECTRIC SHOCK DO NOT OPEN	
<p>CAUTION: TO REDUCE THE RISK OF ELECTRIC SHOCK, DO NOT REMOVE COVER. NO USER-SERVICEABLE PARTS INSIDE. REFER SERVICING TO QUALIFIED SERVICE PERSONNEL.</p>		



The lightning flash with arrowhead symbol, within a triangle, is intended to alert the user to the presence of uninsulated “dangerous voltage” within the product’s enclosure that may be of sufficient magnitude to constitute a risk of electric shock to persons.



The exclamation point within a triangle is intended to alert the user to the presence of important operating and maintenance (servicing) instructions in the literature accompanying the product.

**WARNING:**

FCC Regulations state that any unauthorized changes or modifications to this equipment not expressly approved by the manufacturer could void the user’s authority to operate this equipment.

**NOTE:**

This equipment has been tested and found to comply with the limits for a Class A digital device, pursuant to Part 15 of the FCC Rules. These limits are designed to provide reasonable protection against harmful interference when the equipment is operated in a commercial environment. This equipment generates, uses, and can radiate radio frequency energy and, if not installed and used in accordance with the instruction manual, may cause harmful interference to radio communications. Operation of this equipment in a residential area is likely to cause harmful interference in which case the user will be required to correct the interference at his own expense.

This product utilizes a CR coin Lithium battery which contains a Perchlorate material. Special handling for this material may apply, California residents, See [www.dtsc.ca.gov/hazardouswaste/perchlorate/](http://www.dtsc.ca.gov/hazardouswaste/perchlorate/) Others, consult local environmental officers.

U.S.A. ONLY

To maintain compliance with EMC regulations, use shielded cables to connect to the following terminals: HDMI input terminal, USB input/output terminals and audio output terminal.

# DEAR SHARP CUSTOMER

---

Thank you for your purchase of a SHARP LCD product. To ensure safety and many years of trouble-free operation of your product, please read the Safety Precautions carefully before using this product.

## SAFETY PRECAUTIONS

---

Electricity is used to perform many useful functions, but it can also cause personal injuries and property damage if improperly handled. This product has been engineered and manufactured with the highest priority on safety. However, improper use can result in electric shock and/or fire. In order to prevent potential danger, please observe the following instructions when installing, operating and cleaning the product. To ensure your safety and prolong the service life of your LCD product, please read the following precautions carefully before using the product.

1. Read instructions — All operating instructions must be read and understood before the product is operated.
2. Keep this manual in a safe place — These safety and operating instructions must be kept in a safe place for future reference.
3. Observe warnings — All warnings on the product and in the instructions must be observed closely.
4. Follow instructions — All operating instructions must be followed.
5. Cleaning — Unplug the power cord from the power outlet before cleaning the product. Use a dry cloth to clean the product. Do not use liquid cleaners or aerosol cleaners. Do not use dirty cloths. Doing so may damage the product.
6. Attachments — Do not use attachments not recommended by the manufacturer. Use of inadequate attachments can result in accidents.
7. Water and moisture — Do not use the product near water. Do not install the product in a place where water may splash onto it. Be careful of equipment which drains water such as an air-conditioner.
8. Ventilation — The vents and other openings in the cabinet are designed for ventilation. Do not cover or block these vents and openings since insufficient ventilation can cause overheating and/or shorten the life of the product. Do not place the product on a sofa, rug or other similar surface, since they can block ventilation openings. Do not place the product in an enclosed place such as a bookcase or rack, unless proper ventilation is provided or the manufacturer's instructions are followed.
9. Power cord protection — The power cords must be routed properly to prevent people from stepping on them or objects from resting on them.
10. The screen used in this product is made of glass. Therefore, it can break when the product is dropped or applied with impact. Be careful not to be injured by broken glass pieces in case the screen breaks.
11. Overloading — Do not overload power outlets or extension cords. Overloading can cause fire or electric shock.
12. Entering of objects and liquids — Never insert an object into the product through vents or openings. High voltage flows in the product, and inserting an object can cause electric shock and/or short internal parts. For the same reason, do not spill water or liquid on the product.
13. Servicing — Do not attempt to service the product yourself. Removing covers can expose you to high voltage and other dangerous conditions. Request a qualified service person to perform servicing.
14. Repair — If any of the following conditions occurs, unplug the power cord from the power outlet, and request a qualified service person to perform repairs.
  - a. When the power cord or plug is damaged.
  - b. When a liquid was spilled on the product or when objects have fallen into the product.
  - c. When the product has been exposed to rain or water.
  - d. When the product does not operate properly as described in the operating instructions.

Do not touch the controls other than those described in the operating instructions. Improper adjustment of controls not described in the instructions can cause damage, which often requires extensive adjustment work by a qualified technician.
  - e. When the product has been dropped or damaged.
  - f. When the product displays an abnormal condition. Any noticeable abnormality in the product indicates that the product needs servicing.
15. Replacement parts — In case the product needs replacement parts, make sure that the service person uses replacement parts specified by the manufacturer, or those with the same characteristics and performance as the original parts. Use of unauthorized parts can result in fire, electric shock and/or other danger.
16. Safety checks — Upon completion of service or repair work, request the service technician to perform safety checks to ensure that the product is in proper operating condition.
17. Wall mounting — When mounting the product on a wall, be sure to install the product according to the method recommended by the manufacturer.
18. Heat sources — Keep the product away from heat sources such as radiators, heaters, stoves and other heat-generating products (including amplifiers).

# SAFETY PRECAUTIONS (Continued)

19. Batteries — Incorrect use of batteries may cause the batteries to burst or ignite. A leaky battery may corrode the equipment, dirty your hands or spoil your clothing. In order to avoid these problems, make sure to observe the precautions below:
  - Use the specified batteries only.
  - Install the batteries with due attention to the plus (+) and minus (-) sides of the batteries according to the instructions in the compartment.
  - Do not mix old and new batteries.
  - Do not mix batteries of different types. Voltage specifications of batteries of the same shape may vary.
  - Replace an exhausted battery with a new one promptly.
  - If you will not use the remote control for a long time, remove the batteries.
  - If leaked battery fluid gets on your skin or clothing, rinse immediately and thoroughly. If it gets into your eye, bathe your eye well rather than rubbing and seek medical treatment immediately. Leaked battery fluid that gets into your eye or your clothing may cause a skin irritation or damage your eye.
20. Usage of the monitor must not be accompanied by fatal risks or dangers that, could lead directly to death, personal injury, severe physical damage or other loss, including nuclear reaction control in nuclear facility, medical life support system, and missile launch control in a weapon system.
21. Do not stay in contact with the parts of the product that become hot for long periods of time. Doing so may result in low-temperature burns.
22. Do not modify this product.

## **WARNING:**

This is a Class A product. In a domestic environment this product may cause radio interference in which case the user may be required to take adequate measures.

An apparatus with CLASS I construction shall be connected to a MAIN socket outlet with a protective earthing connection.

## **STABILITY HAZARD**

If a monitor is not positioned in a sufficiently stable location, it can be potentially hazardous due to falling. Many injuries, particularly to children, can be avoided by taking simple precautions such as:

- Using fixing devices like wall mount brackets recommended by the manufacturer.
- Only using furniture that can safely support the monitor.
- Ensuring the monitor is not overhanging the edge of the supporting furniture.
- Not placing the monitor on tall furniture (for example, cupboards or bookcases) without anchoring both the furniture and the monitor to a suitable support.
- Not standing the monitors on cloth or other materials placed between the monitor and supporting furniture.
- Educating children about the dangers of climbing on furniture to reach the monitor or its controls.
- This equipment is not suitable for use in locations where children are likely to be present unsupervised.

## **Especially for child safety**

- Don't allow children to climb on or play with the monitor.
- Don't place the monitor on furniture that can easily be used as steps, such as a chest of drawers.
- Remember that children can become excited while watching a program, especially on a "larger than life" monitor. Care should be taken to place or install the monitor where it cannot be pushed, pulled over, or knocked down.
- Care should be taken to route all cords and cables connected to the monitor so that they cannot be pulled or grabbed by curious children.

# TIPS AND SAFETY INSTRUCTIONS

- The TFT color LCD panel used in this monitor is made with the application of high precision technology. However, there may be minute points on the screen where pixels never light or are permanently lit. Also, if the screen is viewed from an acute angle there may be uneven colors or brightness. Please note that these are not malfunctions but common phenomena of LCDs and will not affect the performance of the monitor.
- Do not display a still picture for a long period, as this could cause a residual image.
- Never rub or tap the monitor with hard objects.
- Please understand that SHARP CORPORATION bears no responsibility for errors made during use by the customer or a third party, nor for any other malfunctions or damage to this product arising during use, except where indemnity liability is recognized under law.
- This monitor and its accessories may be upgraded without advance notice.
- Do not use the monitor where there is a lot of dust, where humidity is high, or where the monitor may come into contact with oil or steam. Do not use in an environment where there are corrosive gases (sulfur dioxide, hydrogen sulfide, nitrogen dioxide, chlorine, ammonia, ozone, etc.). As this could lead to fire.
- Ensure that the monitor does not come into contact with water or other fluids. Ensure that no objects such as paper clips or pins enter the monitor as this could lead to fire or electric shock.
- Do not place the monitor on top of unstable objects or in unsafe places. Do not allow the monitor to receive strong shocks or to strongly vibrate. Causing the monitor to fall or topple over may damage it.
- Do not use the monitor near heating equipment or in places where there is likelihood of high temperature, as this may lead to generation of excessive heat and outbreak of fire.
- Do not use the monitor in places where it may be exposed to direct sunlight. Risk of cabinet deformation and failure if the monitor is used in direct sunlight.
- Images cannot be rotated on this monitor. When using in portrait orientation, you will need to prepare appropriately orientated content in advance.
- The power outlet shall be installed near the equipment and shall be easily accessible.
- Please be sure to constantly remove dust and garbage that has attached to the ventilation opening. If dust collects in the ventilation opening or the inside of the monitor, it may lead to excessive heat, outbreak of fire, or malfunction. Please request a cleaning of the inside of the monitor from an authorized SHARP servicing dealer or service center.
- Do not touch the screen when the monitor power is turned on, it will lead to a malfunction. When this occurs, turn the monitor power off and then on.
- Do not operate the screen with a hard or pointed object such as a fingernail or pencil.
- Depending on the application used, the touch pen may not function.
- If another USB device is connected to the computer to which the touch panel is connected, do not operate the USB device during touch panel input. Input may not take place correctly.
- Do not allow a cable to come near the screen. This may cause the touch panel to malfunction.

## The Power Cord

- Use only the power cord supplied with the monitor.
- Do not damage the power cord nor place heavy objects on it, stretch it or over bend it. Also, do not add extension cords. Damage to the cord may result in fire or electric shock.
- Do not use the power cord with a power tap. Adding an extension cord may lead to fire as a result of overheating.
- Do not remove or insert the power plug with wet hands. Doing so could result in electric shock.
- Unplug the power cord if it is not used for a long time.
- Do not attempt to repair the power cord if it is broken or malfunctioning. Refer the servicing to the service representative.

## Manual Scope

- Microsoft and Windows are either registered trademarks or trademarks of Microsoft Corporation in the United States and/or other countries.
- Apple, Mac and macOS are trademarks of Apple Inc., registered in the U.S. and other countries.
- Google, Android and Chrome OS are trademarks or registered trademarks of Google LLC.
- The terms HDMI, HDMI High-Definition Multimedia Interface, and the HDMI Logo are trademarks or registered trademarks of HDMI Licensing Administrator, Inc.
- DisplayPort is a registered trademark of Video Electronics Standards Association.
- Intel, Celeron, and Intel Core are trademarks or registered trademarks of Intel Corporation or its subsidiaries in the U.S.A. and other countries.
- RoomView, Crestron RoomView and Crestron Connected are either trademarks or registered trademarks of Crestron Electronics, Inc. in the United States and/or other countries.
- VESA is either registered trademark or trademark of Video Electronics Standards Association in the United States and/or other countries.
- Bluetooth is a registered trademark of Bluetooth SIG, Inc.
- All other brand and product names are trademarks or registered trademarks of their respective holders.
- Language of OSD menu used in this manual is English by way of example.
- Illustrations in this manual may not exactly represent the actual product or display.

## LED Backlight

- The LED backlight in this product has a limited lifetime.
  - \* If the screen gets dark or does not turn on, it may be necessary to replace the LED backlight.
  - \* This LED backlight is exclusive to this product and must be replaced by an authorized SHARP servicing dealer or service center. Please contact an authorized SHARP servicing dealer or service center for assistance.

# MOUNTING PRECAUTIONS

---

- This product is for use indoors.
- A mounting bracket compliant with VESA specifications is required.
- Since the monitor is heavy, consult your dealer before installing, removing or moving the monitor.
- Mounting the monitor on the wall requires special expertise and the work must be performed by an authorized SHARP dealer. You should never attempt to perform any of this work yourself. Our company will bear no responsibility for accidents or injuries caused by improper mounting or mishandling.
- Use the monitor with the surface perpendicular to a level surface.
- When moving this monitor, be sure to hold it with the handles, the unit sides or the unit top. Do not grasp the screen, unit corner or speaker. This may cause product damage, failure, or injury.
- This monitor should be used at an ambient temperature between 41°F (5°C) and 95°F (35°C).
- Be careful of high temperatures in the surrounding area. If it is difficult to provide sufficient space for any reason such as the installation of the monitor inside a housing, or if the ambient temperature may be outside of the range of 41°F (5°C) to 95°F (35°C), install a fan or take other measures to keep the ambient temperature within the required range.
- Temperature condition may change when using the monitor together with the optional equipments recommended by SHARP. In such cases, please check the temperature condition specified by the optional equipments.
- Do not block any ventilation openings. If the temperature inside the monitor rises, this could lead to a malfunction.
- Do not place the monitor on a device which generates heat.

# Contents

<b>IMPORTANT INFORMATION</b> .....	<b>3</b>	<b>Touch Pen</b> .....	<b>17</b>
<b>DEAR SHARP CUSTOMER</b> .....	<b>4</b>	<b>Touch action</b> .....	<b>18</b>
<b>SAFETY PRECAUTIONS</b> .....	<b>4</b>	Touch action .....	18
<b>TIPS AND SAFETY INSTRUCTIONS</b> .....	<b>6</b>	Other functions .....	20
<b>MOUNTING PRECAUTIONS</b> .....	<b>7</b>	Cautionary points .....	20
<b>Supplied Components</b> .....	<b>9</b>	<b>Basic Operation</b> .....	<b>21</b>
<b>System Requirements</b> .....	<b>9</b>	Button Operation .....	21
<b>Part Names</b> .....	<b>10</b>	IoT accessories Operation .....	21
<b>Connecting Peripheral Equipment</b> .....	<b>12</b>	Using the remote control unit (option).....	22
<b>Mounting an IoT sensor hub</b> .....	<b>14</b>	<b>Menu Items</b> .....	<b>23</b>
<b>Mounting a camera</b> .....	<b>14</b>	Displaying the menu.....	23
<b>Connecting the Power Cord</b> .....	<b>15</b>	Main function in Action Panel .....	25
<b>Preparing the Remote Control Unit</b> .....	<b>15</b>	<b>Network</b> .....	<b>29</b>
Installing the batteries .....	15	<b>Troubleshooting</b> .....	<b>30</b>
Remote control operation range.....	15	<b>Specifications</b> .....	<b>31</b>
<b>Turning Power On/Off</b> .....	<b>16</b>	<b>Intellectual Property Rights and Other Matters</b> .....	<b>35</b>
Turning on the main power.....	16	<b>Mounting Precautions</b>	
Turning power on .....	16	<b>(For SHARP dealers and service engineers)</b> .....	<b>36</b>
Turning power off .....	16		



# Supplied Components

If any components are missing, please contact your dealer.

- |  |  |  |   |
|--|--|--|---|
| <ul style="list-style-type: none"> <li><input type="checkbox"/> Liquid Crystal Display Monitor: 1</li> <li><input type="checkbox"/> Power cord: 1</li> <li><input type="checkbox"/> HDMI cable: 1</li> <li><input type="checkbox"/> USB Type C cable (26.2 feet [8 m]): 1</li> <li><input type="checkbox"/> USB Type C extend cable: 1</li> <li><input type="checkbox"/> CD-ROM: 1</li> <li><input type="checkbox"/> Setup Manual: 1</li> <li><input type="checkbox"/> Touch pen: 1</li> </ul> | <ul style="list-style-type: none"> <li><input type="checkbox"/> USB A to B cable (for touch back): 1</li> <li><input type="checkbox"/> Cable clamp: 1</li> </ul> | <ul style="list-style-type: none"> <li><input type="checkbox"/> Camera: 1</li> <li><input type="checkbox"/> Knurled screw (M3): 2</li> <li><input type="checkbox"/> USB A to B cable (for camera): 1</li> <li><input type="checkbox"/> S/PDIF cable: 1</li> <li><input type="checkbox"/> 3.5 mm mini jack to USB A cable: 1</li> </ul> | <ul style="list-style-type: none"> <li><input type="checkbox"/> IoT sensor hub: 1</li> <li><input type="checkbox"/> Micro USB cable (for IoT sensor hub): 1</li> <li><input type="checkbox"/> Knurled screw (M3): 2</li> <li><input type="checkbox"/> IoT sensor hub screw (M3): 2</li> <li><input type="checkbox"/> IoT sensor hub mounting brackets (L/R): x1 each</li> </ul> |
|--|--|--|---|

- \* The remote control unit is supplied with the PN-ZR02 (optional).  
(Remote control sensor box is not used.)
- \* For environmental protection!  
Do not dispose of batteries in household waste. Follow the disposal instructions for your area.

## About USB Type C extend cable

- Connect the USB Type C extend cable (supplied) between the USB Type C cable (supplied) and the external device.  
When connecting/disconnecting to the external device, plug/unplug the USB Type C extend cable to prevent damage to the USB Type C cable.

# System Requirements

Hardware	Must have a USB 2.0 compliant port.
Operating system	Windows 8.1 (32-bit or 64-bit version), Windows 10 (32-bit or 64-bit version) (Windows 10 recommended.)
	macOS v10.12, v10.13
	Google Chrome OS Version 75 or later

The USB port varies depending on the terminal connected to the computer.

USB Type C 1 input terminal	USB Type C 1 input terminal
USB Type C 2 input terminal	USB Type C 2 input terminal
HDMI input terminal	USB Type B input terminal for touch back

# Part Names

## ■Front view

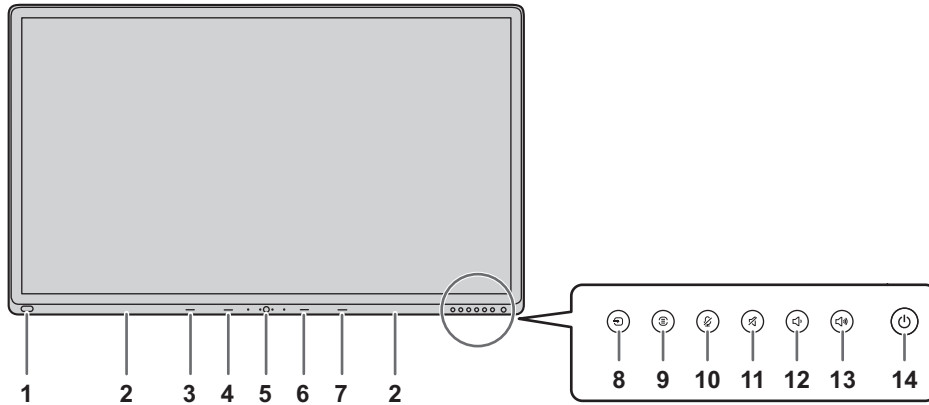

- |  |   |
|--|---|
| <ul style="list-style-type: none"> <li>1. <b>USB port for external source (USB 3.0 compliant)</b> (See page 13.)</li> <li>2. <b>Pen Tray</b> (See page 17.)</li> <li>3. <b>LED indicator for USB Type C 1 source</b></li> <li>4. <b>LED indicator for USB Type C 2 source</b></li> <li>5. <b>Windows button</b></li> <li>6. <b>LED indicator for HDMI</b></li> <li>7. <b>LED indicator for Wireless LAN</b></li> </ul> | <ul style="list-style-type: none"> <li>8. <b>INPUT button</b> (See page 21.)</li> <li>9. <b>MENU button</b> (See page 21.)</li> <li>10. <b>MIC MUTE button</b> (See page 21.)</li> <li>11. <b>MUTE button</b> (See page 21.)</li> <li>12. <b>VOLUME DOWN button</b> (See page 21.)</li> <li>13. <b>VOLUME UP button</b> (See page 21.)</li> <li>14. <b>POWER button</b> (See page 16.)</li> </ul> |
|--|---|

## ■Rear view

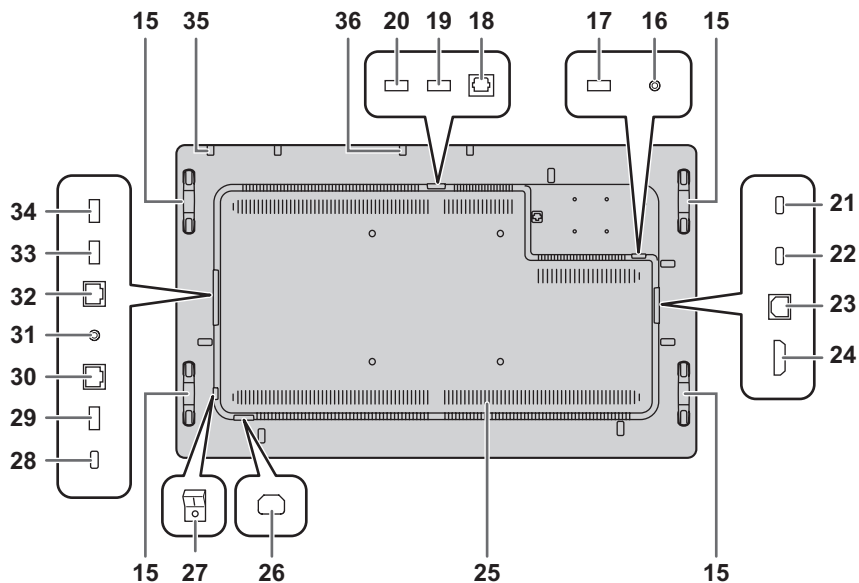

- 15. **Handles**
- 16. **3.5 mm jack for service** (See page 13.)
- 17. **USB port for camera 2** (See page 13.)
- 18. **Optical audio input terminal (S/PDIF)** (See page 13.)
- 19. **USB port for camera 1** (See page 13.)
- 20. **USB port for external source (USB 3.0 compliant)** (See page 13.)
- 21. **USB Type C 1 input terminal** (See page 12.)
- 22. **USB Type C 2 input terminal** (See page 12.)
- 23. **USB Type B input terminal for touch back (pair with HDMI input terminal)** (See page 12.)

- 24. HDMI input terminal (See page 12.)
- 25. Vents
- 26. AC input terminal (See page 15.)
- 27. Main power switch (See page 16.)
- 28. USB Type C output terminal (See page 13.)
- 29. USB port for storage expansion (USB 3.0 compliant) (See page 13.)
- 30. LAN 2 terminal (See page 13.)
- 31. Line out Audio output terminal (See page 12.)
- 32. LAN 1 terminal (See page 13.)
- 33. USB port for IoT sensor hub/USB devices (See page 12.)
- 34. USB port for IoT sensor hub/USB devices (See page 12.)
- 35. Mounting points for IoT sensor hub (See page 14.)
- 36. Mounting points for camera (See page 14.)

**Remote control unit**  
(Supplied with the PN-ZR02 (optional))

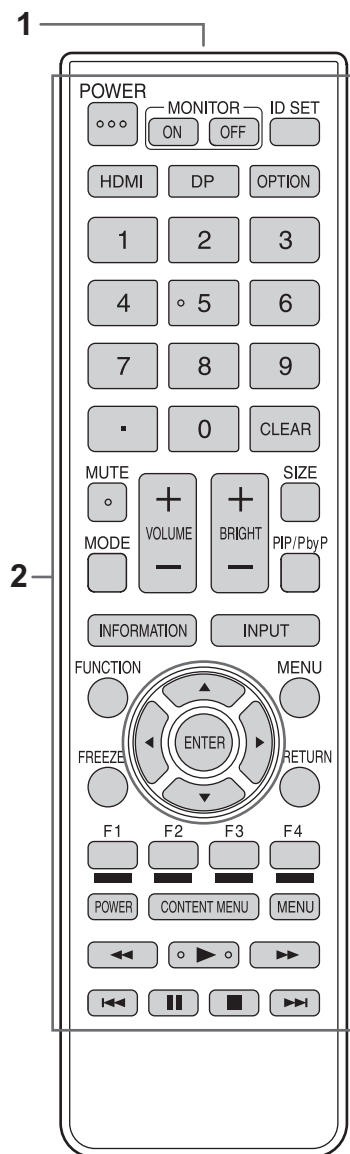

- 1. Signal transmitter
- 2. Operation buttons (See page 22.)

# Connecting Peripheral Equipment

## ■Rear view

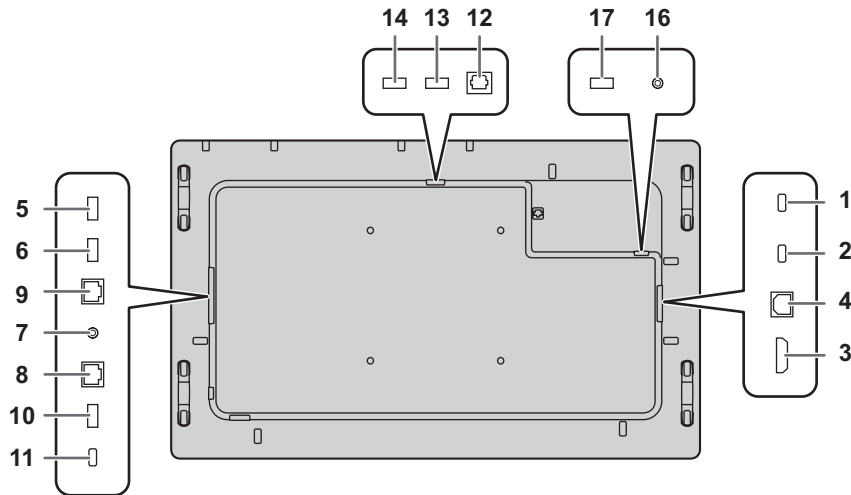

## ■Front view

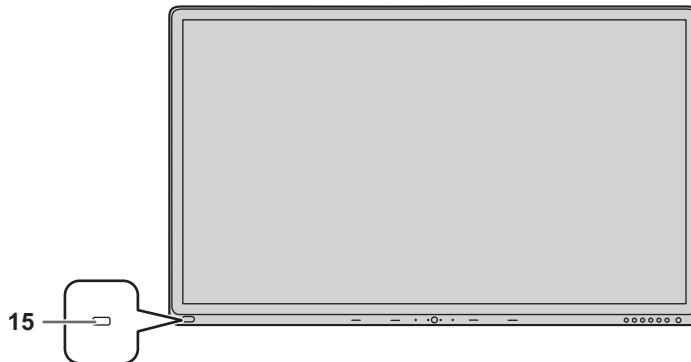

### ! Caution

- Be sure to turn off the main power switch and disconnect the plug from the power outlet before connecting/disconnecting cables. Also, read the manual of the equipment to be connected.
- Be careful not to confuse the input terminal with the output terminal when connecting cables. Accidentally reversing cables connected to the input and output terminals may cause malfunctions and the other problems.
- Do not use any cable that has a damaged or deformed terminal. Using such cables may cause malfunctions.

### TIPS

- Images may not be displayed properly depending on the computer (video card) to be connected.
- If the audio output from the playback device is connected directly to speakers or other devices, the video on the monitor may appear delayed from the audio portion. Audio should be played through this monitor by connecting the playback device to the monitor's audio input, and connecting the monitor's audio output to the speakers or other devices.
- If the computer is connected to this monitor with a USB Type C cable, the device recognition sound of OS may sound several times.

### 1. USB Type C 1 input terminal

### 2. USB Type C 2 input terminal

- Use the USB Type C cable (supplied).
- You can connect a device that supports DisplayPort alternate mode.  
In order to supply power to connected devices, it is necessary to support the Power delivery standard.
- Connect the USB Type C extend cable (supplied) between the USB Type C cable (supplied) and the external device. When connecting/disconnecting to the external device, plug/unplug the USB Type C extend cable to prevent damage to the USB Type C cable.

### 3. HDMI input terminal

- Use the HDMI cable (supplied).

### 4. USB Type B input terminal for touch back (pair with HDMI input terminal)

- To use the touch panel with a computer, connect the touch panel to the computer with a USB A to B cable (supplied).

### 5. USB port for IoT sensor hub/USB devices

### 6. USB port for IoT sensor hub/USB devices

- To use the IoT sensor hub, connect the IoT sensor hub to these ports with the Micro USB cable (supplied).

### 7. Line out Audio output terminal

### 8. LAN 2 terminal

- You can connect to the Internet by connecting a commercially available LAN cable between this terminal and a network.

### 9. LAN 1 terminal

- By connecting this terminal to a network, you can connect an external device connected via USB to the network.

### 10. USB port for storage expansion (USB 3.0 compliant)

- You can expand the storage used by the main system on this terminal by inserting a commercially available USB storage drive.

### 11. USB Type C output terminal

- This Type C terminal allows to output the video source from this terminal to another USB Type C input terminal supported display, via a commercially available Type C cable that support DisplayPort.

### 12. Optical audio input terminal (S/PDIF)

- This terminal is reserved for the hardware echo cancellation feature supported by the camera (supplied).
- Connect the optical audio output from the camera and this optical audio input terminal via an S/PDIF cable (supplied).

### 13. USB port for camera 1

- Connect the camera to this terminal with the USB A to B cable (supplied).

### 14. USB port for external source (USB 3.0 compliant)

- Connect a USB device to this terminal.
- This USB input terminal serves an extension of the external source devices.

### 15. USB port for external source (USB 3.0 compliant)

- Connect a USB device to this terminal.

### 16. 3.5 mm jack for service

- Only for service technicians.

### 17. USB port for camera 2

- Connect the camera to this terminal with the 3.5 mm mini jack to USB A cable (supplied).

# Mounting an IoT sensor hub

It is possible to mount an IoT sensor hub in the following position.

IoT sensor hub  
mounting bracket

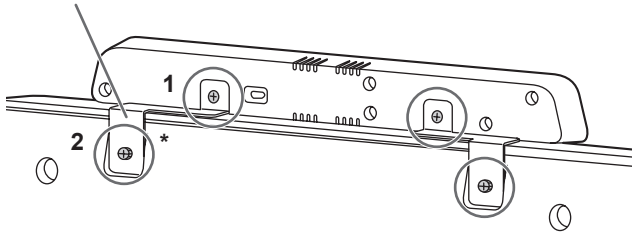

1. Attach the supplied IoT sensor hub mounting brackets (L/R) to the IoT sensor hub with the supplied IoT sensor hub screws (M3) (x2).

2. Fix the IoT sensor hub mounting brackets (L/R) to this monitor with supplied knurled screws (M3) (x2).

\* The IoT sensor hub mounting brackets fit into the recess of this monitor.

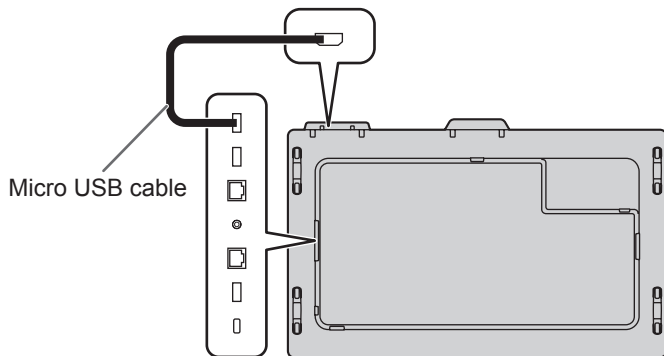

# Mounting a camera

It is possible to mount a camera in the following position.

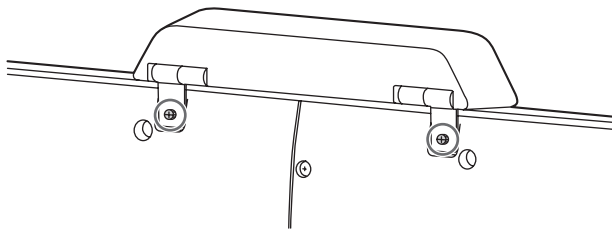

1. Attach the supplied camera with the supplied knurled screws (M3) (x2).

The camera can be tilted downward.

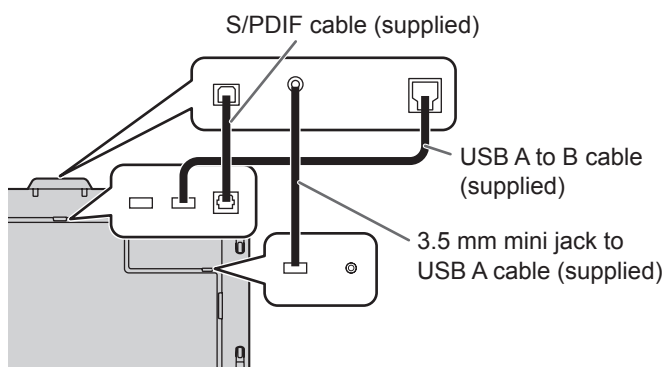
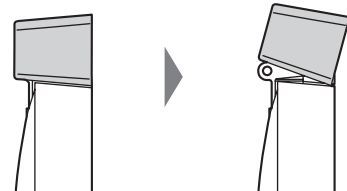

## TIPS

- The cable clamp (supplied) can be used to clamp the 3.5 mm mini jack to USB A cable (supplied).
- Attach the supplied cable clamp to a flat surface. Do not attach over a vent.
- Remove any dust or dirt before attaching.

# Connecting the Power Cord

## ! Caution

- Use only the power cord supplied with the monitor.
1. Turn off the main power switch.
  2. Plug the power cord (supplied) into the AC input terminal.
  3. Plug the power cord (supplied) into the power outlet.

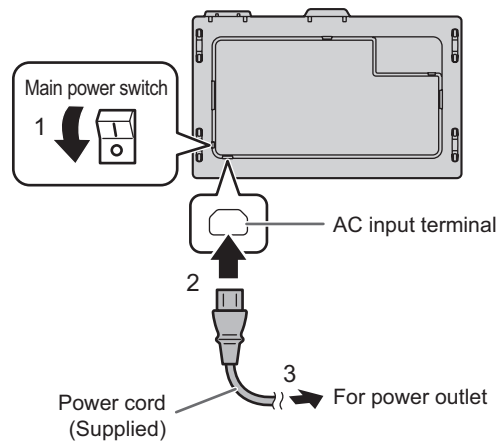

# Preparing the Remote Control Unit

## Installing the batteries

1. Place your finger on the part marked with the ▲, and then pull the cover off.

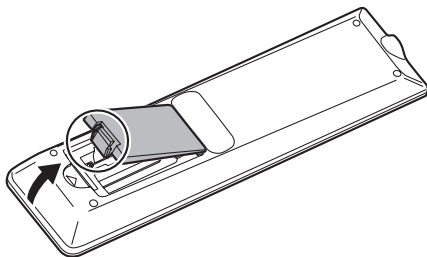

2. See the instructions in the compartment and put in the batteries (supplied with the PN-ZR02 (optional)) with their plus (+) and minus (-) sides oriented correctly.
3. Close the cover.

## TIPS

- When the batteries become exhausted, replace them with new (commercially available) batteries.
- Use manganese (R03 ("AAA" size)) or alkaline (LR03 ("AAA" size)) batteries only.
- The supplied batteries may become exhausted quickly depending on how they are stored.
- If you will not be using the remote control for a long time, remove the batteries.

## Remote control operation range

The operation range of the remote control unit (PN-ZR02, optional) is approx. 16.4 feet (5 m) at an angle of approx. 10° from the center to the top/bottom/right/left of the remote control sensor.

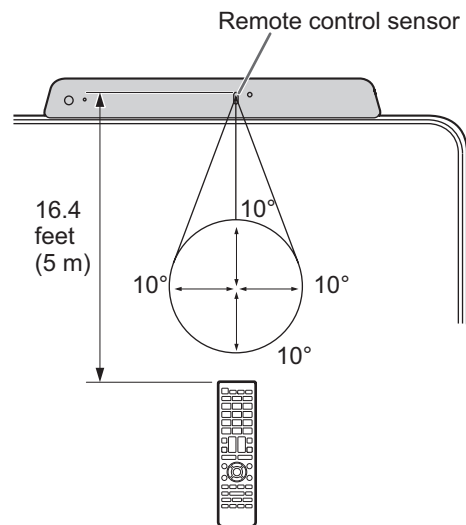

## TIPS

- Do not expose the remote control unit to shock by dropping or stepping on it. This could lead to a malfunction.
- Do not expose the remote control unit to liquids, and do not place it in an area with high humidity.
- The remote control unit may not work properly if the remote control sensor is under direct sunlight or strong lighting.
- Objects between the remote control unit and the remote control sensor may prevent proper operation.
- Replace the batteries when they run low as this may shorten the remote control's operation range.
- If a fluorescent light is illuminated near the remote control unit, it may interfere with proper operation.
- Do not use it with the remote control of other equipment such as air conditioner, stereo components, etc.

# Turning Power On/Off

## ! Caution

- Turn on the monitor first before turning on the computer or playback device.
- When switching the main power switch or the POWER button off and back on, always wait for at least 5 seconds. A short interval may result in a malfunction.
- To keep the performance, put the monitor in the Power off state once a day.

## Turning on the main power

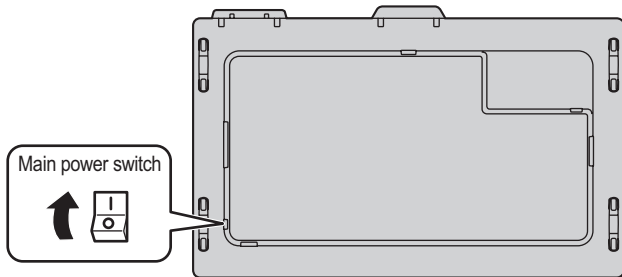

## ! Caution

- The main power must be turned on/off with the main power switch. Do not connect/disconnect the power cord or turn the breaker on/off while the main power switch is on.
- For a complete electrical disconnection, pull out the main plug.

## Turning power on

Press the POWER button on this monitor to turn the power ON.

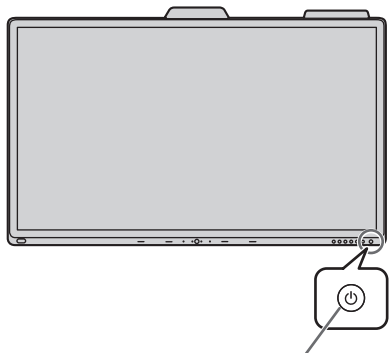

Power LED / POWER button

Status	Status of the monitor
White lit	Power on
Amber lit	Power off

## TIPS

- You can turn on the power automatically in response to the people motions.  
(When "In-Device Motion Sensor" is set to "On".)  
The operating range is approx. 32.8 feet (10 m).

## ■ Operations after first power-on

When the monitor is turned on for the first time after being shipped from the factory, the setting screen will be displayed. Configure the settings according to the screen.

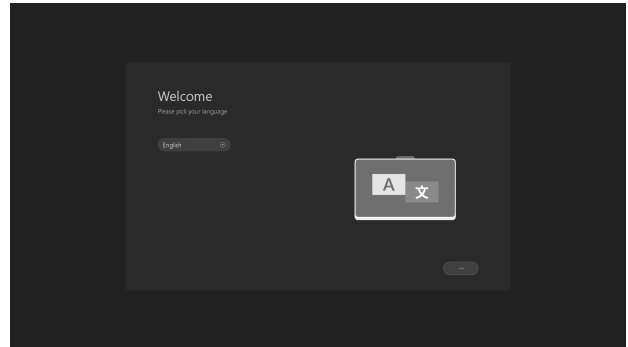

## About Operation Mode

### Mode1:

- This monitor goes into standby mode when there is no signal for 5 minutes.

### Mode2:

- This monitor does not go into standby mode even if no signal continues.

## Turning power off

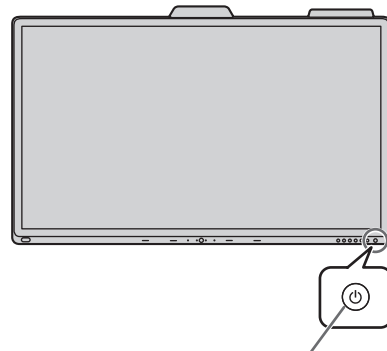

Power LED / POWER button

### When "Operation Mode" is set to "Mode1"

Press the POWER button to turn the power OFF (standby mode).

### When "Operation Mode" is set to "Mode2"

When you press the POWER button, the backlight will be turned off.

To turn the power OFF (standby mode):

#### 1. Long press the POWER button.

The recognition screen appears.

#### 2. Touch [STANDBY].

The power is turned off (standby mode).

## TIPS

- When the main power switch is off, the monitor cannot be turned on.



# Touch Pen

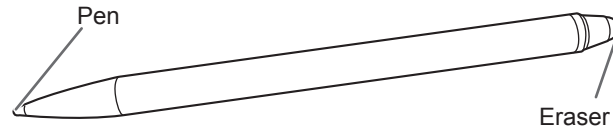

## TIPS

- Incorrect operation may result if your finger is too close to the tip of the pen.
- Hold the touch pen with your bare hand.  
The screen will not respond if you wear a glove.
- When multiple touch pens are used, touch positions and touch pen information (color, thickness, etc.) may become interchanged, and lines may break.
  - When touched simultaneously.
  - When touch pens are moved near each other.
- Do not press the pen tip on other than the screen. This may cause malfunctioning.
- If the pen tip becomes worn or damaged, replace the touch pen. To purchase a new touch pen, consult your dealer.
- Support Windows Ink.
- Support pen, eraser, finger mode.

The supplied touch pen is attached to this monitor.

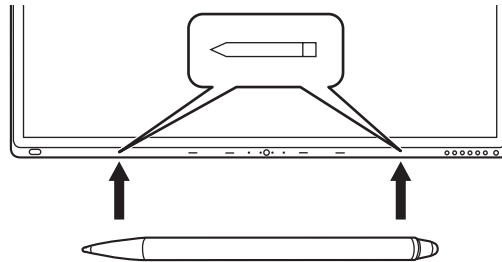

## TIPS

- Do not attach anything other than the supplied touch pen.
- Magnet is used to attach the supplied touch pen. Do not move close watch or magnetic card to it.

# Touch action

## Touch action

Touch actions that can be used with this monitor differ according to operating system and application. The functions of touch actions are also different. For details, check operating system Help and the application's support documentation.

Touch action	Operating system	
	Windows 8.1 / 10	Chrome OS
Single-tap	Yes	Yes
Double-tap	Yes	Yes
Swipe	Yes	Yes
Swipe from edge of screen	Yes	Yes
Drag-and-drop	Yes	Yes
Flicks	Yes	Yes
Press-and-hold	Yes	Yes
Slide to pan	Yes	Yes
Zoom	Yes	Yes
Press-and-tap	No	Yes
Rotate	Yes	Yes

### TIPS

- On the Mac, the actions are the equivalent mouse actions. (Single touch only.)

## Common finger and touch pen actions

### Single-tap

Same action as left-clicking a mouse.  
Touch with your finger/touch pen.

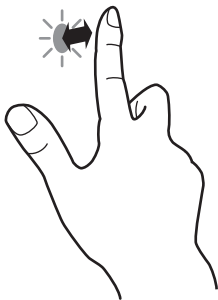

### Double-tap

Same action as double-clicking a mouse.  
Quickly touch twice with your finger/touch pen.

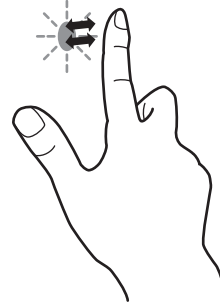

When double-tapping with your finger, be sure to lift your finger sufficiently off the screen after the first tap. If there is insufficient distance between the screen and your finger, double-tap will not take place.

### Swipe

Touch the screen with your finger/touch pen, move without lifting, and then stop.

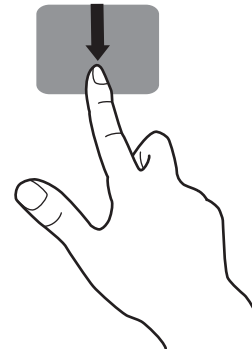

### Swipe from edge of screen

After touching the edge of the monitor with your finger/touch pen, move horizontally without releasing your finger/touch pen and then stop.



**Drag-and-drop**

Same action as drag-and-drop with a mouse.  
Touch the screen with your finger/touch pen and move without lifting. When you have finished the movement, lift your finger/touch pen.

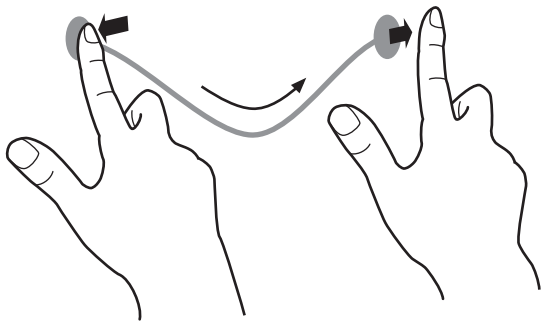

**Flicks**

Flick your finger/touch pen in the direction of the function you want to use.

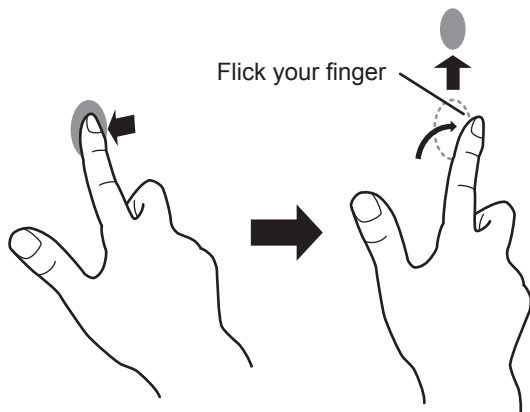

**Press-and-hold**

Same action as right-clicking a mouse.  
Press briefly with your finger/touch pen, and then lift your finger/touch pen from the screen.

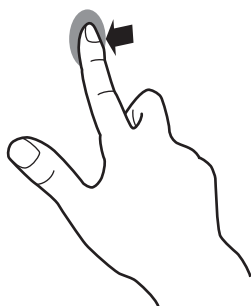

**Slide to pan**

With your finger/touch pen touching the screen, move it up and down to scroll the screen.

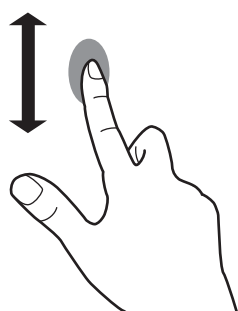

**■Finger actions**

**Zoom**

Use in a screen that is capable of enlargement/reduction.  
Touch the screen with two fingers and move your fingers closer together to reduce the view, or apart to enlarge the view.

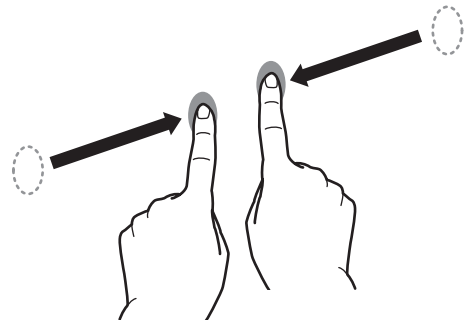

Reduction

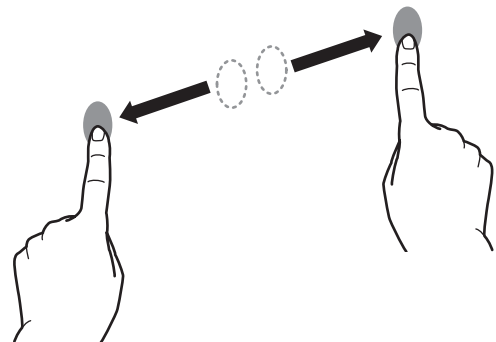

Enlargement

**Press-and-tap**

Same action as right-clicking a mouse.  
With one finger touching the screen, tap once (single tap) with another finger.

Tap once (single tap) with another finger

With one finger touching

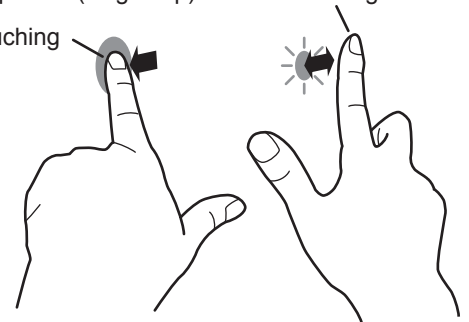

## Touch action

### Rotate

Use this action in a screen that is capable of image rotation. Touch the center point of the rotation with one finger. While holding that finger still, move another finger in the desired direction of rotation.

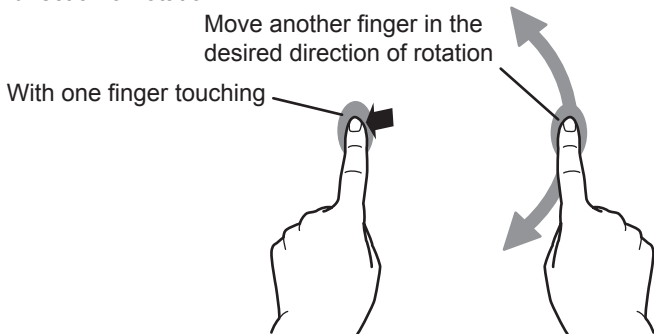

### TIPS

- The screen may not respond correctly in the following cases:
  - Touch gesture is too quick.
  - The distance between the two points is too short.
  - The two points intersect.

---

## Other functions

In Windows 8.1/10, input panel functions can be used. For information on these functions, see Windows Help.

### Input panel :

A software keyboard and an input panel with handwriting recognition appear on the screen.

In Windows 8.1/10, the ink function of Microsoft Office can be used.

Handwritten comments can be written, and handwriting can be recognized.

For details, see Microsoft Office Help.

---

## Cautionary points

- Note the following when touching by finger:
  - Do not touch with a wet finger.
  - Touch with the ball of your finger.
  - Touch with your bare finger.The screen will not respond if you are wearing a glove.
- Do not use the touch pen for any purpose other than touch panel operation.
- Do not press hard on the pen tip.
- This may not operate correctly if there is an inverter fluorescent light nearby.
- If there is dirt or foreign matter on the tip of the touch pen, remove it. Foreign matter may damage the screen.
- The touch pen position may occasionally deviate in the login screen of the connected computer. In this case, use the keyboard or mouse.
- If the USB cable becomes disconnected, the touch panel may not operate correctly after the USB cable is reconnected. In this case, restart the computer.

# Basic Operation

## Button Operation

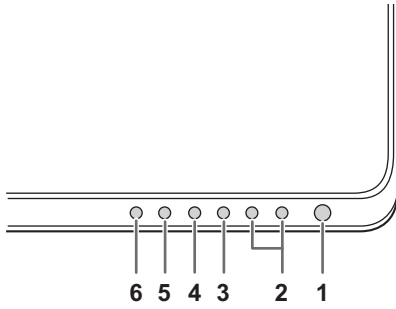

### 1. POWER button

See page 16.

### 2. VOLUME DOWN / UP buttons

#### 2.1 No device connection

Controlling this monitor volume up/down.

#### 2.2 Device connection

Controlling input device volume up/down.

(Windows only. Must be connected with a USB cable.)

### 3. MUTE button

#### 3.1 No device connection

Controlling this monitor volume mute, button LED lights red.

#### 3.2 Device connection

Controlling input device volume mute, button LED lights red.

(Windows only. Must be connected with a USB cable.)

### 4. MIC MUTE button

Controlling input device mic volume mute, button LED lights red.

(Windows only. Must be connected with a USB cable.)

### 5. MENU button

Pressing the MENU button to quick launch the menu.



### 6. INPUT button

Pressing the INPUT button to quick open the Inputs menu.



## IoT accessories Operation

### 1. Camera module

Camera module build with camera and Mic array. Which provide conference video function.

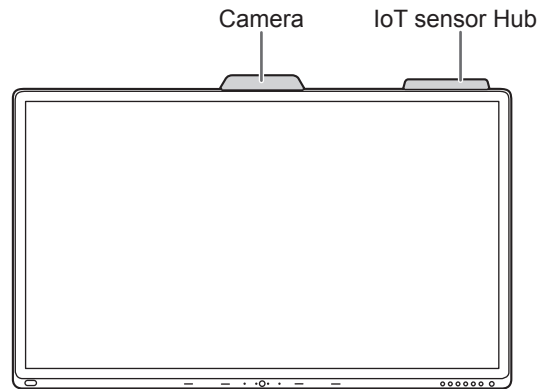

### 2. IoT Sensor Hub

IoT Sensor Hub is an independent accessory which included 5 features (Temperature / Humidity / CO2 / TVOC / Motion).

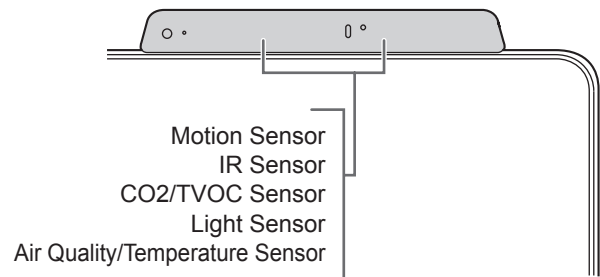

### TIPS

- User can see the Sensor data by open IoT sensor Dashboard or check data in Action panel – Settings – Sensor Hub.

## Using the remote control unit (option)

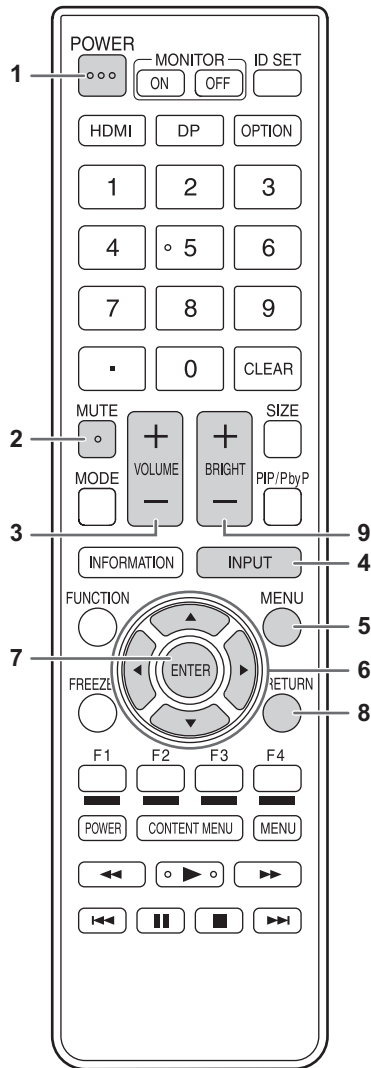

- 1. POWER**  
**When “Operation Mode” is set to “Mode1”**  
 Press the POWER button to turn the power OFF (standby mode).  
**When “Operation Mode” is set to “Mode2”**  
 When you press the POWER button, the backlight will be turned off.
- 2. MUTE**  
 Turns off the volume temporarily.  
 Press the MUTE button again to turn the sound back to the previous level.
- 3. VOLUME +/- (Volume adjustment)**  
 Pressing + or - displays the VOLUME menu.  
 Press + or - to adjust the volume.
- 4. INPUT (Input mode selection)**  
 Each time you press this button, the input mode changes.
- 5. MENU**  
 Displays and turns off the menu screen.
- 6. Cursor**  
 These buttons are used to perform operations such as selecting items, changing adjustment values, and moving the cursor.
- 7. ENTER**  
 Confirms the setting.
- 8. RETURN**  
 Returns to the previous screen.
- 9. BRIGHT +/- (Brightness adjustment)**  
 Press + or - to adjust the brightness.

### TIPS

- Other buttons are not used on this monitor.

# Menu Items

## Displaying the menu

### 1. Home screen

The Home Screen is the default screen that users will see when they launch this monitor.



### 2. Action panel

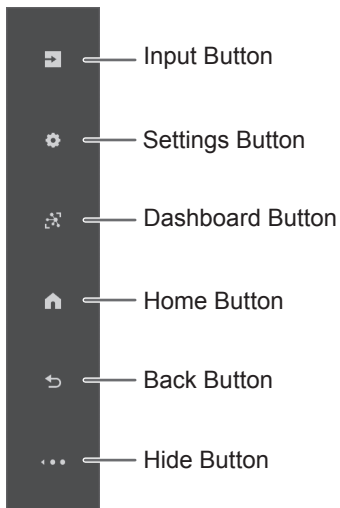

#### 2.1 Action Panel Buttons

The Action Panel buttons can be tapped anytime as long as the Action Panel is showing. The below documentation links provide deeper dive into each button's expanded content.

##### Input Button



The Input Button opens up the Inputs Panel and allow the user to switch sources and get source information.

##### Settings Button



The Settings button will open up the Settings panel and allow the user to change device settings.

##### Dashboard Button



Displays the measurement results of the IoT sensor. (Temperature, Humidity, CO2 Levels, TVOC Levels, Motion)

##### Home Button



The Home button can be tapped at any time to get the user back to the home screen.

##### Back Button



It will allow users to go back inside apps and also within the menu.

##### Hide Button



The Hide button will turn the Action Panel into the Action Thumb. On external source screen it will hide the Action Panel and menu completely.

### 3. Action Thumb

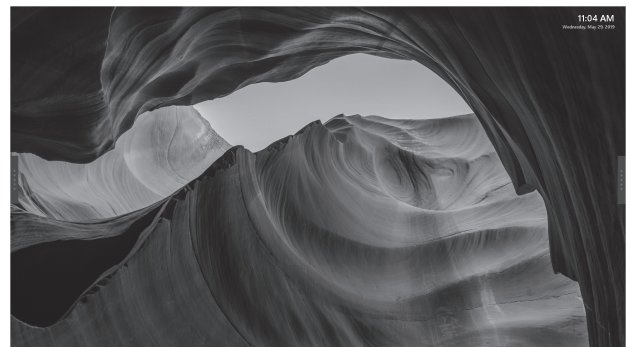

The Action Thumb is meant to be a smaller version of the Action Panel so that it can be present on the screen and not block the content as much as possible.

## 4. Instruction panel

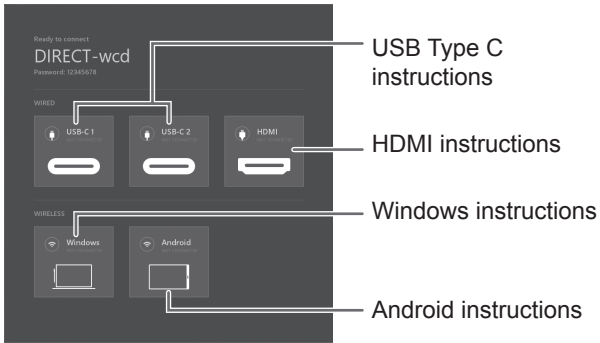

The instruction panel is broken down to different sections each with a different purpose.

### Wired Instructions

The wired section will show you the status of the wired connections within each of the boxes. If the USB icon has a green status then that means that the connection is active. If you want further instructions on how to plug into each of the wire types, you can simply click into the box.



### Wireless Instructions (Windows 10, Android)

The wireless section will show you the status of each wireless connections within each of the boxes. If the Wireless LAN icon has a green status then that means that the connection is active. If you want further instructions on how to connect to each of the wireless types, you can simply click into the box.

Depending on the operating system used, the procedure may differ slightly from the instructions described here. Older or upcoming new operating systems may require additional steps to connect to the monitor.

### TIPS

- When the wireless connection is lost due to external influences, low bandwidth or other causes, you need to reconnect the device.
- Connections to all devices is not guaranteed.



## Main function in Action Panel

The Action Panel can be controlled all panel setting which including OSD functions and input source switching. The below documentation links provide deeper dive into each button's expanded content.

### 1. Inputs

The Input Button opens up the Inputs Panel and allow the user to switch wire or wireless sources and get source information.



#### 1.1 Wire input source

##### Single-input source

Single input source, this monitor will auto detect and switch to input device. Supporting Touch Back function, user can operate this monitor to control the other.



Auto detect input source in dashboard and switch to device directly.  
Both Audio and Video can be switched.

### Multi-input source

This monitor can detect up to two external sources input. For Multi-input source, this monitor can also support PbyP display.



Main Source  
Sub Source / PbyP function

#### Main Source

Main source default with the first input source which go with Main Source icon (🔴) and be the Left place in PbyP mode.

#### Sub Source

The second input source be the sub-source which go with PbyP icon (🟦), and be the Right place in PbyP mode.

#### TIPS

- Touch function default support in the left place in PbyP mode.

#### 1.2 Wireless input source

This monitor support Windows 10 / Android system device with Single source or Muti-sources wireless casting and PbyP display.

# Menu Items

## 2. Settings

The Settings button will open up the Settings panel and allow the user to change device settings.



Quick Settings	Volume	0-100% Mute
	Mic toggle	On/Off
	Brightness	0-100
Display	Contrast	0-100%
	Sharpness	0-100%
	Color	0-100%
	Tint	0-100%
	SOURCES ALIAS (Default: USB-C 1)	Edit
	SOURCES ALIAS (Default: USB-C 2)	Edit
	SOURCES ALIAS (Default: HDMI)	Edit
Network	TCP/IP	DHCP/Manual
	Proxy	None/Manual
System	High Contrast	On/Off
	Font Size	4 steps
	24-Hour Time	On/Off
	Set Automatically	On/Off Date, Time (When "Set Automatically" is set to "Off".)
	Time Zone	Select
	Idle Screen Time	1 minute 5 minutes 10 minutes 15 minutes 30 minutes 1 hour Never Can not be set longer than "Power Saving Timeout".
	Power Saving Timeout*	5 minutes 30 minutes 1 hour 3 hours 6 hours 12 hours Never
	Language	English Español Français Deutsch Italiano Русский
	Bluetooth	On/Off
	Temperature	Celsius Fahrenheit

System	LAN1 Network	On/Off
	USB-C Video Stream	SST (Single Stream Transport) / MST (Multi Stream Transport) Images may not be displayed properly depending on the computer (video card) to be connected.
Sensor Hub	Enable Sensors	On/Off
Device Information	OS/OS version	
	Model	
	Hardware ID/Serial number	
	Software License	
	Open Source Library	
Admin	Device Wireless LAN Name	
	Choose A New Wallpaper	Choose
	Install New Apps	Choose
	Country	Select
	Province / Region / State	Select
	City	Select
	Operation Mode	Mode1 Power Saving Timeout: 5 mins (Standby mode) In-Device Motion Sensor: On Wake On LAN: On IoT Sensor Hub Always On: Off Mode2 Power Saving Timeout: 5 mins (Backlight off) In-Device Motion Sensor: On Wake On LAN: On IoT Sensor Hub Always On: On
	Change User Passcode	Change
	Change Admin Passcode	Change
	OTA Firmware Updates	Update
	USB Firmware Updates	Update
	Firmware Update Window	Start Time End Time
	All Reset	Reset
	In-Device Motion Sensor*	On/Off
	Smart Switcher	On/Off
	Wake On LAN*	On/Off
	IoT Sensor Hub Always On*	On/Off
LAN1 Always-on Connection	On/Off	

\*: When "Operation Mode" is set to "Mode1", these settings can not be changed.

#### About "LAN1 Network" and "LAN1 Always-on Connection"

- "LAN1 Network" set to "On" to use the LAN 1 terminal.
- Disconnect the USB Type C cable or USB A to B cable, "LAN1 Network" will be set to "Off" automatically.  
If "LAN1 Always-on Connection" is set to "On", "LAN1 Network" will not be set to "Off" even if the cable is disconnected.

# Menu Items

## 2.1 Quick Settings



In Quick Settings menu, it can be controlled Volume / Mic toggle / Brightness in both this monitor and external devices.



## 2.4 System



System menu is focus on this monitor adjustment which including High Contrast / Font Size / Time setting and language.

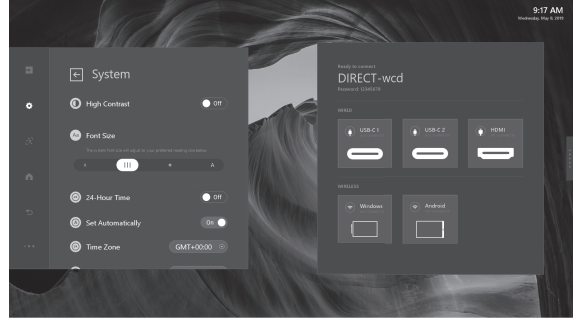

## 2.2 Display



The Display settings will only affect external sources. The Display settings will not be applied to this monitor.



## 2.5 Sensor Hub



Enable sensor data, user can see the sensor value below.



## 2.3 Network



Network menu is setting the LAN connection between this monitor and external devices.



## 2.6 Administration (Admin)



For others setting, admin collects other setting items. User can also update new firmware in Admin menu.



# Network

This monitor can be connected to a LAN.

The connection requires a commercially available LAN cable (UTP cable, Category 5, straight through).

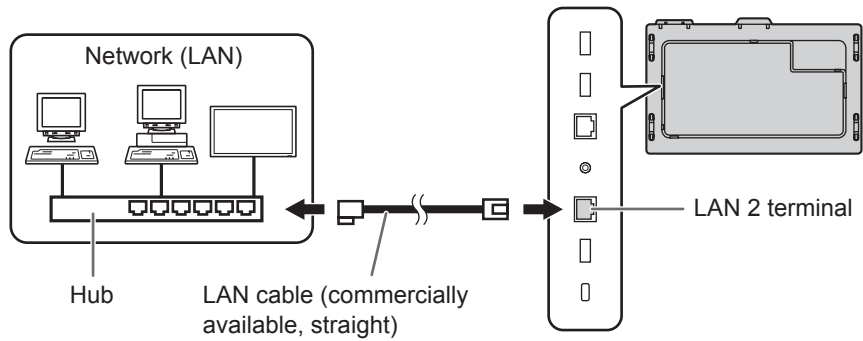

## ■ Settings to connect to a LAN (LAN 2)

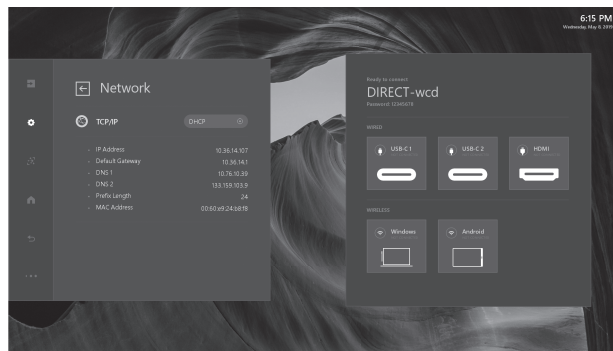

### 1. TCP/IP

If your LAN has a DHCP server and you wish to obtain an address automatically, change this setting to DHCP. To set the address manually, set this to Manual.

#### 1.1 IP Address

If the TCP/IP is set to Manual, specify an IP address.

#### 1.2 Default Gateway

If the TCP/IP is set to Manual, specify a default gateway.

#### 1.3 DNS 1

If the TCP/IP is set to Manual, specify a DNS.

#### 1.4 DNS 2

If the TCP/IP is set to Manual, specify a DNS.

#### 1.5 Subnet Mask

If the TCP/IP is set to Manual, specify a subnet mask.

#### 1.6 MAC Address

Show the MAC Address.

### 2. Proxy

If your LAN has a proxy server and you wish to use it, change this setting to Manual, otherwise set to None.

#### 2.1 Proxy Hostname

If the Proxy is set to Manual, specify a proxy hostname.

#### 2.2 Proxy Port

If the Proxy is set to Manual, specify a proxy port.

## TIPS

- This monitor supports application software RoomView from Crestron Electronics, Inc. This is a function to connect a system developed by Crestron Electronics, Inc. which manages and controls multiple system devices connected to the network. For details of Crestron Connected, refer to the Crestron Electronics, Inc. website. (Provided only In English.) <http://www.crestron.com/> For the download of RoomView Express, refer to the Crestron Electronics, Inc. website. (Provided only In English.) <http://www.crestron.com/getroomview>

# Troubleshooting

If you are experiencing any problem with your display, before calling for service, please review the following troubleshooting tips.

## **There is no picture or sound.**

- The power LED is off.
  - Is power supplied to this monitor?
  - Is the power cord disconnected? (See page 15.)
  - Is the main power switch off? (See page 16.)
- The power LED lights amber.
  - This monitor is in standby mode. Turn on the power. (See page 16.)

## **Remote control does not work.**

- Are the batteries inserted with polarity (+,-) aligned? (See page 15.)
- Are the batteries exhausted?
- Point the remote control unit toward the monitor's remote control sensor. (See page 15.)

## **There is a picture but no sound.**

- Is the sound muted?
- Make sure the volume is not set to minimum.
- Are audio cables connected properly?

## **Unstable video.**

- The signal may be incompatible.

## **The video from the HDMI input terminal does not appear properly.**

- Use the supplied HDMI cable.
- If using a commercially available cable, does the HDMI cable support 4K, and is it HDMI standard compliant? The monitor will not work with cables that are not standard compliant.
- Is the input signal compatible with this monitor? (See page 33.)

## **Control buttons do not work.**

### **There is no picture.**

- Load noises from outside may be interfering with normal operation. Turn off the main power and turn it on after waiting at least 5 seconds, and then check the operation.

### **The touch panel does not respond.**

- Is the USB cable connected properly?

### **The monitor makes a cracking sound.**

- You may occasionally hear a cracking sound from the monitor. This happens when the cabinet slightly expands and contracts according to change in temperature. This does not affect the monitor's performance.

# Specifications

## ■Product Specifications

Model	PN-CD701	
LCD component	70" Class [69-1/2 inch (176.6 cm) diagonal] TFT LCD	
Max. resolution	(pixels)	3840 x 2160
Max. colors	Approx. 1.06 billion colors	
Pixel pitch	0.401 mm (H) × 0.401 mm (V)	
Brightness (typical)	350 cd/m <sup>2</sup> *1	
Contrast ratio (typical)	4000: 1	
Viewing angle	176° right/left/up/down (contrast ratio ≥ 10)	
Screen active area	inch (mm)	60-9/16 (W) x 34-1/16 (H) (1538.9 x 865.6)
Computer input signal	USB type C (alternate mode)	
Input terminals	Video	HDMI x 1 USB Type C x 2
	Audio	3.5 mm mini stereo jack x 1
Output terminals	Video	USB Type C x 1
	Audio	3.5 mm mini stereo jack x 1
LAN terminal	10 / 100 / 1000 Mbps x 2	
Speaker output	12 W + 12 W	
Touch Panel	Detection method	Capacitive type
	Computer connector	USB (2.0 compliant) (Type B) x 1, USB Type C x 2
Wireless LAN	IEEE802.11ac/n/a/g/b compliant	
Bluetooth	4.2 compliant Supported protocols: A2DP, AVRCP, GATT, GAP, HID	
Power requirement	AC 100 V - 240 V, 4.2 A, 50/60 Hz	
Operating temperature*2*3	41°F to 95°F (5°C to 35°C)	
Operating humidity*3	20% to 80% (no condensation)	
Power consumption (Standby mode)	370 W (2.0 W)	
Dimensions (excluding protrusions)	inch (mm)	Approx. 63-15/16 (W) x 3-9/16 (D) x 38-7/16 (H) (1623.5 x 90.0 x 976.5)
Weight	lbs. (kg)	Approx. 143.3 (65)

\*1 Brightness will depend on input mode and other picture settings. Brightness level will decrease over time. Due to the nature of the equipment, it is not possible to precisely maintain a constant level of brightness.

\*2 Temperature condition may change when using the monitor together with the optional equipments recommended by SHARP. In such cases, please check the temperature condition specified by the optional equipments.

\*3 In addition, check the requirements of the computer and other devices to be connected, and make sure that all requirements are satisfied.

As a part of our policy of continuous improvement, SHARP reserves the right to make design and specification changes for product improvement without prior notice. The performance specification figures indicated are nominal values of production units. There may be some deviations from these values in individual units.

# Specifications

## ■ Dimensional Drawings

Note that the values shown are approximate values.

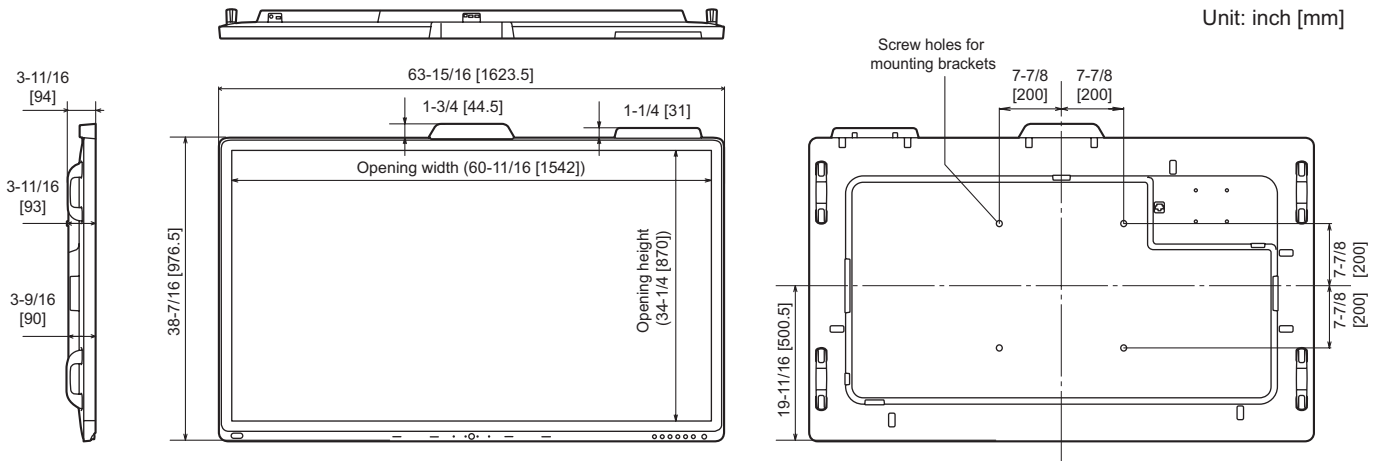

When mounting the monitor, be sure to use a wall-mount bracket that complies with the VESA-compatible mounting method. SHARP recommends using M6 screws and tighten the screws. Note that screw hole depth of the monitor is 3/8 inch (10 mm). Loose mounting may cause the product to fall, resulting in serious personal injuries as well as damage to the product. The screw and hole should come together with over 5/16 inch (8 mm) length of thread. Use a bracket which has been approved for UL1678 standard, and which can endure at least 4 times or more the weight of the monitor.



## Compatible signal timing

Screen resolution		Vsync	HDMI	USB Type C
VESA	640 × 480	60Hz	Yes	Yes
		72Hz	Yes	Yes
		75Hz	Yes	Yes
	800 × 600	56Hz	-	-
		60Hz	Yes	Yes
		72Hz	Yes	Yes
		75Hz	Yes	Yes
	848 × 480	60Hz	-	-
	1024 × 768	60Hz	Yes	Yes
		70Hz	Yes	Yes
		75Hz	Yes	Yes
	1152 × 864	75Hz	Yes	Yes
	1280 × 768	60Hz	-	Yes
		75Hz	-	Yes
	1280 × 800	60Hz	Yes	Yes
	1280 × 960	60Hz	Yes	Yes
	1280 × 1024	60Hz	Yes	Yes
		75Hz	Yes	Yes
	1360 × 768	60Hz	Yes	Yes
	1400 × 1050	60Hz	Yes	Yes
1440 × 900	60Hz	Yes	Yes	
1600 × 1200	60Hz	Yes	Yes	
1680 × 1050	60Hz	Yes	Yes	
1920 × 1200	60Hz	Yes	Yes	
Wide	3840 × 2160	24Hz	Yes	Yes
		25Hz	Yes	Yes
		30Hz	Yes	Yes
		50Hz	Yes	Yes
		60Hz	Yes	Yes
	1280 × 720	60Hz	Yes	Yes
	1920 × 1080	60Hz	Yes	Yes

- Depending on the connected computer, images may not be displayed properly even if the compatible signal described above is input.
- The RGB range supports only the full range.

## Specifications

### ■Channels that can be used in wireless LAN

	Standard	Channel	Frequency band (center frequency)
USA	IEEE802.11b/g/n	1-13ch	2412-2472MHz
	IEEE802.11ac/a/n	36/40/44/48ch	5180-5240MHz
		149/153/157/161/165ch	5745-5825MHz
CANADA	IEEE802.11b/g/n	1-11ch	2412-2462MHz
	IEEE802.11ac/a/n	36/40/44/48ch	5180-5240MHz
		149/153/157/161/165ch	5745-5825MHz

This device is restricted to indoor use due to its operation in the 5.15 GHz to 5.25 GHz frequency range. FCC requires this product to be used indoors for frequency range 5.15 GHz to 5.25 GHz to reduce the potential for harmful interference to co-channel Mobile Satellite systems.

High power radars are allocated as primary users of the 5.25 GHz to 5.35 GHz and 5.65 GHz to 5.85 GHz bands. These radar stations can cause interference with and/or damage this device.

# Intellectual Property Rights and Other Matters

## ■ Information on the software license for this product

### Software composition

The software included in this product is comprised of various software components whose individual copyrights are held by SHARP or by third parties.

### Software developed by SHARP and open source software

The copyrights for the software components and various relevant documents included with this product that were developed or written by SHARP are owned by SHARP and are protected by the Copyright Act, international treaties, and other relevant laws. This product also makes use of freely distributed software and software components whose copyrights are held by third parties. These include software components covered by a GNU General Public License (hereafter GPL), a GNU Lesser General Public License (hereafter LGPL) or other license agreement.

### Obtaining source code

Some of the open source software licensors require the distributor to provide the source code with the executable software components. GPL and LGPL include similar requirements. For information on obtaining the source code for the open source software and for obtaining the GPL, LGPL, and other license agreement information, visit the following website:

[https://jp.sharp/business/lcd-display/support/download/source\\_e.html](https://jp.sharp/business/lcd-display/support/download/source_e.html)

We are unable to answer any questions about the source code for the open source software. The source code for the software components whose copyrights are held by SHARP is not distributed.

# Mounting Precautions (For SHARP dealers and service engineers)

- When installing, removing or moving the monitor, ensure that this is carried out by at least 4 people.
- Be sure to use a wall-mount bracket designed or designated for mounting the monitor.
- This monitor is designed to be installed on a concrete wall or pillar. Reinforced work might be necessary for some materials such as plaster / thin plastic board / wood before starting installation.  
This monitor and bracket must be installed on a wall which can endure at least 4 times or more the weight of the monitor.  
Install by the most suitable method for the material and the structure.
- To attach a VESA-compliant mounting bracket, use M6 screws that are 5/16 inch (8 mm) to 3/8 inch (10 mm) longer than the thickness of the mounting bracket.

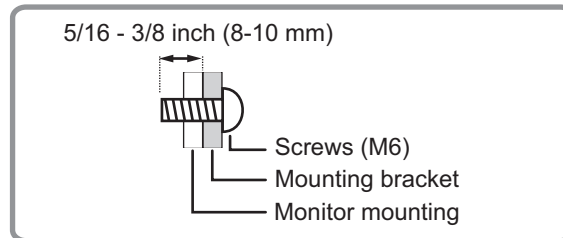

- Do not use an impact driver.
- After mounting, please carefully ensure the monitor is secure, and not able to come loose from the wall or mount.
- Do not use any screw holes other than those for mounting brackets, located on the rear of the monitor, for installation.
- When moving this monitor, be sure to hold it with the handles, the unit sides or the unit top. Do not grasp the screen, unit corner or speaker. This may cause product damage, failure, or injury.
- If you need to temporarily place the monitor on a table or other surface during installation, spread a thick soft cloth on the table to prevent damage to the screen and table.

**SHARP**<sup>®</sup>  
SHARP CORPORATION