

SHARP

Touchboards

205 Westwood Ave, Long Branch, NJ 07740
Phone: 866-94 BOARDS (26273) / (732)-222-1511
Fax: (732)-222-7088 | E-mail: sales@touchboards.com

PN-L802B
PN-L702B
PN-L602B
TOUCHSCREEN LCD MONITOR

Share, Collaborate, Communicate— An Intuitively Easy Touchscreen Solution



For All the Ease and Impact of Touchscreen Interaction

As a highly intuitive integrated touchscreen LCD monitor, the PN-L802B/L702B/L602B makes conventional presentation tools look out of touch with the communication needs of today's businesses and academic institutions. Along with superb image quality and easy operation, the PN-L802B/L702B/L602B brings the convenience of onscreen writing to a range of professional uses. Whether in a business setting or a classroom, functioning as an interactive whiteboard or as part of a videoconferencing system, the versatile PN-L802B/L702B/L602B brings easy communication and touch-and-show efficiency to your presentations. Isn't it time to get in touch?

A Multitude of Applications—Enhancing Communication in So Many Ways

Videoconferences



The big, bright screen brings those far away much closer in just-like-being-there videoconferences*. To facilitate communication, participants can digitally display documents and write notations directly on the screen.
* Requires separately sold videoconferencing system.

Education/Conferences

In spacious lecture halls or conference rooms, the PN-L802B/L702B/L602B can be linked to a large Sharp video wall that keeps all participants fully engaged. Sharp's interactive whiteboards can also link with separate venues for remote learning and two-way communication.

Showrooms



As an all-purpose showroom enhancer, the PN-L802B/L702B/L602B can be used to display product information, demonstrations, and more. And when the interactive whiteboard is hooked up to a Sharp MFP, onscreen info can be quickly printed out for customers.

Discussions/Presentations

Touch control lets users change pages and enlarge or move an object, while a touch pen lets them make annotations, keep track of new proposals, and maintain the focus of discussions. Simultaneously displaying text, images, and handwritten notes gives presenters a persuasive edge.



PN-L702B

Connectivity with Other Equipment Expands Communicative Potential

MFP Connectivity

Documents and images scanned from a colour-scan-capable Sharp MFP can be imported directly to the pen software for display on the LCD monitor. For added convenience, image data shown onscreen—including notations—can be saved to a PC or sent directly to an MFP for printout.

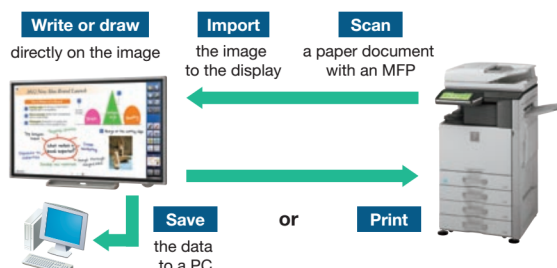

Video Wall Connectivity

Linking the PN-L802B/L702B/L602B to a multi-screen configuration of Sharp PN-V602/V601 monitors enables the instant display of content as it's created and makes even small text easily visible.



PC Connectivity

Linking the PN-L802B/L702B/L602B to a PC makes it easy to bring up shared documents stored on a cloud. And after meetings, whiteboard notes saved on the PC as PDF documents can be e-mailed with ease to all concerned parties.



Note: Depending on the system, separately sold peripheral equipment may be required. Consult your local dealer for more information.

Simple and Straightforward Operation Via Touch Pen or Finger

Simple and Intuitive User Interface

Developed specifically for Sharp touchscreen LCD monitors, the bundled **Sharp Pen Software** allows anyone to smoothly and easily operate the PN-L802B/L702B/L602B. Once documents created on any application software have been imported as images and displayed on the touchscreen, users can quickly write and draw directly on the screen surface using the bundled **touch pen** or a finger.

This user-friendly interface supports onscreen functions for pen-colour and line-thickness selection as well as an **eraser** tool that can be used to delete selected notations or clear the entire screen at once. Screen images can be enlarged or rotated, and handwritten notations such as text and drawings can be selected and repositioned.

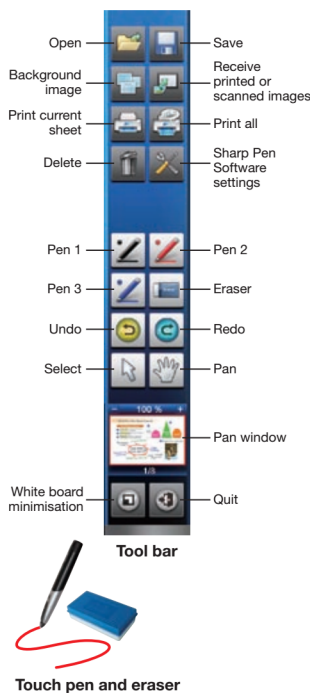

Ready-to-Use Templates

Eight ready-to-use templates come preinstalled: Action Plan/Calendar/Chalk Board/Cork/Graph/Minutes/Monthly Schedule/To Do List. Users can also custom make their own original templates.

Upgraded Sharp Pen Software* provides these advanced functions and more!

Floating Tool Bar

The tool bar won't get in the way of the presenter. It can be moved about freely on the screen, displayed horizontally or vertically, or even hidden from view.

Expanded Sheet Preview Function

Pages displayed onscreen can be easily saved and called up. Convenient editing functions allow pages to be added, deleted, copied, and moved. And multiple pages can be displayed on the screen as **thumbnails**.



* Consult your local dealer about availability and other details.

Dual-Touch Interface

The PN-L802B/L702B/L602B supports a dual-touch* function. In addition to letting the user **scroll** pages with two fingers, this function makes it possible to **enlarge** then **shrink** an image by simply spreading two fingers apart and then bringing them together.

* Available only on Windows® 7

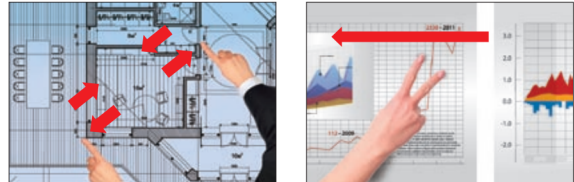

Microsoft® Office Ink Tools*

The PN-L802B/L702B/L602B supports Microsoft® Office ink functionality, allowing the user to write on Excel® or Word documents displayed onscreen and save the files—notations and all.

* Available only on Windows® 7

Touch Application Pad (option)

The optional Touch Application Pad can be installed onto the pen tray for easy access to touch pen functions. The pad boasts 10 one-touch buttons, each of which can be programmed to execute a Sharp Pen Software command, issue a key/mouse code, or start a specified application. With two **USB ports**, the pad also functions as a convenient USB hub for connecting the PN-L802B/L702B/L602B to a USB memory device, keyboard, or mouse.

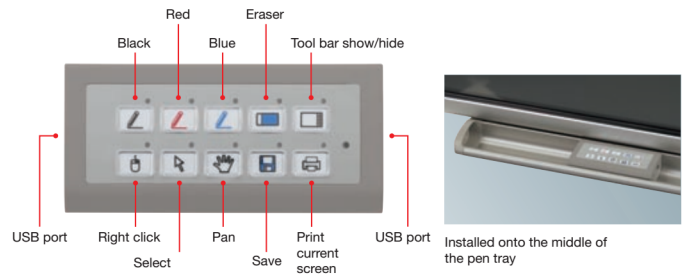

Enhanced Touchscreen Response

The PN-L802B/L702B/L602B's integration of a high-quality LCD panel and a highly sensitive touchscreen makes for easy communication. For heightened touchscreen responsiveness and stress-free onscreen writing, the PN-L702B and the PN-L602B employ Sharp's proprietary **infrared blocking detection system**, which uses multiple infrared sensors to locate the position of the user's finger or the touch pen. The PN-L802B employs a system better suited for very large screens: **optical imaging** technology uses optical cameras in the upper right and left corners of the screen to detect shadows made on the screen by the user's finger or the touch pen.

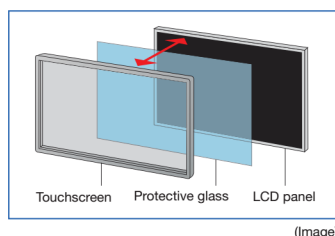

Outstanding Image Quality in Three Sizes

The LCD panel on the PN-L802B/L702B/L602B comes in three large screen sizes: **80 inches**, **70 inches**, and **60 inches**. All three sizes incorporate Sharp's **UV²A*** technology, which ensures highly efficient backlighting and prevents light leakage for the display of bright whites, vivid colours, and deep blacks. The PN-L802B/L702B's full-array **LED backlight** and the PN-L602B's edge-lit LED backlight provide easy readability and reliable performance—all with low power consumption.

* UV²A stands for "Ultraviolet-induced Multi-domain Vertical Alignment," a photo-alignment technology that ensures uniform alignment of liquid crystal molecules in a certain direction.



Specifications

Model Name	PN-L802B	PN-L702B	PN-L602B	
Installation	Landscape		Landscape/Portrait*1 (Pen software works with landscape installation)	
LCD Panel	80-inch widescreen (203.2 cm diagonal) UV [†] A LCD	70-inch widescreen (176.6 cm diagonal) UV [†] A LCD	60-inch widescreen (152.5 cm diagonal) UV [†] A LCD	
	Max. Resolution	1,920 x 1,080 pixels		
	Max. Display Colours (approx.)	1,064 million colours		
	Pixel Pitch (H x V)	0.923 x 0.923 mm	0.802 x 0.802 mm	0.692 x 0.692 mm
	Max. Brightness (average)*2	300 cd/m ²		
	Contrast Ratio	3,000 : 1		
	Viewing Angle (H/V)	160°/160° (CR ≥ 10)		
	Active Screen Area (W x H) (approx.)	1,771.2 x 996.3 mm (69 3/4" x 39 1/4")	1,538.9 x 865.6 mm (60 9/16" x 34 1/16")	1,329.1 x 747.6 mm (52 3/16" x 29 7/16")
	Response Time	6 ms (grey to grey, avg.)		
	Backlight	White LED, full array		White LED, edge lit
Touchscreen	Touch Technology	Optical imaging method	Infrared blocking detection method	
	PC Connection Port	USB (1.1 standard) x 1		
	Power Supply	PC through USB port		
	Driver	OS: Windows [®] XP, Windows Vista [®] , Windows [®] 7		
	Protection Glass Thickness*3	Approx. 3.4 mm	Approx. 3.0 mm	
Touch Pen	Communication	Ultrasonic communication method		
	Button	2 function buttons		
Computer Input	Video	Analogue RGB (0.7 Vp-p) [75Ω], Digital (conforms to DVI 1.0 standards)		
	Synchronisation	Horizontal/vertical separation (TTL: positive/negative), Sync on green, Composite sync (TTL: positive/negative)		
	Plug & Play	VESA DDC2B		
	Power Management	VESA DPMS, DVI DMPM		
Video Colour System	With Optional PN-ZB01	NTSC (3.58 MHz, 4.43 MHz), PAL, PAL60, SECAM		
Input Terminals*4	Standard	PC analogue: Mini D-sub 15-pin x 1, HDMI x 1*5, 3.5 mm-diameter mini stereo jack x 1, RS-232C D-sub 9-pin x 1		
	With Optional PN-ZB01	PC digital: DVI-D 24-pin x 1*5, PC analogue: BNC x 1*6*7, Video: BNC x 1, S-Video x 1, Component video: BNC (Y, Cb/Pb, Cr/Pr) x 1*8, Audio: RCA pin (L/R) x 2		
Output Terminals	Standard	Audio: RCA pin (L/R) x 1, RS-232C D-sub 9-pin x 1		
	With Optional PN-ZB01	PC digital: DVI-D 24-pin x 1*5		
Input/Output Terminals	With Optional PN-ZB01	LAN port		
Speaker Output	Built-in	7 W + 7 W		
	External	7 W + 7 W (6Ω)*8		
Power Supply	100V – 240V AC, 50/60 Hz			
Power Consumption	260 W		240 W	
	170 W			
Environmental Conditions	Operating Temperature	5°C to 35°C		
	Operating Humidity	20% to 80% RH (no condensation)		
Dimensions (W x D x H) (approx.) (display only)	1,880 x 135 x 1,157 mm (74" x 5 3/16" x 45 3/16")	1,648 x 116 x 982 mm (64 7/8" x 4 9/16" x 38 11/16")	1,440 x 101 x 855 mm (56 11/16" x 4" x 33 11/16")	
Weight (not including PN-ZB01) (approx.)	102 kg (224.9 lbs)	70 kg (154.3 lbs)	54 kg (119.0 lbs)	
Main Accessories	Touch pen, touch pen battery (AAA size), pen tips (for touch pen) x 2, eraser, pen tray, power cord, remote control unit, batteries (AA size x 2), CD-ROM, set-up manual, terminal label, Sharp logo cover sticker, cable clamp x 3 (2 for PN-L702B), USB cable, tray mounting fittings x 2, tray mounting screws x 6			

*1 Portrait installation may not be available in some regions. Consult your local dealer for details. *2 Brightness will depend on input mode and other picture settings. Brightness level will decrease over time. Due to the nature of the equipment, it is not possible to precisely maintain a constant level of brightness. *3 Including AR coating on both sides. *4 Use a commercially available connection cable for PC and other video connections. *5 HDCP compatible. For both PC and AV components. *6 The analogue and component BNC terminals are switchable. Use the menu to select. *7 Does not support plug & play. *8 Requires optional PN-ZB01.

DESIGN AND SPECIFICATIONS ARE SUBJECT TO CHANGE WITHOUT PRIOR NOTICE.

Dimensions

(PN-L802B)

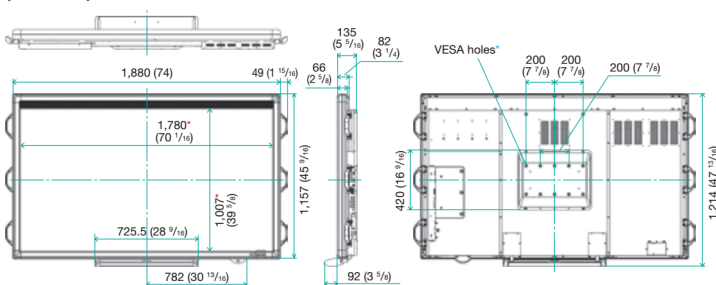

Units: mm (inch)

* Screen dimensions

* To use the VESA-standard mounting bracket, use M6 screws that are 8 to 10 mm plus the thickness of the bracket.

(PN-L702B)

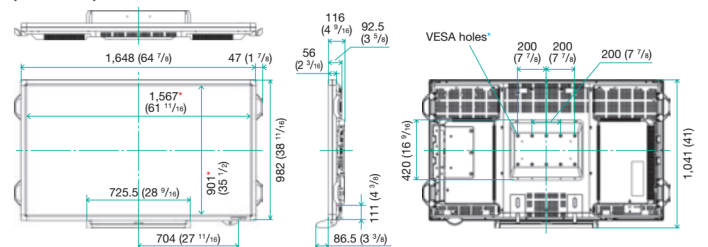

(PN-L602B)

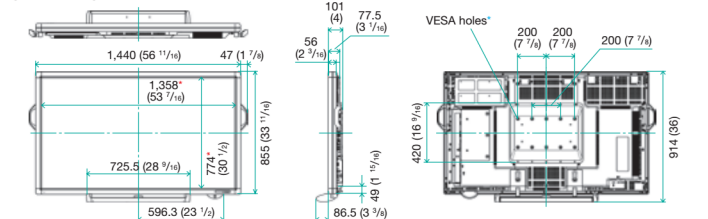

Input/Output Terminals

(standard)

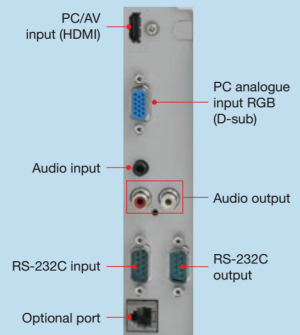

(option)

PN-ZB01 Interface Expansion Board

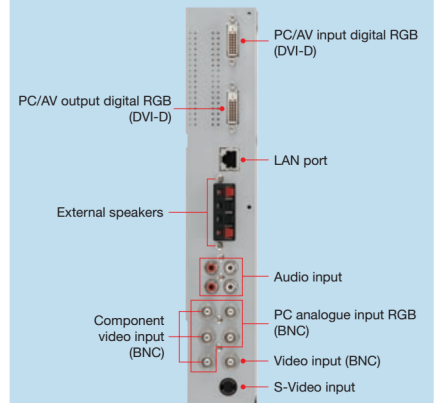

Options

- PN-ZB01 : Interface Expansion Board
- PN-ZC01 : Touch Application Pad

For PN-L802B

- PN-ZS80F : Stand (2,100 mm height)

For PN-L702B

- PN-ZS70F : Stand (2,100 mm height)
- PN-ZS701 : Stand (1,800 mm height)

For PN-L602B

- PN-ZS60F : Stand (2,100 mm height)
- PN-ZS609 : Stand (1,800 mm height)

Consult your local Sharp dealer or representative on availability and other details.

Distributed by:

SHARP