

SHARP[®]

PN-UH861

4K ULTRA HD COMMERCIAL TV

PN-UH551

PN-UH501

PN-UH431

4K ULTRA HD TV

OPERATION MANUAL

 **DOLBY AUDIO**[™]

HDMI

IMPORTANT:

To aid reporting in case of loss or theft, please record the product's model and serial numbers in the space provided. The numbers are located in the rear of the product.



Model No.:

Serial No.:

U.S.A. ONLY

IMPORTANT INFORMATION

WARNING: TO REDUCE THE RISK OF FIRE OR ELECTRIC SHOCK, DO NOT EXPOSE THIS PRODUCT TO RAIN OR MOISTURE.

	CAUTION RISK OF ELECTRIC SHOCK DO NOT OPEN	
<p>CAUTION: TO REDUCE THE RISK OF ELECTRIC SHOCK, DO NOT REMOVE COVER. NO USER-SERVICEABLE PARTS INSIDE. REFER SERVICING TO QUALIFIED SERVICE PERSONNEL.</p>		



The lightning flash with arrowhead symbol, within a triangle, is intended to alert the user to the presence of uninsulated "dangerous voltage" within the product's enclosure that may be of sufficient magnitude to constitute a risk of electric shock to persons.



The exclamation point within a triangle is intended to alert the user to the presence of important operating and maintenance (servicing) instructions in the literature accompanying the product.

WARNING:

FCC Regulations state that any unauthorized changes or modifications to this equipment not expressly approved by the manufacturer could void the user's authority to operate this equipment.

NOTE:

This equipment has been tested and found to comply with the limits for a Class A digital device, pursuant to Part 15 of the FCC Rules. These limits are designed to provide reasonable protection against harmful interference when the equipment is operated in a commercial environment. This equipment generates, uses, and can radiate radio frequency energy and, if not installed and used in accordance with the instruction manual, may cause harmful interference to radio communications. Operation of this equipment in a residential area is likely to cause harmful interference in which case the user will be required to correct the interference at his own expense.

U.S.A. ONLY

To maintain compliance with EMC regulations, use shielded cables to connect to the following terminals: HDMI input terminal, D-sub input terminal and RS-232C input terminal.

INFORMATION:

There is no guarantee that interference will not occur in a particular installation. If this equipment does cause harmful interference to radio or television reception, which can be determined by turning the equipment off and on, the user is encouraged to try to correct the interference by one or more of the following measures:

- Reorient or relocate the receiving antenna.
- Increase the separation between the equipment and receiver.
- Connect the equipment into an outlet on a circuit different from that to which the receiver is connected.
- Consult the dealer or an experienced radio/TV technician for help.

"Note to CATV system installer: This reminder is provided to call the CATV system installer's attention to Article 820 of the National Electrical Code that provides guidelines for proper grounding and, in particular, specifies that the cable ground shall be connected to the grounding system of the building, as close to the point of cable entry as practical."

DEAR SHARP CUSTOMER

Thank you for your purchase of a SHARP LCD monitor. To ensure safety and many years of trouble-free operation of your product, please read the Safety Precautions carefully before using this product.

SAFETY PRECAUTIONS

Electricity is used to perform many useful functions, but it can also cause personal injuries and property damage if improperly handled. This product has been engineered and manufactured with the highest priority on safety. However, improper use can result in electric shock and/or fire. In order to prevent potential danger, please observe the following instructions when installing, operating and cleaning the product. To ensure your safety and prolong the service life of your LCD monitor, please read the following precautions carefully before using the product.

1. Read instructions — All operating instructions must be read and understood before the product is operated.
2. Keep this manual in a safe place — These safety and operating instructions must be kept in a safe place for future reference.
3. Observe warnings — All warnings on the product and in the instructions must be observed closely.
4. Follow instructions — All operating instructions must be followed.
5. Cleaning — Unplug the power cord from the power outlet before cleaning the product. Use a dry cloth to clean the product. Do not use liquid cleaners or aerosol cleaners. Do not use dirty cloths. Doing so may damage the product.
6. Attachments — Do not use attachments not recommended by the manufacturer. Use of inadequate attachments can result in accidents.
7. Water and moisture — Do not use the product near water. Do not install the product in a place where water may splash onto it. Be careful of equipment which drains water such as an air-conditioner.
8. Ventilation — The vents and other openings in the cabinet are designed for ventilation. Do not cover or block these vents and openings since insufficient ventilation can cause overheating and/or shorten the life of the product. Do not place the product on a sofa, rug or other similar surface, since they can block ventilation openings. Do not place the product in an enclosed place such as a bookcase or rack, unless proper ventilation is provided or the manufacturer's instructions are followed.
9. Power cord protection — The power cords must be routed properly to prevent people from stepping on them or objects from resting on them.
10. The LCD panel used in this product is made of glass. Therefore, it can break when the product is dropped or applied with impact. Be careful not to be injured by broken glass pieces in case the LCD panel breaks.
11. Overloading — Do not overload power outlets or extension cords. Overloading can cause fire or electric shock.
12. Entering of objects and liquids — Never insert an object into the product through vents or openings. High voltage flows in the product, and inserting an object can cause electric shock and/or short internal parts. For the same reason, do not spill water or liquid on the product.
13. Servicing — Do not attempt to service the product yourself. Removing covers can expose you to high voltage and other dangerous conditions. Request a qualified service person to perform servicing.
14. Repair — If any of the following conditions occurs, unplug the power cord from the power outlet, and request a qualified service person to perform repairs.
 - a. When the power cord or plug is damaged.
 - b. When a liquid was spilled on the product or when objects have fallen into the product.
 - c. When the product has been exposed to rain or water.
 - d. When the product does not operate properly as described in the operating instructions.

Do not touch the controls other than those described in the operating instructions. Improper adjustment of controls not described in the instructions can cause damage, which often requires extensive adjustment work by a qualified technician.
 - e. When the product has been dropped or damaged.
 - f. When the product displays an abnormal condition. Any noticeable abnormality in the product indicates that the product needs servicing.
15. Replacement parts — In case the product needs replacement parts, make sure that the service person uses replacement parts specified by the manufacturer, or those with the same characteristics and performance as the original parts. Use of unauthorized parts can result in fire, electric shock and/or other danger.
16. Safety checks — Upon completion of service or repair work, request the service technician to perform safety checks to ensure that the product is in proper operating condition.
17. Wall mounting — When mounting the product on a wall, be sure to install the product according to the method recommended by the manufacturer.
18. Heat sources — Keep the product away from heat sources such as radiators, heaters, stoves and other heat-generating products (including amplifiers).

SAFETY PRECAUTIONS (Continued)

19. Batteries — Incorrect use of batteries may cause the batteries to burst or ignite. A leaky battery may corrode the equipment, dirty your hands or spoil your clothing. In order to avoid these problems, make sure to observe the precautions below:
 - Use the specified batteries only.
 - Install the batteries with due attention to the plus (+) and minus (-) sides of the batteries according to the instructions in the compartment.
 - Do not mix old and new batteries.
 - Do not mix batteries of different types. Voltage specifications of batteries of the same shape may vary.
 - Replace an exhausted battery with a new one promptly.
 - If you will not use the remote control for a long time, remove the batteries.
 - If leaked battery fluid gets on your skin or clothing, rinse immediately and thoroughly. If it gets into your eye, bathe your eye well rather than rubbing and seek medical treatment immediately. Leaked battery fluid that gets into your eye or your clothing may cause a skin irritation or damage your eye.
20. Usage of the monitor must not be accompanied by fatal risks or dangers that, could lead directly to death, personal injury, severe physical damage or other loss, including nuclear reaction control in nuclear facility, medical life support system, and missile launch control in a weapon system.
21. Do not stay in contact with the parts of the product that become hot for long periods of time. Doing so may result in low-temperature burns.
22. Do not modify this product.
23. To prevent fire or shock hazard, do not expose this product to dripping or splashing.
No objects filled with liquids, such as vases, should be placed on the product.
24. This product must only be connected to a 120V, 60Hz, grounded (3-prong) outlet. (PN-UH861 ONLY)

WARNING:

- 1) This is a Class A product. In a domestic environment this product may cause radio interference in which case the user may be required to take adequate measures.
- 2) Batteries shall not be exposed to excessive heat such as sunshine, fire or the like.
- 3) To prevent injury, this apparatus must be securely attached to the floor/wall in accordance with the installation instructions.
- 4) An apparatus with CLASS I construction shall be connected to a MAIN socket outlet with a protective earthing connection. (PN-UH861 ONLY)

STABILITY HAZARD

- The television set may fall, causing serious personal injury or death.
Never place a television set in an unstable location. A television set may fall, causing serious personal injury or death. Many injuries, particularly to children, can be avoided by taking simple precautions such as:
 - Using cabinets or stands recommended by the manufacturer of the television set.
 - Only using furniture that can safely support the television set.
 - Ensuring the television set is not overhanging the edge of the supporting furniture.
 - Not placing the television set on tall furniture (for example, cupboards or bookcases) without anchoring both the furniture and the television set to a suitable support.
 - Not placing the television set on cloth or other materials that may be located between the television set and supporting furniture.
 - Educating children about the dangers of climbing on furniture to reach the television set or its controls.
- If the existing television set is going to be retained and relocated, the same considerations as above should be applied.

Especially for child safety

- Don't allow children to climb on or play with the monitor.
- Don't place the monitor on furniture that can easily be used as steps, such as a chest of drawers.
- Remember that children can become excited while watching a program, especially on a "larger than life" monitor. Care should be taken to place or install the monitor where it cannot be pushed, pulled over, or knocked down.
- Care should be taken to route all cords and cables connected to the monitor so that they cannot be pulled or grabbed by curious children.

This equipment is not suitable for use in locations where children are likely to be present. (PN-UH861 ONLY)

IMPORTANT SAFETY INSTRUCTIONS

- 1) Read these instructions.
- 2) Keep these instructions.
- 3) Heed all warnings.
- 4) Follow all instructions.
- 5) Do not use this apparatus near water.
- 6) Clean only with dry cloth.
- 7) Do not block any ventilation openings. Install in accordance with the manufacturer's instructions.
- 8) Do not install near any heat sources such as radiators, heat registers, stoves, or other apparatus (including amplifiers) that produce heat.
- 9) Do not defeat the safety purpose of the polarized or grounding-type plug. A polarized plug has two blades with one wider than the other. A grounding type plug has two blades and a third grounding prong. The wide blade or the third prong are provided for your safety. If the provided plug does not fit into your outlet, consult an electrician for replacement of the obsolete outlet.
- 10) Protect the power cord from being walked on or pinched particularly at plugs, convenience receptacles, and the point where they exit from the apparatus.
- 11) Only use attachments/accessories specified by the manufacturer.
- 12) Use only with the cart, stand, tripod, bracket, or table specified by the manufacturer, or sold with the apparatus. When a cart is used, use caution when moving the cart/apparatus combination to avoid injury from tip-over.
- 13) Unplug this apparatus during lightning storms or when unused for long periods of time.
- 14) Refer all servicing to qualified service personnel. Servicing is required when the apparatus has been damaged in any way, such as power-supply cord or plug is damaged, liquid has been spilled or objects have fallen into the apparatus, the apparatus has been exposed to rain or moisture, does not operate normally, or has been dropped.
- 15) Power Sources — This product should be operated only from the type of power source indicated on the marking label. If you are not sure of the type of power supply to your home, consult your product dealer or local power company.



- Outdoor Antenna Grounding — If an outside antenna is connected to the television equipment, be sure the antenna system is grounded so as to provide some protection against voltage surges and built-up static charges. Article 810 of the National Electrical Code, ANSI/NFPA 70, provides information with regard to proper grounding of the mast and supporting structure, grounding of the lead-in wire to an antenna discharge unit, size of grounding conductors, location of antenna-discharge unit, connection to grounding electrodes, and requirements for the grounding electrode.

EXAMPLE OF ANTENNA GROUNDING AS PER NATIONAL ELECTRICAL CODE, ANSI/NFPA 70

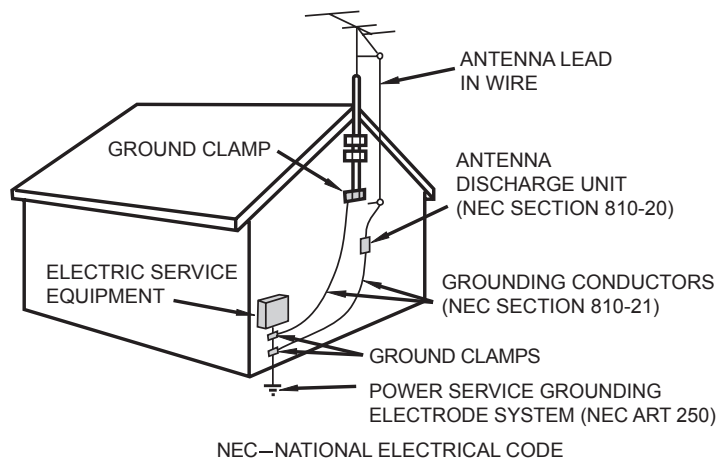

- Lightning — For added protection for this television equipment during a lightning storm, or when it is left unattended and unused for long periods of time, unplug it from the wall outlet and disconnect the antenna. This will prevent damage to the equipment due to lightning and power-line surges.
- Power Lines — An outside antenna system should not be located in the vicinity of overhead power lines or other electric light or power circuits, or where it can fall into such power lines or circuits. When installing an outside antenna system, extreme care should be taken to keep from touching such power lines or circuits as contact with them might be fatal.

TIPS AND SAFETY INSTRUCTIONS

- The TFT color LCD panel used in this monitor is made with the application of high precision technology. However, there may be minute points on the screen where pixels never light or are permanently lit. Also, if the screen is viewed from an acute angle there may be uneven colors or brightness. Please note that these are not malfunctions but common phenomena of LCDs and will not affect the performance of the monitor.
- Do not display a still picture for a long period, as this could cause a residual image.
- Never rub or tap the monitor with hard objects.
- Please understand that SHARP CORPORATION bears no responsibility for errors made during use by the customer or a third party, nor for any other malfunctions or damage to this product arising during use, except where indemnity liability is recognized under law.
- This monitor and its accessories may be upgraded without advance notice.
- Do not use the monitor where there is a lot of dust, where humidity is high, or where the monitor may come into contact with oil or steam. Do not use in an environment where there are corrosive gases (sulfur dioxide, hydrogen sulfide, nitrogen dioxide, chlorine, ammonia, ozone, etc.). As this could lead to fire.
- Ensure that the monitor does not come into contact with water or other fluids. Ensure that no objects such as paper clips or pins enter the monitor as this could lead to fire or electric shock.
- Do not place the monitor on top of unstable objects or in unsafe places. Do not allow the monitor to receive strong shocks or to strongly vibrate. Causing the monitor to fall or topple over may damage it.
- Do not use the monitor near heating equipment or in places where there is likelihood of high temperature, as this may lead to generation of excessive heat and outbreak of fire.
- Do not use the monitor in places where it may be exposed to direct sunlight. Risk of cabinet deformation and failure if the monitor is used in direct sunlight.
- If the monitor is installed in a location exposed to sunlight such as next to a window, measures to reduce ultraviolet and infrared radiation and temperature measures are required. For details, consult your dealer.
- Please be sure to constantly remove dust and garbage that has attached to the ventilation opening. If dust collects in the ventilation opening or the inside of the monitor, it may lead to excessive heat, outbreak of fire, or malfunction. Please request a cleaning of the inside of the monitor from an authorized SHARP servicing dealer or service center.
- The power outlet shall be installed near the equipment and shall be easily accessible.
- Continuous operating time and warranty.
This product is designed for a maximum daily use of 16 hours. Continual use in excess of 16 hours per day is not covered by the warranty.

The Power Cord

- Use only the power cord supplied with the monitor.
- Do not damage the power cord nor place heavy objects on it, stretch it or over bend it. Also, do not add extension cords. Damage to the cord may result in fire or electric shock.
- Do not use the power cord with a power tap. Adding an extension cord may lead to fire as a result of overheating.
- Do not remove or insert the power plug with wet hands. Doing so could result in electric shock.
- Unplug the power cord if it is not used for a long time.
- Do not attempt to repair the power cord if it is broken or malfunctioning. Refer the servicing to the service representative.

Manual Scope

- Microsoft and Windows are either registered trademarks or trademarks of Microsoft Corporation in the United States and/or other countries.
- Manufactured under license from Dolby Laboratories. Dolby, Dolby Audio, and the double-D symbol are trademarks of Dolby Laboratories.
- The terms HDMI and HDMI High-Definition Multimedia Interface, and the HDMI Logo are trademarks or registered trademarks of HDMI Licensing Administrator, Inc. in the United States and other countries.
- VESA is either registered trademark or trademark of Video Electronics Standards Association in the United States and/or other countries.
- All other brand and product names are trademarks or registered trademarks of their respective holders.
- Language of OSD menu used in this manual is English by way of example.
- Illustrations in this manual may not exactly represent the actual product or display.

LED Backlight

- The LED backlight in this product has a limited lifetime.
 - * If the screen gets dark or does not turn on, it may be necessary to replace the LED backlight.
 - * This LED backlight is exclusive to this product and must be replaced by an authorized SHARP servicing dealer or service center. Please contact an authorized SHARP servicing dealer or service center for assistance.

MOUNTING PRECAUTIONS

- This product is for use indoors.
- A mounting bracket compliant with VESA specifications is required.
- Since the monitor is heavy, consult your dealer before installing, removing or moving the monitor.
- Mounting the monitor on the wall requires special expertise and the work must be performed by an authorized SHARP dealer. You should never attempt to perform any of this work yourself. Our company will bear no responsibility for accidents or injuries caused by improper mounting or mishandling.
- Use the monitor with the surface perpendicular to a level surface. If necessary, the monitor may be tilted up to 20 degrees upward or downward.
- This monitor should be used at an ambient temperature between 32°F (0°C) and 104°F (40°C). Provide enough space around the monitor to prevent heat from accumulating inside.

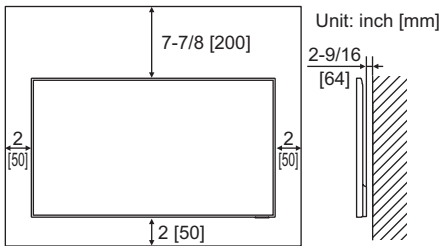

- If it is difficult to provide sufficient space for any reason such as the installation of the monitor inside a housing, or if the ambient temperature may be outside of the range of 32°F (0°C) to 104°F (40°C), install a fan or take other measures to keep the ambient temperature within the required range.
- Do not block any ventilation openings. If the temperature inside the monitor rises, this could lead to a malfunction.
- Do not place the monitor on a device which generates heat.

Contents

IMPORTANT INFORMATION	3	Menu Items	22
DEAR SHARP CUSTOMER	4	Displaying the menu screen.....	22
SAFETY PRECAUTIONS	4	Menu item details.....	23
IMPORTANT SAFETY INSTRUCTIONS	6	Adjustments for computer screen display.....	28
TIPS AND SAFETY INSTRUCTIONS	7	Controlling the Monitor with a computer (RS-232C) ...	29
MOUNTING PRECAUTIONS	8	Computer connection.....	29
Supplied Components	9	Communication conditions.....	29
Part Names	10	Communication procedure.....	29
Connecting Peripheral Equipment	12	RS-232C command table.....	30
Connecting the Power Cord	14	Controlling the Monitor with a computer (LAN).....	32
Binding Cables	15	Settings to connect to a LAN.....	32
Attaching the logo sticker	15	Command-based control.....	32
Preparing the Remote Control Unit	16	Troubleshooting	33
Installing the batteries.....	16	Specifications	34
Remote control operation range.....	16	Mounting Precautions	
Turning Power On/Off	17	(For SHARP dealers and service engineers).....	37
Turning power on/off.....	17		
Basic Operation	18		
Using Media Player	20		
Playing files.....	20		
Auto playback.....	21		
Operations during play.....	21		

Supplied Components

If any component should be missing, please contact your dealer.

- LCD TV: 1
- Remote control unit: 1
- Power cord: 1
- LR03 battery ("AAA" size): 2
- CD-ROM (Utility Disk for Windows): 1
- Setup Manual: 1
- Specification sheet
- Cable clamp: 2
- Logo sticker: 1

* SHARP Corporation holds authorship rights to the Utility Disk program. Do not reproduce it without permission.

* For environmental protection!

Do not dispose of batteries in household waste. Follow the disposal instructions for your area.

Part Names

■ Front view

[PN-UH861]

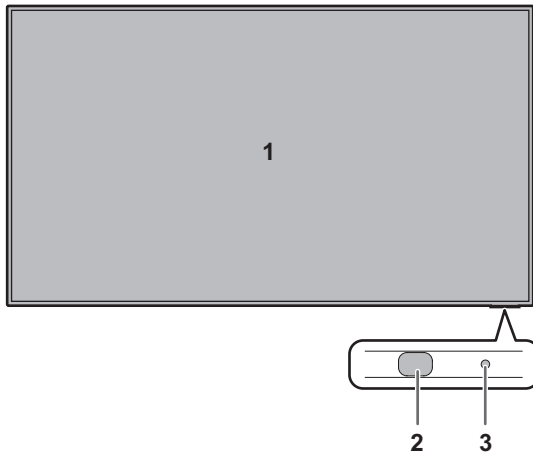

■ Rear view

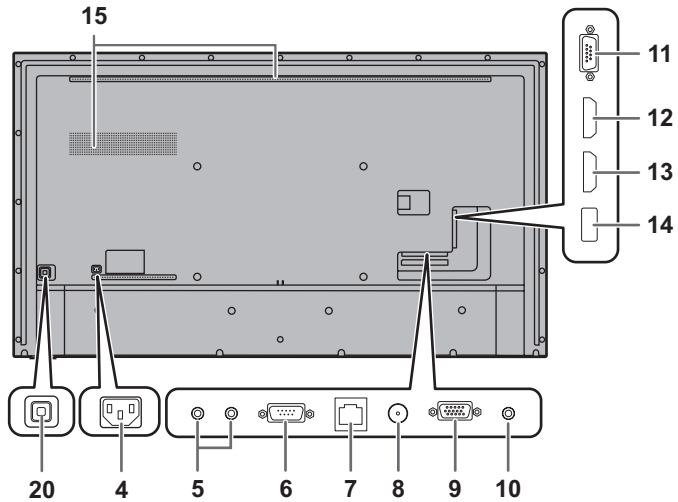

[PN-UH551/PN-UH501/PN-UH431]

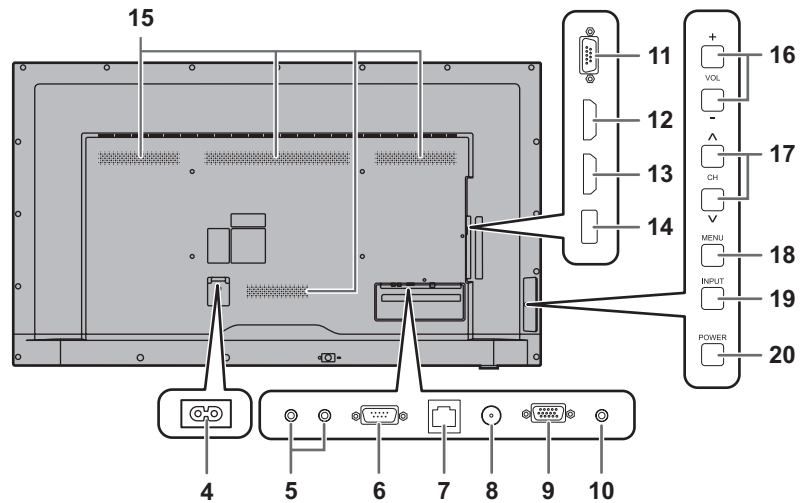
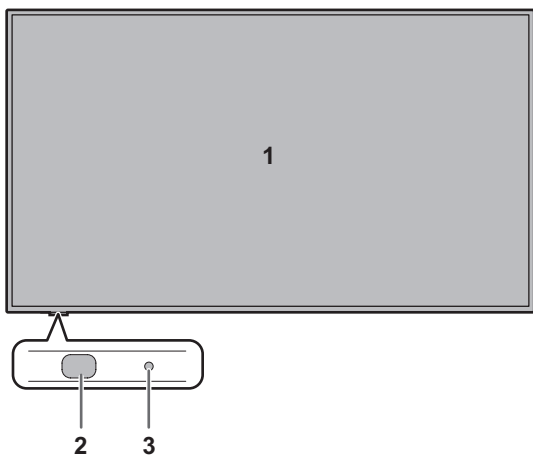

1. LCD panel
2. Remote control sensor (See page 16.)
3. Power LED (See page 17.)
4. AC input terminal (See page 14.)
5. Audio output terminal (See page 12.)
6. RS-232C input terminal (See page 12.)
7. LAN terminal (See page 12.)
8. Antenna terminal (See page 12.)
9. D-sub input terminal (See page 12.)
10. Audio input terminal (See page 12.)
11. IR output terminal (See page 12.)

12. HDMI1 input terminal (See page 12.)
13. HDMI2 input terminal (See page 12.)
14. USB port (See page 13.)
15. Vents
16. VOL +/- button (See page 18.)
17. CH ^/v button (See page 18.)
18. MENU button (See page 18.)
19. INPUT button (See page 18.)
20. POWER button (See page 17.)

■ Remote control unit

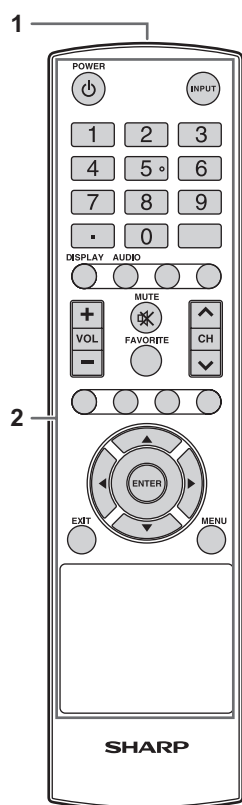

1. Signal transmitter
2. Operation buttons (See page 18.)

Connecting Peripheral Equipment

[PN-UH861]

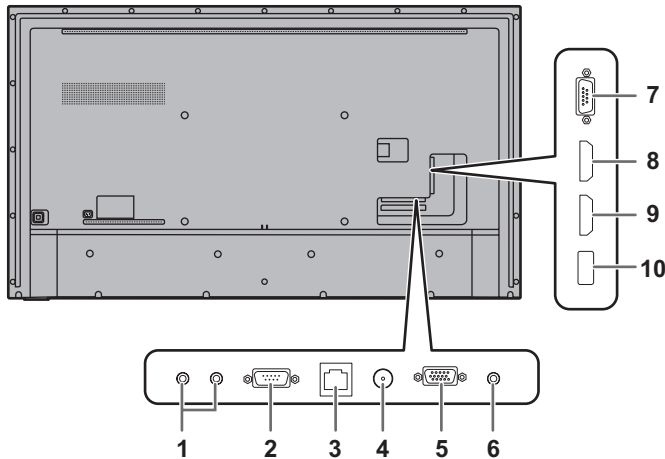

[PN-UH551/PN-UH501/PN-UH431]

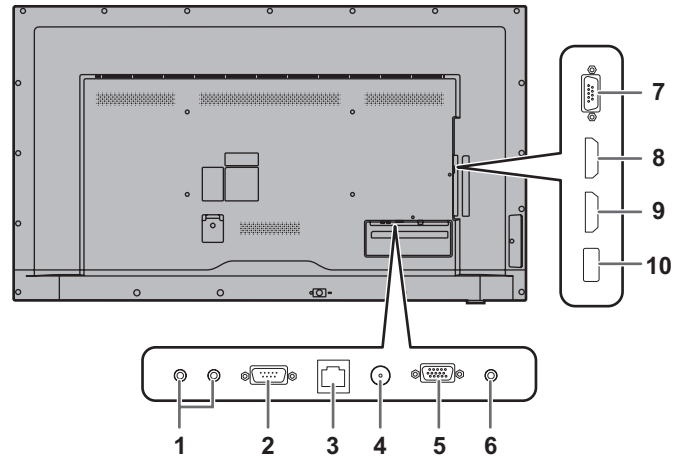

! Caution

- Be sure to turn off the power and disconnect the plug from the power outlet before connecting/disconnecting cables. Also, read the manual of the equipment to be connected.
- Be careful not to confuse the input terminal with the output terminal when connecting cables. Accidentally reversing cables connected to the input and output terminals may cause malfunctions and the other problems.
- Do not use any cable that has a damaged or deformed terminal. Using such cables may cause malfunctions.

TIPS

- Images may not be displayed properly depending on the computer (video card) to be connected.
- Use the automatic screen adjustment when a computer screen is displayed for the first time using D-SUB or when the setting of the computer is changed.
- If the audio output from the playback device is connected directly to speakers or other devices, the video on the monitor may appear delayed from the audio portion. Audio should be played through this monitor by connecting the playback device to the monitor's audio input, and connecting the monitor's audio output to the speakers or other devices.
- The audio input terminals used in each input mode are as follows.

Input mode	Audio input terminal
TV	Antenna terminal
HDMI1	HDMI1 input terminal
HDMI2	HDMI2 input terminal
D-SUB	Audio input terminal
USB	USB port

1. Audio output terminal

- The output sound varies depending on the input mode.

2. RS-232C input terminal

- You can control the monitor from a computer by connecting a commercially available RS-232 straight cable between this terminal and the computer.

3. LAN terminal

- You can control the monitor from a computer on a network by connecting a commercially available LAN cable between this terminal and a network.

4. Antenna terminal

5. D-sub input terminal

6. Audio input terminal

- Use an audio cable without resistance.

7. IR output terminal

- You can operate connected external connection equipment through this monitor. Point the remote control of the external connection equipment toward the remote control sensor on this monitor.

8. HDMI1 input terminal

9. HDMI2 input terminal

- Use a commercially available HDMI cable (conforming to the HDMI standard) that supports 4K.
- When HDMI is selected, it is not necessary to connect an audio cable to the audio input terminal.

10. USB port

- Connect a USB flash drive to the USB port.
- Do not connect a USB device other than a USB flash drive.
- Turn off the power of the monitor when removing a USB flash drive.

Supported USB flash drives

File System	FAT16/32
Capacity	Up to 32 GB (maximum file size 4 GB)

- Do not use a USB flash drive with a security function or a write protection function.
- Use a USB flash drive with a shape that can be inserted in the USB port. Some USB flash drives with special shapes cannot be inserted. Do not forcibly insert a USB flash drive. This may damage the connector and cause failure.

Connecting the Power Cord

! Caution

- Use only the power cord supplied with the monitor.
- When all connections are complete, connect the power cord.

1. Plug the power cord (supplied) into the AC input terminal.
2. Plug the power cord (supplied) into the power outlet.

[PN-UH861]

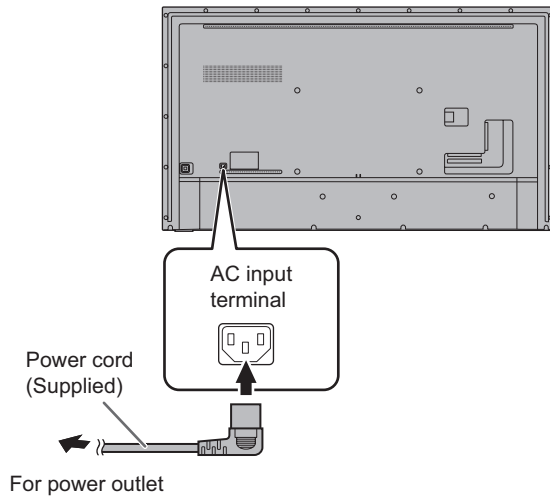

[PN-UH551/PN-UH501/PN-UH431]

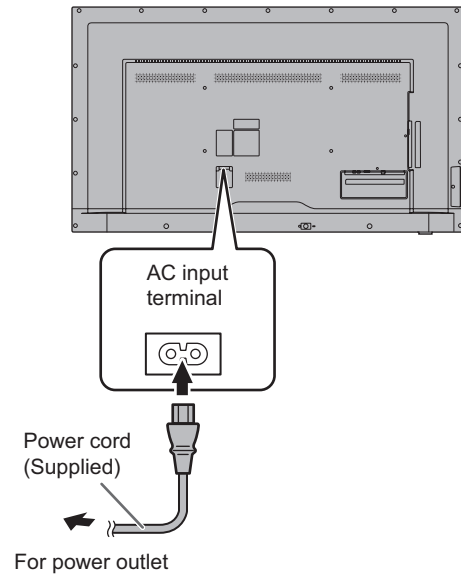

Binding Cables

The supplied cable clamps (affixing type) can be used to clamp the power cord and cables connected to the back of the monitor.

! Caution

- Attach the supplied cable clamps to a flat surface. Do not attach over a vent.
- Remove any dust or dirt before attaching.

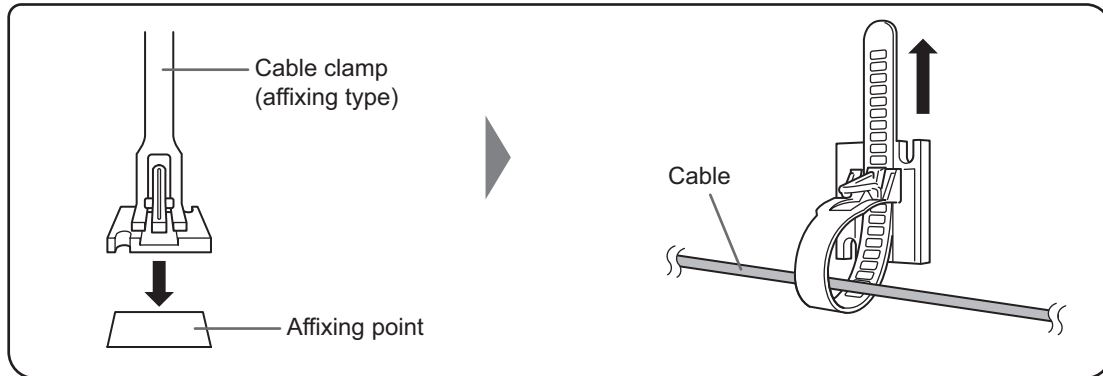

Attaching the logo sticker

You can attach the supplied logo sticker on this monitor.
Refer to the following example to attach the sticker as necessary.

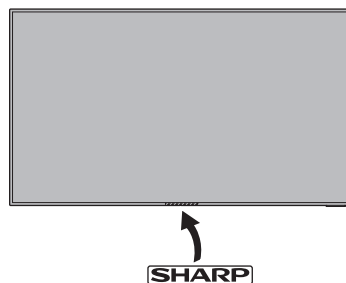

Preparing the Remote Control Unit

Installing the batteries

1. Press the cover gently and slide it in the direction of the arrow.

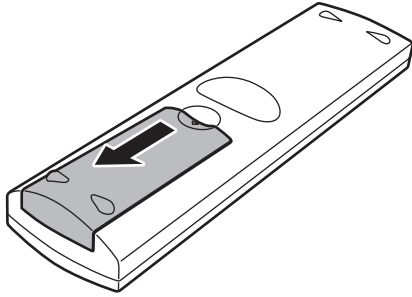

2. See the instructions in the compartment and put in the supplied batteries (LR03 ("AAA" size) x 2) with their plus (+) and minus (-) sides oriented correctly.
3. Close the cover.

TIPS

- When the batteries become exhausted, replace them with new (commercially available) batteries.
- The supplied batteries may become exhausted quickly depending on how they are stored.
- If you will not be using the remote control for a long time, remove the batteries.
- Use manganese or alkaline batteries only.

Remote control operation range

The operation range of the remote control unit is approx. 16.4 feet (5 m) at an angle of approx 10° from the center to the top/bottom/right/left of the remote control sensor.

[PN-UH861]

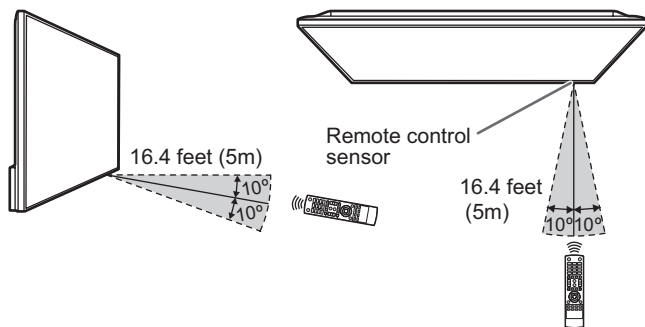

[PN-UH551/PN-UH501/PN-UH431]

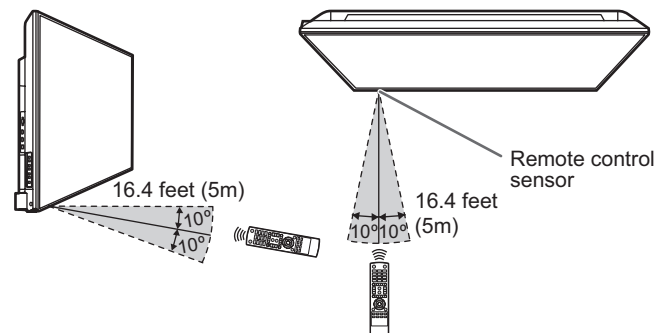

TIPS

- Do not expose the remote control unit to shock by dropping or stepping on it. This could lead to a malfunction.
- Do not expose the remote control unit to liquids, and do not place it in an area with high humidity.
- The remote control unit may not work properly if the remote control sensor is under direct sunlight or strong lighting.
- Objects between the remote control unit and the remote control sensor may prevent proper operation.
- Replace the batteries when they run low as this may shorten the remote control's operation range.
- If a fluorescent light is illuminated near the remote control unit, it may interfere with proper operation.
- Do not use it with the remote control of other equipment such as air conditioner, stereo components, etc.

Turning Power On/Off

! Caution

- Turn on the monitor first before turning on the computer or playback device.
- Even when the power is turned off with the POWER button on the monitor, a minute amount of power is consumed if the power cord is connected.
- When turning the power off and back on, always wait for at least 5 seconds. A short interval may result in a malfunction.
- For a complete electrical disconnection, pull out the main plug.

Turning power on/off

1. Press the POWER button on this monitor to turn on the power.

The power LED lights green.

[PN-UH861]

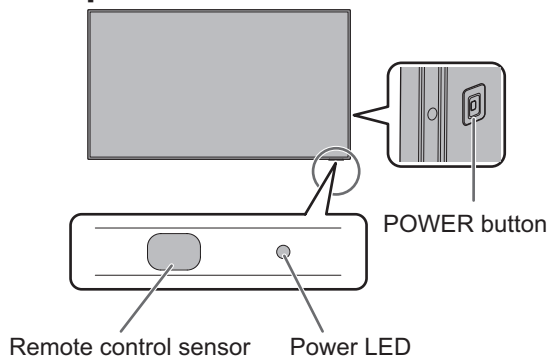

[PN-UH551/PN-UH501/PN-UH431]

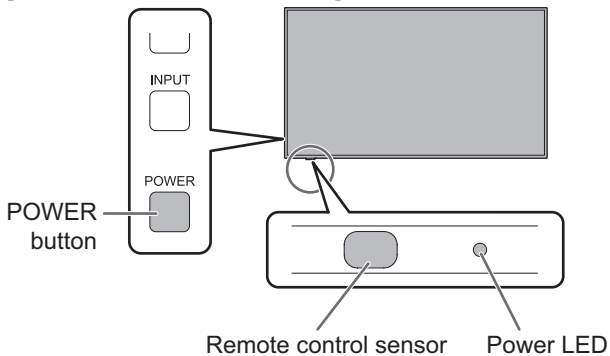

2. Turn the power on and off with the POWER button on the remote control unit.

Point the remote control unit toward the remote control sensor on this monitor, and press the POWER button.

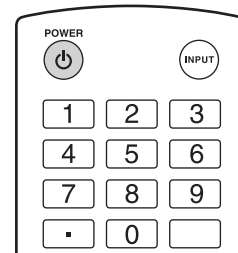

■ Power save mode

When the monitor is turned on for the first time after being shipped from the factory, the power save mode setting screen will be displayed. Set it to "YES" or "NO".

YES ... "Power save mode" is set to "On". Current consumption is reduced while the monitor is in standby mode. Note, however, that the startup time from standby mode becomes longer.

NO "Power save mode" is set to "Off". Startup time from standby mode is reduced. Note, however, that more power will be consumed in standby mode.

Even after being set, you can change the "Power save mode". (See page 25.)

Status	Status of the monitor
Green lit	Power on
Red lit	Standby mode

Basic Operation

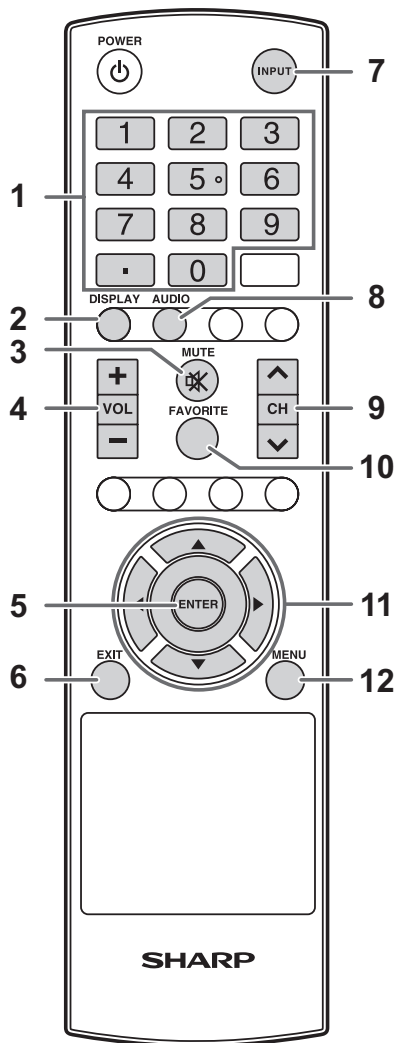

1. Numeric input buttons

Manually enter a channel.
You can also use the button when you enter numeric or dot.

2. DISPLAY

Displays information of displayed channel or monitor.

3. MUTE

Turns off the volume temporarily.
Press the MUTE button again to turn the sound back to the previous level.

4. VOL +/- (Volume adjustment)

Press + or - to adjust the volume.

5. ENTER

Confirms the setting.
Press the ENTER button while watching TV to display the channel list.

6. EXIT

Turns off the menu screen.

7. INPUT (Input mode selection)

The menu is displayed. Press the ▲ or ▼ button to select the input mode, and press the ENTER button to enter.

* You can change the input mode by pressing the INPUT button of the monitor. (PN-UH551/PN-UH501/PN-UH431)

Input mode	Video	Audio
TV	Antenna terminal	Antenna terminal
HDMI1	HDMI1 input terminal	HDMI1 input terminal
HDMI2	HDMI2 input terminal	HDMI2 input terminal
D-SUB	D-sub input terminal	Audio input terminal
USB	USB port	USB port

8. AUDIO

Change MTS or audio language.

9. CH ▲/▼

Changes channel.

10. FAVORITE

Displays registered favorite channel list.
This is used in Media Player. (See page 20.)

11. Cursor

These buttons are used to perform operations such as selecting items, changing adjustment values, and moving the cursor.

12. MENU

Displays the menu screen. Returns to previous screen while the menu items are being displayed. (See page 22.)

TIPS

- Buttons other than the above are not used with this monitor.

■Switching the screen size

You can switch the screen size in “Wide mode” of “Advanced” on the “Picture” menu. (See page 23.)

Even when the screen size is changed, the display may remain the same depending on the input signal.

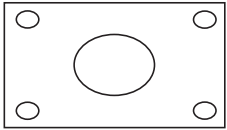
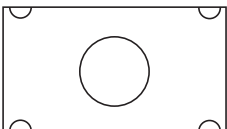
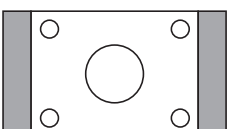
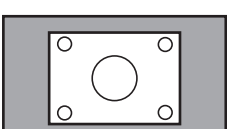
Wide		Displays image so it fills the entire screen.
Zoom		The image is enlarged to fill the entire screen without changing the aspect ratio. The edges of the image may be cut off.
Normal		Displays the image so it fills the screen without changing the aspect ratio.
Dot by Dot		Displays the dots of the input signals as the corresponding dots on the screen.

TIPS

- Using this monitor's screen-size switching function to compress or expand the screen for commercial or public viewing in establishments like cafes or hotels may infringe on the rights of the creators, as protected by Copyright Law, so please be careful.
- The appearance of the original video may change if you select a screen size with a different aspect ratio than the original image (e.g. TV broadcast or video input from external equipment).
- When 4:3 video is viewed with the whole screen using the screen-size switching function of this monitor, the edge of the video may be lost or appear distorted. If you wish to respect the creator's intentions, set the screen size to “Normal”.
- When playing commercial software, parts of the image (like subtitles) may be cropped. In this case select the optimal screen size using the screen-size switching function of this monitor. With some software, there may be noise or distortion at the edges of the screen. This is due to the characteristics of the software, and is not a malfunction.
- Depending on the original video size, black bands may remain at the edges of the screen.

Using Media Player

You can play photo, music, and video files in a USB flash drive connected to the monitor. There are the way to play the specified files/folders and the way to play as auto playback. You can also play Music file during Photo file display. For information on USB flash drive, see page 13.

■ Supported formats

The types of files that can be played are as follows. The operation of formats not indicated in the table is not guaranteed.

Photo files

Extension	Max. resolution
.jpg (.jpeg)	15360 x 8640

- Progressive JPEG files are not supported.

Music files

Extension	Audio codec
*.mp3	MPEG-1 L2/L3, MPEG-2 L3

Video files

Video files up to Full HD can be played.

Extension	Video codec	Audio codec
*.ts	MPEG2/H.264	AAC, AC-3, MP3, LPCM
*.mp4	H.264 MP/HP@L4	AAC, AC-3, MP3

- Both video codec and audio codec need to be supported.
- Video files up to 1080p 30 Hz can be played.
- In some cases it may not be possible to play the above files.
- A maximum of 32 alphanumeric characters can be used for folder name and file name.
- Do not use a file that is over 4 GB.

Playing files

TIPS

- Files are displayed/played according to the order you copy them to a USB flash drive. Copy files to a USB flash drive according to the order you want to play.
- You can have photo or video files play automatically when a USB flash drive is connected or the power is turned on. (See page 21.)

■ Select the type of file to be played

1. Insert the USB flash drive into the monitor. (See page 13.)
2. Change an input mode to [USB]. (See page 18.)
3. Select the type of file to be played with the ◀ or ▶ button, and press the ENTER button.

■ Playing files

1. Displays the file to be played.
Select the folder with the ◀, ▶, ▲ or ▼ button and press the ENTER button to show the files in the folder.
2. Select the file you want to play, and press the ENTER button.
The file is selected.
Multiple files can be selected. You can also select files in different folders.
3. Press the FAVORITE button.
The selected files are played.

TIPS

- The played screen size is "Normal".
- If you press the FAVORITE button without selecting a file, all the files in the folder will be played.
- Select "Return" folder to return to the root folder, select "Up Folder" folder to return to the next higher folder.
- The volume can be adjusted with the VOL button and MUTE button on the remote control.
- For operations during play, see page 21.

■ To stop play

1. Press the EXIT button.

Auto playback

Photos or video in a USB flash drive can be played automatically.

■ Preparations

Prepare the files. Name the file to be played "001-030" such as "001.jpg" - "030.jpg".

1. Create a folder named "autoplay" in the root folder of a USB flash drive and copy the files to be automatically played to the folder.

Select the type of file.

1. Change an input mode to other than [USB]. (See page 18.)
2. Press the MENU button, and select "Setup" with the ◀ or ▶ button, select "Auto Play" with the ▲ or ▼ button and press the ENTER button.
3. Select the type of file with the ▲ or ▼ button and press the ENTER button.

■ Auto playback of files

Connect a USB flash drive (see page 13) and turn on the monitor power.

Auto play starts.

You can connect a USB flash drive (see page 13) after turning on the monitor power.

Auto play starts.

TIPS

- Photos and video cannot be played automatically at the same time.
- Auto play repeatedly plays all photo or video files in the "autoplay" folder.

■ To stop auto play

1. Press the EXIT button.

Operations during play

When playing is started, the operation bar is displayed in the bottom of the screen and you can perform the steps below. If the operation bar is not displayed, press the MENU button to display it.

PLAY / PAUSE	Play the current file./ Pause the playing file.
FB	Fast backward playing the file. (Audio and Video only)
FF	Fast forward playing the file. (Audio and Video only)
Previous	Go to the previous file.
Next	Go to the next file.
STOP	Stop the playing file.
Repeat none / Repeat 1 / Repeat all	Repeat none: Play files in the playlist only once. Repeat 1: Play and repeat the current file. Repeat all: Play and Repeat files in the playlist.
Set A / Set B / None	Play and repeat set interval. SetA: Set the interval of the start point. SetB: Set the interval of the end point. (Audio and Video only)
Random On / Random Off	Random On: Play and repeat files of the playlist in random. Random Off: Play files of the playlist in order.
Music On / Music Off	Setting to "Music On", the photo and music files in the same folder are played at the same time. (Photo only)
Interval	Select Slideshow time. (Photo only)
Playlist	Show Playlist.
Info.	Show Playing file information.
Rotate (Clockwise)	Rotate the current file 90 degrees clockwise temporarily. (Photo only)
Rotate (Anti-Clockwise)	Rotate the current file 90 degrees Anti- clockwise temporarily. (Photo only)
Zoom in	The file zooms in. (Photo only)
Zoom out	The file zooms out. (Photo only)
Move	Select view area in zoomed. (Photo only)
Dynamic / PC / Standard / Movie / Game	Select video settings. (Video only)

Menu Items

Displaying the menu screen

Video adjustment and settings of various functions are enabled. This section describes how to use the menu items. See page 23 for details of each menu items.

! Caution

- Do not turn off the power while the menu items are being displayed. Doing so may initialize the settings.
- This cannot be displayed when the input mode is [USB]. Change an input mode to other than [USB] before performing these operations.

■ Example of operation

(Adjusting “Contrast” in the “Picture” menu)

1. Press the **MENU** button to display the menu screen.

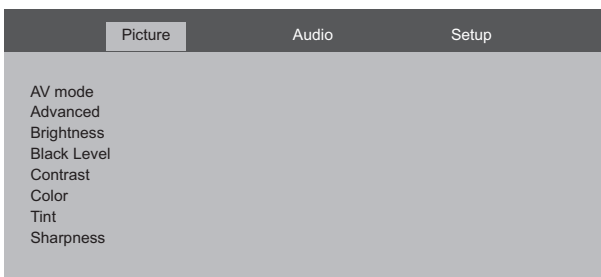

2. Press the ◀ or ▶ button to select “Picture”.

3. Press the ▲ or ▼ button to select “Contrast”.



4. Press the **ENTER** button, and press the ◀ or ▶ button to adjust the setting.

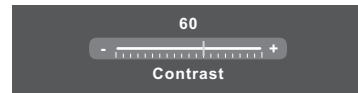

5. Press the **ENTER** button.

6. Press the **EXIT** button to close the menu screen.

TIPS

- The menu will differ depending on the input mode.

■ Menu screen display

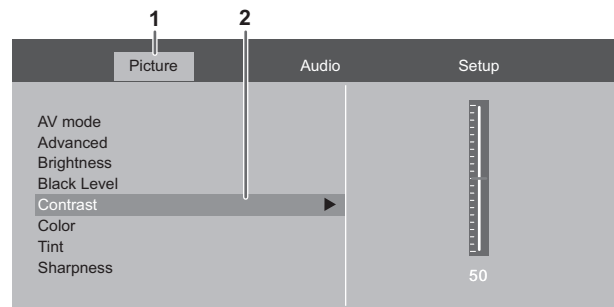

1 Name of the menu

2 An item being selected (highlighted)

TIPS

- Items that cannot be selected appear in gray.

Menu item details

The menu will differ depending on the input mode.

■Picture

AV mode

Video settings can be changed to match the scene.

Dynamic / PC / Standard / Movie / Game / Custom

* Once you change the setting such as "Color Temp." or "Brightness" from "Dynamic" / "PC" / "Standard" / "Movie" / "Game", "AV mode" will be changed to "Custom". If you change "Custom" to another "AV mode", the value of "Custom" will not be maintained.

Advanced

Wide mode

Changes the screen size. (See page 19.)

Overscan

Sets the scan mode used for video input.

Color Temp.

Selects the color temperature.

Noise reduction

Reduce the image noise.

Setting a higher level reduces more noise. However, it may cause blurring on an image.

Active Contrast

Automatically adjusts the contrast according to the image.

The adjustment operation may not be smooth depending on the image. In this case select "Off".

Motion enhancement (PN-UH861)

Use this when showing a picture with fast movement.

Brightness

Adjusts the backlight brightness.

Black Level

Adjusts the entire brightness of the video signals.

Contrast

Adjusts the difference between the bright and dark portions of the image.

Color

Adjusts the color intensity.

Tint

Adjusts the hue. Selecting + changes the color towards green, and selecting - changes it towards magenta.

Sharpness

Adjusts the sharpness of the image.

■Audio

Balance

Adjusts the balance of the audio sound between right and left.

Bass

Adjusts the volume of bass-level sound.

Treble

Adjusts the volume of treble-level sound.

Speaker

Select whether or not speakers are used.

Surround

You can produce surround effect from the speakers.

Audio output

Sets the volume of sound output from the audio output terminals.

Variable..... You can adjust the volume using the VOL button.

Fixed..... Fixes the sounds.

Menu Items

■TV

CH search

Channel auto search makes this monitor look for all channels viewable in the set area.

CH memory

You can select the channels to skip.

Favorite CH

This function allows you to program favorite channels. By setting the favorite channels in advance, you can select your favorite channels easily.

MTS/SAP

Select monitor's audio type. You can select "Mono", "Stereo" or "SAP".

Audio language

Select monitor's primary audio language. You can select "English", "Español" or "Français".

■Setup

Language

Sets the display language for the menu screen.

Communication setting

RS-232C/LAN select

Selects the method with which to control the monitor from the computer.

LAN setup

Configures the settings to control the monitor from the computer via LAN. (See page 32.)

Parental control (See page 26.)

Set whether or not to filter programs not suitable for children's viewing.

Closed caption

Set whether to display closed caption and make various settings.

HDMI CEC Link

On..... Use the HDMI CEC function.

If the device connected to the HDMI input terminal supports CEC, the input mode of the monitor changes to HDMI when playback starts on the device.

Off..... HDMI CEC function is not used.

HDMI Modes

HDMI modes settings change how the content displayed is processed and decoded.

"Mode1" is default and will support most common color spaces and other encoding signals.

"Mode2" should be used for YCbCr 4:2:0 at 4K Vsync 50/60 Hz signals or when non 4K devices are connected and content onscreen are not what is expected.

Screen**Auto (D-SUB)**

The "Clock", "Phase", "H-Pos.", and "V-Pos." are automatically adjusted.

Pressing the ENTER button performs adjustment. Use this automatic adjustment when you use the D-SUB to display a computer screen for the first time or when you change the setting of the computer. (See page 28.)

H-Pos. (D-SUB)

Adjust the horizontal position of the image.

V-Pos. (D-SUB)

Adjust the vertical position of the image.

Clock (D-SUB)

Adjusts frequency for sampling clock for applicable video.

Adjust when there is flickering in the form of vertical stripes.

When using the adjustment pattern (see page 28), make adjustments so that no vertical stripe noise appears in it.

Phase (D-SUB)

Adjusts sampling clock phase for applicable video. Useful when small characters appear with low contrast and/or there are flickers at corners. When using the adjustment pattern (see page 28), make adjustments so that no horizontal stripe noise appears in it.

* Adjustments to "Phase" should be made only after "Clock" has been correctly set.

Reset

Resets the values of the "Screen" items to the factory default settings.

Select "Yes" and then press the ENTER button.

No signal off

Sets whether or not the monitor power off when there is no input signal for more than 10 minutes.

Power save mode

When "Off" is selected, startup time from standby mode is reduced. Note, however, that more power will be consumed in standby mode.

When "On" is selected, current consumption is reduced while the monitor is in standby mode. Note, however, that the startup time from standby mode becomes longer.

If set to "On", certain RS-232C commands and LAN control cannot be used in standby mode. (See pages 29 and 32.)

Monitor button lock

You can disable all monitor buttons.

To disable "Monitor button lock", press the DISPLAY button until "F" appears in the upper left corner of the screen. Then, press the ▲, ▼, ◀ and ▶ buttons in this sequence before "F" disappears.

RC control lock

You can disable the remote control buttons.

To disable "RC control lock", press the DISPLAY button until "F" appears in the upper left corner of the screen. Then, press the ▲, ▼, ◀ and ▶ buttons in this sequence before "F" disappears. You can also disable "RC control lock" by disconnecting the power cord from the power outlet, and then reconnecting the power cord to the power outlet while pressing the POWER button on the monitor. Use this method to disable when auto play has been set in Media Player.

Front Indicator Light

Specifies whether to light the power LED.

Auto Play (See page 21.)

Set the type of file to be automatically played from a USB flash drive.

Information

Displays monitor information.

All reset

Resets all the settings to the factory default settings.

Menu Items

■Parental control

You can set whether or not to filter programs not suitable for children's viewing. Secret No. (see the description below) must be entered.

Setting parental control

1. Press the ▲ or ▼ button to adjust the item to your desired position.

No rating

Block programs without rating.

US (See the description right.)

MPAA: You can set parental control on movie ratings.
 TV Guidelines: You can set parental control on TV Parental Guidelines.
 * Voluntary movie rating system only uses an age-based rating.

Canada (See page 27.)

Can.English Ratings: You can set parental control on Canadian English Ratings.

Can.French Ratings: You can set parental control on Canadian French Ratings.

RRT5

Sets the RRT5 (Rating Region Table 5) setting.

Reset RRT5

Resets the RRT5 setting.

Setting Secret No.

Allows you to use a secret number to protect certain settings from being accidentally changed. "0000" is set as the default value.

Reset

Resets the parental control setting.

US

- The U.S. has two rating systems for viewing content: TV Parental Guidelines and movie ratings.
- The TV Parental Guidelines work in conjunction with the V-CHIP to help parents screen out inappropriate television shows from their children.
- Movie ratings are used for original movies rated by the Motion Picture Association of America (MPAA) as watched on cable TV and not edited for television. The V-CHIP can also be set to block MPAA-rated movies.

MPAA (Voluntary movie rating system)

None	Do not set parental controls.
G	General audiences. All ages admitted.
PG	Parental guidance suggested. Some material may not be suitable for children.
PG-13	Parents strongly cautioned. Some material may be inappropriate for children under 13.
R	Restricted. Under 17 requires accompanying parent or adult guardian (age varies in some jurisdictions).
NC-17	No one 17 and under admitted.
X	X is an older rating that is unified with NC-17 but may be encoded in the data of older movies.

TV Guidelines

(1) Suggested age

None	Do not set parental controls.
TV-Y	All children.
TV-Y7	Directed to older children.
TV-G	General audience.
TV-PG	Parental Guidance suggested.
TV-14	Parents strongly cautioned.
TV-MA	Mature audience only.

(2) Content

All	All contents.
FV	Fantasy violence.
L	Adult language.
S	Sexual situation.
V	Violence.
D	Sexually suggestive dialog.

Rating		Content					
		All	FV	L	S	V	D
Suggested age	TV-Y	Yes	No	No	No	No	No
	TV-Y7	Yes	Yes	No	No	No	No
	TV-G	Yes	No	No	No	No	No
	TV-PG	Yes	No	Yes	Yes	Yes	Yes
	TV-14	Yes	No	Yes	Yes	Yes	Yes
	TV-MA	Yes	No	Yes	Yes	Yes	No

Canada

- The TV rating systems in Canada are based on the Canadian Radio-Television and Telecommunications Commission (CRTC) policy on violence in television programming.
- While violence is the most important content element to be rated, the structure developed takes into consideration other program content like language, nudity, sexuality and mature themes.
- When setting the V-CHIP on the Canadian system you can choose either the Canadian English ratings or the Canadian French ratings.

Can.English Ratings

E (Exempt)	Includes news, sports, documentaries and other information programming; talk shows, music videos, and variety programming.
C (Children)	Intended for younger children under the age of 8 years. Pays careful attention to themes that could threaten their sense of security and well-being.
C8+ (Children over 8 years old)	Contains no portrayal of violence as the preferred, acceptable, or only way to resolve conflict; nor encourage children to imitate dangerous acts which they may see on the screen.
G (General)	Considered acceptable for all age groups. Appropriate viewing for the entire family, contains very little violence, physical, verbal or emotional.
PG (Parental Guidance)	Intended for a general audience, but may not be suitable for younger children (under the age of 8) because it could contain controversial themes or issues.
14+ (Over 14 years)	Could contain themes where violence is one of the dominant elements of the storyline, but it must be integral to the development of plot or character. Language usage could be profane and nudity present within the context of the theme.
18+ (Adults)	Intended for viewers 18 years and older and might contain depictions of violence, which while related to the development of plot, character or themes, are intended for adult viewing. Could contain graphic language and portrayals of sex and nudity.

Can.French Ratings

E (Exempt)	Exempt programming.
G (General)	All ages and children, contains minimal direct violence, but may be integrated into the plot in a humorous or unrealistic manner.
8ans+ (General but inadvisable for young children)	May be viewed by a wide public audience, but could contain scenes disturbing to children under 8 who cannot distinguish between imaginary and real situations. Recommended for viewing with parent.
13ans+ (Over 13 years)	Could contain scenes of frequent violent scenes and therefore recommended for viewing with parent.
16ans+ (Over 16 years)	Could contain frequent violent scenes and intense violence.
18ans+ (Over 18 years)	Only for adult viewing. Could contain frequent violent scenes and extreme violence.

Adjustments for computer screen display

■ Automatic adjustment

When you use the D-SUB to display a computer screen for the first time, or when you change the setting of the computer, use the automatic screen adjustment.

1. **Switch the input to D-SUB and display the adjustment pattern.** (See the description below.)
2. **Press the MENU button and use the ◀ or ▶ button to display the “Setup” menu.**
3. **Select “Auto” on the “Screen” menu.**
4. **Press the ENTER button.**
The automatic adjustment is complete in several seconds.
5. **Press the EXIT button to close the menu screen.**

TIPS

- If the screen cannot be adjusted properly with one automatic adjustment, repeat the automatic adjustment two or three times. Try manual adjustment if necessary.

■ Screen display for adjustment

Before making adjustments in the “Setup” menu or “Picture” menu, display an image to brighten the entire screen. If you are using a Windows computer, use the adjustment pattern on the supplied CD-ROM.

Opening the adjustment pattern

The following example is performed in Windows 7.

1. **Load the supplied CD-ROM into the computer’s CD-ROM drive.**
2. **Open [CD Drive] in [Computer].**
3. **Double-click [Adj_uty.exe].**

The adjustment pattern will appear.

Adjust the screen automatically or manually.

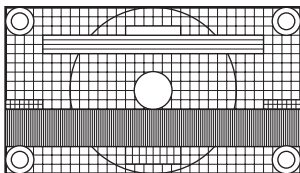

4. **When adjustment is finished, press the [Esc] on the computer’s keyboard to quit the adjustment program.**
5. **Eject the CD-ROM from the CD-ROM drive.**

TIPS

- If the display mode on the computer you are using is 65000 colors, the color levels in the color pattern may appear differently or grayscale may appear to be colored. (This is due to the specifications of the input signal and is not a malfunction.)

Controlling the Monitor with a computer (RS-232C)

You can control this monitor from a computer via RS-232C (COM port) on the computer.

TIPS

- To control the monitor via RS-232C, set "RS-232C/LAN select" to "RS-232C".
- You cannot use RS-232C and LAN control simultaneously.

Computer connection

Connect with RS-232 straight cable between the computer's COM port (RS-232C connector) and the RS-232C input terminal on the monitor.

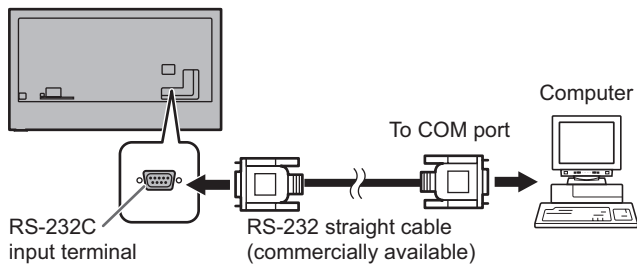

Communication conditions

Set the RS-232C communication settings on the computer to match the monitor's communication settings as follows:

Baud rate	9600bps	Stop bit	1 bit
Data length	8 bits	Flow control	None
Parity bit	None		

Communication procedure

Command format

When a command is sent from the computer to the monitor, the monitor operates according to the received command and sends a response message to the computer.

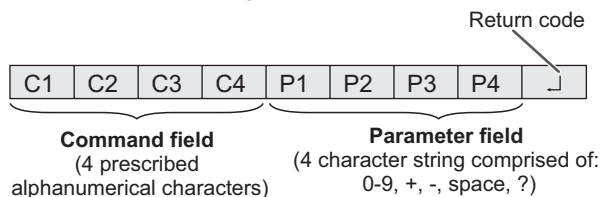

Example: VOLM0030
VOLM _ _ 30

- * Be sure to input 4 characters for the parameter. Pad with spaces (" ") if necessary.
(" " is a return code (0DH, 0AH or 0Dh))
Wrong : VOLM30
Right : VOLM _ _ 30

The current value can be returned by using "?" as the parameter.

Example:

VOLM ? ? ? ? ← From computer to monitor (How much is current volume setting?).
30 ← From monitor to computer (Current volume setting: 30).

Response code format

When a command has been executed correctly

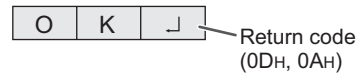

A response is returned after a command is executed.

When a command has not been executed



TIPS

- "ERR" is returned when there is no relevant command or when the command cannot be used in the current state of the monitor.
- If communication has not been established for reasons such as a bad connection between the computer and monitor, nothing is returned (not even ERR).
- "ERR" may be returned when a command cannot be received correctly due to interference from the surrounding environment. Please ensure that the system or software resends the command if this occurs.

Communication interval

- After OK or ERR is returned, you must send the following commands.
To set a timeout for the command response, specify 10 seconds or longer.
- Provide an interval of 100 ms or more between the command response and the transmission of the next command.

Controlling the Monitor with a computer (RS-232C)

RS-232C command table

How to read the command table

- Command: Command field (See page 29.)
- Direction: W When the "Parameter" is set in the parameter field (see page 29), the command functions as described under "Control/Response Contents".
R The returned value indicated under "Reply" can be obtained by setting "????", "____?" or "???" (repeater control) in the parameter field. (See page 29.)
- Parameter: Parameter field (See page 29.)
- Reply: Response (Returned value)
- * : "o" : Indicates a command which can be used in standby mode or when the power is on.
"–" : Indicates a command which can be used when the power is on. Cannot be used in standby mode.

Power control/Input mode selection

Function	Command	Direction	Parameter	Reply	Control/Response contents	*
Power control	POWR	W	0		Switches to standby mode.	o
			1		Returns from standby mode.	
Input mode selection	INPS	W	0		Toggle change for input mode.	-
			2		D-SUB	
			10		HDMI1	
			11		USB	
			13		HDMI2	
			25		TV	

"Picture" menu

Function	Command	Direction	Parameter	Reply	Control/Response contents	*
Brightness	VLMP	WR	0-50	0-50		
Wide mode (Screen size selection)	WIDE	WR	1-4	1-4	1: Wide, 2: Normal, 3: Dot by Dot, 4: Zoom	
AV mode	BMOD	WR	0	0	Standard	-
			2	2	Dynamic	
			5	5	PC	
			6	6	Movie	
			7	7	Game	
8	8	Custom				
User name	USER	WR	XXXXXXXX	XXXXXXXX	8 characters or less; half-width alphanumeric characters, "-", and "_". (The field can be left blank, but spaces cannot be entered.)	
Password	PASS	WR	XXXXXXXX	XXXXXXXX	8 characters or less; half-width alphanumeric characters, "-", and "_". (The field can be left blank, but spaces cannot be entered.)	
Model	INF1	R		Value		
Serial no.	SRNO	R		Value		

Controlling the Monitor with a computer (RS-232C)

TV menu

Function	Command	Direction	Parameter	Reply	Control/Response contents	*
Channel up	CHUP	W	0		Up the channel number of TV by 1.	
Channel down	CHDW	W	0		Down the channel number of TV by 1.	
Direct channel (Analog)	ATDC	W	XXXX	XXXX	Enter channel number of analog TV directry. X: Setting of antenna type 0 : Air, 1 : Cable YYY: Channel number Air : 002 - 069, Cable : 001 - 135 If it is not TV, input mode is changed to TV.	
Direct channel (Digital)	DTDC	W	YYYYYYZZZ	YYYYYYZZZ	Enter channel number of digital TV directry. X: Setting of antenna type 0 : Air, 1: Cable YYYYY: Major number or One part channel number Air : 00001 - 65535, Cable : 00000 - 65535 ZZZZ: Minor number Air : 0001 - 9999, Cable : 0001 - 9999 (If use one part channel number, it is 0000.) If it is not TV, input mode is changed to TV.	-
Audio selection	ACHA	W	0		Toggle change for audio.	

Others

Function	Command	Direction	Parameter	Reply	Control/Response contents	*
Volume	VOLM	WR	0-100	0-100		-
Mute audio	MUTE	WR	0-1	0-1	0: Off, 1: On	
Temperature sensor	DSTA	R	0		Internal temperature normal	○
			1		Internal temperature abnormal has occurred and the monitor is in standby mode	
			2		Internal temperature abnormal occurred (To delete the information of temperature abnormal, turn off the power.)	
			3		Internal temperature abnormal has occurred	
			4		Temperature sensor abnormal	
Temperature acquisition	ERRT	R		Value	Returns the temperature at the temperature sensors. Indicates a temperature sensor abnormality when "126" is returned.	-

Controlling the Monitor with a computer (LAN)

Your monitor can be connected to a LAN allowing you to control it from a computer on the LAN. The connection requires a commercially available LAN cable (UTP cable, Category 5, straight through).

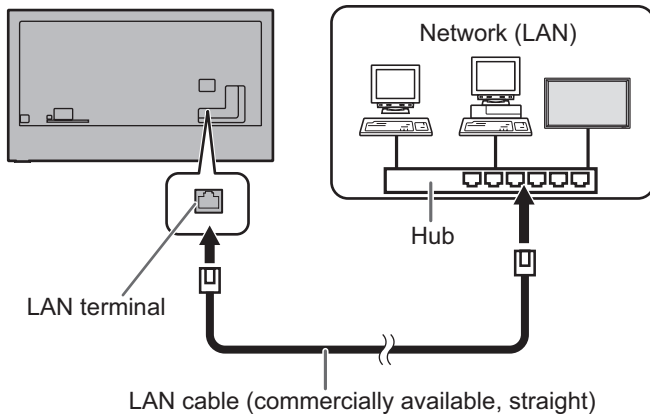

TIPS

- When “Power save mode” is set to “On”, the control is disabled in the standby mode.
- To control the monitor via LAN, set “RS-232C/LAN select” to “LAN”. (See page 24.)
- You cannot use RS-232C and LAN control simultaneously.

Settings to connect to a LAN

Set the monitor’s IP address and subnet mask to match the settings of your LAN.

These settings can be made on either the monitor or a computer connected to the monitor.

The settings depend on the configuration of your LAN. Ask your LAN administrator for details.

■ To set on the monitor

Set “RS-232C/LAN select” of “Communication setting” on the “Setup” menu to “LAN”, and then set the “LAN setup” options. (See page 24.)

After setting each item, select “Set” and press the ENTER button.

Network Information

Displays LAN setting information.

DHCP

If your LAN has a DHCP server and you wish to obtain an address automatically, change this setting to “Use”. To set the address manually, set this to “No Use”.

IP address

If the “DHCP” is set to “No Use”, specify an IP address. Press the ◀ or ▶ button to select the items, and enter the values with the numeric input buttons (0 to 9). You can also change the values with the ▲ or ▼ button.

Subnet mask

If the “DHCP” is set to “No Use”, specify the subnet mask. Press the ◀ or ▶ button to select the items, and enter the values with the numeric input buttons (0 to 9). You can also change the values with the ▲ or ▼ button.

Gateway

If the “DHCP” is set to “No Use”, specify the default gateway. If you are not using a default gateway, specify “000.000.000.000”.

Press the ◀ or ▶ button to select the items, and enter the values with the numeric input buttons (0 to 9).

You can also change the values with the ▲ or ▼ button.

Set

Save the setting.

Command-based control

You can control the monitor using RS-232C commands (see page 30) via terminal software and other appropriate applications.

Read the manual for the terminal software for detailed instructions.

(1) Connect the computer to the monitor.

1. Specify the IP address and data port number (10008) and connect the computer to the monitor.

When connection has been established successfully, [Login:] is returned as response.

2. Send the user name.

- Send [user name] + [□].

- If the user name is not set, send [□].

- When the transmission is successful, [□ Password:] is returned as response.

3. Send the password.

- Send [password] + [□].

- If the password is not set, send [□].

- When the transmission is successful, [OK □] is returned as response.

(2) Send commands to control the monitor.

- The commands used are the same as those for RS-232C. Refer to the communication procedure (see page 29) for operation.

- Usable commands are provided in the RS-232C command table (see page 30).

(3) Disconnect the connection with the monitor and quit the function.

1. Send [BYE □].

When the transmission is successful, [goodbye] is returned and the connection is disconnected.

Troubleshooting

If you are experiencing any problem with your display, before calling for service, please review the following troubleshooting tips.

There is no picture or sound.

- The power LED is off.
 - Is power supplied to this monitor?
 - Is the power cord disconnected? (See page 14.)

Remote control does not work.

- Are the batteries inserted with polarity (+,-) aligned? (See page 16.)
- Are the batteries exhausted?
- Point the remote control unit toward the monitor's remote control sensor. (See page 16.)

Sound from left and right speakers is reversed.

Sound is heard from only one side.

- Are audio cables connected properly?

There is a picture but no sound.

- Is the sound muted?
- Make sure the volume is not set to minimum.
- Are audio cables connected properly?

Unstable video.

- The signal may be incompatible.
- Try the automatic screen adjustment when D-SUB is in use.

The video from the HDMI input terminal does not appear properly.

- Does the HDMI cable support 4K, and is it HDMI standard compliant? The monitor will not work with cables that are not standard compliant.
- Is the input signal compatible with this monitor? (See pages 34 and 35.)
- If the connected device does not support 4K, set "HDMI Modes" to "Mode2".

The video from D-Sub input terminal does not appear correctly.

- Is the setting for D-SUB correct?
- Is the input signal compatible with this monitor? (See page 34.)

Control buttons do not work.

There is no picture.

- Load noises from outside may be interfering with normal operation. Turn off the power and turn it on after waiting at least 5 seconds, and then check the operation.

When "AUTO DIMMING" is displayed.

- When the internal temperature of the monitor rises excessively, the brightness of the backlight automatically decreases in order to prevent a further temperature rise. If you attempt to adjust the brightness while the monitor is in this state, "AUTO DIMMING" is displayed and you cannot change the brightness.
- Remove the cause of the excessive temperature rise.

The monitor makes a cracking sound.

- You may occasionally hear a cracking sound from the monitor. This happens when the cabinet slightly expands and contracts according to change in temperature. This does not affect the monitor's performance.

The Power LED is flashing in red and green alternately.

When "TEMPERATURE" is displayed in the corner of the screen.

- When the internal temperature of the monitor rises excessively, the brightness of the backlight decreases automatically in order to prevent high-temperature-related problems. When this occurs, "TEMPERATURE" is displayed on the screen and the Power LED flashes red and green alternately.
- If the internal temperature rises further, the monitor automatically enters standby mode. (The Power LED continues flashing red and green alternately.)
- Remove the cause of the excessive temperature rise.
 - If the monitor enters standby mode due to a rise in temperature, to return to normal display, turn the power off and then back on again. The monitor, however, will enter standby mode again if the cause of the temperature rise is not eliminated. (See page 8.)
 - Check whether the monitor is placed at a location where a quick rise in temperature is likely. Internal temperature rises quickly if the vents on the monitor are blocked.
 - Internal temperature rises quickly if dust accumulates inside the monitor or around the vents. Remove dust if possible. Ask SHARP dealer about removing internal dust.

Specifications

■DDC (plug and play)

The monitor supports the VESA DDC (Display Data Channel) standard.

DDC is a signal standard for plug and play between monitors and computers. Information about resolution and other parameters is exchanged between the two. This function can be used if the computer supports DDC and it has been configured to detect plug-and-play monitors.

There are several types of DDC, depending on the communication method used. This monitor supports DDC2B.

■Compatible signal timing (PC)

Screen resolution		Hsync	Vsync	Dot frequency	Digital	Analog (D-SUB)	
					HDMI		
VESA	640 × 480	31.5kHz	60Hz	25.175MHz	Yes	Yes	
	800 × 600	37.9kHz	60Hz	40.0MHz	Yes	Yes	
	848 × 480	31.0kHz	60Hz	33.75MHz	-	Yes	
	1024 × 768	48.4kHz	60Hz	65.0MHz	Yes	Yes	
	1280 × 800	49.7kHz	60Hz	83.5MHz	Yes	Yes	
	1280 × 960	60.0kHz	60Hz	108.0MHz	Yes	Yes	
	1280 × 1024	64.0kHz	60Hz	108.0MHz	Yes	Yes	
		80.0kHz	75Hz	135.0MHz	Yes	Yes	
	1360 × 768	47.7kHz	60Hz	85.5MHz	Yes	-	
	1400 × 1050	65.3kHz	60Hz	121.75MHz	Yes	-	
	1440 × 900	55.9kHz	60Hz	106.5MHz	Yes	Yes	
1680 × 1050	65.3kHz	60Hz	146.25MHz	Yes	Yes		
Wide	3840 × 2160	54.0kHz	24Hz	297.0MHz	Yes	-	
		56.25kHz	25Hz	297.0MHz	Yes	-	
		67.5kHz	30Hz	297.0MHz	Yes	-	
		112.5kHz	50Hz	594.0MHz	Yes	-	
		135kHz	60Hz	594.0MHz	Yes	-	
	4096 × 2160	54.0kHz	24Hz	297.0MHz	Yes ^{*1}	-	
		56.0kHz	25Hz	297.0MHz	Yes ^{*1,2}	-	
		67.0kHz	30Hz	297.0MHz	Yes ^{*1,2}	-	
		112.5kHz	50Hz	594.0MHz	Yes ^{*1}	-	
		135.0kHz	60Hz	594.0MHz	Yes ^{*1}	-	
	1280 × 720	44.7kHz	60Hz	74.4MHz	Yes	Yes	
	1920 × 1080	67.5kHz	60Hz	148.5MHz	Yes	Yes	
	US TEXT	720 × 400	31.5kHz	70Hz	28.3MHz	Yes	Yes

*1 Displays a reduced image, except in "Dot by Dot". In "Dot by Dot", the image will be cut down to panel size then displayed.

*2 Compatible when "HDMI Modes" is "Mode1".

- Depending on the connected computer, images may not be displayed properly even if the compatible signal described above is input.

■Compatible signal timing (AV)

Screen resolution	Frequency	HDMI
4096 × 2160p	24Hz	Yes
	25Hz	Yes
	30Hz	Yes
	50Hz	Yes
	59.94Hz	Yes
	60Hz	Yes
3840 × 2160p	24Hz	Yes
	25Hz	Yes
	30Hz	Yes
	50Hz	Yes
	59.94Hz	Yes
	60Hz	Yes
1920 × 1080p	24Hz	Yes
	50Hz	Yes
	59.94Hz	Yes
	60Hz	Yes
1920 × 1080i	50Hz	Yes
	59.94Hz	Yes
	60Hz	Yes
1280 × 720p	50Hz	Yes
	59.94Hz	Yes
	60Hz	Yes
720 × 576p	50Hz	Yes
720 × 480p	59.94Hz	Yes
	60Hz	Yes
640 × 480p(VGA)	59.94Hz	Yes
	60Hz	Yes
720(1440) × 576i	50Hz	Yes
720(1440) × 480i	59.94Hz	Yes
	60Hz	Yes

Specifications

■HDMI input terminal pins

(HDMI Connector)

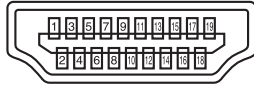

No.	Function	No.	Function
1	TMDS data 2+	11	TMDS clock shield
2	TMDS data 2 shield	12	TMDS clock-
3	TMDS data 2-	13	CEC
4	TMDS data 1+	14	N.C.
5	TMDS data 1 shield	15	SCL
6	TMDS data 1-	16	SDA
7	TMDS data 0+	17	DDC/CEC GND
8	TMDS data 0 shield	18	+5V
9	TMDS data 0-	19	Hot-plug detection
10	TMDS clock+		

■D-sub input terminal pins

(Mini D-sub 15 pin)

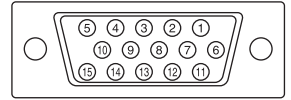

No.	Function	No.	Function
1	Red video signal input	9	+5V
2	Green video signal input	10	GND
3	Blue video signal input	11	N.C.
4	N.C.	12	DDC data
5	GND	13	Hsync signal input
6	GND for red video signal	14	Vsync signal input
7	GND for green video signal	15	DDC clock
8	GND for blue video signal		

■RS-232C input terminal pins

(D-sub 9 pin)

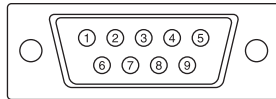

No.	Function	No.	Function
1	N.C.	6	N.C.
2	Transmitted data	7	N.C.
3	Received data	8	N.C.
4	N.C.	9	N.C.
5	GND		

Mounting Precautions (For SHARP dealers and service engineers)

- When installing, removing or moving the monitor, ensure that this is carried out by at least 2 people. (PN-UH861: at least 3 people.)
- Be sure to use a wall-mount bracket designed or designated for mounting the monitor.
- This monitor is designed to be installed on a concrete wall or pillar. Reinforced work might be necessary for some materials such as plaster / thin plastic board / wood before starting installation.
- This monitor and bracket must be installed on a wall which can endure at least 4 times or more the weight of the monitor. Install by the most suitable method for the material and the structure.
- To attach a VESA-compliant mounting bracket, remove the screws attached to screw holes for mounting brackets. Do not use the removed screws to attach the mounting bracket. (PN-UH861 ONLY)
- To attach a VESA-compliant mounting bracket, use M8 [PN-UH861] or M6 [PN-UH551/PN-UH501/PN-UH431] screws that are 11/16 inch (18 mm) to 13/16 inch (20 mm) [PN-UH861] or 5/16 inch (8 mm) to 3/8 inch (10 mm) [PN-UH551/PN-UH501/PN-UH431] longer than the thickness of the mounting bracket.

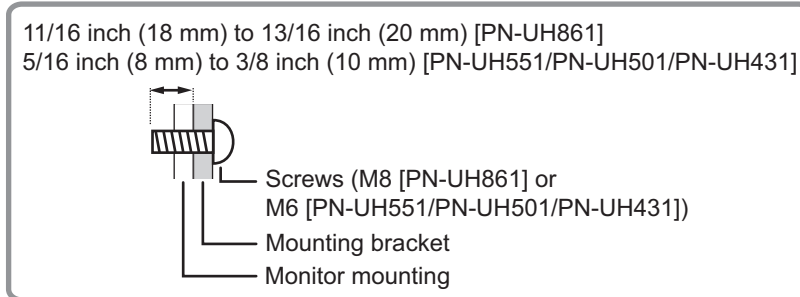

- Do not use an impact driver.
- When moving the monitor, be sure to hold the parts marked by  below. Do not hold the LCD panel. This may cause product damage, failure, or injury.

[PN-UH861]

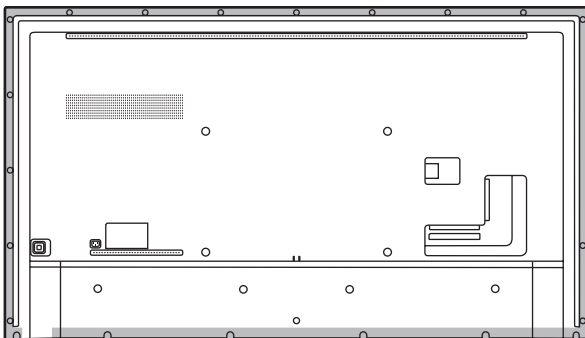

[PN-UH551/PN-UH501/PN-UH431]

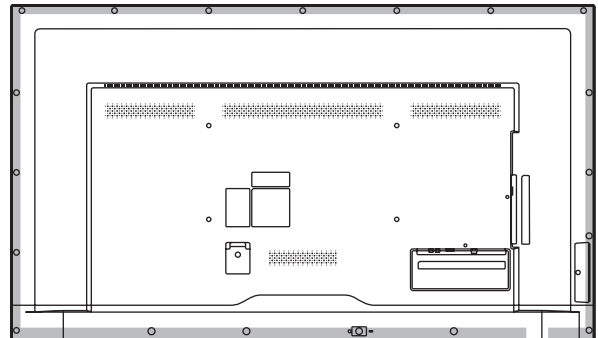

- After mounting, please carefully ensure the monitor is secure, and not able to come loose from the wall or mount.
- Do not use any screw holes other than those for mounting brackets, located on the rear of the monitor, for installation.

SHARP®
SHARP CORPORATION