

SHARP

Be Original.

PN-HM851
PN-HM751
PN-HM651

Professional LCD Monitors

Spectacular 4K LCD Monitors Deliver 24/7 Professional Smart Signage



4K

3840 × 2160 Pixels



The impressive scale of PN-HM851/HM751/HM651 monitors enhance in-store ambience while immersing viewers in realistic life-size images. Coming in three sizes—85" Class (84 9/16" diagonal), 75" Class (74 9/16" diagonal) and 65" Class (64 1/2" diagonal)—this versatile signage solution lets you easily create and deliver customized content. The PN-HM851/HM751/HM651 displays handle a range of signage needs, from simple set-ups to solutions for large networks of multiple monitors. These durable and flexible monitors can work 24/7, supporting a wide range of signage needs. Whether installed in a shopping mall, transport hub, or conference hall, the PN-HM851/HM751/HM651 displays convey your message with overwhelming style and precision.

Out-of-the-Box Digital Signage Solution

Built-in SoC (System on a Chip)

The PN-HM851/HM751/HM651 displays have a powerful integrated SoC controller driven by an Arm® Cortex® hexa-core processor. The SoC comes with 4 GB of memory, 32 GB of storage and integrated Android™ OS (7.1). These monitors are ready to display signage right out of the box.

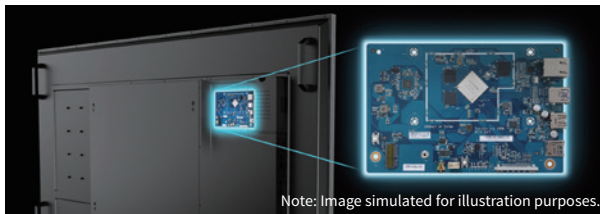

Monitors with no built-in SoC controller

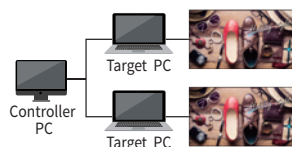

Requires a target PC for each monitor

Monitors with a built-in SoC controller

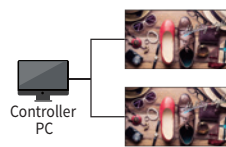

No target PCs required

Support for H.265/HEVC

PN-HM851/HM751/HM651 monitors support not only H.264/AVC but also H.265/HEVC. The latter is a next-generation, high-efficiency video codec that reduces the communication burden during video transmission. Your content takes on a new level of depth and presence, thanks to the sheer scale and precision of these screens.

SHARP Open Architecture Platform

This platform allows third-party software developers to create custom signage applications. This opens up rich possibilities for digital signage in retail, office and other settings. Certification under the Google® Compatibility Test Suite (CTS) assures compatibility with third-party Android apps.

Note: For details, please consult with your local authorized Sharp dealer or representative.

Smart Connectivity

The PN-HM851/HM751/HM651 displays support high-speed wireless LAN and features built-in Bluetooth® connectivity. This lets you deliver content—and connect equipment—wirelessly.

Ready for Versatile Signage Support

Autoplay with Media Player

Displaying still images or videos as signage content couldn't be easier. When the monitor is powered on, the built-in media player automatically starts playing content stored in internal storage or on a USB memory device or microSD card. A simple schedule function allows you to pre-register seven patterns for when to start/stop the content playback. In a slideshow, you can add visual effects between the still images. You can also make playlists that combine still images and videos. The PN-HM851/HM751/HM651 displays let you enjoy the benefits of simple digital signage without any extra software, special skills or even a PC.

Web-Based Signage

The PN-HM851/HM751/HM651 displays feature a pre-installed HTML5 browser on the SoC as well as built-in support for Bluetooth and a high-speed wireless LAN. This makes it easy to show web content on the monitor as signage content.

Note: Web-based content can be displayed at up to 1080p resolution.

SHARP Content Distributor

This software makes it easy to update the content to be displayed on multiple LCD monitors. Through simple and intuitive PC operation, you can schedule **what** content gets distributed, **when** it gets delivered, and **which** monitors show it. Take advantage of a convenient signage solution that lets you distribute content in a timely manner to multiple monitors.

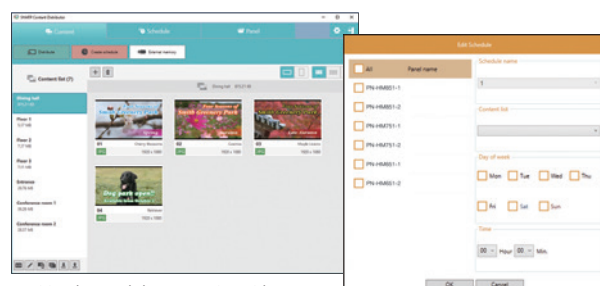

Intuitive drag-and-drop operation with thumbnail view

Easy editing of distribution schedules

Note: SHARP Content Distributor is available via the downloader on the bundled CD-ROM.

Flexibility and Expandability

Superb 4K LCD Panel

The PN-HM851/HM751/HM651 supports 4K Ultra-HD (3,840 × 2,160-pixel) resolution and is equipped with a variety of inputs to support up to 4K60p playback*. These monitors can express all the detail and visual impact of your selected content. A brightness of 500 cd/m² supports them in their digital signage functions.

* 4K playability depends on PC and system configuration.

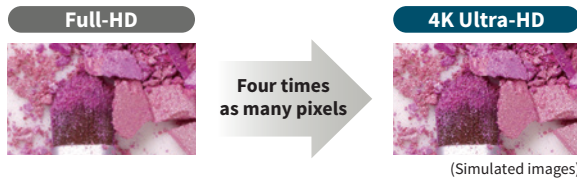

Flexible Settings

The PN-HM851/HM751/HM651 is designed for easy installation. You can install it in a landscape or portrait orientation or even face up. And you can tilt it too—either backward up to 90 degrees or forward up to 20 degrees. Such flexibility gives you more freedom to meet today's demanding signage needs.

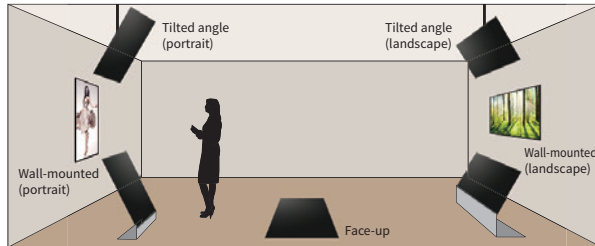

Note: Please consult with your local authorised Sharp dealer or representative regarding tilttable angles and other installation conditions.

Reliable 24/7 Operation

Built solid and durable, the PN-HM851/HM751/HM651 is ideal for use in 24-hour stores and other demanding professional applications that require around-the-clock operation, seven days a week.

Notes:

1. Rebooting the OS once a day is highly recommended to maintain stable operation.
2. When POWER SAVE MODE is set to OFF, the integrated SoC controller stays on even in standby mode.

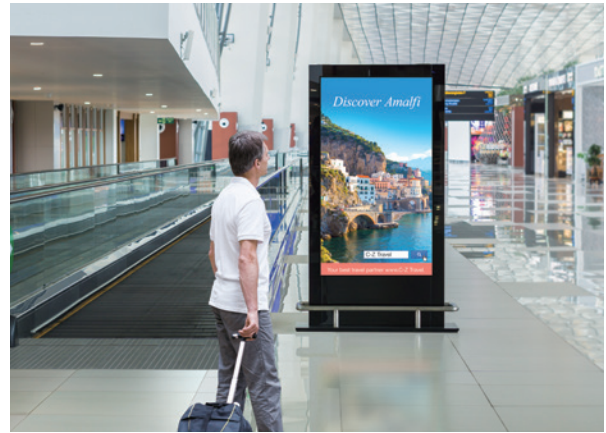

DisplayPort™ Daisy Chain

Up to four PN-HM851/HM751/HM651 monitors can be set up in a daisy chain configuration by connecting their DisplayPort terminals. This lets you display the same content simultaneously on all screens.

HDBaseT™ Receiver Board (PN-ZB03H) (Option)

HDMI™ video*¹/audio and control signals can be received via a single LAN cable*² from up to 100 metres away. Compatibility with HDBaseT 2.0 allows you to remotely operate a PC from a USB device connected to this board*³.

*1 Video signals up to 4K30p can be transferred.

*2 Category 6 or higher shielded cable (available commercially).

*3 Requires an HDBaseT 2.0-compatible transmitter (available commercially). Not all USB devices are supported.

Wireless Board (PN-ZB03W) (Option)

This allows up to 10 devices—including Mac® or Windows® computers, smartphones, and tablets—to be connected simultaneously to the monitor without any cable hassles. Input from four devices can be displayed in a 2 × 2 split screen, with images displayed at up to 1080p resolution. Enabling such wireless collaboration is a great way to enhance productivity in work or educational environments.

Note: Transferred screen images can be displayed at up to 1080p resolution.

SHARP e-Signage S

This versatile signage software provides total support for creating, scheduling, distributing and managing a wide range of signage programs on Sharp LCD monitors in a variety of locations. You can make and edit signage programs easily through simple drag-and-drop operation. As well as laying out diverse content, you can create display schedules and monitor the operational status of designated LCD monitors. The PN-HM851/HM751/HM651 displays come bundled with the Standalone Edition of SHARP e-Signage S. It also includes a signage player pre-installed on the integrated Android OS.

	Product name	No. of target PCs (Players)	No. of operators	Distribution network
Standalone Edition	Bundled	1	1	No
Player	Pre-installed			

Notes:

1. SHARP e-Signage S content can be displayed at up to 1080p resolution.
2. SHARP e-Signage S (Standalone Edition) is available via the downloader on the bundled CD-ROM.



Specifications

Model Name	PN-HM851	PN-HM751	PN-HM651	
Installation	Landscape / Portrait / Face-up			
LCD Panel	85" Class (84 3/16" diagonal) TFT LCD	75" Class (74 7/16" diagonal) TFT LCD	65" Class (64 1/2" diagonal) TFT LCD	
	Max. Resolution	3,840 × 2,160 pixels		
	Max. Display Colors (approx.)	1,070 million colors		
	Pixel Pitch (H × V)	0.488 × 0.488 mm	0.430 × 0.430 mm	0.372 × 0.372 mm
	Max. Brightness*1	500 cd/m ²		
	Contrast Ratio	5,000 : 1		
	Viewing Angle (H/V)	178°/178° (CR ≥ 10)		
	Active Screen Area (W × H)	73 11/16" × 41 7/16"	65" × 36 9/16"	56 1/4" × 31 5/8"
	Response Time	9.5 ms (gray to gray avg.)		
Backlight	LED, direct lit			
Computer Input	Video	Analog RGB (0.7 Vp-p) [75Ω], DisplayPort 1.2, HDMI		
	Synchronization	Horizontal/vertical separation (TTL: positive/negative)		
	Plug & Play	VESA DDC2B		
Input Terminals*2	DisplayPort × 1, Mini D-sub 15-pin × 1, HDMI × 2, RS-232C × 1, 3.5 mm-diameter mini stereo jack × 1			
Output Terminals*2	DisplayPort × 1, RS-232C × 1*3, 3.5 mm-diameter mini stereo jack × 1			
Android	OS	Android 7.1		
	CPU	Hexa Core [Arm Cortex-A72 processor (dual core) + Arm Cortex-A53 processor (quad core)]		
	Memory	4 GB		
	Storage	32 GB		
	External Interface	LAN port (10Base-T/100Base-TX/1000Base-T), microSD card slot (microSD/microSDHC/microSDXC*) × 1, USB port (3.0-compliant) × 2, USB port (2.0-compliant) × 1		
	Wireless LAN	Compliant with IEEE802.11ac/n/a/g/b		
Bluetooth	Compliant with version 4.1 (A2DP/AVRCP/GATT/GAP/HID/HOGP)			
Expansion Slot	12 V, 2.5 A (power supplied when expanding the functions with an optional part)			
Speaker Output	10 W + 10 W			
Mounting	4 points, 600 × 400 mm pitch, M6 screw		4 points, 400 × 400 mm pitch, M6 screw	
Power Supply	100 V – 240 V AC, 50/60 Hz			
Power Consumption*5	370 W		320 W	
	260 W			
Environmental Conditions	Operating Temperature*6	0 °C to 40 °C		
	Operating Humidity	20% to 80% RH (no condensation)		
Dimensions (W × D × H) (approx.) (display only)	74 7/8" × 3 1/2" × 42 3/8"	66" × 3 7/16" × 37 9/16"	57 5/16" × 3 7/16" × 32 11/16"	
Weight (approx.)*5	105.9 lbs	81.6 lbs	64 lbs	
Main Accessories	AC power cord, remote control unit, battery (AAA size) × 2, CD-ROM, set-up manual, cable clamp (insertion type) × 2, cable clamp (stick-on type) × 3, USB flash drive/microSD card cover, USB flash drive/microSD card cover fixing screw, logo sticker, wireless LAN antenna × 2, RS-232C conversion cable × 1			

*1 Brightness depends on input mode and other picture settings. Brightness level will decrease slightly over the lifetime of the product. Due to the physical limitations of the equipment, it is not possible to maintain a precisely constant level of brightness. *2 Use a commercially available connection cable for PC and other video connections. *3 Requires the bundled RS-232C conversion cable. *4 exFAT is not supported. *5 Power consumption and weight may vary from specified levels. *6 When using the monitor lying flat on a surface (or when the monitor is tilted more than 20 degrees upward or downward from the perpendicular in relation to a level surface) the ambient temperature must be within the range of 0°C to 30°C. Temperature conditions may change when using the monitor together with optional equipment. In such cases, check the temperature conditions specified by the optional equipment.

Dimensions

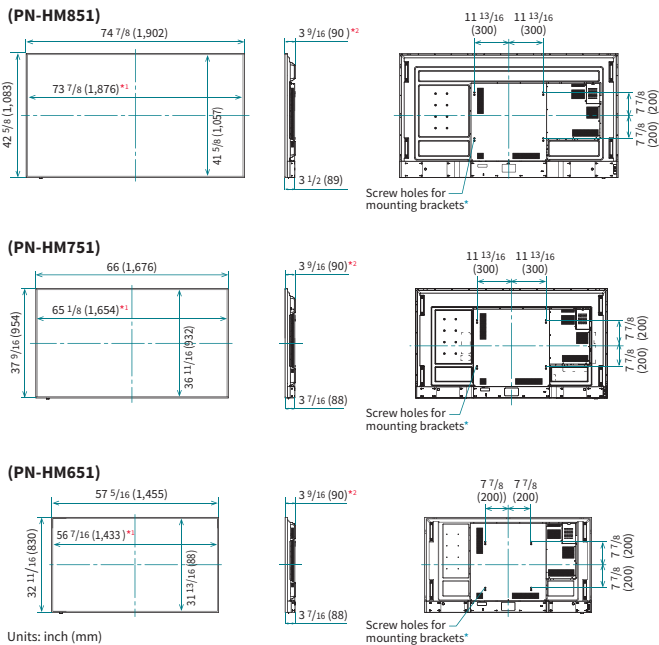

Units: inch (mm)
 *1 Screen dimensions *2 Including detachable handle
 * To use the mounting bracket, use M6 screws that are 8 to 10 mm plus the thickness of the bracket.

Input/Output Terminals

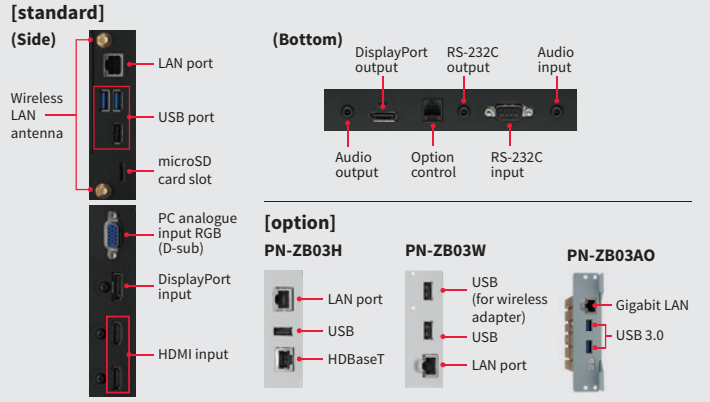

Options

	PN-ZB03H: HDBaseT Receiver Board	PN-ZB03W: Wireless Board	PN-ZB03AO: Computing Board
Supported standard	HDBaseT 2.0		
Max. resolution	4,096 × 2,160 (30 Hz)	1,920 × 1,080 (30 Hz)	
Copy protection	HDCP pass-through	2.4 GHz, IEEE802.11b/g/n 5 GHz, IEEE802.11a/n	
Transmission distance	Up to 328 feet / 100 m		
Input/output terminals	HDBaseT × 1, LAN × 1 (10Base-T/100Base-TX), USB × 1 (USB 2.0)	LAN port × 1 (10Base-T/100Base-TX), USB × 1 (USB 2.0), Wireless adapter × 1 (USB 2.0)	
Power supply	From the monitor	From the monitor	
			PN-ZB03AO Computing Board
			Max. resolution 3,840 × 2,160 (30 Hz)



SHARP ELECTRONICS CORPORATION
 100 Paragon Drive, Montvale, NJ 07645
 1-800-BE-SHARP • www.sharppusa.com

Sharp is a registered trademark of Sharp Corporation. Arm and Cortex are registered trademarks of ARM Limited (or its subsidiaries) in the US and/or elsewhere. Google and Android are either trademarks or registered trademarks of Google LLC. Bluetooth is a registered trademark of Bluetooth SIG, Inc. DisplayPort and the DisplayPort Compliance Logo are trademarks owned by the Video Electronics Standards Association in the United States and other countries. HDBaseT and the HDBaseT Alliance logo are trademarks of the HDBaseT Alliance. The terms HDMI and HDMI High-Definition Multimedia Interface and the HDMI Logo are trademarks or registered trademarks of HDMI Licensing Administrator, Inc. Mac is a trademark of Apple Inc., registered in the U.S. and other countries. Windows is a registered trademark of Microsoft Corporation in the United States and other countries. All other brand names and product names may be trademarks or registered trademarks of their respective owners. All screen images appearing in this brochure are simulated. Design and specifications are subject to change without prior notice.