

SHARP[®]

PN-HM851

PN-HM751

PN-HM651

PN-HB851

PN-HB751

PN-HB651

LCD MONITOR

OPERATION MANUAL

HDMI

IMPORTANT:

To aid reporting in case of loss or theft, please record the product's model and serial numbers in the space provided. The numbers are located in the rear of the product.



Model No.:

Serial No.:

U.S.A. ONLY

IMPORTANT INFORMATION

WARNING: TO REDUCE THE RISK OF FIRE OR ELECTRIC SHOCK, DO NOT EXPOSE THIS PRODUCT TO RAIN OR MOISTURE.

	CAUTION RISK OF ELECTRIC SHOCK DO NOT OPEN	
<p>CAUTION: TO REDUCE THE RISK OF ELECTRIC SHOCK, DO NOT REMOVE COVER. NO USER-SERVICEABLE PARTS INSIDE. REFER SERVICING TO QUALIFIED SERVICE PERSONNEL.</p>		



The lightning flash with arrowhead symbol, within a triangle, is intended to alert the user to the presence of uninsulated “dangerous voltage” within the product’s enclosure that may be of sufficient magnitude to constitute a risk of electric shock to persons.



The exclamation point within a triangle is intended to alert the user to the presence of important operating and maintenance (servicing) instructions in the literature accompanying the product.

WARNING:

FCC Regulations state that any unauthorized changes or modifications to this equipment not expressly approved by the manufacturer could void the user’s authority to operate this equipment.

NOTE:

This equipment has been tested and found to comply with the limits for a Class A digital device, pursuant to Part 15 of the FCC Rules. These limits are designed to provide reasonable protection against harmful interference when the equipment is operated in a commercial environment. This equipment generates, uses, and can radiate radio frequency energy and, if not installed and used in accordance with the instruction manual, may cause harmful interference to radio communications. Operation of this equipment in a residential area is likely to cause harmful interference in which case the user will be required to correct the interference at his own expense.

This product utilizes a CR coin Lithium battery which contains a Perchlorate material. Special handling for this material may apply, California residents, See www.dtsc.ca.gov/hazardouswaste/perchlorate/ Others, consult local environmental officers.

U.S.A. ONLY

To maintain compliance with EMC regulations, use shielded cables to connect to the following terminals: HDMI input terminal, D-sub input terminal, RS-232C input/output terminals, and DisplayPort input/output terminals.

DEAR SHARP CUSTOMER

Thank you for your purchase of a SHARP LCD product. To ensure safety and many years of trouble-free operation of your product, please read the Safety Precautions carefully before using this product.

SAFETY PRECAUTIONS

Electricity is used to perform many useful functions, but it can also cause personal injuries and property damage if improperly handled. This product has been engineered and manufactured with the highest priority on safety. However, improper use can result in electric shock and/or fire. In order to prevent potential danger, please observe the following instructions when installing, operating and cleaning the product. To ensure your safety and prolong the service life of your LCD product, please read the following precautions carefully before using the product.

1. Read instructions — All operating instructions must be read and understood before the product is operated.
2. Keep this manual in a safe place — These safety and operating instructions must be kept in a safe place for future reference.
3. Observe warnings — All warnings on the product and in the instructions must be observed closely.
4. Follow instructions — All operating instructions must be followed.
5. Cleaning — Unplug the power cord from the power outlet before cleaning the product. Use a dry cloth to clean the product. Do not use liquid cleaners or aerosol cleaners. Do not use dirty cloths. Doing so may damage the product.
6. Attachments — Do not use attachments not recommended by the manufacturer. Use of inadequate attachments can result in accidents.
7. Water and moisture — Do not use the product near water. Do not install the product in a place where water may splash onto it. Be careful of equipment which drains water such as an air-conditioner.
8. Ventilation — The vents and other openings in the cabinet are designed for ventilation. Do not cover or block these vents and openings since insufficient ventilation can cause overheating and/or shorten the life of the product. Do not place the product on a sofa, rug or other similar surface, since they can block ventilation openings. Do not place the product in an enclosed place such as a bookcase or rack, unless proper ventilation is provided or the manufacturer's instructions are followed.
9. Power cord protection — The power cords must be routed properly to prevent people from stepping on them or objects from resting on them.
10. The screen used in this product is made of glass. Therefore, it can break when the product is dropped or applied with impact. Be careful not to be injured by broken glass pieces in case the screen breaks.
11. Overloading — Do not overload power outlets or extension cords. Overloading can cause fire or electric shock.
12. Entering of objects and liquids — Never insert an object into the product through vents or openings. High voltage flows in the product, and inserting an object can cause electric shock and/or short internal parts. For the same reason, do not spill water or liquid on the product.
13. Servicing — Do not attempt to service the product yourself. Removing covers can expose you to high voltage and other dangerous conditions. Request a qualified service person to perform servicing.
14. Repair — If any of the following conditions occurs, unplug the power cord from the power outlet, and request a qualified service person to perform repairs.
 - a. When the power cord or plug is damaged.
 - b. When a liquid was spilled on the product or when objects have fallen into the product.
 - c. When the product has been exposed to rain or water.
 - d. When the product does not operate properly as described in the operating instructions.

Do not touch the controls other than those described in the operating instructions. Improper adjustment of controls not described in the instructions can cause damage, which often requires extensive adjustment work by a qualified technician.
 - e. When the product has been dropped or damaged.
 - f. When the product displays an abnormal condition. Any noticeable abnormality in the product indicates that the product needs servicing.
15. Replacement parts — In case the product needs replacement parts, make sure that the service person uses replacement parts specified by the manufacturer, or those with the same characteristics and performance as the original parts. Use of unauthorized parts can result in fire, electric shock and/or other danger.
16. Safety checks — Upon completion of service or repair work, request the service technician to perform safety checks to ensure that the product is in proper operating condition.
17. Wall mounting — When mounting the product on a wall, be sure to install the product according to the method recommended by the manufacturer.
18. Heat sources — Keep the product away from heat sources such as radiators, heaters, stoves and other heat-generating products (including amplifiers).

SAFETY PRECAUTIONS (Continued)

19. Batteries — Incorrect use of batteries may cause the batteries to burst or ignite. A leaky battery may corrode the equipment, dirty your hands or spoil your clothing. In order to avoid these problems, make sure to observe the precautions below:
 - Use the specified batteries only.
 - Install the batteries with due attention to the plus (+) and minus (-) sides of the batteries according to the instructions in the compartment.
 - Do not mix old and new batteries.
 - Do not mix batteries of different types. Voltage specifications of batteries of the same shape may vary.
 - Replace an exhausted battery with a new one promptly.
 - If you will not use the remote control for a long time, remove the batteries.
 - If leaked battery fluid gets on your skin or clothing, rinse immediately and thoroughly. If it gets into your eye, bathe your eye well rather than rubbing and seek medical treatment immediately. Leaked battery fluid that gets into your eye or your clothing may cause a skin irritation or damage your eye.
20. Usage of the monitor must not be accompanied by fatal risks or dangers that, could lead directly to death, personal injury, severe physical damage or other loss, including nuclear reaction control in nuclear facility, medical life support system, and missile launch control in a weapon system.
21. Do not stay in contact with the parts of the product that become hot for long periods of time. Doing so may result in low-temperature burns.
22. Do not modify this product.

WARNING:

This is a Class A product. In a domestic environment this product may cause radio interference in which case the user may be required to take adequate measures.

An apparatus with CLASS I construction shall be connected to a MAIN socket outlet with a protective earthing connection.

STABILITY HAZARD

If a monitor is not positioned in a sufficiently stable location, it can be potentially hazardous due to falling. Many injuries, particularly to children, can be avoided by taking simple precautions such as:

- Using fixing devices like wall mount brackets recommended by the manufacturer.
- Only using furniture that can safely support the monitor.
- Ensuring the monitor is not overhanging the edge of the supporting furniture.
- Not placing the monitor on tall furniture (for example, cupboards or bookcases) without anchoring both the furniture and the monitor to a suitable support.
- Not standing the monitors on cloth or other materials placed between the monitor and supporting furniture.
- Educating children about the dangers of climbing on furniture to reach the monitor or its controls.
- This equipment is not suitable for use in locations where children are likely to be present unsupervised.

Especially for child safety

- Don't allow children to climb on or play with the monitor.
- Don't place the monitor on furniture that can easily be used as steps, such as a chest of drawers.
- Remember that children can become excited while watching a program, especially on a "larger than life" monitor. Care should be taken to place or install the monitor where it cannot be pushed, pulled over, or knocked down.
- Care should be taken to route all cords and cables connected to the monitor so that they cannot be pulled or grabbed by curious children.

TIPS AND SAFETY INSTRUCTIONS

- The TFT color LCD panel used in this monitor is made with the application of high precision technology. However, there may be minute points on the screen where pixels never light or are permanently lit. Also, if the screen is viewed from an acute angle there may be uneven colors or brightness. Please note that these are not malfunctions but common phenomena of LCDs and will not affect the performance of the monitor.
- Do not display a still picture for a long period, as this could cause a residual image.
- Never rub or tap the monitor with hard objects.
- Please understand that SHARP CORPORATION bears no responsibility for errors made during use by the customer or a third party, nor for any other malfunctions or damage to this product arising during use, except where indemnity liability is recognized under law.
- This monitor and its accessories may be upgraded without advance notice.
- Do not use the monitor where there is a lot of dust, where humidity is high, or where the monitor may come into contact with oil or steam. Do not use in an environment where there are corrosive gases (sulfur dioxide, hydrogen sulfide, nitrogen dioxide, chlorine, ammonia, ozone, etc.). As this could lead to fire.
- Ensure that the monitor does not come into contact with water or other fluids. Ensure that no objects such as paper clips or pins enter the monitor as this could lead to fire or electric shock.
- Do not place the monitor on top of unstable objects or in unsafe places. Do not allow the monitor to receive strong shocks or to strongly vibrate. Causing the monitor to fall or topple over may damage it.
- Do not use the monitor near heating equipment or in places where there is likelihood of high temperature, as this may lead to generation of excessive heat and outbreak of fire.
- Do not use the monitor in places where it may be exposed to direct sunlight. Risk of cabinet deformation and failure if the monitor is used in direct sunlight.
- If the monitor is installed in a location exposed to sunlight such as next to a window, measures to reduce ultraviolet and infrared radiation and temperature measures are required. For details, consult your dealer.
- Please be sure to constantly remove dust and garbage that has attached to the ventilation opening. If dust collects in the ventilation opening or the inside of the monitor, it may lead to excessive heat, outbreak of fire, or malfunction. Please request a cleaning of the inside of the monitor from an authorized SHARP servicing dealer or service center.
- When using this monitor in a portrait orientation, prepare portrait-oriented content in advance.
- The power outlet shall be installed near the equipment and shall be easily accessible.
- Continuous operating time and warranty. (PN-HB851/PN-HB751/PN-HB651 only)
This product is designed for a maximum daily use of 16 hours. Continual use in excess of 16 hours per day is not covered by the warranty.
- Restarting the Android system.
To maintain stable operation of APPLICATION mode, the Android system must be restarted once a day. A schedule is set by factory default in this monitor that restarts the system at 3:00 AM. (See the "APPLICATION Mode Reboot" of Software Guide.)

- If you or a third party uses the product incorrectly, or if the product is subjected to the effects of static electricity or electrical noise, or if the product malfunctions or is repaired, there is a risk that saved data will be corrupted or lost.
- Always back up important data to a USB flash drive or microSD memory card.
- We bear no responsibility for protection of internal memory recorded content or related damages.

The Power Cord

- Use only the power cord supplied with the monitor.
- Do not damage the power cord nor place heavy objects on it, stretch it or over bend it. Also, do not add extension cords. Damage to the cord may result in fire or electric shock.
- Do not use the power cord with a power tap. Adding an extension cord may lead to fire as a result of overheating.
- Do not remove or insert the power plug with wet hands. Doing so could result in electric shock.
- Unplug the power cord if it is not used for a long time.
- Do not attempt to repair the power cord if it is broken or malfunctioning. Refer the servicing to the service representative.

Manual Scope

- Microsoft and Windows are either registered trademarks or trademarks of Microsoft Corporation in the United States and/or other countries.
- The terms HDMI and HDMI High-Definition Multimedia Interface, and the HDMI Logo are trademarks or registered trademarks of HDMI Licensing Administrator, Inc. in the United States and other countries.
- DisplayPort is a registered trademark of Video Electronics Standards Association.
- Google and Android are trademarks or registered trademarks of Google LLC.
- Ethernet is a registered trademark of Xerox Corporation.
- VESA is either registered trademark or trademark of Video Electronics Standards Association in the United States and/or other countries.
- All other brand and product names are trademarks or registered trademarks of their respective holders.
- This product comes with RICOH Bitmap Fonts produced and sold by RICOH COMPANY, LTD.
- Language of OSD menu used in this manual is English by way of example.
- Illustrations in this manual may not exactly represent the actual product or display.
- This manual assumes use in landscape orientation, except where specifically noted.

LED Backlight

- The LED backlight in this product has a limited lifetime.
 - * If the screen gets dark or does not turn on, it may be necessary to replace the LED backlight.
 - * This LED backlight is exclusive to this product and must be replaced by an authorized SHARP servicing dealer or service center. Please contact an authorized SHARP servicing dealer or service center for assistance.

MOUNTING PRECAUTIONS

- This product is for use indoors.
- A mounting bracket compliant with VESA specifications is required.
- Since the monitor is heavy, consult your dealer before installing, removing or moving the monitor.
- Mounting the monitor on the wall requires special expertise and the work must be performed by an authorized SHARP dealer. You should never attempt to perform any of this work yourself. Our company will bear no responsibility for accidents or injuries caused by improper mounting or mishandling.
- Use the monitor with the surface perpendicular to a level surface. If necessary, the monitor may be tilted up to 20 degrees upward or downward.
- This monitor should be used at an ambient temperature between 32°F (0°C) and 104°F (40°C). Provide enough space around the monitor to prevent heat from accumulating inside.

For the monitor in landscape orientation

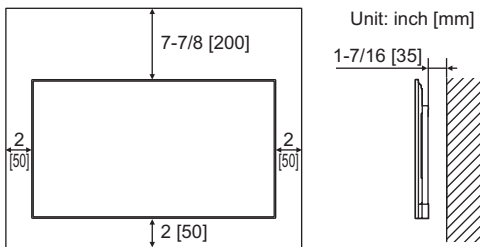

For the monitor in portrait orientation

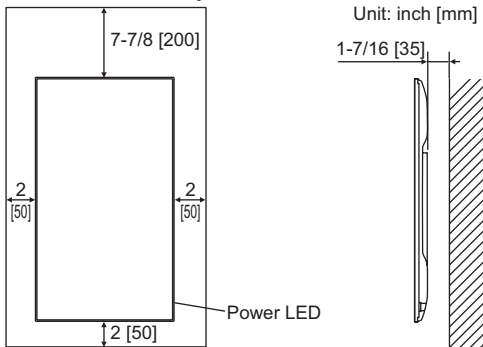

- If it is difficult to provide sufficient space for any reason such as the installation of the monitor inside a housing or of several units side-by-side, or if the ambient temperature may be outside of the range of 32°F (0°C) to 104°F (40°C), install a fan or take other measures to keep the ambient temperature within the required range.
- When installing two or more monitor units side-by-side, provide space of at least 3/16 inch (5 mm) around them to prevent stress on the adjacent unit or structure due to thermal expansion.
- Temperature condition may change when using the monitor together with the optional equipments recommended by SHARP. In such cases, please check the temperature condition specified by the optional equipments.
- Do not block any ventilation openings. If the temperature inside the monitor rises, this could lead to a malfunction.
- Do not place the monitor on a device which generates heat.

- Adhere to the following when installing the monitor in its portrait orientation. Failing to adhere to the following may cause malfunctions.
 - Install the monitor such that the power LED is located on the bottom side.
 - Set the PORTRAIT/LANDSCAPE INSTALL in the MONITOR menu to PORTRAIT. (See page 28)
 - Be sure to clamp the power cord (supplied) onto the cable clamp attachment using the supplied cable clamp. When clamping the power cord, take care not to stress the terminal of the power cord. Do not bend the power cord excessively.

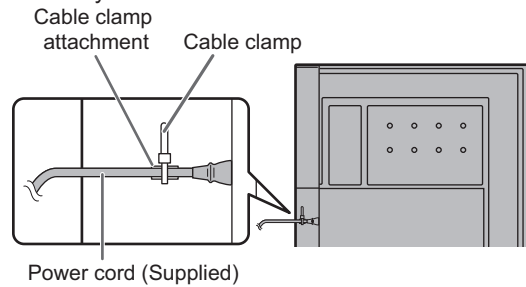

Mounting the monitor laying flat on a surface

- When using this monitor laying flat on a surface (when the monitor is tilted more than 20 degrees upward from the perpendicular in relation to a level surface), consult an authorized SHARP dealer because there are some specific mounting conditions.

Adhere to the following. Failing to adhere to the following may cause malfunctions.

- This monitor can be tilted up to 90 degrees upward.
- Set HORIZONTAL INSTALLATION in the MONITOR menu to FACE UP. (See page 28.)
- Use this monitor at the ambient temperature between 32°F (0°C) and 86°F (30°C). Provide 7-7/8 inch (200 mm) or more space between the monitor and the floor or other mounting surfaces and surrounding objects to prevent heat from accumulating inside.

If it is difficult to provide sufficient space or if the ambient temperature may be outside of the range of 32°F (0°C) to 86°F (30°C), install a fan or take other measures to keep the ambient temperature within the required range.

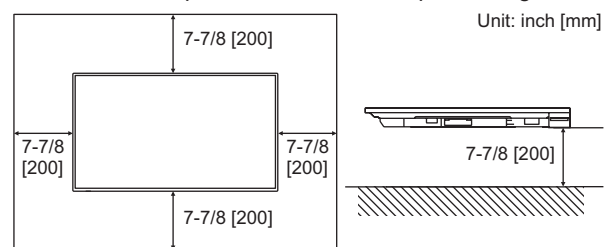

- Do not press hard on the screen or otherwise subject it to impacts.

Contents

IMPORTANT INFORMATION	3	Basic Operation	20
DEAR SHARP CUSTOMER	4	Menu Items	23
SAFETY PRECAUTIONS	4	Displaying the menu screen.....	23
TIPS AND SAFETY INSTRUCTIONS	6	Menu item details	24
MOUNTING PRECAUTIONS	7	Adjustments for computer screen display	35
Supplied Components	8	Initialization (Reset)/Functional Restriction Setting	
Part Names	9	(FUNCTION)	36
Connecting Peripheral Equipment	11	Controlling the Monitor with a computer (RS-232C) ...	38
Connecting the Power Cord	13	Computer connection	38
Binding Cables	13	Communication conditions	38
Removing the Handles	14	Communication procedure	38
Attaching the logo sticker	14	RS-232C command table.....	42
Attaching the USB flash drive / SD card cover	15	Controlling the Monitor with a computer (LAN)	49
Attaching the wireless LAN antenna	15	Command-based control.....	49
Preparing the Remote Control Unit	16	Troubleshooting	50
Installing the batteries	16	Specifications	52
Remote control operation range.....	16	Mounting Precautions	
Turning Power On/Off	18	(For SHARP dealers and service engineers)	56
Turning on the main power.....	18		
Turning power on/off	18		
Disabling power on/off operations.....	19		

Supplied Components

If any component should be missing, please contact your dealer.

- Liquid Crystal Display Monitor: 1
- Remote control unit: 1
- Cable clamp: 2



- Cable clamp (affixing type): 3

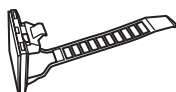

- Power cord: 1
- R03 battery ("AAA" size): 2
- CD-ROM (Utility Disk for Windows): 1
- Setup Manual: 1
- Specification sheet
- RS-232C conversion cable (3.5mm mini stereo jack): 1
- Logo sticker: 1
- USB flash drive / SD card cover: 1
- USB flash drive / SD card cover fixing screw: 1
- Wireless LAN antenna: 2

* SHARP Corporation holds authorship rights to the Utility Disk program. Do not reproduce it without permission.

* For environmental protection!

Do not dispose of batteries in household waste. Follow the disposal instructions for your area.

TIPS

- SHARP Content Distributor setup program can be downloaded using Information Display Downloader. Install Information Display Downloader.
- When the Information Display Downloader is installed, you can check and download the most recent versions of the software programs.
- To install and use the software, see the manual for each.

Part Names

■ Front view



■ Rear view

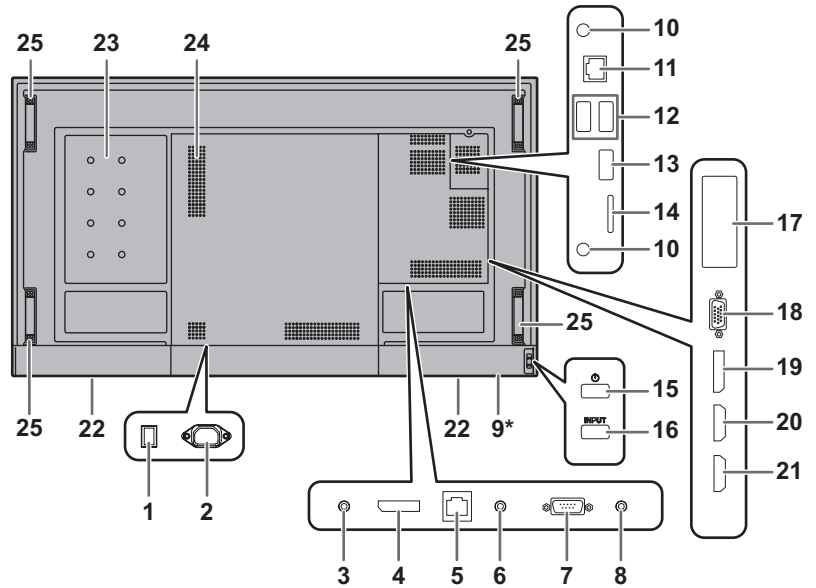

* How to pull out the power LED/remote control sensor

Pull out

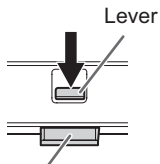

Power LED / Remote control sensor

Store

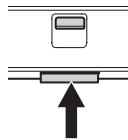

- Slide the lever on the rear of the monitor to pull out the power LED/remote control sensor.
Press the power LED/remote control sensor directly to store it inside the monitor.

- 1. Main power switch** (See page 13.)
- 2. AC input terminal** (See page 13.)
- 3. Audio output terminal** (See page 12.)
- 4. DisplayPort output terminal** (See page 12.)
- 5. Optional terminal**
This terminal is provided for possible future (optional) function expansion. Offering of this terminal is not a guarantee that future expanded functionality will be released.
- 6. RS-232C output terminal** (See page 11.)
- 7. RS-232C input terminal** (See page 11.)
- 8. Audio input terminal** (See page 11.)
- 9. Power LED** (See page 18.) / **Remote control sensor** (See page 16.)
- 10. Wireless LAN antenna terminal** (See page 12.)
- 11. LAN terminal** (See page 12.)
- 12. USB port (USB 3.0 compliant)** (See page 12.)
- 13. USB port (USB 2.0 compliant)** (See page 12.)

- 14. microSD card slot** (See page 12.)
- 15. POWER button** (See page 18.)
- 16. INPUT button** (See page 21.)
- 17. Expansion slot**

This section is used to connect optional hardware for function expansion. Offering this attachment location is not a guarantee that future compatible hardware attachments will be released.

- 18. D-sub input terminal** (See page 11.)
- 19. DisplayPort input terminal** (See page 11.)
- 20. HDMI1 input terminal** (See page 11.)
- 21. HDMI2 input terminal** (See page 11.)
- 22. Speakers**

23. Optional attachment section

This section is used to connect optional hardware for function expansion. Offering this attachment location is not a guarantee that future compatible hardware attachments will be released.

- 24. Vents**
- 25. Handles**

! Caution

- Consult your SHARP dealer for attachment/detachment of optional parts.

Part Names

■Remote control unit

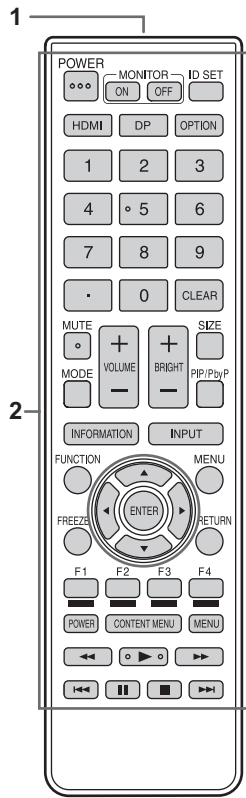

1. Signal transmitter
2. Operation buttons (See page 20.)

Connecting Peripheral Equipment

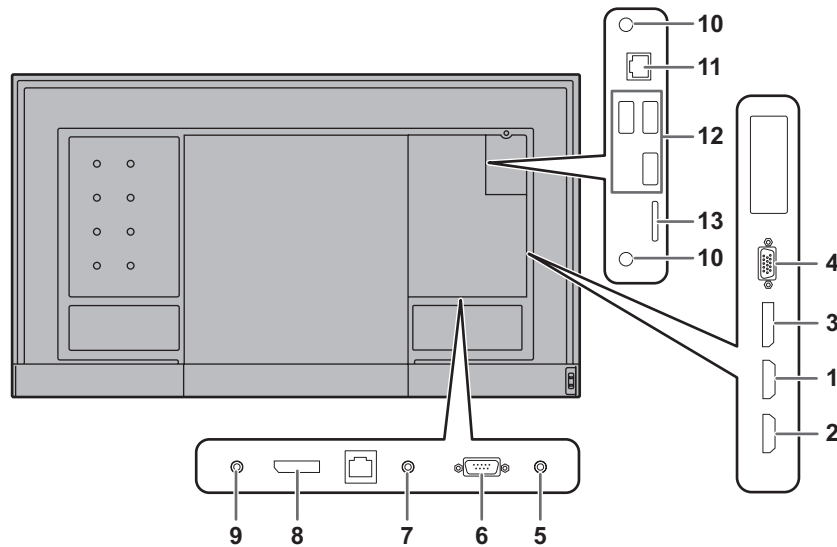

! Caution

- Be sure to turn off the main power switch and disconnect the plug from the power outlet before connecting/ disconnecting cables. Also, read the manual of the equipment to be connected.
- Be careful not to confuse the input terminal with the output terminal when connecting cables. Accidentally reversing cables connected to the input and output terminals may cause malfunctions and the other problems.
- Do not use any cable that has a damaged or deformed terminal. Using such cables may cause malfunctions.

TIPS

- Images may not be displayed properly depending on the computer (video card) to be connected.
- Use the automatic screen adjustment when a computer screen is displayed for the first time using D-SUB or when the setting of the computer is changed. The screen is adjusted automatically when SELF ADJUST in the MONITOR menu is set to ON.
- If the audio output from the playback device is connected directly to speakers or other devices, the video on the monitor may appear delayed from the audio portion. Audio should be played through this monitor by connecting the playback device to the monitor's audio input, and connecting the monitor's audio output to the speakers or other devices.
- The audio input terminals used in each input mode are factory-set as follows.

Input mode	Audio input terminal (Factory setting)
DisplayPort	DisplayPort input terminal
HDMI1	HDMI1 input terminal
HDMI2	HDMI2 input terminal
D-SUB	Audio input terminal

1. HDMI1 input terminal

2. HDMI2 input terminal

- Use a commercially available HDMI cable (conforming to the HDMI standard) that supports 4K.
- Select the audio input terminal to be used in AUDIO SELECT of the SETUP menu. When HDMI is selected, it is not necessary to connect an audio cable to the audio input terminal.

3. DisplayPort input terminal

- Use a commercially available DisplayPort cable (conforming to the DisplayPort standard) that supports 4K.
- Select the audio input terminal to be used in AUDIO SELECT of the SETUP menu. When DisplayPort is selected, it is not necessary to connect an audio cable to the audio input terminal.

4. D-sub input terminal

5. Audio input terminal

- Use an audio cable without resistance.
- Set the audio input terminal to be used in each input mode in AUDIO SELECT on the SETUP menu.

6. RS-232C input terminal

7. RS-232C output terminal*

- You can control the monitor from a computer by connecting a commercially available RS-232 straight cable between these terminals and the computer.
- * Use the supplied RS-232C conversion cable.

Connecting Peripheral Equipment

8. DisplayPort output terminal

- The screen displayed on this monitor and the audio output from this monitor can be output to an external device.
- Use a commercially available DisplayPort cable (conforming to the DisplayPort standard) that supports 4K.
- Outputting HDCP-encrypted video requires an external device which supports HDCP.
- This terminal can be used to make a daisy chain connection* by connecting same series monitors to each other through the DisplayPort input terminal of each monitor.

*: Up to 4 monitors.

TIPS

- The length of the signal cables or surrounding environment may affect the image quality.
- The output screen may not be displayed properly. In this case, turn off the power to all the monitors connected in a daisy chain and then turn the power on again.
- When connecting monitors in a daisy chain set NO SIGNAL AUTO INPUT SEL. to OFF.
- Video output is disabled in the following cases:
 - When the power is turned off.
 - When the monitor is in input signal waiting mode.
- This terminal does not support HDR signals.
 - The output device's screen will not be displayed properly.

9. Audio output terminal

- The output sound varies depending on the input mode.
- The volume of the output sound can be fixed by setting AUDIO OUTPUT of AUDIO OPTION on the SETUP menu.
- It is not possible to control the sound output from the audio output terminals with the AUDIO menu.

10. Wireless LAN antenna terminal

- Attach the supplied wireless LAN antennas.

11. LAN terminal

- You can control the monitor from a computer on a network by connecting a commercially available LAN cable between this terminal and a network.

12. USB port

- This is used in APPLICATION mode. For details, see the Software Guide.

13. microSD card slot

- This is used in APPLICATION mode. For details, see the Software Guide.

Connecting the Power Cord

! Caution

- Use only the power cord supplied with the monitor.
1. Turn off the main power switch.
 2. Plug the power cord (supplied) into the AC input terminal.
 3. Plug the power cord (supplied) into the power outlet.

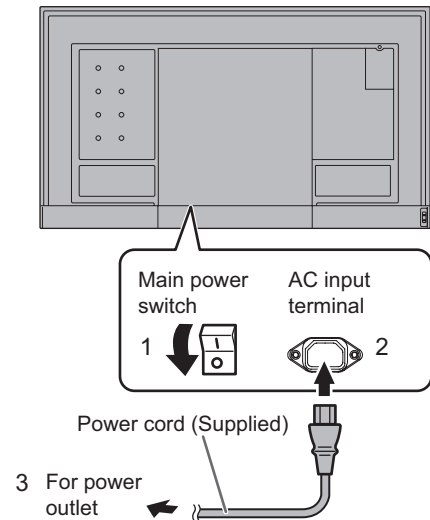

Binding Cables

The supplied cable clamps can be used to clamp the power cord and cables connected to the back of the monitor.

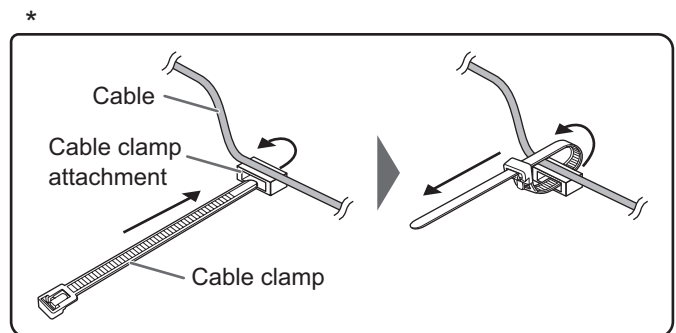
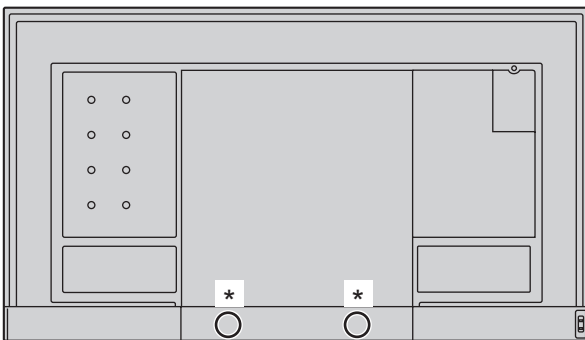

Attach the supplied cable clamps (affixing type) to a flat surface, removing any dust or dirt before attaching. Do not attach over a vent.

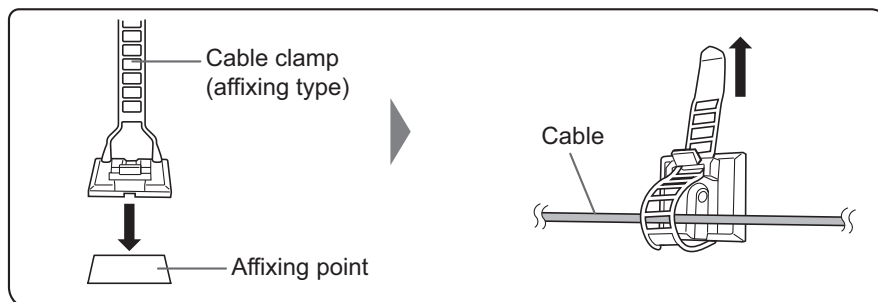

Removing the Handles

The handles can be removed.

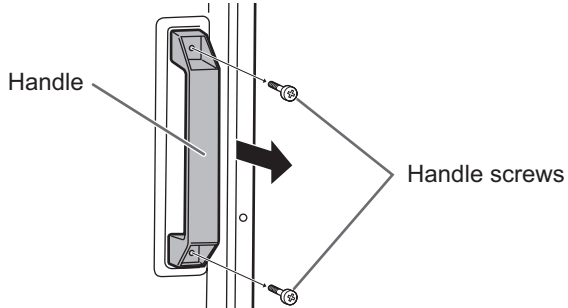

! Caution

- The removable handles and handle screws are for use with this monitor. Do not use them for any other devices.
- To attach handles, be sure to use the handles and handle screws which were removed from this monitor.
- Be sure the handles are attached securely.

Attaching the logo sticker

You can attach the supplied logo sticker on this monitor.
Refer to the following example to attach the sticker as necessary.

Example for landscape orientation

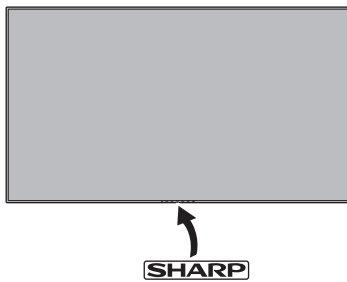

Example for portrait orientation



Attaching the USB flash drive / SD card cover

1. Attach the USB flash drive / SD card cover (supplied) to this monitor.

USB flash drive / SD card cover (supplied)

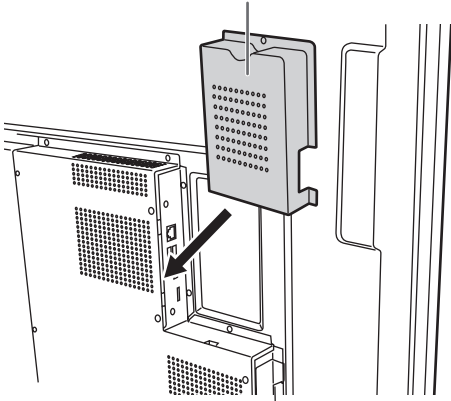

TIPS

- If the cover will be attached, use a USB flash drive no larger than 2-3/4 inch (70 mm) (L) (excluding the terminal) x 11/16 inch (17 mm) (W) x 5/16 inch (8 mm) (H).

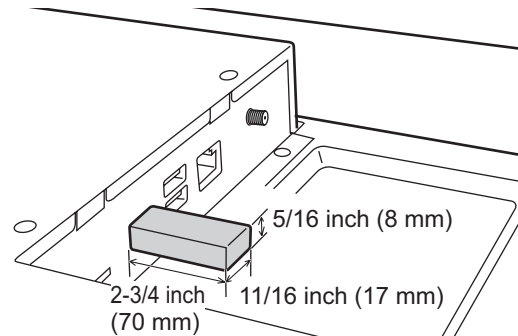

2. Secure the cover using USB flash drive / SD card cover fixing screw (supplied).

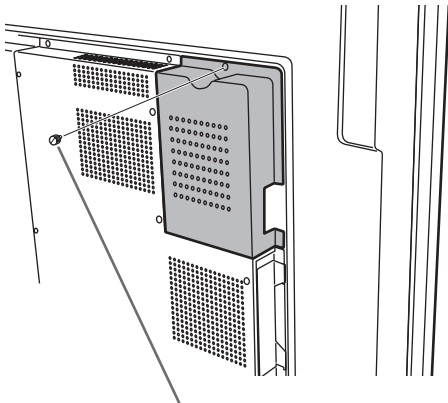

USB flash drive / SD card cover fixing screw (supplied)

Attaching the wireless LAN antenna

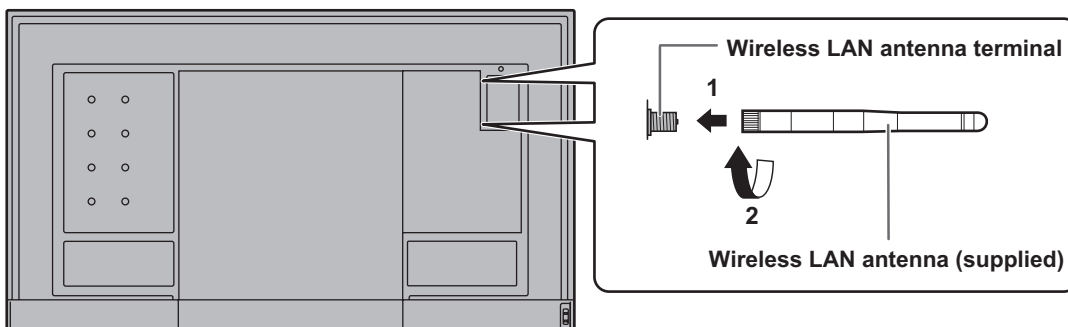

Preparing the Remote Control Unit

Installing the batteries

1. Place your finger on the part marked with the ▲, and then pull the cover off.

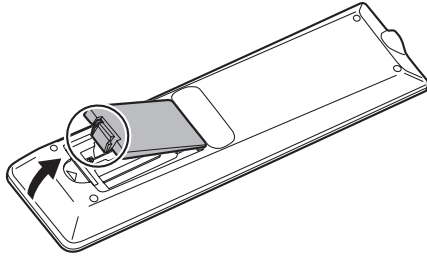

2. See the instructions in the compartment and put in the supplied batteries (R03 ("AAA" size) x 2) with their plus (+) and minus (-) sides oriented correctly.
3. Close the cover.

TIPS

- When the batteries become exhausted, replace them with new (commercially available) batteries.
- The supplied batteries may become exhausted quickly depending on how they are stored.
- If you will not be using the remote control for a long time, remove the batteries.
- Use manganese or alkaline batteries only.

Remote control operation range

Remote control sensor in

The remote control can be operated even when the remote control sensor is stored inside the monitor.

Point the remote control unit toward the remote control sensor on the bottom of the monitor (or the right side of the monitor if using portrait orientation).

For the monitor in landscape orientation

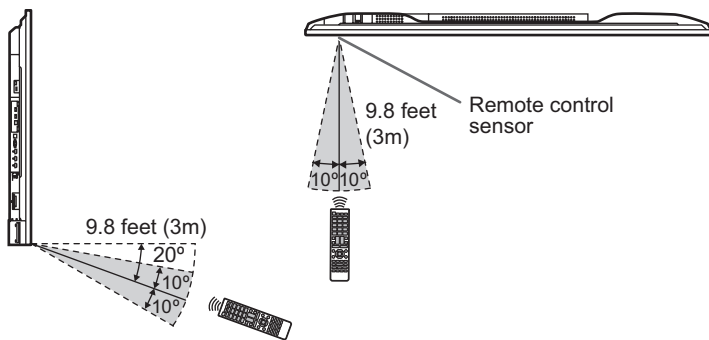

For the monitor in portrait orientation

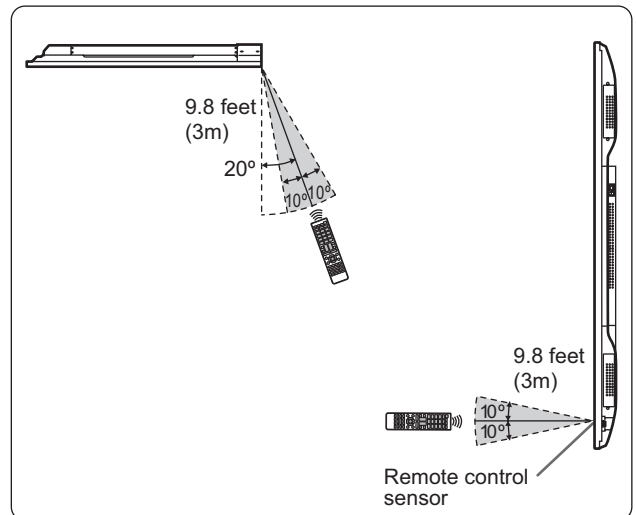

Remote control sensor out

Point the remote control unit toward the remote control sensor on the front of the monitor.

For the monitor in landscape orientation

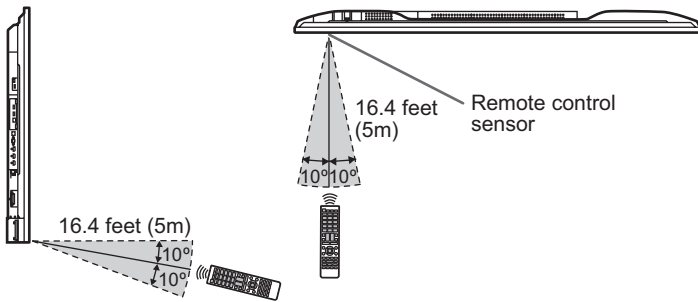

For the monitor in portrait orientation

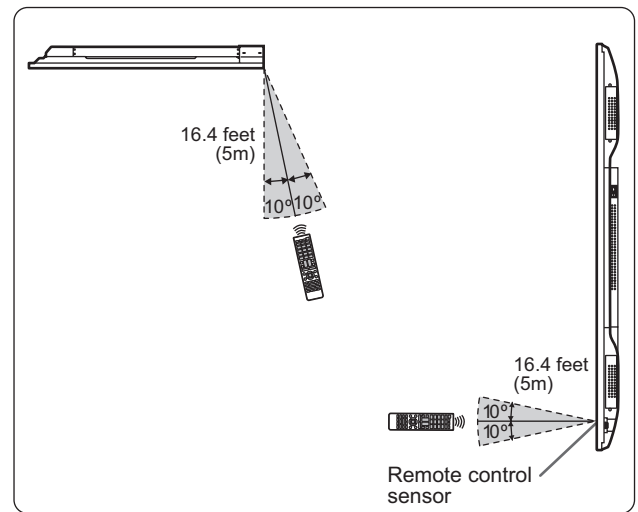

TIPS

- Do not expose the remote control unit to shock by dropping or stepping on it. This could lead to a malfunction.
- Do not expose the remote control unit to liquids, and do not place it in an area with high humidity.
- The remote control unit may not work properly if the remote control sensor is under direct sunlight or strong lighting.
- Objects between the remote control unit and the remote control sensor may prevent proper operation.
- Replace the batteries when they run low as this may shorten the remote control's operation range.
- If a fluorescent light is illuminated near the remote control unit, it may interfere with proper operation.
- Do not use it with the remote control of other equipment such as air conditioner, stereo components, etc.

Turning Power On/Off

! Caution

- Turn on the monitor first before turning on the computer or playback device.
- When switching the main power switch or the POWER button off and back on, always wait for at least 5 seconds. A short interval may result in a malfunction.

Turning on the main power

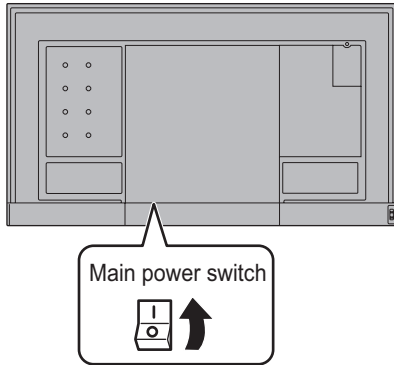

! Caution

- The main power must be turned on/off with the main power switch. Do not connect/disconnect the power cord or turn the breaker on/off while the main power switch is on.
- For a complete electrical disconnection, pull out the main plug.

Turning power on/off

Press the POWER button to turn the power ON/OFF. You can also turn the power ON/OFF by pressing the MONITOR ON button/MONITOR OFF button on the remote control unit.

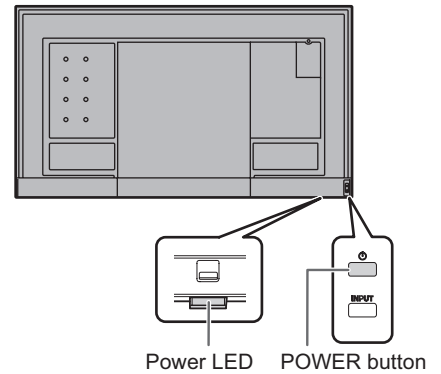
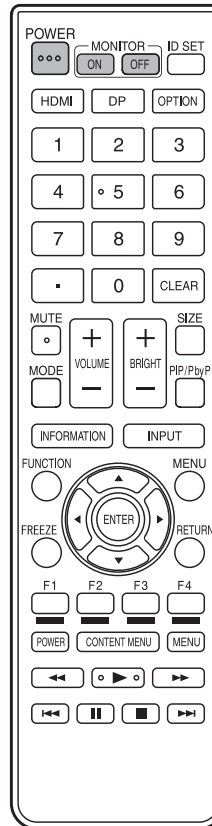

Status	Status of the monitor
Green lit	Power on
Orange lit	Power off (Standby mode)
Green flashing	Input signal waiting mode

TIPS

- When the main power switch is off, the monitor cannot be turned on.
- If the monitor is in the input signal waiting mode and you press the POWER button or MONITOR OFF button, the monitor enters standby mode.
- Setting the SCHEDULE flashes the power LED alternately in red and orange in standby mode.
- To disable the logo screen from displaying when turning the power ON, set LOGO SCREEN to OFF on the OTHERS menu. (See page 31.)
- You can fix the input mode that appears after startup. Set START INPUT MODE on the SETUP menu. (See page 28.)

Operations after first power-on

Set POWER SAVE MODE

When the monitor is turned on for the first time after being shipped from the factory, the power save mode setting screen will be displayed. Set it to YES or NO.

YES POWER SAVE MODE is set to ON. Current consumption is reduced while the monitor is in standby mode. Android is also shut down. Note, however, that the startup time from standby mode becomes longer.

NO POWER SAVE MODE is set to OFF. Startup time from standby mode is reduced. Note, however, that more power will be consumed in standby mode. Android continues to run in standby mode.

Even after being set, you can change the POWER SAVE MODE. (See page 29.)

Set the date/time

The date/time setting screen appears.

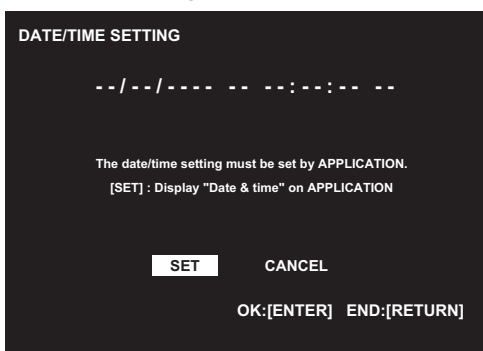

1. Select "SET".

The input mode changes to APPLICATION, and the "Date & time" screen appears.

2. Select "Set date".

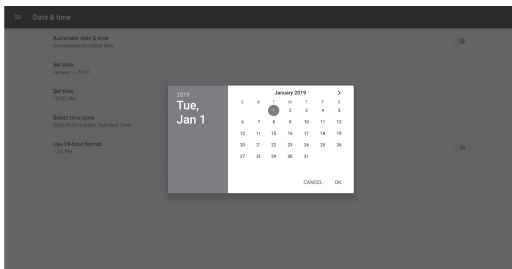

3. Set the date and select "OK".

The "Date & time" screen appears.

4. Select "Set time".

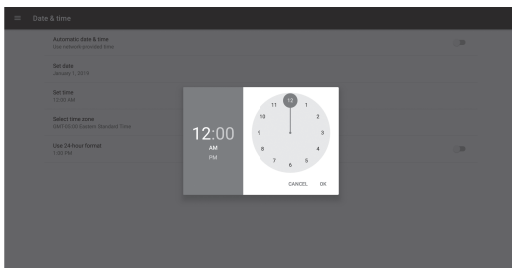

5. Set the time and select "OK".

The "Date & time" screen appears.

6. Press the RETURN button on the remote control unit.

The "Select a Home app" screen appears.

7. Select "Launcher:SHARP Open Architecture Platform".

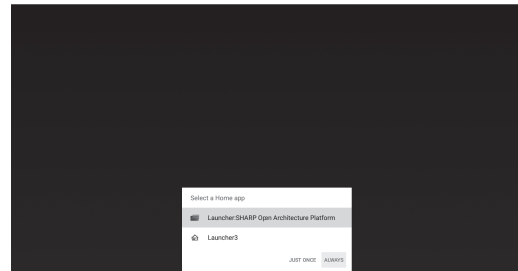

8. Select "ALWAYS".

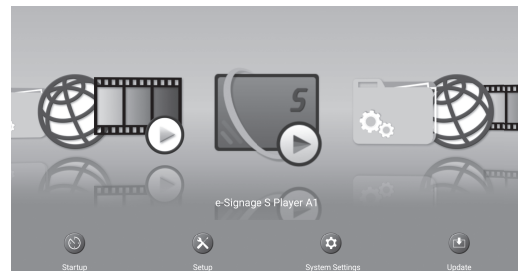

This is the base screen (CONTENT MENU screen) when the input mode is APPLICATION. For information on APPLICATION mode, see the Software Guide.

- Be sure to set the date and time.

TIPS

- When "Select a Home app" screen appears, select "Launcher:SHARP Open Architecture Platform", and select "ALWAYS".
- The clock is maintained by the internal battery.
- If you already set the time but the date/time setting screen appears when the power is turned on, the internal battery may be exhausted. After replacing the internal battery, set the date and time as explained in step on the left.
- Please contact an authorized SHARP servicing dealer or service center for assistance with internal battery replacement.
- Estimated service life of the internal battery: About 5 years (depending on monitor operation)
- The initial battery was inserted at the factory when the monitor was shipped, so it may run out of power before its expected operation life.

Disabling power on/off operations

Power on/power off operations can be disabled in order to protect the monitor from an accidental power off. Set the ADJUSTMENT LOCK in FUNCTION menu to ON 2. (See page 36.)

Basic Operation

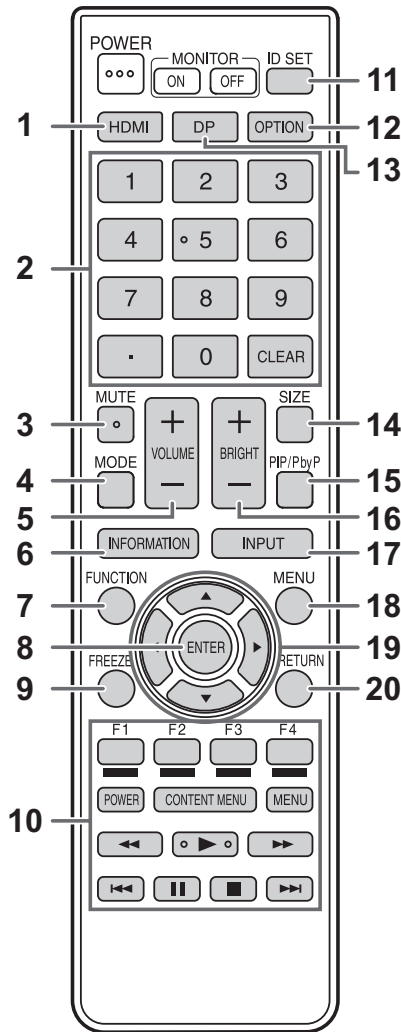

1. HDMI

Switch the input mode to HDMI1 or HDMI2.

2. Numeric input buttons

0 to 9 are also used in conjunction with the ID SET button.

3. MUTE

Turns off the volume temporarily.

Press the MUTE button again to turn the sound back to the previous level.

4. MODE (Color mode selection)

Each time you press this button, the color mode changes in the following order:

STD (Standard) → VIVID → sRGB → HIGH ILLUMINANCE → STD...

- HIGH ILLUMINANCE is a display with colors suited to bright locations.
- sRGB is international standard of color representation specified by IEC (International Electrotechnical Commission). Color conversion is made in taking account of liquid crystal's characteristics and represents color tone close to its original image.

5. VOLUME +/- (Volume adjustment)

Pressing + or - displays the VOLUME menu.



Press + or - to adjust the volume.

* If you do not press any buttons for about 4 seconds, the VOLUME menu automatically disappears.

6. INFORMATION

Displays monitor information.

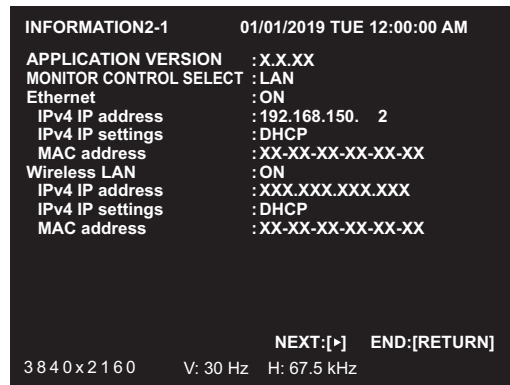
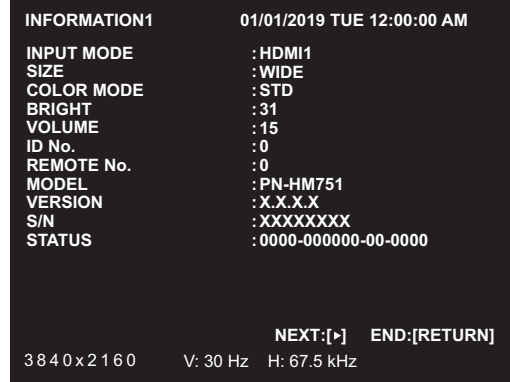

The display changes from INFORMATION1 → INFORMATION2-1 → INFORMATION2-2 → INFORMATION3 → clear display, and so on every time you press this button. When displaying INFORMATION, the display changes from INFORMATION1 → INFORMATION2-1 → INFORMATION2-2 → INFORMATION3 → INFORMATION1, and so on every time you press the ► button.

Pressing the RETURN button disappears the display.

- INFORMATION3 shows the information when you have used the expansion slot to expand the functions.
- The display disappears automatically after about 15 seconds.

7. FUNCTION

Use this to display the FUNCTION menu. (See page 36.)

8. ENTER

Confirms the setting.

9. FREEZE

Freezes the video shown on the monitor.
 To cancel, press any button other than the POWER button, MUTE button or VOLUME button.
 Freeze is also canceled when the input signal changes (switching to no signal, changing the resolution, etc.).
 In some cases a residual image may occur. Do not freeze the video for a long time.

10. Buttons for APPLICATION mode

Buttons for operating the HDMI-connected device

This is used in APPLICATION mode. For details, see the Software Guide.

When HDMI CEC LINK is set to AUTO, you can operate devices that support HDMI CEC in modes other than APPLICATION mode.

CONTENT MENU button

Operation when the input mode is other than APPLICATION depends on the settings.

- When HDMI CEC LINK is OFF
 - The input mode changes to APPLICATION.
- When HDMI CEC LINK is AUTO and the CONTENT MENU BUTTON is SWITCH TO APPLICATION
 - The input mode changes to APPLICATION.
- When HDMI CEC LINK is AUTO and the CONTENT MENU BUTTON is CEC
 - Operate devices that support HDMI CEC.

11. ID SET

Set a number on the remote control unit. (See page 35.)

12. OPTION

Switch the input mode to APPLICATION.
 When using the expansion slot to expand the functions, input mode change alternately between APPLICATION and OPTION.

13. DP (DisplayPort)

Switch the input mode to DisplayPort.

14. SIZE (Screen size selection)

The menu is displayed.
 Press the ▲ or ▼ button to select the screen size. (See page 22.)

15. PIP/PbyP

The menu is displayed.
 Press the ▲ or ▼ button to select PIP MODES/ QUAD-SCREEN MODE. (See page 32.)

16. BRIGHT +/- (Brightness adjustment)

Pressing + or - displays the BRIGHT menu.



Press + or - to adjust the brightness.

- * If you do not press any buttons for about 4 seconds, the BRIGHT menu automatically disappears.

17. INPUT (Input mode selection)

The menu is displayed.

Press the ▲ or ▼ button to select the input mode, and press the ENTER button to enter.

In APPLICATION mode, you can use Android applications. For details of APPLICATION mode, see the Software Guide.

- * You can change the input mode by pressing the INPUT button of the monitor.

Input mode	Video	Audio
APPLICATION	APPLICATION	APPLICATION
DisplayPort	DisplayPort input terminal	*2
HDMI1	HDMI1 input terminal	
HDMI2	HDMI2 input terminal	
D-SUB	D-sub input terminal	Audio input terminal
OPTION*1	Expansion slot	*2

*1 This is displayed when you have used the expansion slot to expand the functions.

*2 Select the terminal for AUDIO SELECT which is used for audio input. (See page 27.)

18. MENU

Displays and turns off the menu screen. (See page 23.)

19. Cursor

These buttons are used to perform operations such as selecting items, changing adjustment values, and moving the cursor.

20. RETURN

Returns to the previous screen.

Basic Operation

■ Switching the screen size

Even when the screen size is changed, the display may remain the same depending on the input signal.

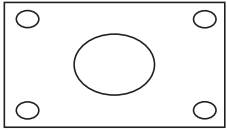
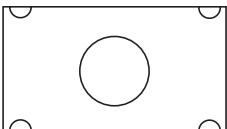
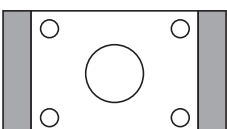
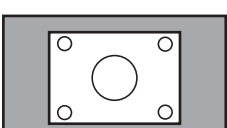
WIDE		Displays image so it fills the entire screen.
ZOOM		The image is enlarged to fill the entire screen without changing the aspect ratio. The edges of the image may be cut off.
NORMAL		Displays the image so it fills the screen without changing the aspect ratio.
Dot by Dot		Displays the dots of the input signals as the corresponding dots on the screen.

TIPS

- Using this monitor's screen-size switching function to compress or expand the screen for commercial or public viewing in establishments like cafes or hotels may infringe on the rights of the creators, as protected by Copyright Law, so please be careful.
- When ENLARGE is set to ON, the screen size is fixed to WIDE mode.
- When dual-screen or quad-screen display is selected, the screen size cannot be changed.
- The appearance of the original video may change if you select a screen size with a different aspect ratio than the original image (e.g. TV broadcast or video input from external equipment).
- When 4:3 video is viewed with the whole screen using the screen-size switching function of this monitor, the edge of the video may be lost or appear distorted. If you wish to respect the creator's intentions, set the screen size to NORMAL.
- When playing commercial software, parts of the image (like subtitles) may be cropped. In this case select the optimal screen size using the screen-size switching function of this monitor. With some software, there may be noise or distortion at the edges of the screen. This is due to the characteristics of the software, and is not a malfunction.
- Depending on the original video size, black bands may remain at the edges of the screen.

Menu Items

Displaying the menu screen

Video and audio adjustment and settings of various functions are enabled. This section describes how to use the menu items. See page 24 for details of each menu items.

! Caution

- Do not turn the main power switch off while the menu items are being displayed. Doing so may initialize the settings.

TIPS

- Also check the time setting, network settings, and other settings in the Software Guide.

Example of operation

(Adjusting CONTRAST in the PICTURE menu)

- Press the **MENU** button to display the menu screen.

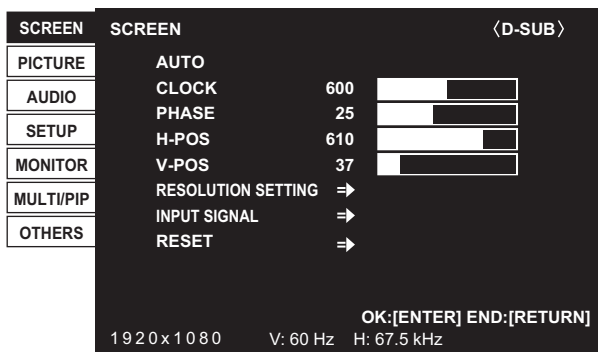

- Press the **▲** or **▼** button to select **PICTURE**, and press the **ENTER** button.

- Press the **▲** or **▼** button to select **CONTRAST**.

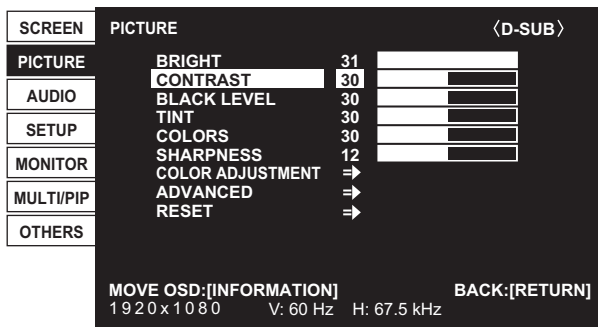

- Press the **◀** or **▶** button to adjust the setting.

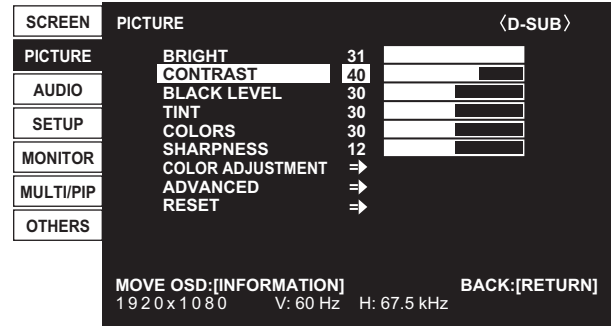

For items that have **⇒**, press the **ENTER** button to display the sub menu.

- Press the **MENU** button to close the menu screen.

TIPS

- The menu will differ depending on the input mode.
- The menu screen will close automatically if no operation is performed for about 15 seconds. (SCHEDULE screen will close in about 4 minutes.)

Menu screen display

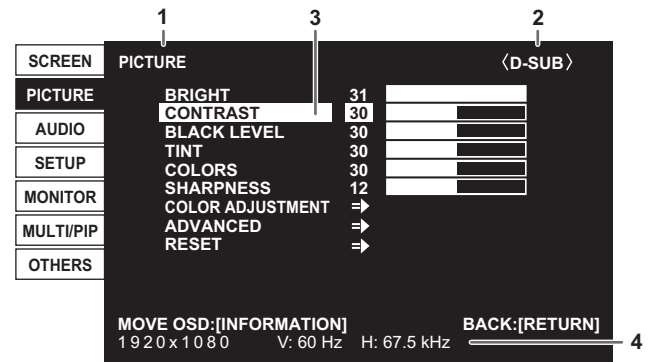

- Name of the menu
- Input mode
- An item being selected (highlighted)
- Screen resolution of input signal, and other data.

TIPS

- Items that cannot be selected appear in gray. (e.g. Function not supported by the current input signal)

Menu item details

The menu will differ depending on the input mode.

■SCREEN

You can move the menu screen display position each time the INFORMATION button is pressed.

AUTO (D-SUB)

The CLOCK, PHASE, H-POS, and V-POS are automatically adjusted.

Pressing the ENTER button performs adjustment. Use this automatic adjustment when you use the D-SUB to display a computer screen for the first time or when you change the setting of the computer. (See page 35.)

CLOCK (D-SUB)

Adjusts frequency for sampling clock for applicable video.

Adjust when there is flickering in the form of vertical stripes.

When using the adjustment pattern (see page 35), make adjustments so that no vertical stripe noise appears in it.

PHASE (D-SUB)

Adjusts sampling clock phase for applicable video. Useful when small characters appear with low contrast and/or there are flickers at corners. When using the adjustment pattern (see page 35), make adjustments so that no horizontal stripe noise appears in it.

* Adjustments to PHASE should be made only after CLOCK has been correctly set.

H-POS (D-SUB)

Adjust the horizontal position of the image.

V-POS (D-SUB)

Adjust the vertical position of the image.

RESOLUTION SETTING (D-SUB)

H-RESOLUTION

Sets proper horizontal resolution when the resolution of input signals is not recognized properly.

(Adjustment may be impossible with some signals.)

V-RESOLUTION

Sets proper vertical resolution when the resolution of input signals is not recognized properly.

(Adjustment may be impossible with some signals.)

INPUT SIGNAL (D-SUB)

If the resolution of the computer is one of the following, make a selection from the following options.

480 LINES AUTO, 640x480 or 848x480

768 LINES AUTO, 1024x768, 1280x768 or 1360x768

1050 LINES 1400x1050 or 1680x1050

RESET

Resets the values of the SCREEN menu items to the factory default settings.

Select ON and then press the ENTER button.

PICTURE

You can move the menu screen display position each time the INFORMATION button is pressed.

BRIGHT

Adjusts the backlight brightness.

CONTRAST

Adjusts the difference between the bright and dark portions of the image.

BLACK LEVEL

Adjusts the entire brightness of the video signals.

TINT

Adjusts the hue. Selecting + changes the color towards green, and selecting - changes it towards magenta.

COLORS

Adjusts the color intensity.

SHARPNESS

Adjusts the sharpness of the image.

COLOR ADJUSTMENT**COLOR MODE**

Changes the color mode on the screen. The color mode on the screen can also be changed using a remote control unit. (See page 20 for details.)

WHITE BALANCE

THRU Displays the input signal level as is.

PRESET Selects the color temperature using PRESET.

USER Adjusts R-/G-/B-CONTRAST and R-/G-/B-OFFSET respectively using USER.

PRESET

Selects the color temperature when the WHITE BALANCE is set to PRESET.

The setting values are shown for reference. The color temperature of the screen varies over time. This function is not intended to keep the color temperature constant.

USER

Adjusts each item when the WHITE BALANCE is set to USER.

R-CONTRAST Adjusts bright-toned red component.

G-CONTRAST ... Adjusts bright-toned green component.

B-CONTRAST Adjusts bright-toned blue component.

R-OFFSET Adjusts dark-toned red component.

G-OFFSET Adjusts dark-toned green component.

B-OFFSET Adjusts dark-toned blue component.

COPY TO USER

Copies the value of white set for PRESET to the USER setting.

Select ON and then press the ENTER button.

(In the case other than white, color tone may differ from the PRESET.)

GAMMA

Selects the gamma.

C.M.S.-HUE

Adjusts color tone with 6 colors of R (red), Y (yellow), G (green), C (cyan), B (blue), and M (magenta).

C.M.S.-SATURATION

Adjusts color vividness with 6 colors of R (red), Y (yellow), G (green), C (cyan), B (blue), and M (magenta).

Menu Items

ADVANCED

AUTO (D-SUB)

The ANALOG GAIN and ANALOG OFFSET are automatically adjusted.
Pressing the ENTER button performs adjustment.

ANALOG GAIN (D-SUB)

Adjusts the bright portions of the video input signal.

ANALOG OFFSET (D-SUB)

Adjusts the dark portions of the video input signal.

NR

Reduce the image noise.
Setting a higher level reduces more noise. However, it may cause blurring on an image.

RGB INPUT RANGE

Sets the RGB input signal range.
When using HDMI, DisplayPort or OPTION set to AUTO, the RGB input signal range is detected automatically. Use AUTO normally.
If the RGB input signal range cannot be set appropriately even when using AUTO, set according to the image. When the setting is different, images will be displayed with washed out blacks and compressed gradients.

DISPLAY COLOR PATTERN

Displays a color pattern. Can be displayed while the menu screen is displayed, so you can refer to the pattern while adjusting the image. When WHITE, RED, GREEN, or BLUE is displayed, you can set the level in the range of 0 to 255.

OFFNo pattern display.

WHITE.....White single color pattern display.

RED.....Red single color pattern display.

GREENGreen single color pattern display.

BLUE.....Blue single color pattern display.

USERRed/green/blue mixed color pattern display. When USER is selected, set each color's level.

HDR (HDMI)

To play content that supports HDR, select ON and set HDMI MODES to MODE1.
If HDMI MODES is set to MODE2, content that supports HDR cannot be played.
To make the setting effective, you must restart this monitor.

RESET

Resets the values of the PICTURE menu items to the factory default settings.
Select ON and then press the ENTER button.

■AUDIO

TREBLE

Adjusts the volume of treble-level sound.

BASS

Adjusts the volume of bass-level sound.

BALANCE

Adjusts the balance of the audio sound between right and left.

RESET

Resets the values of the AUDIO menu items to the factory default settings.
Select ON and then press the ENTER button.

■SETUP**DATE/TIME SETTING**

Display the date and time.

When select SET, input mode change to APPLICATION, and you can set the date and time.

When APPLICATION is set to DISABLE, SET does not appear. Set in the displayed screen.

TIME FORMAT (when APPLICATION is ENABLE)

Set the time display format.

Select the display format, and select SET.

DATE/TIME FORMAT (when APPLICATION is DISABLE)

Set the date/time display format.

SCHEDULE (See page 34.)

You can turn the power on/off and change the screen brightness at a specified time.

LANGUAGE

Set the display language for the menu screen.

INPUT SELECT**DisplayPort STREAM**

Set how DisplayPort is used.

If a device that do not support DisplayPort1.2 is connected, set to SST1.

SST1Use as single stream (DisplayPort1.1).

SST2Use as single stream (DisplayPort1.2).

HDMI MODES

HDMI MODES settings change how the content displayed is processed and decoded.

MODE1 is default and will support most common color spaces and other encoding signals.

MODE2 should be used for YCbCr 4:2:0 at 4K Vsync 50/60Hz signals or when non 4K devices are connected and content onscreen are not what is expected.

CEC SETTING**HDMI CEC LINK**

AUTO HDMI CEC function is used.

If the device connected to the HDMI input terminal supports CEC, the input mode of the monitor changes to HDMI when playback starts on the device.

Set the operation of the CONTENT MENU button with CONTENT MENU BUTTON.

OFF HDMI CEC function is not used.

When the input mode is other than APPLICATION, the input mode changes to APPLICATION when the CONTENT MENU button is pressed.

AUTO POWER ON

This can be set when HDMI CEC LINK is set to AUTO.

If the device connected to the HDMI input terminal supports CEC, you can specify whether or not the monitor power turns on when the device power is turned on.

CONTENT MENU BUTTON

This can be set when HDMI CEC LINK is set to AUTO.

Set the operation of the CONTENT MENU button in other than APPLICATION mode.

CEC..... Operates as an HDMI CEC function button.

SWITCH TO APPLICATION..... Changes the input mode to APPLICATION.

AUDIO SELECT

Selects the terminal used to input audio signals in each input mode.

Menu Items

AUDIO OPTION

AUDIO OUTPUT

Sets the volume of sound output from the audio output terminal.

VARIABLE1 You can adjust the volume from the speakers of this monitor and the audio output terminal simultaneously by using VOLUME.

VARIABLE2 You can adjust the volume from the audio output terminal by using VOLUME.
Sound will not be output from the speakers of this monitor.

FIXED Fixes the volume from the audio output terminal. Adjust the volume by using an external device.

AUDIO INPUT LEVEL

Selects the maximum audio input level of the audio input terminal.

MONAURAL AUDIO

Outputs audio signals as monaural.

START INPUT MODE

You can set the input mode that will be in effect when the power is turned on.

When this is set to LAST INPUT MODE, the input mode when the power was last turned off will appear.

* When NO SIGNAL AUTO INPUT SEL. is ON and there is no input signal in the set input mode, the input mode will change to the input mode that has an input signal.

COMMUNICATION SETTING

MONITOR CONTROL SELECT (when APPLICATION is ENABLE)

RS-232C Select to control this monitor by RS-232C.

LAN Select to control this monitor by LAN.

APPLICATION.... Select to control from the application of APPLICATION mode, such as e-Signage.

BAUD RATE

Selects the communication speed used for RS-232C communication.

ID SETTING

ID No. SET

Assigns ID numbers to monitors connected in a daisy chain (see page 38), using the RS-232 cables.

The numbers 1 to 255 are available for ID numbers.

If "0" is set, the system regards this as the state where no ID number is set.

AUTO ASSIGN ID No.

ID No. to be used will be automatically assigned when multiple monitors are connected with RS-232C.

Select ON, then press the ENTER button.

Perform operations using the first monitor in the daisy chain.

REMOTE No.

Sets the number of the remote control unit. (See page 35.)

■ MONITOR

PORTRAIT/LANDSCAPE INSTALL

LANDSCAPE Landscape orientation

PORTRAIT Portrait orientation

HORIZONTAL INSTALLATION

OFF Portrait/landscape installation.

FACE UP The display screen faces up.

ROTATE 180°

If video is upside down when the monitor is installed in portrait orientation, you can rotate the video 180 degrees.

Interlaced signals may not be displayed properly.

OSD H-POSITION

Adjusts the horizontal display position of menu screen.

OSD V-POSITION

Adjusts the vertical display position of menu screen.

POWER SAVE MODE

When OFF is selected, startup time from standby mode is reduced. Note, however, that more power will be consumed in standby mode. Android continues to run in standby mode.

When ON is selected, current consumption is reduced while the monitor is in standby mode. Android is also shut down. Note, however, that the startup time from standby mode becomes longer.

If set to ON, certain RS-232C commands and LAN control cannot be used in standby mode. (See pages 38 and 49.)

OFF IF NO OPERATION

Determines whether or not to set the monitor to go into standby mode when there is no operation from the remote control unit or RS-232C commands.

When the setting is ON, set the time until standby mode is entered in TIME.

POWER ON DELAY

When ON is set, you can delay the screen display after the monitor is turned on.

When ON is selected, set the delay time with INTERVAL (interval can be set up to 60 seconds in units of 1 second).

When this function is activated, the power LED flashes (at approx. 0.5 second interval) in green.

SELF ADJUST

On a D-SUB screen, specify whether to perform screen adjustment automatically or not.

When ON is selected, the screen is automatically adjusted when its resolution is 800 x 600 or higher and the timing of input signals changes and other cases. "ADJUSTING" appears on the screen during the adjustment.

If SELF ADJUST is set to ON, set the time it takes to start the SELF ADJUST function in START TIMING.

For images with black edges, etc., depending on the signal, adjustment may not be possible. In this case select OFF. (Perform manual adjustment of the screen.)

■MULTI/PIP**MULTI****ENLARGE (See page 33.)**

Sets whether or not to use the enlarge function.

ADVANCED (ENLARGE)

ENLARGE H / ENLARGE V

.....Sets the number of screen splits (number of monitors) in the horizontal/vertical direction used for the enlargement.

ENLARGE-POS

.....Specify the split screen to be displayed when the enlargement function is used.

H-POS / V-POS

.....Adjust the horizontal/vertical position of the enlarged screen.

BEZEL ADJUST

Sets whether or not to use the frame correction function.

ADVANCED (BEZEL ADJUST)

BEZEL ADJUST (TOP) / BEZEL ADJUST (BOTTOM) / BEZEL ADJUST (RIGHT) / BEZEL ADJUST (LEFT)

.....Adjusts so that the top/bottom/left/right connecting joints of grouped units will be displayed smoothly when a group of monitors are aligned in multiples to display a single image.

BEZEL (TOP) / BEZEL (BOTTOM) / BEZEL (RIGHT) / BEZEL (LEFT)

.....Sets the frame width of the display.

Menu Items

PIP/PbyP

PIP MODES

Sets the display method.

OFF Displays one screen.

PIP Displays a sub screen inside a main screen.

PbyP Displays a main screen and a sub screen in a line.

PbyP2 Displays a main screen which measures 2560 pixels in the longest direction and a sub screen in a line.

PIP SIZE

Sets the size of the sub screen in PIP mode.

PIP H-POS

Adjusts the horizontal position of the sub screen in PIP mode.

PIP V-POS

Adjusts the vertical position of the sub screen in PIP mode.

PIP BLEND

In PIP mode, use this menu item to display the sub screen transparently.

PIP SOURCE

Selects the input signal of the sub screen in PIP, PbyP or PbyP2 mode.

SOUND CHANGE

Sets the sound which is output in PIP, PbyP or PbyP2 mode.

MAIN POS

Sets the position of the main screen in PbyP or PbyP2 mode.

PbyP2 POS

Sets the position of the sub screen in PbyP2 mode.

CONFIGURE QUAD-SCREEN

QUAD-SCREEN MODE

Set how the screens are displayed.

OFF Display single screen.

ON Display 4 screens simultaneously.

SETTING INITIAL SCREEN

Set the input mode displayed in each of the 4 screens.

When AUTO is selected, input modes that have input signals are displayed in the order set in PRIORITY: AUTO INPUT SEL..

PRIORITY: AUTO INPUT SEL.

Set the order of priority for the input mode that is displayed when AUTO is selected for SETTING INITIAL SCREEN.

The lower the number, the higher the priority.

SAVE LAST INPUT CONFIG.

OFF When quad-screen display is started, the 4 screens set in SETTING INITIAL SCREEN always appear.

ON When quad-screen display is started, the previously displayed 4 screens appear.

TARGET: SOUND / INPUT SEL.

When quad-screen is displayed, you set the screen whose audio is output, and the screen whose input is changed.

When you return to single screen display, the input mode will return to the input mode set here.

RECONFIGURE QUAD-SCREEN

Displays 4 screens again according to SETTING INITIAL SCREEN setting.

This can be set when QUAD-SCREEN MODE is set to ON.

INPUT SIGNAL INFO.

This shows the input mode, resolution, and frequency of the displayed screens.

■ OTHERS

POWER MANAGEMENT

POWER MANAGEMENT determines whether or not to switch modes from no signal to the input signal waiting mode.

CONNECT AUTO INPUT SELECT

Sets whether the input into the input terminal automatically changes when a video signal is input into that terminal. The input via the expansion slot is ignored.

(With some input signals, the input may not change.)

NO SIGNAL AUTO INPUT SEL.

Specify whether to change inputs automatically. When ON is selected and no signal is present in the selected input mode, the monitor automatically changes the selected mode to another mode where a video signal is present.

When there are video signals in multiple input modes, switching takes place according to the order of priority set in AUTO INPUT SELECT PRIORITY.

AUTO INPUT SELECT PRIORITY

Sets the order of input terminal priority for NO SIGNAL AUTO INPUT SEL..

When an option that supports this function is connected to the expansion slot, you can set the order in OPTION.

(If the option does not support this function, "OPTION" will not appear.)

Input does not change automatically for terminals without a priority setting.

The lower the number, the higher the priority.

LOGO SCREEN

Sets whether or not to display the logo screen.

VOLUME

Adjusts the volume.

MUTE AUDIO

Temporarily mutes the audio.

MUTE WITH FREEZE

Set whether or not audio turns off during freeze.

BACKLIGHT OFF

When set to ON, the backlight turns off. Audio does not turn off.

TIPS

- When WHITE BALANCE is set to THRU, BLACK LEVEL, CONTRAST, TINT, COLORS, GAMMA, C.M.S.-HUE, C.M.S.-SATURATION, and COPY TO USER cannot be set.
- If COLOR MODE is set to sRGB, the following items cannot be set. WHITE BALANCE, PRESET, USER, COPY TO USER, and GAMMA
- When the COLOR MODE is set to VIVID or HIGH ILLUMINANCE, GAMMA cannot be adjusted.
- When displaying the color pattern, it is possible to adjust certain items of the PICTURE menu. Non-adjustable items cannot be selected.
- When the input signal is HDR signal, GAMMA, COLOR MODE and BRIGHT cannot be adjusted.

■Dual-screen display

You can display two screens simultaneously. Set this function with PIP MODES of PIP/PbyP in the MULTI/PIP menu. Or, press the PIP/PbyP button, and select the mode.

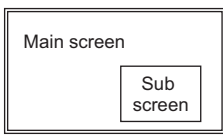
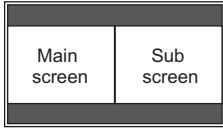
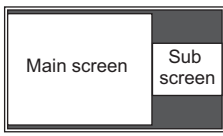
PIP		A sub screen is displayed inside a main screen.
PbyP		A main screen and a sub screen are displayed in a line.
PbyP2		Displays a main screen which measures 2560 pixels in the longest direction and a sub screen in a line.

- * The currently selected input signal is displayed on the main screen.
- * The following combination is not available for display. HDMI1 - OPTION

TIPS

- You might infringe on a copyright of the author which is protected by copyright law when you display the images of the computer screen and television/VCR simultaneously for profit-making or to show the image to the public.
- The screen size for dual-screen display is the same as the screen size for single-screen display. The Dot by Dot screen is displayed in NORMAL size except when it is set as the PIP main screen.
- When dual-screen display is selected, the CONNECT AUTO INPUT SELECT function and NO SIGNAL AUTO INPUT SEL. function are disabled.
- When dual-screen display is selected, the AUDIO menu cannot be set.
- When dual-screen display is selected, the DISPLAY COLOR PATTERN cannot be set.
- When an interlaced signal (1080i, 480i, video) is input to the sub screen, horizontal lines may flicker. If this happens, display the image on the main screen.
- When ROTATE 180° is set to ON, you cannot set PIP MODES to PIP, PbyP, or PbyP2.
- When HDMI CEC LINK is set to AUTO, SOUND CHANGE on the PIP/PbyP may be changed to MAIN due to the switching of the monitor's input or due to the operation of the HDMI-connected device.
- The sub screen does not support HDR signals.

■Quad-screen display

You can display 4 screens simultaneously.

Landscape orientation

Position 1 (1920×1080)	Position 2 (1920×1080)
Position 3 (1920×1080)	Position 4 (1920×1080)

Portrait orientation

Position 2 (1080×1920)	Position 4 (1080×1920)
Position 1 (1080×1920)	Position 3 (1080×1920)

Displaying 4 screens

1. Set **CONFIGURE QUAD-SCREEN – QUAD-SCREEN MODE** to **ON** in the MULTI/PIP menu.

Or, press the PIP/PbyP button, and select the **QUAD-SCREEN**.

- The 4 screens set in SETTING INITIAL SCREEN appear.
- When SAVE LAST INPUT CONFIG. is ON, the previously displayed 4 screens appear.
- You can return to the 4 screens set in SETTING INITIAL SCREEN using **CONFIGURE QUAD-SCREEN – RECONFIGURE QUAD-SCREEN** in the MULTI/PIP menu.

Deciding the screen that will be the audio output/input mode selection target

Set the screen whose audio is output, and the screen whose input is changed.

1. Set in **CONFIGURE QUAD-SCREEN – TARGET:SOUND / INPUT SEL.** in the MULTI/PIP menu.

Returning to single screen

1. Set **CONFIGURE QUAD-SCREEN – QUAD-SCREEN MODE** to **OFF** in the MULTI/PIP menu.

Or, press the PIP/PbyP button, and select the **OFF**.

- The screen set in the audio output/input mode selection target is displayed on 1 screen.

TIPS

- You might infringe on a copyright of the author which is protected by copyright law when you display the images of the computer screen and television/VCR simultaneously for profit-making or to show the image to the public.
- When quad-screen display is selected, screen size cannot be changed.
The screen size for quad-screen display is the same as the screen size for single-screen display. The Dot by Dot screen is displayed in NORMAL size.
- When quad-screen display is selected, the CONNECT AUTO INPUT SELECT function and NO SIGNAL AUTO INPUT SEL. function are disabled.
- When quad-screen display is selected, SCREEN menu and AUDIO menu cannot be set.
- When quad-screen display is selected, the DISPLAY COLOR PATTERN cannot be set.
- When quad-screen display is selected, the monitor will not enter the input signal waiting mode even if POWER MANAGEMENT is set to ON.
- When quad-screen display is selected, HDMI CEC LINK does not operate.
- When quad-screen display is selected, the FREEZE, DP (DisplayPort), HDMI, and OPTION buttons cannot be used.
- When quad-screen display is selected, the position 1 screen is output from the DisplayPort output terminal.
- Positions 2 to 4 do not support HDR signals.

■Enlarge

- You can align several monitors and integrate them into a single large screen to display.
- Up to 5 monitors can be aligned in both the horizontal and vertical directions.
- Each monitor displays enlarged views of separated images.

(Example)

Horizontal direction: 2 monitors

Vertical direction: 2 monitors

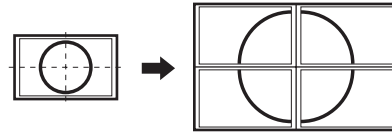

Horizontal direction: 3 monitors

Vertical direction: 2 monitors

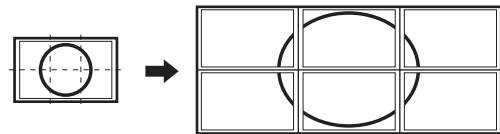

Setting procedure

Set using MULTI in the MULTI/PIP menu.

1. Set **ENLARGE** to ON.
2. Select **ADVANCED (ENLARGE)**.
3. Set the number of monitors aligned in the horizontal direction in **ENLARGE H**.
4. Set the number of monitors aligned in the vertical direction in **ENLARGE V**.
5. Set the section of the separated image to be displayed on each monitor in **ENLARGE-POS**.
 - 1) Press the **ENTER** button.
 - 2) Press the **▲**, **▼**, **◀** or **▶** button to select position, then press **MENU** button.

TIPS

- When Enlarge is used, the CONNECT AUTO INPUT SELECT function and NO SIGNAL AUTO INPUT SEL. function are disabled.

■ SCHEDULE

You can set the time to switch the monitor on and off.
Set this function with SCHEDULE in the SETUP menu. (See page 27.)

SCHEDULE						< D-SUB >
No.	(1) POWER	(2) DAY OF THE WEEK	(3) TIME	(4) INPUT	(5) BRIGHT	(6)
1	-	-	-	-	-	-
2	-	-	-	-	-	-
3	-	-	-	-	-	-
4	-	-	-	-	-	-
5	-	-	-	-	-	-
6	-	-	-	-	-	-
7	-	-	-	-	-	-
8	-	-	-	-	-	-

OK:[ENTER] CANCEL:[RETURN]

- Press the ▲ or ▼ button to select the SCHEDULE number, and press the ► button.
- Set the SCHEDULE. (See the description below.)
Press the ◀ or ▶ button to select items, and press the ▲ or ▼ button to change the setting.
- Press the ENTER button.
SCHEDULE becomes effective.

(1)

- : SCHEDULE effective
- : SCHEDULE not effective

(2) POWER

ON: Switches the monitor on at the specified time.
OFF: Switches the monitor off at the specified time and puts the monitor in standby mode.

(3) DAY OF THE WEEK

Specifies the day of the week to execute the SCHEDULE.
0: ONLY ONCE
Executes the SCHEDULE once on the specified day.
Specify the day of the week to execute the SCHEDULE.
1: EVERY WEEK
Executes the SCHEDULE on the specified day of the week every week. Specify the day of the week to execute the SCHEDULE.
Periodic setting such as "Monday through Friday" is also possible.
2: EVERY DAY
Executes the SCHEDULE every day regardless of the day of the week.

(4) TIME

Specifies the time to execute the SCHEDULE.
Set the time on a 12-hour basis. (Factory default)

(5) INPUT

Specifies the input mode at power-on. If you don't specify this the input active at the last power-off will appear.
When START INPUT MODE is set to a value other than LAST INPUT MODE, the input mode configured for START INPUT MODE will be set.

(6) BRIGHT

Sets the brightness when changing the screen brightness at a specified time.

! Caution

- Do not switch off the main power after setting the SCHEDULE.
- Specify the correct date and time. (See page 27.)
SCHEDULE does not function unless the date and time are specified.
- Check regularly that the set date and time are correct.
- When a temperature abnormality occurs and the backlight brightness is reduced, the brightness is not changed even if a schedule set to BRIGHT is executed.

TIPS

- Up to 8 SCHEDULE items can be registered.
- Setting the SCHEDULE flashes the power LED alternately in red and orange in standby mode.
- A SCHEDULE that has a large number has precedence over that of a small number when schedules overlap.

■About remote control numbers

If there is another monitor nearby, you can change the remote control number to prevent the other monitor from being operated by the remote control unit.

Set the same number in the monitor and in the remote control unit.

TIPS

- You can set remote control numbers to values from 0 to 9.
- When the remote control unit batteries become exhausted and when you replace the batteries, the number on the remote control unit may be reset to 0.

Changing the remote control number on the monitor

Use REMOTE No. on the SETUP menu to set the number. (See page 28.)

1. Use the ◀ or ▶ button to select the remote control number.
2. Select ON and press the ENTER button.
The remote control number is set on the monitor.

Changing the remote control number on the remote control unit

1. While holding down the ID SET button, hold down the number that corresponds to the remote control number set on the monitor for 5 seconds or more, and then release these buttons.

The remote control number is set on the remote control unit.

Checking the remote controller number

1. Press the INFORMATION button to display INFORMATION1.
2. Check that REMOTE No. is the remote control number that you have set in the above procedure.
3. Press the RETURN button to close the monitor INFORMATION screen.

TIPS

- If the remote control numbers on the monitor and remote control unit are different, they will both be displayed on INFORMATION1. On this screen, you can press the ENTER button to match the number on the monitor with the number on the remote control unit.
- Even if the remote control numbers are different, you can use the remote control unit to display the INFORMATION screen.

Adjustments for computer screen display

■Automatic adjustment

When you use the D-SUB to display a computer screen for the first time, or when you change the setting of the computer, use the automatic screen adjustment.

1. Switch the input to D-SUB and display the adjustment pattern. (See the description below.)
2. Press the MENU button and use the ▲ or ▼ button to display the SCREEN menu.
3. Press the ENTER button and select "AUTO".
4. Press the ENTER button.
The automatic adjustment is complete in several seconds.
5. Press the MENU button to close the menu screen.

TIPS

- If the screen cannot be adjusted properly with one automatic adjustment, repeat the automatic adjustment two or three times. Try manual adjustment if necessary.

■Screen display for adjustment

Before making adjustments in the SCREEN menu or PICTURE menu, display an image to brighten the entire screen. If you are using a Windows computer, use the adjustment pattern on the supplied CD-ROM.

Opening the adjustment pattern

The following example is performed in Windows 7.

1. Load the supplied CD-ROM into the computer's CD-ROM drive.
2. Open [CD Drive] in [Computer].
3. Double-click [Adj_uty.exe].

The adjustment pattern will appear.

Adjust the screen automatically or manually.

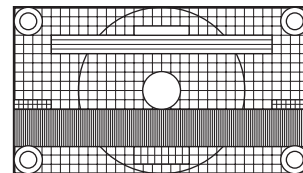

4. When adjustment is finished, press the [Esc] on the computer's keyboard to quit the adjustment program.
5. Eject the CD-ROM from the CD-ROM drive.

TIPS

- If the display mode on the computer you are using is 65000 colors, the color levels in the color pattern may appear differently or grayscale may appear to be colored. (This is due to the specifications of the input signal and is not a malfunction.)

Initialization (Reset)/Functional Restriction Setting (FUNCTION)

You can reset the settings to the factory default settings or restrict operations.

1. Press the **FUNCTION** button, and then press the **MENU** button within 10 seconds.

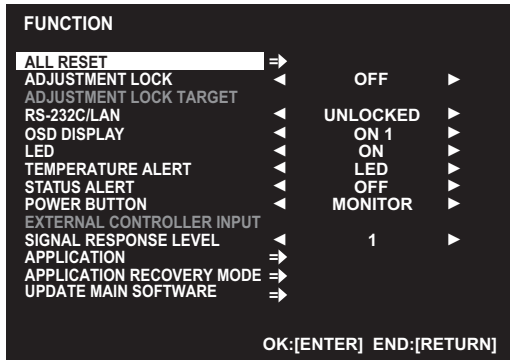

2. Select and set the items.

ALL RESET

Resets the settings to the factory default settings. Press the ENTER button, select the resetting method, and then press the ENTER button. After initialization, turn the main power switch off and then back on.

ALL RESET 1:

Resets all the settings to the factory default settings. In APPLICATION mode, only the settings of the factory-installed applications are initialized.

ALL RESET 2:

Returns the settings to the factory default settings. However, the following items are not returned:
 ID No. SET, REMOTE No., MONITOR CONTROL SELECT, BAUD RATE, APPLICATION (see pages 28 and 37.);
 the applications of APPLICATION mode also are not returned.

ADJUSTMENT LOCK

You can disable operations on the monitor and the remote control unit that use buttons.

OFF ... Enables operation.

ON 1 .. Disables all operations other than turning power on/off and FUNCTION.

ON 2 .. Only the FUNCTION operation is enabled. Disables all operations other than FUNCTION (not even power on/off).

ADJUSTMENT LOCK TARGET

Sets the target to prohibit operation of with ADJUSTMENT LOCK.

REMOTE CONTROL..... Prohibits remote control operation

MONITOR BUTTONS ... Prohibits monitor button operation

BOTH..... Prohibits remote control and monitor button operation

RS-232C/LAN

Specifies whether to allow control via RS-232C or LAN. (See pages 38 and 49.)

OSD DISPLAY

Shows/hides the menu, modes and messages. The FUNCTION screen cannot be hidden.

ON 1 Shows all menus, modes and messages.
 ON 2 Hides messages automatically displayed by the display. Shows messages during operation.

OFF Hides all menus, modes and messages.

LED

Specifies whether to light the power LED.

TEMPERATURE ALERT

Selects the notification method for an abnormal temperature.

OFF Do not notify about an abnormal temperature.

OSD & LED When an abnormal temperature is detected, the power LED flashes in red and green alternately and the screen displays a message: TEMPERATURE.

LED..... When an abnormal temperature is detected, the power LED flashes in red and green alternately.

STATUS ALERT

Selects the notification method for a hardware error.

OFF Do not notify about the error.

OSD & LED When a hardware error is detected, the power LED flashes in red and the screen displays a message: STATUS [xxxx].

LED..... When a hardware error is detected, the power LED flashes in red.

POWER BUTTON

Normally, leave this setting as MONITOR.

When using an optional part, if instruction appears, change the setting accordingly.

EXTERNAL CONTROLLER INPUT

Normally, you do not need to change this setting.

When using an optional part, if instruction appears, change the setting accordingly.

SIGNAL RESPONSE LEVEL

Normally, you do not need to change this setting. Use this option to set the level of response to signal changes.

Initialization (Reset)/Functional Restriction Setting (FUNCTION)

APPLICATION

Set whether or not APPLICATION mode is used.
DISABLE Do not use APPLICATION mode. The input mode cannot be changed to APPLICATION.

ENABLE Use APPLICATION mode.

APPLICATION RECOVERY MODE

Before selecting this item, connect a commercially available USB keyboard to the USB port.
Select this item when you want to return to the factory default settings, such as when an application does not operate correctly.
Select ON, and select "Wipe data/factory reset".
Other items are not used.
* During processing, do not turn off the power.

UPDATE MAIN SOFTWARE

Not normally used.
Used by service technicians when performing repairs or otherwise.

3. Press the RETURN button to return to the normal screen.

TIPS

- When both abnormal temperature and hardware error are detected, the hardware error notification overrides.
- If TEMPERATURE ALERT or STATUS ALERT is set to OSD & LED, alert messages will appear even if the OSD DISPLAY is set to ON 2 or OFF.
- If TEMPERATURE ALERT or STATUS ALERT is set to LED or OSD & LED, the power LED lights even if the LED function is set to OFF.

Controlling the Monitor with a computer (RS-232C)

You can control this monitor from a computer via RS-232C (COM port) on the computer.

You can also connect multiple monitors via a daisy chain by using a computer. By assigning ID numbers to each monitor (see page 39), you can make input mode selection/adjustment or can check the status of a specific monitor.

TIPS

- To control the monitor via RS-232C, set MONITOR CONTROL SELECT to RS-232C. (When this is done, control via LAN or application is not possible.)

Computer connection

■ One-to-one connection with a computer

Connect with RS-232C straight cable between the computer's COM port (RS-232C connector) and the RS-232C input terminal on the monitor.

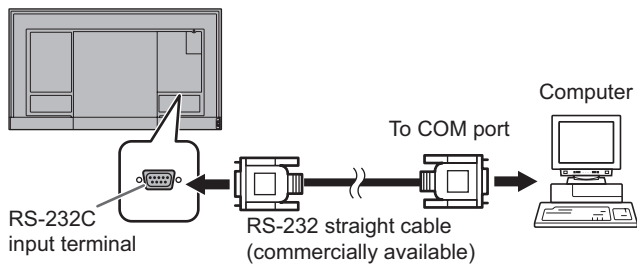

■ Daisy chain connection... **Advanced operation**

Connect with RS-232C straight cable between the computer's COM port (RS-232C connector) and the RS-232C input terminal on the first monitor. Next, connect RS-232C conversion cable (supplied) and RS-232C straight cable to the first monitor's RS-232C output terminal and to the second monitor's RS-232C input terminal. Connect RS-232C straight cable and RS-232C conversion cable (supplied) in the same way to the third and subsequent monitors.

Up to 4 monitors can be connected. (Depending on the length of the cable used and the surrounding environment.)

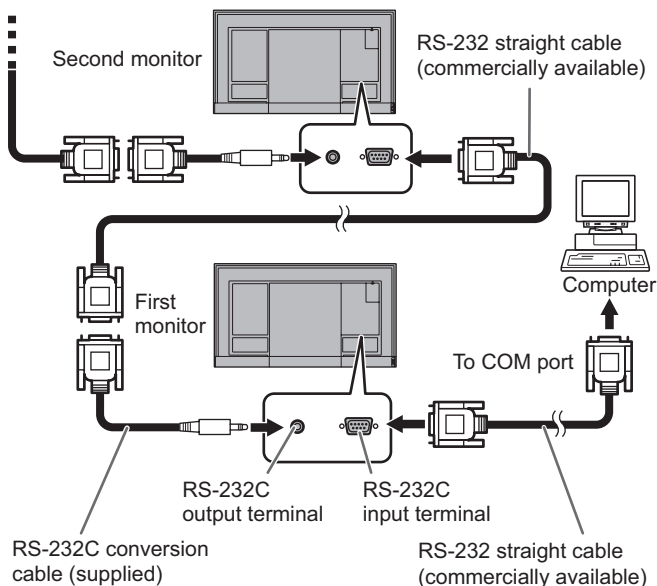

Communication conditions

Set the RS-232C communication settings on the computer to match the monitor's communication settings as follows:

Baud rate	*
Data length	8 bits
Parity bit	None

Stop bit	1 bit
Flow control	None

* Set to the same baud rate as the BAUD RATE setting of SETUP menu. (Initial setting: 38400 bps)

* When connecting multiple monitors in a daisy chain, set all monitors to the same BAUD RATE.

Communication procedure

■ Command format

When a command is sent from the computer to the monitor, the monitor operates according to the received command and sends a response message to the computer.

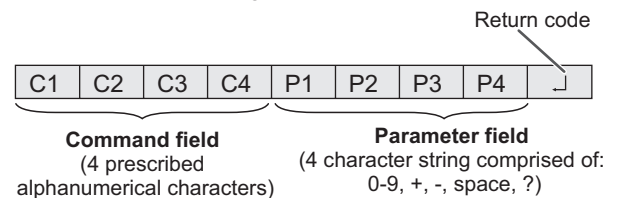

Example: VOLM0030
VOLM _ _ 30

* Be sure to input 4 characters for the parameter. Pad with spaces (" ") if necessary.

("␣" is a return code (0DH, 0AH or 0DH))

Wrong : VOLM30␣

Right : VOLM _ _ 30␣

When inputting a negative value, specify a numerical value in three digits.

Example: OFSR-127

When the parameter part is 5 or more characters, specify parameters using a specified number of characters without using spaces.

Example: MPOS010097

If a command has "R" listed for "Direction" in the "RS-232C command table" on page 42, the current value can be returned by using "?" as the parameter.

Example:

VOLM ? ? ? ? ← From computer to monitor (How much is current volume setting?).

30 ← From monitor to computer (Current volume setting: 30).

* If an ID number (see page 39) has been assigned (For example, ID number = 1).

VOLM _ _ _ ? ← From computer to monitor.

30 _ 001 ← From monitor to computer.

Response code format

When a command has been executed correctly

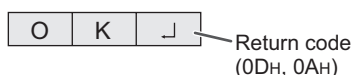

A response is returned after a command is executed.

- * If an ID number has been assigned

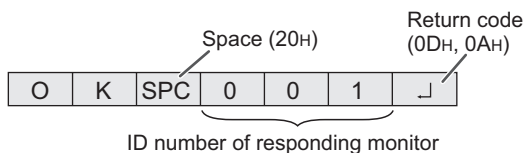

When a command has not been executed



- * If an ID number has been assigned

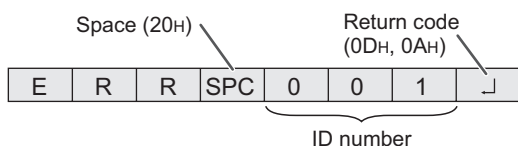

TIPS

- “ERR” is returned when there is no relevant command or when the command cannot be used in the current state of the monitor.
- If communication has not been established for reasons such as a bad connection between the computer and monitor, nothing is returned (not even ERR).
- “ERR” may be returned when a command cannot be received correctly due to interference from the surrounding environment. Please ensure that the system or software resends the command if this occurs.
- If no monitor has been assigned the designated ID number (e.g. if the command IDSL0002 is used, but no monitor with ID number: 2 is found), no response is returned.

If execution of the command is taking some time



When the following commands are used, “WAIT” is returned. In this case, a value will be returned if you wait a while. Do not send any command during this period.

No ID number is attached to WAIT response.

- Commands which return WAIT:
 1. When repeater control is used
 2. When an IDSL or IDLK command is used
 3. When one of the following commands is used: RSET, POWR, INPS, ASNC, PXSL, AGIN, HDRS, DPST, HD1M, HD2M, OPTM, ENLG, EMAG, EMHV, EPHV, EPOS, ESTG, ESHV, MWIN, MWIP, MWPP, MSCS, MSP1, MSP2, MSP3, MSP4, MSIP, BOMD, APST, APRV, WIDE

When control via RS-232C is locked (see page 36)



When MONITOR CONTROL SELECT is set to LAN or APPLICATION

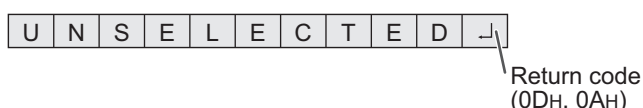

Communication interval

- After OK or ERR is returned, you must send the following commands.

To set a timeout for the command response, specify 10 seconds or longer.

When connecting multiple monitors in a daisy chain, set the timeout to at least the product of the monitor's position from the computer multiplied by 10 seconds.

Example) 3rd monitor from computer: 30 seconds or longer.

- Provide an interval of 100 ms or more between the command response and the transmission of the next command.

VOLM0020

OK

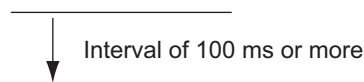

INPS0001

WAIT

OK

TIPS

- When executing ALL RESET, set the timeout period to 30 seconds or longer.
- When turning the power on while the POWER ON DELAY function is in use, set the timeout period to the POWER ON DELAY period + 10 seconds or longer.

Advanced operation

This section explains commands for daisy chain connection. The basic communication procedure is the same as in the “One-to-one connection with a computer” section.

ID numbers

You can assign a unique ID number to each monitor. (See page 28.) This allows you to control a particular monitor in a daisy chain of monitors.

You can assign ID numbers either from the menu screen or from the computer using RS-232 cable.

[Example]

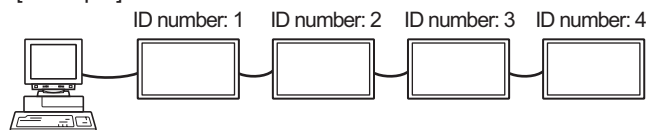

If monitors are connected as shown above, you can execute commands like “Set the volume of the monitor with ID 4 to 20”.

When designating ID numbers for a set of monitors linked in a daisy chain, you should basically avoid any duplication of ID numbers.

ID numbers do not have to be assigned in ascending order starting from the computer. They can also be connected as shown below.

[Example]

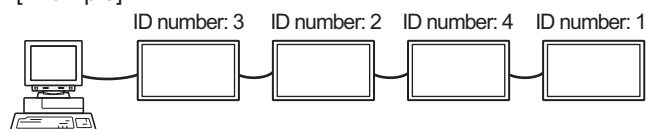

Controlling the Monitor with a computer (RS-232C)

■ Commands for ID control

The command examples shown on this page assume the following connection and ID number set up.

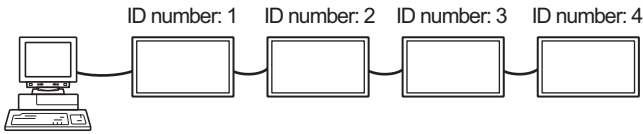

IDSTA monitor receiving this command sets its own ID number in the parameter field.

Example:

IDST0001

OK _ 001 ← The ID number of this monitor is set to 1.

TIPS

You can automatically assign ID numbers by using the IDST command with the Repeater control (see “Repeater control” on page 41).

For example, using the command “IDST001+” automatically sets the ID numbers, as shown below.

[Example]

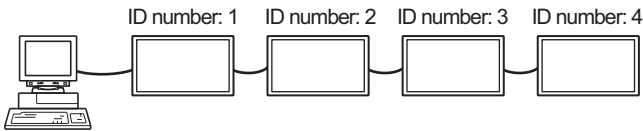

IDST001 + ← ID setting command with repeater control

WAIT

OK _ 001 ← “OK” response from ID number: 1

OK _ 002 ← “OK” response from ID number: 2

OK _ 003 ← “OK” response from ID number: 3

OK _ 004 ← “OK” response from ID number: 4 (End)

IDSLThe parameter of this command sets the ID number of the monitor. The monitor is subject to the next command.

Example:

IDSL0002 ← The next command is for the monitor with ID number: 2.

WAIT ← Searching for monitor with ID number: 2

OK _ 002 ← Found monitor with ID number: 2

VOLM0030 ← Sets volume of monitor with ID number: 2 to 30.

WAIT ← Processing

OK _ 002 ← OK response from monitor with ID number: 2

VOLM0020 ← Sets volume to 20.

OK _ 001 ← The volume of the monitor with ID number: 1 (the one directly connected to the computer) is set to 20.*

* The IDSL command is effective only once, for the immediately succeeding command.

IDLKThe parameter of this command sets the ID number of the monitor. The monitor is subject to all subsequent commands.

Example:

IDLK0002 ← Following commands are for the monitor with ID number: 2.

WAIT ← Searching for monitor with ID number: 2

OK _ 002 ← Found monitor with ID number: 2

VOLM0030 ← Sets volume of monitor with ID number: 2 to 30.*

WAIT ← Processing

OK _ 002

VOLM0020 ← Sets volume of monitor with ID number: 2 to 20.*

WAIT

OK _ 002

IDLK0000 ← Canceling fixed ID number setting

WAIT ← Canceling IDLK

OK _ 002 ← Cancellation complete

VOLM0010

OK _ 001 ← The volume of the monitor with ID number: 1 (the one directly connected to the computer) is set to 10. (IDLK is canceled.)

* The IDLK command remains effective until it is canceled, or power is shut off.

IDCK.....Provides screen display of the ID number currently assigned to a monitor, and the ID number currently set for IDLK (if any).

Example:

(After executing IDLK0002)

IDCK0000 ← (Parameter has no meaning.)

ID : 001 IDLK : 002 ← Returned response. The ID number is also displayed on the monitor screen.

IDCK000 + ← Repeater control. (If a command is used with repeater control, ID designation using IDSL or IDLK is canceled.)

WAIT

ID : 001 IDLK : 000

ID : 002 IDLK : 000

ID : 003 IDLK : 000

ID : 004 IDLK : 000

■ Repeater control

This system has a function to allow setting of multiple monitors connected in a daisy chain using a single command. This function is called repeater control. You can use Repeater control function without assigning ID numbers.

[Example]

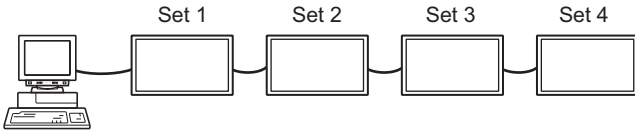

* If monitors are connected as shown above, you can execute a command like "Set all monitors' input settings to D-SUB".

■ Repeater control command

Repeater control is achieved by setting the FOURTH CHARACTER of the parameter to "+".

Example:

VOLM030 + ← Sets volume of all monitors to 30.

In repeater control, responses are returned by all the connected monitors.

If you want to determine that a value has been returned by a specific set, assign ID numbers to each monitor in advance. When some monitors do not return their responses, the probable cause is that the monitors could not receive the command or command processing is not complete. Do not send a new command.

Example: (When 4 monitors are connected, and assigned ID numbers: 1 through 4)

```
VOLM030 +
WAIT
OK _ 001
OK _ 002
OK _ 003
OK _ 004 ← If 4 monitors are connected in
             a chain, reliable operation can
             be ensured by sending a new
             command only after a reply
             has been returned by 4th (last)
             monitor.
```

Repeater control can also be used for reading settings.

Example:

```
VOLM ??? +
WAIT
10 _ 001
20 _ 002
30 _ 003
30 _ 004
```

Volume settings for all monitors are returned.

TIPS

- If repeater control is used during ID designation (IDSL, IDLK), the ID designation is canceled.

Controlling the Monitor with a computer (RS-232C)

RS-232C command table

How to read the command table

- Command: Command field (See page 38.)
- Direction: W When the "Parameter" is set in the parameter field (see page 38), the command functions as described under "Control/Response Contents".
R The returned value indicated under "Reply" can be obtained by setting "????", "____?" or "???" (repeater control) in the parameter field. (See page 38.)
- Parameter: Parameter field (See page 38.)
- Reply: Response (Returned value)
- * : When POWER SAVE MODE is set to OFF:
 "●/○" : Indicates a command which can be used in standby mode or when the power is on.
 "-" : Indicates a command which can be used when the power is on. Cannot be used in standby mode.
 When POWER SAVE MODE is set to ON:
 "●" : Indicates a command which can be used in standby mode or when the power is on.
 "○/-" : Indicates a command which can be used when the power is on. Cannot be used in standby mode.

Power control/Input mode selection

Function	Command	Direction	Parameter	Reply	Control/Response contents	*
Power control	POWR	W	0		Switches to standby mode.	
			1		Returns from standby mode.	
		R	0		Standby mode	
			1		Normal mode	
			2		Input signal waiting mode	
Input mode selection	INPS	W	0		Toggle change for input mode.	●
			2		D-SUB	
			10		HDMI1	
			13		HDMI2	
			14		DisplayPort	
			21		OPTION "ERR" when nothing is attached in the expansion slot.	
			24		APPLICATION	
		R	2		D-SUB	
			10		HDMI1	
			13		HDMI2	
			14		DisplayPort	
			21		OPTION	
			24		APPLICATION	

SCREEN menu

Function	Command	Direction	Parameter	Reply	Control/Response contents	*	
AUTO	ASNC	W	1		When the input mode is D-SUB.		
CLOCK	CLCK	WR	0-1200	0-1200	When the input mode is D-SUB. Varies depending on the signal.		
PHASE	PHSE	WR	0-63	0-63	When the input mode is D-SUB.		
POSITIONING	POSITION OF THE LONGEST DIRECTION	HPOS	WR	0-800	0-800		When the input mode is D-SUB. Varies depending on the signal.
	POSITION OF THE SHORTEST DIRECTION	VPOS	WR	0-200	0-200		When the input mode is D-SUB. Varies depending on the signal.
RESOLUTION SETTING	LONGEST DIRECTION RESOLUTION	HRES	WR	300-1920	300-1920		When the input mode is D-SUB. Only even numbers are valid for parameters.
	SHORTEST DIRECTION RESOLUTION	VRES	WR	300-1200	300-1200		Varies depending on the signal.
INPUT SIGNAL (D-SUB)	PXSL	WR	1	1	768) 1360 x 768		
			2	2	768) 1280 x 768		
			3	3	768) 1024 x 768		
			5	5	480) 848 x 480		
			6	6	480) 640 x 480		
			7	7	1050) 1680 x 1050		
			8	8	1050) 1400 x 1050		
			9	9	768) AUTO		
			10	10	480) AUTO		
			Check the resolution	PXCK	R		-
RESET	ARST	W	1				

Controlling the Monitor with a computer (RS-232C)

PICTURE menu

Function		Command	Direction	Parameter	Reply	Control/Response contents	*	
BRIGHT		VLMP	WR	0-31	0-31			
CONTRAST		CONT	WR	0-60	0-60			
BLACK LEVEL		BLVL	WR	0-60	0-60			
TINT		TINT	WR	0-60	0-60			
COLORS		COLR	WR	0-60	0-60			
SHARPNESS		SHRP	WR	0-24	0-24			
COLOR ADJUSTMENT	COLOR MODE	BMOD	WR	0	0	STD		
				2	2	VIVID		
				3	3	sRGB		
				4	4	HIGH ILLUMINANCE		
	WHITE BALANCE		WHBL	WR	0-2	0-2	0:THRU, 1:PRESET, 2:USER	
	PRESET		CTMP	WR	1-28	1-28	From 1: approximately 3000K to 15: approximately 10000K (500K steps), 16: approximately 5600K, 17: approximately 9300K, 18: approximately 3200K, From 19: approximately 10500K to 28: approximately 15000K (500K steps) "ERR" when WHBL is not set to 1.	
	USER	R-CONTRAST	CRTR	WR	0-256	0-256	"ERR" when WHBL is not set to 2.	
		G-CONTRAST	CRTG	WR	0-256	0-256		
		B-CONTRAST	CRTB	WR	0-256	0-256		
		R-OFFSET	OFSR	WR	-127-127	-127-127		
		G-OFFSET	OFSG	WR	-127-127	-127-127		
	COPY TO USER		CPTU	W	0		Copies a preset value to the user setting.	
	GAMMA		GAMM	WR	0-2, 5-9	0-2, 5-9	0: 1.8, 1: 2.2, 2: 2.4, 5:2.0, 6:STD, 7:LIGHT 2, 8:LIGHT 1, 9:DARK	
	C.M.S.-HUE		CMHR	WR	-10-10	-10-10	R	
			CMHY				Y	
			CMHG				G	
			CMHC				C	
			CMHB				B	
			CMHM				M	
	C.M.S.-SATURATION		CRST	W	1		Resets the hue.	
CMSR			WR	-10-10	-10-10	R		
CMSY						Y		
CMSG						G		
CMSC						C		
CMSB						B		
CMSM						M		
		CRST	W	2		Resets the saturation.		
ADVANCED	AUTO	AGIN	W	1		When the input mode is D-SUB.	-	
	ANALOG GAIN	ANGA	WR	0-127	0-127	When the input mode is D-SUB.		
	ANALOG OFFSET	ANOF	WR	0-127	0-127	When the input mode is D-SUB.		
	NR	TDNR	WR	0-2	0-2	0: OFF, 1: LOW, 2: HIGH		
	RGB INPUT RANGE	INPR	WR	0-2	0-2	0: AUTO, 1: FULL, 2: LIMITED When the input mode is D-SUB or APPLICATION, the value 0 is invalid.		
	DISPLAY COLOR PATTERN		PTDF	WR	0	0	No pattern display.	
					1	1	White single color pattern display.	
					2	2	Red single color pattern display.	
					3	3	Green single color pattern display.	
					4	4	Blue single color pattern display.	
				99	99	Red/green/blue mixed color pattern display. Set each color's level with PTDR, PTDG, PTDB.		
DISPLAY COLOR PATTERN (R)		PTDR	WR	0-255	0-255	Set the R, G, and B levels of the mixed color pattern. "ERR" when PTDF is not set to 99.	-	
DISPLAY COLOR PATTERN (G)		PTDG	WR	0-255	0-255			
DISPLAY COLOR PATTERN (B)		PTDB	WR	0-255	0-255			
DISPLAY COLOR PATTERN (LEVEL)		PTDL	WR	0-255	0-255	Set the white, red, green, and blue levels of the single color pattern. "ERR" when the DISPLAY COLOR PATTERN is set to a color other than white, red, green, or blue.		
HDR		HDRS	WR	0-1	0-1	0: OFF, 1: ON		
RESET		ARST	W	2				

Controlling the Monitor with a computer (RS-232C)

AUDIO menu

Function	Command	Direction	Parameter	Reply	Control/Response contents	*
TREBLE	AUTR	WR	-5-5	-5-5		
BASS	AUBS	WR	-5-5	-5-5		○
BALANCE	AUBL	WR	-10-10	-10-10		
RESET	ARST	W	3			-

SETUP menu

Function	Command	Direction	Parameter	Reply	Control/Response contents	*	
DATE/TIME SETTING	DATE	WR	AABBCCDDEE	AABBCCDDEE	AA: Year, BB: Month, CC: Day, DD: Hour, EE: Minute		
Automatic date & time	AMDT	WR	0-1	0-1	Set whether or not the time provided from the network is used. 0: OFF, 1: ON "ERR" when DISABLE is selected for APPLICATION.		
DATE DISPLAY FORMAT	DTFT	WR	0-2	0-2	0: YYYY/MM/DD, 1: MM/DD/YYYY, 2: DD/MM/YYYY YYYY: Year, MM: Month, DD: Day		
TIME DISPLAY FORMAT	TMFT	WR	0-1	0-1	0: 24-HOUR TIME, 1: 12-HOUR TIME		
SCHEDULE	SC01-SC08	WR	ABCDEFGGH	ABCDEFGGH	Schedule of a specified number A: Schedule 0= Not effective, 1 = Effective B: Power 0 = OFF, 1 = ON C: Day of the week 1 0 = Only once, 1 = Every week, 2 = Every day D: Day of the week 2 0 = Sunday, 1 = Monday through 6 = Saturday, 9 = Not exist E: Day of the week 3 0 = Sunday, 1 = Monday through 6 = Saturday, 9 = Not exist F: Hour 00-23 G: Minute 00-59 H: Input 0 = Not specified, 1 = HDMI1, 2 = HDMI2, 4 = D-SUB, 6 = DisplayPort, 8=OPTION (valid when you have used the expansion slot to expand the functions), 9 = APPLICATION	○	
SCHEDULE BRIGHTNESS	SB01-SB08	WR	0-31 99	0-31 99	Screen brightness to change Disable brightness setting		
LANGUAGE	LANG	WR	14 1 2 3 4 5 6	14 1 2 3 4 5 6	ENGLISH DEUTSCH FRANÇAIS ITALIANO ESPAÑOL РУССКИЙ 日本語		
INPUT SELECT	DisplayPort STREAM (DisplayPort)	DPST	WR	0, 2	0, 2	0: SST1, 2: SST2	
	HDMI MODES (HDMI1)	HD1M	WR	0-1	0-1	0: MODE1, 1: MODE2	-
	HDMI MODES (HDMI2)	HD2M	WR	0-1	0-1	0: MODE1, 1: MODE2	
	HDMI MODES (OPTION)	OPTM	WR	0-1	0-1	0: MODE1, 1: MODE2	
CEC SETTING	HDMI CEC LINK	CELK	WR	0-1	0-1	0: OFF, 1: AUTO	
	AUTO POWER ON	ATPO	WR	0-1	0-1	0: OFF, 1: ON	
	CONTENT MENU BUTTON	CMBT	WR	0-1	0-1	0: CEC, 1: SWITCH TO APPLICATION	
AUDIO SELECT	APPLICATION	ASAC	WR	0-1	0-1	0: APPLICATION, 1: AUDIO	
	DisplayPort	ASDI	WR	1, 3	1, 3	1: AUDIO, 3: DisplayPort	
	HDMI1	ASHP	WR	0-1	0-1	0: HDMI, 1: AUDIO	
	HDMI2	AH2P	WR	0-1	0-1	0: HDMI, 1: AUDIO	
	OPTION (valid when you have used the expansion slot to expand the functions)	ASOP	WR	0-1	0-1	0: OPTION, 1: AUDIO	○
AUDIO OPTION	AUDIO OUTPUT	AOUT	WR	0-2	0-2	0: VARIABLE1, 1: FIXED, 2: VARIABLE2	
	AUDIO INPUT LEVEL	AIVP	WR	0-1	0-1	0: 1.0Vrms, 1: 0.5Vrms	
	MONAURAL AUDIO	MONO	WR	0-1	0-1	0: OFF, 1: ON	
START INPUT MODE	SUIM	WR	1-4, 7, 10, 12	1-4, 7, 10, 12	1: LAST INPUT MODE, 2: DisplayPort, 3: HDMI1, 4: HDMI2, 7: D-SUB, 10:OPTION (valid when you have used the expansion slot to expand the functions), 12: APPLICATION		

Controlling the Monitor with a computer (RS-232C)

Function		Command	Direction	Parameter	Reply	Control/Response contents	*
COMMUNICATION SETTING	MONITOR CONTROL SELECT	CTLS	WR	0-2	0-2	0: RS-232C, 1: LAN, 2: APPLICATION	●
	BAUD RATE	BAUD	WR	0-2	0-2	0: 9600bps, 1: 19200bps, 2: 38400bps	
ID SETTING	ID No. SET	IDST	WR	0-255	0-255	Sets the monitor's ID number. ("0" means "no ID number".)	
	ID NO. SETTING (ONCE)	IDSL	W	1-255		Set a monitor's ID number to send a command. This ID number is only effective for the command immediately after this command.	
				0		Clears the ID number if one has been designated.	○
	ID NO. SETTING (SUBSEQUENT)	IDLK	W	1-255		Set a monitor's ID number to send a command. This ID number is effective for the next and all subsequent commands after this command.	
				0		Clears the ID number if one has been designated.	
	ID CHECK	IDCK	W	0	ID : xxx IDLK : yyy	Displays monitor's own ID number and the selected ID number on the screen.	
	ID DISPLAY	IDDP	W	0-2		0: OFF, 1: ON, 2: ON (turns OFF after 4 sec.) (The IP address and MAC address are both displayed.)	-
AUTO ASSIGN ID No.	HAID	W	1				
REMOTE No.	RCNO	WR	0-9	0-9	Sets the number of the remote control unit.	○	

MONITOR menu

Function		Command	Direction	Parameter	Reply	Control/Response contents	*
PORTRAIT/LANDSCAPE INSTALL		STDR	WR	0-1	0-1	0: LANDSCAPE, 1: PORTRAIT	
HORIZONTAL INSTALLATION		MLAY	WR	0-1	0-1	0: OFF, 1: FACE UP	
ROTATE 180°		PFIL	WR	0, 3	0, 3	0: OFF, 3: ON "ERR" when PIP MODES is a value other than OFF.	
OSD H-POSITION		OSDH	WR	0-100	0-100		
OSD V-POSITION		OSDV	WR	0-100	0-100		
POWER SAVE MODE		STBM	WR	0-1	0-1	0: OFF, 1: ON	
OFF IF NO OPERATION		ATOF	WR	0-1	0-1	0: OFF, 1: ON	
	TIME	AOFT	WR	1-12	1-12	1-12: 1-12 hours	○
POWER ON DELAY		PODS	WR	0-1	0-1	0: OFF, 1: ON	
	INTERVAL	PWOD	WR	1-60	1-60	1-60: 1-60 seconds	
SELF ADJUST		AADJ	WR	0-1	0-1	0: OFF, 1: ON	
	START TIMING	AADD	WR	10-200	10-200	10: 1 second through 200: 20 seconds	

Controlling the Monitor with a computer (RS-232C)

MULTI/PIP menu

Function	Command	Direction	Parameter	Reply	Control/Response contents	*	
ENLARGE	ENLG	WR	0-1	0-1	0: OFF, 1: ON		
Enlarge mode	EMAG	WR	1-4	1-4	1: 2 x 2, 2: 3 x 3, 3: 4 x 4, 4: 5 x 5		
	EMHV	WR	12(21)-55	11-55	1 x 2 (2 x 1) to 5 x 5 ("m x n" is expressed as "mn", where m and n are the numbers of monitors specified for the longest direction and the shortest direction respectively.)		
Image position (M x N)	EPHV	WR	11-55	11-55	Specifies values in the order of image position in longest / shortest direction.		
Image position (2 x 2)	EPOS	WR	0-3	0-3	See the description below.		
Image position (3 x 3)	EPOS	WR	0-8	0-8			
Image position (4 x 4)	EPOS	WR	0-15	0-15			
Image position (5 x 5)	EPOS	WR	0-24	0-24			
ENLARGED SCREEN POSITIONING	THE LONGEST DIRECTION	EPSH	WR	-999-999		-999-999	The setting range depends on the enlarge mode setting and the image position.
	THE SHORTEST DIRECTION	EPSV	WR	-999-999	-999-999		
BEZEL ADJUST	BZCO	WR	0-1	0-1	0: OFF, 1: ON	○	
	TOP	BZCT	WR	0-1	0-1		0: OFF, 1: ON
	BOTTOM	BZCB	WR	0-1	0-1		0: OFF, 1: ON
	RIGHT	BZCR	WR	0-1	0-1		0: OFF, 1: ON
	LEFT	BZCL	WR	0-1	0-1		0: OFF, 1: ON
BEZEL WIDTH	TOP	BZWT	WR	0-100	0-100		
	BOTTOM	BZWB	WR	0-100	0-100		
	RIGHT	BZWR	WR	0-100	0-100		
	LEFT	BZWL	WR	0-100	0-100		
ENLARGE/IMAGE POSITION SETTING	ESTG	WR	XXYY	XXYY	XX: Enlarge mode (Same as EMAG), YY: Image position (Same as EPOS)		
	ESHV	WR	XXYY	XXYY	XX: Enlarge mode (Same as EMHV), YY: Image position (Same as EPHV)		

• Image position (EPOS) setting In landscape orientation

2 x 2

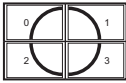

3 x 3

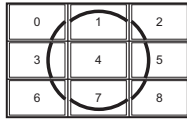

4 x 4

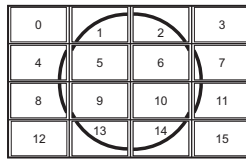

5 x 5

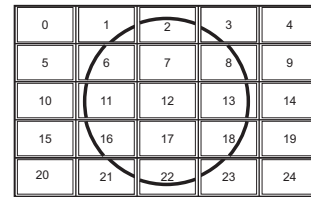

In portrait orientation

2 x 2



3 x 3

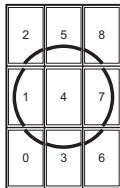

4 x 4

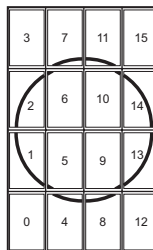

5 x 5

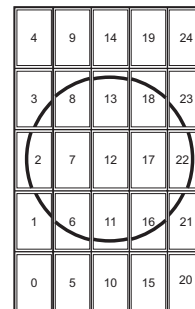

Controlling the Monitor with a computer (RS-232C)

Function		Command	Direction	Parameter	Reply	Control/Response contents	*
PIP MODES		MWIN	WR	0-3	0-3	0: OFF, 1: PIP, 2: PbyP, 3: PbyP2	
PIP SIZE		MPSZ	WR	1-64	1-64		
PIP POS	THE LONGEST DIRECTION	MHPS	WR	0-100	0-100		
	THE SHORTEST DIRECTION	MVPS	WR	0-100	0-100		
PIP POS LD+SD BATCH		MPOS	W	0-100,0-100		Specify the position in MPOSxxxxyy format. (xxx: Longer side, yyy: Shorter side position)	
			R		0-100,0-100	Returns a response in (xxx,yyy) format. (xxx: Longer side, yyy: Shorter side position)	
PIP BLEND		MWBL	WR	0-7	0-7		
PIP SOURCE		MWIP	WR	2	2	D-SUB	
				10	10	HDMI1	
				13	13	HDMI2	
				14	14	DisplayPort	
				21	21	OPTION (valid when you have used the expansion slot to expand the functions)	
				24	24	APPLICATION	
SOUND CHANGE		MWAD	WR	1-2	1-2	1: MAIN, 2: SUB	
MAIN POS (Main screen)		MWPP	WR	0-1	0-1	0: POS1, 1: POS2	
PbyP2 POS (Sub screen)		MW2P	WR	0-2	0-2	0: POS1, 1: POS2, 2: POS3	
QUAD-SCREEN MODE		MSCS	WR	1, 4	1, 4	1: OFF, 4: ON	
SETTING INITIAL SCREEN (POSITION 1-4)		MSP1- MSP4	WR	0	0	AUTO	
				2	2	D-SUB	
				10	10	HDMI1	
				13	13	HDMI2	
				14	14	DisplayPort	
				21	21	OPTION (valid when you have used the expansion slot to expand the functions)	
				24	24	APPLICATION	
PRIORITY: AUTO INPUT SEL.	DisplayPort	MPDP	WR	0-10	0-10	0: Not selected by PRIORITY: AUTO INPUT SEL., 1-10: Priority setting	
	HDMI1	MPH1					
	HDMI2	MPH2					
	D-SUB	MPD1					
	APPLICATION	MPAP					
SAVE LAST INPUT CONFIG.		MSLI	WR	0-1	0-1	0: OFF, 1: ON	
TARGET: SOUND / INPUT SEL.		MSAO	WR	1-4	1-4	1: POS1, 2: POS2, 3: POS3, 4: POS4	
Input mode selection in quad-screen display		MSIP	WR	2	2	D-SUB	
				10	10	HDMI1	
				13	13	HDMI2	
				14	14	DisplayPort	
				21	21	OPTION (valid when you have used the expansion slot to expand the functions)	
				24	24	APPLICATION	

OTHERS menu

Function		Command	Direction	Parameter	Reply	Control/Response contents	*	
POWER MANAGEMENT		PMNG	WR	0-1	0-1	0: OFF, 1: ON		
CONNECT AUTO INPUT SELECT		AICO	WR	0-1	0-1	0: OFF, 1: ON		
NO SIGNAL AUTO INPUT SEL.		AINO	WR	0-1	0-1	0: OFF, 1: ON		
AUTO INPUT SELECT PRIORITY	DisplayPort	APDP	WR	0-10	0-10	0: Not selected by NO SIGNAL AUTO INPUT SEL., 1-10: Priority setting "ERR" when OFF is selected for NO SIGNAL AUTO INPUT SEL.. APOP will result in an error ("ERR") when an optional part that is not a target for this function is connected. All input terminals cannot be set to 0 simultaneously.		
	HDMI1	APH1						
	HDMI2	APH2						
	D-SUB	APD1						
	OPTION	APOP						
LOGO SCREEN		BTSC	WR	0-1	0-1	0: OFF, 1: ON		
VOLUME		VOLM	WR	0-31	0-31			
MUTE AUDIO		MUTE	WR	0-1	0-1	0: OFF, 1: ON	-	
MUTE WITH FREEZE		FRAO	WR	0-1	0-1	0: OFF, 1: ON	○	
BACKLIGHT OFF		BOMD	W	0		Turn backlight off		
				1		Turn backlight on		
			R		0		Backlight off	
					1		Backlight on	

Controlling the Monitor with a computer (RS-232C)

Initialization/Functional Restriction Setting (FUNCTION) menu

Function	Command	Direction	Parameter	Reply	Control/Response contents	*
ALL RESET	RSET	W	0-1		0: ALL RESET 1, 1: ALL RESET 2	-
ADJUSTMENT LOCK	ALCK	WR	0	0	OFF	●
		W	1-2		1: ON 1, 2: ON 2	○
		R		1-2	1: ON 1, 2: ON 2	●
ADJUSTMENT LOCK TARGET	ALTG	WR	0-2	0-2	0: REMOTE CONTROL, 1: MONITOR BUTTONS, 2: BOTH	
OSD DISPLAY	LOSD	WR	0-2	0-2	0: ON 1, 1: OFF, 2: ON 2	
LED	OFLD	WR	0-1	0-1	0: ON, 1: OFF	
TEMPERATURE ALERT	TALT	WR	0-2	0-2	0: OFF, 1: OSD & LED, 2: LED	
STATUS ALERT	SALT	WR	0-2	0-2	0: OFF, 1: OSD & LED, 2: LED	○
POWER BUTTON	PBTN	WR	0-1	0-1	0: MONITOR, 1: EXT. CONTROLLER	
EXTERNAL CONTROLLER INPUT	PCIP	WR	0-3	0-3	0: D-SUB, 1: DisplayPort, 2: HDMI1, 3: HDMI2 "ERR" when MONITOR is selected for POWER BUTTON.	
SIGNAL RESPONSE LEVEL	HDUC	WR	1-200	1-200		
APPLICATION	APST	WR	0-1	0-1	0: DISABLE, 1: ENABLE	
APPLICATION RECOVERY MODE	APRV	W	0		Display the menu for APPLICATION mode recovery	-

Others

Function	Command	Direction	Parameter	Reply	Control/Response contents	*	
SIZE (Screen size selection)	WIDE	WR	1-4	1-4	1: WIDE, 2: NORMAL, 3: Dot by Dot, 4: ZOOM	○	
INFORMATION	Model	INF1		Value			
	Serial no.	SRNO		Value			
Temperature sensor	DSTA	R		0	Internal temperature normal		
				1	Internal temperature abnormal has occurred and the monitor is in standby mode	●	
				2	Internal temperature abnormal occurred (To delete the information of temperature abnormal, turn off the main power.)		
				3	Internal temperature abnormal has occurred and backlight brightness is dimmed		
				4	Temperature sensor abnormal		
Temperature acquisition	ERRT	R		Value	Returns the temperature at the temperature sensors. Indicates a temperature sensor abnormality when "126" is returned.	○	
Cause of last standby mode	STCA	W	0		Initialization		
		R	0	No detectable error has occurred			
			1	Standby mode by POWER button or MONITOR OFF button			
			2	Main power off by the main power switch			
			3	Standby mode by control via RS-232C, LAN, or application			
			4	Input signal waiting mode by No Signal			
			6	Standby mode by abnormal temperature			
			8	Standby mode by SCHEDULE setting			
			10	Standby mode by HDMI CEC			
20	Standby mode by OFF IF NO OPERATION setting						
FREEZE	FRMD	WR	0-1	0-1	0: FREEZE release, 1: FREEZE execute	-	
LAN setup	FTP ON/OFF select	FCHE	WR	0-1	0-1	0: FTP connection OFF, 1: FTP connection ON "ERR" when DISABLE is selected for APPLICATION.	
	FTP Username	FUSR	WR	XXXXXXXX	XXXXXXXX	8 characters or less; half-width alphanumeric characters, "-", and "_". (The field cannot be left blank, and spaces cannot be entered.) "ERR" when DISABLE is selected for APPLICATION.	○
	FTP Password	FPAS	WR	XXXXXXXX	XXXXXXXX	8 characters or less; half-width alphanumeric characters, "-", and "_". (The field cannot be left blank, and spaces cannot be entered.) "ERR" when DISABLE is selected for APPLICATION.	

Controlling the Monitor with a computer (LAN)

Your monitor can be connected to a LAN allowing you to control it from a computer on the LAN. The connection requires a commercially available LAN cable (UTP cable, Category 5, straight through).

TIPS

- This monitor must be connected to a network. Set APPLICATION to ENABLE. Configure settings required for connection to a network in "System Settings" – "Ethernet" on the CONTENT MENU screen of APPLICATION mode. To connect by wireless LAN, set "Wireless LAN" of "System Settings" in the CONTENT MENU screen of APPLICATION mode.
- When POWER SAVE MODE is set to ON, the control is disabled in the standby mode.
- To control the monitor via LAN, set MONITOR CONTROL SELECT to LAN. (See page 28.) (When this is done, control via RS-232C or application is not possible.) Set "Telnet Server" to "ON" on "Setup" in APPLICATION mode. (See Software Guide.)

Command-based control

You can control the monitor using RS-232C commands (see page 42) via terminal software and other appropriate applications. Read the manual for the terminal software for detailed instructions.

(1) Connect the computer to the monitor.

1. Specify the IP address and data port number (Default setting: 10008) and connect the computer to the monitor. When connection has been established successfully, [Login:] is returned as response.
2. Send the user name.
 - Send [user name] + [].
 - If the user name is not set, send [].
 - When the transmission is successful, [Password:] is returned as response.
3. Send the password.
 - Send [password] + [].
 - If the password is not set, send [].
 - When the transmission is successful, [OK] is returned as response.

(2) Send commands to control the monitor.

- The commands used are the same as those for RS-232C. Refer to the communication procedure (see page 38) for operation.
- Usable commands are provided in the RS-232C command table (see page 42).

(3) Disconnect the connection with the monitor and quit the function.

1. Send [BYE]. When the transmission is successful, [Goodbye] is returned and the connection is disconnected.

TIPS

- Connection is automatically disconnected when the time specified in AUTO LOGOUT TIME elapses over a no-communication period.

Troubleshooting

If you are experiencing any problem with your display, before calling for service, please review the following troubleshooting tips.

There is no picture or sound.

- The power LED is off.
 - Is power supplied to this monitor?
 - Is the power cord disconnected? (See page 13.)
 - Is the main power switch off? (See page 18.)
- The power LED lights orange.
 - This monitor is in standby mode. Turn on the power. (See page 18.)
- The power LED flashes green.
 - There is no input signal.
 - Is an input mode selected that is appropriate for the input terminal to which the cable is connected? (See page 21.)
 - If any external equipment is connected, make sure the equipment is operating (playing back).

Remote control does not work.

- Are the batteries inserted with polarity (+,-) aligned? (See page 16.)
- Are the batteries exhausted?
- Point the remote control unit toward the monitor's remote control sensor. (See page 16.)
- Is the menu display hidden or is operation disabled? (See page 36.)
- Do the remote control numbers on the remote control unit and on the monitor match?
Check the numbers on INFORMATION. (See page 35.)

The remote control unit's buttons for operating the HDMI-connected device do not work.

- When the input mode is APPLICATION, these buttons operate the application in APPLICATION mode.
- Is HDMI CEC LINK set to AUTO under CEC SETTING on the SETUP menu?
- Is CONTENT MENU BUTTON set to CEC under CEC SETTING on the SETUP menu?
- Switch to a different input mode, and then try switching the input mode back to HDMI.

Sound from left and right speakers is reversed.

Sound is heard from only one side.

- Are audio cables connected properly?
- Check the setting of BALANCE for AUDIO menu.

There is a picture but no sound.

- Is the sound muted?
- Make sure the volume is not set to minimum.
- Are audio cables connected properly?
- Is the setting of AUDIO SELECT on the SETUP menu correct?

Unstable video.

- The signal may be incompatible.
- Try the automatic screen adjustment when D-SUB is in use.

The video from the HDMI input terminal does not appear properly.

- Does the HDMI cable support 4K, and is it HDMI standard compliant? The monitor will not work with cables that are not standard compliant.
- Is the input signal compatible with this monitor? (See pages 52 and 53.)
- If the connected device does not support 4K, set HDMI MODES to MODE2.

The video from D-Sub input terminal does not appear correctly.

- Is the input signal compatible with this monitor? (See page 52.)

The video from the DisplayPort does not appear properly.

- Does the DisplayPort cable support 4K, and is it DisplayPort standard compliant? The monitor will not work with cables that are not standard compliant.
- Is the input signal compatible with this monitor? (See page 52.)
- If the monitors are connected in a daisy chain, turn off the power to all the monitors connected in a daisy chain and then turn the power on again.
- Does the video card support DisplayPort1.2?
If it does not support DisplayPort1.2, set DisplayPort STREAM to SST1.

Control buttons do not work.

There is no picture.

- Load noises from outside may be interfering with normal operation. Turn off the main power and turn it on after waiting at least 5 seconds, and then check the operation.

The input mode changes automatically.

- When CONNECT AUTO INPUT SELECT is ON, the input mode automatically changes to that terminal when a video signal is input into the input terminal.
For this reason, the input mode may change when the computer wakes up from system standby.
- When NO SIGNAL AUTO INPUT SEL. is ON and the current video signal input stops, the input mode automatically changes to the mode of an active video signal.
Consequently, the input mode may change even in the following cases:
 - When a computer enters standby mode.
 - When video play is stopped with a playback device.

Power LED flashes red.

"STATUS [xxxx]" appears in the corner of the screen.

- Hardware has a problem. Turn off the monitor and request repair from your SHARP dealer.
(When STATUS ALERT is set to OSD & LED. This varies depending on the setting.)

When "AUTO DIMMING" is displayed.

- When the internal temperature of the monitor rises excessively, the brightness of the backlight automatically decreases in order to prevent a further temperature rise. If you attempt to adjust the brightness while the monitor is in this state, "AUTO DIMMING" is displayed and you cannot change the brightness.
- Remove the cause of the excessive temperature rise.

The monitor makes a cracking sound.

- You may occasionally hear a cracking sound from the monitor. This happens when the cabinet slightly expands and contracts according to change in temperature. This does not affect the monitor's performance.

The Power LED is flashing in red and green alternately.

When "TEMPERATURE" is displayed in the corner of the screen.

- When the internal temperature of the monitor rises excessively, the brightness of the backlight decreases automatically in order to prevent high-temperature-related problems. When this occurs, "TEMPERATURE" is displayed on the screen and the Power LED flashes red and green alternately. (When TEMPERATURE ALERT is set to OSD & LED. This varies depending on the setting.)
- If the internal temperature rises further, the monitor automatically enters standby mode. (The Power LED continues flashing red and green alternately.)
- Remove the cause of the excessive temperature rise.
 - If the monitor enters standby mode due to a rise in temperature, to return to normal display, turn the power switch off and then back on again. The monitor, however, will enter standby mode again if the cause of the temperature rise is not eliminated. (See page 7.)
 - Check whether the monitor is placed at a location where a quick rise in temperature is likely. Internal temperature rises quickly if the vents on the monitor are blocked.
 - Internal temperature rises quickly if dust accumulates inside the monitor or around the vents. Remove dust if possible. Ask SHARP dealer about removing internal dust.

Specifications

■Compatible signal timing (PC)

Screen resolution		Vsync	Digital		Analog (D-sub)	
			HDMI	DisplayPort		
VESA	640 × 480	60Hz	Yes	Yes	Yes	
		72Hz	Yes	Yes	Yes	
		75Hz	Yes	Yes	Yes	
	800 × 600	56Hz	-	-	Yes	
		60Hz	Yes	Yes	Yes	
		72Hz	Yes	Yes	Yes	
	848 × 480	60Hz	-	-	Yes	
		1024 × 768	60Hz	Yes	Yes	Yes
			70Hz	Yes	Yes	Yes
	75Hz		Yes	Yes	Yes	
	1152 × 864	75Hz	Yes	Yes	Yes	
	1280 × 768	60Hz	-	Yes	Yes	
		75Hz	-	Yes	Yes	
	1280 × 800	60Hz	Yes	Yes	Yes	
	1280 × 960	60Hz	Yes	Yes	Yes	
	1280 × 1024	60Hz	Yes	Yes	Yes	
		75Hz	Yes	Yes	Yes	
	1360 × 768	60Hz	Yes	Yes	Yes	
	1400 × 1050	60Hz	Yes	Yes	Yes	
	1440 × 900	60Hz	Yes	Yes	Yes	
1600 × 1200	60Hz	Yes	Yes	Yes		
1680 × 1050	60Hz	Yes	Yes	Yes		
1920 × 1200	60Hz	-	-	Yes		
Wide	1280 × 720	60Hz	Yes	Yes	Yes	
	1920 × 1080	60Hz	Yes	Yes	Yes	
	3840 × 2160	24Hz	Yes	Yes	-	
		25Hz	Yes	Yes	-	
		30Hz	Yes	Yes	-	
		50Hz	Yes	Yes ^{*2}	-	
		60Hz	Yes	Yes ^{*2}	-	
	4096 × 2160 ^{*1}	24Hz	Yes	Yes	-	
		25Hz	Yes ^{*3}	Yes	-	
		30Hz	Yes ^{*3}	Yes	-	
		50Hz	Yes	Yes ^{*2}	-	
60Hz		Yes	Yes ^{*2}	-		
US TEXT	720 × 400	70Hz	Yes	Yes	Yes	

*1 Displays a reduced image, except in Dot by Dot. In Dot by Dot, the image will be cut down to panel size then displayed.

*2 Compatible when DisplayPort STREAM is SST2.

*3 Compatible when HDMI MODES is MODE1.

- Depending on the connected computer, images may not be displayed properly even if the compatible signal described above is input.

■Compatible signal timing (AV)

Screen resolution	Frequency	HDMI
4096 × 2160p	24Hz	Yes
	25Hz	Yes*
	30Hz	Yes*
	50Hz	Yes
	59.94Hz	Yes
	60Hz	Yes
3840 × 2160p	24Hz	Yes
	25Hz	Yes
	30Hz	Yes
	50Hz	Yes
	59.94Hz	Yes
	60Hz	Yes
1920 × 1080p	24Hz	Yes
	50Hz	Yes
	59.94Hz	Yes
	60Hz	Yes
1920 × 1080i	50Hz	Yes
	59.94Hz	Yes
	60Hz	Yes
1280 × 720p	50Hz	Yes
	59.94Hz	Yes
	60Hz	Yes
720 × 576p	50Hz	Yes
720 × 480p	59.94Hz	Yes
	60Hz	Yes
640 × 480p(VGA)	59.94Hz	Yes
	60Hz	Yes
720(1440) × 576i	50Hz	Yes
720(1440) × 480i	59.94Hz	Yes
	60Hz	Yes

* Compatible when HDMI MODES is MODE1.

■DDC (plug and play)

The monitor supports the VESA DDC (Display Data Channel) standard.

DDC is a signal standard for plug and play between monitors and computers. Information about resolution and other parameters is exchanged between the two. This function can be used if the computer supports DDC and it has been configured to detect plug-and-play monitors.

There are several types of DDC, depending on the communication method used. This monitor supports DDC2B.

Specifications

■ Channels that can be used in wireless LAN

	Standard	Channel	Frequency band (center frequency)
USA	IEEE802.11b/g/n	1-13ch	2412-2472MHz
	IEEE802.11ac/a/n	36/40/44/48/52/56/60/64ch	5180-5320MHz
		100/104/108/112/116/120/124/128/132/136/140ch	5500-5700MHz
		149/153/157/161/165ch	5745-5825MHz
CANADA MEXICO	IEEE802.11b/g/n	1-11ch	2412-2462MHz
	IEEE802.11ac/a/n	36/40/44/48/52/56/60/64ch	5180-5320MHz
		100/104/108/112/116ch	5500-5580MHz
		132/136/140ch	5660-5700MHz
		149/153/157/161/165ch	5745-5825MHz

This device is restricted to indoor use due to its operation in the 5.15 GHz to 5.25 GHz frequency range. FCC requires this product to be used indoors for frequency range 5.15 GHz to 5.25 GHz to reduce the potential for harmful interference to co-channel Mobile Satellite systems. High power radars are allocated as primary users of the 5.25 GHz to 5.35 GHz and 5.65 GHz to 5.85 GHz bands. These radar stations can cause interference with and/or damage this device.

■HDMI input terminal pins
(HDMI Connector)



No.	Function	No.	Function
1	TMDS data 2+	11	TMDS clock shield
2	TMDS data 2 shield	12	TMDS clock-
3	TMDS data 2-	13	CEC
4	TMDS data 1+	14	N.C.
5	TMDS data 1 shield	15	SCL
6	TMDS data 1-	16	SDA
7	TMDS data 0+	17	DDC/CEC GND
8	TMDS data 0 shield	18	+5V
9	TMDS data 0-	19	Hot-plug detection
10	TMDS clock+		

■D-sub input terminal pins
(Mini D-sub 15 pin)

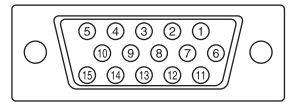

No.	Function	No.	Function
1	Red video signal input	9	+5V
2	Green video signal input	10	GND
3	Blue video signal input	11	N.C.
4	N.C.	12	DDC data
5	GND	13	Hsync signal input
6	GND for red video signal	14	Vsync signal input
7	GND for green video signal	15	DDC clock
8	GND for blue video signal		

■RS-232C input terminal pins
(D-sub 9 pin)

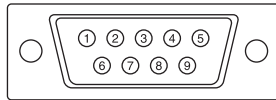

No.	Function	No.	Function
1	N.C.	6	N.C.
2	Transmitted data	7	N.C.
3	Received data	8	N.C.
4	N.C.	9	N.C.
5	GND		

■DisplayPort input terminal pins
(DisplayPort 20 pin)

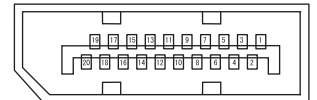

No.	Function	No.	Function
1	MainLane 3-	11	Gnd
2	Gnd	12	MainLane 0+
3	MainLane 3+	13	Gnd
4	MainLane 2-	14	Gnd
5	Gnd	15	Aux +
6	MainLane 2+	16	Gnd
7	MainLane 1-	17	Aux -
8	Gnd	18	Hot-plug detection
9	MainLane 1+	19	Gnd
10	MainLane 0-	20	3.3V

■RS-232C output terminal pins
(Using RS-232C conversion cable (supplied),
D-sub 9 pin)

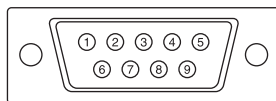

No.	Function	No.	Function
1	N.C.	6	N.C.
2	Received data	7	N.C.
3	Transmitted data	8	N.C.
4	N.C.	9	N.C.
5	GND		

■DisplayPort output terminal pins
(DisplayPort 20 pin)

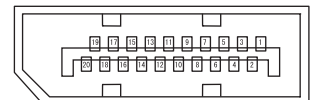

No.	Function	No.	Function
1	MainLane 0+	11	Gnd
2	Gnd	12	MainLane 3-
3	MainLane 0-	13	Gnd
4	MainLane 1+	14	Gnd
5	Gnd	15	Aux +
6	MainLane 1-	16	Gnd
7	MainLane 2+	17	Aux -
8	Gnd	18	Hot-plug detection
9	MainLane 2-	19	Gnd
10	MainLane 3+	20	3.3V

Mounting Precautions (For SHARP dealers and service engineers)

- When installing, removing or moving the monitor, ensure that this is carried out by at least 4 people. (PN-HM651/PN-HB651: at least 2 people.)
- Be sure to use a wall-mount bracket designed or designated for mounting the monitor.
- This monitor is designed to be installed on a concrete wall or pillar. Reinforced work might be necessary for some materials such as plaster / thin plastic board / wood before starting installation.
- This monitor and bracket must be installed on a wall which can endure at least 4 times or more the weight of the monitor. Install by the most suitable method for the material and the structure.
- To attach a VESA-compliant mounting bracket, use M6 screws that are 5/16 inch (8 mm) to 3/8 inch (10 mm) longer than the thickness of the mounting bracket.

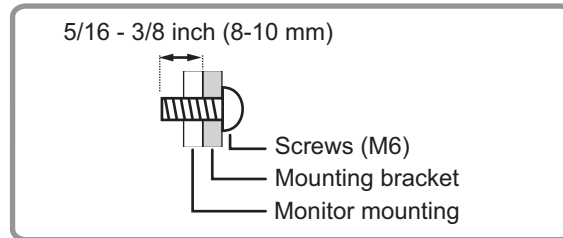

- Do not use an impact driver.
- When moving the monitor, be sure to hold the handles or the parts marked by  below. Do not hold the screen. This may cause product damage, failure, or injury.

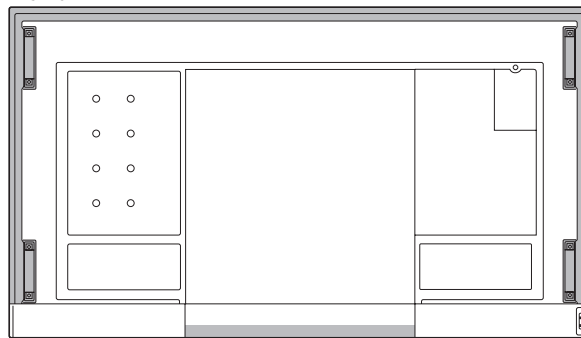

- After mounting, please carefully ensure the monitor is secure, and not able to come loose from the wall or mount.
- Do not use any screw holes other than those for mounting brackets, located on the rear of the monitor, for installation.
- When using this monitor laying flat on a surface (when the monitor is tilted more than 20 degrees upward from the perpendicular in relation to a level surface), consult an authorized SHARP dealer because there are some specific mounting conditions.

SHARP[®]
SHARP CORPORATION