

DT-311J Digital Stroboscope

Operation Manual



CAUTION

Do not apply a strong shock or rapid temperature change to unit. Especially, do not leave it where temperature will rise: for instance, in a closed automobile, exposed to direct sunlight, near a stove, open flame, etc.

This instrument is water-proof. Do not spray or immerse in water. Do not open and disassemble the unit. Make sure of proper voltage!

Do not use stroboscope in an explosive atmosphere as it generates high electrical energy pulses.

To avoid potential eye damage, do not look directly at flashes. Before operation, make sure there is no damage on the provided AC voltage line cable. If the cable is damaged, replace it with a new one.

To protect against water drips, carefully thread the power cable connector firmly to the stroboscope. After metal connector of the cable has been properly fitted onto the body, the power cable can then be safely plugged into a properly grounded AC receptacle.

To prevent getting burned, let lamp cool after use before attempting replacement.



DT-311J NEMA 4X Stroboscope for Harsh Wet Work Areas

Where powerful illumination and rugged speed measuring accuracy is required for the textile industry, the DT-311J will perform where other stroboscopes will not. The DT-311J is used to set injection timing, injection pressure, timing of shedding and weft running time of weaving machinery. Units combine rugged NEMA 4X (IP65) housing with high performance accuracy, special phase shifting, with shock absorbing components and top mounted handle, allows the equipment operator maximum flexibility when setting the timing of weaving machinery.

SPECIFICATIONS

Phase Shift: 0 – 359° / 1° increments

Flash Rate/Phase Angle Setter: Rotary dial

Display: 4 digit 0.39 in (10 mm) high red LED

Divide Ratio: 1/1, 1/2, 1/3, 1/4, 2/4 with shift

Input Signal: High level: 5-24 V pulse; Low Level: 0-1 V pulse. 2 msec minimum. Impedance less than 10k Ω

Input Impedance: 47k

Display Mode: Phase shift (degree), Tachometer

Accuracy: ±1 digit

Internal Signal Range: 200-1500 FPM

Flash Range: 200-1500 FPM

FlashTube: Xenon lamp Max: 10w at 1,500 rpm. Life: 1,200 hours at 1,500 rpm

Power Requirement: 115VAC±5% 50/60Hz

Power Consumption: 20VA max

Operating Temperature: 32 to 104°F (0 to 40°C)

Product Weight: 4.2 lbs (1.9 kg)

Package Weight: 6.2 lbs (2.81 kg)

Included Accessories: 19.68' (6m) input/power cable with connector, rubber strobe guard w/ handle

CONFIGURATION

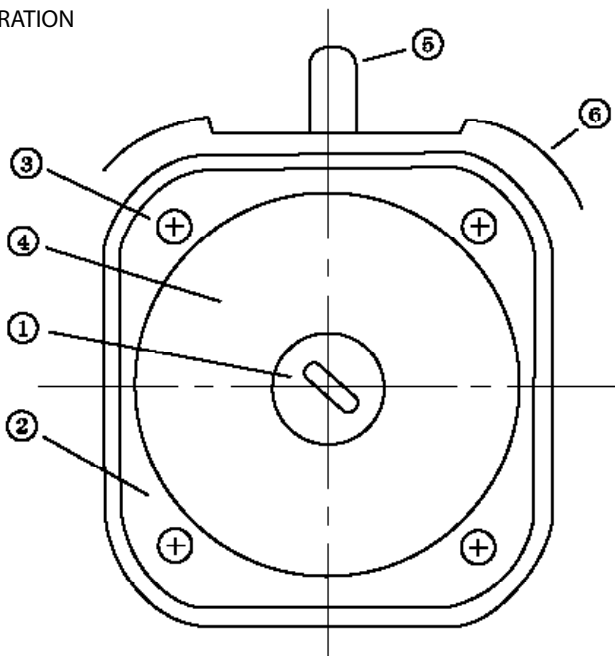

A. Front panel

- Xenon lamp
- Protective window
- Protective window screws
- Reflector
- Handle
- Protection mule

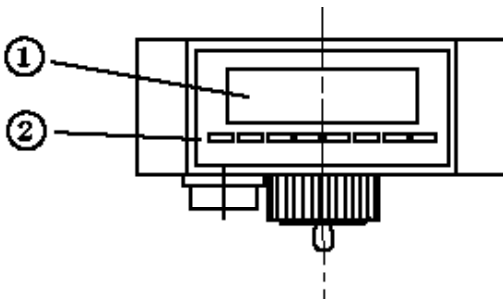

B. Rear (Display & Operation panel)

- Delayed angle or rpm display
- Mode indicators

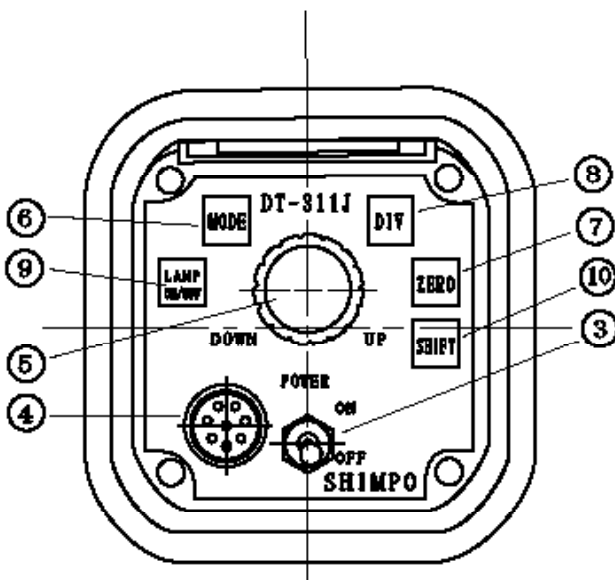

C. Operation part

- Power switch
- Connector
- Mode select switch
- Setting knob: for Flash Rate and Phase Shift adjustment
- Zero setting switch
- Divide ratio select switch
- Stroboscope flash: on/off switch
- Shift switch

CABLE CONNECTION

Connect power and signal with provided cable as follow.

- AC plug (with 3-prong plug) 110 VAC or 230 VAC at 50/60 Hz
- Red clip signal (positive)
- Black clip 0V

MODE SELECTION

Press (MODE) switch (5) to select internal or external signal mode.

EXTERNAL SIGNAL OPERATION

When external signal mode is selected ('deg' or 'rpm' LED on), flashing rate is synchronized with the external signal. The phase shift range can be set between 0 - 359° - 0 - 359° continuously. And also it's available to display the rotation speed (rpm unit).

deg..... Delayed Angle..... degree
 rpm..... Number of revolution per 1 minuterpm

DIVIDE RATIO SETTING(See 8.Flash interval for detail)

- Select 1/1 to provide a flash per every 1 rotation.
- Select 1/2 to provide a flash per every 2 rotations.
- Select 1/3 to provide a flash per every 3 rotations.
- Select 1/4 to provide a flash per every 4 rotations.
- Select 2/4 to provide two continuously flashes per 4 rotations.

PHASE SHIFT

Turning the Phase Shift setting knob clockwise or counterclockwise, the flashing phase will be shifted. Pressing the zero set button(ZERO) makes the display "0" at any angle.

FLASH INTERVAL

FLASH MODE

Flashing behavior at each mode.

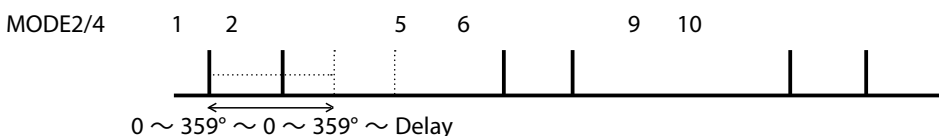
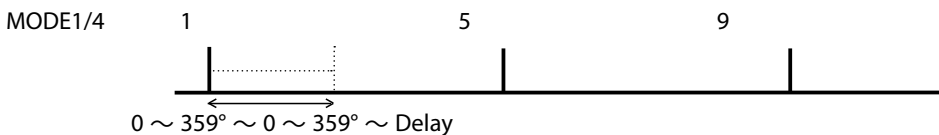
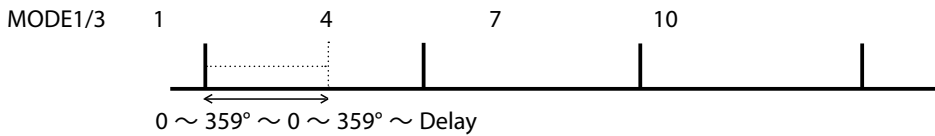
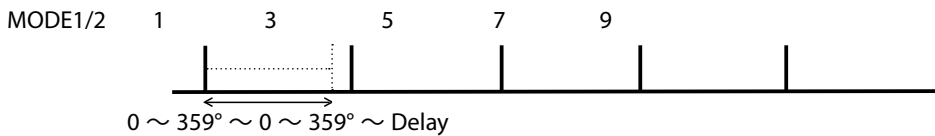
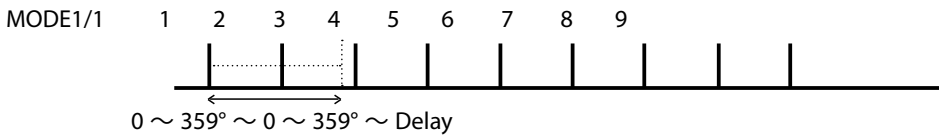
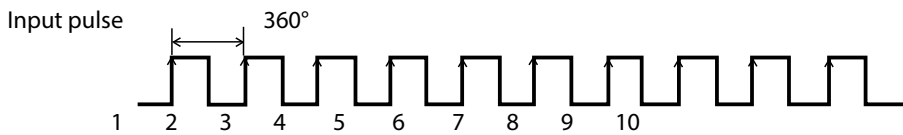

PHASE MODE

Every time you depress the shift button (SHIFT), the flashes slide to the next pulse.

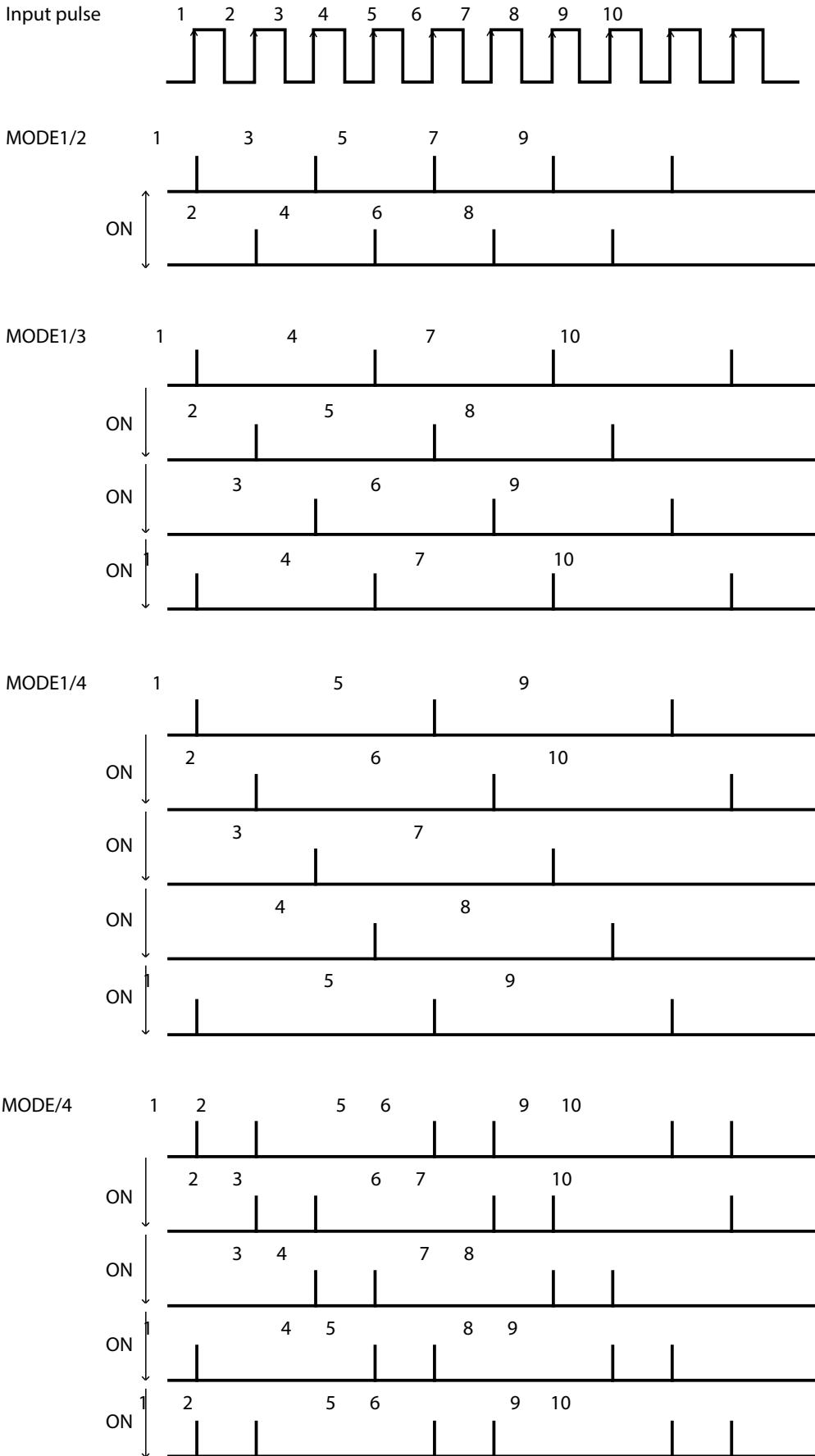

9. LAMP ON/OFF SWITCH

LAMP ON/OFF switch can stop flashing. To save lamp life, turn lamp off while not in operation. After the power is on, if no adjustments are made during the next 30 minutes, flashing will automatically turn off after 30 minutes and the

ALARMS

LOW SPEED INDICATOR(External signal operation only)Below 180rpm under symbol appears.

At degree mode

under symbol

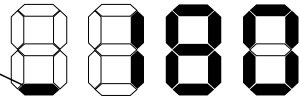

At rpm mode

under symbol

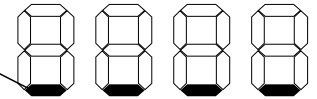

HIGH SPEED INDICATOR(External signal operation only)Over 1,650rpm over symbol appears.

At degree display

over symbol



At rpm display

over symbol

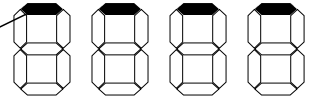

If AC power is low, the flashing will stop and "LLLL" will be displayed.

If an alarm symbol appears, ("under", "over") the stroboscope flash will not function.

INPUT CIRCUITRY

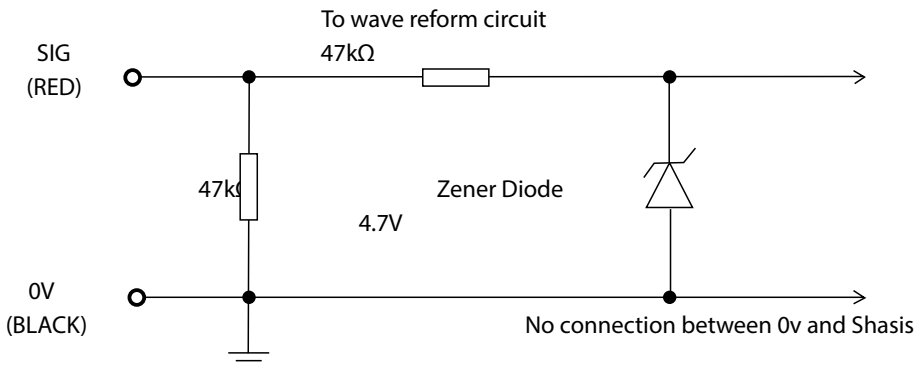

LAMP REPLACEMENT

Lamp life is about 100 million flashes. Although rotation speed is displayed, no flash is emitted. When the flash is intermittently emitted, this indicates the lamp must be replaced. Be sure to replace flash tube with the specified lamp: (FLASHTUBE311-J)

Procedures:

- 1)After unplugging the line cable from the power line, let the stroboscope sit for 30 minutes or longer. Be sure stroboscope is cool to the touch before replacing the lamp.
- 2)Remove the lamp protection window by loosening the 4 screws on the window. Insert a fine screw driver into a hole of the protection window and pull out.
- 3)Remove the reflector and pull out the lamp base(Glass portion). Caution, do not pull out the lamp glass portion directly.
- 4)Do not touch the flash tube with fingers. Use a clean cloth. Press the lamp base to the socket in the proper direction to install the new lamp. *Do not touch to glass portion of the lamp.
- 5)Important: In order to maintain protection against water, be sure to mount the Protection cover in the center. Fix the protective window with the 4 screws and the sealing washers.(Tightening torque: 0.5Nm)

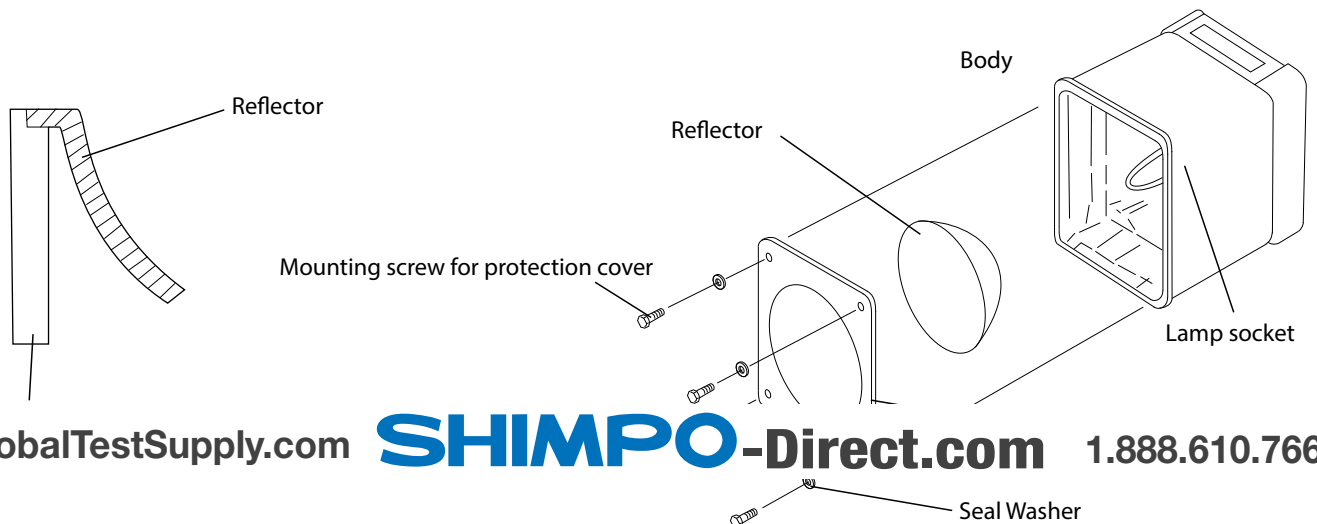

DT-311J Dimensions

