



STROBOSCOPE

DT-3015N

INSTRUCTION MANUAL

Read this manual thoroughly before use.

Before use, please carefully read these safety precautions as well as instructions,
and follow them for proper operation.

Safety Precautions

Be sure to observe

Be sure to read the entire instruction manual thoroughly before initial set-up, operation and maintenance.

The instruction manual provides two grades of safety warnings: "Danger" and "Caution". Each of them is an important description related to safety. Be sure to observe.



Danger

This indicates the possibility of fire, severe injury, and even death if a user disregards the instruction and operates the unit improperly.



Caution

This indicates the possibility of minor injury or property damage if a user operates the unit improperly. However, depending on the circumstances, there is still the possibility that severe injury may result. Be sure to observe.

We categorize the type of those precautions using the following symbols throughout the manual.



A prohibited action you must not do.



A forced action you must always do.



Danger



Never use in flammable environments.
May result in fire.



Never look directly into the light source.
May result in eye injury.



Caution



Do not apply strong impact to the unit, or drop it.
Failure to follow this could result in abnormal operation.



Avoid the followings.
Water, direct sunlight, condensation, dust, dirt, salt, iron, oil, chemicals, corrosive and/or combustible gases.



Do not alter, modify or dispose improperly.
Failure to follow this could result in injury due to abnormal operation.



Operate within 0-35°C(32-95°F)
Failure to follow this could result in malfunction.



Wipe clean the unit with a soft dry cloth if it gets dirty.
Or immerse a cloth in water diluted neutral detergent, wring it, and wipe clean the unit with it.
Do not use any volatile chemicals, such as benzine, thinner, or alcohol.



Operate within 45-85%RH
Failure to follow this could result in malfunction.



Since continuously emitting light for long time causes the unit's housing to heat up, fix the strobe using a tripod, etc. (Avoid direct skin contact with the unit, such as holding it by hand).
Failure to follow this could result in mild burns.

Contents

1	Overview of this product	3
2	Before use	3
2.1	Checking the supplied items	3
2.2	Charging	4
2.2.1	Charging method	4
2.2.2	Indication of low battery voltage (LOWBAT)	5
3	Part names and functions	5
3.1	Main unit	5
3.2	Operation Panel	6
3.3	Display	7
3.3.1	Part names and function instructions	7
4	Function and operations	8
4.1	Power ON / OFF	8
4.1.1	LAMP ON / OFF	9
4.1.2	Flash timer	9
4.1.3	Heat Lamp Indicator	9
4.2	Emission mode and settings	10
4.2.1	How to switch INT and EXT	10
4.3	Internal oscillation emission	11
4.3.1	FPM mode setting (INT)	11
4.3.2	PHA mode (INT)	13
4.4	External synchronous emission	14
4.4.1	FPM mode setting (EXT)	15
4.4.2	PHA mode setting (EXT)	16
4.5	Function mode	17
4.5.1	The setting items	17
4.5.2	Instructions about function mode	18
4.6	Saving function	24
4.6.1	Saving the setting values	24
4.6.2	How to save the setting values	25
4.6.3	Initialize	26
4.6.4	Initializing the setting values	27
4.7	Reading memory function	28
4.7.1	Reading values	28
4.7.2	How to read the memory	28
4.8	External signal I/O connector specifications and Pin assignment	29
4.9	External pulse input	30
4.10	External pulse output	30
4.11	Lamp replacement	31
4.12	Battery replacement	32
5	Specifications	33
5.1	Specifications list	33
5.2	External dimensions	34
6	Troubleshooting	35

1 Overview of this product

A stroboscope tachometer is a measurement instrument to measure the speed (cycle) of rotating objects that rotate at a constant speed, or moving objects that repeatedly operate at a constant cycle. When the rotation (motion) cycle matches with the flash cycle while the strobe flash is periodically applied on a rotating or moving object, the rotating (moving) object image appears to stand still. This stroboscope tachometer is the non-contact type, and can be used to read the object frequency when such a still image appears. Also, a stroboscope can be used to make images of rotating or moving objects stand still or that slightly move in order to observe their appearance in slow -motion.



Main features

- Wide flash range – 30 to 35000 FPM(flashes per minute)
- Emission in synchronization with the external trigger pulse
- Phase Shift function.(PHA mode)
- Rechargeable

2 Before use

2.1 Checking the supplied items

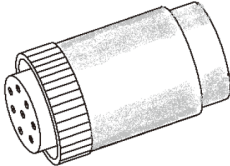
Check that the five items below are supplied.

Main unit	<p style="text-align: center;">One(1) DT-3015N</p> 
Accessories	<p style="text-align: center;">One(1) External signal I/O connector (8 pins) RM15WTPZ-8S(71)</p> 
	<p style="text-align: center;">One(1) Dedicated AC adapter (3m)</p> 
Instruction Manual	One(1) This document
Warranty	One(1) document

2.2 Charging

Be sure to charge the battery before initial use.

Before charging, be sure to check that the power is turned OFF.

Please check the state of the power switch OFF with the picture in "3.1 Main unit" on page 6.

2.2.1 Charging method

Turn the power OFF, and connect the AC adapter's connector to the main unit.

Next insert the AC adapter's AC plug into an outlet. The battery lamp lights up, and charging starts.

Charging is complete in approximately 2 hours, and then the charging lamp goes off.

The battery lamp (B-CHG)	State
Off	AC adapter not connected, or Charging complete
Flash	Charging error (Stop charging)
Continuous light	Charging

*Be sure to use the supplied AC adapter.

*Use at the ambient temperature 15°C or higher.

(If the ambient temperature is lower than 15°C, Charging may not be possible.)

*If the battery overheats, a charging error may occur.

In this case, let the internal temperature decrease and then reconnect the AC adapter.



Remove the connector cover,
and connect the AC adapter

Note 1) When the power is turned ON during charging, charging is canceled and emission starts. When the unit uses the AC adapter as its power source, it is not charged. (Note that emission and charging cannot be performed simultaneously.)

Note 2) Though the unit can be charged while battery power still remains, charging will still end when fully charged. It is recommended, however, that the unit be charged when the battery has run out ("LLLLLL" is indicated on the display) to avoid reducing the battery life itself.

Note 3) If the unit is charged immediately after a long emission time at a high ambient temperature, the temperature detection circuit will turn on, and the charging lamp may not light up. In that case, disconnect the AC adapter, and let the unit cool. When the product temperature has decreased, connect the AC adapter again and start charging.

Note 4) Using in a high temperature environment may shorten the battery life.



Never charge the unit under the following conditions.

- Using another AC adapter than supplied
- Charging near flammable materials

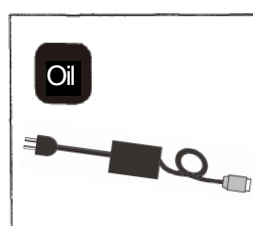
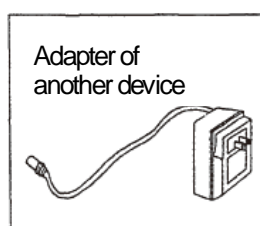

3.2 Operation Panel

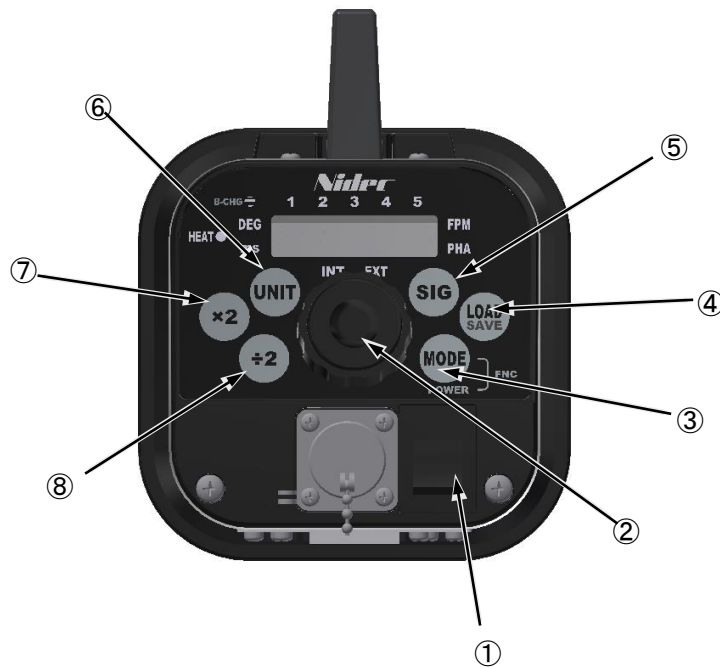

No.	Key	Function Instructions
①	Power Switch	Turns the power ON / OFF
②	Dial (LAMP POWER)	Turn this clockwise or counterclockwise to change the emission frequency and some setting value. Press and hold the center of this to turn the lamp ON / OFF.
③	MODE	Press this to switch the LED display as follows Flashes Per Minute mode (FPM mode) → Phase Shift mode (PHA mode DEG = delay angle) → Phase Shift mode (PHA mode ms = delay time) → FPM mode →...
④	LOAD(SAVE)	Press this to load the saved settings. Also, Press and hold this to save the current display and mode settings.
⑤	SIG	Select Internal/ External/ Parameter mode. Internal oscillation emission (referred to as "INT") : Flash by internal signal External synchronous emission (referred to as "EXT") : Synchronized flash with external signal
⑥	UNIT	Each press of this switches the delay type as following, delay angle(DEG) → delay time(ms) → DEG → ms
⑦	×2	Press this while on INT to double the current set emission count (frequency). (*If the double count is over than the flash range, nothing will change on the display.)
⑧	÷2	Press this while on INT to halve the current set emission count (frequency). (*If the half count is lower than the flash range, nothing will change on the display.)

3.3 Display

3.3.1 Part names and function instructions

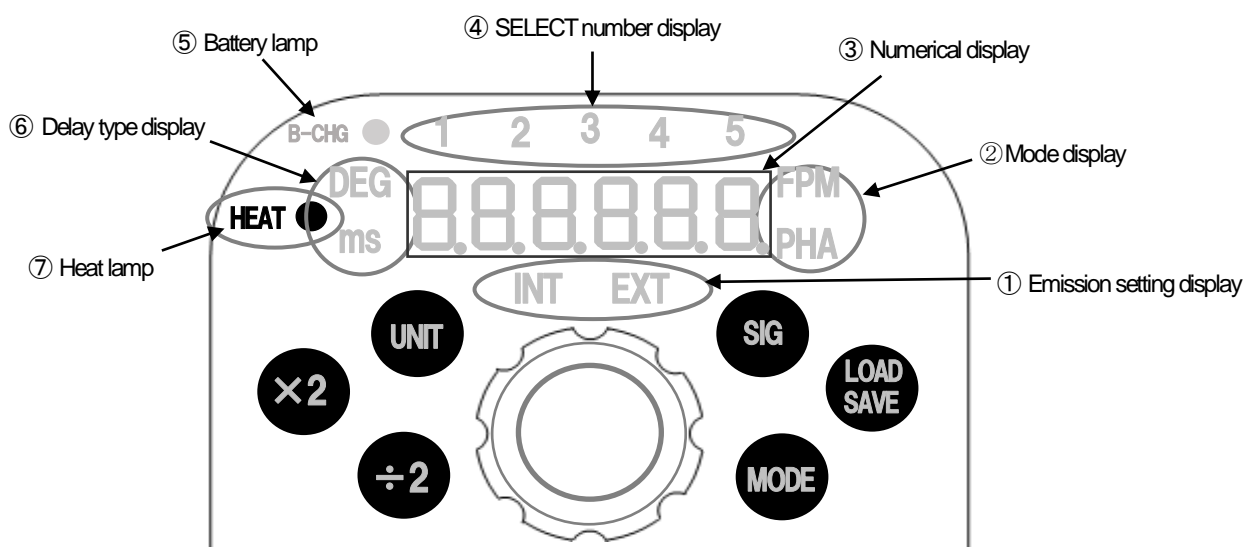

No.	Key	Display	Instructions
①	Emission setting display	INT	Each press of "SIG" switches emission settings. INT : Internal oscillation emission EXT : External synchronous emission
		EXT	
②	Mode display	FPM	Each press of "MODE" switches flashing mode and delay type. FPM : Flashes per minutes mode / PHA : Phase mode
		PHA	
③	SELECT number display	1 2 3 4 5	This indicates the memories for saving. (called SELECT number) Each press of "LOAD" switches SELECT number (1 to 5)
④	Numerical display		Standard Operation : indicates flash rate. PHA Mode : Angle and Time are displayed. Function Mode : Each setting value is indicated.
⑤	Battery lamp	B-CHG	Lights up while charging, and goes off when charging is complete. Flashes if charging error.
⑥	Delay type display	DEG	Each press of "MODE" switches flashing mode and delay type. DEG : delay angle / ms : delay time (millisecond)
		ms	
⑦	Heat lamp	HEAT	When the ambient temperature of the Xenon lamp rises above a certain level, this lamp indicator will flash.

4 Function and operations

4.1 Power ON/OFF

Press the power switch when the power is OFF to turn the power ON.

When power is turned ON, the model is indicated, followed by internal oscillation emission or external synchronous emission.

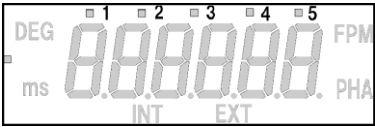
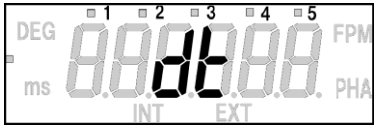
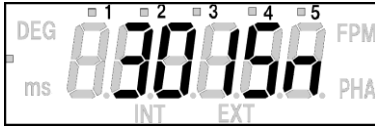
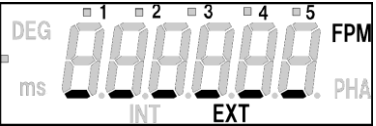
Operation	Display
When the power is OFF	
Press the power switch	 <p>Displayed "dl" for 0.5 sec.</p>
	 <p>Displayed the model for a sec.</p>
	 <p>When turning the power on for the first time, "EXT FPM mode" is displayed. From the second time on, the same as when the power is previously turned OFF is displayed.</p>

Press the power switch when the power is ON to turn the power OFF, then the indication goes off.

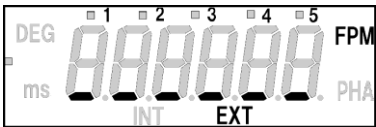
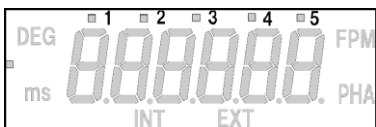
Operation	Display
When the power is ON	
Press the power switch	 <p>Indicated letters go off</p>

*When the power is turned ON, the following indication may be displayed.

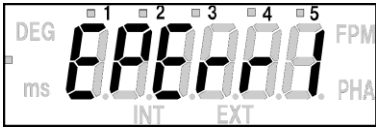
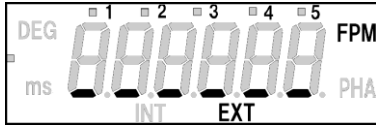

The following indication is an error message when the reading previously used setting value fails.

Press the "MODE" to return to normal emission screen from the error message display.

Operation	Display
 <p>Press the "x 2"</p>	 <p>Error message</p>
	 <p>Returns to the normal emission screen</p>

4.1.1 LAMP ON/OFF

Press and hold the center of the dial to turn ON the LAMP when emission setting is displayed on the screen.
Press and hold again while flashing to turn OFF the LAMP.

Operation	Display
 <p>Press and hold</p>	 <p>Press and hold the dial to flash. Press and hold again to stop flashing.</p>

*When turning the power switch OFF while flashing, it will be turned ON flashing at the next time.

4.1.2 Flash timer

When the Flash timer is set to a value other than 0 [minutes] in Function mode 3, the flashing will automatically cease after set time from the start of the light emission.
When the flashing stops by this flash timer, the display indicates "OFF".
Press and hold the dial to return to the previous display.

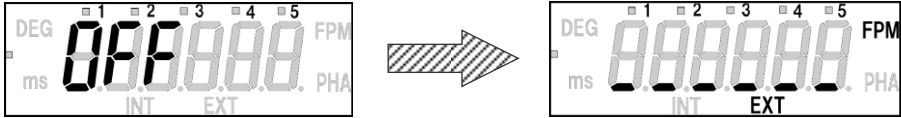
Operation	Display
 <p>Press and hold</p>	 <p>After set time from the start</p> <p>Return to the previous display</p>

4.1.3 Heat Lamp Indicator

When the ambient temperature of the Xenon lamp rises above a certain level, the Heat Lamp Indicator will flash.
If the temperature rises more, the Heat Lamp Indicator will remain on and the light emission will cease.

*The temperature tends to rise more quickly the higher the emission frequency is set.

The ambient temperature of the Xenon lamp	HEAT	Light emission
Less than 65°C (149°F)	Off	Keep flashing
Over 65°C (149°F)	Flash	Keep flashing
Over 70°C (158°F)	On	Stop flashing

4.2 Emission mode and settings

Emission mode	Instructions
Internal oscillation emission ("INT")	Flash at the set frequency.
External synchronous emission ("EXT")	Flash in synchronization with the external trigger pulse.
Function mode	Configure the settings.

4.2.1 How to switch INT and EXT

Each press of "SIG" switches "INT" and "EXT".

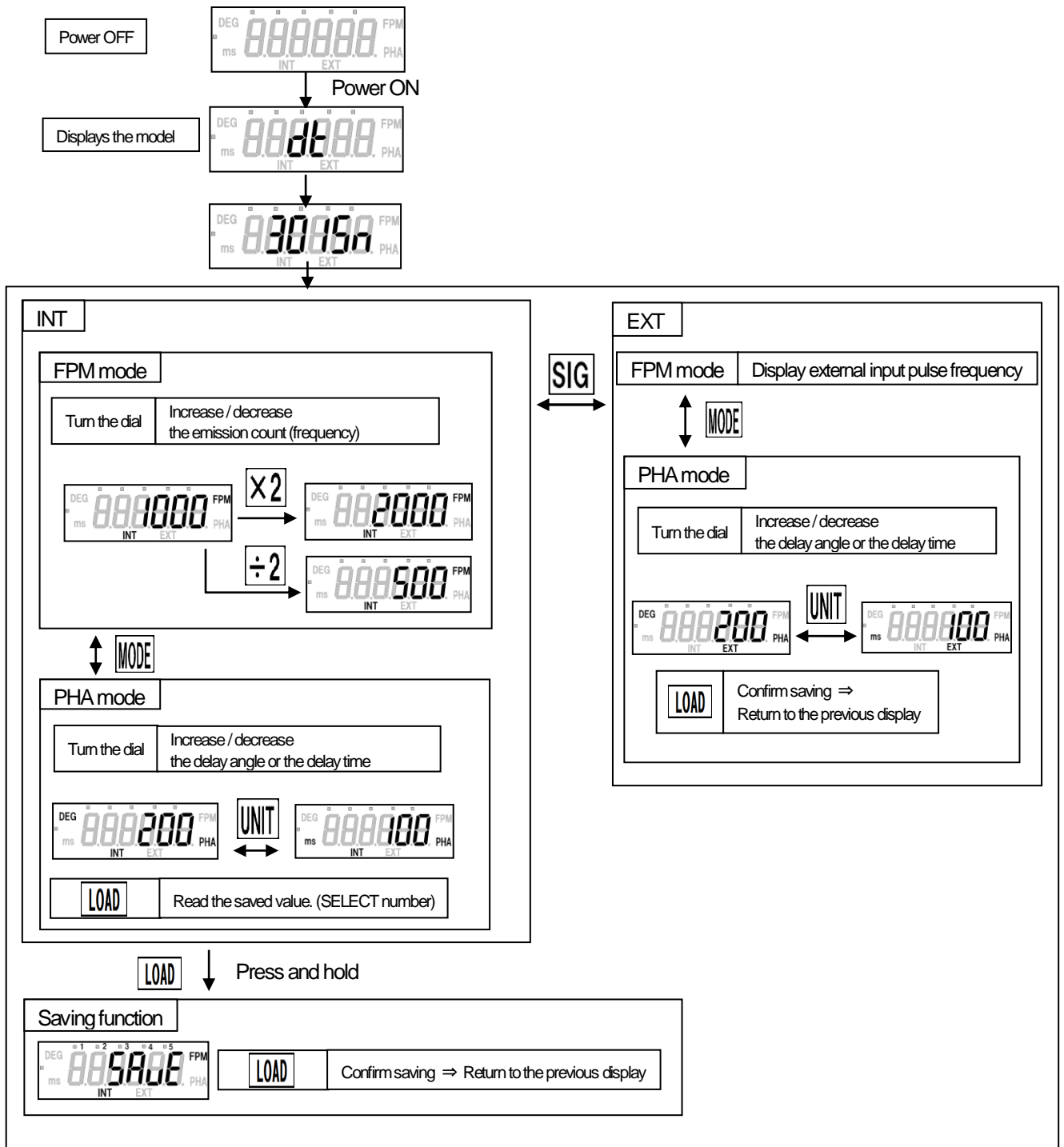

4.3 Internal oscillation emission

- On "INT", the Xenon lamp flashes at the displayed emission count.
- "INT" has the following 2 mode settings.

Mode settings	FPM mode	PHA mode
Instructions	Set the emission count per minute [FPM] (flashes per minute)	Shift the timing of flash. The phase can be changed by a degree or a millisecond. (One cycle is 360°)

Display of INT

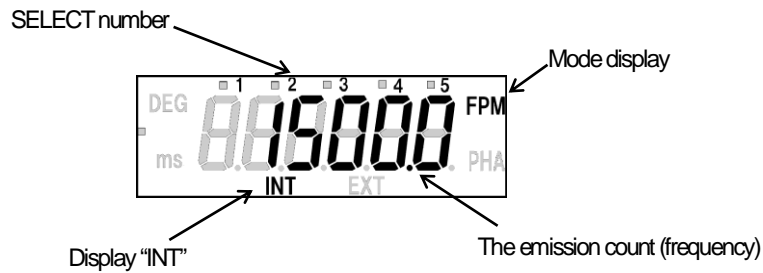



4.3.1 FPM mode setting (INT)

The emission count (frequency) can be set in FPM mode.

Turn the dial in a CW direction to increase the emission count, and in a CCW direction to decrease it.

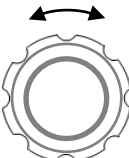
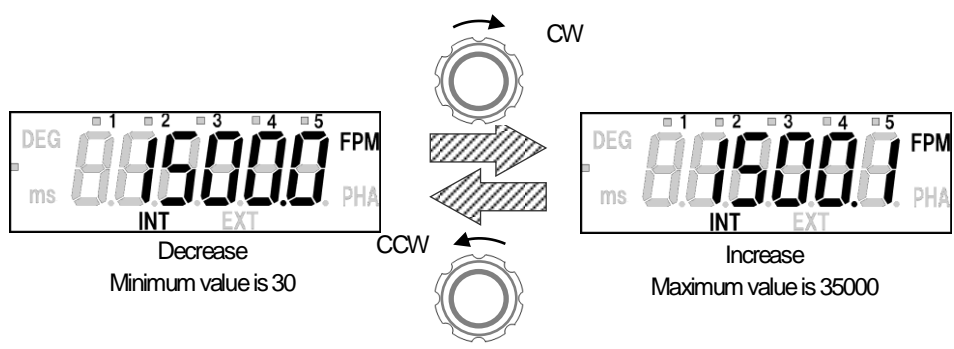
(Turn the dial fast to change the setting value greatly, and slowly to change it slightly.)

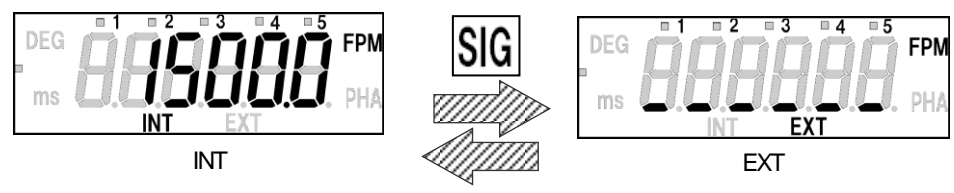
Operation	Display
 <p>Increase / decrease The emission count (frequency)</p>	 <p>Decrease Minimum value is 30</p> <p>Increase Maximum value is 35000</p>
 <p>Press "SIG" to switch to the "EXT"</p>	 <p>INT</p> <p>EXT</p>

4.3.2 PHA mode (INT)

When the rotation (motion) cycle of a measured object matches with the strobe flash cycle, the measured object appears to stand still. Use the PHA mode in order to adjust the stop angle (position).









The phase can be changed by 1° using dial within the range between 1° and 359° in the PHA mode.

Press "UNIT" to switch to PHA mode (ms).

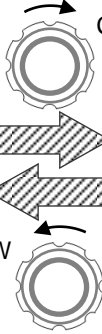
(The phase can be changed by 0.01 [ms] within the range between 0.00 and 999.99 [ms] and by 0.1 [ms] within the range between 1000.0 and 1994.4 [ms].)

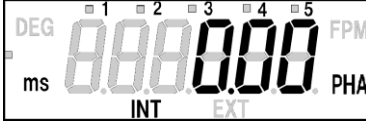
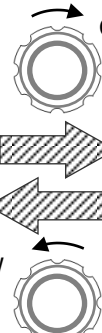
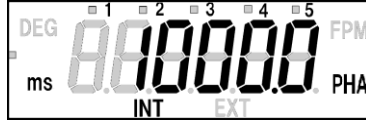
A time longer than the light emission cycle cannot be set. (PHA mode ms)

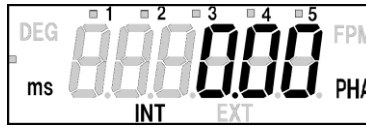
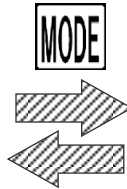
Press "MODE" in PHA mode to switch to FPM mode.

Operation	Display
 <p data-bbox="229 891 456 949">Increase / decrease Delay angle / time</p>  <p data-bbox="217 1133 469 1191">Each press of "UNIT" switches DEG to ms</p>	<div style="display: flex; justify-content: space-around;"> <div data-bbox="517 748 884 931"> <p>Decrease delay angle</p>  <p>PHA mode (DEG)</p> </div> <div data-bbox="884 676 1066 1008">  </div> <div data-bbox="1066 748 1433 931"> <p>Increase delay angle</p>  </div> </div> <div style="display: flex; justify-content: center; margin: 10px 0;">  </div> <div style="display: flex; justify-content: space-around;"> <div data-bbox="517 1133 884 1317"> <p>Decrease delay time</p>  <p>PHA mode (ms)</p> </div> <div data-bbox="884 1048 1066 1379">  </div> <div data-bbox="1066 1133 1433 1317"> <p>Increase delay time</p>  </div> </div>
 <p data-bbox="197 1554 478 1612">Press "MODE" to switch to FPM mode</p>	<div style="display: flex; justify-content: space-around;"> <div data-bbox="517 1464 884 1626">  <p>PHA mode</p> </div> <div data-bbox="916 1451 1043 1639">  </div> <div data-bbox="1066 1464 1433 1626">  <p>FPM mode</p> </div> </div>

4.4 External synchronous emission

- External synchronous emission is the function to emit a strobe flash in synchronization with an external trigger pulse input.
- You can set which edge of the external trigger pulse triggers emission, the rising edge or falling edge.
- A timing (delay) from the external trigger pulse input with the strobe flash emission can be optionally set using time and angle.
- EXT has the following 2 mode settings.

Mode setting	FPM mode	PHA mode
Instruction	Display the measured value of the emission count (frequency). The unit is FPM (flashes per minute)	Shift the timing of flash. The phase can be changed by a degree or a millisecond. (One cycle is 360°)

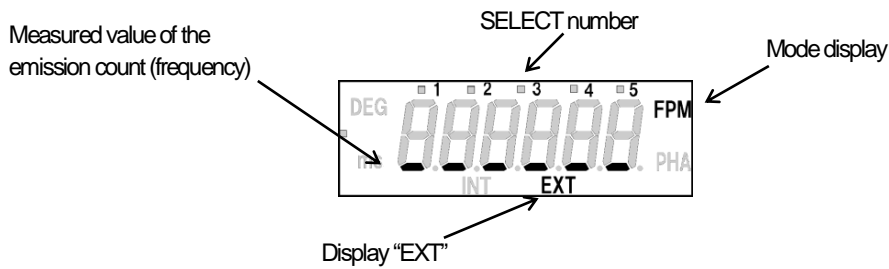

*If the external trigger pulse cycle is beyond the specifications range, the following letters are indicated.

[Without the delay angle / time setting]

Measurable range 27 to 35020 [fpm]

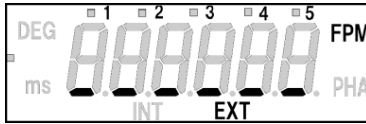

When the external input pulse frequency goes below 27 [fpm], underlines are displayed.



When the external input pulse frequency goes beyond 35020 [fpm], overlines are displayed.

[With the delay angle setting]

Measurable range 27 to 35020 [fpm]



When the external input pulse frequency goes below 27 [fpm], an underline on the first, left two digits is displayed.

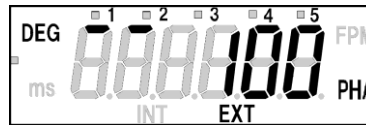

When the external input pulse frequency goes beyond 35020 [fpm], an overline on the first, left two digits is displayed.

[With the delay time setting]

Measurable range 27 to 35020 [fpm]

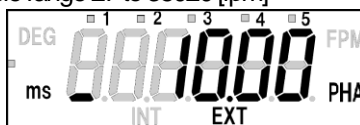

When the external input pulse frequency goes below 27 [fpm], an underline on the first, left two digits is displayed.



When the external input pulse frequency goes beyond 35020 [fpm], an overline on the first, left two digits is displayed.

4.4.1 FPM mode setting (EXT)

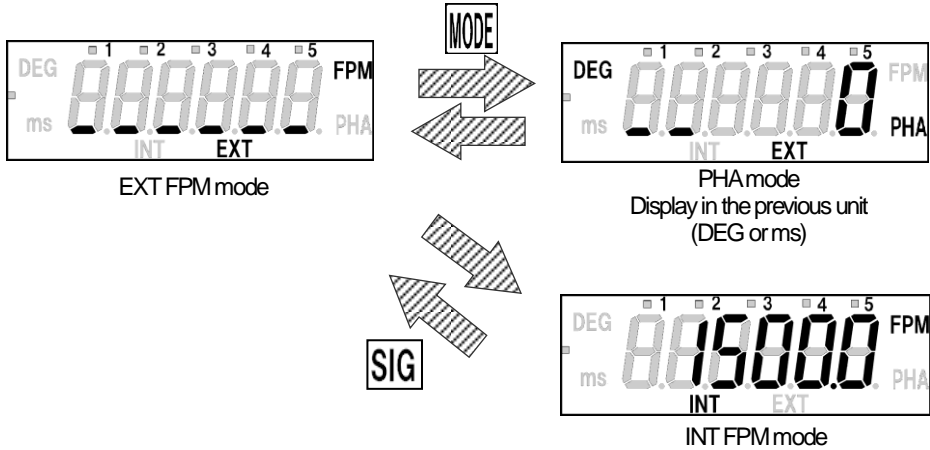
Operation	Display
<p data-bbox="272 443 352 517">MODE</p> <p data-bbox="193 524 424 584">Press "MODE" to switch to PHA mode</p> <p data-bbox="272 633 352 707">SIG</p> <p data-bbox="193 714 437 775">Press "SIG" to switch to INT</p>	 <p data-bbox="604 544 762 568">EXT FPM mode</p> <p data-bbox="1187 544 1294 568">PHA mode</p> <p data-bbox="1121 566 1366 618">Display in the previous unit (DEG or ms)</p> <p data-bbox="1177 792 1323 817">INT FPM mode</p>

4.4.2 PHA mode setting (EXT)

Delay emission can be set within the input signal range between 27 and 35020 [fpm].





In the PHA mode, the phase from the external trigger pulse entry to strobe flash emission can be changed by 1° using the dial within the range between 1° and 359°.

Press “UNIT” to toggle between PHA mode (DEG) and PHA mode (ms).

The phase can be changed by 0.01 [ms] within the range between 0.00 and 999.99 [ms], by 0.1 [ms] within the range between 1000.0 and 2216.0 [ms].

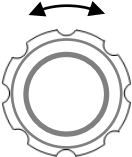
A time longer than the light emission cycle cannot be set. (PHA mode ms)

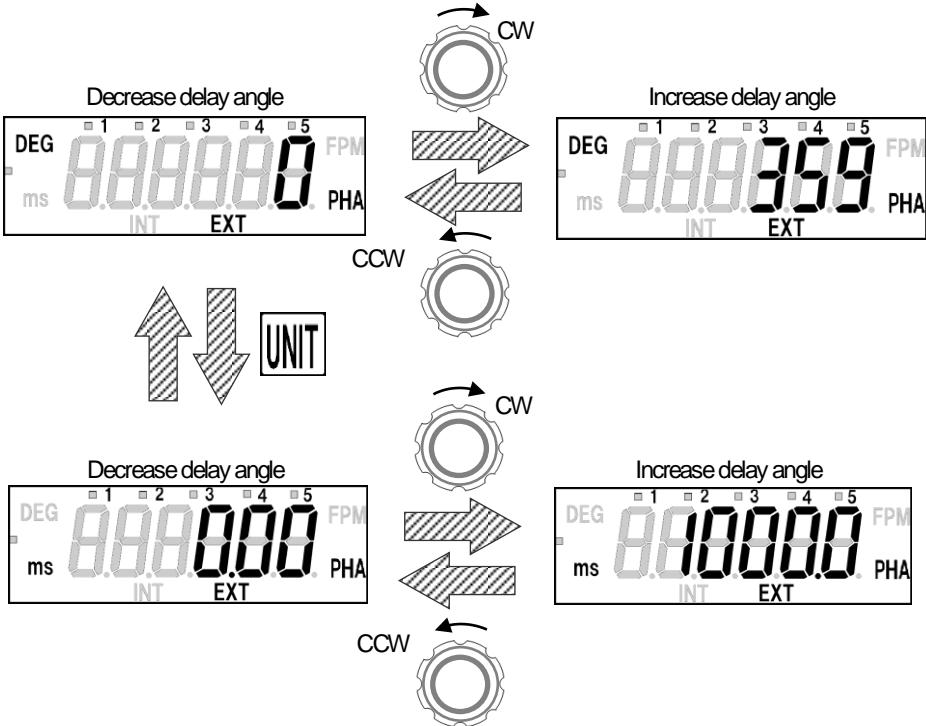
Press “MODE” in PHA mode to switch to FPM mode.

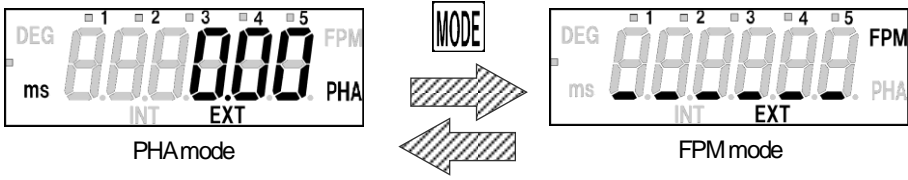
Operation	Display
 <p data-bbox="213 927 427 987">Increase / decrease Delay angle / time</p>  <p data-bbox="185 1171 440 1232">Press “UNIT” to toggle between DEG and ms</p>	 <p data-bbox="619 792 823 822">Decrease delay angle</p> <p data-bbox="1187 792 1378 822">Increase delay angle</p> <p data-bbox="890 958 948 987">CCW</p> <p data-bbox="890 1339 948 1368">CCW</p> <p data-bbox="799 1016 863 1084">UNIT</p>
 <p data-bbox="185 1608 416 1668">Press “MODE” to switch to FPM mode</p>	 <p data-bbox="676 1659 788 1688">PHA mode</p> <p data-bbox="1225 1659 1337 1688">FPM mode</p> <p data-bbox="979 1525 1043 1592">MODE</p>

4.5 Function mode

Turn the power ON while pressing the “MODE” to enter the function mode.











During the function mode, turn the dial (CW/CCW) to change the settings.

And press “MODE” to save the setting and move to the next setting item. (F1⇒F2⇒F3⇒F4⇒F5⇒F6 end)

If the power is turned OFF in the middle of the function mode, the changed value will not be saved in the memory.

4.5.1 The setting items

The setting items in the following table can be configured in the function mode.

F1	Set to add decimal point (for INT and EXT FPM mode)
	Add decimal point
	No decimal point
F2	Trigger edge setting (for EXT)
	Flash in the rising edge.
	Flash in the falling edge.
F3	Auto emission stop time setting
	Emission is performed continuously
	Stop emission automatically when no operation is performed for a certain period of time and display “OFF”. The available setting time is within the range between 0 [min] and 120 [min], which can be changed by 1 [ms]
F4	Choose the input circuit
	Open collector input
	Voltage pulse input
F5	Measurement range setting (for INT)
	The maximum value of the emission count can be set within the range between 30 and 35000 [rpm] (The value is limited to the maximum.)
F6	Set the pulse width of the synchronous output signal to 400 [μs] or 150 [μs]
	The pulse width is 400 [μs]
	The pulse width is 150 [μs]

4.5.2 Instructions about function mode

How to move to function mode.



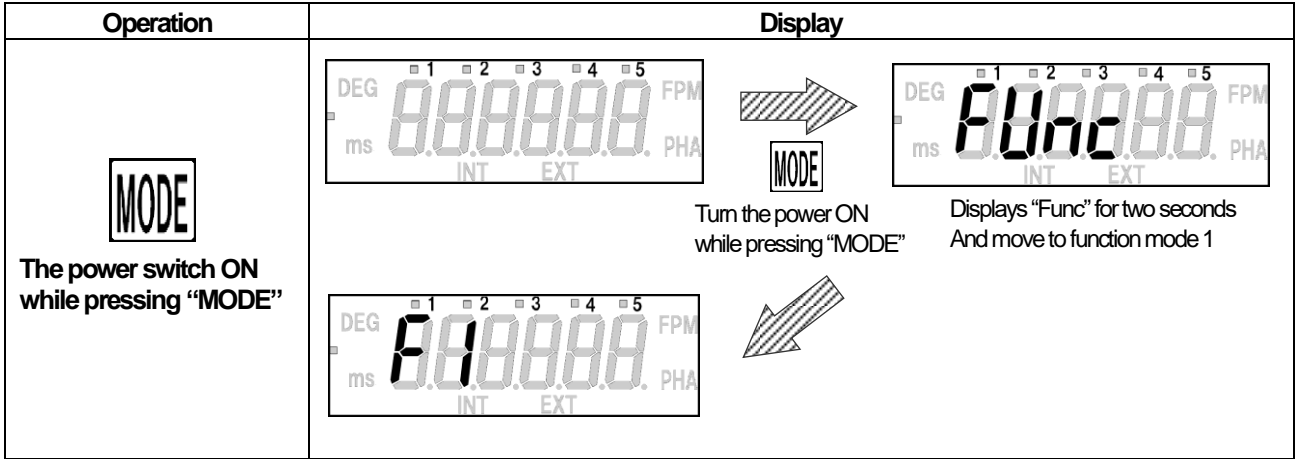



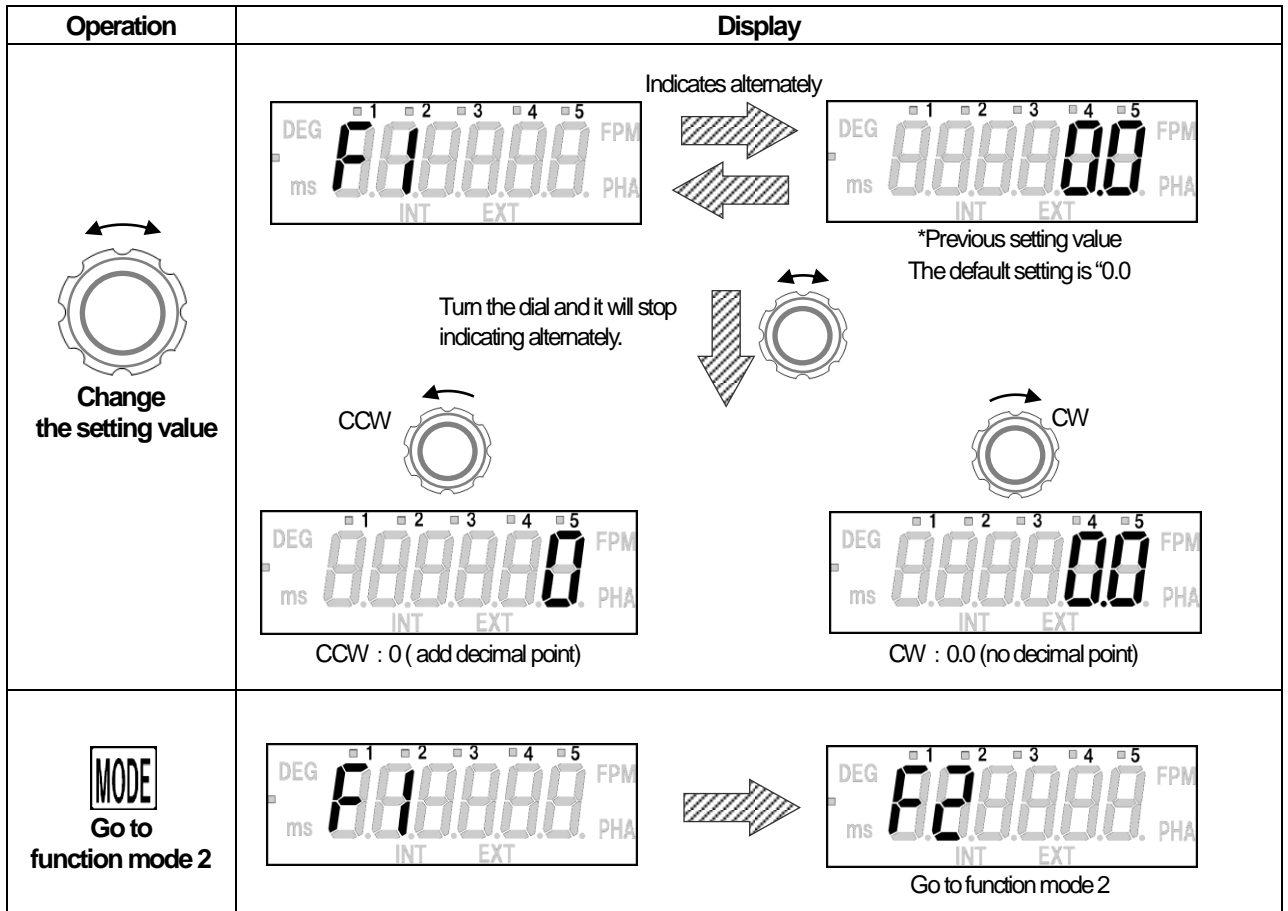

Turn the power ON while pressing the “MODE” to enter the function mode.

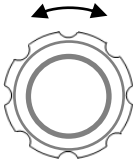
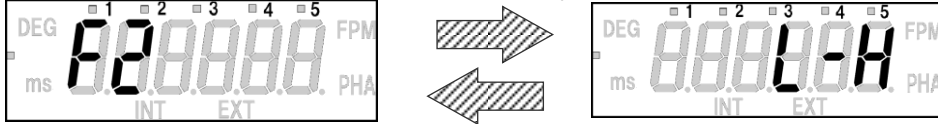

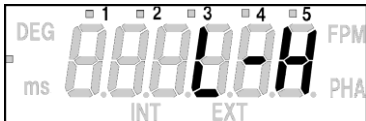
In function mode 1, you can set weather to add decimal point. (Not reflected on EXT)



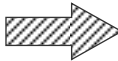

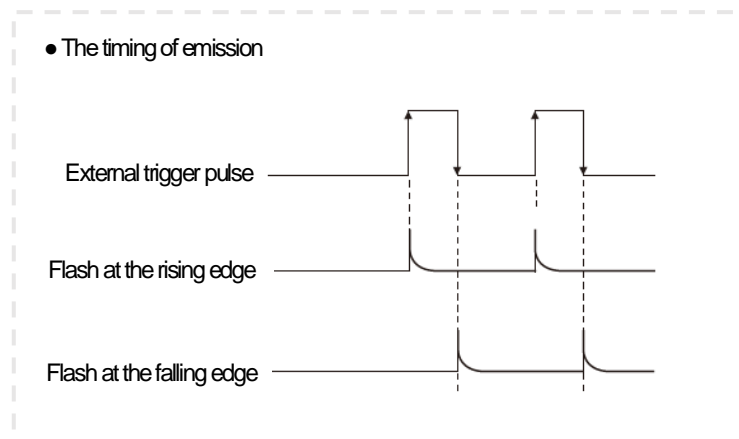

In function mode 2, in which the edge of the external pulse triggers emission, the rising edge or falling edge, can be set (for EXT).

Operation	Display
 <p>Change the setting value</p>	<p>Indicates alternately</p>  <p>*Previous setting value The default setting is "L-H"</p> <p>Turn the dial and it will stop indicating alternately.</p> <p>CCW </p>  <p>CCW: L-H (Rising edge)</p> <p>CW </p>  <p>CW: H-L (Falling edge)</p>
 <p>Go to function mode 3</p>	   <p>Go to function mode 3</p>



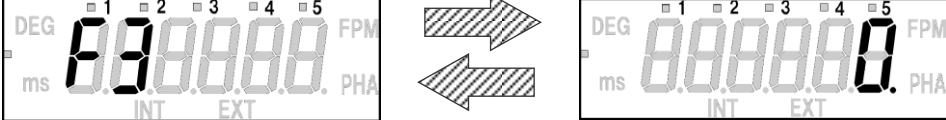

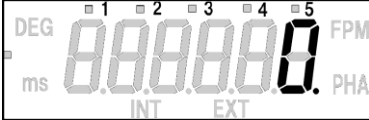
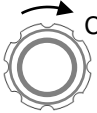
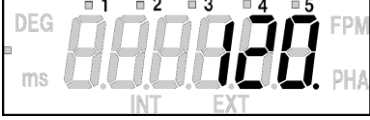

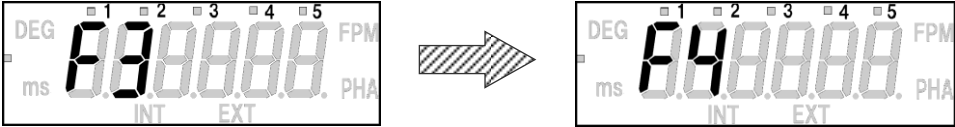
*This setting changes the timing of emission as shown in the following figure.



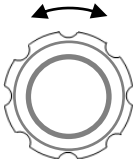
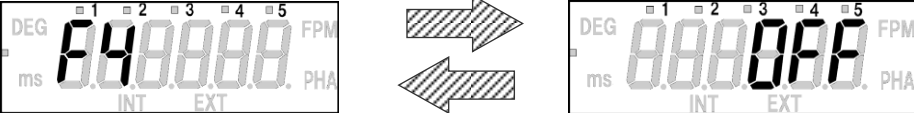

In function mode 3, auto emission stop time can be changed.

Operation	Display
 <p>Change the setting value</p>	<p>Indicates alternately</p>  <p>*Previous setting vale The default setting is "0"</p> <p>Turn the dial and it will stop indicating alternately.</p> <p>CCW </p>  <p>CW </p>  <p>CW : +1 CCW : -1</p> <p>The timer can be set between 0 [min] and 120 [min]</p>
 <p>Go to function mode 4</p>	 <p>Go to function mode 4</p>

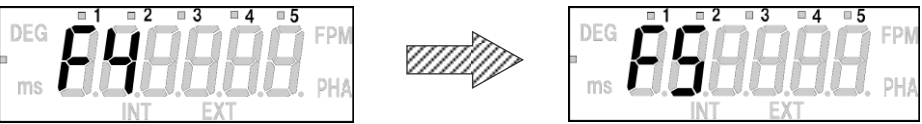

In function mode 4, the input circuit setting can be changed.

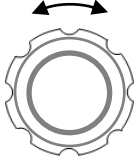
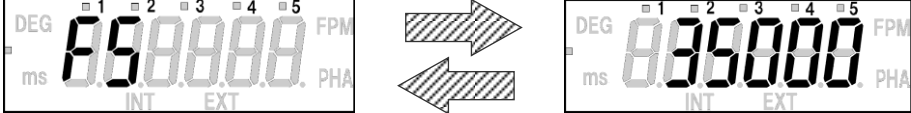
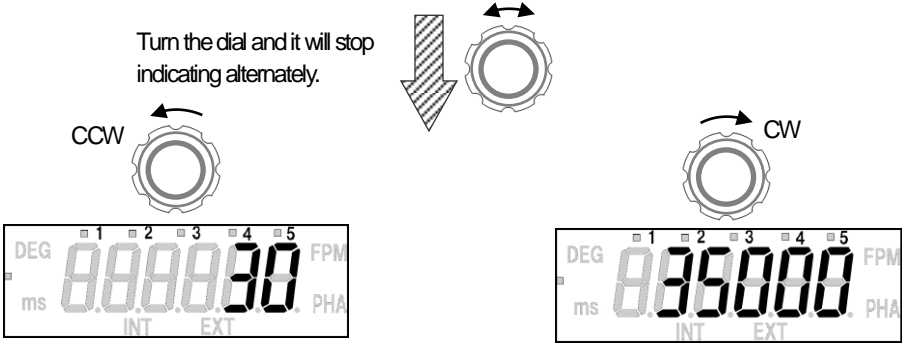
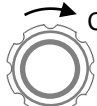
Operation	Display
 <p>Change the setting value</p>	<p>Indicates alternately</p>  <p>*Previous setting vale The default setting is "OFF"</p> <p>Turn the dial and it will stop indicating alternately.</p> <p>CCW </p>  <p>CCW : OFF Voltage pulse input (Pull down the external input circuit)</p> <p>CW </p>  <p>CW : On Open collector input (Pull up the external input circuit)</p>
 <p>Go to function mode 5</p>	 <p>Go to function mode 5</p>

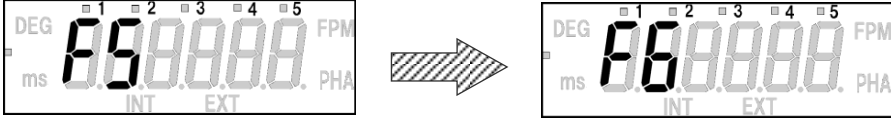
In function mode 5, the measurement range on INT can be set.

Operation	Display
 <p>Change the setting value</p>	<p>Indicates alternately</p>  <p>*Previous setting vale The default setting is "35000"</p> <p>Turn the dial and it will stop indicating alternately.</p> <p>CCW  CW </p>  <p>Increase / decrease by 1 [fpm] Available setting range: 30 to 35000 [fpm]</p>
 <p>Go to function mode 6</p>	 <p>Go to function mode 6</p>

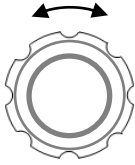
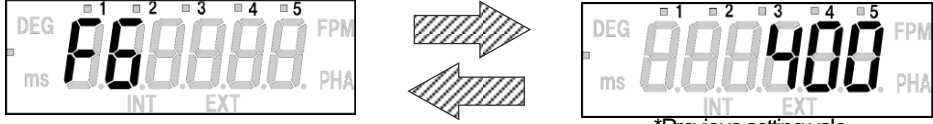
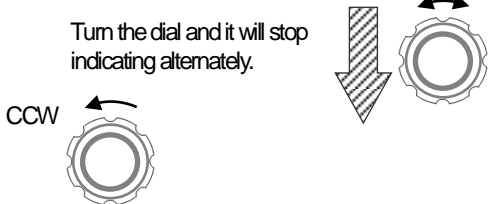
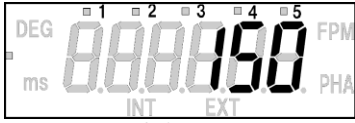
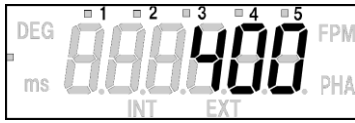
In function mode 6, the pulse width of the synchronous output signal can be set to 400 μ sec or 150 μ sec.

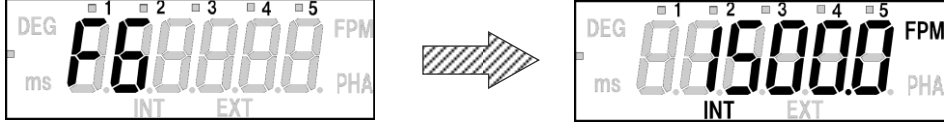
Operation	Display
 <p>Change the setting value</p>	<p>Indicates alternately</p>  <p>*Previous setting vale The default setting is "400"</p> <p>Turn the dial and it will stop indicating alternately.</p>   <p>150 μsec</p>  <p>400 μsec</p>
 <p>Save the changes and go to the home screen</p>	 <p>Go to the home screen</p>

4.6 Saving function

This unit can save the setting values in two ways.

- Power OFF save : While using the unit while on INT and EXT, turn the power OFF to save the setting value to that which it was before turning the power OFF.
When the power is turned ON again, operation starts from the previous setting value.
- Memory save : The setting values on the screen can be saved as the SELECT number.
Since the SELECT number have five memories, the setting can be saved as five patterns.

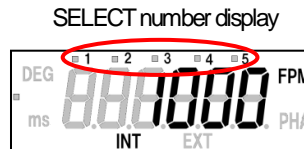

4.6.1 Saving the setting values

The setting values are saved as the following figure.



○ : save × : cannot save		Memory save		Power OFF save	
		INT	EXT	Power OFF during INT	Power OFF during EXT
Emission setting(INT / EXT)		○	○	○	○
Mode setting(FPM / PHA)		○	○	○	○
INT	The emission count(FPM)	○	×	○	×
	Delay angle(PHA)	○	×	○	×
	Delay time(PHA)	○	×	○	×
EXT	Delay angle(PHA)	×	○	×	○*1
	Delay time(PHA)	×	○	×	○*2

*1 When you press "ZERO" in Delay angle mode, the value (delay angle) on the display is different from the actual value.
In that case, the value on the display will be saved.

*2 When you turn the power OFF to save, the calculated delay time based on delay angle will be saved.

4.6.2 How to save the setting values

The setting values can be saved by the operations as followings.

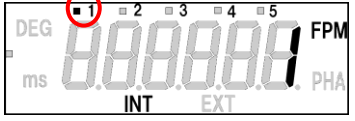
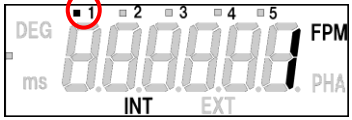
Operation	Display
<div style="border: 1px solid black; padding: 5px; width: fit-content; margin: 10px auto;">LOAD</div> <p>Press and hold "LOAD"</p> <div style="border: 1px solid black; padding: 5px; width: fit-content; margin: 10px auto;">X2</div> <p>Press "x2" to cancel the saving function.</p>	<div style="text-align: center; margin-bottom: 20px;">  <p>Press and hold "LOAD"</p> </div> <div style="display: flex; justify-content: space-around; align-items: center;"> <div style="text-align: center;">  </div> <div style="text-align: center;">  </div> </div> <p>"SAVE" and SELECT number (the default is "1") display alternately every 0.5 seconds. Turn the dial and change SELECT number to save.</p> <p style="margin-left: 40px;">CW : +1 CCW : -1</p> <p>*When "1" displays on the screen, turn the dial CW to display "5". *When "5" displays on the screen, turn the dial CCW to display "1".</p> <div style="text-align: center; margin-top: 20px;">  </div> <div style="display: flex; justify-content: space-between; margin-top: 20px;"> <ul style="list-style-type: none"> • Press "LOAD" and confirm the saving function. After the saving, go to the previous screen. <ul style="list-style-type: none"> • Press "x2" and cancel the saving function. Go to the previous screen without saving. </div>

4.6.4 Initializing the setting values

The current settings will be erased and replaced as follows. (Including the function mode.)

		The initial setting	display
The initial emission setting		EXT	
The initial mode		FPM	
Default SELECT number		0 ※1	
INT	FPM	1500	
	PHASE(DEG)	0	
	PHASE(ms)	0	
EXT	FPM	0	*2
	PHASE(DEG)	0	
	PHASE(ms)	0	
F1		0.0	
F2		L-H	
F3		0	
F4		OFF	
F5		35000	
F6		400	

*1 Memory (SELECT number) is not loaded





*2 On EXT, underlines are displayed until the external signal inputs occur.

4.7 Reading memory function

4.7.1 Reading values

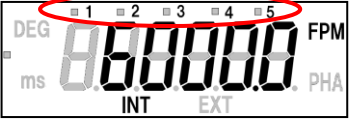
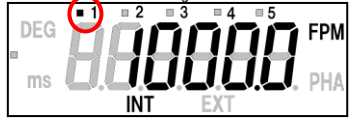
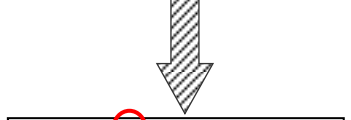
Press "LOAD" and read the saving values as the figure on 4.6.1

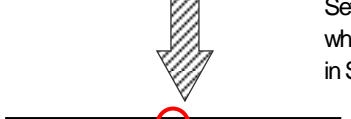
4.7.2 How to read the memory

Operation	Display
<div style="border: 1px solid black; padding: 5px; width: fit-content; margin: 10px auto;">LOAD</div> <p>Each press of "LOAD" switches SELECT numbers. OFF→1→2→3→4→5</p>	<p>OFF (SELECT : 0)</p> 
	<p>SELECT : 1</p> 
	<p>SELECT : 2</p> 
	<p>SELECT : 3</p> 
	<p>SELECT : 4</p> 
	<p>SELECT : 5</p> 

Set the setting values which have been saved in SELECT number on display.

4.8 External signal I/O connector specifications and Pin assignment

RM15WTRZB-8P(71) (Hirose Electric Group)

Pin number	Signal name	Remarks
1	+19V	Power input +
2	-19V	Power input -
3	12V	Power supply+ (DC12V) for sensor
4	OUT	External pulse output
5	IN	External pulse input
6	GND	Power supply- (DC12V) for sensor External pulse output common External pulse input common
7	NC	-
8	FG	Earth

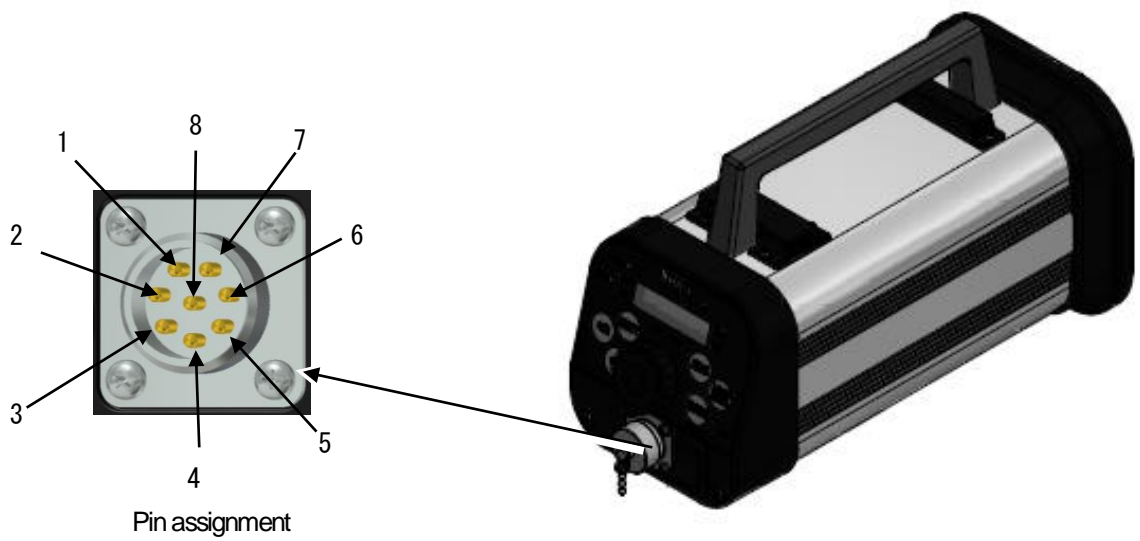

4.9 External pulse input

Connect the unit to external devices (sensors, etc.) to allow the strobe to emit light using the pulse signal from the devices on external synchronous emission.

Available input frequency	:	Available measurement range	27 to 35020 fpm (0.45 to 583.7 Hz)
	:	Available delay emission range	27 to 35020 fpm (0.45 to 583.7 Hz)
Available input signal	:	Hi	2.5 to 12 V
	:	Lo	0 to 0.5 V
Available input pulse width	:		50 μ s or more (edge trigger)
Input impedance	:		10 k Ω (at voltage input)

[Input circuit]

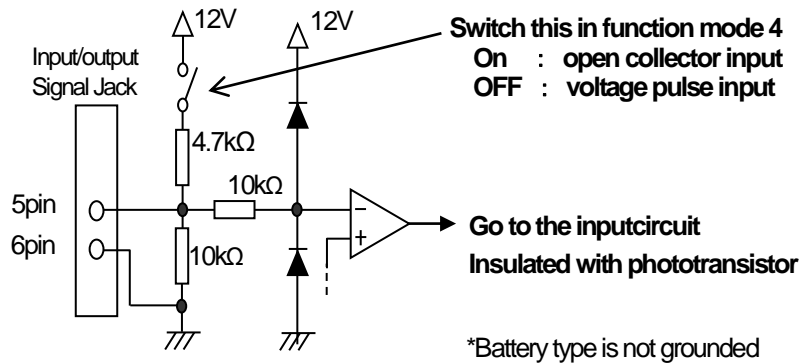

4.10 External pulse output

Outputs pulses to external devices simultaneously with light emission.

Output circuit spec	:	12 V output
Output pulse width	:	about 400 μ s

[Output circuit]

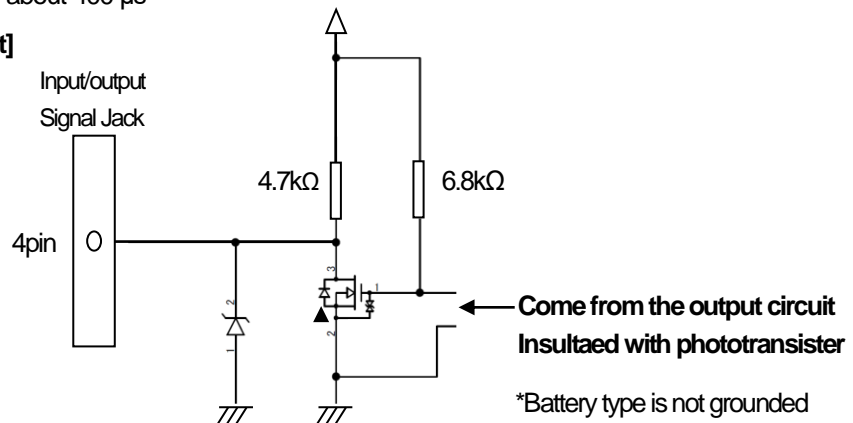

*Output square wave as following figure.

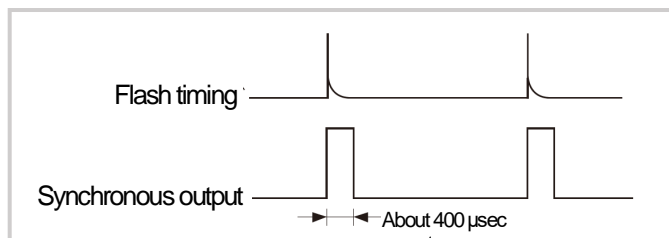

Pulse width can be changed in function mode 6 (\Rightarrow 150 μ sec)

4.11 Lamp replacement

The life of a xenon lamp is about 1200 hours when it is emitted at 1500 fpm each time. Although rotation speed is displayed, no flash is emitted. When the flash is intermittently emitted, this indicates the lamp must be replaced. Be sure to replace the lamp with the following steps. Be sure to use the specified lamp. Please contact us or the retailer where you purchased this product if you need it.



Be sure to turn the power OFF. May result in electric shock



The lamp is hot and may cause burns.
After emission stops, let the stroboscope sit for 30 minutes or longer.
Be sure stroboscope is cool to the touch before replacing the lamp.

- ① Remove the protection window by loosening the 4 screws. Insert a thin screw driver into a hole of the protection window and pull out.
- ② Remove the reflector and Insert the lamp insertion holder as far as it will go. Then turn it CW two or three times and pull out straight with lamp.



Be sure to use a lamp insertion holder.
Pulling out lamp by hand may cause injury.

- ③ Insert new lamp into the lamp insertion holder with seeig the figure below. And press it to the socket in the proper direction.
- ④ Turn the lamp insertion holder CCW and pull out. And put carefully the reflector on the case properly.
- ⑤ Put the protection window back with 4 screws.

*In order to maintain protection, be sure to fix the protective window. (Tightening torque: 0.3N·m or less)

4-Mounting screws for protection window
(Tightening torque: 0.3 N·m or less)

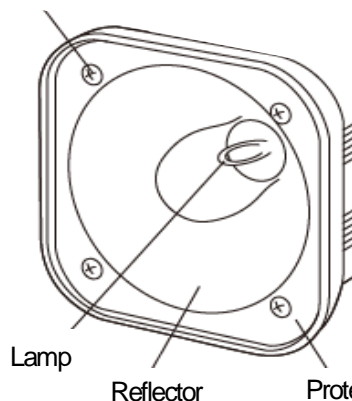

Lamp

Reflector

Protection window

Insert the screw part of the holder
and turn it CW

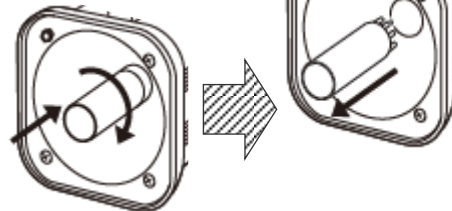

Insert this part into socket
to fit the groove



Lamp

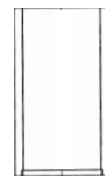

The lamp insertion holder
(One side is threaded)

*Sold Separately

4.12 Battery replacement

If the built-in battery-life duration becomes short, replace the battery with one that is specified. Be sure to use the specified battery. Please contact us or the retailer where you purchased this product if you need it.



Be sure to turn the power OFF. May result in electric shock



Do not replace the battery near flammable materials.

- ① Remove the six screws on the bottom of the DT-3015N main unit, and take out the built-in battery.
- ② Remove the connector and battery fixing screws.
- ③ Cut the insulok that is holding the battery onnector with nippers,etc.
*Please take care not to scratch the connector cable and the battery with nippers.
- ④ Remove the four battery fixing screws and the top cover.
- ⑤ Take out the battery from the battery case, and replace with a new battery.
*Please be careful that the harness faces the outside.
- ⑥ Insert the Insulock attached to the battery through the Insulock through hole on the top cover.
- ⑦ Secure the connector cable with the Insulock so that the battery connector contacts the top cover.
(Refer to the Detail drawing) *Please tighten it strongly.
- ④ Attach the top cover to the battery case and fix it with the fixing screws (4 places-tightening torque 0.3 Nm).
- ⑤ Connect the battery connector to the main body connector.
- ⑩ Install the battery in the main unit and fix it with the battery case fixing screws (6 places-tightening torque 0.6 N-m).

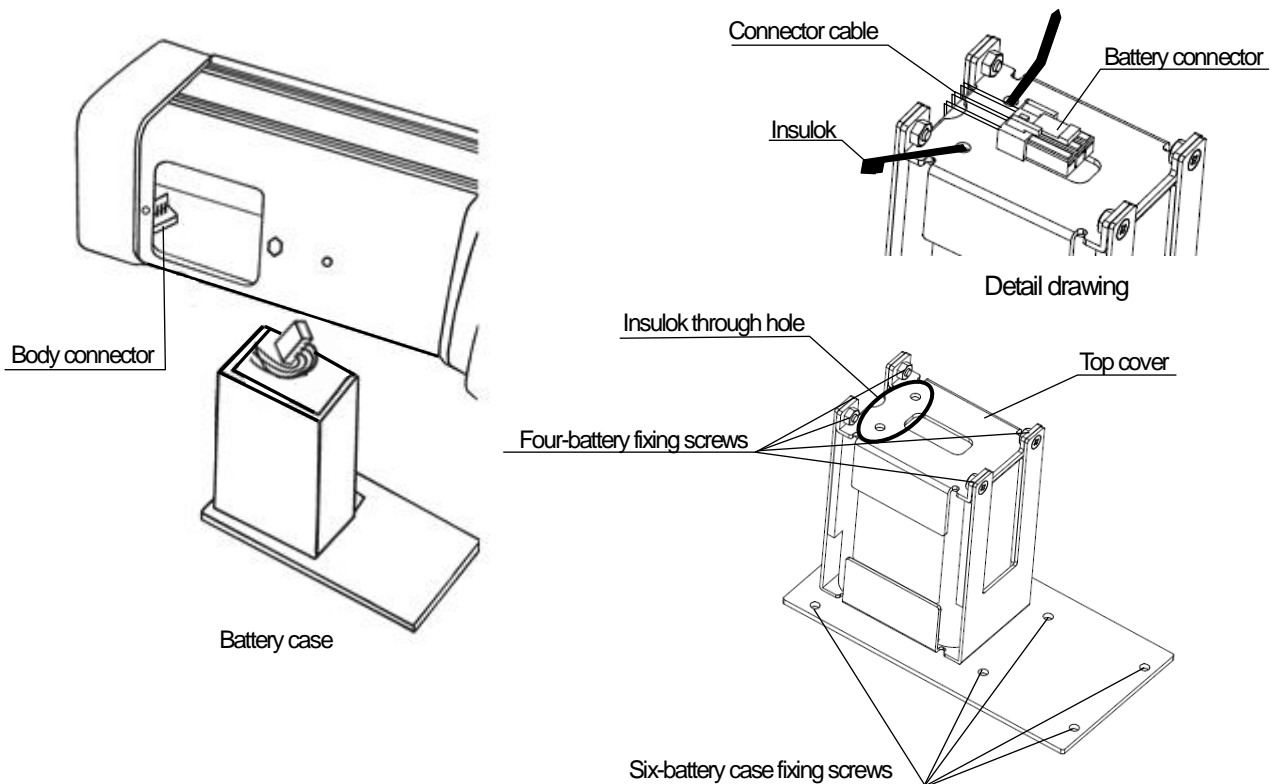

5 Specifications

5.1 Specifications list

Internal oscillation emission	Emission count	30 to 35000 fpm
	Resolution	30.0 to 5000.0 : 0.1 fpm to 8000.0 : 0.2 fpm to 10000.0 : 0.5 fpm to 35000.0 : 1.0 fpm
	Phase change function	Available (PHA mode)
	Jump function	Available (press "x2" and "+2" while on INT)
	Limit function	Available (configurable in function mode 5)
	Integer function	Available (configurable in function mode 1)
	Delayed emission function	Measurement range : 30 to 35000 fpm Within the range (angle) : 0 to 359°, available to set by 1° Within the range (time) : 0.00 to 999.99 ms, available to set by 0.01 ms 1000.0 to 1994.4 ms, available to set by 0.1 ms
External synchronous emission	Input signal	H level : 2.5 to 12 V L level : 0 to 0.5 V Pulse width : 50 µs or more *Input impedance : 10 kΩ or more
	Frequency measurement range	27 to 35020 fpm
	Phase change function	Available (PHA mode)
	Resolution	1 fpm
	Delayed emission function	Measurement range : 27 to 35020 fpm Within the range (angle) : 0 to 359°, available to set by 1° Within the range (time) : 0.00 to 999.99 ms, available to set by 0.01 ms 1000.0 to 2216.0 ms, available to set by 0.1 ms
Display		6-digit 7 segment red LED
Setting devices		Multi-turn encoder, tact switch
Lamp	Emission source	Xenon Lamp
	input	15 W
Emission pulse width		20 µs
Emission timer		Emission continuously or automatically stop in 1 to 120 [min] (adjustable in function mode 3)
Saving function		Power OFF saving Memory saving (SELECT number)
Power supply for sensor		DC12V 40mA
Power		Built-in NiMH battery •Charging time : Approx. 2 hours •Continuous emission time Approx. 3 hours (when the emission count is 1500FPM) Supplied AC adapter •Input: AC 100 V to 240 V 50/60Hz
Operating temperature		0 to 40°C (32 to 104°F)
Operating humidity		45 to 85% (Non- condensing)
Protection structure		None
Weight		Approx. 1.9 kg (main unit only) (4.2lb)

Notes

- *1 The lamp may flicker in high frequency, but it is not failure. It can be measured by instruments so please continue to use it.
- *2 If noise causes signal integrity issues from the external input sensors, please take measures such as connecting a ferrite core to the signal line.

5.2 External dimensions

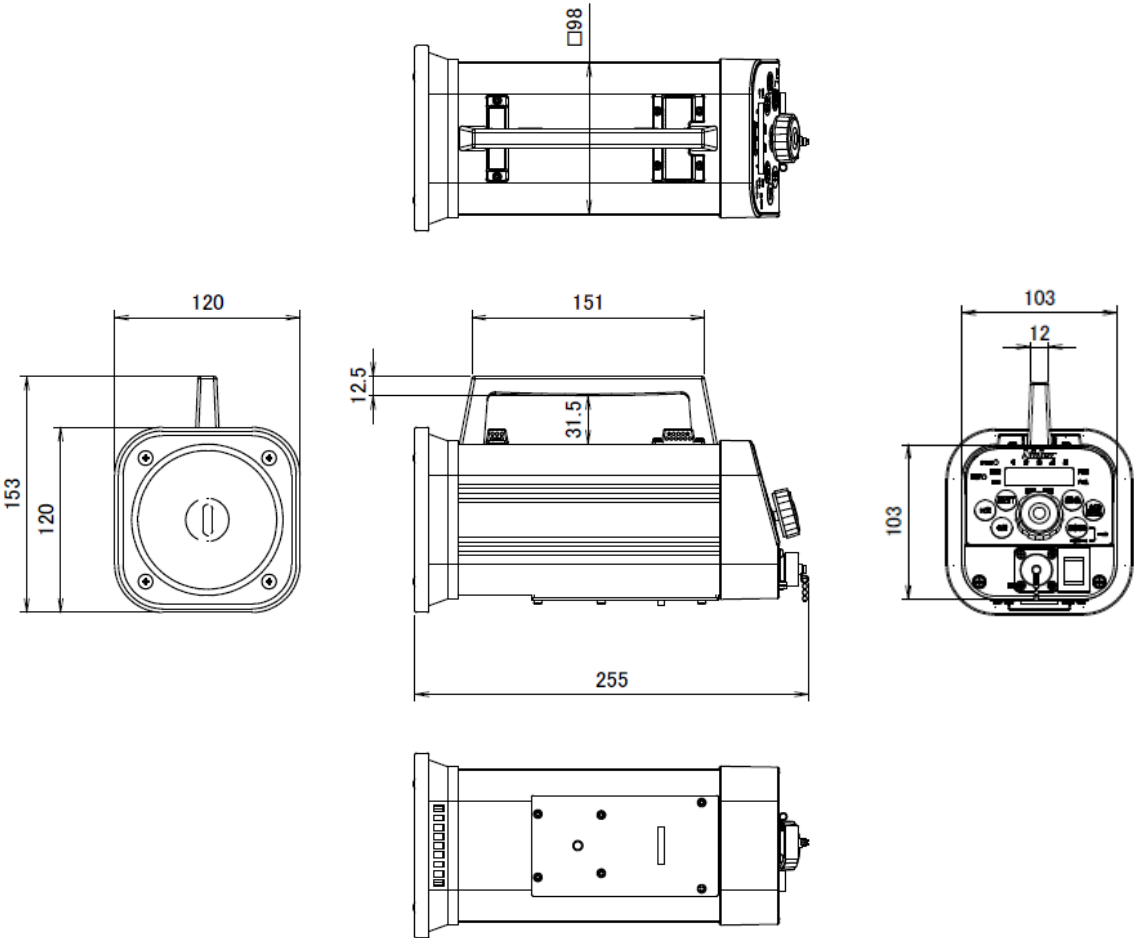

6 Troubleshooting

Troubleshooting				
Symptoms		Factors	Causes	Solution
Emission occurs inconsistently.	→	The Xenon lamp failure.	The Xenon lamp life. Internal circuit failure.	Replace the lamp, if the problem has not been solved, ask for repair.
Emission sometimes stops.	→	The Xenon lamp failure.	The Xenon lamp life. Internal circuit failure.	Replace the lamp, if the problem has not been solved, ask for repair.
Display does not change by turning the dial.	→	Internal circuit malfunction.	Internal circuit failure.	Ask for repair.
Information appears on the digital display, but no emission occurs.	→	The Xenon lamp failure.	Short battery life Internal circuit failure.	Replace the lamp, if the problem has not been solved, ask for repair.
Emission occurs but does not match the display.	→	Internal circuit malfunction.	Internal circuit failure.	Ask for repair.
Nothing is indicated on the display and no emission occurs.	→	Internal circuit malfunction.	Internal circuit failure.	Ask for repair.
At measurement, the object does not stand still completely	→	The rotation speed cannot be set accurately.	Due to resolution.	It cannot be set below the second decimal place.
When the power is turned ON, "LLLLL" is indicated, and no emission occurs.	→	The battery voltage is low.	The battery is not charged.	Charge the battery.
Though the battery is fully charged, "LLLLL" is soon indicated on the display.	→	The battery capacity is low.	Short battery life Battery malfunction	Replace the battery.
The charging lamp does not light up when the AC adapter is connected.	→	Internal circuit malfunction. The power does not reach the main unit.	Internal circuit failure. AC adapter is not connected. AC adapter malfunction	Ask for repair. Check the connection. Ask for repair.
Emission occurs when the AC adapter is plugged in, but stops when unplugged.	→	The battery is exhausted.	The battery voltage is too low.	Replace the battery. If the problem has not been solved, ask for repair.
Though the battery is fully charged, the charging lamp remains lit.	→	Internal circuit malfunction.	Short battery life Charging circuit failure	Replace the battery. If the problem has not been solved, ask for repair.
Though the charging lamp lights up, charging does not start.	→	The temperature detection circuit is working.	Not charged within specified temperature.	Charge in a room temperature environment. If the problem has not been solved, ask for repair.

Q & A

Questions		Answer	Note
Is it possible to see the object 2m away?	→	It depends on the surrounding environment.	Please check it by using demo.
Can I shoot the video?	→	No.	It does not have the signal for the video.
Can I take a picture?	→	No.	It does not have the signal for pictures.
Is this washable?	→	It is not washable.	Do not wash.
Do you have explosion-proof models?	→	No.	Impossible at present.
Is it possible to use at 200V	→	Yes. It can be used at 100-240V.	The included ac adapter is a free power supply up to 240V.

NIDEC-SHIMPO CORPORATION

:1 Terada Kotari, Nagaokakyo-city, Kyoto, 617-0833 Japan
Phone: 81-75-958-3887 FAX:81-75-958-1296

Copyright NIDEC-SHIMPO Corporation. All Rights Reserved.