

Digital Force Gauge  
**FGV-500/1000HXY**

**Instruction Manual**

Please read carefully before you use.

Please read the entire instruction manual (including Safety Precaution) thoroughly before operation.

# Safety Precaution \*Retain this manual for future reference



It is extremely important for safety that all warnings and cautions are observed exactly per this manual.



**Warning** Serious injury or possibly even death may result if the gauge is used wrongly



**Caution** A serious problem or issue may result if the gauge is used wrongly

## Safety Precaution Symbols



Warning



Prohibited



Must follow



## Warning



Take precaution to potential flying parts of test subject upon destruction

When performing a break or failure test, flying parts of the test subject may cause injury. A mask or safety glasses are required for proper safety



Do not use damaged or deformed hook.

If deformed or damaged in any manner, the hook could slip and cause damage upon testing



## Caution



Do not load above the rated capacity.

The sensor could be damaged if overloaded, additional loading above capacity could cause severe damage or an accident



When OVR is displayed, an overload condition has occurred. Reduce the load immediately. Values measured during an overload condition are not accurate.



## Caution



Please use only supplied AC adapter for charging.

If you use a substitute power adaptor, potential product damage or fire may result



Only use 100–230 VAC power voltage.

Using power outside this range can cause electric shock or fire



Please plug the AC adapter in firmly.

If loose, short circuit or electric shock may result



Do not touch the AC adapter with wet hand.

There is the possibility of electric shock.



Do not take apart, make alternations or attempt to repair the FGV.







The warranty will be voided and personal injury may result



Do not pull the cord to unplug the AC adapter.

The cord may be damaged from improper use and a fire hazard may result

## Safety precaution

 <b>Caution</b>	
 <p>Do not use AC plug covered with dust.</p> <p>A potential fire hazard may exist</p>	 <p>Do not use and keep FGV under the following circumstances.</p> <ul style="list-style-type: none"> <li>• Location which will be gotten water</li> <li>• Locations which receive direct sunlight</li> <li>• Dew condensation place</li> <li>• Dusty, salinity and iron content environments</li> <li>• Location which will be gotten oil and chemical</li> <li>• Corrosive and Flammable gas environment</li> </ul>
 <p>To clean the FGV do not use a volatile chemical such as benzene, thinner or alcohol. Only use a dry soft cloth or a cloth soaked in a mild detergent that is mixed with water.</p>	 <p>Please use the FGV in operating temperature in range 0°C~40°C .</p> <p>If you use FGV beyond above temperature, FGV might operate unusual.</p>
 <p>Accuracy performance degrades overtime. It is recommended the force gauge be checked for performance regularly. The frequency of the checks is dependent on the frequency of use and loading.</p>	 <p>Please operate the force gauge within operating humidity range; 35 ~ 85RH.</p> <p>If you use the force gauge beyond the above range, it might produce improper operation.</p>

## Caution before use.

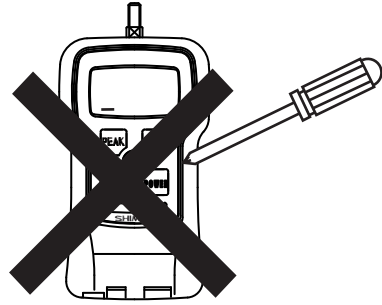
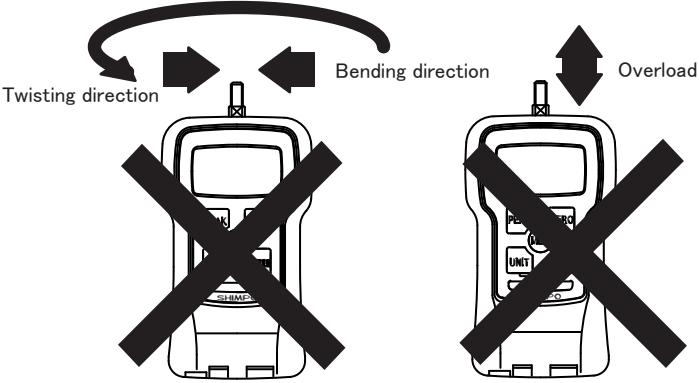
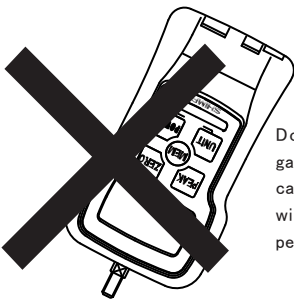
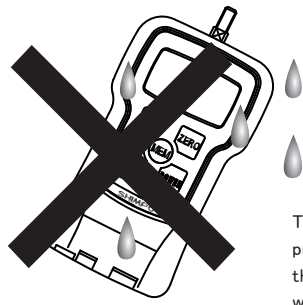
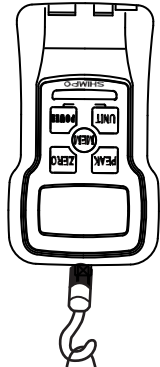
 <b>Caution</b>	
<p>1. Do not press the button with a sharp-pointed object.</p> 	<p>2. Do not load in an axial direction</p>  <p>The FGV can measure pulling and compression loads, but not loads in a rotational direction. The FGV is equipped with a limit stopper. However, this is unable to prevent damage from a heavy impact load or excessive axial forces.</p>
<p>3. Do not drop the force gauge.</p>  <p>Do not allow the force gauge to fall. The sensor can become damaged and will no longer be able to perform properly.</p>	<p>4. Do not use the force gauge in locations where it may get wet.</p>  <p>This force gauge is not water proof. Please do not operate the force gauge in locations where it may get wet.</p>
<p>5. Measuring very small loads</p> <p>Factory default, the tracking setting is set to ON. When measuring small loads, turn the tracking setting to OFF. Refer to section 4.5 for further details.</p> 	

# INDEX

<u>1. Product features</u>	<u>4</u>		
<u>2. Confirmation of standard accessories</u>	<u>4</u>		
<u>3. Part names and functions</u>	<u>5</u>		
3.1. Main unit	5		
[FGV-500/1000HXY]	6		
3.2. Display	7		
3.2.1. Part names	7		
3.2.2. Numeric display	7		
3.2.3. Unit display	7		
3.2.4. Peak hold mode display	7		
3.2.5. MAX/MIN display	7		
<u>4. Before use</u>	<u>8</u>		
4.1. Charge	8		
4.2. Attaching measuring adapter	8		
4.3. Attaching hanger	7		
4.4. Attaching handle	8		
4.5. Tracking	8		
4.6. Function setting	10		
4.6.1. Sign: f01	10		
4.6.2. Display update time: f02	11		
4.6.3. Auto power off: f03	11		
4.6.4. Baud rate of RS232C: f04	11		
4.6.5. Measuring filter: f05	12		
4.6.6. External output: f06	12		
4.6.7. PEAK signal mode: f07	12		
4.6.8. Function mode=end	12		
4.7. Reverse the display	13		
<u>5. Feature and Operation</u>	<u>13</u>		
5.1. Overview of operation	13		
5.2. Measuring mode	14		
5.2.1. Standard measuring mode	14		
5.2.2. Peak hold mode	14		
5.3. Change display unit	14		
5.4. Tare	14		
5.5. Comparator	15		
5.5.1. Comparator	15		
5.5.2. How to enter Comparator/Memory setting mode	15		
5.5.3. Setting HI limit	15		
5.5.4. Setting LO limit	16		
5.5.5. Judgement on LCD	16		
5.5.6. Output signal of judgement	16		
5.6. Memory	16		
5.6.1. Setting memory mode	18		
5.6.2. Storing data	19		
5.6.2.1. Store the data (Continuous memory mode)	19		
5.6.2.2. Store the data (Single memory mode)	19		
5.6.2.3. Store the data (Standard memory mode)	19		
5.7. Recalling memory data	20		
5.7.1. Continuous memory mode	20		
5.7.1.1. Measuring memory data	20		
5.7.1.2. Statistics memory data	21		
5.7.2. Single memory mode	21		
5.7.2.1. Measuring memory data	21		
5.7.2.2. Statistics memory data	23		
5.7.3. Standard memory mode	24		
5.7.3.1. Measuring memory data	24		
5.7.3.2. Statistics memory data	25		
5.8. Erasing memory data	25		
5.8.1. Erasing final memory data (one data)	25		
5.8.2. Erasing all memory data	26		
5.8.3. No memory data	26		
5.9. USB Communication	26		
5.9.1. Feature of ToriemonUSB	26		
5.9.2. Download ToriemonUSB	26		
5.9.3. Precaution when using USB communication	26		
<u>6. External Connection Connector</u>	<u>27</u>		
6.1. Pin assignment	27		
6.2. RS-232C output	27		
6.2.1. RS-232C interface	27		
6.2.2. RS-232C communication command	28		
6.2.3. Connection between FGV and PC	29		
6.3. Analog output	29		
6.4. Overload/Comparator output	29		
<u>7. Signal connector</u>	<u>30</u>		
7.1. Pin assignment	30		
7.2. Mitutoyo Digimatic output	30		
7.3. Comparator output	30		
7.4. External input signal	31		
<u>8. Frequently-asked questions</u>	<u>32</u>		
8.1. Troubleshooting	32		
8.2. Technical issue	32		
<u>9. Support</u>	<u>32</u>		
9.1. Repair and Calibration	32		
9.2. Warranty	32		
<u>10. Specifications and Dimensions</u>	<u>33</u>		
Dimensions	33		

## 1.Product Features

- Nickel-hydrogen battery for long time use  
→ 4.1. Charge
- Data can be downloaded to PC with USB  
→ 5.9. USB communication
- 1000 data point memory  
→ 5.6. Memory
- Comparator shows pass or fail. ( I/O output of the result)  
→ 5.5. Comparator
- Rated Capacity 2500N (250.0kg, 500lb) / 5000N (500.0kg, 1000lb)  
→ 10 Specifications and Dimensions
- Reverse the display of the measuring value and the unit.  
→ 4.7. Reverse the display
- One touch simple operation for changing the unit N, kg(g), Lb(oz).  
→ 5.3. Change display unit
- Measure peak value (positive or negative)  
→ 5.2.2. Peak hold mode
- High-speed measuring (1000 times/second)  
→ 10. Specifications and Dimensions
- Display update time is selectable up to 20 times/second.  
→ 5.2.1 Standard measuring mode
- External tare signal, display value hold, PEAK mode changeover feature  
→ 7.4 External input signal
- Available measuring data output with Mitsutoyo Digmatic communication.  
→ 7.2 Mitutoyo Digmatic output

## 2.Confirmation of Standard Accessories

- Before use, please confirm the following items are included in the carrying case.

### 1. Main Unit



FGV-500/1000HXY

\*\*\*Check the model number

### 3. Instruction manual



### 4. Measuring adapters



Hook

M10



Flat head

φ 24



Cone head

90°



Notched head

90°



Chisel

90°

### 2. AC adapter

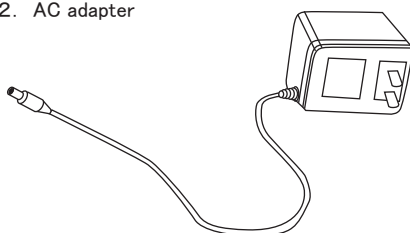

### Extension rod L:112(M10)



### 5. Hanger



### 6. USB cable (2.0 m)

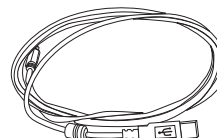

### 7. Handle (only FGV-500/1000HXY)

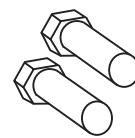

### 3. Part names and functions

#### 3.1. Main Unit

FGV-500/1000HXY

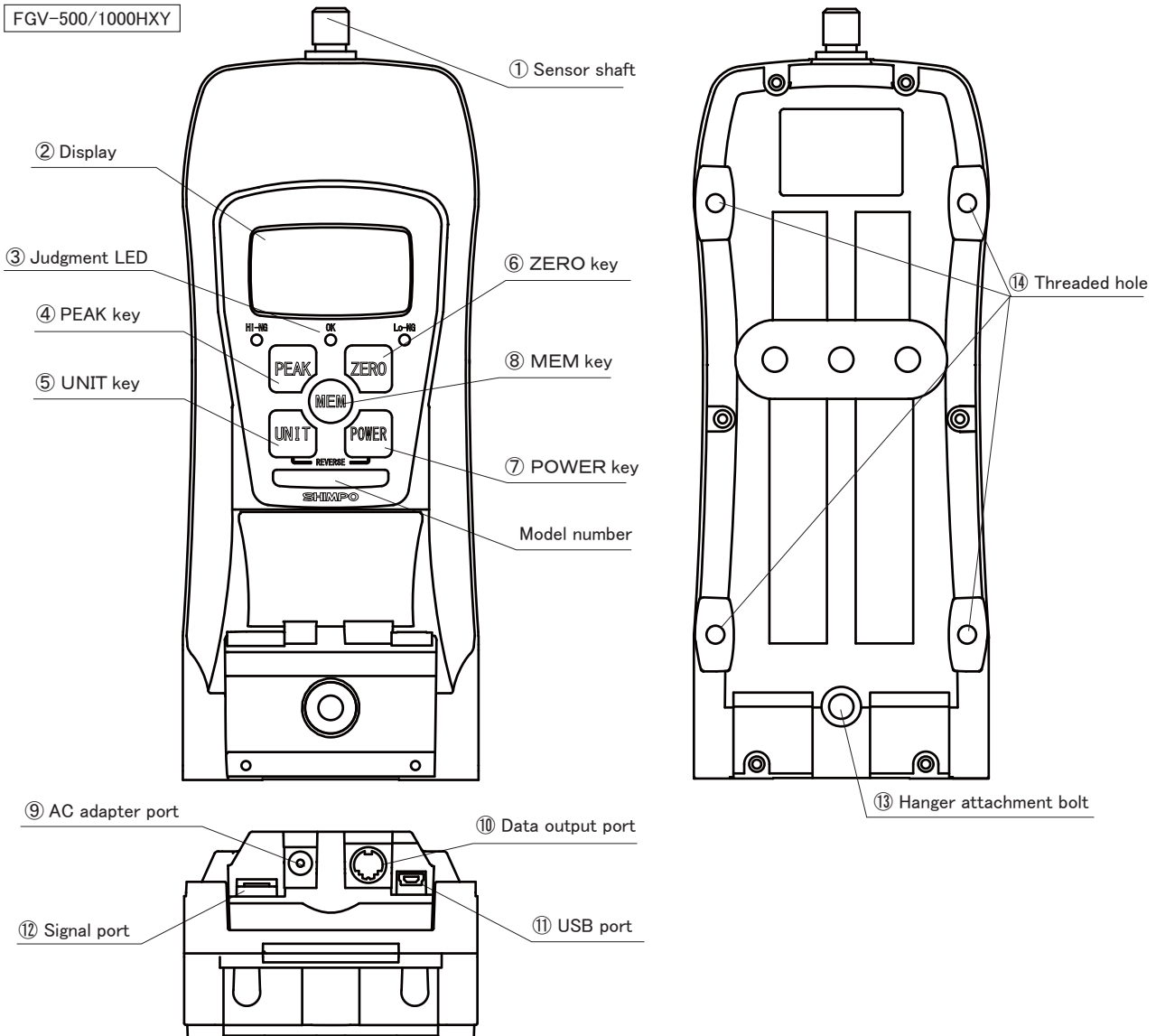

①	Sensor shaft	Force bolt (Push/Pull force)
②	Display	Display the load and the unit
③	Judgment LED	Light on the LED as the result of comparator judgment
④	PEAK key	<ul style="list-style-type: none"> <li>Switch the mode (standard measuring mode ⇒ +peak hold mode ⇒ -peak hold mode)</li> <li>Tracking ON/OFF</li> <li>It is used for comparator/memory setting</li> </ul>
⑤	UNIT key	<ul style="list-style-type: none"> <li>Switch the unit (N ⇒ Kg ⇒ lb(oz) ⇒ N)</li> <li>It is used to reverse the display.</li> <li>Tracking ON/OFF.</li> <li>It is used for comparator/memory setting.</li> </ul>
⑥	ZERO key	<ul style="list-style-type: none"> <li>Tare at standard measuring mode (not display a peak value).</li> <li>It is used for function setting.</li> <li>Press the ZERO key under the peak hold mode (display the peak value), to clear the peak value. In this case, tare does not perform. If you need tare, press the peak key to change into standard measuring mode, then press the Zero key.</li> <li>It is used for comparator/memory setting.</li> </ul>
⑦	POWER key	<ul style="list-style-type: none"> <li>Press the POWER and release to turn ON/OFF.</li> <li>It is used to reverse the display.</li> <li>Tracking ON/OFF.</li> <li>It is used for comparator/memory setting.</li> </ul>
⑧	MEM key	<ul style="list-style-type: none"> <li>Press the MEM key under the standard measuring mode (not display peak value), then measuring value is memorized.</li> <li>It is used to recall the memory data, and setting High/Low limits.</li> <li>It is used for comparator/memory setting.</li> </ul>
⑨	AC adapter port	Supply the electricity through the AC adapter.
⑩	Data output port	Connect with a PC and a recorder. (RS232C, analog output and so on)
⑪	USB port	Connect with a PC. (USB)
⑫	Signal port	Signal port for comparator output, input signal and Mitutoyo Digmatic signal
⑬	Hanger attachment bolt	Attach the hanger with this bolt.
⑭	Threaded hole	Use this threaded hole in order to attach the FGV with a stand.

## 3.2.Display

### 3.2.1.Part names

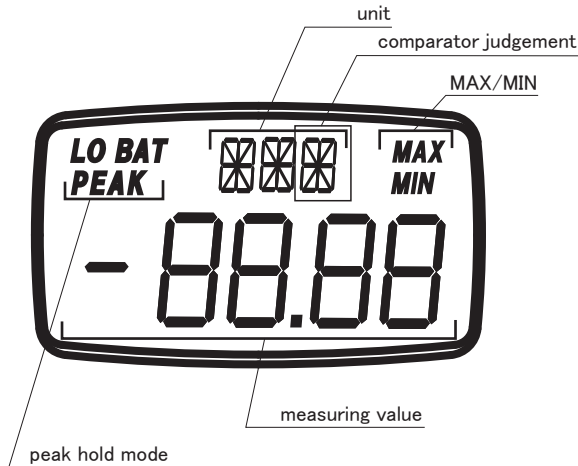

### 3.2.2.Numeric Display

Display the measuring value with sign and 4 digits numbers. Compression force: plus, Tension force: minus.

(It's available to switch plus/minus with the setting of function (f01)).

Reverse display is available.

### 3.2.3.Unit Display

Display the units. In case of overload, "OVR" is shown. "PWR" appears to notify that there is 1 minute before power off.

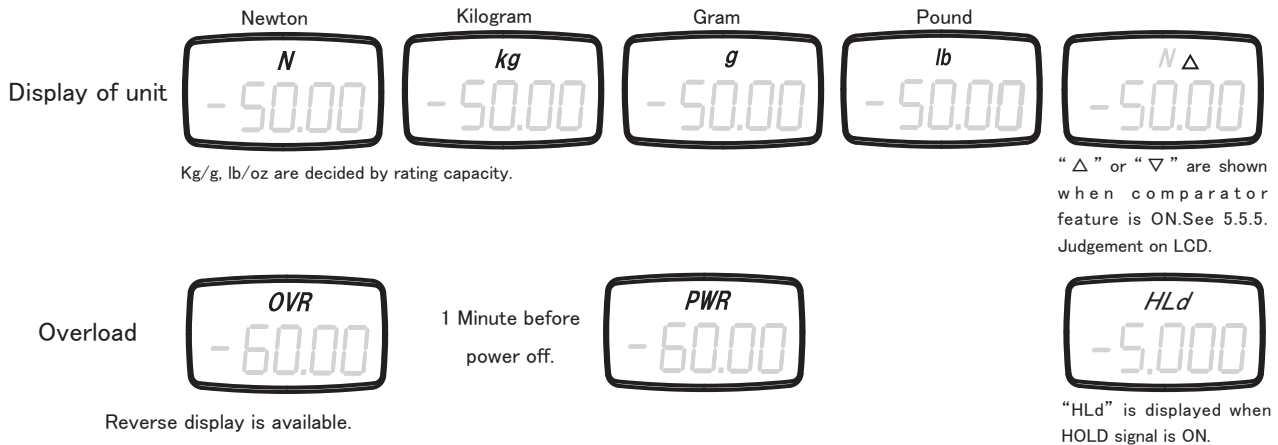

### 3.2.4.Peak hold mode display

Depend on the condition of the force gauge, the following display is shown.



In case of the voltage of internal nickel hydride battery decreases, "LO BAT" turns on and off. Please connect AC adapter to charge the battery.

During the charge of battery, "BAT" is shown. Even if turn the power off during the charge, "BAT" will be displayed.

"PEAK" turns on when plus peak hold mode.\*

"PEAK" turns on when minus peak hold mode.\*

\* Please discern plus peak hold mode and minus peak hold mode with or without "-".

### 3.2.5.MAX/MIN display

In case of showing statistical data for memory mode (continuous, single, standard), the following displays are shown.

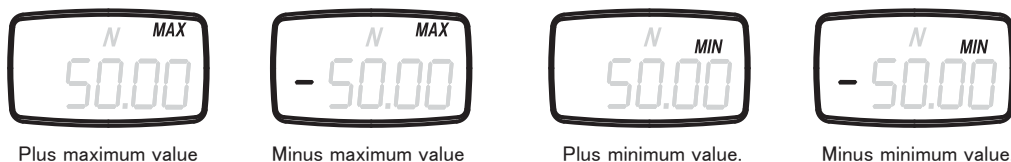

## 4. Before use

### 4.1. Charge



Only charge with supplied AC adaptor.

Please use AC adaptor supplied with the FGV. An alternate adaptor could cause damage and fire.

The unit's battery may be depleted upon first use. Plug attached AC adaptor and charge before you use.

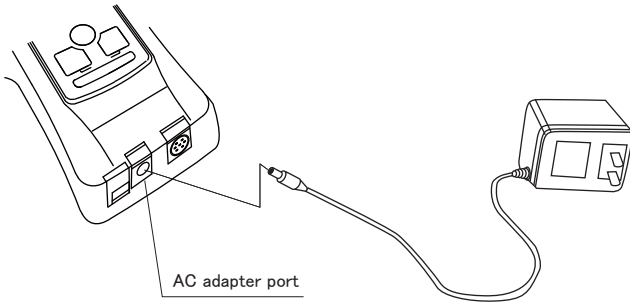

- ① Please connect the attached AC adaptor into the AC adapter port of the body, and then plug the adaptor into an outlet
  - Charge the battery. After charging is complete, the charging automatically stops. • "BAT" will be shown on the LCD display while charging. After complete the charging, "BAT" will disappear from LCD.
  - Charge time: Up to 16 hours at most.
  - Operating time: Approx. 8 hours per 1 full charge.

- ② The nickel hydride battery is charged automatically when it is discharged during the usage of AC adapter.
  - ※ If you charge the battery frequently, its lifetime will be shortened. When you use the FGV with AC adapter, you should not insert and remove the AC adapter often.

- ③ Measurements may be taken during charging

- ④ After the battery power has declined, "LoBAT" appears on the display. Connect the AC charger. If you leave the gauge turned on while "LoBAT" is displayed, the power will continue to decline and the unit will automatically shut off.

### 4.2. Attaching measuring adapter

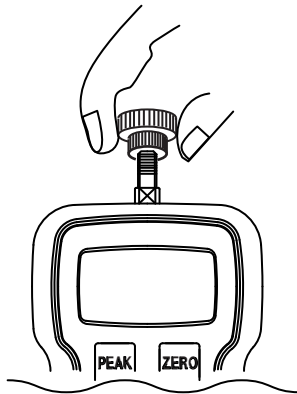

Please select the measuring adapter depending on the measuring purpose. Screw the adapter until it stops lightly. Do not screw it forcibly in order not to give the damage to the sensor.



Do not screw the adaptor on too tightly as it could damage the sensor.



Do not use scratched hook or deformed hook.

Hook



Flat head



Cone head



Notched head



Chisel



Extension rod



### 4.3. Attaching hanger

FGV-500/1000HXY

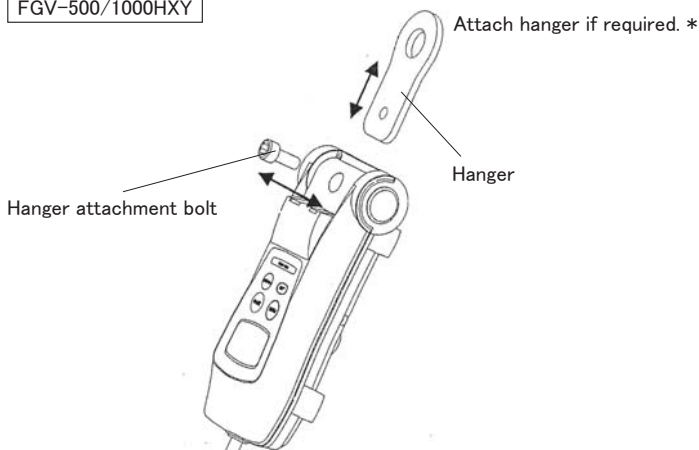

\* Please use a tolerable nail or winch against the load.

Please take off the attached hanger bolt. Fit the square hole of hanger into the salient part of the case, and then tighten the attached hanger bolt.



## 4.4 Attaching of the handle ( FGV-500/1000HXY)

\*Attach handle if required

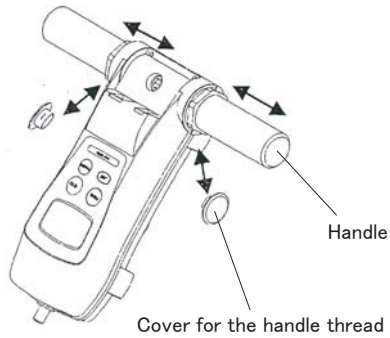

To record the most stable force, it is recommended to use the attachment handle.



\*Only use the attachment handle when testing by hand.

## 4.5.Tracking

A load cell strain gauge is used for the FGV force sensing. This type of sensor can alter its output due to changes in temperature. The tracking feature algorithm can negate this slight change. When measuring very small forces, an error could arise while tracking is on. It is recommended on light load sensing to turn the tracking function off. To turn the tracking off, hold the PEAK key and UNIT key simultaneously while the power is off. Next, press and release the POWER key. Then, release the PEAK key and UNIT key after a value has remained on the screen for 1 second.

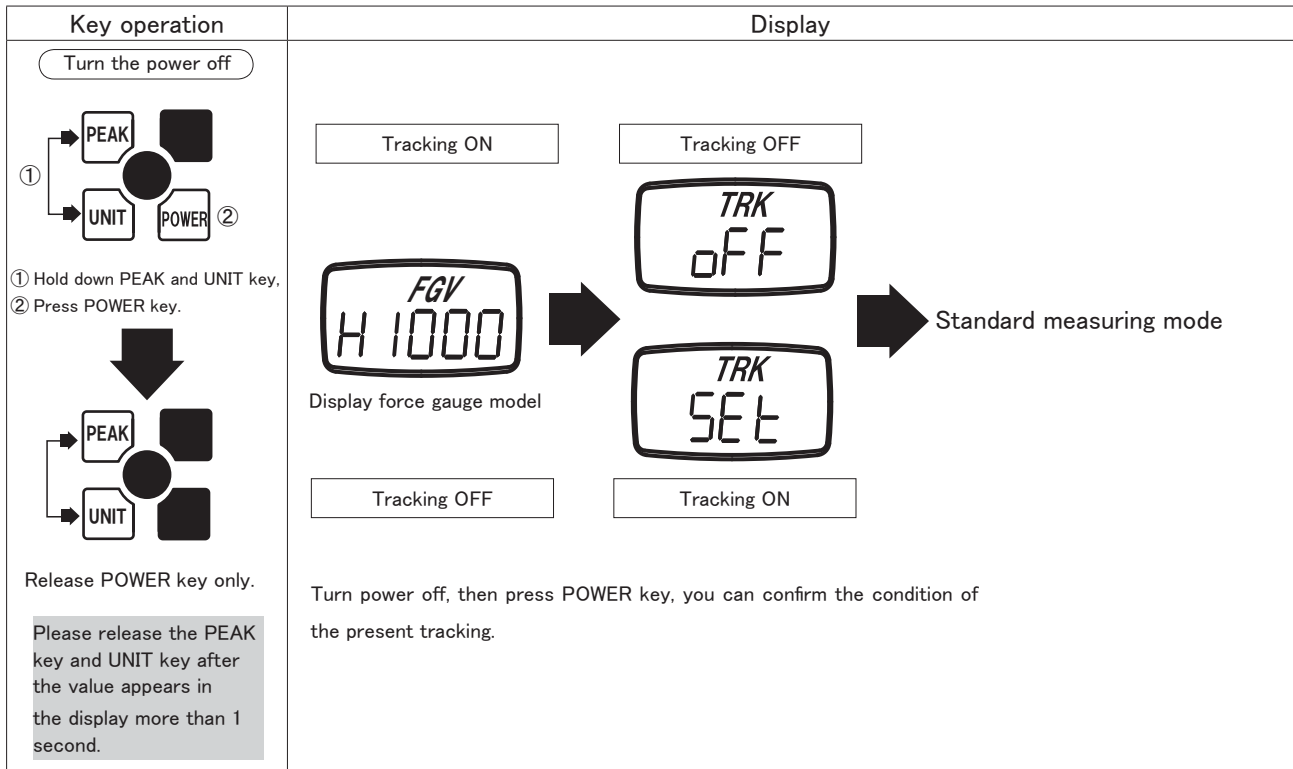

## 4.6.Function setting

The following setting items in function mode.

Item	Unit	Set contents	Default factory setting
Display sign	f01	-0001(minus), 0001 (plus)	0001
Display update time	f02	1、 2、 3、 5、 10、 20 (times/second)	3
Auto power off	f03	10 (10 minutes )、 oFF (not valid)	10
RS-232C baud rate	f04	2400、 4800、 9600、 19200 (bps)	2400
Measuring filter	f05	3、 20、 150 (msec)	3
External output	f06	ovEr、 Hi-Lo	ovEr
PEAK signal mode	f07	nonE、 +PEAK、 -PEAK	nonE

Key operation	Display
<p>Turn the power off</p> <p>① Hold down ZERO key. ② Press POWER key.</p> <p>Release POWER key only.</p> <p>Please release the ZERO key after the value has appeared in the display more than 1 second.</p>	<p>Display force gauge model → Display function mode (f01)</p>



### 4.6.1.Sign: f01

The measuring values of the sensor may be set to have a plus or minus sign.  
Select the sign by pressing of UNIT key / Press the PEAK key to move ahead.

Key operation	Display
<p>Each time to press UNIT</p>	<p>Minus → Plus</p>
	Register all settings, and then move to the standard measuring mode.
	Reserve the change, and then move to f02.

### 4.6.2. Display update time: f02

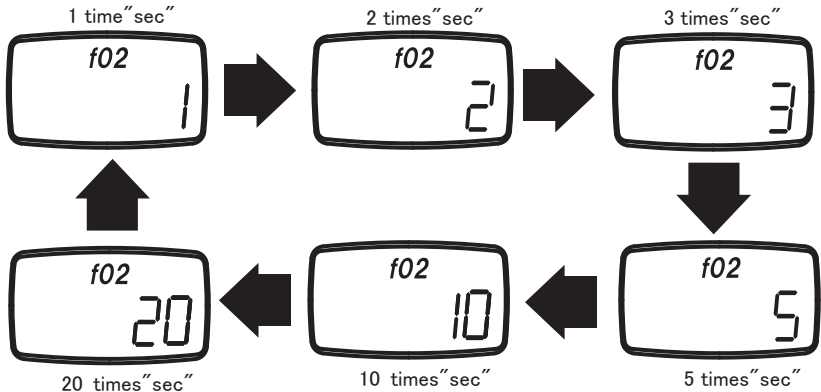
It's available to set the display update time for 1 time/second, 2 times/second, 3 times/second, 5 times/second, 10 times/second and 20 times/second. After the setting, the averaging value within display update time is shown every display update time. Press the UNIT key to choose the display update time (1、2、3、5、10、20 (times/second) ), Press the PEAK key to move ahead



Key operation	Display
 Each time to press UNIT	
	Register all settings, and then move to the standard measuring mode.
	Reserve the change, and then move to f03.

### 4.6.3. Auto power off: f03

If the gauge is on and there is no activity for 10 minutes\*, the unit automatically powers off to conserve battery charge (When connected with the AC adapter, the Auto Power off function does not work.). "PWR" appears to notify that there is 1 minute before power off.

Press the UNIT key to switch the auto power off, Press the PEAK key to move ahead

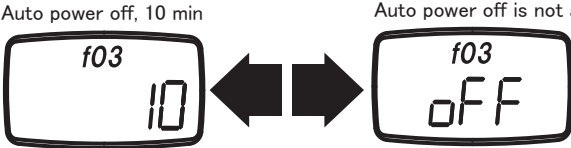

\*No activity means there is no key operation, RS-232C communication, USB communication, or no charge of measuring value.

Key operation	Display
 Each time to press UNIT	
	Register all settings, and then move to the standard measuring mode.
	Reserve the change, and then move to f04.

### 4.6.4. Baud rate of RS-232C : f04

It's available to set the baud rate of RS-232C.

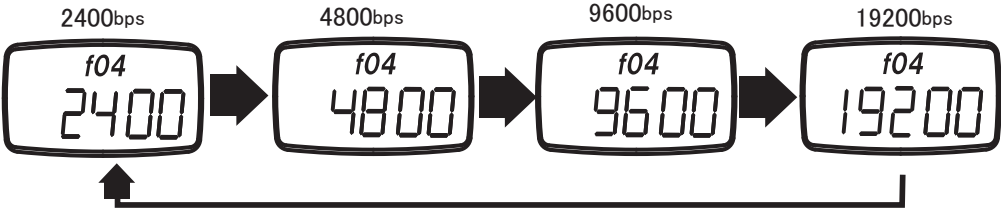



Press the UNIT key to switch the Baud rate (2400、4800、9600、19200(bps)) \* Press PEAK key to move ahead.

Key operation	Display
 Each time to press UNIT	
	Register all settings, and then move to the standard measuring mode.
	Reserve the change, and then move to f05.

## 4.6.5.Measuring filter : f05

It's available to set 3 types of filters as follows.

Press UNIT key to switch (response time 3 (msec)、20 (msec)、150 (msec)) \* Press PEAK key to move ahead.

Key operation	Display
 Each time to press UNIT	Response time 3msec    Response time 20msec    Response time 150msec 
	Register all settings, and then move to the standard measuring mode.
	Reserve the change, and then move to f06.

\* Filter response time show 90% of step input.

Depend on the filter response, sampling period and analog output update period is decided.

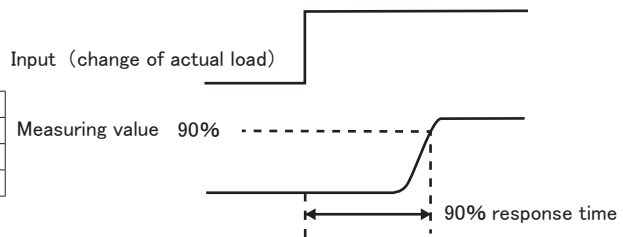

Filter response	Sampling period · Analog output update period
3msec	1msec
20msec	1msec
150msec	6.7msec



## 4.6.6.External output : f06

It's available to change the external output; RS-232C, USB and Digimatic output.

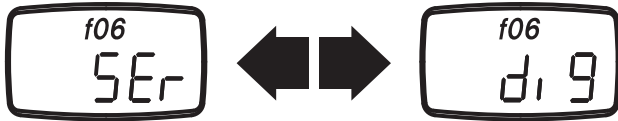

Press UNIT key to switch the external output. Press PEAK key to move ahead.

Key operation	Display
 Each time to press UNIT	RS-232C · USB output    Digimatic output 
	Register all settings, and then move to the standard measuring mode.
	Reserve the change, and then move to f07.

## 4.6.7 PEAK signal mode: f07

It's available to set PEAK signal mode.

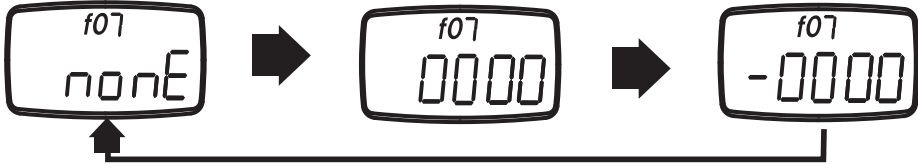
Press the UNIT key to switch the PEAK signal mode. Press PEAK key to back to f01.

Key operation	Display
 Each time to press UNIT	Not available PEAK signal    PEAK signal mode: +PEAK    PEAK signal mode: -PEAK 
	Register all settings, and then move to the standard measuring mode.
	Reserve the change, and then move to f01.

## 4.6.8.Function mode-end

Press ZERO key to memorize the set value and come back from function mode to standard measuring mode.

In order to cancel the change of function mode, press POWER key, then turn the POWER off.

## 4.7.Reverse the display

In the case you attach FGV with a stand, display of the value and the units can be reversed in order to read the display easily.  
Turn POWER off. Press the UNIT key and hold, then press POWER key and release (release UNIT key after the value appears in the display more than 1 second). Then you can reverse the display.

Key operation	Display
<p>Turn the power off</p> <p>① Hold down UNIT key ② Press POWER key.</p> <p>↓</p> <p>Release POWER key only.</p> <p>Please release the UNIT key after the value appears in the display more than 1 second.</p>	<p>Standard display</p> <p>Display force gauge model</p> <p>Reverse display</p> <p>Standard measuring mode</p> <p>Reverse display</p> <p>Standard display</p> <p>Standard measuring mode</p>

## 5.Feature and Operation

### 5.1.Overview of operation

#### 1) Basic operation

Key	Operation
POWER	Turn the POWER ON/OFF
ZERO	Tare (Peak reset at the PEAK Hold mode)
PEAK	Standard measuring mode / Plus peak hold mode / Minus peak hold mode
UNIT	Change the unit
MEM	Store the measuring data into memory

#### 2) Special operation

Key	Operation	How to operate
PEAK + UNIT POWER	Tracking ON / OFF	Turn POWER off. Press PEAK key and UNIT key simultaneously and hold, then press and release POWER key (release the PEAK key and UNIT key after the value appears in the display more than 1 second.)
ZERO POWER	Function mode	Turn POWER off. Press ZERO key and hold, then press POWER key and release (release ZERO key after the value appears in the display more than 1 second). Function mode; UNIT : Change the setting content PEAK : Switch the function ZERO : Register the setting content
UNIT POWER	Reverse display	Turn POWER off. Press UNIT key and hold, then press POWER key and release (release the UNIT key after the value appears in the display more than 1 second.)
MEM POWER	Display memory data	Turn POWER off. Press MEM key and hold, then press POWER key and release (release MEM key after the value appears in the display more than 1 second.) Display memory data; UNIT : Display the statistical data PEAK : Memory data display end ZERO : Delete one memory data Hold ZERO key to delete all data MEM : Next memory data
PEAK POWER	Comparator memory mode setting	Turn POWER off. Press PEAK key and hold, then press POWER key and release. In this setting; UNIT : Change sign, number and memory mode PEAK : Change the setting content ZERO : Shift the digit MEM : Register the setting content

## 5.2.Measuring Mode

There are standard measuring mode and peak hold mode in the measuring mode.

### 5.2.1 Standard measuring mode

It's available to measure the compression and tension force. Measuring value appears at all times.

- 1) Press POWER key and release ( Turn POWER on after release)
- 2) Press ZERO key to tare.

Displayed measuring value is the averaged out sampling value (every 1 msec\*) per display update time.

Display update time of default factory setting is 3 times/second. In order to increase the display response against the change of measuring value, you may change the set value of display update time.

You can increase this time up to 20 times/second (regarding the change of display update time, please refer "4.6.2. Display update time" .)

Based on the filter setting (f05). Please refer "4.6.5. Measuring filter" .

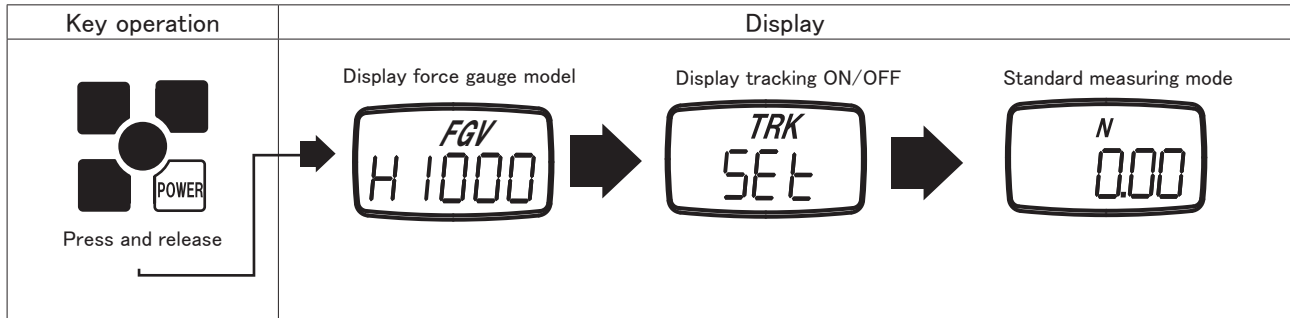

### 5.2.2 Peak hold mode

Display peak measuring value. Sampling time is 1ms.\*

Press PEAK key to change standard measuring mode, Plus peak hold mode and Minus peak hold mode.

Under the plus peak hold mode, "PEAK" appears.

Under the minus peak hold mode, "PEAK" and "-" (minus).

Based on the filter setting (f05). Please refer "4.6.5. Measuring filter" .

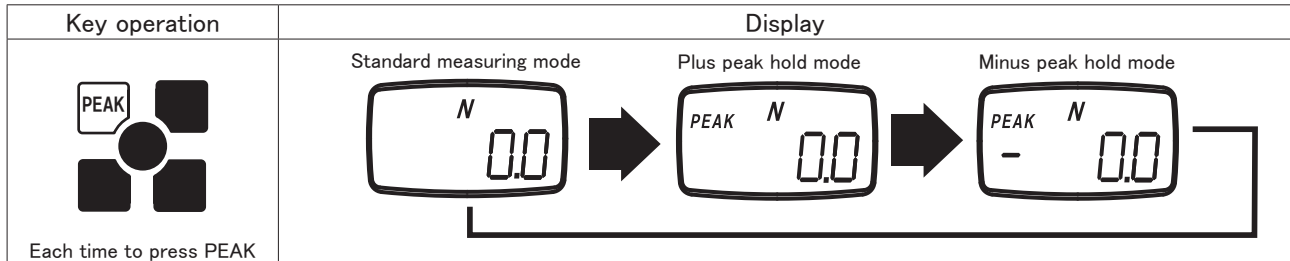

Under the plus peak hold mode and minus peak hold mode, press ZERO key to clear the peak value (Tare is not performed).

## 5.3.Change display unit

To change the display units, just press UNIT and the units will change every time the button is pressed.

N → kg (g) → lb (oz) → N

## 5.4.Tare

Press ZERO key to reset the measuring value. Please press the ZERO key before starting the measurement in order not to change the starting display value because of the own weight or measuring direction or weight of measuring fixture.

Measuring range is from maximum pulling load to maximum compression load. When measuring range is over the limit, "OVR" is displayed.

Press the ZERO key under the plus peak hold mode or minus peak hold mode. The plus peak value or minus peak value is cleared. In plus peak hold or minus peak hold modes, the tare cannot be performed even when pressing and releasing the ZERO key.

When turning the POWER on, a tare is automatically performed. If you turn POWER on while getting a load force, the display becomes "0" and you cannot measure accurate values.

## 5.5.Comparator

### 5.5.1.Comparator

Compare HI / LO limits which you entered. The results appear on the display. In addition, an output signal of the result is available with the data output port. In order to activate the comparator function, set Hi-Lo at External output (f06) in the function settings. When you set "ovEr" at the External output (f06), a result will not appear and the output signal does not perform.

### 5.5.2.How to enter Comparator / Memory setting mode

Turn POWER off, press PEAK key and hold, then press POWER key and release (release PEAK key after the value is displayed more than 1 second).

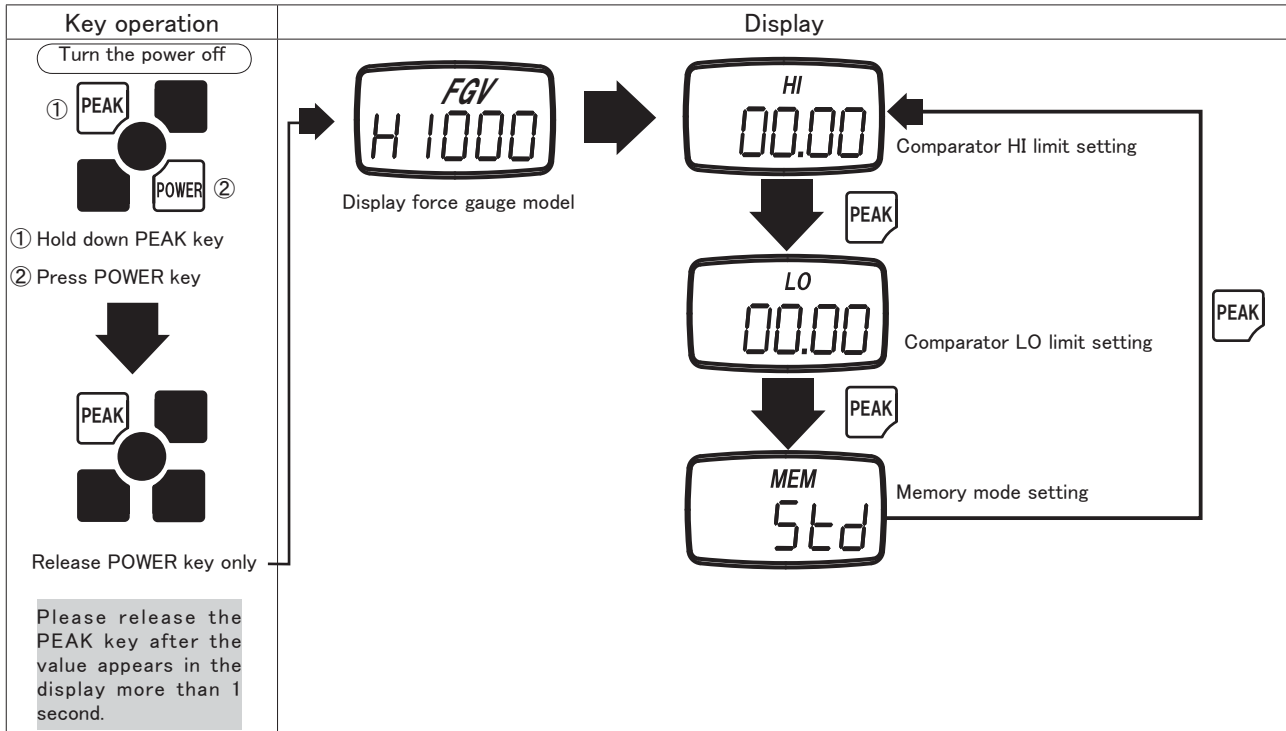

There are following setting items for comparator /memory setting mode.

Item	Display	Content of setting	Default factory setting
Comparator HI limit	HI	Set the comparator HI limit※	0
Comparator LO limit	LO	Set the comparator LO limit※	0
Memory mode setting	MEM	Set the memory mode (single mode, continuous mode, standard mode)	Std

When you set "0" at both HI limit and LOW limit, comparator function does not work.

### 5.5.3.Setting HI limit

- Press the UNIT key then all 4 digits turn on and off. Press the UNIT key once more, you can chose sign (plus or minus).
- Choose 0,1,2,3,4,5,6,7,8,9 at 4 ~ 1 digit (when you prees UNIT key at 9, it turns 0). Press ZERO key to move right one digit. In this case, chosen number is displayed with unit which is chosen at standard measuring mode. (When you change the unit at standard measuring mode after the setting of HI limit, the conversion of the unit for HI limit value is not performed. After the change of the unit, please set the HI limit again.)
- Press PEAK key, then move to the setting of comparator LO limit
- Press MEM key, then setting value is registerd and move to standard measuring mode.
- When you set both HI and LO limit with "0" , comparator function does not work.

#### NOTICE



You can set the value regardless of rating capacity. In the case you set the value which is out of the range for rating capacity, comparator function might not work properly.

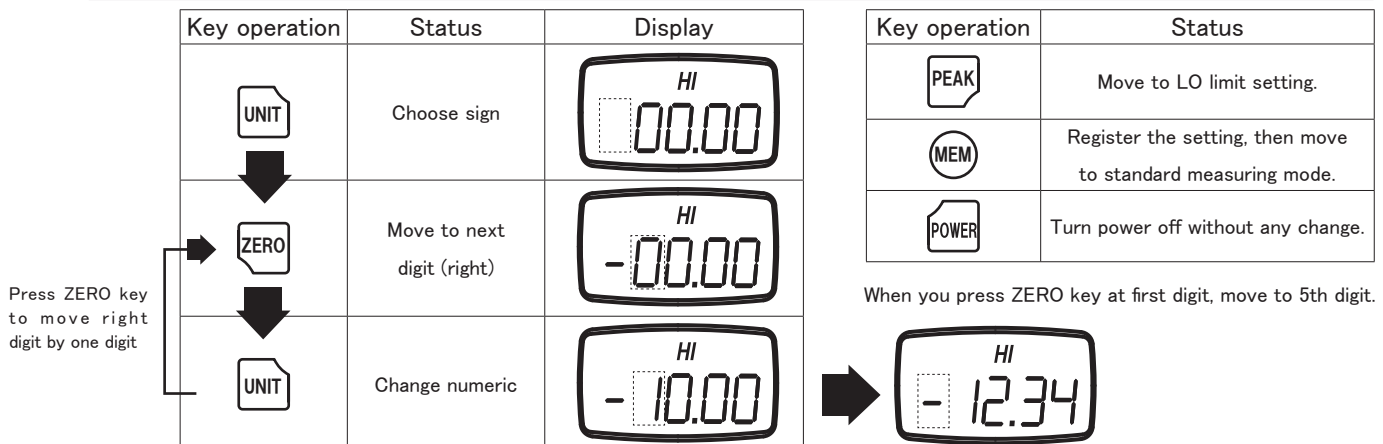

## 5.5.4.Setting LO limit

- (1) Press PEAK key during comparator HI limit setting, then move to LO limit setting.
- (2) Setting way is the same as the comparator HI limit setting.
- (3) Press MEM key, then setting value is registered, and move to standard measuring mode.
- (4) When you set HI and LO limit with "0", comparator function does not work.

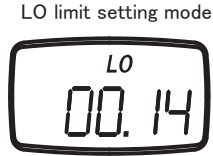

Key operation	State
	Move to memory mode.
	Register the setting, then move to standard measuring mode.
	Turn power off without any change.

## 5.5.5.Judgement on LCD

Compare the measuring value to comparator HI / LO limit value, then show  $\Delta$ / $\nabla$  after the unit.

" $\Delta$ " means measuring value  $>$  HI limit

" $\nabla$ " means measuring value  $<$  LO limit

Relation between judgement and display is as follows.

	Data $\leq$ HI limit Data $\geq$ LO limit	Data $>$ HI limit Data $\geq$ LO limit	Data $\leq$ HI limit Data $<$ LO limit	Data $>$ HI limit Data $<$ LO limit
In case of N (unit)				
LED light on	Hi-NG   OK   Lo-NG ●   ○   ●	Hi-NG   OK   Lo-NG ○   ●   ●	Hi-NG   OK   Lo-NG ●   ●   ○	Hi-NG   OK   Lo-NG ○   ●   ○

※ In order to activate the display of comparator judgement, you have to set "Hi-Lo" at function mode "External output (f06)".

## 5.5.6.Output signal of judgement

Compare the measuring value to comparator HI / LO limit value, then the signal of comparator judgement will be outputted through the data output port.

Measuring value  $>$  HI limit value  $\Rightarrow$  Turn on output signal of comparator HI limit.

Measuring value  $<$  LO limit value  $\Rightarrow$  Turn on output signal of comparator LO limit.

※ In order to activate output signal of comparator judgement, please set "Hi-Lo" at function mode "External output (f06)".

## 5.6.Memory

There are 3 modes at memory mode as follows.

Continuous memory	Force gauge creates the instant measured memory upto 1000 records continuously. It is possible to create statistical data by using the memorized data in the Force gauge.
Single memory	Force gauge memorizes the instant measured data when "MEM" key is pressed. It can memorize up to 100 records. It is possible to create statistical data* by using the memorized data in the Force gauge. Statistical data includes Maximum, Minimum, peak value, average, and standard deviation.
Standard memory	Force gauge starts creating the statistical data* based on the measured value and the last memorized data. This memory mode starts when pressing "MEM" key and stops by pressing "MEM" key again. Statistical data includes Maximum, Minimum, and peak value.



[Definitions of the terms]

Measuring value: Displayed value which is per display update time at standard measuring mode.

Plus maximum value (+MAX): Maximum value at plus side which is measured within memory measuring interval.

Minus maximum value (-MAX): Maximum value at minus side which is measured within memory measuring interval.

Plus minimum value (+MIN): Minimum value at plus side which is measured within memory measuring interval.

Minus minimum value (-MIN): Minimum value at minus side which is measured within memory measuring interval.

Example of +MAX, -MAX, +MIN, -MIN (Continuous memory mode)

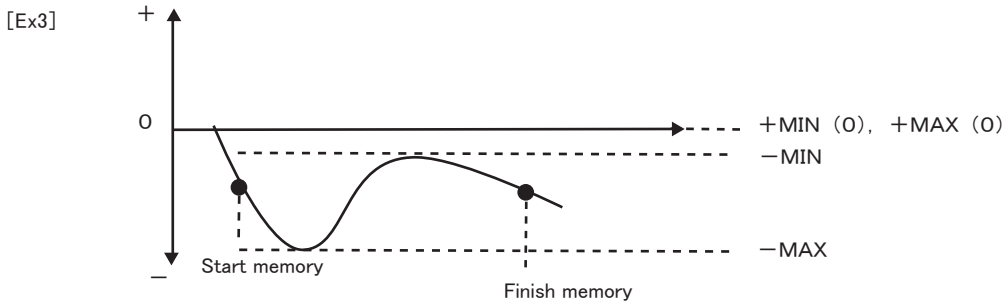
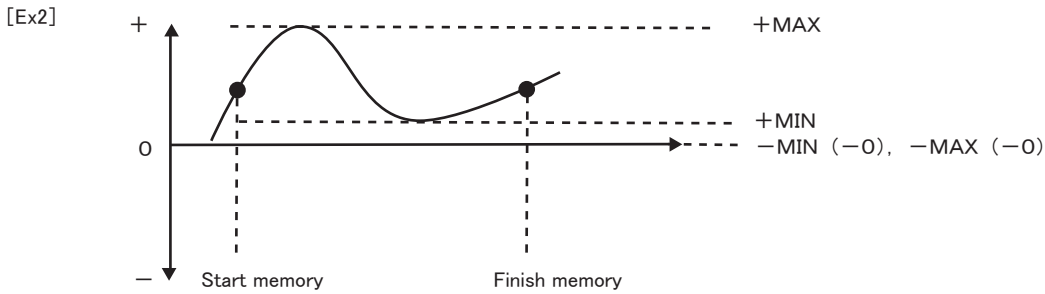
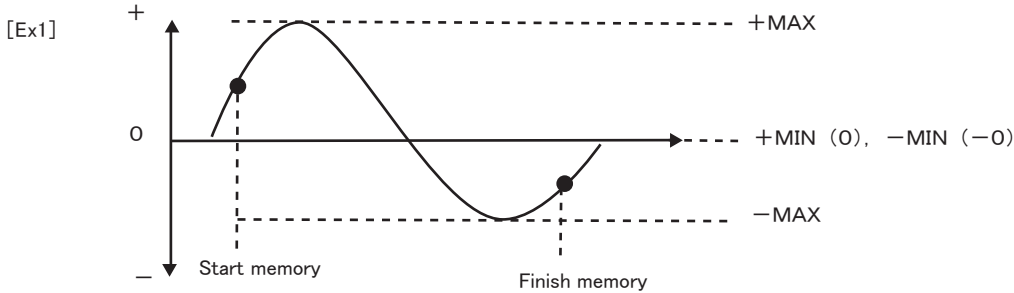

- Average value (AVE) : Average value of measuring value which is measured within memory measuring interval.  $\sum X_i/n$
- Standard deviation (DEV) : Standard deviation of measuring value which is measured within memory measuring interval.  $\sqrt{\sum (X_i - \bar{X})^2/n}$
- Plus peak value : Plus peak value within memory measuring interval (Maximum value within sampling interval 1000 times/second).
- Minus peak value : Minus peak value within memory measuring interval (Minimum value within sampling interval 1000 times/second)
- Last measuring value (LST) : Value which is measured in the end of memory measuring interval.

## 5.6.1. Setting memory mode

Turn the POWER off. Press PEAK key and hold, then press POWER key. Comparator HI limit setting turns on, then press PEAK key twice. Memory setting mode turns on.

There are following setting items for comparator \* memory setting mode.

Item	Display	Content	Default factory setting
Comparator HI limit setting	HI	Set comparator HI limit *	0
Comparator LO limit setting	LO	Set comparator LO limit *	0
Memory mode setting	MEM	Set memory mode (Single mode, Continuous mode, Standard mode)	Std

\* When you set "0" at both HI limit and LO limit, comparator function does not work.

At memory mode setting, you can set single memory, continuous memory, standard memory.

- (1) Switch memory mode (SinG (single memory mode), Cont (continuous memory mode), Std (standard memory mode)) by UNIT key.
- (2) Press PEAK key to move comparator upper limit setting.
- (3) Press MEM key to register the setting, and move to standard display.

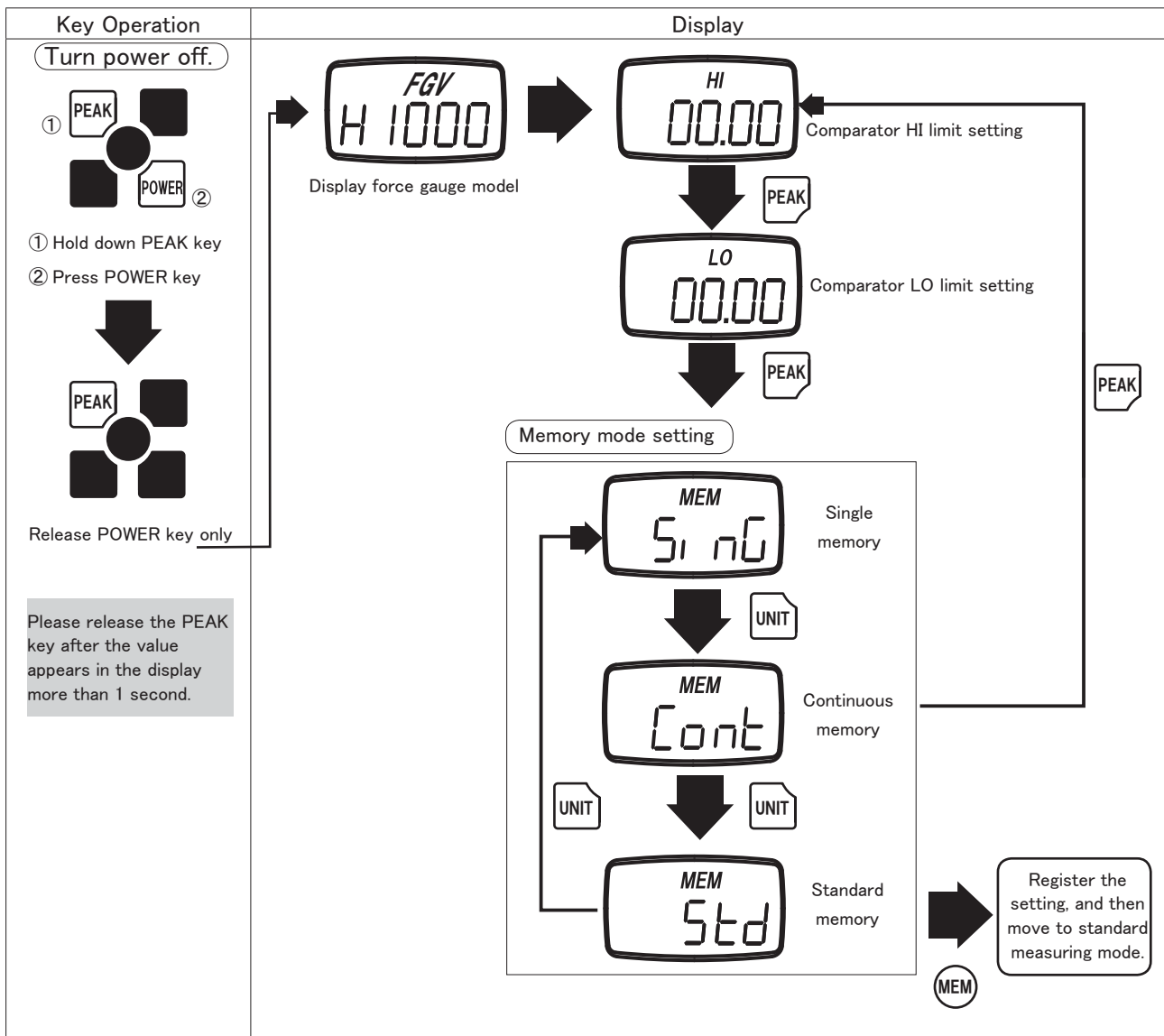

## 5.6.2. Storing data

Store the data at setting memory mode (single memory, continuous memory, standard memory).

### 5.6.2.1. Store the data (Continuous memory mode)

- (1) During the standard measuring mode, please press MEM key. Then "M" blink, start the record. Press MEM key, measurement is finished, and then display of the unit is changed from M into the unit.
- (2) When the memory reaches the 1000th recorded entry, "FULL" appears on the display. The recording is finished and will move to the standard measuring mode.

Key operation	Status	Display (" " means blinking)
(MEM)	Standard measuring mode	
—	Registering the data	
(MEM)	The record is finished	

When amount of memory number arrive at 1000

### 5.6.2.2. Store the data (Single memory mode)

- (1) During the standard measuring mode, please press MEM key. Then "M" turn on at the unit display and the present display (one data) is recorded.
- (2) If 100 data are already recorded, "FULL" appears for 1 second at the value display. Then move to standard measuring mode.

Key operation	Status	Display
(MEM)	Standard measuring mode	
—	Registering the data	

When amount of memory number arrive at 100

### 5.6.2.3. Store the data (Standard memory mode)

Press MEM key during the standard measuring, then "M" blink at the unit display, start the record. Press MEM key again to finish measurement, then display of the unit return to the unit display.

Key operation	Status	Display (" " means blinking)
(MEM)	Standard measuring mode	
—	Registering the data	
(MEM)	The record is finished	





When amount of memory number arrive at 50

## 5.7.Recalling memory data

### 5.7.1.Continuous memory mode

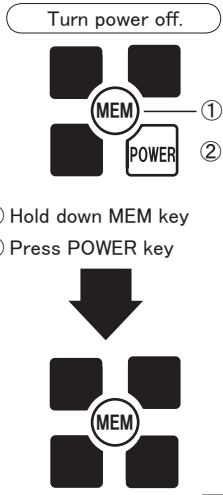
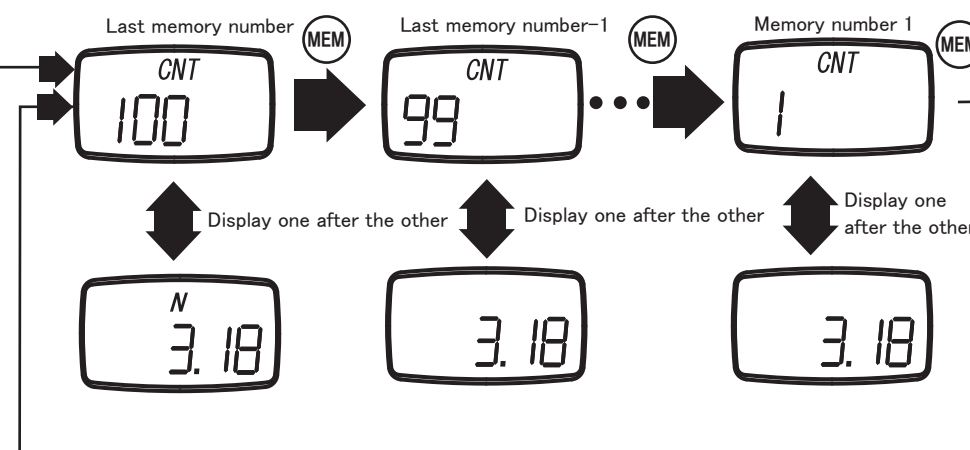
#### 5.7.1.1.Measuring memory data

- (1) Turn the POWER off. Press MEM key and hold, then press and release POWER key (release MEM key after the value appear in the display more than 1 second), then move to display measuring memory data.
- (2) Start to display from the last memory data which is recorded. Memory number and data appear one after the other.
- (3) Press MEM key to display previous memory number (when memory number is 1, move to last memory data number).
- (4) Press PEAK key to output with RS-232C (regarding output format, please download "FGV series RS-232C communication command list" from our web site. And, please refer "6.2.2. RS-232C communication command" for the detail.). Move to standard measuring mode.

Key operation	Display
<p>Turn power off.</p>  <p>① Hold down MEM key ② Press POWER key</p> <p>Release POWER key only</p> <p>Please release the MEM key after the value appears in the display more than 1 second.</p>	
	Delete the data when last memory data is displayed.
	Display the statistics memory data.
	Output the memory data with RS-232C, and then move to standard measuring mode.
	Finish display of the memory data. (Turn the power off)

## 5.7.1.2. Statistics memory data



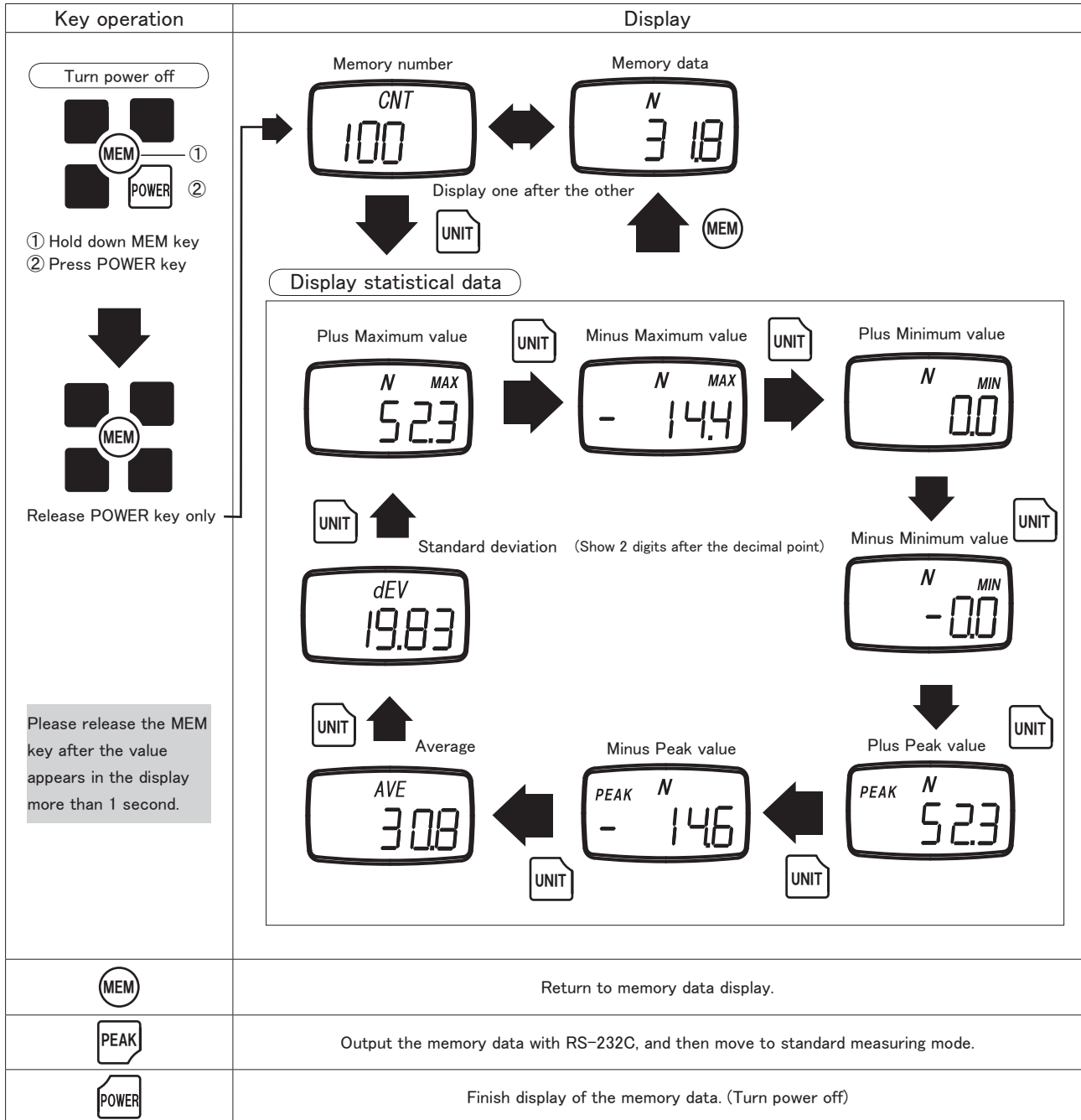

- (1) Press UNIT key during the measuring memory data, statistical data appear.
- (2) Every time UNIT key is pressed, switch the display item, plus maximum value → minus maximum value → plus minimum value → minus minimum value → plus peak value → minus peak value → average value → standard deviation.
- (3) Press MEM key during the statistical data, measuring memory data appear.
- (4) Press PEAK key to move RS-232C output (regarding output format, please refer “6.2.2. RS-232C communication command” ).  
Move to standard measuring.

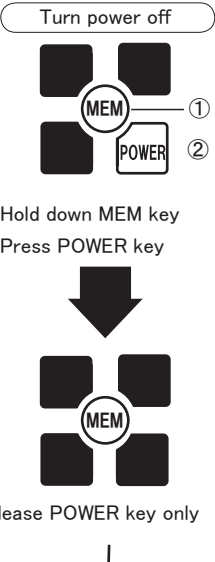
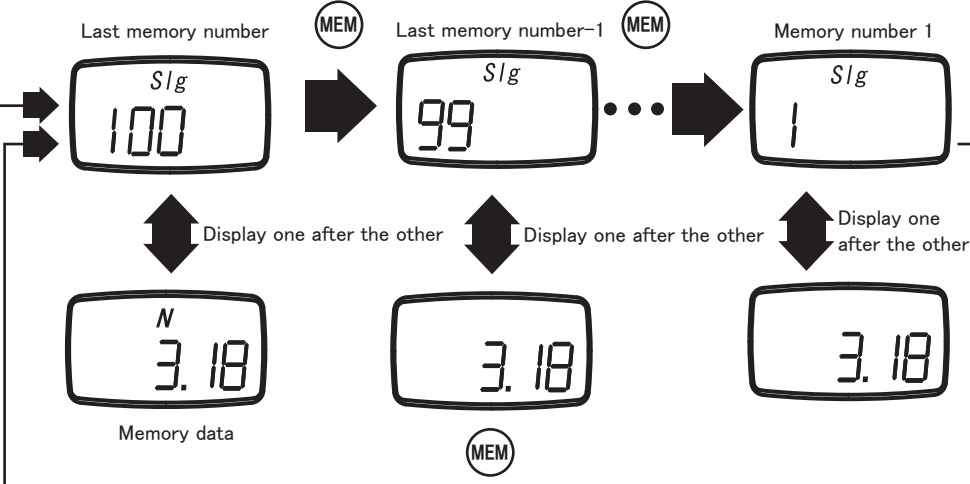

## 5.7.2. Single memory mode

### 5.7.2.1. Measuring memory data

- (1) Turn POWER off. Press MEM key and hold, then press and release POWER key (release MEM key after the value appear in the display more than 1 second), then measuring memory data is displayed.
- (2) Start to display from the last data and show memory number and data alternatively.
- (3) Press MEM key to display previous memory number (when memory number is 1, move to last memory data number).
- (4) If PEAK key is pressed, output of RS-232C is processed. (Regarding the output format, please download "FGV series RS-232C communication command list" from our web site. Please refer to "6.2.2. RS-232C communication command" for the detail.) Move to standard measuring mode.

Key operation	Display
<p>Turn power off</p>  <p>① Hold down MEM key ② Press POWER key</p> <p>Release POWER key only</p> <div style="border: 1px solid gray; padding: 5px; margin-top: 10px;"> <p>Please release the MEM key after the value appears in the display more than 1 second.</p> </div>	 <p>Last memory number (MEM) Last memory number-1 (MEM) Memory number 1</p> <p>S/g S/g S/g</p> <p>100 99 1</p> <p>Display one after the other</p> <p>N N N</p> <p>3.18 3.18 3.18</p> <p>Memory data (MEM)</p>
	Delete the data when last memory data is displayed.
	Display the statistics memory data.
	Output the memory data with RS-232C, and then move to standard measuring mode.
	Finish display of the memory data. (Turn power off)

## 5.7.2.2. Statistics memory data



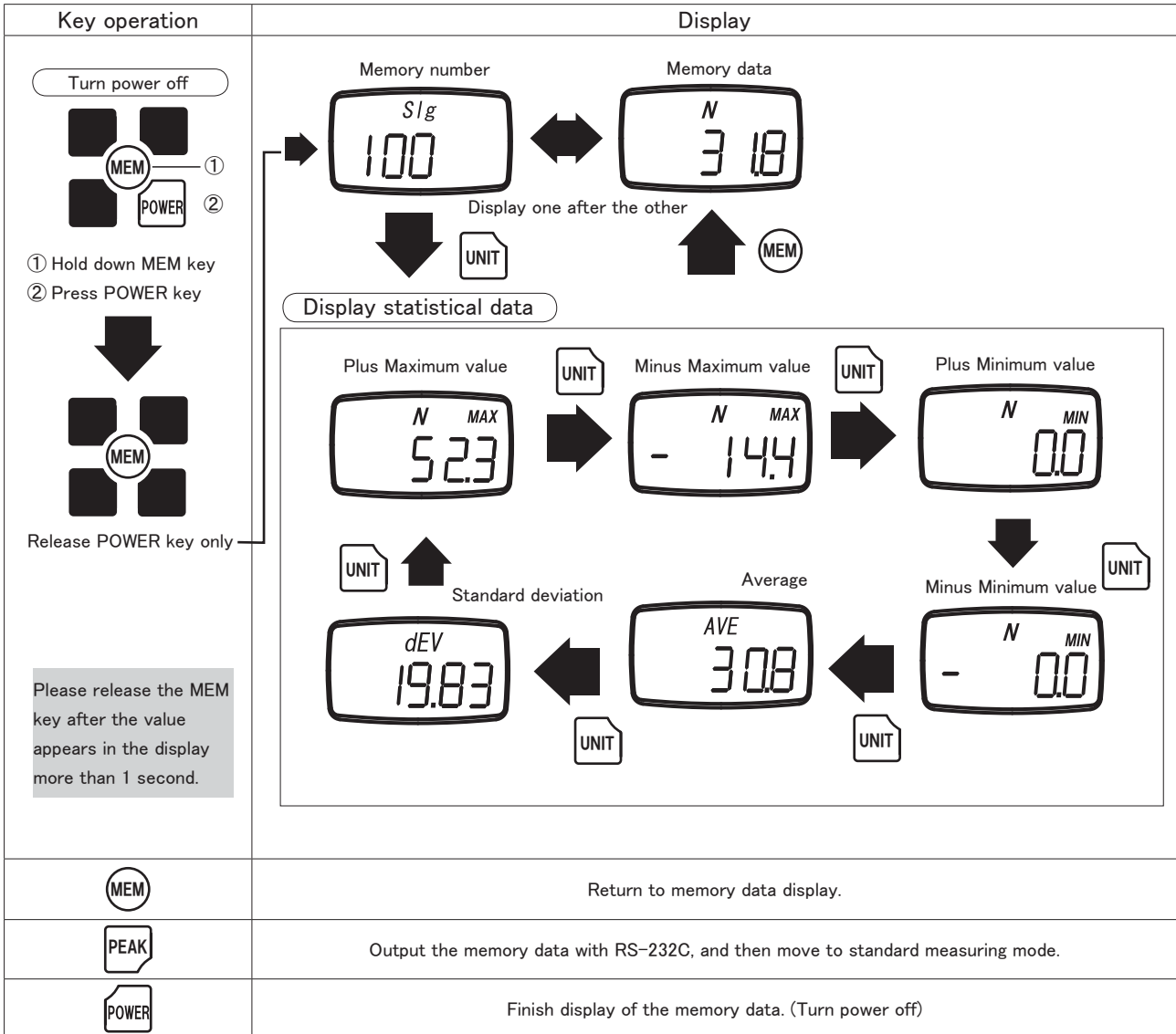

- (1) When measuring memory data is displayed, the display shifts to statistical memory data by pressing UNIT key.
- (2) Each time you press UNIT key, the display switches in order of plus maximum value → minus maximum value → plus minimum value → minus minimum value → average value → standard deviation.
- (3) When statistical memory data is displayed, the display shifts back to measuring memory data if you press MEM key.
- (4) If pressing PEAK key, output of RS-232C is processed and then display shifts back to standard measuring mode.  
(Regarding the output format, please download "FGV series RS-232C communication command list" from our web site.  
Please refer to "6.2.2. RS-232C communication command" for the detail.)

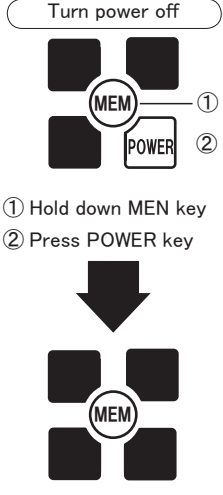
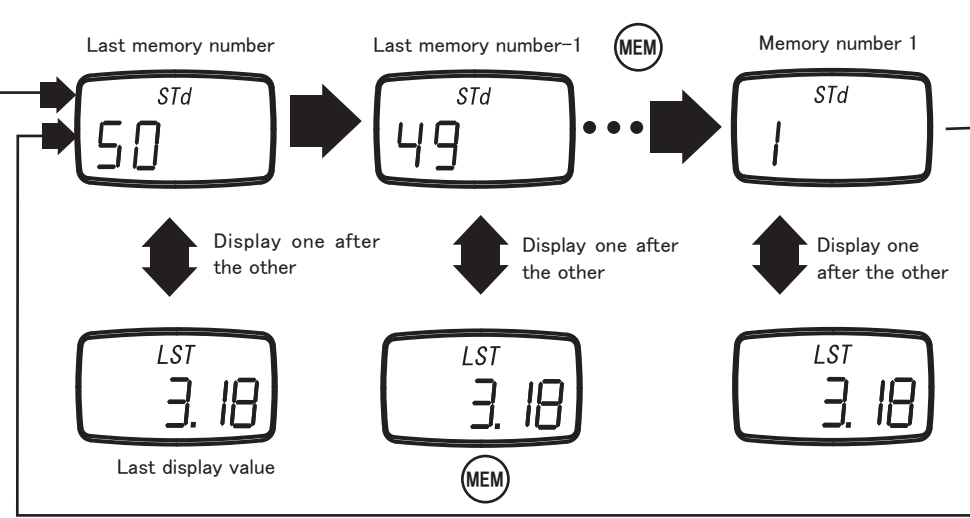

## 5.7.3. Standard memory mode

### 5.7.3.1. Measuring memory data

- (1) Turn POWER off. Press MEM key and hold, then press and release POWER key  
(release MEM key after the value appear in the display more than 1 second), then measuring memory data is displayed.
- (2) Start to display from the last data and show memory number and data alternatively.
- (3) Press MEM key to display previous memory number (when memory number is 1, move to last memory number).
- (4) If PEAK key is pressed, output of RS-232C is processed. Then display shifts back to measuring mode.  
(Regarding the output format, please download "FGV series RS-232C communication command list" from our web site. Please refer to "6.2.2. RS-232C communication command" for the detail.)

Key operation	Display
<p>Turn power off</p>  <p>① Hold down MEN key ② Press POWER key</p> <p>Release POWER key only</p> <p>Please release the MEN key after the value appears in the display more than 1 second.</p>	 <p>Last memory number</p> <p>Last memory number-1</p> <p>MEM</p> <p>Memory number 1</p> <p>STd</p> <p>50</p> <p>49</p> <p>1</p> <p>Display one after the other</p> <p>LST</p> <p>3.18</p> <p>Last display value</p> <p>MEM</p>
	Delete the data when last memory data is displayed.
	Display the statistics memory data.
	Output the memory data with RS-232C, and then move to standard measuring mode.
	Finish display of the memory data. (Turn power off)



### 5.7.3.2. Statistics memory data

- (1) When measuring memory data is displayed, display shifts to statistics memory data by pressing UNIT key.
- (2) Each time you press UNIT key, display switches in order of plus maximum value → minus maximum value → plus minimum value → minus minimum value → plus peak value → minus peak value.
- (3) When statistics memory data is displayed, display shifts back to measuring memory data if you press MEM key.
- (4) Output of RS-232C is processed if you press PEAK key and display shifts to standard measuring mode. (Regarding the output format, please download "FGV series RS-232C communication command list" from our web site. Please refer to "6.2.2. RS-232C communication command" for the detail.)

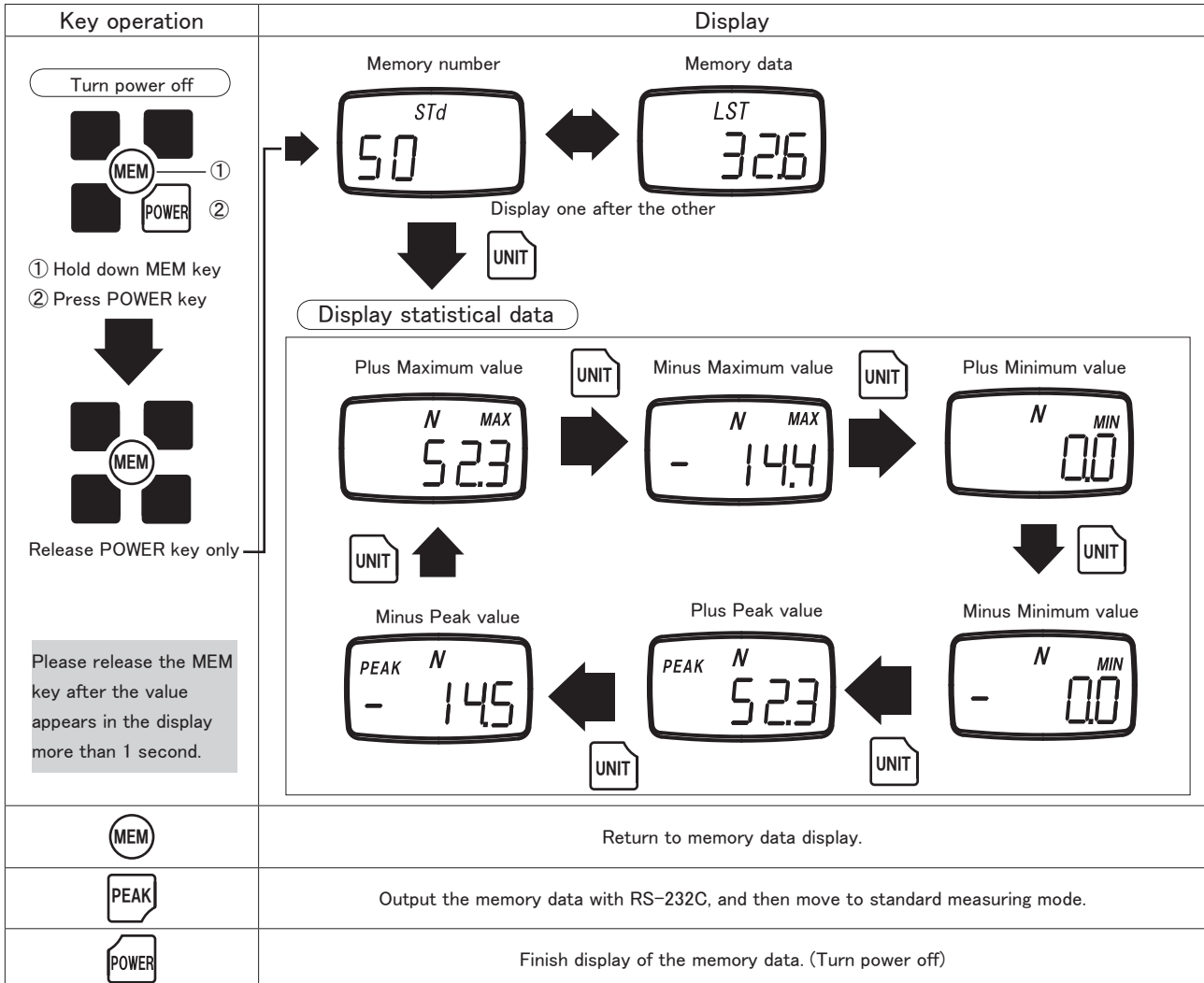

### 5.8. Erasing memory data

#### 5.8.1. Elimination of one last data

- (1) When last measuring memory data is displayed, last data is erased if you push ZERO key. The memory data before erased last data will be memory number of last data, and then display shifts to measuring memory data.
- (2) If you press ZERO key except when last data is displayed, display shifts to measuring memory data after "Err" is displayed for one second at measuring display.

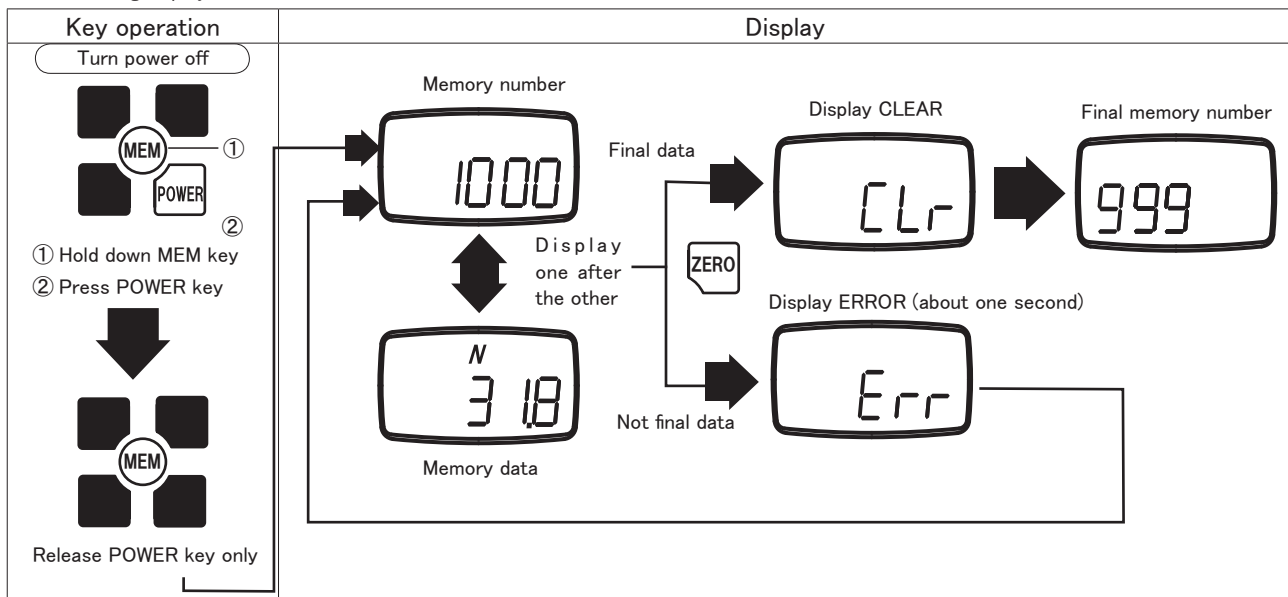

## 5.8.2. Erasing all memory data

- (1) When last memory data is displayed, all data will be erased if you press ZERO key for at least 5 seconds.
- (2) Display switches to standard measuring mode after showing "nonE" for one second at measuring display.
- (3) All memory data of current memory mode is erased.

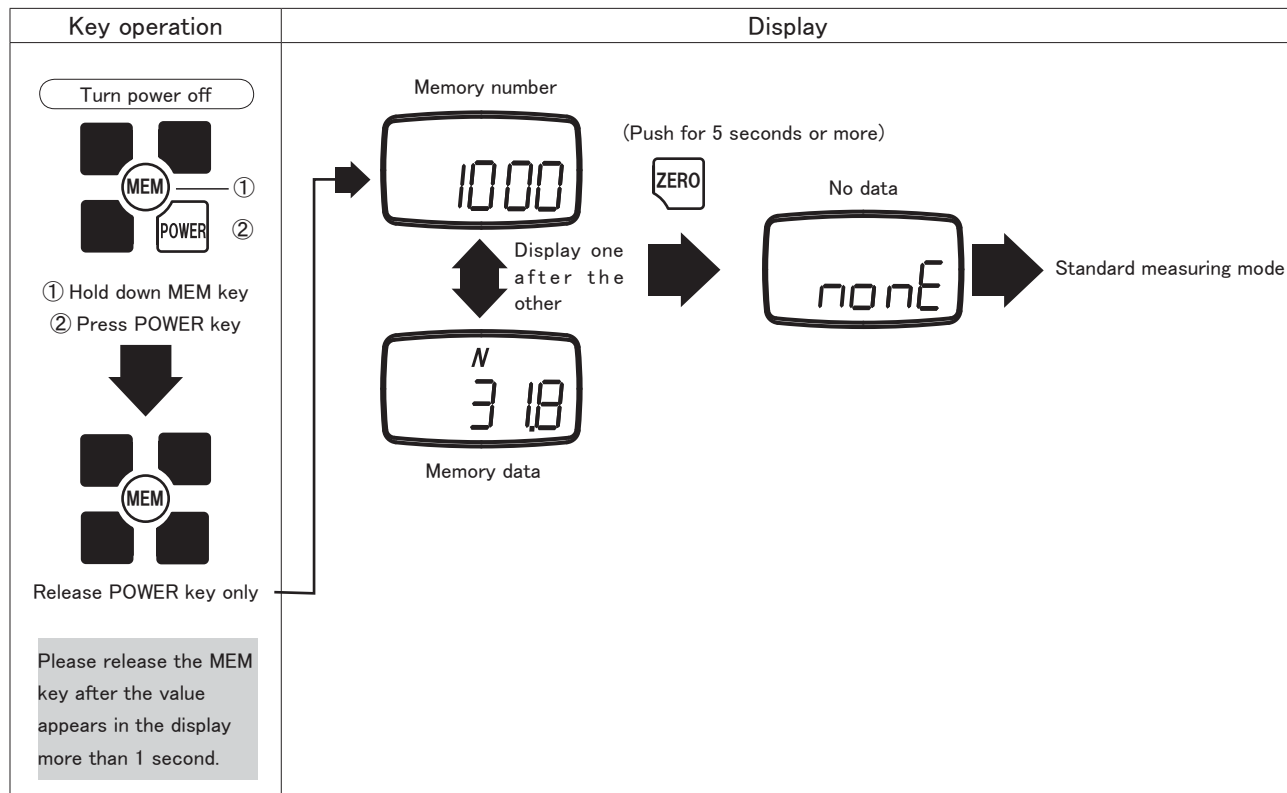

## 5.8.3. No memory data

Display shows "nonE" if switching to measuring memory data display mode.



If no data is stored in memory, "nonE" is displayed for one second, the display will go back to the current measuring mode.

## 5.9. USB communication

If you connect the force gauge to a PC with the USB cable, you can download data to the PC from the force gauge of the current values being measured or from data that is stored in memory. See below on how to install the communication software ToriemonUSB.

### 5.9.1. Features of ToriemonUSB

You can take measuring data or memory data of force gauge directly into the excel seat by using "Toriemon USB" which is Excel add-in software. There you can analyze the recorded data or make graphs easily..

※ Microsoft Excel is registered as trademark of Microsoft Corporation in U.S.A.

### 5.9.2. Download ToriemonUSB

Please access our web site (<http://www.nidec-shimpo.co.jp/en/is/fg/fgp/index.html>) and register download. After registration, you will get ID and password, and then access download site to download "Toriemon USB" .

If you doubleclick the downloaded file, PDF file "Toriemon USB instruction manual" is made in the same holder with the downloaded file. Please refer to the content of this instruction manual regarding the installing procedure of Torieom USB, function explanation, and operating procedure.

### 5.9.3. Precaution when using USB communication

Do not leave USB cable connected for extended period of time. If you leave USB cable connected, battery power tends to deplete even if the power of force gauge is off. (No problem for using AC adapter)

## 6.External Connection Connection

### 6.1.Pin assignment

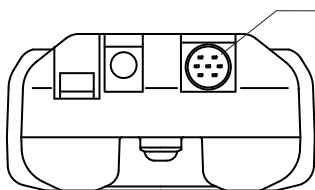

HR12 — 10RC — 10SDL made in Hirose is used for connector.

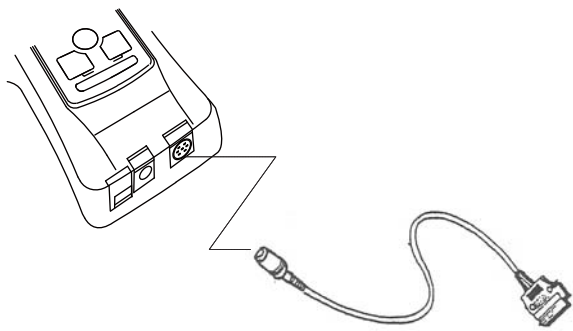
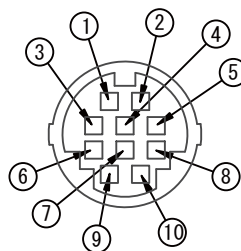

RS-232C communication cable: 2 m (Option)

Pin Number	Signal Name
①	Analog +
②	Analog GND
③	RxD (RS-232C Received data) Host computer ⇒ FGP
④	Digital GND
⑤	Detection of Connection
⑥	TxD (RS-232C Transmitted data) FGP ⇒ Host computer
⑦	(Connection disabled ※1)
⑧	Compression overload / LO output of comparator※2
⑨	Tension overload / HI output of comparator※2
⑩	Common of overload / comparator

※1 Please leave the pin ⑦ is always unconnected.

※2 Switch of overload output/comparator output can be set by external output setting (f06) of function mode.

## 6.2.RS-232C Output

You can operate this equipment from your PC if connecting it by using optional cable for RS-232C.

\* Cannot use USB communication and RS-232C communication at the same time.

### 6.2.1.RS-232C interface

Baud rate*	: 2400, 4800, 9600, 19200 bps
Length of data bit	: 8bit
Parity bit	: None
Length of stop bit	: 1bit
Flow control	: None

\* Please set baud rate according to RS-232C baud rate setting (f04) of function setting.

Default factory settings is 2400 bps. Please use your equipment as the above parameter.

Alphanumeric characters and carriage return (cr) of ASCII code is used for transmitting data.

## 6.2.2.RS-232C communication command

### ■ Typical communication command

“cr” means carriage return.

Transmitting command from host computer to FGP	Content	Returning command from FGV	Explanation
AAcr	Tare	AAcr	
ABcr	Cancel of data transmission	ABcr	
ACcr	Switch to plus peak hold mode	ACcr	
ADcr	Switch to standard measuring mode	ADcr	
ALcr	Switch to minus peak hold mode	ALcr	
AEcr	Clear the plus/minus peak value to zero	AEcr	
AFcr	Switch the unit to kg	AFcr	
AGcr	Switch the unit to N	AGcr	
AHcr	Switch the unit to lb	AHcr	
AKcr	Switch the unit to oz	AKcr	
BAcr	Transmission request of one measuring data (measuring value at present)	BAcr NA□□□□□□cr	□□□□□□ : 6-digit value including sign, decimal point and 4-digit number
BBcr	Request for continuous transmission of measuring data (10 times/second)	BBcr NA□□□□□□cr	
BB1cr	Request for continuous transmission of measuring data (20 times/second)	BB1cr NA□□□□□□cr	
BB2cr	Request for continuous transmission of measuring data (50 times/second)	BB2cr NA□□□□□□cr	
BB3cr	Request for continuous transmission of measuring data (100 times/second)	BB3cr NA□□□□□□cr	
BCcr	Transmission request of model	BCcr NE□□cr	□□ : 2-digit number indicating model OC : FGV — 500HXY OD : FGV — 1000HXY
BDcr	Transmission request of unit	BDcr NH□cr	□ : one-digit number indicating unit 0 : N, 1 : kg, 2 : g, 3 : lb, 4 : oz
BEcr	Transmission request of plus peak value	BEcr NB□□□□□□cr	□□□□□□ : 6-digit value including sign, decimal point and 4-digit number
BFcr	Transmission request of minus peak value	BFcr NC□□□□□□cr	
In the communication with host computer, when FGV detect communication error, transmit the error command.		OBcr	Command format error (mistake command)
		OFcr	Flaming error
		OHcr	Overrun error

### ■ Other communication command

Other than those above, a lot of communication commands are prepared.

Please access our web site (<http://www.nidec-shimpo.co.jp/en/is/fg/fgp/index.html>) and register download.

After registration, you will get ID and password, and then access download site to download “FGV RS-232C communication command table” .

## 6.2.3. Connection between FGV and PC

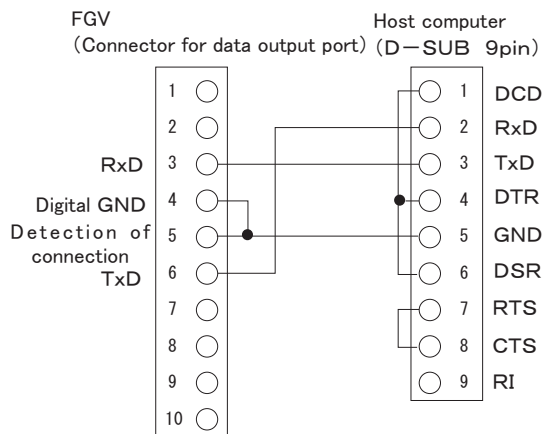

Please be sure to connect 5pin into 4 pin of digital GND when making cable for RS-232C on your own. It cannot be transmitted without this connection.

## 6.3. Analog output

Output  $\pm 1V$  for display range.

Output plus voltage when measuring value is plus (when compressing) and minus voltage when measuring value is minus (when tensioning). Output will be nearly 0 V if you press ZERO key and tare.

Output signal	$\pm 1V$ ( $\pm$ Range which display is possible)
Signal method	12 bit D/A convertor method
Output update	1000 times / second *
Load resistance	10 k $\Omega$ or more
Output accuracy	$\pm 50mV$

The data will be updated 1000 times for one second as the measuring value is changed to analog by 12 bit D/A converter. Please adjust output to 0 V on your own since this equipment cannot respond to it. Load resistance is 10k  $\Omega$  or more.

When using analog cable (option), please plug the connector side of cable into connector for data output port of FGV and connect red banana plug into plus and black banana plug into minus.

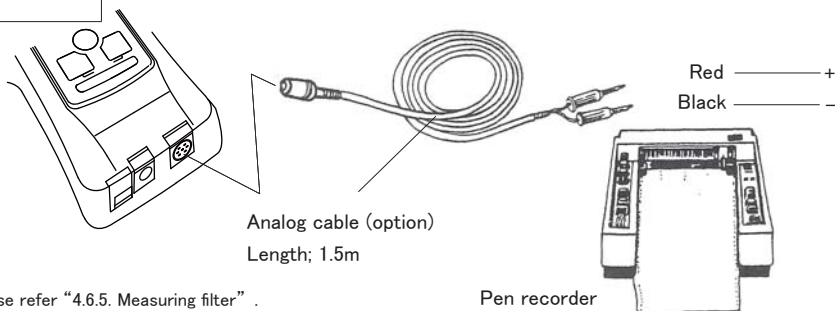

\* It's depending on the measuring filter setting (f05). Please refer "4.6.5. Measuring filter".

## 6.4. Overload output

Output overload/comparator signal.

Switch of output overload/comparator signal is set by external output setting (f06) of function mode.

### ● I/F Circuit

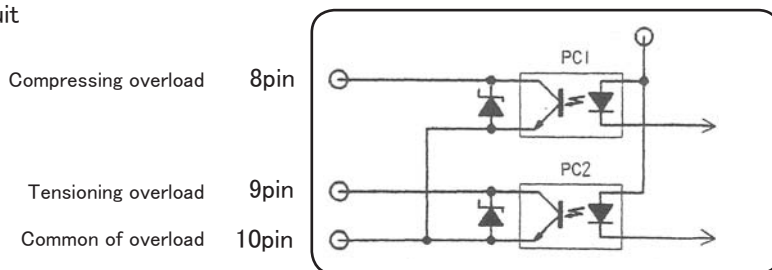

Maximum allowance voltage DC 30V / current 5mA

Please connect the power and load to avoid going over maximum allowance.

### ● Overload output

Output signal \* when overloaded. If you use it with installing other equipment or it is installed in motorized test stand, security alarm can be connected and protect the force gauge.

If overloading works toward the compressing direction, photo-coupler PC1 will be on and the current flows.

If overloading works toward the tensioning direction, photo-coupler PC2 will be on and the current flows.

If not overloaded, photo-coupler of PC1 and PC2 will be off and the current doesn't flow.

\* Output when overloading is about 120% (not including tare value) of rating capacity.



## 7.4 External input signal

By an input signal from the outside, it is possible to perform tare influence (ZERO signal input), the hold of a measurement value (HOLD signal input), and the change to a peak operation mode (PEAK signal input).

### ● Input circuit

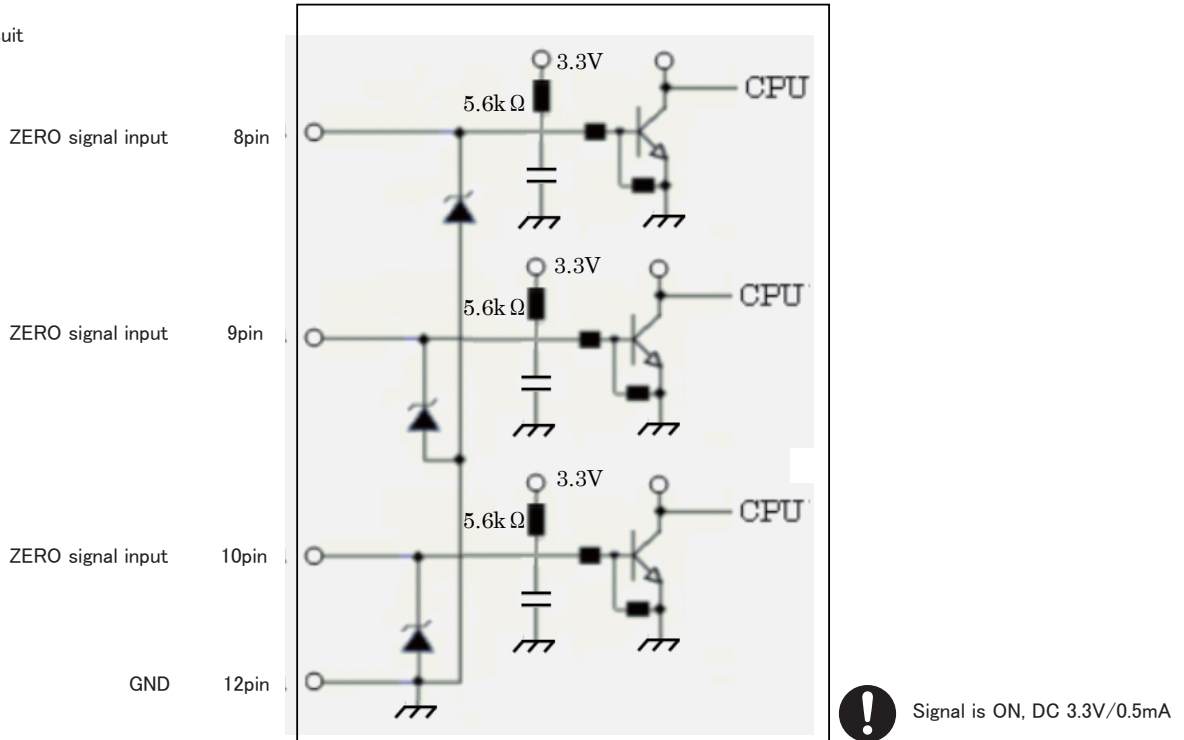

### ● Signal input

#### 1. ZERO signal input

Tare and peak reset are performed when ZERO signal input pin (8 pin) and GND (12 pin) is changed from OPEN to CLOSE (ZERO signal is ON).

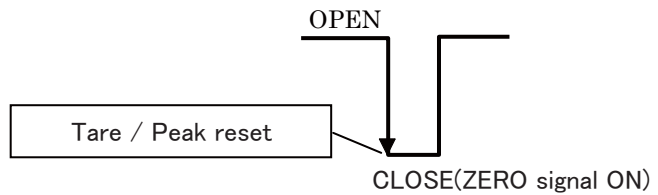

#### 2. HOLD signal input

HOLD signal is ON when HOLD signal input pin (9 pin) and GND (12 pin) is changed from OPEN to CLOSE. The display number doesn't change while HOLD signal is ON. And "HLD" is shown on the sub display. When HOLD signal is OFF, the display is back to the measuring mode.

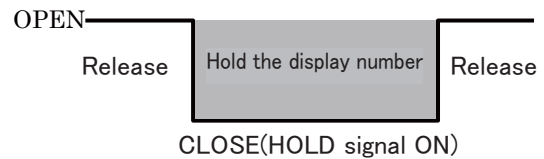

#### 3. PEAK signal input

PEAK signal is ON when PEAK signal input pin (10 pin) and GND (12 pin) is changed from OPEN to CLOSE. While PEAK signal is ON, if the function setting (f07) is +PEAK, the measuring mode is + peak mode. If -PEAK, the measuring mode is - peak mode. When the PEAK signal is OFF, it's the normal measuring mode.

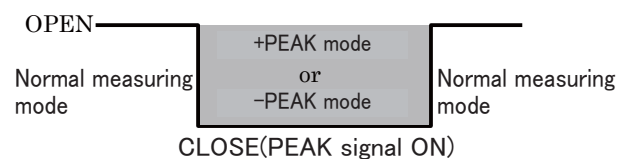
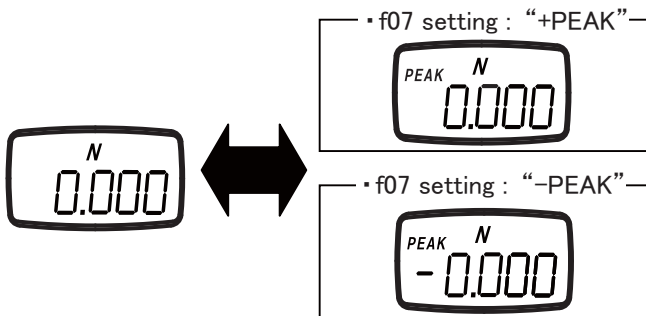

\* If the function setting (f07) is "nonE", PEAK signal is no effect. Cannot switch the measuring mode by using PEAK signal.

## 8.Frequently –asked questions

### 8.1.Troubleshooting

Questions	Cause	Presumable reason	Procedure
When turning on power, “OVR” is displayed even if not applying load and cannot be cleared by pushing ZERO key.	It is possible that internal loadcell is broken.	Unit was dropped or overloaded.	Contact a dealer for repair
Low bat displays even after the unit was charged for more than one day.	Voltage of battery is low.	<ul style="list-style-type: none"> <li>▪ End of battery life</li> <li>▪ Breakdown of battery</li> <li>▪ Breakdown of charging</li> </ul>	Contact a dealer for repair
It doesn't display anything even if pressing POWER Key.	Battery is weak.	Voltage of battery is lower.	Please charge a battery.
	“BAT” isn't displayed on LCD even if charging up.	<ul style="list-style-type: none"> <li>▪ Breakdown of battery</li> <li>▪ Breakdown of internal circuit</li> <li>▪ Breakdown of AC adapter</li> </ul>	Contact a dealer for repair.
The value becomes “0” automatically when measuring small value near 0.	You can use tracking to prevent the fluctuation of the measuring value near “0”.	Tracking is on.	Please set tracking off. (Refer to “4.5.Tracking”)
Value changes if you change the direction of force gauge.	This is not breakdown. This equipment is measuring the empty weight of sensor on its own.	Sensor or tools can add weight	Push ZERO key after setting the direction to measure and clear the measuring value.
Although I downloaded “Toriemon” , it doesn't work even if connecting force gauge.	-	Since “Toriemon” is software for RS-232C transmission, it doesn't respond to USB transmission.	Please download “Toriemon USB” and use it.

### 8.2.Technical issue

Questions	Explanation	Reference
How long does rechargeable battery (Nickel hydride battery) last?	Enable to use 500 times or more by complete electric discharge. It depends on the status of use.	Please charge battery after discharging electricity until “LO BAT” is displayed at LCD.
Why are there various rating capacities?	The value is more accurate when measuring near rating as much as possible.	It is ideal to use this equipment with 50% rating or more.
Why does measuring data show variations?	Although there are many reasons, the measuring value is affected by vibration if operated by hand.	Fluctuation will be reduced when using handle or stand.
How does biased loading affect accuracy?	Although it depends on the angle, you cannot measure accurate value with biased loading.	
How do you handle ISO caribration ?	Measure the load value with certified weights.	Weight with traceability is necessary.
Please tell easy test methods which user can.	Please hang the weight which is clear.	
Can user exchange battery?	User cannot exchange battery.	Ask our dealers to assist you with battery replacement.
Do you have CAD data?	Yes.	Please contact our dealer.
Is it possible to use in water?	No. It is not waterproof structure.	Please pay attention not to pour water.

## 9.Support

### 9.1.Repair and Calibration

We have calibration service for value. We recommend calibrating regularly for keeping up the accuracy of force gauge. Please ask our dealers for the price and lead time of the calibration.

### 9.2.Warranty

Nidec-Shimpo Corp. warrants, to the original purchaser of new products only, that this product shall be free from defects in workmanship and materials under normal use and proper maintenance for one year from the date of original purchase.



## 10.Specifications and Dimensions

Model	High capacity type FGV-H series	
	FGV-500HXY	FGV-1000HXY
Rated capacity	± 2500N (± 250kg ± 500lb)	± 5000N (± 500.0kg ± 1000lb)
Display possible scope	± 2500N ± 500lb	± 5000N ± 1000lb
Display resolution power	1N/0.1kg/0.1lb(1lb)*	
Unit	N, kg(g) unit switchover (Reversible display)	
Measuring method	Normal measurement, plus peak, minus peak	
Display interval	1st times/sec, 2nd times/sec, 3rd times/sec, 5th times/sec, 10th times/sec, 20th times/sec	
Sampling interval	1000 times/sec	
Accuracy	± 0.2% R.C or ± 1/2 digit (at 23°C)	
Display equipment	4 digits indication with LCD tag (letter height 12mm)	
	3 type LED decision (Hi_NG, OK, Lo_NG)	
Comparator function	Hi_NG, OK, Lo_NG decision, output according to decided LED and output signal	
Communication	USB	with exclusive communication software, communication with P.C. is possible. Connecting cable is standard accessory.
	RS-232C	with exclusive communication command, communication with P.C. is possible. Connecting cable is optional.
	Digimatic	could be connected with Mitsutoyo digimatic printer.
Analog	± 1V (As against the output ± indication possible scope) Accuracy ± 50mV, 12bitD/A converter method	
	Output update 1000 revolutions/sec, zero setting is possible, load resistance more than 10kΩ	
Output	Overload	Overload PUSH, PULL Open corrector output (Max. DC30V/5mA)
	Comparator	Hi, OK, LO Open corrector output (Max. DC30V/5mA)
Input signal	ZERO (Output parts zero setting), HOLD (Outer parts hold)	
Current	AC adapter (DC9V/200mA) or Inner stored nickle hydrogen battery (rechargeable)	
	During recharging measurements possible Battery working possible time : after full charged battery about 10 hours Charging period : max. 17 hours (Automatically gets off when fully charged)	
Auto power off function	10 minutes (when AC adapter is connected, continuous usage is possible). Invalidate/Cancel function is also possible.	
Memory function	Continuous memory 1000 items/ Independent memory 100 items/ Standard memory 50 items	
	3 types of memory mode switching over possible Statistics function exists (Max, Min, Peak, Average, Standard deviation)	
Working Temperature range	32 to 104 F (0 to 40°C) (However, condensation not allowed)	
Working Humidity range	35 to 38% rH (However, condensation not allowed)	
Outer dimensions	W82 × Thick 57 × L 214mm	
Weight	2 lb (900g)	
Accessories	Measuring adapter (6types), hanger, AC adapter, carrying case, USB cable	
Communication software	Exclusive communication software (corresponding to USB) could be download free of cost from our Co.'s Home page.	

※ 1 In case of setting 150msec of measuring filter, 150 times/sec

※ 0 ~ 999.9 → 0.1 lb 1000 lb → 1 lb

※ 2 Outer dimension : FGV-100 is 149mm

## Dimensions

### ● FGV-1000HXY

