

# SDG Series Arbitrary Waveform Generator



## Programming Guide PG02\_E04A



## Content

<b>1</b>	<b>PROGRAMMING OVERVIEW .....</b>	<b>3</b>
1.1	BUILD COMMUNICATION VIA VISA .....	3
1.1.1	Install NI-VISA .....	3
1.1.2	Connect the instrument .....	7
1.2	REMOTE CONTROL .....	8
1.2.1	User-defined Programming .....	8
1.2.2	Using SCPI via NI-MAX .....	8
1.2.3	Using SCPI over Telnet.....	8
1.2.4	Using SCPI over Socket.....	10
<b>2</b>	<b>INTRODUCTION TO THE SCPI LANGUAGE .....</b>	<b>11</b>
2.1	ABOUT COMMANDS & QUERIES .....	11
2.2	DESCRIPTION .....	11
2.3	USAGE .....	11
2.4	COMMAND NOTATION .....	11
2.5	TABLE OF COMMAND & QUERIES .....	12
<b>3</b>	<b>COMMANDS AND QUERIES.....</b>	<b>14</b>
3.1	IEEE 488.2 COMMON COMMAND INTRODUCTION.....	14
3.1.1	*IDN.....	14
3.1.2	*OPC.....	15
3.1.3	*RST.....	16
3.2	COMM_HEADER COMMAND .....	16
3.3	OUTPUT COMMAND.....	17
3.4	BASIC WAVE COMMAND .....	18
3.5	MODULATE WAVE COMMAND .....	21
3.6	SWEEP WAVE COMMAND.....	25
3.7	BURST WAVE COMMAND .....	27
3.8	PARAMETER COPY COMMAND.....	30
3.9	ARBITRARY WAVE COMMAND .....	30
3.10	SYNC COMMAND .....	32
3.11	NUMBER FORMAT COMMAND.....	33
3.12	LANGUAGE COMMAND .....	33
3.13	CONFIGURATION COMMAND.....	34
3.14	BUZZER COMMAND.....	34
3.15	SCREEN SAVE COMMAND .....	35
3.16	CLOCK SOURCE COMMAND.....	35
3.17	FREQUENCY COUNTER COMMAND .....	36
3.18	INVERT COMMAND .....	37
3.19	COUPLING COMMAND .....	38

3.20	OVER-VOLTAGE PROTECTION COMMAND .....	39
3.21	STORE LIST COMMAND .....	40
3.22	ARB DATA COMMAND .....	42
3.23	VIRTUAL KEY COMMAND.....	44
3.24	IP COMMAND .....	46
3.25	SUBNET MASK COMMAND .....	47
3.26	GATEWAY COMMAND .....	48
3.27	SAMPLING RATE COMMAND .....	48
3.28	HARMONIC COMMAND.....	49
3.29	WAVEFORM COMBINING COMMAND.....	50
3.30	MODE SELECT COMMAND .....	51
3.31	MULTI-DEVICE SYNC .....	51
3.32	IQ COMMANDS .....	52
3.32.1	:IQ:CENTerfreq .....	52
3.32.2	:IQ:SAMPlerate .....	53
3.32.3	:IQ:SYMBolrate .....	53
3.32.4	:IQ:AMPLitude.....	53
3.32.5	:IQ:IQADjustment:GAIN .....	54
3.32.6	:IQ:IQADjustment:IOFFset.....	54
3.32.7	:IQ:IQADjustment:QOFFset .....	55
3.32.8	:IQ:IQADjustment:QSKew.....	55
3.32.9	:IQ:TRIGger:SOURce.....	55
3.32.10	:IQ:WAVEload:BUILtin.....	56
3.32.11	:IQ:WAVEload:USERstored .....	56
<b>4</b>	<b>PROGRAMMING EXAMPLES .....</b>	<b>58</b>
4.1	EXAMPLES OF USING VISA .....	58
4.1.1	VC++ Example .....	58
4.1.2	VB Example .....	65
4.1.3	MATLAB Example .....	70
4.1.4	LabVIEW Example .....	72
4.1.5	Python Example .....	74
4.2	EXAMPLES OF USING SOCKETS.....	77
4.2.1	Python Example .....	77
<b>5</b>	<b>INDEX.....</b>	<b>80</b>

# 1 Programming Overview

By using USB and LAN interfaces, in combination with NI-VISA and programming languages, users can remotely control the waveform generator. Through LAN interface, VXI-11, Sockets and Telnet protocols can be used to communicate with the instruments. This chapter introduces how to build communication between the instrument and the PC. It also introduces how to configure a system for remote instrument control.

## 1.1 Build communication via VISA

### 1.1.1 Install NI-VISA

Before programming, please make sure that you have properly installed the latest version of National Instruments NI-VISA Software.

NI-VISA is a communication library that enables computer communications to instrumentation. There are two available VISA packages: A full version and the Run-Time Engine. The full version includes NI device drivers and a tool named NI MAX; a user interface to control the device. While the drivers and NI MAX can be useful, they are not required for remote control. The Run-Time Engine is a much smaller file and is recommended for remote control.

For convenience, you can obtain the latest version of the NI-VISA run-time engine or full version from the National Instruments website. The installation process is similar for both versions.

Follow these steps to install NI-VISA (The full version of NI-VISA 5.4 is used in this example):

- a. Download the appropriate version of NI-VISA (the Run-time engine is recommended)
- b. Double click the visa540\_full.exe, dialog shown as below:

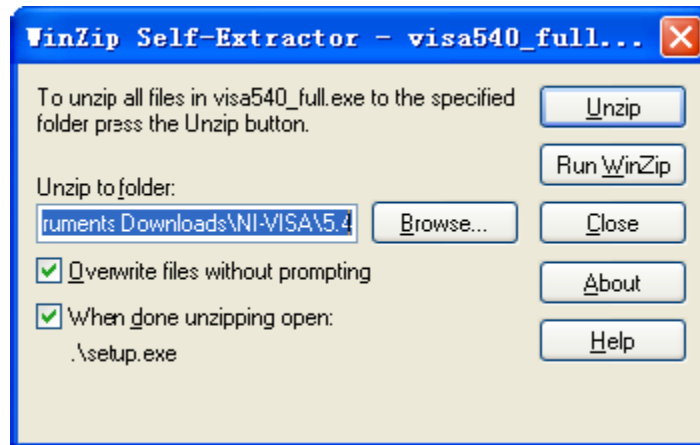

- c. Click Unzip, the install process will launch after unzipping files. If your computer needs to install the .NET Framework 4, it may auto start.



- d. The NI-VISA install dialog is shown above. Click Next to start the installation process.

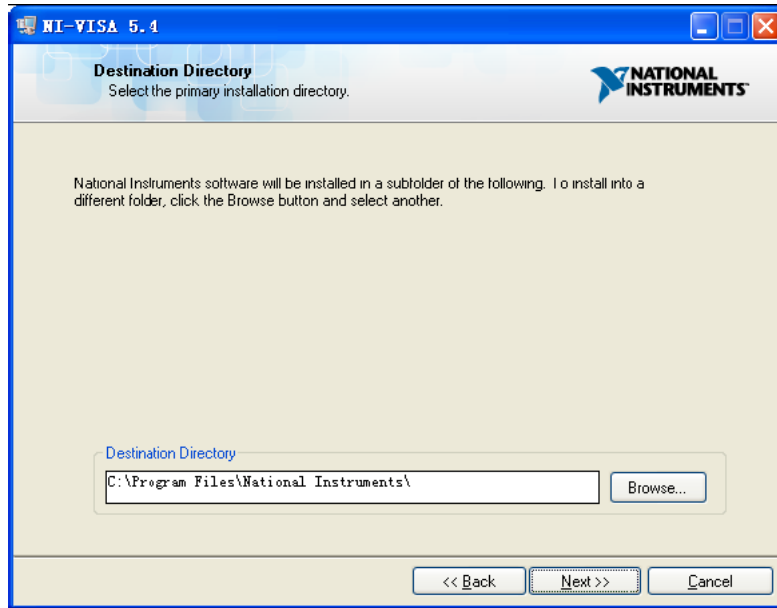

- e. Set the install path, default path is “C:\Program Files\National Instruments\”, you can change it, if you prefer. Click Next, dialog as shown above.

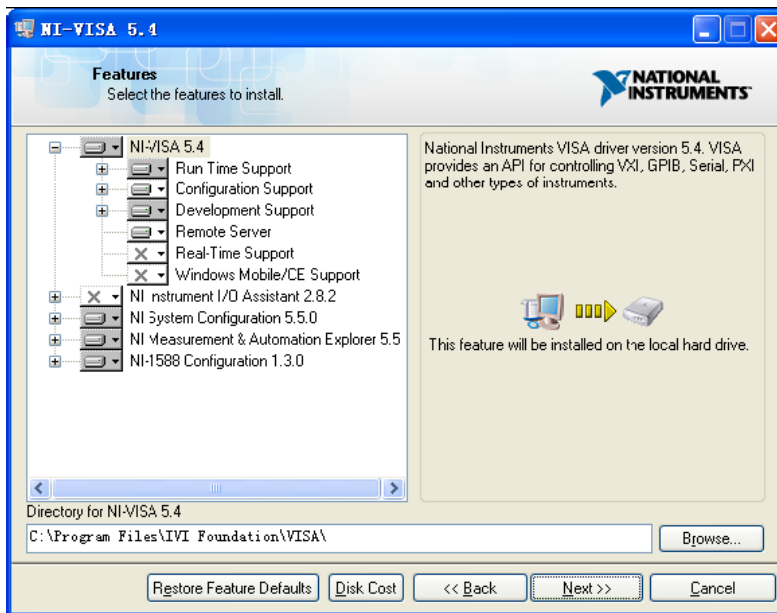

- f. Click Next twice, in the License Agreement dialog, select the “I accept the above 2 License Agreement(s).” and click Next, dialog as shown below:

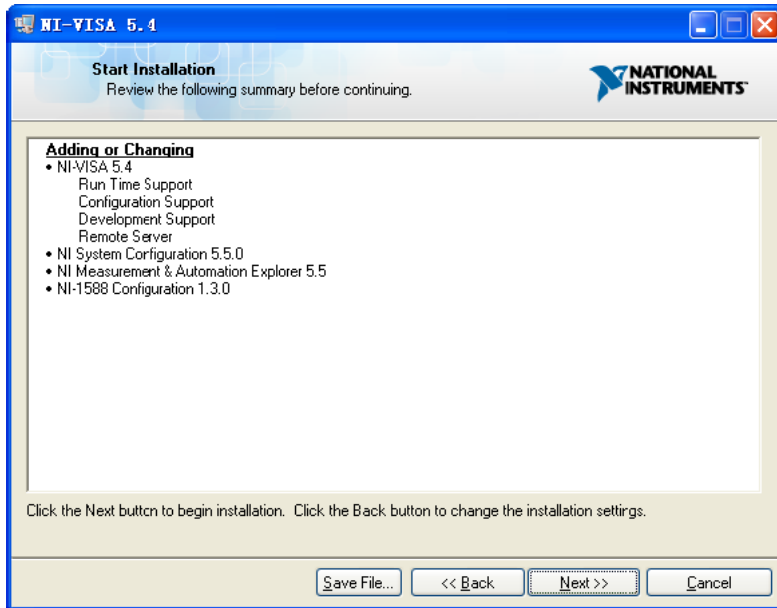

g. Click Next to begin installation.

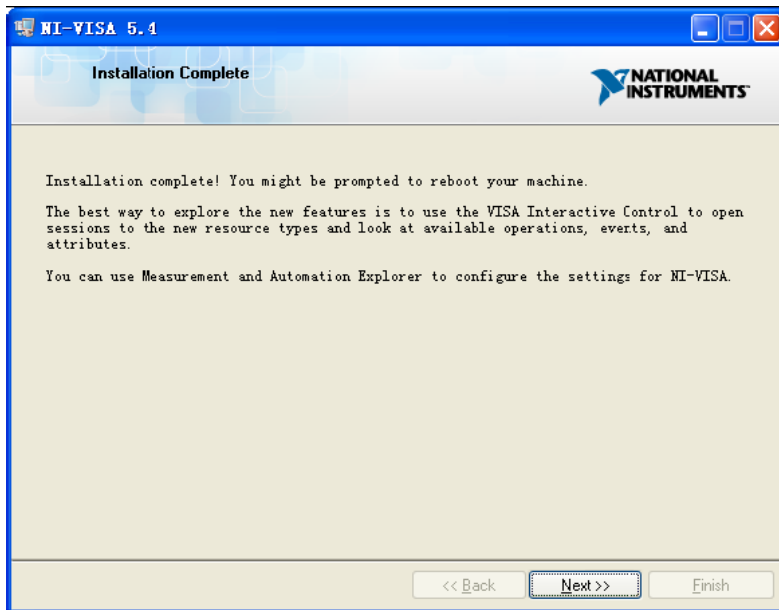

h. Now the installation is complete. Reboot your PC.

## 1.1.2 Connect the instrument

Depending on the specific model, the arbitrary waveform generator may be able to communicate with a PC through the USB or LAN interface.

Connect the arbitrary waveform generator and the USB Host interface of the PC using a USB cable. Assuming your PC is already turned on, turn on the SDG, and then the PC will display the “Device Setup” screen as it automatically installs the device driver as shown below.

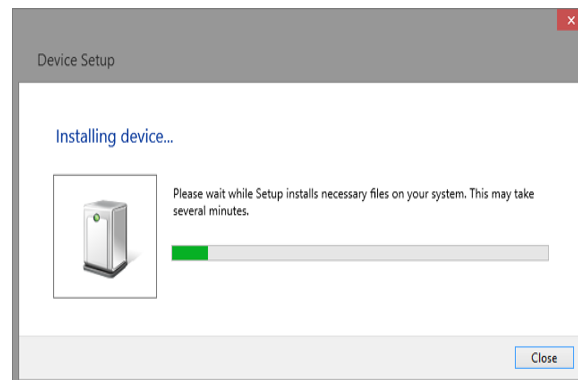

Wait for the installation to complete and then proceed to the next step.



## 1.2 Remote Control

### 1.2.1 User-defined Programming

Users can send SCPI commands via a computer to program and control the arbitrary waveform generator. For details, refer to the introductions in " Programming Examples".

### 1.2.2 Using SCPI via NI-MAX

NI-MAX is a program created and maintained by National Instruments. It provides a basic remote control interface for VXI, LAN, USB, GPIB, and Serial communications. The SDG can be controlled remotely by sending SCPI commands via NI-MAX.

### 1.2.3 Using SCPI over Telnet

Telnet provides a means of communicating with the SDG over the LAN. The Telnet protocol sends SCPI commands to the SDG from a PC and is similar to communicating with the SDG over USB. It sends and receives information interactively: one command at a time. The Windows operating systems use a command prompt style interface for the Telnet client. The steps are as follows:

1. On your PC, click Start > All Programs > Accessories > Command Prompt.
2. At the command prompt, type in *telnet*.
3. Press the Enter key. The Telnet display screen will be displayed.

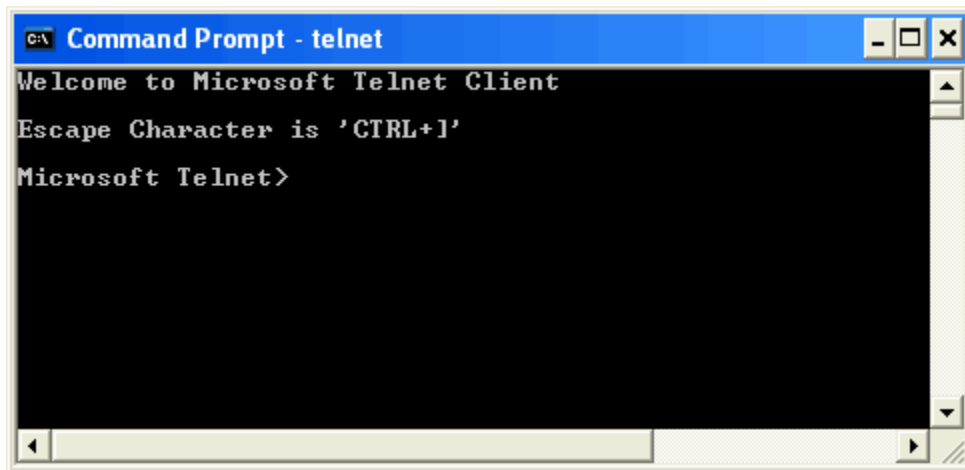

4. At the Telnet command line, type:

```
open XXX.XXX.XXX.XXX 5024
```

Where XXX.XXX.XXX.XXX is the instrument's IP address and 5024 is the port. You should see a response similar to the following:

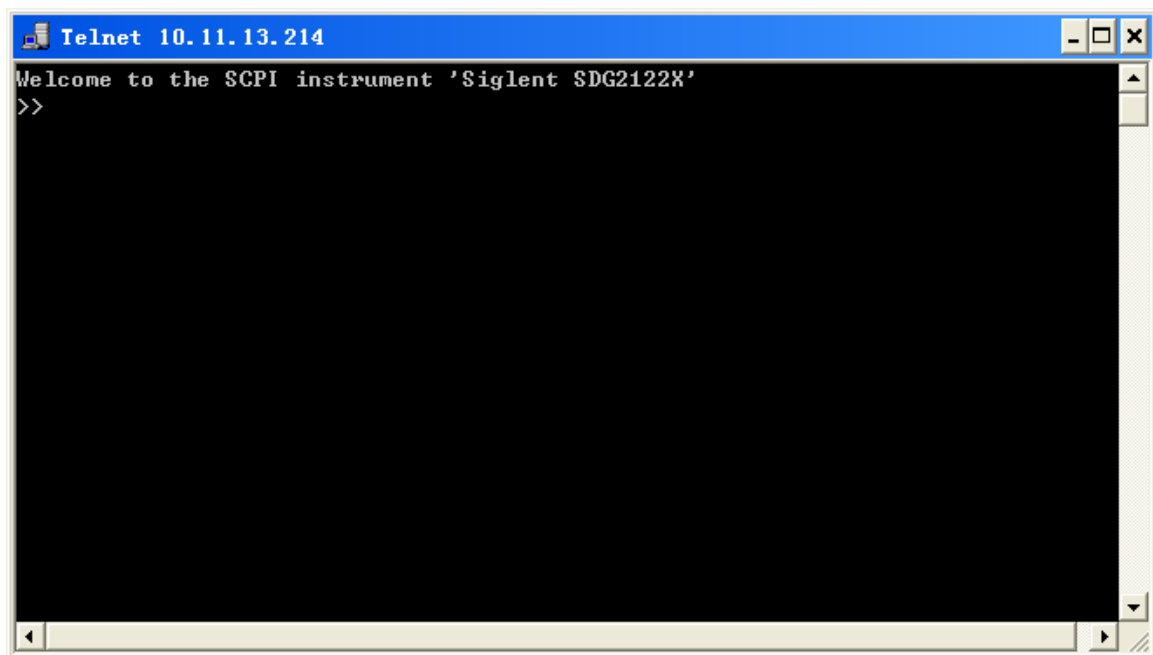

5. At the SCPI> prompt, input the SCPI commands such as `*IDN?` to return the company name, model number, serial number, and firmware version number.

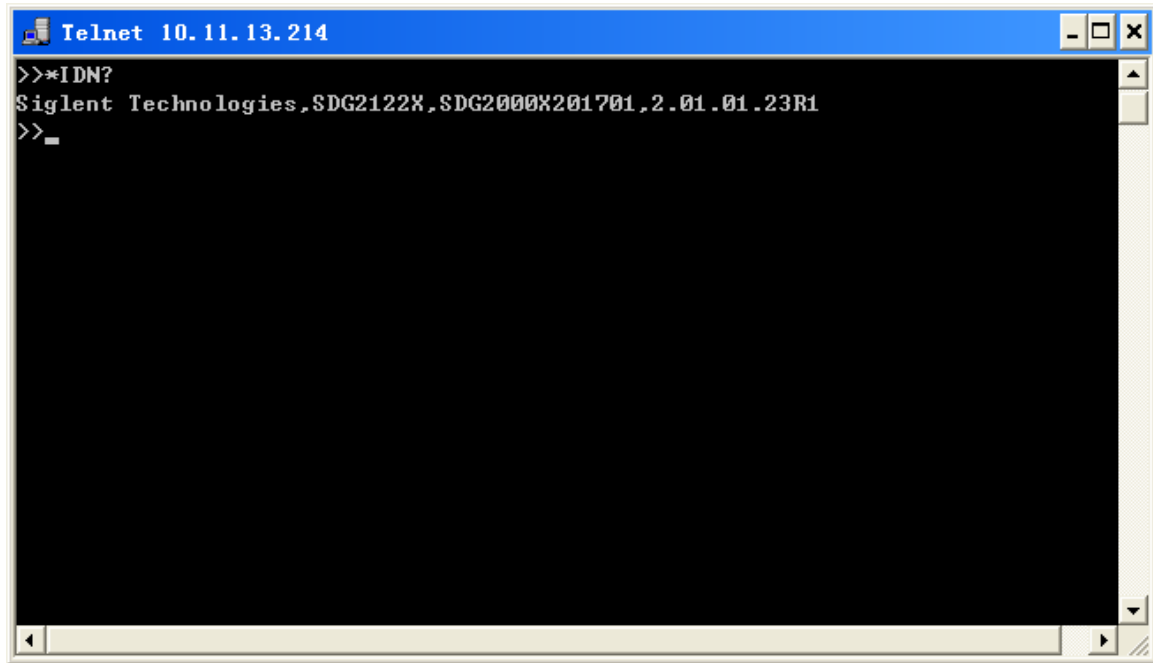

```
Telnet 10.11.13.214
>>*IDN?
Siglent Technologies,SDG2122X,SDG2000X201701,2.01.01.23R1
>>_
```

6. To exit the SCPI> session, press the Ctrl+] keys simultaneously.
7. Type *quit* at the prompt or close the Telnet window to close the connection to the instrument and exit Telnet.

## 1.2.4 Using SCPI over Socket

Socket API can be used to control the SDG series by LAN without installing any other libraries. This can reduce the complexity of programming.

<b>SOCKET ADDRESS</b>	IP address + port number
<b>IP ADDRESS</b>	SDG IP address
<b>PORT NUMBER</b>	5025

Please see section 4.2 "Examples of Using Sockets" for the details.

## 2 Introduction to the SCPI Language

### 2.1 About Commands & Queries

This section lists and describes the remote control commands and queries recognized by the instrument. All commands and queries can be executed in either local or remote state.

Each command or query, with syntax and other information, has some examples listed. The commands are given in both long and short format at “**COMMAND SYNTAX**” and “**QUERY SYNTAX**”, and the subject is indicated as a command or query or both. Queries perform actions such as obtaining information, and are recognized by the question mark (?) following the header.

### 2.2 Description

In the description, a brief explanation of the function performed is given. This is followed by a presentation of the formal syntax, with the header given in Upper-and-Lower-Case characters and the short form derived from it in ALL UPPER-CASE characters. Where applicable, the syntax of the query is given with the format of its response.

### 2.3 Usage

The commands and queries listed here can be used for SDGxxxx Series Arbitrary Waveform Generators.

### 2.4 Command Notation

The following notations are used in the commands:

- < > Angular brackets enclose words that are used as placeholders, of which there are two types: the header path and the data parameter of a command.
- := A colon followed by an equals sign separates a placeholder, from the description of the type and range of values that may be used in a command instead of the placeholder.
- { } Braces enclose a list of choices, one of which must be made.
- [ ] Square brackets enclose optional items.
- ... An ellipsis indicates that the items both to its left and right may be repeated for a

number of times.

## 2.5 Table of Command & Queries

Short	Long Form	Subsystem	What Command/Query does
<a href="#">*IDN</a>	*IDN	SYSTEM	Gets identification from device.
<a href="#">*OPC</a>	*OPC	SYSTEM	Gets or sets the OPC bit (0) in the Event Status Register (ESR).
<a href="#">*RST</a>	*RST	SYSTEM	Initiates a device reset.
<a href="#">CHDR</a>	COMM_HEADER	SIGNAL	Sets or gets the command returned format
<a href="#">OUTP</a>	OUTPUT	SIGNAL	Sets or gets the output state.
<a href="#">BSWV</a>	BASIC_WAVE	SIGNAL	Sets or gets the basic wave parameters.
<a href="#">MDWV</a>	MODULATEWAVE	SIGNAL	Sets or gets the modulation parameters.
<a href="#">SWWV</a>	SWEEPWAVE	SIGNAL	Sets or gets the sweep parameters.
<a href="#">BTWV</a>	BURSTWAVE	SIGNAL	Sets or gets the burst parameters.
<a href="#">PACP</a>	PARACOPY	SIGNAL	Copies parameters from one channel to the other.
<a href="#">ARWV</a>	ARBWAVE	DATA	Changes arbitrary wave type.
<a href="#">SYNC</a>	SYNC	SIGNAL	Sets or gets the synchronization signal.
<a href="#">NBFM</a>	NUMBER_FORM AT	SYSTEM	Sets or gets the data format.
<a href="#">LAGG</a>	LANGUAGE	SYSTEM	Sets or gets the language.
<a href="#">SCFG</a>	SYS_CFG	SYSTEM	Sets or gets the power-on system setting way.
<a href="#">BUZZ</a>	BUZZER	SYSTEM	Sets or gets the buzzer state.
<a href="#">SCSV</a>	SCREEN_SAVE	SYSTEM	Sets or gets the screen save state.
<a href="#">ROSC</a>	ROSCILLATOR	SIGNAL	Sets or gets the state of clock source.
<a href="#">FCNT</a>	FREQCOUNTER	SIGNAL	Sets or gets the frequency counter parameters.
<a href="#">INVT</a>	INVERT	SIGNAL	Sets or gets the polarity of current channel.
<a href="#">COUP</a>	COUPLING	SIGNAL	Sets or gets the coupling parameters.
<a href="#">VOLTPRT</a>	VOLTPRT	SYSTEM	Sets or gets the state of over-voltage protection.
<a href="#">STL</a>	STORELIST	SIGNAL	Lists all stored waveforms.
<a href="#">WVDT</a>	WVDT	SIGNAL	Sets and gets the arbitrary wave data.
<a href="#">VKEY</a>	VIRTUALKEY	SYSTEM	Sets the virtual keys.
<a href="#">SYST:COMM:LAN:IPAD</a>	SYSTEM:COMMUNICATE:LAN:IPADDRESS	SYSTEM	The Command can set and get system IP address.
<a href="#">SYST:COMM</a>	SYSTEM:COMMUNICATE	SYSTEM	The Command can set and get system

Short	Long Form	Subsystem	What Command/Query does
<a href="#">MM:LAN:SMAS</a>	NICATE:LAN:SMASK		subnet mask.
<a href="#">SYST:COMM:LAN:GAT</a>	SYSTEM:COMMUNICATE:LAN:GATEWAY	SYSTEM	The Command can set and get system Gateway.
<a href="#">SRATE</a>	SAMPLERATE	SIGNAL	Sets or gets the arbitrary wave mode, sampling rate and interpolation method.
<a href="#">HARM</a>	HARMonic	SIGNAL	Sets or gets the harmonic information.
<a href="#">CMBN</a>	CoMBiNe	SIGNAL	Sets or gets the wave combine information.
<a href="#">MODE</a>	MODE	SIGNAL	Sets or gets the waveform phase mode
<a href="#">CASCADE</a>	CASCADE	SYSTEM	Set up multi-device synchronization
<a href="#">IQ:CEN</a>	IQ:CENTerfreq	SIGNAL	Sets the I/Q modulator center frequency.
<a href="#">IQ:SAMP</a>	IQ:SAMPlerate	SIGNAL	Sets the I/Q sample rate.
<a href="#">IQ:SYMB</a>	IQ:SYMBOLrate	SIGNAL	Sets the I/Q symbol rate.
<a href="#">IQ:AMPL</a>	IQ:AMPLitude	SIGNAL	Sets the I/Q amplitude.
<a href="#">IQ:IQAD:GAIN</a>	IQ:IQADjustment:GAIN	SIGNAL	Adjusts the ratio of I to Q while preserving the composite.
<a href="#">IQ:IQAD:IOFF</a>	IQ:IQADjustment:IOFFset	SIGNAL	Adjusts the I channel offset value.
<a href="#">IQ:IQAD:QOFF</a>	IQ:IQADjustment:QOFFset	SIGNAL	Adjusts the I channel offset value.
<a href="#">IQ:IQAD:QSK</a>	IQ:IQADjustment:QSKew	SIGNAL	Adjusts the phase angle between the I and Q vectors by increasing or decreasing the Q phase angle.
<a href="#">IQ:TRIG:SOURCE</a>	IQ:TRIGGER:SOURCE	SIGNAL	Sets the I/Q trigger source.
<a href="#">IQ:WAVE:BUILT</a>	IQ:WAVEload:BUILTin	SIGNAL	Selects the I/Q wave from built in wave list.
<a href="#">IQ:WAVE:USER</a>	IQ:WAVEload:USERstored	SIGNAL	Select the I/Q wave from user stored waveforms.
<a href="#">:IQ:FrequencySampling</a>	:IQ:FrequencySampling	SIGNAL	Sets the I/Q Frequency sampling rate.

## 3 Commands and Queries

### 3.1 IEEE 488.2 Common Command Introduction

The IEEE standard defines the common commands used for querying the basic information of the instrument or executing basic operations. These commands usually start with "\*" and the length of the keywords of the command is usually 3 characters.

#### 3.1.1 \*IDN

<b>DESCRIPTION</b>	The *IDN? query causes the instrument to identify itself. The response is comprised of the manufacturer, model, serial number and firmware version.
<b>QUERY SYNTAX</b>	*IDN?
<b>RESPONSE FORMAT</b>	<p>Format 1: *IDN, &lt;device id&gt;,&lt;model&gt;,&lt;serial number&gt;,&lt;firmware version&gt;, &lt;hardware version&gt;</p> <p>Format 2: &lt;manufacturer&gt;,&lt;model&gt;,&lt;serial number&gt;,&lt;firmware version&gt;</p> <p>&lt;device id&gt;:= "SDG".            &lt;manufacturer&gt;:= "Siglent Technologies".            &lt;model&gt;:= A model identifier less than 14 characters, should not contain the word "MODEL".            &lt;serial number&gt;:= The serial number.            &lt;firmware version&gt;:= The firmware version number.            &lt;hardware version&gt;:= The hardware level field, containing information about all separately revisable subsystems.</p>
<b>EXAMPLE</b>	<p>Reads version information:</p> <p><i>*IDN?</i></p> <p>Return:</p> <p><i>Siglent Technologies,SDG6052X, SDG6XBAX1R0034, 6.01.01.28</i> (It may differ from each version)</p>

Notes:

1. The table below shows the available response format of the command in each SDG

series.

Parameter /command	SDG800	SDG1000	SDG2000X	SDG5000	SDG1000X	SDG6000X /X-E
Response Format	Format1	Format1	Format2	Format1	Format2	Format2

- Format of <hardware version>: value1-value2-value3-value4-value5.

value1: PCB version.

value2: Hardware version.

value3: Hardware subversion.

value4: FPGA version.

value5: CPLD version.

### 3.1.2 \*OPC

**DESCRIPTION**

The \*OPC (Operation Complete) command sets the OPC bit (bit 0) in the standard Event Status Register (ESR). This command has no other effect on the operation of the device because the instrument starts parsing a command or query only after it has completely processed the previous command or query. The \*OPC? query always responds with the ASCII character 1 because the device only responds to the query when the previous command has been entirely executed.

**COMMAND SYNTAX**

\*OPC

**QUERY SYNTAX**

\*OPC?

**RESPONSE FORMAT**

Format 1: \*OPC 1

Format 2: 1

Note: The table below shows the available response format of the command in each SDG series.

Parameter /command	SDG800	SDG1000	SDG2000X	SDG5000	SDG1000X	SDG6000X /X-E
Response Format	Format1	Format1	Format2	Format1	Format2	Format2



### 3.1.3 \*RST

<b>DESCRIPTION</b>	The *RST command initiates a device reset and recalls the default setup.
<b>COMMAND SYNTAX</b>	*RST
<b>EXAMPLE</b>	This example resets the signal generator to the default setup: <i>*RST</i>

## 3.2 Comm\_Header Command

<b>DESCRIPTION</b>	This command is used to change the query command returned format. "SHORT" parameter returns short format. "LONG" parameter returns long format. "OFF" returns nothing.
<b>COMMAND SYNTAX</b>	Comm_HeaDeR <parameter> <parameter>:= {SHORT, LONG, OFF}.
<b>QUERY SYNTAX</b>	Comm_HeaDeR?
<b>RESPONSE FORMAT</b>	CHDR <parameter>
<b>EXAMPLE</b>	Set query command format to long: <i>CHDR LONG</i>  Read query command format: <i>CHDR?</i> Return: <i>COMM_HEADER LONG</i>

Note: The table below shows the availability of the command in each SDG series.

Parameter /command	SDG800	SDG1000	SDG2000X	SDG5000	SDG1000X	SDG6000X /X-E
CHDR	yes	yes	no	yes	no	no

### 3.3 Output Command

**DESCRIPTION** This command enables or disables the output port(s) at the front panel. The query returns “ON” or “OFF” and “LOAD”, “PLRT”, “RATIO” parameters.

**COMMAND** <channel>:OUTPut ON|OFF,LOAD,<load>,PLRT, <polarity>

**SYNTAX** <channel>:= {C1, C2}.

<load>:= {see the note below}. The unit is ohm.

<polarity>:= {NOR, INVT}, in which NOR refers to normal, and INVT refers to invert.

NoiseSum: to add noise to the channel with specified signal-to-noise ratio.

<channel>:NOISE\_ADD STATE,ON|OFF,RATIO,<S/N>.

or

<channel>:NOISE\_ADD STATE,ON|OFF,RATIO\_DB,<S/N(dB)>.

<S/N>:= {2.1-100000000}.

<S/N (dB)>:= {3.24886-80}.

Max Amplitude Output: to limit the maximum amplitude output.

<channel>:BSWV MAX\_OUTPUT\_AMP, <Amplitude>

<Amplitude>:= {1-20}, Maximum output amplitude peak-to-peak voltages.

**QUERY** <channel>:OUTPut?

**SYNTAX** <channel>:NOISE\_ADD?

<channel>:BSWV?

**RESPONSE** <channel>:OUTP ON|OFF,LOAD,<load>,PLRT, <polarity>

**FORMAT** <channel>:NOISE\_ADDSTATE,ON|OFF,RATIO,<S/N >,RATIO\_DB,<S/N (dB)>

<channel>:BSWV WVTP,<type>,FRQ,

<frequency>,PERI,<period>,AMP,<amplitude>,AMPVRMS,<Amplitude>,MAX\_OUTPUT\_AMP, OFST, <offset>, HLEV, <high level>, LLEV, <low level>, PHSE, <phase>

**EXAMPLE** Turn on CH1:

*C1:OUTP ON*

Read CH1 output state:

*C1:OUTP?*

Return:

*C1:OUTP ON,LOAD,HZ,PLRT,NOR*

Set the load of CH1 to 50 ohm:

*C1:OUTP LOAD,50*

Set the load of CH1 to HiZ:

*C1:OUTP LOAD,HZ*

Set the polarity of CH1 to normal:

*C1:OUTP PLRT,NOR*

turn on NoiseSum and set the signal-to-noise ratio

*C1:NOISE\_ADD STATE,ON,RATIO,120*

Set the maximum output amplitude

*C1:BSWV MAX\_OUTPUT\_AMP,5*

Note: The table below shows the availability of the command in each SDG series.

Parameter /command	SDG800	SDG1000	SDG2000X	SDG5000	SDG1000X	SDG6000X /X-E
<channel>	no	yes	yes	yes	yes	yes
LOAD	50, HZ	50~10000, HZ	50~100000, HZ	50, HZ	50~100000, HZ	50~100000, HZ

\* "HZ" refers to High Z.

### 3.4 Basic Wave Command

**DESCRIPTION** This command sets or gets the basic wave parameters.

**COMMAND SYNTAX** <channel>:BaSic\_WaVe <parameter>,<value>  
 <channel>:={C1, C2}.  
 <parameter>:= {a parameter from the table below}.  
 <value>:= {value of the corresponding parameter}.

Parameters	Value	Description
WVTP	<type>	:= {SINE, SQUARE, RAMP, PULSE, NOISE, ARB, DC, PRBS, IQ}. If the command doesn't set basic waveform type, WVTP will be set to the current waveform.
FRQ	<frequency>	:= frequency. The unit is Hertz "Hz". Refer to the data sheet for the range of valid values. Not valid when WVTP is NOISE or DC.
PERI	<period>	:= period. The unit is seconds "s". Refer to the data sheet for the range of valid values. Not valid when WVTP is NOISE or DC.
AMP	<amplitude>	:= amplitude. The unit is volts, peak-to-peak "Vpp". Refer to the data sheet for the range of valid values. Not valid when WVTP is NOISE or DC.

OFST	<offset>	:= offset. The unit is volts "V". Refer to the data sheet for the range of valid values. Not valid when WVTP is NOISE.
SYM	<symmetry>	:= {0 to 100}. Symmetry of RAMP. The unit is "%". Only settable when WVTP is RAMP.
DUTY	<duty>	:= {0 to 100}. Duty cycle. The unit is "%". Value depends on frequency. Only settable when WVTP is SQUARE or PULSE.
PHSE	<phase>	:= {0 to 360}. The unit is "degree". Not valid when WVTP is NOISE, PULSE or DC.
STDEV	<stdev>	:= standard deviation of NOISE. The unit is volts "V". Refer to the data sheet for the range of valid values. Only settable when WVTP is NOISE.
MEAN	<mean>	:= mean of NOISE. The unit is volts "V". Refer to the data sheet for the range of valid values. Only settable when WVTP is NOISE.
WIDTH	<width>	:= positive pulse width. The unit is seconds "s". Refer to the data sheet for the range of valid values. Only settable when WVTP is PULSE.
RISE	<rise>	:= rise time (10%~90%). The unit is seconds "s". Refer to the data sheet for the range of valid values. Only settable when WVTP is PULSE.
FALL	<fall>	:= fall time (90%~10%). The unit is seconds "s". Refer to the data sheet for the range of valid values. Only settable when WVTP is PULSE.
DLY	<delay>	:= pulse delay. The unit is seconds "s". Refer to the data sheet for the range of valid values. Only settable when WVTP is PULSE.
HLEV	<high level>	:= high level. The unit is volts "V". Not valid when WVTP is NOISE or DC.
LLEV	<low level>	:= low level. The unit is volts "V". Not valid when WVTP is NOISE or DC.
BANDSTATE	<bandwidth switch >	:= {ON,OFF}. Only settable when WVTP is NOISE.
BANDWIDT H	<bandwidth value>	:= noise bandwidth. The unit is Hertz "Hz". Refer to the data sheet for the range of valid values. Only settable when WVTP is NOISE.
LENGTH	<prbs length>	:= {3~32}. Actual PRBS length = $2^{\text{LENGTH}-1}$ . Only settable when WVTP is PRBS.
EDGE	<prbs rise/fall>	:= rise/fall time of PRBS. The unit is seconds "s". Refer to the data sheet for the range of valid values. Only settable when WVTP is PRBS.
DIFFSTATE	<prbs >	:= {ON, OFF}. State of PRBS differential mode. Only

	differential switch>	settable when WVTP is PRBS.
BITRATE	<prbs rate> bit	:= PRBS bit rate. The unit is bits-per-second "bps". Refer to the data sheet for the range of valid values. Only settable when WVTP is PRBS.
LOGICLEVEL	<prbs logiclevel rate>	:= { TTL_CMOS, LVTTTL_LVCMOS, ECL, LVPECL, LVDS }. Only settable when WVTP is PRBS.
AMPVRMS	<amplitude>	:= amplitude. The unit is V <sub>rms</sub> .
AMPDBM	<amplitude>	:= amplitude. The unit is dBm.

**QUERY SYNTAX**            <channel>: BaSic\_WaVe?  
                                  <channel>:= {C1, C2}.

**RESPONSE FORMAT**      <channel>:BSWV <parameter>  
                                  <parameter>:= {All the parameters of the current basic waveform}.

**EXAMPLE**                    Change the waveform type of C1 to Ramp:  
                                  *C1:BSWV WVTP,RAMP*

Change the frequency of C1 to 2000 Hz:  
*C1:BSWV FRQ,2000*

Set the amplitude of C1 to 3 V<sub>pp</sub>:  
*C1:BSWV AMP,3*

Return parameters of C1 from the device:  
*C1:BSWV?*

Return:  
*C1:BSWV WVTP,SINE,FRQ,100HZ,PERI,0.01S,AMP,2V,OFST,0V,HLEV,1V,LLEV,-1V,PHSE,0*

Set noise bandwidth of C1 to 100 MHz:  
*C1:BSWV BANDWIDTH,100E6*  
 or  
*C1:BSWV BANDWIDTH,100000000*

Set output amplitude of C1 to 3dBm:  
*C1:BSWV AMPDBM,3*

Set the logic level of C1 to TTL\_CMOS:  
*C1:BSWV LOGICLEVEL,TTL\_CMOS*

Notes:

- The table below shows the availability of some command parameters in each SDG series.

Parameter /command	SDG800	SDG1000	SDG2000 X	SDG5000	SDG1000 X	SDG6000 X	SDG6000 X-E
<channel>	no	yes	yes	yes	yes	yes	yes
RISE	yes	no	yes	yes	yes	yes	yes
FALL	yes	no	yes	yes	yes	yes	yes
DLY	no	yes	yes	yes	yes	yes	yes
BANDSTATE	no	no	yes	no	no	yes	yes
BANDWIDTH	no	no	yes	no	no	yes	yes
LENGTH	no	no	no	no	no	yes	no
EDGE	no	no	no	no	no	yes	no
DIFFSTATE	no	no	no	no	no	yes	no
BITRATE	no	no	no	no	no	yes	no
LOGICLEVEL	no	no	no	no	no	yes	no
AMPDBM	no	no	yes	no	yes	yes	yes

- In SDG1000X if Wave Combine is enabled, WVTP cannot be set to SQUARE.

## 3.5 Modulate Wave Command

**DESCRIPTION** This command sets or gets the modulation parameters.

**COMMAND SYNTAX**

```
<channel>:MoDulateWaVe <type>
<channel>:MoDulateWaVe <parameter>,<value>
<channel>:={C1, C2}
```

<type>:= {AM,DSBAM,FM,PM,PWM,ASK,FSK,PSK}.  
 <parameter>:= {a parameter from the table below}.  
 <value>:= {value of the corresponding parameter}.

Parameters	Value	Description
STATE	<state>	:= {ON, OFF}. Enable or disable modulation. STATE must be set to ON before you set or read other parameters of the modulation.
AM, SRC	<src>	:= {INT, EXT}. AM signal source.
AM, MDSP	<mod wave shape>	:= {SINE, SQUARE, TRIANGLE, UPRAMP, DNRAMP, NOISE, ARB}. AM modulation wave. Only settable when SRC is INT.
AM, FRQ	<AM frequency>	:= AM frequency. The unit is Hertz "Hz". Refer to the data sheet for the range of valid values. Only settable when SRC is INT.
AM, DEPTH	<depth>	:= {0 to 120}. AM depth. The unit is "%". Only settable when SRC is INT.
DSBAM, SRC	<src>	:= {INT, EXT}. DSBAM signal source.
DSBAM, MDSP	<mod wave shape>	:= {SINE, SQUARE, TRIANGLE, UPRAMP, DNRAMP, NOISE, ARB}. DSB AM modulation wave. Only settable when SRC is INT.
DSBAM, FRQ	<DSB-AM frequency>	:= DSB AM frequency. The unit is Hertz "Hz". Refer to the data sheet for the range of valid values. Only settable when SRC is INT.
FM, SRC	<src>	:= {INT, EXT}. FM signal source.
FM, MDSP	<mod wave shape>	:= {SINE, SQUARE, TRIANGLE, UPRAMP, DNRAMP, NOISE, ARB}. FM modulation wave. Only settable when SRC is INT.
FM, FRQ	<FM frequency>	:= FM frequency. The unit is Hertz "Hz". Refer to the data sheet for the range of valid values. Only settable when SRC is INT.
FM, DEVI	<FM frequency deviation >	:= {0 to carrier frequency}. FM frequency deviation. The value depends on the difference between the carrier frequency and the bandwidth frequency. Only settable when signal source is INT.
PM, SRC,	<src>	:= {INT, EXT}. PM signal source.
PM, MDSP	<mod wave shape>	:= {SINE, SQUARE, TRIANGLE, UPRAMP, DNRAMP, NOISE, ARB}. PM modulation wave. Only settable when SRC is INT.
PM, FRQ	<PM frequency>	:= PM frequency. The unit is Hertz "Hz". Refer to the data sheet for the range of valid values. Only settable when SRC is INT.

PM, DEVI	<PM phase offset>	:= {0 to 360}. PM phase deviation. The unit is "degree". Only settable when SRC is INT.
PWM, SRC	<src>	:= {INT, EXT}. PWM signal source.
PWM, FRQ	<PWM frequency>	:= PWM frequency. The unit is Hertz "Hz". Refer to the data sheet for the range of valid values. Only settable when SRC is INT.
PWM, DEVI	<PWM dev>	:= Duty cycle deviation. The unit is "%". Value depends on the carrier duty cycle.
PWM, MDSP	<mod wave shape>	:= {SINE, SQUARE, TRIANGLE, UPRAMP, DNRAMP, NOISE, ARB}. PWM modulation wave. Only settable when SRC is INT.
ASK, SRC	<src>	:= {INT, EXT}. ASK signal source.
ASK, KFRQ	< key frequency>	:= ASK key frequency. The unit is Hertz "Hz". Refer to the data sheet for the range of valid values. Only settable when SRC is INT.
FSK, SRC	<src>	:= {INT, EXT}. FSK signal source.
FSK, KFRQ	< key frequency>	:= FSK key frequency. The unit is Hertz "Hz". Refer to the data sheet for the range of valid values. Only settable when SRC is INT.
FSK, HFRQ	<FSK_hop_freq>	:= FSK hop frequency. The same with basic wave frequency. The unit is Hertz "Hz". Refer to the data sheet for the range of valid values.
PSK, SRC	<src>	:= {INT, EXT}. PSK signal source.
PSK, KFRQ	< key frequency>	:= PSK key frequency. The unit is Hertz "Hz". Refer to the data sheet for the range of valid values. Only settable when SRC is INT.
CARR, WVTP	<wave type>	:= {SINE, SQUARE, RAMP, ARB, PULSE}. Carrier waveform type.
CARR, FRQ	<frequency>	:= carrier frequency. The unit is Hertz "Hz". Refer to the data sheet for the range of valid values.
CARR, PHSE	<phase>	:= {0 to 360}. Carrier phase. The unit is "degree".
CARR, AMP	<amplitude>	:= carrier amplitude. The unit is volts, peak-to-peak "Vpp". Refer to the data sheet for the range of valid values.
CARR, OFST	<offset>	:= carrier offset. The unit is volts "V". Refer to the data sheet for the range of valid values.
CARR, SYM	<symmetry>	:= {0 to 100}. Carrier symmetry when the carrier is RAMP. The unit is "%".
CARR, DUTY	<duty>	:= {0 to 100}. Carrier duty cycle when the carrier is SQUARE or PULSE. The unit is "%".



CARR, RISE	<rise>	:= rise time when the carrier is PULSE. The unit is seconds "s". Refer to the data sheet for the range of valid values.
CARR, FALL	<fall>	:= fall time when the carrier is PULSE. The unit is seconds "s". Refer to the data sheet for the range of valid values.
CARR, DLY	<delay>	:= pulse delay when the carrier is PULSE. The unit is seconds "s". Refer to the data sheet for the range of valid values.

Notes:

1. Modulation is not available if the carrier wave is Noise.
2. Range of some parameters depends on the model. Refer to the data sheet for details.

**QUERY SYNTAX**

<channel>:MoDulateWaVe?  
 <channel>:={C1, C2}.

**RESPONSE FORMAT**

<channel>:MDWV <parameter>  
 <parameter>:= {all parameters of the current modulation}.

**EXAMPLE**

Set CH1 modulation state to on:  
*C1:MDWV STATE,ON*

Set CH1 modulation type to AM:  
*C1:MDWV AM*

Set modulation to AM, and the modulating wave type to sine wave:  
*C1:MDWV AM,MDSP,SINE*

Read CH1 modulation parameters when STATE is ON:  
*C1:MDWV?*  
 Return:  
*C1:MDWV AM,STATE,ON,MDSP,SINE,SRC,INT,FRQ,100HZ,DEPTH,100,CARR,WVTP,RAMP,FRQ,1000HZ,AMP,4V,AMPVRMS,1.15473Vrms,OFST,0V,PHSE,0,SYM,50*

Read CH1 modulate wave parameters when STATE is OFF:  
*C1:MDWV?*  
 Return:  
*C1:MDWV STATE,OFF*

Set CH1 FM frequency to 1000 Hz:  
*C1:MDWV FM,FRQ,1000*

Set CH1 carrier to SINE:  
*C1:MDWV CARR,WVTP,SINE*

Set CH1 carrier frequency to 1000 Hz:  
*C1:MDWV CARR,FRQ,1000*

Note: The table below shows the availability of some command parameters in each SDG series.

Parameter /command	SDG800	SDG1000	SDG2000X	SDG5000	SDG1000X	SDG6000X /X-E
<channel>	no	yes	yes	yes	yes	yes
<type>, SRC	no	yes	yes	yes	yes	yes
CARR, DLY	no	yes	yes	yes	yes	yes
CARR, RISE	yes	no	yes	yes	yes	yes
CARR, FALL	yes	no	yes	yes	yes	yes

<type>:= {AM, FM, PM, FSK, ASK, PSK, DSBAM, PWM}.

### 3.6 Sweep Wave Command

**DESCRIPTION** This command sets or gets the sweep parameters.

**COMMAND SYNTAX** <channel>:SweepWaVe <parameter>,<value>  
 <channel>:={C1, C2}  
 <parameter>:= {a parameter from the table below}  
 <value>:= {value of the corresponding parameter}

Parameters	Value	Description
STATE	<state>	:= {ON, OFF}. Enable or disable sweep. STATE must be set to ON before you set or read other parameters of the sweep.
TIME	<time>	:= sweep time. The unit is seconds "s". Refer to the data sheet for the range of valid values.
START	<start_freq>	:= start frequency. The same with basic wave frequency. The unit is Hertz "Hz".
STOP	<stop_freq>	:= stop frequency. The same with basic wave frequency. The unit is Hertz "Hz".
SWMD	<sweep_mode>	:= {LINE, LOG}, in which LINE refers to Linear and

		LOG refers to Logarithmic.
DIR	<direction>	:= {UP, DOWN}. Sweep direction.
TRSR	<trig_src>	:= {EXT, INT, MAN}. Trigger source. EXT refers to External, INT refers to Internal and MAN refers to Manual.
MTRIG		:= send a manual trigger. Only valid when TRSR is MAN.
TRMD	<trig_mode>	:= {ON, OFF}. State of trigger output. If TRSR is EXT, the parameter is invalid.
EDGE	<edge>	:= {RISE, FALL}. Available trigger edge. Only valid when TRSR is EXT or MAN.
CARR, WVTP	<wave type>	:= {SINE, SQUARE, RAMP, ARB}. Carrier waveform type. Modulation is not available if the carrier is PULSE, NOISE or DC.
CARR, FRQ	<frequency>	:= carrier frequency. The unit is Hertz "Hz". Refer to the data sheet for the range of valid values.
CARR, PHSE	<phase>	:= {0 to 360}. Carrier phase. The unit is "degree".
CARR, AMP	<amplitude>	:= carrier amplitude. The unit is volts, peak-to-peak "Vpp". Refer to the data sheet for the range of valid values.
CARR, OFST	<offset>	:= carrier offset. The unit is volts "V". Refer to the data sheet for the range of valid values.
CARR, SYM	<symmetry>	:= {0 to 100}. Carrier symmetry when the carrier is RAMP. The unit is "%".
CARR, DUTY	<duty>	:= {0 to 100}. Carrier duty cycle when the carrier is SQUARE. The unit is "%".
MARK_STATE	<state>	:= {ON, OFF}.
MARK_FREQ	<frequency>	:= mark frequency. The unit is Hertz "Hz". The range is from the start frequency to the stop frequency.

**QUERY SYNTAX**            <channel>:SWEEPWaVe?  
                                  <channel>:= {C1, C2}.

**RESPONSE FORMAT**      <channel>:SWVV <parameter>  
                                  <parameter>:= {All parameters of the current sweep wave}

**EXAMPLE**                    Set CH1 sweep state to ON:  
                                  *C1:SWVV STATE,ON*

                                 Set CH1 sweep time to 1 s:  
                                  *C1:SWVV TIME,1*

Set CH1 stop frequency to 1000 Hz:

*C1:SWWV STOP,1000*

Set trigger source of CH1 to Manual:

*C1:SWWV TRSR,MAN*

Send a manual trigger to CH1:

*C1:SWWV MTRIG*

Read CH2 sweep parameters when STATE is ON:

*C2:SWWV?*

Return:

*C2:SWWV STATE,ON,TIME,1S,STOP,100HZ,START,100HZ,TRSR,MAN,TRMD,OFF,SWMD,LINE,DIR,UP,CARR,WVTP,SQUARE,FRQ,1000HZ,AMP,4V,OFST,0V,DUTY,50,PHSE,0*

Read CH2 sweep parameters when STATE is OFF:

*C2:SWWV?*

Return:

*C2:SWWV STATE,OFF*

Set CH1 the FreqMarker of sweep to 1kHz

*C1:SWWV MARK\_STATE,ON,MARK\_FREQ,1000*

Note: The table below shows the availability of some command parameters in each SDG series.

Parameter /command	SDG800	SDG1000	SDG2000X	SDG5000	SDG1000X	SDG6000X /X-E
<channel>	no	yes	yes	yes	yes	yes
TRMD	no	yes	yes	yes	yes	yes
EDGE	no	yes	yes	yes	yes	yes

### 3.7 Burst Wave Command

**DESCRIPTION**

This command sets or gets the burst wave parameters.

**COMMAND SYNTAX**

<channel>:BursTWaVe <parameter>,<value>

<channel>:= {C1, C2}.

<parameter>:= {a parameter from the table below}.

<value>:= {value of the corresponding parameter}.

Parameters	Value	Description
STATE	<state>	:= {ON, OFF}. Enable or disable burst. STATE must be set to ON before you set or read other

		parameters of the burst.
PRD	<period>	:= burst period. Refer to the data sheet for the range of valid values. The unit is seconds "s". Not valid when: <ul style="list-style-type: none"> <li>Carrier is NOISE</li> <li>GATE_NCYC is GATE (except "X" series)</li> <li>TRSR is EXT</li> </ul>
STPS	<start_phase>	:= {0 to 360}. Start phase of the carrier. The unit is "degree". Not valid when the carrier is NOISE or PULSE.
GATE_NCYC	<burst_mode>	:= {GATE, NCYC}. Burst mode. Not valid when the carrier is NOISE.
TRSR	<trig_src>	:= {EXT, INT, MAN}. Trigger source. EXT refers to External, INT refers to Internal and MAN refers to Manual.
MTRIG		:= send a manual trigger. Only when TRSR is MAN, the parameter is valid.
DLAY	<delay>	:= trigger delay. The unit is seconds "s". Refer to the data sheet for the range of valid values. Available when GATE_NCYC is NCYC. Not valid when the carrier is NOISE.
PLRT	<polarity>	:= {NEG, POS}. Gate polarity. Negative or Positive.
TRMD	<trig_mode>	:= {RISE, FALL, OFF}. Trigger out mode. Available when GATE_NCYC is NCYC and TRSR is INT or MAN. Not valid when the carrier is NOISE.
EDGE	<edge>	:= {RISE, FALL}. Available trigger edge. Only valid when TRSR is EXT or MAN.
EDGE	<edge>	:= { RISE, FALL}. Available trigger edge. Available when GATE_NCYC is NCYC and TRSR is EXT. Not valid when the carrier is NOISE.
TIME	<circle_time>	:= {INF, 1, 2,..., M}, where M is the maximum supported Ncycle number which depends on the model; INF sets the burst to Infinite mode. Available when GATE_NCYC is NCYC. Not valid when the carrier is NOISE.
CARR, WVTP	<wave type>	:= {SINE, SQUARE, RAMP, ARB, PULSE, NOISE}. Carrier waveform type.
CARR, FRQ	<frequency>	:= carrier frequency. The unit is Hertz "Hz". Refer to the data sheet for the range of valid values.
CARR, PHSE	<phase>	:= {0 to 360}. Carrier phase. The unit is "degree".
CARR, AMP	<amplitude>	:= carrier amplitude. The unit is volts, peak-to-peak "Vpp". Refer to the data sheet for the range of valid

		values.
CARR, OFST	<offset>	:= carrier offset. The unit is volts "V". Refer to the data sheet for the range of valid values.
CARR, SYM	<symmetry>	:= {0 to 100}. Carrier symmetry when the carrier is RAMP. The unit is "%".
CARR, DUTY	<duty>	:= {0 to 100}. Carrier duty cycle when the carrier is SQUARE or PULSE. The unit is "%".
CARR, RISE	<rise>	:= rise time when the carrier is PULSE. The unit is seconds "s". Refer to the data sheet for the range of valid values.
CARR, FALL	<fall>	:= fall time when the carrier is PULSE. The unit is seconds "s". Refer to the data sheet for the range of valid values.
CARR, DLY	<delay>	:= pulse delay when the carrier is PULSE. The unit is seconds "s". Refer to the data sheet for the range of valid values.
CARR, STDEV	<stdev>	:= standard deviation of NOISE. The unit is volts "V". Refer to the data sheet for the range of valid values.
CARR, MEAN	<mean>	:= mean of NOISE. The unit is volts "V". Refer to the data sheet for the range of valid values.

**QUERY SYNTAX**            <channel>:BTWV(BurstTWaVe)?  
                                  <channel>:={C1, C2}

**RESPONSE FORMAT**      <channel>:BTWV <parameter>  
                                  <parameter>:={All parameters of the current burst wave.}

**EXAMPLE**                    Set CH1 burst state to ON  
                                  *C1:BTWV STATE,ON*

Set CH1 burst period to 1 s.  
*C1:BTWV PRD,1*

Set CH1 burst delay to 1 s  
*C1:BTWV DLAY,1*

Set CH1 burst to infinite  
*C1:BTWV TIME,INF*

Read CH2 burst parameters when the STATE is ON.  
*C2:BTWV?*

Return:  
*C2:BTWV STATE,ON,PRD,0.01S,STPS,0,TRSR,INT,*

*TRMD,OFF,TIME,1,DLAY,2.4e-07S,GATE\_NCYC,NCYC,  
CARR,WVTP,SINE,FRQ,1000HZ,AMP,4V,OFST,0V,PHSE,0*

Read CH2 burst parameters when the STATE is OFF.

*C2:BTWV?*

Return:

*C2:BTWV STATE,OFF*

Note: The table below shows the availability of some command parameters in each SDG series.

Parameter /command	SDG800	SDG1000	SDG2000X	SDG5000	SDG1000X	SDG6000X /X-E
<channel>	no	yes	yes	yes	yes	yes
TRMD	no	yes	yes	yes	yes	yes
EDGE	no	yes	yes	yes	yes	yes
CARR, DLY	yes	yes	yes	yes	yes	yes
CARR, RISE	yes	no	yes	yes	yes	yes
CARR, FALL	yes	no	yes	yes	yes	yes

### 3.8 Parameter Copy Command

**DESCRIPTION** This command copies parameters from one channel to another.

**COMMAND SYNTAX** ParaCoPy <destination\_channel>,<src\_channel>  
 < destination\_channel>:= {C1, C2}.  
 <src\_channel>:= {C1, C2}.  
 Note: the parameters C1 and C2 must be set to the device together.

**EXAMPLE** Copy parameters from CH1 to CH2.  
*PACP C2,C1*

Note: The table below shows the availability of the command in each SDG series.

Parameter /command	SDG800	SDG1000	SDG2000X	SDG5000	SDG1000X	SDG6000X /X-E
PACP	no	yes	yes	yes	yes	yes

### 3.9 Arbitrary Wave Command

**DESCRIPTION** This command sets and gets the arbitrary waveform type.  
 Note: The index number in the command syntax and the response

format of query omit the character 'M', and directly uses the value to represent the index number.

**COMMAND SYNTAX**

<channel>:ArbWaVe INDEX,<index>  
 <channel>:ArbWaVe NAME,<name>  
 <channel>:= {C1, C2}.

<index>: the index of the arbitrary waveform from the table below.

<name>: the name of the arbitrary waveform from the table below.

**.QUERY SYNTAX**

<channel>:ARbWaVe?  
 <channel>:= {C1, C2}.

**RESPONSE FORMAT**

<channel>:ARWV INDEX,<index>,NAME,<name>

**EXAMPLE**

Set CH1 current waveform by index 2:

*C1:ARWV INDEX,2*

Read CH1 current waveform:

*C1:ARWV?*

Return:

*C1:ARWV INDEX,2,NAME,StairUp*

Set CH1 current waveform to wave\_1 by name.

*C1:ARWV NAME,wave\_1*

**RELATED COMMANDS**

[STL](#)

Index	Name	Index	Name	Index	Name	Index	Name
0	Sine	12	Logfall	24	Gmonopuls	36	Triang
1	Noise	13	Logrise	25	Tripuls	37	Harris
2	StairUp	14	Sqrt	26	Cardiac	38	Bartlett
3	StairDn	15	Root3	27	Quake	39	Tan
4	Stairud	16	X^2	28	Chirp	40	Cot
5	Ppulse	17	X^3	29	Twotone	41	Sec
6	Npulse	18	Sinc	30	Snr	42	Csc
7	Trapezia	19	Gaussian	31	Hamming	43	Asin
8	Upramp	20	Dlorentz	32	Hanning	44	Acos
9	Dnramp	21	Haversine	33	Kaiser	45	Atan
10	Exp_fall	22	Lorentz	34	Blackman	46	Acot
11	Exp_rise	23	Gauspuls	35	Gausswin	47	Square

Note: This table is just an example, the index depends on the specific model. The “STL?” command can be used to get the accurate mapping relationship between the index and name.



Note: The table below shows the availability of some command parameters in each SDG series.

Parameter /command	SDG800	SDG1000	SDG2000X	SDG5000	SDG1000X	SDG6000X /X-E
<channel>	no	yes	yes	yes	yes	yes
INDEX	yes	yes	yes(only built-in wave)	yes	yes(only built-in wave)	yes(only built-in wave)
NAME	yes	yes	yes(only user defined wave)	yes	yes(only user defined wave)	yes(only user defined wave)

### 3.10 Sync Command

**DESCRIPTION** This command sets the synchronization signal.

**COMMAND SYNTAX** <channel>:SYNC <state>  
 <channel>:= {C1, C2}.  
 <state>:= {ON, OFF}.  
 SYNC TYPE, <TYPE>  
 <TYPE>:= {CH1, CH2, MOD\_CH1, MOD\_CH2}.

**QUERY SYNTAX** <channel>:SYNC?  
 <channel>:= {C1, C2}.

**RESPONSE FORMAT** <channel>:SYNC <state>

**EXAMPLE** Turn on sync output and set the source as modulating signal of CH1:

*C1:SYNC ON,TYPE,MOD\_CH1*

Read state of CH1 sync.

*C1:SYNC?*

Return:

*C1:SYNC ON,TYPE,MOD\_CH1*

Note: The table below shows the availability of the command in each SDG series.

Parameter /command	SDG800	SDG1000	SDG2000X	SDG5000	SDG1000X	SDG6000X /X-E
SYNC	no	yes	yes	yes	yes	yes

## 3.11 Number Format Command

<b>DESCRIPTION</b>	This command sets or gets the number format.
<b>COMMAND SYNTAX</b>	NumBer_ForMat PNT,<pnt>, NumBer_ForMa SEPT,<sept> <pnt>:= {Dot, Comma}. The point format. <sept>:= {Space, Off, On}. The separator format.
<b>QUERY SYNTAX</b>	NBFM?
<b>RESPONSE FORMAT</b>	NBFM PNT,<pnt>, SEPT,<sept>
<b>EXAMPLE</b>	Set point format to DOT: <i>NBFM PNT, DOT</i>  Set separator format to ON: <i>NBFM SEPT, ON</i>  Read the number format: <i>NBFM?</i> Return: <i>NBFM PNT, DOT, SEPT, ON</i>

## 3.12 Language Command

<b>DESCRIPTION</b>	This command sets or gets the system language.
<b>COMMAND SYNTAX</b>	LAnGuaGe <language> <language>:= {EN,CH,RU}, where EN is English, CH is Chinese Simplified, and RU is Russian.
<b>QUERY SYNTAX</b>	LAnGuaGe?
<b>RESPONSE FORMAT</b>	LAGG <language>
<b>EXAMPLE</b>	Set language to English: <i>LAGG EN</i>  Read language <i>LAGG?</i>

Return:  
*LAGG EN*

Note: The table below shows the availability of some command parameters in each SDG series.

Parameter /command	SDG800	SDG1000	SDG2000X	SDG5000	SDG1000X	SDG6000X /X-E
RU	no	yes	no	no	no	no

### 3.13 Configuration Command

<b>DESCRIPTION</b>	This command sets or gets the the power-on system setting.
<b>COMMAND SYNTAX</b>	<p>Sys_CFG &lt;mode&gt;                      &lt;mode&gt;:= {DEFAULT, LAST}</p>
<b>QUERY SYNTAX</b>	<p>Sys_CFG?</p>
<b>RESPONSE FORMAT</b>	<p>SCFG &lt;mode&gt;</p>
<b>EXAMPLE</b>	<p>Set the power-on system setting to LAST:  <i>SCFG LAST</i></p>

### 3.14 Buzzer Command

<b>DESCRIPTION</b>	This command turns on or off the buzzer.
<b>COMMAND SYNTAX</b>	<p>BUZZer &lt;state&gt;                      &lt;state&gt;:= {ON, OFF}.</p>
<b>QUERY SYNTAX</b>	<p>BUZZer?</p>
<b>RESPONSE FORMAT</b>	<p>BUZZ &lt;state&gt;</p>
<b>EXAMPLE</b>	<p>Turn on the buzzer:  <i>BUZZ ON</i></p>

## 3.15 Screen Save Command

<b>DESCRIPTION</b>	This commands turns off or sets screen save time (the unit is minutes).
<b>COMMAND SYNTAX</b>	SCreen_SaVe <parameter> <parameter>:= {OFF, 1, 5, 15, 30, 60, 120, 300}.
<b>QUERY SYNTAX</b>	SCreen_SaVe?
<b>RESPONSE FORMAT</b>	SCSV <parameter>
<b>EXAMPLE</b>	<p>Set screen save time to 5 minutes: <i>SCSV 5</i></p> <p>Read the current screen save time: <i>SCreen_SaVe?</i> Return: <i>SCSV 5MIN</i></p>

## 3.16 Clock Source Command

<b>DESCRIPTION</b>	This command sets or gets the clock source.
<b>COMMAND SYNTAX</b>	ROSCillator <src> <src>:= {INT, EXT}  ROSC 10MOUT,ON OFF
<b>QUERY SYNTAX</b>	ROSC?
<b>RESPONSE FORMAT</b>	ROSC <src>,10MOUT,ON OFF
<b>EXAMPLE</b>	<p>Set internal time base as the source: <i>ROSC INT</i></p> <p>Enable 10MHz output: <i>ROSC 10MOUT,ON</i></p>

Note: The table below shows the availability of the command in each SDG series.

Parameter	SDG800	SDG1000	SDG2000X	SDG5000	SDG1000X	SDG6000X
-----------	--------	---------	----------	---------	----------	----------

/command						/X-E
ROSC	no	yes	yes	yes	yes	yes

## 3.17 Frequency Counter Command

**DESCRIPTION** This command sets or gets the frequency counter parameters.

**COMMAND SYNTAX** FreqCouNter <parameter>,<value>  
 <parameter>:= {a parameter from the table below}.  
 <value>:= {value of the corresponding parameter}.

Parameters	Value	Description
STATE	<state>	:= {ON, OFF} State of frequency counter.
FRQ	<frequency>	Measured frequency. The unit is Hertz "Hz". Can't be set.
PW	<pos_width>	Measured positive width. The unit is seconds "s". Can't be set.
NW	<neg_width>	Measured negative width. The unit is seconds "s". Can't be set.
DUTY	<duty>	Measured duty cycle. The unit is "%". Can't be set.
FRQDEV	<freq_dev>	Measured frequency deviation. The unit is "ppm". Can't be set.
REFQ	<ref_freq>	Expected frequency, for calculating the frequency deviation. The unit is Hertz "Hz".
TRG	<triglev>	Trigger level. The range of valid values depends on the model. The unit is volts "V".
MODE	<mode>	:= {AC, DC} Coupling mode.
HFR	<HFR>	:= {ON, OFF} State of High Frequency Rejection.

**QUERY SYNTAX** FreqCouNter?

**RESPONSE FORMAT** FCNT <parameter>  
 <parameter>:= {All parameters of the frequency counter}

**EXAMPLE** Turn frequency counter on:  
*FCNT STATE,ON*  
 Set reference freq to 1000 Hz:

*FCNT REFQ,1000*

Query frequency counter information:

*FCNT?*

Return:

*FCNT STATE,ON,FRQ,10000000HZ,DUTY,59.8568,REFQ,1e+07HZ,TRG,0V,PW,5.98568e-08S,NW,4.01432e-08S,FRQDEV,0ppm,MODE,AC,HFR,OFF*

Note: The table below shows the availability of the command in each SDG series.

Parameter /command	SDG800	SDG1000	SDG2000X	SDG5000	SDG1000X	SDG6000X /X-E
FCNT	no	yes	yes	yes	yes	yes

### 3.18 Invert Command

**DESCRIPTION** This command sets or gets the polarity of specified channel.

**COMMAND SYNTAX** <channel>:INVerT <state>  
 <channel>:= {C1, C2}.  
 <state>:= {ON, OFF}.

**QUERY SYNTAX** <channel>:INVerT?  
 <channel>:={C1, C2}.

**RESPONSE FORMAT** <channel>:INVT <state>

**EXAMPLE** Set CH1 polarity to invert  
*C1:INVT ON*

Read the polarity of CH1.  
*C1:INVT?*  
 Return:  
*C1:INVT ON*

Note: The table below shows the availability of some command parameters in each SDG series.

Parameter /command	SDG800	SDG1000	SDG2000X	SDG5000	SDG1000X	SDG6000X /X-E
<channel>	no	yes	yes	yes	yes	yes

## 3.19 Coupling Command

**DESCRIPTION** This command sets or gets the channel coupling parameters. Only when TRACE is set to OFF, the other coupling parameters can be set.

**COMMAND SYNTAX** COUPling <parameter>,<value>  
 <parameter>:= {a parameter from the table below}.  
 <value>:={value of the corresponding parameter}.

Parameters	Value	Description
TRACE	<track_enable>	:= {ON, OFF} State of channel tracking.
STATE	<state>	:= {ON, OFF} State of channel coupling.
BSCH	<bsch>	:= {CH1,CH2} Base channel.
FCOUP	<fcoup>	:= {ON, OFF} State of frequency coupling
FDEV	<frq_dev>	:= frequency deviation between the 2 channels. The unit is Hertz "Hz".
FRAT	<frat>	:= frequency ratio between the 2 channels.
PCOUP	<pcoup>	:= {ON, OFF} State of phase coupling
PDEV	<pha_dev>	:= phase deviation between the 2 channels. The unit is "degree".
PRAT	<prat>	:= phase ratio between the 2 channels.
ACOUP	<acoup>	:= {ON, OFF} State of amplitude coupling
ARAT	<arat>	:= amplitude ratio between the 2 channels.
ADEV	<adev>	:= amplitude deviation between the 2 channels. The unit is volts, peak-to-peak "Vpp".

**QUERY SYNTAX** COUPling?

**RESPONSE FORMAT** COUP <parameter>  
 <parameter>:= { All parameters of coupling}.

### EXAMPLE

Set coupling state to ON:  
*COUP STATE,ON*

Set frequency coupling state to ON:

*COUP FCOUP,ON*

Set frequency deviation to 5 Hz:

*COUP FDEV,5*

Query coupling information.

*COUP?*

Return:

*COUP TRACE,OFF,FCOUP,ON,PCOUP,ON,ACOUP,ON,FDEV,5HZ,PRAT,1,ARAT,2*

Note: The table below shows the availability of the command and some parameters in each SDG series.

Parameter /command	SDG800	SDG1000	SDG2000X	SDG5000	SDG1000X	SDG6000X /X-E
COUP	no	yes	yes	yes	yes	yes
TRACE	no	no	yes	no	yes	yes
STATE	no	yes	no	yes	no	no
BSCH	no	yes	no	yes	no	no
FCOUP	no	no	yes	no	yes	yes
FRAT	no	no	Yes	no	yes	yes
PCOUP	no	no	Yes	no	yes	yes
PRAT	no	no	Yes	no	yes	yes
ACOUP	no	no	Yes	no	yes	yes
ARAT	no	no	Yes	no	yes	yes
ADEV	no	no	yes	no	yes	yes

### 3.20 Over-Voltage Protection Command

**DESCRIPTION** This command sets or gets the state of over-voltage protection.

**COMMAND SYNTAX** VOLTPRT <state>  
<state>:= {ON, OFF}

**QUERY SYNTAX** VOLTPRT?

**RESPONSE FORMAT** VOLTPRT <state>

Note: The table below shows the availability of the command in each SDG series.

Parameter	SDG800	SDG1000	SDG2000X	SDG5000	SDG1000X	SDG6000X
-----------	--------	---------	----------	---------	----------	----------



/command						/X-E
VOLTPRT	no	yes	yes	no	yes	yes

## 3.21 Store List Command

**DESCRIPTION** This command is used to read the stored waveforms list with indexes and names. If the store unit is empty, the command will return “EMPTY” string.

**QUERY SYNTAX** SToreList?  
SToreList? BUILDIN|USER

**EXAMPLE** Read all arbitrary data saved in a SDG1000.

*STL?*

Return:

*STL M0, sine, M1, noise, M2, stairup, M3, stairdn, M4, stairud, M5, ppulse, M6, npulse, M7, trapezia, M8, upramp, M9, dn ramp, M10, exp\_fall, M11, exp\_rise, M12, logfall, M13, logrise, M14, sqrt, M15, root3, M16, x^2, M17, x^3, M18, sinc, M19, gaussian, M20, dlorentz, M21, haversine, M22, lorentz, M23, gauspuls, M24, gmonopuls, M25, tripuls, M26, cardiac, M27, quake, M28, chirp, M29, twotone, M30, snr, M31, EMPTY, M32, EMPTY, M33, EMPTY, M34, hamming, M35, hanning, M36, kaiser, M37, blackman, M38, gaussiwin, M39, triangle, M40, blackmanharris, M41, bartlett, M42, tan, M43, cot, M44, sec, M45, csc, M46, asin, M47, acos, M48, atan, M49, acot, M50, EMPTY, M51, EMPTY, M52, EMPTY, M53, DDROPOUT, M54, FCLK1, M55, FSDA1, M56, EMPTY, M57, EMPTY, M58, EMPTY, M59, EMPTY*

Read built-in wave data from a SDG2000X:

*STL? BUILDIN*

Return:

*STL M10, ExpFal, M100, ECG14, M101, ECG15, M102, LFPulse, M103, Tens1, M104, Tens2, M105, Tens3, M106, Airy, M107, Besselj, M108, Bessely, M109, Dirichlet, M11, ExpRise, M110, Erf, M111, Erfc, M112, ErfcInv, M113, ErfInv, M114, Laguerre, M115, Legend, M116, Versiera, M117, Weibull, M118, LogNormal, M119, Laplace, M12, LogFall, M120, Maxwell, M121, Rayleigh, M122, Cauchy, M123, CosH, M124, CosInt, M125, CotH, M126, Csch, M127, SecH, M128, SinH, M129, SinInt, M13, LogRise, M130, TanH, M131, ACosH, M132, ASecH, M133, ASinH, M134, ATanH, M135,*

ACsch, M136, ACoth, M137, Bartlett, M138, BohmanWin, M139, ChebWin, M14, Sqrt, M140, FlattopWin, M141, ParzenWin, M142, TaylorWin, M143, TukeyWin, M144, SquareDuty01, M145, SquareDuty02, M146, SquareDuty04, M147, SquareDuty06, M148, SquareDuty08, M149, SquareDuty10, M15, Root3, M150, SquareDuty12, M151, SquareDuty14, M152, SquareDuty16, M153, SquareDuty18, M154, SquareDuty20, M155, SquareDuty22, M156, SquareDuty24, M157, SquareDuty26, M158, SquareDuty28, M159, SquareDuty30, M16, X<sup>2</sup>, M160, SquareDuty32, M161, SquareDuty34, M162, SquareDuty36, M163, SquareDuty38, M164, SquareDuty40, M165, SquareDuty42, M166, SquareDuty44, M167, SquareDuty46, M168, SquareDuty48, M169, SquareDuty50, M17, X<sup>3</sup>, M170, SquareDuty52, M171, SquareDuty54, M172, SquareDuty56, M173, SquareDuty58, M174, SquareDuty60, M175, SquareDuty62, M176, SquareDuty64, M177, SquareDuty66, M178, SquareDuty68, M179, SquareDuty70, M18, Sinc, M180, SquareDuty72, M181, SquareDuty74, M182, SquareDuty76, M183, SquareDuty78, M184, SquareDuty80, M185, SquareDuty82, M186, SquareDuty84, M187, SquareDuty86, M188, SquareDuty88, M189, SquareDuty90, M19, Gaussian, M190, SquareDuty92, M191, SquareDuty94, M192, SquareDuty96, M193, SquareDuty98, M194, SquareDuty99, M195, demo1\_375pts, M196, demo1\_16kpts, M197, demo2\_3kpts, M198, demo2\_16kpts, M2, StairUp, M20, Dlorentz, M21, Haversine, M22, Lorentz, M23, Gauspuls, M24, Gmonopuls, M25, Tripuls, M26, Cardiac, M27, Quake, M28, Chirp, M29, Twotone, M3, StairDn, M30, SNR, M31, Hamming, M32, Hanning, M33, kaiser, M34, Blackman, M35, Gausswin, M36, Triangle, M37, Bartlett-Hann, M38, Bartlett, M39, Tan, M4, StairUD, M40, Cot, M41, Sec, M42, Csc, M43, Asin, M44, Acos, M45, Atan, M46, Acot, M47, Square, M48, SineTra, M49, SineVer, M5, Ppulse, M50, AmpALT, M51, AttALT, M52, RoundHalf, M53, RoundsPM, M54, BlaseiWave, M55, DampedOsc, M56, SwingOsc, M57, Discharge, M58, Pahcur, M59, Combin, M6, Npulse, M60, SCR, M61, Butterworth, M62, Chebyshev1, M63, Chebyshev2, M64, TV, M65, Voice, M66, Surge, M67, Radar, M68, Ripple, M69, Gamma, M7, Trapezia, M70, StepResp, M71, BandLimited, M72, CPulse, M73, CWPulse, M74, GateVibr, M75, LFMPulse, M76, MCNoise, M77, AM, M78, FM, M79, PFM, M8, Upramp, M80, PM, M81, PWM, M82, EOG, M83, EEG, M84, EMG, M85, Pulseilogram, M86, ResSpeed, M87, ECG1, M88, ECG2, M89, ECG3, M9,

*Dnramp, M90, ECG4, M91, ECG5, M92, ECG6, M93, ECG7, M94, ECG8, M95, ECG9, M96, ECG10, M97, ECG11, M98, ECG12, M99, ECG13*

Read wave data defined by user from a SDG1000X:

*STL? USER*

Return:

*STL WVNM,sinc\_8M,sinc\_3000000,sinc\_1664000, ramp\_8M,sinc\_2000000,sinc\_50000,square\_8M,sinc\_5000, wave1,square\_1M*

Note: The table below shows the availability of some command parameters in each SDG series.

Parameter /command	SDG800	SDG1000	SDG2000X	SDG5000	SDG1000X	SDG6000X /X-E
STL? return	BUILDIN USER	BUILDIN USER	BUILDIN	BUILDIN USER	BUILDIN	BUILDIN
BUILDIN	no	no	yes	no	yes	yes
USER	no	no	yes	no	yes	yes

## 3.22 Arb Data Command

### DESCRIPTION

This command sets and gets the arbitrary waveform data.

### COMMAND SYNTAX

<channel>:WVDT <index>,<parameter>,<value>

<channel>:= {C1, C2}.

<index>:= {Mn}. The waveform index. See note 2 below for the details.

<parameter>:= {a parameter from the table below}.

<value>:= {value of the corresponding parameter}.

Parameters	Value	Description
WVNM	<wave_name>	:= waveform name.
TYPE	<type>	:= {0 to 5} 0 - common 1 - math 2 - engineering 3 - window 4 - triangle function 5 - user defined This parameter is not valid for the "X" series.

LENGTH	<length>	:= the number of waveform bytes, the valid range depends on the model. See note 1 below for the details. This parameter is not necessary in the "X" series
FREQ	<frequency>	:= frequency. The unit is Hertz "Hz".
AMPL	<amplifier>	:= amplitude. The unit is volts, peak-to-peak "Vpp".
OFST	<offset>	:= offset. The unit is volts "V".
PHASE	<phase>	:= phase. The unit is "degree".
WAVEDATA	<wave data>	:= waveform data. The wave data needs to be read from a waveform file

**QUERY SYNTAX**                      Format 1: WVDT? Mn

Format 2: WVDT? USER,<wave\_name>  
<wave name>:={The name of user defined waveform}.

**EXAMPLE**                              See section 4.1.5 for the example.

Notes:

- The table below shows the availability of some command parameters in each SDG series.

Parameter /command	SDG800	SDG1000	SDG2000X	SDG5000	SDG1000X	SDG6000X-E	SDG6000X
TYPE	yes	yes	no	yes	no	no	no
<length>	32KB	32KB	4B~16MB	32KB, 1024KB	4B~16MB	4B~16MB	4B~40MB
USER	no	no	yes	no	yes	yes	yes
Format of WVDT?	Format 1	Format 1	Built-in: Format1 User-defined: Format2	Format 1	Built-in: Format1 User-defined: Format2	Built-in: Format1 User-defined: Format2	Built-in: Format1 User-defined: Format2

- The table below shows the details of Mn parameters in each SDG series.

Model	Description of Mn
<b>SDG800</b>	0<=n<=59. M0~M49: build-in (32KB). M50~M59: user-defined (32KB).
<b>SDG1000</b>	0<=n<=59. M0~M49: build-in (32KB). M50~M59: user-defined (32KB).
<b>SDG2000X</b>	0<=n<=196. M0~M196: build-in (32KB).

	Not necessary when sending waveform data.
<b>SDG5000</b>	0<=n<=68. M0~M35: build-in (32KB). M36~M59: user-defined (32KB). M60~M67: user-defined (1024KB).
<b>SDG1000X</b>	0<=n<=196. M0~M196: build-in (32KB). Not necessary when sending waveform data.
<b>SDG6000X/X-E</b>	0<=n<=196. M0~M196: build-in (32KB). Not necessary when sending waveform data.

### 3.23 Virtual Key Command

**DESCRIPTION** This command is used to simulate pressing a key on the front panel.

**COMMAND SYNTAX** VirtualKEY VALUE,<value>,STATE,<state>  
 <value>:= {a Name or Index of the virtual keys from the table below}.  
 <state>:= {0,1}, where “1” is effective to virtual value, and “0” is useless.

Name	Index	Name	Index
KB_FUNC1	28	KB_NUMBER_4	52
KB_FUNC2	23	KB_NUMBER_5	53
KB_FUNC3	18	KB_NUMBER_6	54
KB_FUNC4	13	KB_NUMBER_7	55
KB_FUNC5	8	KB_NUMBER_8	56
KB_FUNC6	3	KB_NUMBER_9	57
KB_SINE	34	KB_POINT	46
KB_SQUARE	29	KB_NEGATIVE	43
KB_RAMP	24	KB_LEFT	44
KB_PULSE	19	KB_RIGHT	40
KB_NOISE	14	KB_UP	45
KB_ARB	9	KB_DOWN	39
KB_MOD	15	KB_OUTPUT1	153
KB_SWEEP	16	KB_OUTPUT2	152
KB_BURST	17	KB_KNOB_RIGHT	175
KB_WAVES	4	KB_KNOB_LEFT	177
KB_UTILITY	11	KB_KNOB_DOWN	176
KB_PARAMETER	5	KB_HELP	12
KB_STORE_RECALL	70	KB_CHANNEL	72

KB_NUMBER_0	48		
KB_NUMBER_1	49		
KB_NUMBER_2	50		
KB_NUMBER_3	51		

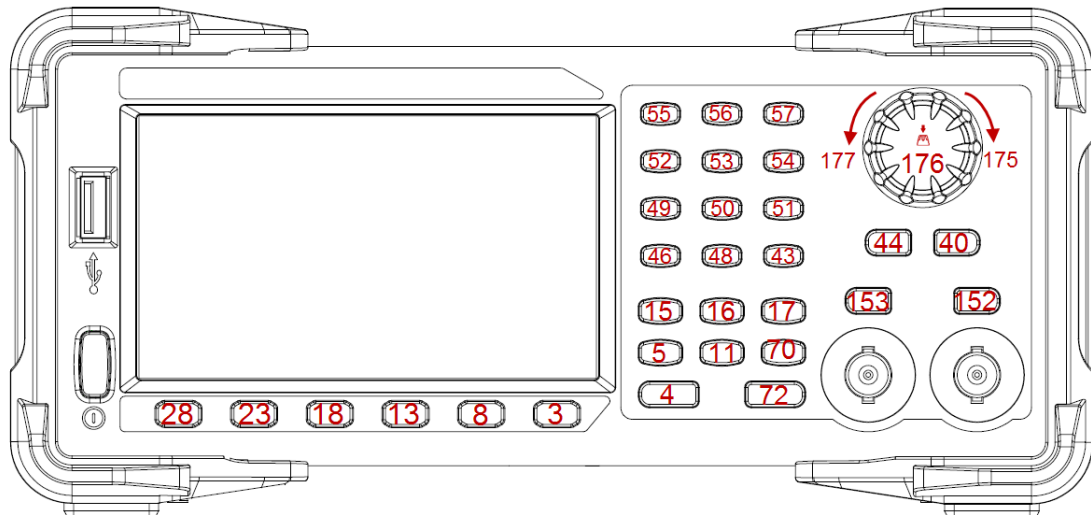

Keys and Indices on the SDG1000X/SDG2000X/SDG6000X/SDG6000X-E

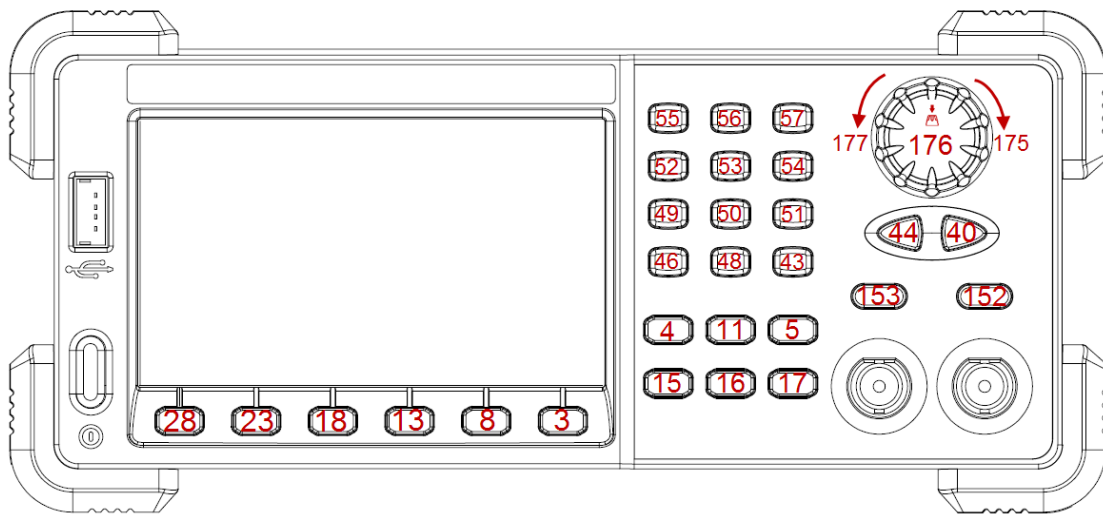

Keys and Indices on the SDG5000

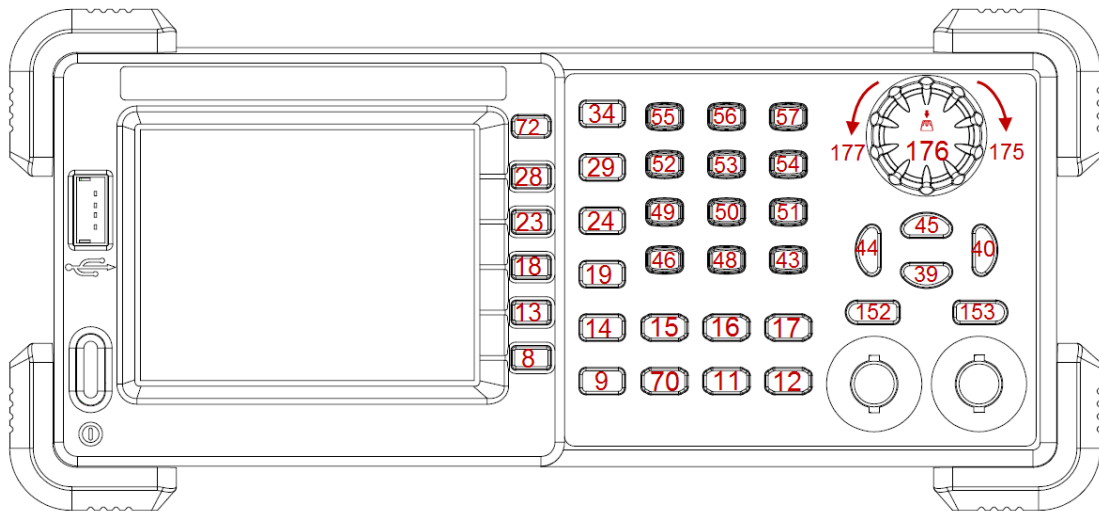

Keys and Indices on the SDG1000/SDG800

**EXAMPLE** *VKEY VALUE,15,STATE,1*

*VKEY VALUE,KB\_SWEEP,STATE,1*

Note: The table below shows the availability of some command parameters in each SDG series.

Parameter /command	SDG800	SDG1000	SDG2000X	SDG5000	SDG1000X	SDG6000X /X-E
KB_FUNC6	no	no	yes	yes	yes	yes
KB_STORE_RECALL	yes	yes	yes	no	yes	yes
KB_HELP	yes	yes	no	no	no	no
KB_CHANNEL	no	yes	yes	no	yes	yes
KB_SINE	yes	yes	no	no	no	no
KB_SQUARE	yes	yes	no	no	no	no
KB_RAMP	yes	yes	no	no	no	no
KB_PULSE	yes	yes	no	no	no	no
KB_NOISE	yes	yes	no	no	no	no
KB_ARB	yes	yes	no	no	no	no
KB_UP	yes	yes	no	no	no	no
KB_DOWN	yes	yes	no	no	no	no

### 3.24 IP Command

**DESCRIPTION** This command sets and gets the system IP address.

**COMMAND SYNTAX**     SYSTem:COMMunicate:LAN:IPADdress  
 “<parameter1>.<parameter2>.<parameter3>.<parameter4>”

<parameter1>:={an integer value between 1 and 223}.  
 <parameter2>:={an integer value between 0 and 255}.  
 <parameter3>:={an integer value between 0 and 255}.  
 <parameter4>:={an integer value between 0 and 255}.

**QUERY SYNTAX**         SYSTem:COMMunicate:LAN:IPADdress?

**EXAMPLES**                Set IP address to 10.11.13.203:  
*SYST:COMM:LAN:IPAD “10.11.13.203”*

Get the IP address:  
*SYST:COMM:LAN:IPAD?*

Return:  
*“10.11.13.203”*

Note: The table below shows the availability of the command in each SDG series.:

Parameter /command	SDG800	SDG1000	SDG2000X	SDG5000	SDG1000X	SDG6000X /X-E
SYST:COMM:LAN:IPAD	no	no	yes	no	yes	yes

### 3.25 Subnet Mask Command

**DESCRIPTION**            This command sets and gets the system subnet mask.

**COMMAND SYNTAX**       SYSTem:COMMunicate:LAN:SMASK  
 “<parameter1>.<parameter2>.<parameter3>.<parameter4>”

<parameter1>:={an integer value between 0 and 255}.  
 <parameter2>:={an integer value between 0 and 255}.  
 <parameter3>:={an integer value between 0 and 255}.  
 <parameter4>:={an integer value between 0 and 255}.

**QUERY SYNTAX**         SYSTem:COMMunicate:LAN:SMASK?

**EXAMPLES**                Set subnet mask to 255.0.0.0:  
*SYST:COMM:LAN:SMAS “255.0.0.0”*

Get subnet mask:



*SYST:COMM:LAN:SMAS?*

Return:

*"255.0.0.0"*

Note: The table below shows the availability of the command in each SDG series.

Parameter /command	SDG800	SDG1000	SDG2000X	SDG5000	SDG1000X	SDG6000X /X-E
SYST:COMM:LAN:SMAS	no	no	yes	no	yes	yes

### 3.26 Gateway Command

**DESCRIPTION**

This command sets and gets the system gateway.

**COMMAND SYNTAX**

*SYSTem:COMMunicate:LAN:GATeway*

*"<parameter1>.<parameter2>.<parameter3>.<parameter4>"*

*<parameter1>:= {an integer value between 0 and 223}.*

*<parameter2>:= {an integer value between 0 and 255}.*

*<parameter3>:= {an integer value between 0 and 255}.*

*<parameter4>:= {an integer value between 0 and 255}.*

**QUERY SYNTAX**

*SYSTem:COMMunicate:LAN:GATeway?*

**EXAMPLES**

Set Gateway to 10.11.13.5:

*SYSTem:COMMunicate:LAN:GATeway "10.11.13.5"*

Get gateway:

*SYSTem:COMMunicate:LAN:GATeway?*

Return:

*"10.11.13.5"*

Note: The table below shows the availability of the command in each SDG series.

Parameter /command	SDG800	SDG1000	SDG2000X	SDG5000	SDG1000X	SDG6000X /X-E
SYST:COMM:LAN:GAT	no	no	yes	no	yes	yes

### 3.27 Sampling Rate Command

**DESCRIPTION**

This command sets or gets the Arb mode, sampling rate and

interpolation method. Sampling rate and interpolation method can only be set when MODE is TARB.

**COMMAND SYNTAX** <channel>:SampleRATE MODE,<mode>,VALUE, <sample rate>,INTER,<interpolation>

<channel>:= <C1, C2>.  
 <mode>:= {DDS, TARB}, where TARB is TrueArb.  
 <sample rate>:= sample rate. The unit is Sa/s.  
 <interpolation>:= {LINE, HOLD, SINC, SINC27, SINC13}, where LINE is linear, and HOLD is zero-order hold. SINC, SINC27 and SINC13 are only for SDG6000X/X-E.

**QUERY SYNTAX** <channel>:SRATE?

**EXAMPLES** Get the sampling rate of CH1:

*C1:SRATE?*

Return:

*C1:SRATE MODE,DDS*

Set CH1 to TureArb mode:

*C1:SRATE MODE,TARB*

Set sampling rate of CH1 to 1000000Sa/s:

*C1:SRATE VALUE,1000000*

Set CH1 to TureArb mode and set interpolation to SINC13

*C1:SRATE MODE,TARB,INTER,SINC13*

Note: The table below shows the availability of the command and some parameters in each SDG series.

Parameter /command	SDG800	SDG1000	SDG2000X	SDG5000	SDG1000X	SDG6000X /X-E
SRATE	no	no	yes	no	no	yes
INTER	no	no	no	no	no	yes

### 3.28 Harmonic Command

**DESCRIPTION** This command sets or gets the harmonic parameters. Only available when the basic wave is SINE.

**COMMAND SYNTAX** <channel>:HARMonic HARMSTATE,<state>,HARMTYPE,

<type>,HARMORDER,<order>,<unit>,<value>,  
HARMPHASE,<phase>

<state>:= <ON, OFF>.

<type>:= <EVEN, ODD, ALL>.

<order>:= {1,2,...,M}, where M is the supported maximum order.

<unit>:= < HARMAMP, HARMDBC>.

<value>:= amplitude of specified harmonic. The range of valid values depends on the model. When <unit>= HARMAMP, the unit is volts, peak-to-peak "Vpp", and when <unit>= HARMDBC, the unit is "dBc".

<phase>:= {0~360}, the unit is "degree"

**QUERY SYNTAX**

<channel>:(HARMonic?

<channel> := {C1, C2}.

**EXAMPLES**

Enable the harmonic function of CH1:

*C1:HARM HARMSTATE,ON*

Set the 2nd harmonic of CH1 to -6 dBc:

*C1:HARM HARMORDER,2,HARMDBC,-6*

Get the harmonic information of CH1:

*C1:HARM?*

Return:

*C1:HARM ,HARMSTATE,ON,HARMTYPE,EVEN,HARMORDER,2,HARMAMP,2.004748935V,HARMDBC,-6dBc,HARMPHASE,0*

Note: The table below shows the availability of the command in each SDG series.

Parameter /command	SDG800	SDG1000	SDG2000X	SDG5000	SDG1000X	SDG6000X /X-E
HARM	no	no	yes	no	yes	yes

### 3.29 Waveform Combining Command

**DESCRIPTION**

This command sets or gets the waveform combining parameters.

**COMMAND SYNTAX**

<channel>:CoMBiNe <state>

<channel>:= {C1, C2}.

<state>:= {ON, OFF}.

**QUERY SYNTAX**

<channel>:CoMBiNe?

<channel>:= {C1, C2}.

**RESPONSE FORMAT** <channel>:CMBN <state>

**EXAMPLES** Turn on the waveform combining of CH1:  
*C1:CMBN ON*

Query the waveform combining state of CH2:  
*C2:CMBN?*  
Return:  
*C2:CMBN OFF*

Note: The table below shows the availability of the command in each SDG series.

Parameter /command	SDG800	SDG1000	SDG2000X	SDG5000	SDG1000X	SDG6000X /X-E
CMBN	no	no	yes	no	yes	yes

### 3.30 Mode Select Command

**DESCRIPTION** This command sets or gets the phase mode.

**COMMAND SYNTAX** MODE <parameter>  
<parameter>:= {PHASE-LOCKED, INDEPENDENT}.

**QUERY SYNTAX** MODE?

**RESPONSE FORMAT** MODE <parameter>

**EXAMPLE** Set the phase mode to INDEPENDENT:  
*MODE INDEPENDENT*

Note: The table below shows the availability of the command in each SDG series.

Parameter /command	SDG800	SDG1000	SDG2000X	SDG5000	SDG1000X	SDG6000X /X-E
MODE	no	no	yes	no	yes	yes

### 3.31 Multi-Device Sync

**DESCRIPTION** This command set up synchronization between two or more instruments and achieve in-phase output

**COMMAND SYNTAX** CASCADE STATE,ON|OFF,MODE,<MODE>,DELAY,<DELAY>

<MODE>:={MASTER,SLAVE}  
 <DELAY>:={0-0.000025},UNIT=s, This parameter can only be set in slave mode

**QUERY SYNTAX** CASCADE?

**RESPONSE FORMAT** Return from SLAVE MODE :  
 CASCADE STATE,ON,MODE,SLAVE,DELAY, <DELAY>  
 Return from MASTER mode :  
 CASCADE STATE,ON,MODE,MASTER

**EXAMPLE** Set the device as slave and the delay to 0.0000001s:  
*CASCADE STATE,ON,MODE,SLAVE,DELAY,0.0000001*

### 3.32 IQ Commands

The table below shows the availability of IQ commands in each SDG series.

Parameter /command	SDG800	SDG1000	SDG2000 X	SDG5000	SDG1000 X	SDG6000 X	SDG6000 X-E
IQ	no	no	no	no	no	yes	no

#### 3.32.1 :IQ:CENTerfreq

**DESCRIPTION** This command sets center frequency of the I/Q modulator.

**COMMAND SYNTAX** [:SOURce]:IQ:CENTerfreq <center\_freq><unit>  
 <center\_freq>:= the center frequency. Refer to the data sheet for the range of valid values.  
 <unit>:= {Hz, kHz, MHz, GHz}. The default unit is Hertz "Hz".

**QUERY SYNTAX** [:SOURce]:IQ:CENTerfreq?

**RESPONSE FORMAT** <center\_freq> (expressed in Hz.)

**EXAMPLE** Set the center frequency to 1 kHz:  
*:SOURce:IQ:CENTerfreq 1000Hz*

### 3.32.2 :IQ:SAMPLerate

<b>DESCRIPTION</b>	This command sets the I/Q sampling rate.
<b>COMMAND SYNTAX</b>	[[:SOURce]:]IQ:SAMPLerate <sample_rate><unit> <sample_rate>:= sample rate. Refer to the data sheet for the range of valid values. <unit>:= {Hz, kHz, MHz, GHz}. The default unit is Hertz "Hz".
<b>QUERY SYNTAX</b>	[[:SOURce]:]IQ:SAMPLerate?
<b>RESPONSE FORMAT</b>	<sample_rate> (expressed in Hz.)
<b>EXAMPLE</b>	Set the sample rate to 100 kHz: <i>:IQ:SAMPLerate 1000000</i> or: <i>:IQ:SAMP 100kHz</i>

### 3.32.3 :IQ:SYMBOLrate

<b>DESCRIPTION</b>	This command sets the I/Q symbol rate.
<b>COMMAND SYNTAX</b>	[[:SOURce]:]IQ:SYMBOLrate <symb_rate><unit> <symb_rate>:= symbol rate. Refer to the data sheet for the range of valid values. <unit>:= {S/s, kS/s, MS/s}. The default unit is symbols-per-second "S/s".
<b>QUERY SYNTAX</b>	[[:SOURce]:]IQ:SYMBOLrate?
<b>RESPONSE FORMAT</b>	<symb_rate> (expressed in S/s.)
<b>EXAMPLE</b>	Set the symbol rate to 1 MS/s: <i>:IQ:SYMB 1MS/s</i>

### 3.32.4 :IQ:AMPLitude

<b>DESCRIPTION</b>	This command sets the I/Q amplitude.
<b>COMMAND SYNTAX</b>	[[:SOURce]:]IQ:AMPLitude <amplitude><unit> <amplitude>:= amplitude. Refer to the data sheet for the range of valid values.

<unit>:= {Vrms, mVrms, dBm}. The default unit is volts, root-mean-square “Vrms”.

**QUERY SYNTAX** [:SOURce]:IQ:AMPLitude?

**RESPONSE FORMAT** <amplitude> (expressed Vrms.)

**EXAMPLE** Set the I/Q amplitude ( $\sqrt{I^2+Q^2}$ ) to 0.2 Vrms:  
*:IQ:AMPL 0.2*

### 3.32.5 :IQ:IQADjustment:GAIN

**DESCRIPTION** This command adjusts the ratio of I to Q while preserving the composite.

**COMMAND SYNTAX** [:SOURce]:IQ:IQADjustment:GAIN <gain\_ratio>  
 <gain\_ratio>:= Gain ratio of I to Q. The default unit is dB.

**QUERY SYNTAX** [:SOURce]:IQ:IQADjustment:GAIN?

**RESPONSE FORMAT** <gain\_ratio> (expressed in unit of dB.)

**EXAMPLE** Set the gain ratio of I/Q to 0.1 dB:  
*:IQ:IQADjustment:GAIN 0.1*

### 3.32.6 :IQ:IQADjustment:IOFFset

**DESCRIPTION** This command adjusts the I channel offset value.

**COMMAND SYNTAX** [:SOURce]:IQ:IQADjustment:IOFFset <offset><unit>  
 <offset>:= I offset.  
 <unit>:= {V, mV, uV}. The default unit is volts “V”.

**QUERY SYNTAX** [:SOURce]:IQ:IQADjustment:IOFFset?

**RESPONSE FORMAT** <offset> (expressed V.)

**EXAMPLE** Set the I offset to 1 mV:  
*:IQ:IQADjustment:IOFFset 1mV*

### 3.32.7 :IQ:IQADjustment:QOFFset

<b>DESCRIPTION</b>	This command adjusts the Q channel offset value.
<b>COMMAND SYNTAX</b>	[[:SOURce]:IQ:IQADjustment:QOFFset <offset><unit> <offset>:= Q offset. <unit>:= {V, mV, uV}. The default unit is volts "V".
<b>QUERY SYNTAX</b>	[[:SOURce]:IQ:IQADjustment:QOFFset?
<b>RESPONSE FORMAT</b>	<offset> (expressed in V.)
<b>EXAMPLE</b>	Set the Q offset to -1 mV: <i>:IQ:IQAD:QOFF -0.001V</i>

### 3.32.8 :IQ:IQADjustment:QSKew

<b>DESCRIPTION</b>	This command adjusts the phase angle (quadrature skew) between the I and Q vectors by increasing or decreasing the Q phase angle.
<b>COMMAND SYNTAX</b>	[[:SOURce]:IQ:IQADjustment:QSKew <angle> <angle>:= angle. The unit is degree.
<b>QUERY SYNTAX</b>	[[:SOURce]:IQ:IQADjustment:QSKew?
<b>RESPONSE FORMAT</b>	<angle> (expressed in unit of degree.)
<b>EXAMPLE</b>	Set the Q angle to 1 degree: <i>:IQ:IQADjustment:QSKew 1.0</i>

### 3.32.9 :IQ:TRIGger:SOURce

<b>DESCRIPTION</b>	This command sets the I/Q trigger source.
<b>COMMAND SYNTAX</b>	[[:SOURce]:IQ:TRIGger:SOURce <src> <src>:={INTernal,EXTernal,MANual}
<b>QUERY SYNTAX</b>	[[:SOURce]:IQ:TRIGger:SOURce?
<b>RESPONSE FORMAT</b>	<src>



**EXAMPLE**                      Set the trigger source to INT:  
*:IQ:TRIGger:SOURce INTernal*

### 3.32.10 :IQ:WAVEload:BUILtin

**DESCRIPTION**                This command selects I/Q waveform from the built in waveform list.

**COMMAND SYNTAX**            [:SOURce]:IQ:WAVEload:BUILtin <wave\_name>  
 <wave\_name>:= {A waveform name from the table below}.

**QUERY SYNTAX**                [:SOURce]:IQ:WAVEload?

**RESPONSE FORMAT**            BUILtin|USERstored <wave\_name>

**EXAMPLE**                      Set the I/Q waveform to built-in 2ASK:  
*:IQ:WAVE:BUIL 2ASK*

2ASK	4ASK	8ASK	BPSK	4PSK
8PSK	DBPSK	4DPSK	8DPSK	8QAM
16QAM	32QAM	64QAM	128QAM	256QAM

### 3.32.11 :IQ:WAVEload:USERstored

**DESCRIPTION**                This command selects I/Q waveform from the user stored waveforms.

**COMMAND SYNTAX**            [:SOURce]:IQ:WAVEload:USERstored “<wave\_name>”  
 <wave\_name>:= { A waveform name from the user stored waveforms}.

**QUERY SYNTAX**                [:SOURce]:IQ:WAVEload?

**RESPONSE FORMAT**            BUILtin|USERstored <wave\_name>

**EXAMPLE**                      Set the I/Q waveform to user stored UserIQ\_1.arb:  
*:IQ:WAVEload:USERstored “UserIQ\_1.arb”*

### 3.32.12 :IQ:FrequencySampling

<b>DESCRIPTION</b>	This command sets the I/Q Frequency sampling rate.
<b>COMMAND SYNTAX</b>	[[:SOURce]:]IQ: FrequencySampling <sampling> < sampling >:= {500-300000000}. The unit is S/s
<b>QUERY SYNTAX</b>	[[:SOURce]:]IQ:FrequencySampling? [[:SOURce]:]IQ:FrequencySamplingLimit?
<b>RESPONSE FORMAT</b>	<sampling> MAX,<max_sampling>,MIN,< min_sampling >
<b>EXAMPLE</b>	Set the I/Q frequency sampling to 2000000: <i>:IQ:FrequencySampling 2000000</i>

## 4 Programming Examples

This chapter gives some examples for the programmer. In these examples you can see how to use VISA or sockets, in combination with the commands described above to control the generator. By following these examples, you can develop many more applications.

### 4.1 Examples of Using VISA

#### 4.1.1 VC++ Example

**Environment:** Windows 7 32-bit, Visual Studio.

**Description:** Query the instrument information using "\*IDN?" command over NI-VISA, with the access through USBTMC and TCP/IP separately.

**Steps:**

1. Open Visual Studio, create a new VC++ win32 console project.
2. Set the project environment to use the NI-VISA lib, there are two ways to specify NI-VISA, static or automatic:
  - a) Static:

Find the files visa.h, visatype.h and visa32.lib in NI-VISA installation path, copy them to the root path of the VC++ project, and add them into the project. In the projectname.cpp file, add the following two lines:

```
#include "visa.h"
#pragma comment(lib,"visa32.lib")
```
  - b) Dynamic:

In "project---properties---c/c++---General---Additional Include Directories" set the value to the NI-VISA installation path (e.g. C:\Program Files\IVI Foundation\VISA\WinNT\include), as shown in the figure below:

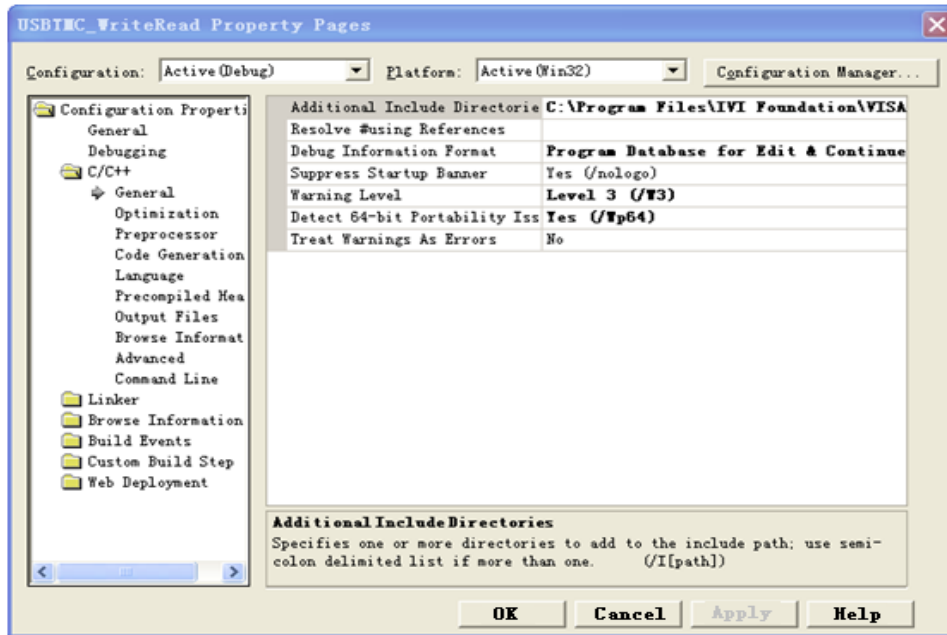

In "project---properties---Linker---General---Additional Library Directories " set the value to the NI-VISA installation path (e.g. C:\Program Files\IVI Foundation\VISAWinNT\include), as shown in the figure below:

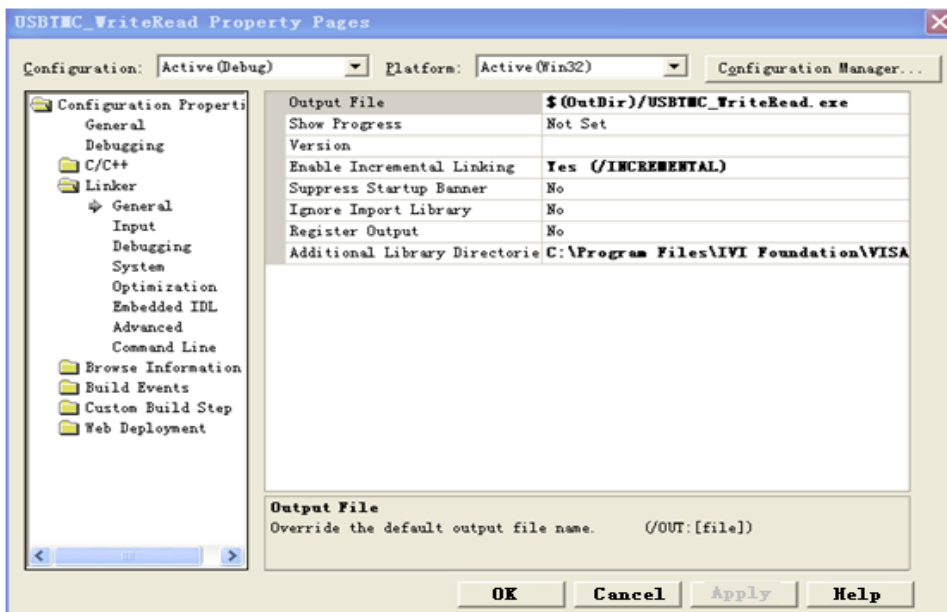

In "project---properties---Linker---Command Line---Additional" set the value to visa32.lib, as shown in the figure below:

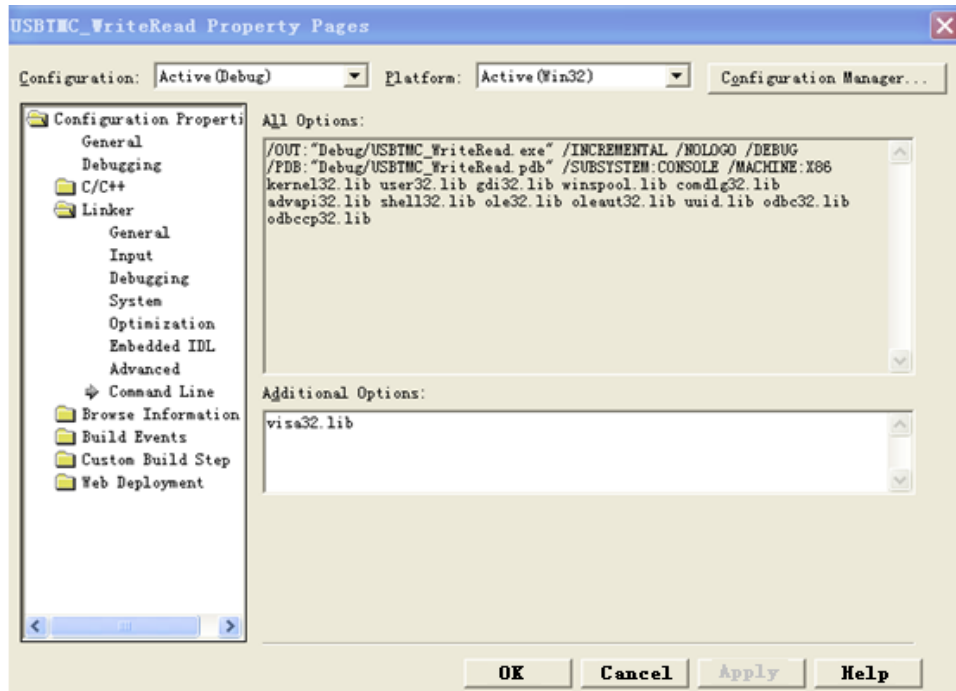

Include visa.h file in the projectname.cpp file:

```
#include <visa.h>
```

### 3. Coding:

#### a) USBTMC:

```
int Usbtmc_test()
{
    /* This code demonstrates sending synchronous read & write commands */
    /* to an USB Test & Measurement Class (USBTMC) instrument using      */
    /* NI-VISA                                                             */
    /* The example writes the "*IDN?\n" string to all the USBTMC         */
    /* devices connected to the system and attempts to read back         */
    /* results using the write and read functions.                        */
    /* The general flow of the code is */
    /*   Open Resource Manager      */
    /*   Open VISA Session to an Instrument                               */
    /*   Write the Identification Query Using viPrintf                    */
    /*   Try to Read a Response With viScanf                             */
    /*   Close the VISA Session      */
    /******
    ViSession defaultRM;
    ViSession instr;
```

```
ViUInt32 numInstrs;
ViFindList findList;
ViStatus status;
char instrResourceString[VI_FIND_BUFLen];
unsigned char buffer[100];
int i;
/** First we must call viOpenDefaultRM to get the manager
 * handle. We will store this handle in defaultRM.*/
status=viOpenDefaultRM (&defaultRM);
if (status<VI_SUCCESS)
{
    printf ("Could not open a session to the VISA Resource Manager!\n");
    return status;
}
/* Find all the USB TMC VISA resources in our system and store the number of
resources in the system in numInstrs. */
status = viFindRsrc (defaultRM, "USB?*INSTR", &findList, &numInstrs,
instrResourceString);
if (status<VI_SUCCESS)
{
    printf ("An error occurred while finding resources.\nPress 'Enter' to
continue.");
    fflush(stdin);
    getchar();
    viClose (defaultRM);
    return status;
}
/** Now we will open VISA sessions to all USB TMC instruments.
 * We must use the handle from viOpenDefaultRM and we must
 * also use a string that indicates which instrument to open. This
 * is called the instrument descriptor. The format for this string
 * can be found in the function panel by right clicking on the
 * descriptor parameter. After opening a session to the
 * device, we will get a handle to the instrument which we
 * will use in later VISA functions. The AccessMode and Timeout
 * parameters in this function are reserved for future
 * functionality. These two parameters are given the value VI_NULL.*/
for (i=0; i<int(numInstrs); i++)
{
    if (i> 0)
    {
        viFindNext (findList, instrResourceString);
    }
    status = viOpen (defaultRM, instrResourceString, VI_NULL, VI_NULL,
```

```
&instr);
    if (status<VI_SUCCESS)
    {
        printf ("Cannot open a session to the device %d.\n", i+1);
        continue;
    }
    /* * At this point we now have a session open to the USB TMC instrument.
    * We will now use the viPrintf function to send the device the string
    "*IDN?\n",
    * asking for the device's identification. */
    char * ccommand = "*IDN?\n";
    status = viPrintf (instr, ccommand);
    if (status<VI_SUCCESS)
    {
        printf ("Error writing to the device %d.\n", i+1);
        status = viClose (instr);
        continue;
    }
    /** Now we will attempt to read back a response from the device to
    * the identification query that was sent. We will use the viScanf
    * function to acquire the data.
    * After the data has been read the response is displayed.*/
    status = viScanf(instr, "%t", buffer);
    if (status<VI_SUCCESS)
    {
        printf ("Error reading a response from the device %d.\n", i+1);
    }
    else
    {
        printf ("\nDevice %d: %s\n", i+1 , buffer);
    }
    status = viClose (instr);

}

/** Now we will close the session to the instrument using
* viClose. This operation frees all system resources. */
status = viClose (defaultRM);
printf("Press 'Enter' to exit.");
fflush(stdin);
getchar();
return 0;
}

int _tmain(int argc, _TCHAR* argv[])
```

```

{
    Usbtmc_test();
    return 0;
}

```

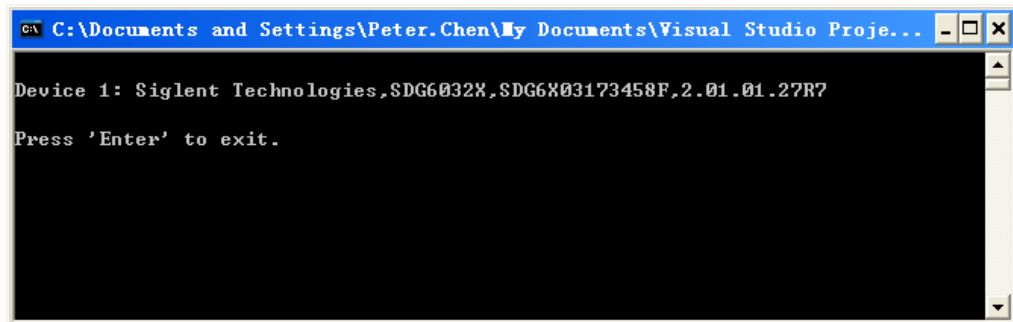
**Run result:****b) TCP/IP:**

```

int TCP_IP_Test(char *pIP)
{
    char outputBuffer[VI_FIND_BUFLLEN];
    ViSession defaultRM, instr;
    ViStatus status;
    /* First we will need to open the default resource manager. */
    status = viOpenDefaultRM (&defaultRM);
    if (status<VI_SUCCESS)
    {
        printf("Could not open a session to the VISA Resource Manager!\n");
    }
    /* Now we will open a session via TCP/IP device */
    char head[256] ="TCPIP0::";
    char tail[] ="::INSTR";
    strcat(head, pIP);
    strcat(head, tail);
    status = viOpen (defaultRM, head, VI_LOAD_CONFIG, VI_NULL, &instr);
    if (status<VI_SUCCESS)
    {
        printf ("An error occurred opening the session\n");
        viClose(defaultRM);
    }
    status = viPrintf(instr, "*idn?\n");
    status = viScanf(instr, "%t", outputBuffer);
    if (status<VI_SUCCESS)

```



```
    {
        printf("viRead failed with error code: %x \n", status);
        viClose(defaultRM);
    }
    else
    {
        printf ("\nMesseage read from device: %s\n", 0, outputBuffer);
    }
    status = viClose (instr);
    status = viClose (defaultRM);
    printf("Press 'Enter' to exit.");
    fflush(stdin);
    getchar();
    return 0;
}

int _tmain(int argc, _TCHAR* argv[])
{
    printf("Please input IP address:");
    char ip[256];
    fflush(stdin);
    gets(ip);
    TCP_IP_Test(ip);
    return 0;
}
```

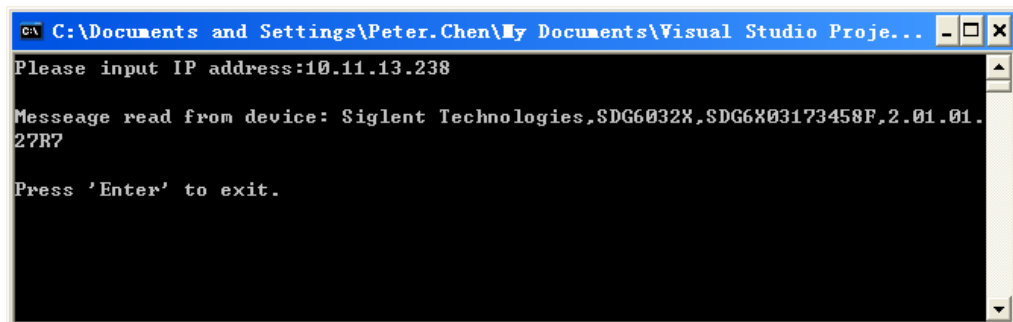
**Run result:**

```
C:\Documents and Settings\Peter.Chen\My Documents\Visual Studio Proje...
Please input IP address:10.11.13.238

Messeage read from device: Siglent Technologies,SDG6032X,SDG6X03173458F,2.01.01.
27R?

Press 'Enter' to exit.
```

## 4.1.2 VB Example

**Environment:** Windows 7 32-bit, Microsoft Visual Basic 6.0

**Description:** Query the instrument information using "IDN?" command over NI-VISA, with the access through USBTMC and TCP/IP separately.

**Steps:**

1. Open Visual Basic, and build a standard application program project.
2. Set the project environment to use the NI-VISA lib: Click the Existing tab of Project>>Add Existing Item, search the visa32.bas file in the "include" folder under the NI-VISA installation path and add the file, as shown in the figure below:

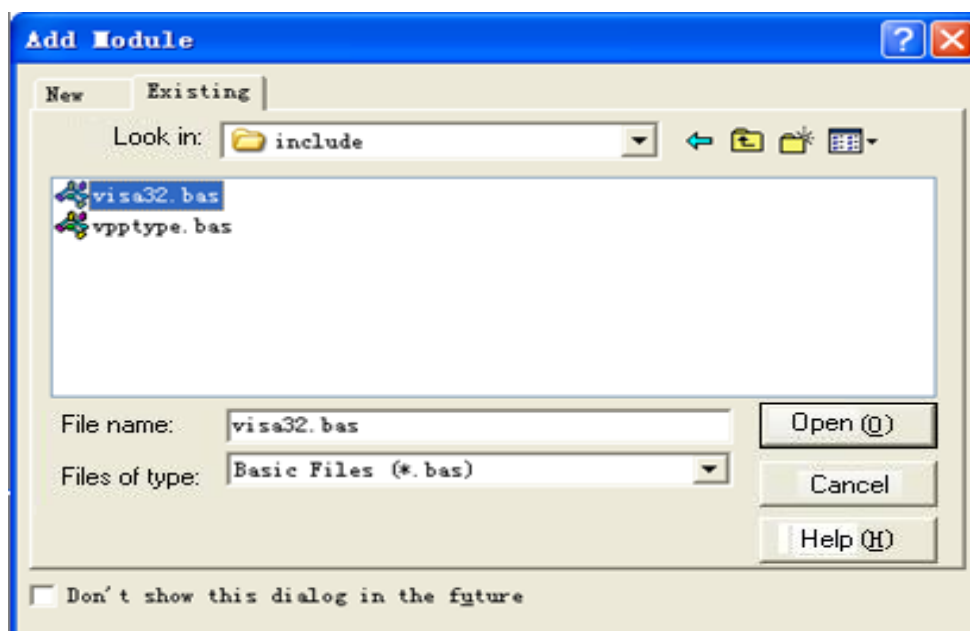

3. Coding:
  - a) USBTMC:

`Private Function Usbtmc_test() As Long`

```
' This code demonstrates sending synchronous read & write commands  
' to an USB Test & Measurement Class (USBTMC) instrument using  
' NI-VISA  
' The example writes the "*IDN?\n" string to all the USBTMC  
' devices connected to the system and attempts to read back  
' results using the write and read functions.  
' The general flow of the code is  
'   Open Resource Manager  
'   Open VISA Session to an Instrument
```

```

' Write the Identification Query Using viWrite
' Try to Read a Response With viRead
' Close the VISA Session
Const MAX_CNT = 200

Dim defaultRM As Long
Dim instrsesn As Long
Dim numInstrs As Long
Dim findList As Long
Dim retCount As Long
Dim status As Long
Dim instrResourceString As String * VI_FIND_BUFLEN
Dim Buffer As String * MAX_CNT
Dim i As Integer

' First we must call viOpenDefaultRM to get the manager
' handle. We will store this handle in defaultRM.
status = viOpenDefaultRM(defaultRM)
If (status < VI_SUCCESS) Then
    resultTxt.Text = "Could not open a session to the VISA Resource Manager!"
    Usbtmc_test = status
    Exit Function
End If

' Find all the USB TMC VISA resources in our system and store the
' number of resources in the system in numInstrs.
status = viFindRsrc(defaultRM, "USB?*INSTR", findList, numInstrs, instrResourceString)
If (status < VI_SUCCESS) Then
    resultTxt.Text = "An error occurred while finding resources."
    viClose(defaultRM)
    Usbtmc_test = status
    Exit Function
End If

' Now we will open VISA sessions to all USB TMC instruments.
' We must use the handle from viOpenDefaultRM and we must
' also use a string that indicates which instrument to open. This
' is called the instrument descriptor. The format for this string
' can be found in the function panel by right clicking on the
' descriptor parameter. After opening a session to the
' device, we will get a handle to the instrument which we
' will use in later VISA functions. The AccessMode and Timeout
' parameters in this function are reserved for future
' functionality. These two parameters are given the value VI_NULL.

```

```

For i = 0 To numInstrs
  If (i > 0) Then
    status = viFindNext(findList, instrResourceString)
  End If
  status = viOpen(defaultRM, instrResourceString, VI_NULL, VI_NULL, instrsesn)
  If (status < VI_SUCCESS) Then
    resultTxt.Text = "Cannot open a session to the device " + CStr(i + 1)
    GoTo NextFind
  End If

  ' At this point we now have a session open to the USB TMC instrument.
  ' We will now use the viWrite function to send the device the string "*IDN?",
  ' asking for the device's identification.
  status = viWrite(instrsesn, "*IDN?", 5, retCount)
  If (status < VI_SUCCESS) Then
    resultTxt.Text = "Error writing to the device."
    status = viClose(instrsesn)
    GoTo NextFind
  End If

  ' Now we will attempt to read back a response from the device to
  ' the identification query that was sent. We will use the viRead
  ' function to acquire the data.
  ' After the data has been read the response is displayed.
  status = viRead(instrsesn, Buffer, MAX_CNT, retCount)
  If (status < VI_SUCCESS) Then
    resultTxt.Text = "Error reading a response from the device." + CStr(i + 1)
  Else
    resultTxt.Text = "Read from device: " + CStr(i + 1) + " " + Buffer
  End If
  status = viClose(instrsesn)
Next i

' Now we will close the session to the instrument using
' viClose. This operation frees all system resources.
status = viClose(defaultRM)
Usbtmc_test = 0
End Function

```

b) TCP/IP:

```

Private Function TCP_IP_Test(ByVal ip As String) As Long
  Dim outputBuffer As String * VI_FIND_BUFLen

```

```
Dim defaultRM As Long
Dim instrsesn As Long
Dim status As Long
Dim count As Long

' First we will need to open the default resource manager.
status = viOpenDefaultRM(defaultRM)
If (status < VI_SUCCESS) Then
    resultTxt.Text = "Could not open a session to the VISA Resource Manager!"
    TCP_IP_Test = status
    Exit Function
End If

' Now we will open a session via TCP/IP device
status = viOpen(defaultRM, "TCPIP0::" + ip + "::INSTR", VI_LOAD_CONFIG, VI_NULL,
instrsesn)
If (status < VI_SUCCESS) Then
    resultTxt.Text = "An error occurred opening the session"
    viClose(defaultRM)
    TCP_IP_Test = status
    Exit Function
End If

status = viWrite(instrsesn, "*IDN?", 5, count)
If (status < VI_SUCCESS) Then
    resultTxt.Text = "Error writing to the device."
End If
status = viRead(instrsesn, outputBuffer, VI_FIND_BUFLEN, count)
If (status < VI_SUCCESS) Then
    resultTxt.Text = "Error reading a response from the device." + CStr(i + 1)
Else
    resultTxt.Text = "read from device:" + outputBuffer
End If
status = viClose(instrsesn)
status = viClose(defaultRM)
TCP_IP_Test = 0

End Function
```

c) Button control code:

```
Private Sub exitBtn_Click()
    End
```

```

End Sub
Private Sub tcpipBtn_Click()
    Dim stat As Long
    stat = TCP_IP_Test(ipTxt.Text)
    If (stat < VI_SUCCESS) Then
        resultTxt.Text = Hex(stat)
    End If
End Sub
Private Sub usbBtn_Click()
    Dim stat As Long
    stat = Usbtmc_test
    If (stat < VI_SUCCESS) Then
        resultTxt.Text = Hex(stat)
    End If
End Sub

```

Run result:

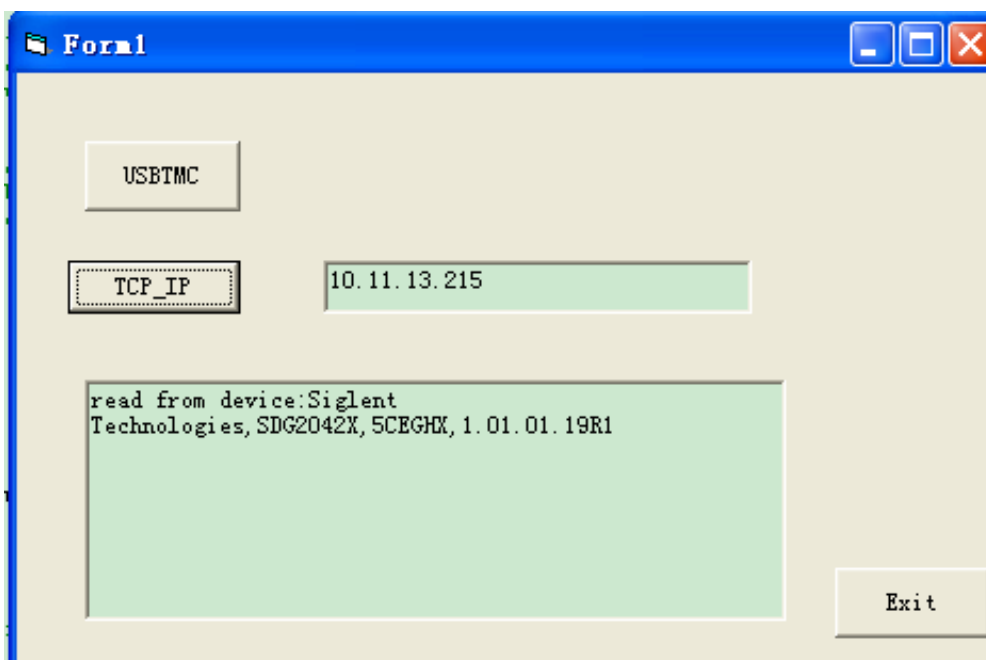

### 4.1.3 MATLAB Example

**Environment:** Windows 7 32-bit, MATLAB R2013a

**Description:** Query the instrument information using "IDN?" command over NI-VISA, with the access through USBTMC and TCP/IP separately.

**Steps:**

1. Open MATLAB, and modify the current directory. In this demo, the current directory is modified to "D:\USBTMC\_TCPIP\_Demo".
2. Click File>>New>>Script in the Matlab interface to create an empty M file.
3. Coding:
  - a) USBTMC:

```
function USBTMC_test()
% This code demonstrates sending synchronous read & write commands
% to an USB Test & Measurement Class (USBTMC) instrument using
% NI-VISA

%Create a VISA-USB object connected to a USB instrument
vu = visa('ni','USB0::0xF4ED::0xEE3A::sdg2000x::INSTR');

%Open the VISA object created
fopen(vu);

%Send the string "*IDN?",asking for the device's identification.
fprintf(vu,'*IDN?');

%Request the data
outputbuffer = fscanf(vu);
disp(outputbuffer);

%Close the VISA object
fclose(vu);
delete(vu);
clear vu;

end
```

**Run result:**

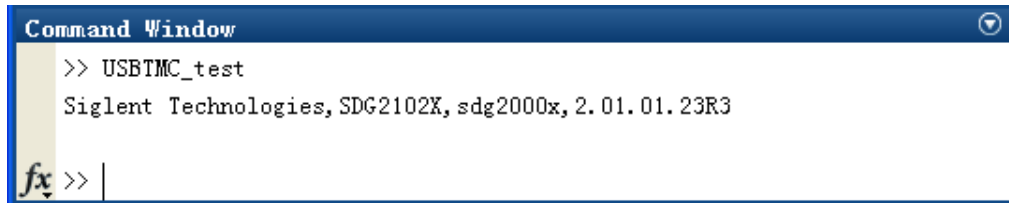

```

Command Window
>> USBTMC_test
Siglent Technologies, SDG2102X, sdg2000x, 2.01.01.23R3
fx >> |

```

## b) TCP/IP:

Write a function TCP\_IP\_Test:

```

function TCP_IP_test()
% This code demonstrates sending synchronous read & write commands
% to an TCP/IP instrument using NI-VISA

%Create a VISA-TCPIP object connected to an instrument
%configured with IP address.
vt = visa('ni',['TCPIP0:','10.11.13.32', '::INSTR']);

%Open the VISA object created
fopen(vt);

%Send the string "*IDN?",asking for the device's identification.
fprintf(vt, '*IDN?');

%Request the data
outputbuffer = fscanf(vt);
disp(outputbuffer);

%Close the VISA object
fclose(vt);
delete(vt);
clear vt;

end

```

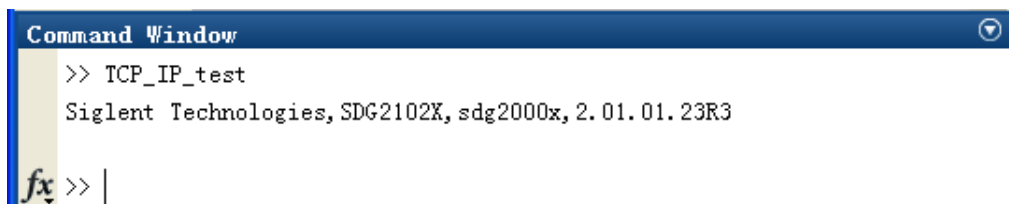
**Run result:**

```

Command Window
>> TCP_IP_test
Siglent Technologies, SDG2102X, sdg2000x, 2.01.01.23R3
fx >> |

```



### 4.1.4 LabVIEW Example

**Environment:** Windows 7 32-bit, LabVIEW 2011

**Description:** Query the instrument information using "IDN?" command over NI-VISA, with the access through USBTMC and TCP/IP separately.

**Steps:**

1. Open LabVIEW, and create a VI file.
2. Add controls. Right-click in the **Front Panel** interface, select and add **VISA resource name**, error in, error out and some indicators from the Controls column.
3. Open the **Block Diagram** interface. Right-click on the **VISA resource name**, select and add the following functions from VISA Palette from the pop-up menu: **VISA Write**, **VISA Read**, **VISA Open** and **VISA Close**.
4. The connection is as shown in the figure below:

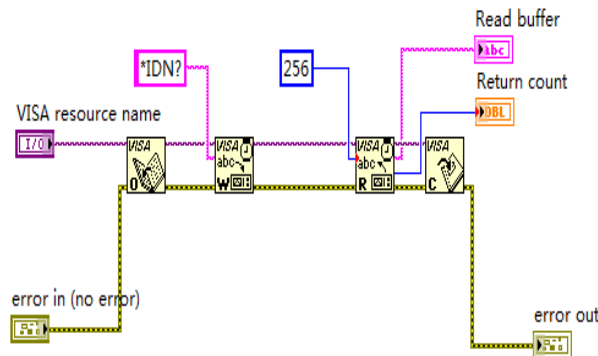

5. Select the device resource from the VISA Resource Name list box and run the program.

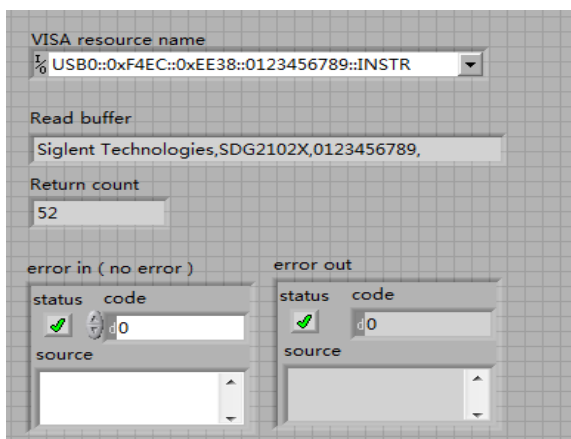

In this example, the VI opens a VISA session to a USBTMC device, writes a "IDN?" command to the device, and reads back the response. After all communication is complete, the VI closes the VISA session.

6. Communicating with the device via TCP/IP is similar to USBTMC. But you need to change VISA Write and VISA Read Function to Synchronous I/O. The LabVIEW default is asynchronous I/O. Right-click the node and select Synchronous I/O Mod>>Synchronous from the shortcut menu to write or read data synchronously.
7. The connection is as shown in the figure below:

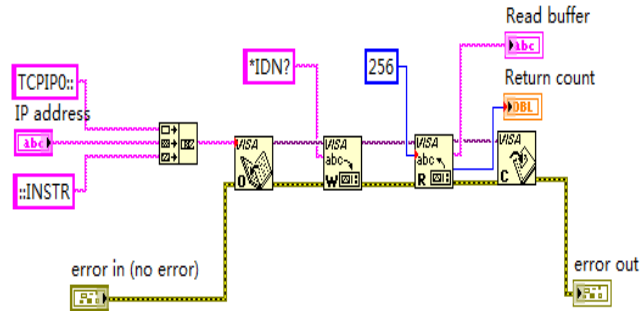

8. Input the IP address and run the program.

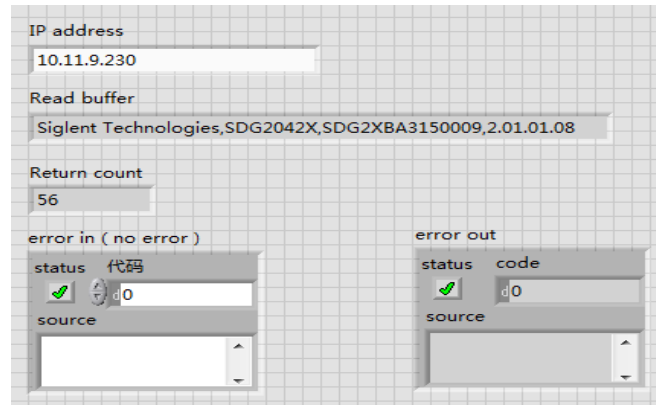

## 4.1.5 Python Example

**Environment:** Python2.7, PyVISA 1.4

(Please install PyVISA after installing Python2.7. Please refer to <https://pyvisa.readthedocs.io/en/stable/getting.html> for PyVISA installation guide.

**Description:** Use Python script to build an 8-point 16-bit arbitrary waveform (0x1000, 0x2000, 0x3000, 0x4000, 0x5000, 0x6000, 0x7000, 0x7fff) and save the waveform data in "wave1.bin", then download it to the instrument, finally read it back from the instrument and save it as "wave2.bin".

Below is the code of the script:

```
#!/usr/bin/env python2.7
# -*- coding: utf-8 -*-

import visa
import time
import binascii

#USB resource of Device
device_resource = "USB0::0xF4EC::0x1101::#15::INSTR"

#Little endian, 16-bit 2's complement
wave_points = [0x0010, 0x0020, 0x0030, 0x0040, 0x0050, 0x0060, 0x0070, 0xff7f]

def create_wave_file():
    """create a file"""
    f = open("wave1.bin", "wb")
    for a in wave_points:
        b = hex(a)
        b = b[2:]
        len_b = len(b)
        if (0 == len_b):
            b = '0000'
        elif (1 == len_b):
            b = '000' + b
        elif (2 == len_b):
            b = '00' + b
        elif (3 == len_b):
```

```

        b = '0' + b
        c = binascii.a2b_hex(b)    #Hexadecimal integer to ASCII encoded string
        f.write(c)
    f.close()

def send_wave_data(dev):
    """send wave1.bin to the device"""
    f = open("wave1.bin", "rb")    #wave1.bin is the waveform to be sent
    data = f.read()
    print 'write bytes:',len(data)
    dev.write("C1:WVDT
WVNM,wave1,FREQ,2000.0,AMPL,4.0,OFST,0.0,PHASE,0.0,WAVEDATA,%s" % (data))
#"X" series (SDG1000X/SDG2000X/SDG6000X/X-E)
    dev.write("C1:ARWV NAME,wave1")
    f.close()

def get_wave_data(dev):
    """get wave from the device"""
    f = open("wave2.bin", "wb")    #save the waveform as wave2.bin
    dev.write("WVDT? user,wave1")    #"X" series (SDG1000X/SDG2000X/SDG6000X/X-E)
    time.sleep(1)
    data = dev.read()
    data_pos = data.find("WAVEDATA,") + len("WAVEDATA,")
    print data[0:data_pos]
    wave_data = data[data_pos:]
    print 'read bytes:',len(wave_data)
    f.write(wave_data)
    f.close()

if __name__ == '__main__':
    """
    device = visa.instrument(device_resource, timeout=5000, chunk_size = 40*1024)
    create_wave_file()
    send_wave_data(device)
    get_wave_data(device)
    """

```

**Output waveform:**

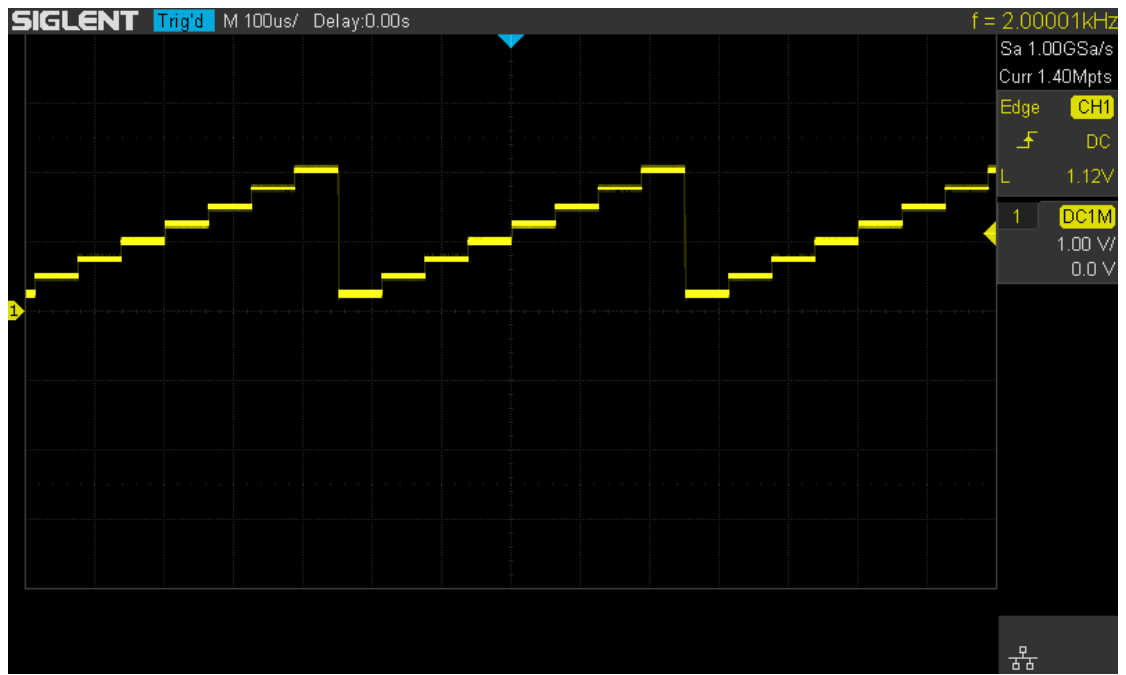

## 4.2 Examples of Using Sockets

### 4.2.1 Python Example

Python has a low-level networking module that provides access to the socket interface. Python scripts can be written for sockets to do a variety of tests and measurement tasks.

**Environment:** Windows 7 32-bit, Python v2.7.5

**Description:** Open a socket, send a query, and repeat this loop for 10 times, finally close the socket. Note that SCPI command strings must be terminated with a “\n” (new line) character in programming.

Below is the code of the script:

```
#!/usr/bin/env python
#-*- coding:utf-8 -*-
#-----
# The short script is a example that open a socket, sends a query,
# print the return message and closes the socket.
#-----

import socket # for sockets
import sys # for exit
import time # for sleep

#-----

remote_ip = "10.11.13.40" # should match the instrument's IP address
port = 5025 # the port number of the instrument service
count = 0

def SocketConnect():
    try:
        #create an AF_INET, STREAM socket (TCP)
        s = socket.socket(socket.AF_INET, socket.SOCK_STREAM)
    except socket.error:
        print ('Failed to create socket.')
        sys.exit();
    try:
        #Connect to remote server
        s.connect((remote_ip , port))
    except socket.error:
        print ('failed to connect to ip ' + remote_ip)
```

```
    return s

def SocketQuery(Sock, cmd):
    try :
        #Send cmd string
        Sock.sendall(cmd)
        time.sleep(1)
    except socket.error:
        #Send failed
        print ('Send failed')
        sys.exit()
    reply = Sock.recv(4096)
    return reply

def SocketClose(Sock):
    #close the socket
    Sock.close()
    time.sleep(.300)

def main():
    global remote_ip
    global port
    global count

    # Body: send the SCPI commands *IDN? 10 times and print the return message
    s = SocketConnect()
    for i in range(10):
        qStr = SocketQuery(s, b'*IDN?\n')
        print (str(count) + ":: " + str(qStr))
        count = count + 1
    SocketClose(s)
    input('Press "Enter" to exit')

if __name__ == '__main__':
    proc = main()
```

**Run result:**

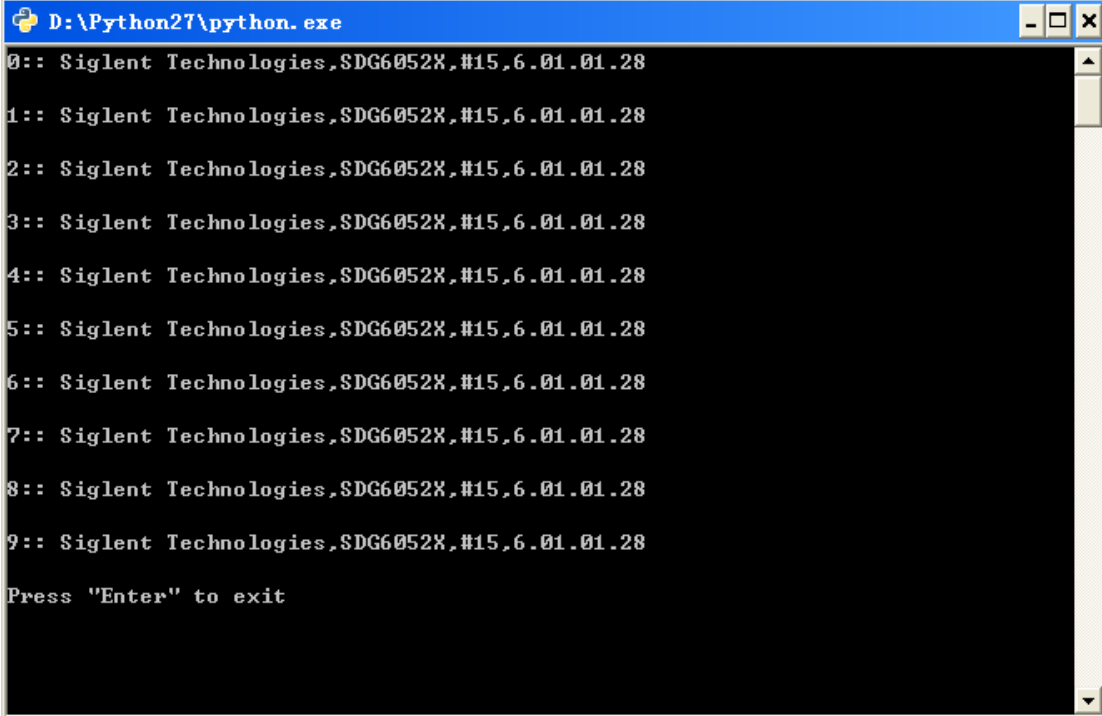

```
D:\Python27\python.exe
0:: Siglent Technologies,SDG6052X,#15,6.01.01.28
1:: Siglent Technologies,SDG6052X,#15,6.01.01.28
2:: Siglent Technologies,SDG6052X,#15,6.01.01.28
3:: Siglent Technologies,SDG6052X,#15,6.01.01.28
4:: Siglent Technologies,SDG6052X,#15,6.01.01.28
5:: Siglent Technologies,SDG6052X,#15,6.01.01.28
6:: Siglent Technologies,SDG6052X,#15,6.01.01.28
7:: Siglent Technologies,SDG6052X,#15,6.01.01.28
8:: Siglent Technologies,SDG6052X,#15,6.01.01.28
9:: Siglent Technologies,SDG6052X,#15,6.01.01.28
Press "Enter" to exit
```



## 5 Index

[\\*IDN](#)

[\\*OPC](#)

[\\*RST](#)

### A

[ARWV ArbWaVe](#)

### B

[BSWV BaSic\\_WaVe](#)

[BTWV BursTWaVe](#)

[BUZZ BUZZer](#)

### C

[CASCADE](#)

[CHDR Comm\\_HeaDeR](#)

[COUP COUPling](#)

[CMBN CoMBiNe](#)

### F

[FCNT FreqCouNter](#)

### H

[HARM HARMonic](#)

### I

[IQ:CENT IQ:CENTerfreq](#)

[IQ:SAMP IQ:SAMPlerate](#)

[IQ:SYMB IQ:SYMBolrate](#)

[IQ:AMPL IQ:AMPLitude](#)

[IQ:IQAD:GAIN IQ:IQADjustment:GAIN](#)

[IQ:IQAD:IOFFset IQ:IQADjustment:IOFFset](#)

[IQ:IQAD:QOFFset IQ:IQADjustment:QOFFset](#)

[IQ:IQAD:QSK IQ:IQADjustment:QSKew](#)

[IQ:TRIG:SOUR IQ:TRIGger:SOURce](#)

[IQ:WAVE:BUIL IQ:WAVEload:BUILtin](#)

[IQ:WAVE:USER IQ:WAVEload:USERstored](#)

[IQ:FrequencySampling IQ:FrequencySampling](#)

[IVNT INVERT](#)

### L

[LAGG](#) [LAnGuaGe](#)

**M**

[MDWV](#) [MoDulateWaVe](#)

[MODE](#) [MODE](#)

**N**

[NBFM](#) [NumBer ForMat](#)

**O**

[OUTP](#) [OUTPut](#)

**P**

[PACP](#) [ParaCoPy](#)

**R**

[ROSC](#) [ROSCillator](#)

**S**

[SCFG](#) [Sys CFG](#)

[SCSV](#) [SCreen SaVe](#)

[SWWV](#) [SweepWaVe](#)

[SYNC](#) [SYNC](#)

[STL](#) [StoreList](#)

[SYST:COMM:LAN:IPAD](#) [SYSTem:COMMunicate:LAN:IPADdress](#)

[SYST:COMM:LAN:SMAS](#) [SYSTem:COMMunicate:LAN:SMASk](#)

[SYST:COMM :LAN:GAT](#) [SYSTem:COMMunicate:LAN:GATeway](#)

[SRATE](#) [SampleRATE](#)

**W**

[WVDT](#) [WVDT](#)

**V**

[VOLTPRT](#) [VOLTPRT](#)

[VKEY](#) [VirtualKEY](#)

## About SIGLENT

SIGLENT is an international high-tech company, concentrating on R&D, sales, production and services of electronic test & measurement instruments.

SIGLENT first began developing digital oscilloscopes independently in 2002. After more than a decade of continuous development, SIGLENT has extended its product line to include digital oscilloscopes, function/arbitrary waveform generators, RF generators, digital multimeters, DC power supplies, spectrum analyzers, vector network analyzers, isolated handheld oscilloscopes, electronic load and other general purpose test instrumentation. Since its first oscilloscope, the ADS7000 series, was launched in 2005, SIGLENT has become the fastest growing manufacturer of digital oscilloscopes. We firmly believe that today SIGLENT is the best value in electronic test & measurement.

### Headquarters:

SIGLENT Technologies Co., Ltd  
Add: Bldg No.4 & No.5, Antongda Industrial  
Zone, 3rd Liuxian Road, Bao'an District,  
Shenzhen, 518101, China  
Tel: + 86 755 3688 7876  
Fax: + 86 755 3359 1582  
Email: sales@siglent.com  
Website: int.siglent.com

### USA:

SIGLENT Technologies America, Inc  
6557 Cochran Rd Solon, Ohio 44139  
Tel: 440-398-5800  
Toll Free: 877-515-5551  
Fax: 440-399-1211  
Email: info@siglent.com  
Website: www.siglentna.com

### Europe:

SIGLENT Technologies Germany GmbH  
Add: Liebigstrasse 2-20, Gebaeude 14,  
22113 Hamburg Germany  
Tel: +49(0)-819-95946  
Fax: +49(0)-819-95947  
Email: info-eu@siglent.com  
Website: www.siglenteu.com

Follow us on  
Facebook: SiglentTech

