

# SPS5000X Series

## Wide Range Programmable Switching DC Power Supply

### QuickStart





# Contents

Copyright Notice .....	2
Safety Guidelines .....	3
General Inspection .....	4
Preparation Before Use .....	5
Quick Start .....	6
Front Panel .....	8
Back Panel .....	12
User Interface .....	15
Basic Operation .....	18
Remote .....	22
More Information .....	23
Troubleshooting .....	24

# Copyright Notice

## Copyright

SIGLENT TECHNOLOGIES CO., LTD.

## Trademark information

SIGLENT is a registered trademark of Shenzhen SIGLENT Technology Co., Ltd

## Notice

- Our products are protected by the patent of the people's Republic of China which has been approved and is still being approved.
- The company reserves the right to change specifications and prices.
- The information provided in this manual replaces all previously published materials.
- Without the consent of the company, the contents of this manual may not be copied, excerpted or translated in any form or method.

## Product certification

SIGLENT certified that this product meets China's national product standards and industry product standards, and further certified that this product meets the relevant standards of other international standards organization members.

## Contact us

SIGLENT TECHNOLOGIES CO., LTD.

Address: Blog No.4 & No.5, Antongda Industrial Zone, 3rd Liuxian Road, Bao'an District, Shenzhen, 518101, China.

Tel: 400-878-0807

E-mail:Service@siglent.com

Http://www.siglent.com

## Safety Guidelines

Understand the following safety precautions to avoid personal injury and prevent damage to this product or any other products connected to it. In order to avoid possible dangers, please use this product in accordance with regulations.

**Only qualified technicians can perform maintenance procedures.**

**Prevent fire or personal injury.**

**Use proper power cord**—— Only use the power cord for this product approved by your country.

**Ground the product**—— This product is grounded through the grounding conductor of the power cord. In order to prevent electric shock, the grounding conductor must be connected to the earth. Before connecting to the input or output terminal of this product, be sure to properly ground the product.

**Connect the output cable correctly**—— Do not connect the ground wire to high voltage. During the test, do not touch the exposed contacts and components.

**View the ratings of all terminals**—— To prevent the risk of fire or electric shock, please check all ratings and marking instructions for this product. Before connecting the product, please read this product manual for further information about the ratings.

**Do not operate when you suspect that the product is malfunctioning**—— If you suspect that this product is damaged, please have it inspected by qualified maintenance personnel.

**Avoid exposed circuits**—— Do not touch the exposed connectors and components after the power is turned on.

**Do not operate in a humid environment.**

**Do not operate in a flammable and explosive environment.**

**Keep the product surface clean and dry.**

### Safety Symbols

**-DANGER:** Indicates that there is a direct risk of injury near the mark.

**-WARNING:** Indicates that there is a potential risk of injury near the mark.

**-CAUTION:** Indicates potential danger to this product and other properties.



DANGER High Voltage



CAUTION



Protective terminal



Grounded

## General Inspection

When you get a new power supply, it is recommended that you check it step by step as follows.

**Check if there is any damage caused by transportation problems.**

If you find that the packing box or the foam protective pad is seriously damaged, please keep it until the whole machine and accessories pass the electrical and mechanical tests.

**Check the whole machine**

If the external damage of the instrument is found and the corresponding test fails, please contact the SIGLENT distributor or local office responsible for this business. SIGLENT will arrange for repair or replacement of the new machine.

**Check the attachment**

Regarding the details of the accessories provided, there are detailed instructions in the "packing list", you can refer to this to check whether the accessories are complete. If you find any accessories are missing or damaged, please contact the SIGLENT distributor or local office responsible for this business

# Preparation Before Use

## Connect AC power

According to the machine you get, please use the power cord provided in the accessories to connect to the power source as follows.



Figure 1- 1 Type I

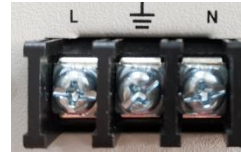

Figure 1- 2 Type II

## Connection method

- Type I /10A: applicable models 360W and 720W

The specification of the equipment that can input AC power is:100~240V, 47~63Hz.

Use the power cord provided in the accessories to directly plug into the power interface.

- Type II/16A: applicable models 1080W

The specification of the equipment that can input AC power is:100~240V, 47~63Hz. The power cord connection method provided by the accessories:

*Black/Brown*: live wire, connect to L port

*White/Blue*: neutral line, connected to port N

*Green/Green-yellow*: ground wire, connected to GND port

Note:

After connecting the input line, lock the safety cover.



American Standard



European standard

Figure 1- 3 II Wiring diagram

# Quick Start

## Technical specifications

For detailed technical specifications, please refer to the data sheet of SIGLENT's official website ([www.siglent.com](http://www.siglent.com))

### The main parameters

Number of output channels	1/2/3
Output voltage	40V/50V/80V/160V
Output current	7.5A/10A/15A/22.5A/30A/45A/60A/90A
Output power	180W/360W/720W/1080W
Power ratio	3.33

## Standard accessories:

- One SPS power supply
- An international AC power cord
- A quick start manual
- A USB data cable
- 10A output line: red×1, black×1
- Output terminal cover



The SPS5000X series includes 16 models, with 4 voltage output types: 40V/50V/80V/160V, with up to three output channels:

Model	Type	Channel number(/CH)	Rated voltage (V)	Rated current(A)	power(W)
SPS5041X	I	1	0~40	0~30	360
SPS5042X	II	1	0~40	0~60	720
SPS5043X	III	1	0~40	0~90	1080
SPS5044X	IV	2	0~40/CH	0~30/CH	360/CH
SPS5045X	V	3	0~40/CH	0~30/CH	360/CH
SPS5051X	I	1	0~50	0~10	180
SPS5081X	I	1	0~80	0~15	360
SPS5082X	II	1	0~80	0~30	720
SPS5083X	III	1	0~80	0~45	1080
SPS5084X	IV	2	0~80/CH	0~15/CH	360/CH
SPS5085X	V	3	0~80/CH	0~15/CH	360/CH
SPS5161X	I	1	0~160	0~7.5	360
SPS5162X	II	1	0~160	0~15	720
SPS5163X	III	1	0~160	0~22.5	1080
SPS5164X	IV	2	0~160/CH	0~7.5/CH	360/CH
SPS5165X	V	3	0~160/CH	0~7.5/CH	360/CH

## Front Panel

Type III/Type V:



- A** Screen
- B** Button
- C** Knob
- D** USB Host port
- E** Panel
- F** Power switch
- G** Stand
- H** Front output port

Type I :











Type II/TypeIV:



## A Screen

Equipped with a 2.4-inch OLED display for displaying system output status, system parameter settings, menu options, and promotion information.

## B Button

	Used to view system information and configure power parameters.
	In the main interface, press this key to select and set the output voltage value or output current value. Press this key in the function area to enter the next menu, which is equivalent to the confirm key.
	Press <b>Menu</b> to enter the menu list, press this key to return to the previous menu. When the power supply enters the protection state, long press the key to release the protection mode
	Press this key to enter the List mode, you can set each group of output current, output voltage and running time, etc. Press this key again to exit the List interface
	Press this key to turn on the keyboard lock function, long press to release the key lock.
	Used to recall or store the state. If you select List, press this key to store or recall the List state.
	Power output button, used to turn the output on or off.
	The direction buttons are used to switch the digits of the value where the cursor is selected, and to move the cursor position or switch options.

### **C Direction knob**

When setting parameters, turn the knob to increase or decrease the value at the cursor.

When setting objects (voltage or current, operation mode, internal resistance configuration, etc.), rotate the knob to quickly move the cursor position or switch options, press the knob to set the current parameters, rotate the knob to increase or decrease the value at the cursor, and press again to make the current setting effective.

### **D USB A port**

Used to insert peripheral USB devices for file transfer and system upgrades.

### **F Power Switch**

Used to turn the power on or off.

### **H Front output port (positive (+), negative (-))**

The current output front port can output a maximum current of 10A.

The front and rear outputs cannot be used at the same time. When the front output is connected to a load, the rear port should not be connected to a load.

# Back Panel

Type V:

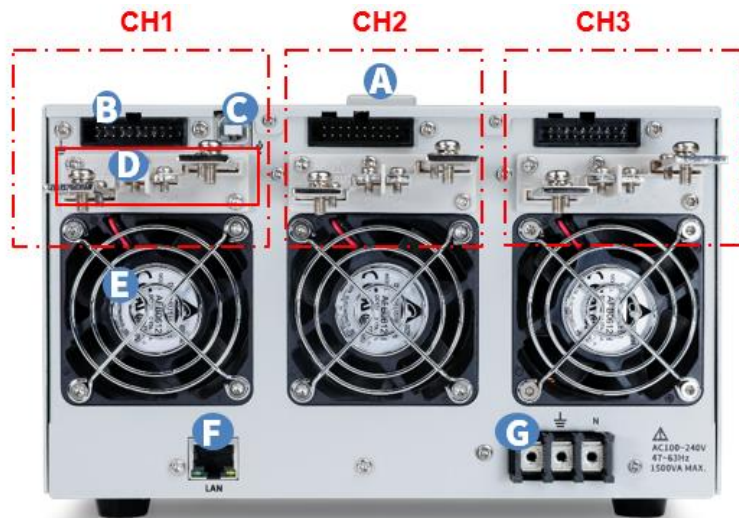

- A** Handle
- B** Analog connector port
- C** USB Device port
- D** Output Interfac
- E** Fan port
- F** LAN port
- G** AC power interface

Type I :



Type II :



### **B Analog connector port**

Used to detect the output of voltage and current, and also used for analog control of current and voltage output.

### **C USB Device port**

This interface can be connected to a PC to realize USBTMC communication, and control the power supply by sending commands through the upper computer software.

### **D Output Interface**

One set of positive (+) and negative (-) output terminals, type IV has two output ports, and type V has three output ports. With multiple output channels, face up to the power supply from right to left, the one near the display is CH1, then CH2, CH3.

### **E Fan port**

The temperature-controlled fan can effectively dissipate the heat of the power supply line.

### **F LAN port**

Used to connect the power supply to the computer or the network where the computer is located. SPS5000X conforms to the VXI-11 instrument standard, and supports Socket-based and remote commands, and remote control using WEB. It can quickly build a test system with other standard equipment and easily achieve system integration.

### **G AC power interface**

The AC power supply supports 100 ~ 240V, 47Hz ~ 63Hz. Please use the power cord provided in the attachment to connect to AC power supply. For different types of power interface connection, please refer to [7.1].



## User Interface

The SPS5000X series has three different user interfaces according to different output channels:

Type I /Type II/Type III:

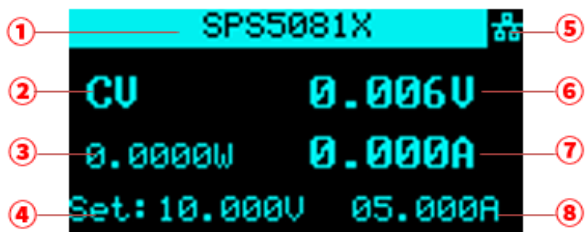

Type V:

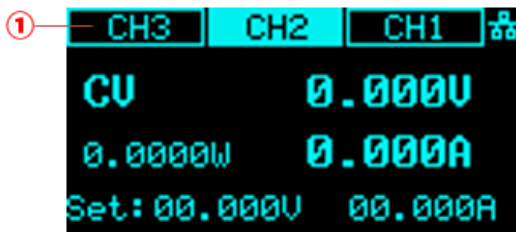

- ① For single-channel models, the status bar here displays the machine model information, if it is multi-channel, the status of each channel is displayed here.  
Channel status can be configured, operation method: **Menu** → **Configure** → **Channel Mode**, When set to Off, the status is displayed as **!XCH2**, At this time, the output of the channel is closed, and the voltage and current cannot be output normally.
- ② Display the working mode of the power supply.
- ③ The output power value of the power supply.
- ④ The setting value of the voltage, you can set the size of the output voltage value, the method: press the **Set** key to switch the cursor position, press the left and right direction keys to switch the cursor to the number of digits, turn the knob to increase or decrease the value, press the knob to confirm.
- ⑤ Display the status of LAN network port or peripheral USB access. When the network cable is connected or the U disk is inserted, the highlight here  
**U** Indicates that a U disk has been read, **LAN** Indicates that the LAN cable is connected
- ⑥ The output voltage value of the power supply

- ⑦ The output current value of the power supply
- ⑧ The setting value of the current, you can set the size of the output current value,  
Operation method: Press the Set key to switch the cursor position, press the left and right direction keys to switch the cursor to the number odigits, turn the knob to increase or decrease the value, press the knob to confirm.

List interface:

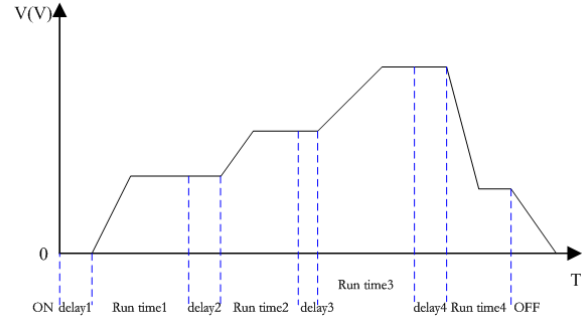
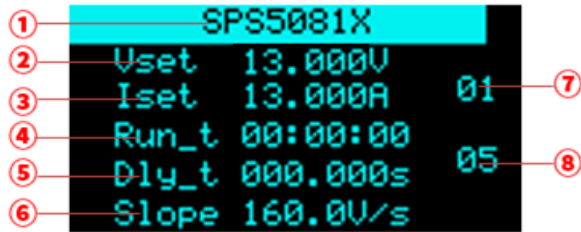

- ① For single-channel models, the status bar displays the machine model; for multi-channel models, the current channel is displayed here. You can press the left and right direction keys to select.
- ② Set the voltage to be output. After pressing the knob, move the cursor to here, and select the knob to change the value.
- ③ Set the size of the current to be output, press the knob and move the cursor to here, select the knob to change the value.
- ④ Run time
- ⑤ Delay time of current step.

⑥ Slope. The same rising and falling slope of the current step.

⑦ Number of List groups in the current setting interface, 01 means the first group.

Setting method: In the List setting interface, press the key when the cursor is hidden to switch the current group number interface.

⑧ Total number of steps, the total number of steps output by List, 05 means there are 5 sets of data

Setting method: In the List setting interface, move the cursor to here, turn the knob to change the value, and press the knob to confirm the setting is successful.

# Basic Operation

## View system information

Users can view the system information through Menu -> System -> Version, and the contents to be viewed include:

- Boot times
- Supplier name
- Product model
- Specifications
- Serial number
- Software version
- Hardware version

## Upgrade

Please follow the steps below to upgrade:

1. Download the upgrade package from the official website.
2. Copy the .ADS file in the upgrade package to the root directory of the U disk.
3. Insert the U disk into the USB port, press **Menu** -> **System** -> **Upgrade** and select the upgrade file;
4. Press the button to confirm and the upgrade progress bar will pop up. After the upgrade is successful, it will restart, and if it fails, a prompt box will pop up.

Any operation that interrupts the upgrade process may cause the upgrade to fail or even the machine cannot start. Please keep the U disk in a stable state and the machine's power supply status during the upgrade process.

## Voltage and current setting

By pressing the **Set** key, the cursor appears at the voltage setting. Press the **Set** key again to switch the cursor to the current setting. Press the left and right direction key **←** to switch the position of the cursor. Select the knob to change the value. After setting, press the knob Confirm, the setting is complete. Multi-channel model: After hiding the cursor, press **↔** to switch the channel selection. The background of the channel in the upper status bar is highlighted to indicate that it is selected. Operate as above.

## List setting

For single-channel models, press the **List** key on the panel to enter the List setting interface, press the knob or the **Set** key, and the selection cursor appears. At this time, press the up and down direction key **▲▼** to switch the cursor to the parameter to be set, and press the left and right direction keys to switch the cursor position number. When the cursor is hidden, press **▲▼** to turn the page and realize the setting of different groups of List output parameters. For multi-channel models, after setting the channel mode to List mode in **Menu** → **Configure** → **Channel Mode**, set the List parameters as above.

## Other configuration setting

Users can configure the system function through **Menu** → **Configure**:

### 1. Protect

Set the overvoltage protection (OVP) value and overcurrent protection value (OCP), and the ON/OFF of OCP.

### 2. Shunt

When set to Off, the internal bleeder circuit does not work.

### 3. Operating mode

You can set the power mode to CC or CV mode, and set the priority mode to high speed priority or slope priority. When it is set to slope priority, you can also set the slope value.

### 4. Output delay

On\_dly: output delay when output is turned on, Off\_dly: turn off delay when turning off the output.

### 5. Output resistance

It is equivalent to a resistor in series on the output terminal.

### 6. Measure average

Set the average number of readback parameters, three modes of Low, Mid, and High can be set.

### 7. Voltage control

The parameters Local, Ext\_V (external voltage 0-10V control), Ext\_R (external resistance 0-10K control) can be set.

### 8. Current control

Parameters can be set Local, Ext\_V (external voltage 0-10V control), Ext\_R (external resistance 0-10K control).

### 9. Ext on/off

Set the external control ON/OFF switch. When it is set to ON, the output is controlled by the low level of the rear analog interface pin15, and the output button on the front panel is invalid

## 10. Channel Mode

Multi-channel model configuration options, the parameters that can be set are Off, Normal, and List.

11. **M/S mode settings** One in series: the master is set to Master/series through System → M/S mode settings, and one slave is set to Slave/series through System → M/S mode settings.

One in parallel: the master is set to Master/Parallel1 through System → M/S mode settings, and one slave is set to Slave/Parallel through System → M/S mode settings.

Connect two units in parallel: the master is set to Master/Parallel2 through System → M/S mode settings, and the two slaves are set to Slave/Parallel through System → M/S mode settings

## Rear Analog Interface Wiring Method

### One in series

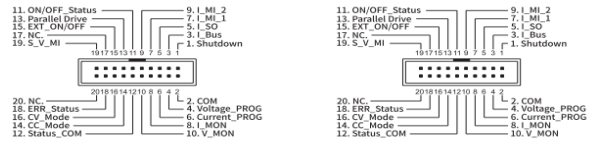
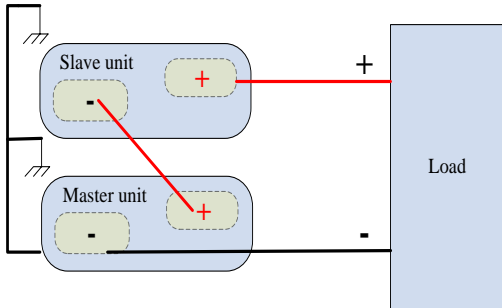

**A: Master**

**B: Slave**

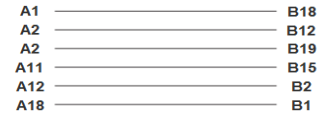

## Connect two units in parallel

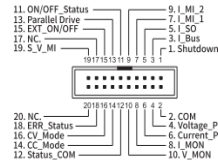
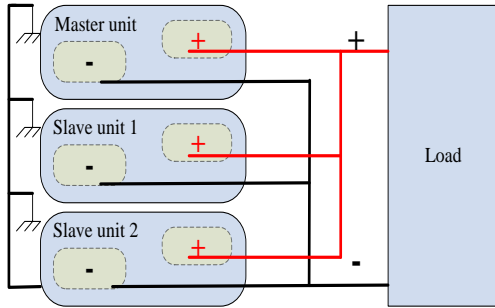

**A:Master**

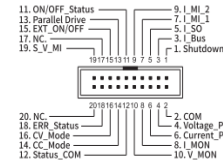

**B:Slave**

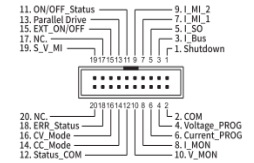

**C:Slave**

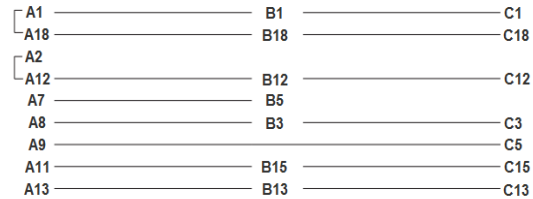

# Remote

Based on the SCPI (Standard Commands for Programmable Instruments) command set, the power supply supports communication with the computer via USB, LAN, and GPIB-USB interfaces to realize remote control.

Press **Menu** → **Communication** to configure the remote control parameters of the power supply

1. View the USB resource information of the power supply.
2. View and configure GPIB address.
3. LAN parameter settings, you can set the DHCP switch, IP address, gateway address and subnet mask address.

**Method:** after entering the LAN interface, press the knob and press to move the cursor position up and down. When is displayed, it means that the selected is On, and the IP is automatically obtained at this time. Turn the knob to switch On/Off, and press the knob to confirm the effect.

To manually set the IP, first set DHCP to Off according to the above method, press the knob to select Off, press the knob again and press **▲▼** to move the cursor up and down, the key **←→** can move the cursor left and right, turn the knob to change the value, press the knob Confirmation takes effect.

## Web Service

Enter the IP address set on the machine directly into the Google browser to enter the web interface to achieve remote control of the power supply.

The screenshot displays the web interface for the power supply. On the left is a navigation menu with 'Home', 'Configure', and 'About' options. The main content area is divided into two sections: 'Main settings' and 'List settings'.

**Main settings**

	State	Voltage(V)	Current(A)	Power(W)	Channel Enabled	List	Vset(V)	Iset(A)	Output
CH1	CV	1.157	0.188	0.219	On	()	0	0.5	On
CH2	CC	0.000	0.000	0.000	Off	()	0	0	Off
CH3	CC	0.000	0.000	0.000	Off	()	0	0	Off

**List settings**

Full step: 0    On    Off    Off

Buttons: Load    Stop    Load

Step	Vset(V)	Iset(A)	Delay Time(s)	Running Time(s)	Standby(s)	Operation

After setting the parameters, click **Submit** with the mouse and then the data will be sent to the power supply.



## More Information

For more information about this product, please refer to the following manual:

(you can log in to the SIGLENT website to download [Http://www.siglent.com](http://www.siglent.com))

“*SPS5000X User Manual*” Provide a detailed description of the functions of this product, as well as a detailed description of the SCPI commands and programming of this product.

“*SPS5000X Data Sheet*” Provide the main features and technical indicators of this product.

# Troubleshooting

The following lists the possible failures and troubleshooting methods during the use of the power supply. When you encounter these faults, please follow the corresponding steps to deal with them. If you cannot deal with them, please contact SIGLENT in time.

1. If you press the power button, the power is still black without any display:
  - (1) Check whether the power connector is properly connected
  - (2) After checking, please restart the power.
  - (3) If the power supply still cannot be started normally, please contact SIGLENT.
2. Press Output without voltage output
  - (1) Check whether the voltage and current settings are correct
  - (2) Check whether it is in host mode, whether EXT on/off is in off state, Volt\_ctrl and Curr\_ctrl are in Local state, and whether the output resistance setting is reasonable. Whether the output delay time is too large or the slope mode setting is too small, which causes the output voltage to rise slowly.
  - (3) Use the default setting to reset the voltage and current output after restoring the factory settings.
  - (4) If the power supply still cannot be used normally, please contact SIGLENT.
3. U disk cannot be recognized
  - (1) Check whether the U disk device can work normally.
  - (2) Check whether the power USB HOST interface is working properly.
  - (3) Make sure that the flash-type U disk is used, and the power supply does not support hard disk-type U disk devices.
  - (4) Re-plug the U disk, or restart the power and insert the U disk again.
  - (5) If you still cannot use the U disk normally, please contact SIGLENT.



