

SSG3000X Series Signal Generator

Programming Guide

PG0803X-E01B

Contents

1.	Programming Overview	5
1.1	Build Communication	5
1.1.1	Build Communication Using VISA	5
1.1.2	Build Communication Using Sockets	8
1.1.3	Connecting the signal generator via the USB Host port.....	8
1.2	Remote Control Capabilities	9
1.2.1	User-defined Programming	9
1.2.2	Send SCPI Commands via NI-MAX.....	9
2.	SCPI Overview.....	13
2.1	Command Format	13
2.2	Symbol Instruction	13
2.3	Parameter Type	14
2.4	Command Abbreviation	15
3.	System Commands	16
3.1	IEEE Common Commands.....	16
3.1.1	Identification Query (*IDN).....	16
3.1.2	Reset (*RST).....	16
3.1.3	Clear Status (*CLS)	17
3.1.4	Standard Event Status Enable (*ESE).....	17
3.1.5	Standard Event Status Register Query (*ESR).....	17
3.1.6	Operation Complete Query (*OPC).....	18
3.1.7	Service Request Enable (*SRE)	18
3.1.8	Status Byte Query (*STB)	18
3.1.9	Wait-to-Continue (*WAI).....	19
3.1.10	Self Test Query (*TST)	19
3.2	System Subsystem.....	19
3.2.1	System Time (:SYSTem:TIME).....	19
3.2.2	System Date (:SYSTem:DATE)	20
3.2.3	IP Address (:SYSTem:COMMunicate:LAN:IPADdress).....	20
3.2.4	Gateway (:SYSTem:COMMunicate:LAN:GATeway).....	21

3.2.5	Subnet Mask (:SYSTem:COMMunicate:LAN:SMASk)	21
3.2.6	IP Config (:SYSTem:COMMunicate:LAN:TYPE)	22
3.2.7	Power On Type (:SYSTem:PON:TYPE)	22
3.2.8	10M Adjustment State (:SYSTem:REF:DAC:STAT)	22
3.2.9	Ref Osc Code (:SYSTem:REF:DAC)	23
3.2.10	Ref Osc Code Store (:SYSTem:REF:DAC:SAVE)	23
3.2.11	Ref Osc Code Load (:SYSTem:REF:DAC:LOAD)	24
3.2.12	Reset Ref Osc Code to Default (:SYSTem:REF:DAC:DEFault)	24
3.3	Preset Subsystem	25
3.3.1	Preset (:SOURce:PRESet)	25
3.3.1	System Preset (:SYSTem:PRESet)	25
3.3.2	Preset Save (:SYSTem:PRESet:SAVE)	25
3.3.3	Preset Path (:SYSTem:PRESet:PATH)	26
3.3.4	Preset Type (:SYSTem:PRESet:TYPE)	26
3.3.5	Factory Reset (:SYSTem:FDEFault)	26
3.4	Output Subsystem	27
3.4.1	RF Output (:OUTPut[:STATe])	27
3.5	Source Subsystem	27
3.5.1	[:SOURce]:FREQuency Subsystem	27
3.5.2	[:SOURce]:POWER Subsystem	30
3.5.3	[:SOURce]:SWEep Subsystem	39
3.5.4	[:SOURce]:MODulation Subsystem	50
3.5.5	[:SOURce]:AM Subsystem	51
3.5.6	[:SOURce]:FM Subsystem	53
3.5.7	[:SOURce]:PM Subsystem	56
3.5.8	[:SOURce]:PULM Subsystem	59
3.5.9	[:SOURce]:LFOutput Subsystem	68
3.5.10	[:SOURce]:LFOutput:SWEep Subsystem	71
3.6	Sense Subsystem	75
3.6.1	Sensor Info (:SENSe[:POWER]:TYPE)	75
3.6.2	Sensor State (:SENSe[:POWER]:STATus)	76
3.6.3	Measurement (:SENSe[:POWER]:VALue)	76
3.6.4	Statistics State (:SENSe[:POWER]:STATISTics:STATe)	76
3.6.5	Statistics Value (:READ[:POWER])	77
3.6.6	Statistics Max Value (:SENSe[:POWER]:STATISTics:MAX?)	77

3.6.7	Statistics Min Value (:SENSe[:POWER]:STATISTICS:MIN?)	78
3.6.8	Statistics Mean Value (:SENSe[:POWER]:STATISTICS:AVG?)	78
3.6.9	Statistics Count (:SENSe[:POWER]:STATISTICS:COUNT?)	79
3.6.10	Statistics Clear (:SENSe[:POWER]:STATISTICS:CLEAR?)	79
3.6.11	Auto Zero (:CALibration:ZERO:TYPE)	79
3.6.12	Zeroing (:SENSe[:POWER]:ZERO)	80
3.6.13	Frequency Type (:SENSe[:POWER]:SOURCE).....	80
3.6.14	Frequency (:SENSe[:POWER]:FREQUENCY).....	81
3.6.15	Level Offset State (:SENSe[:POWER]:OFFSET:STATE).....	81
3.6.16	Level Offset (:SENSe[:POWER]:OFFSET)	81
3.6.17	Average Type (:SENSe[:POWER]:FILTER:TYPE).....	82
3.6.18	Average Times (:SENSe[:POWER]:FILTER:LENGTH)	82
3.6.19	Internal Noise (:SENSe[:POWER]:FILTER:NSRATIO)	83
3.6.20	Logging (:SENSe[:POWER]:LOGGING:STATE).....	83
4.	Programming Examples.....	84
4.1	Examples of Using VISA	84
4.1.1	Example of VC++	84
4.1.2	Example of VB	90
4.1.3	Example of MATLAB	94
4.1.4	Example of LabVIEW	96
4.2	Examples of Using Socket.....	98
4.2.1	Example of Python.....	98
4.2.2	Example of Telnet	100

1. Programming Overview

SSG3000X support both USB and LAN interfaces. By using these interfaces, in combination with NI-VISA and programming languages, users can remotely control the signal generator. Through LAN interface, VXI-11, Sockets and Telnet protocols can be used to communicate with the signal generator. This chapter introduces how to build communication between the signal generator and the PC. It also introduces the remote control capabilities.

1.1 Build Communication

1.1.1 Build Communication Using VISA

1、 Install NI-VISA

Before programming, you need to install NI-VISA, which you can download from the NI-VISA web site. About NI-VISA, there are full version and Run-Time Engine version. The full version includes the NI device driver and a tool named NI MAX that is a user interface to control the device. The Run-Time Engine version which is much smaller than the full version only include NI device driver.

For example, you can get NI-VISA 5.4 full version from: <http://www.ni.com/download/ni-visa-5.4/4230/en/>.

You can also download NI-VISA Run-Time Engine 5.4 to your PC and install it as default selection. Its installation process is similar with the full version.

After you downloaded the file you can follow the steps below to install it:

a. Double click the visa540_full.exe, dialog shown as below:

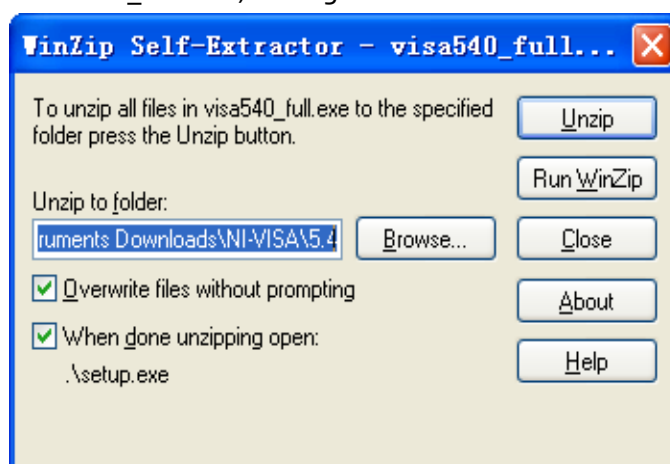

b. Click Unzip, the installation process will automatically launch after unzipping files. If your computer needs to install .NET Framework 4, its setup process will auto start.



c. The NI-VISA installing dialog is shown above. Click Next to start the installation process.

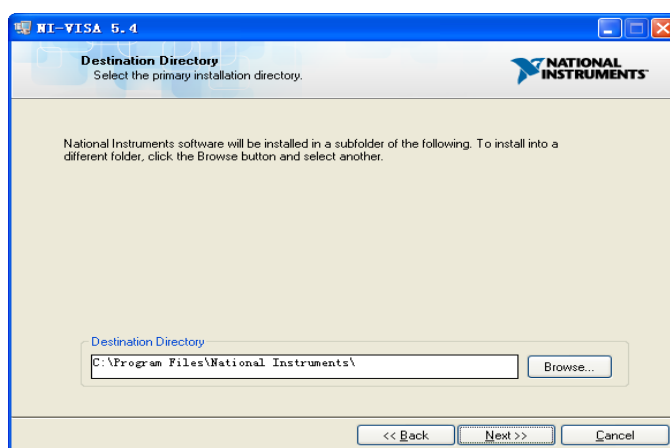

Set the install path, default path is "C:\Program Files\National Instruments\" , you can change it. Click Next, dialog shown as above.

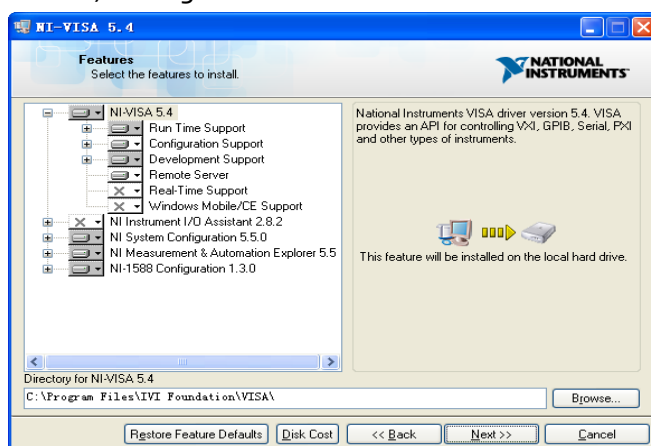

d. Click Next twice, in the License Agreement dialog, select the "I accept the above 2 License Agreement(s)." ,and click Next, dialog shown as below:

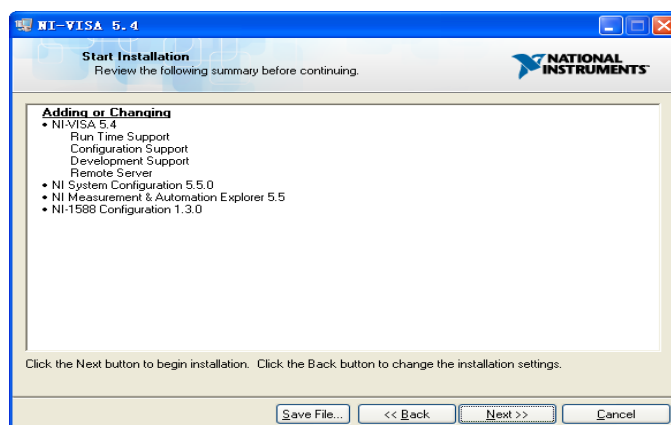

e. Click Next to run installation.

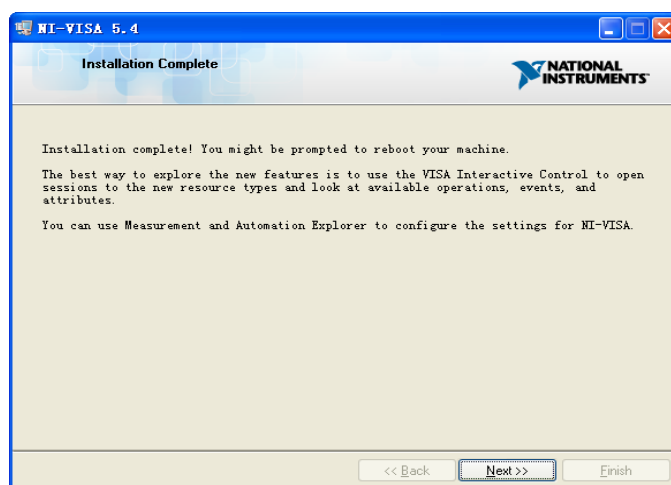

Now the installation is complete, reboot your PC.

2、 Connect the Instrument

Depending on your specific model your signal generator may be able to communicate with a PC through the USB or LAN interface. This manual takes the USB as an example. (For instructions to communicate with a PC through the LAN interface see the User Manual.)

a. Connect the USB Device interface at the rear panel of the signal generator and the USB Host interface of the PC using a USB cable. Assuming your PC is already turned on, turn on your signal generator and your PC will display the "Device Setup" screen as it automatically installs the device driver as shown below.

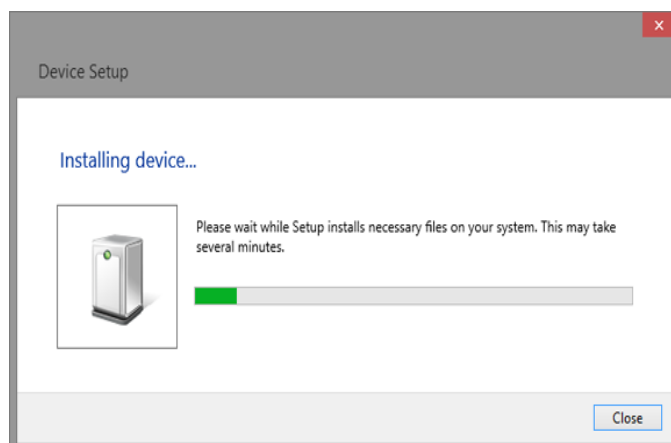

b. Wait for the installation to complete and then proceed to the next step.

1.1.2 Build Communication Using Sockets

Sockets LAN is a method used to communicate with the signal generator over the LAN interface using the Transmission Control Protocol/Internet Protocol (TCP/IP). A socket is a fundamental technology used for computer networking and allows applications to communicate using standard mechanisms built into network hardware and operating systems. The method accesses a port on the signal generator from which bidirectional communication with a network computer can be established.

Before you can use sockets LAN, you must select the signal generator's sockets port number to use:

- Standard mode. Available on port 5025. Use this port for simple programming.
- Telnet mode. The telnet SCPI service is available on port 5024.

1.1.3 Connecting the signal generator via the USB Host port

Refer to the following steps to finish the connection via USB:

1. Install NI-VISA on your PC for GPIB driver.
2. Connect the signal generator USB Host port to a PC's GPIB card port, with SIGLENT USB-GPIB adaptor.



3. Switch on the signal generator
4. Press button on the front panel **System** → Interface → GPIB to enter the GPIB number.

The signal generator will be detected automatically as a new GPIB point.

1.2 Remote Control Capabilities

1.2.1 User-defined Programming

Users can use SCPI commands to program and control the signal generator. For details, refer to the introductions in “Programming Examples” .

1.2.2 Send SCPI Commands via NI-MAX

Users can control the signal generator remotely by sending SCPI commands via NI-MAX software.

1.2.2.1 Using USB

Run NI MAX software.

- 1, Click “Device and interface” at the upper left corner of the software;
- 2, Find the “USBTMC” device symbol;

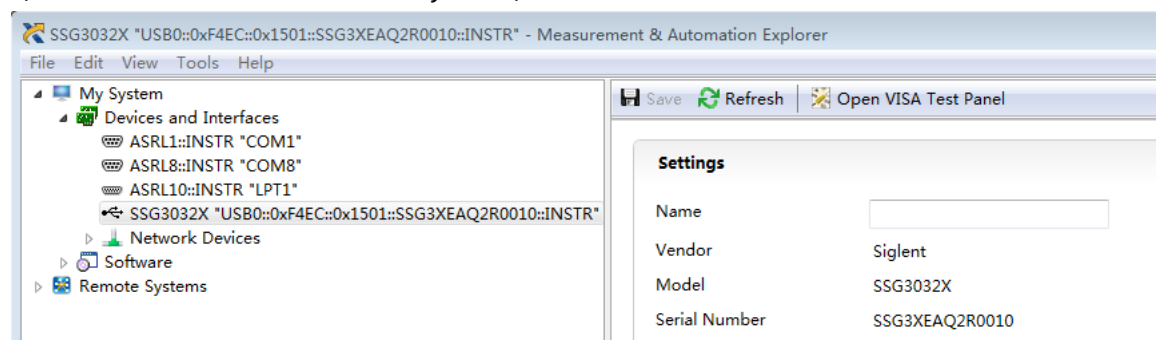

3, Click “Open VISA Test Panel” option button, then the following interface will appear;

4, Click the “Input/Output” option button and click the “Query” option button in order to view the operation information.

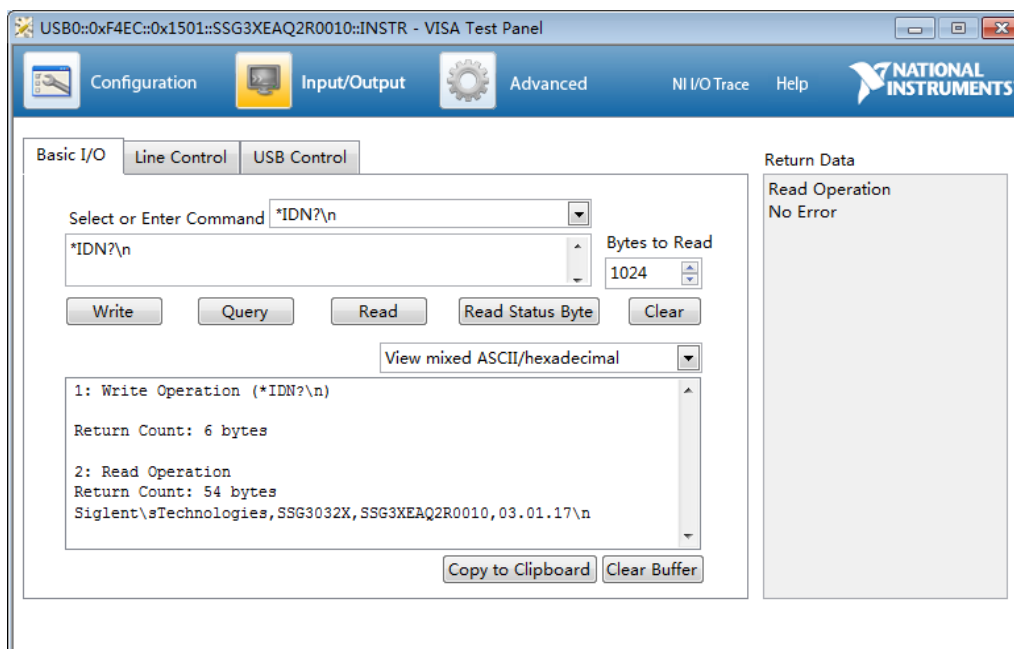

NOTE: The *IDN? command (known as the Identification Query) returns the instrument manufacturer, instrument model, serial number, and other identification information.

1.2.2.2 Using LAN

Add Network Device, and select VISA TCP/IP Resource as shown:.

Run NI MAX software.

1, Click “Device and interface” at the upper left corner of the software;

2, Find the “Network Devices” symbol, click “Add Network Devices” ;

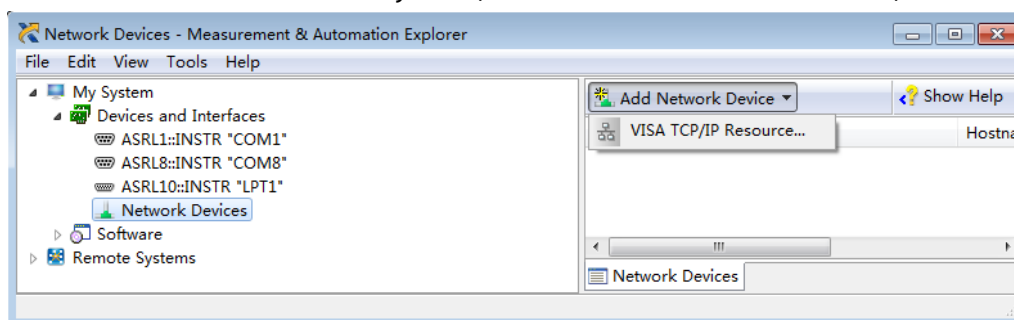

3. Select Manual Entry of LAN instrument, select Next, and enter the IP address as

shown. Click Finish to establish the connection:

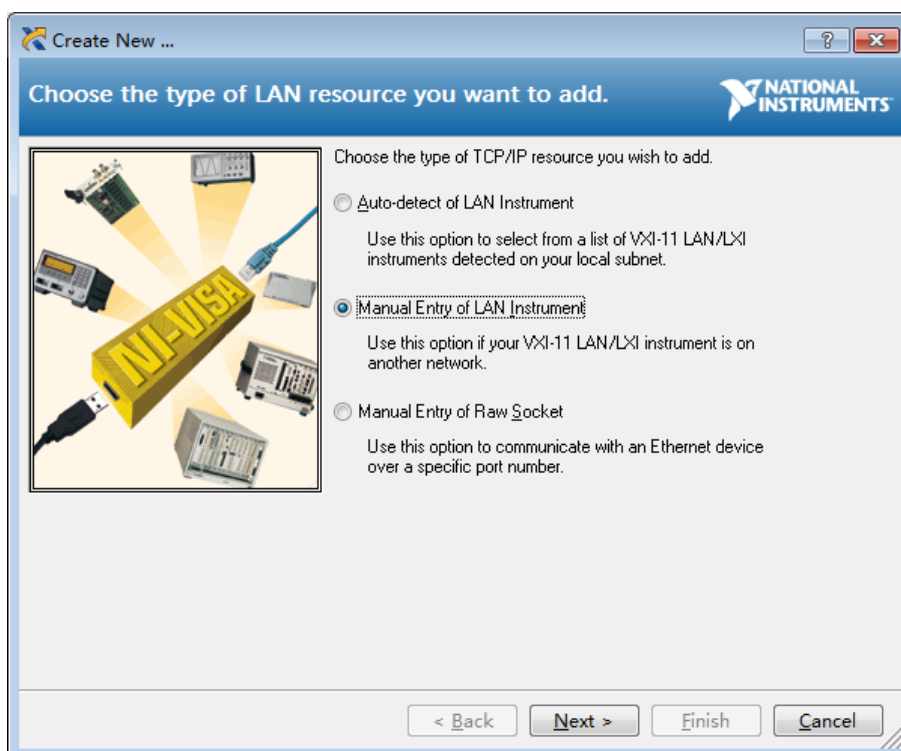

NOTE: Leave the LAN Device Name BLANK or the connection will fail.

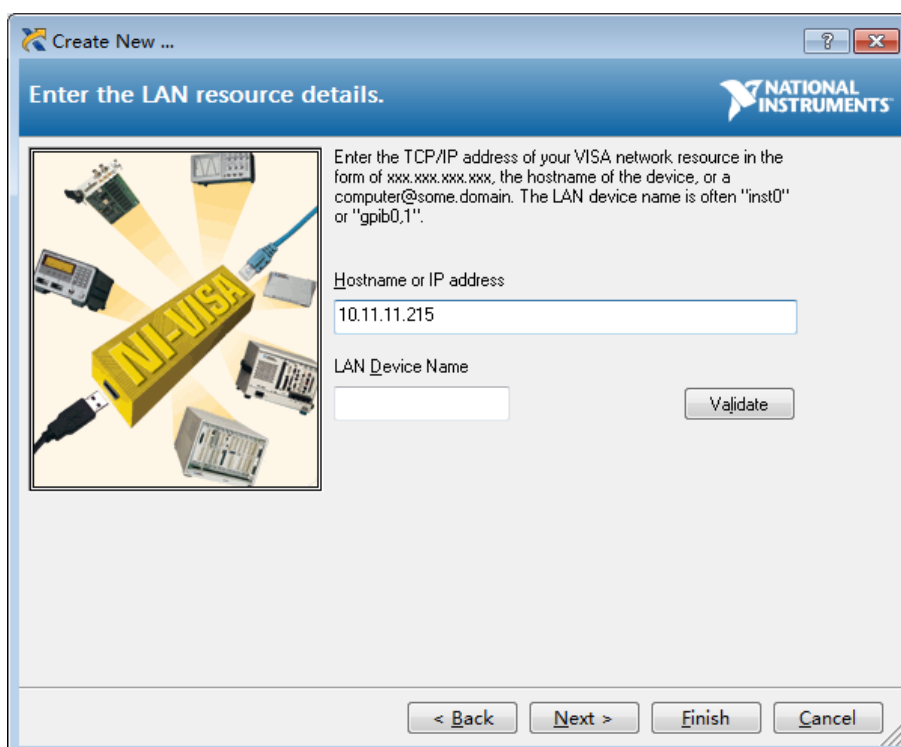

4. After a brief scan, the connection should be shown under Network Devices:

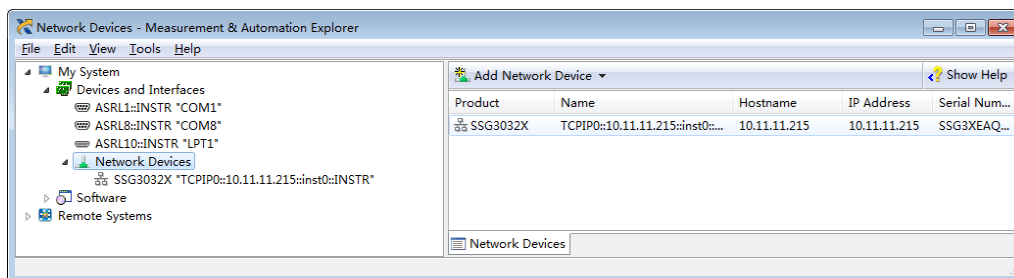

5. Right-click on the product and select Open NI-VISA Test Panel:

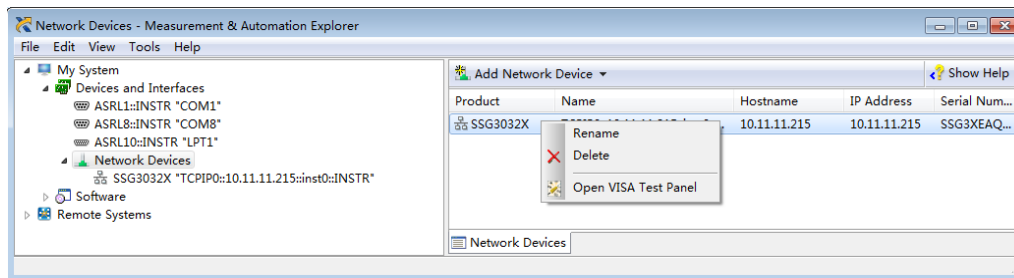

6. Click "Input/Output" option button and click "Query" option button. If everything is OK, you will see the Read operation information returned as shown below.

2.SCPI Overview

2.1 Command Format

SCPI commands present a hierarchical tree structure containing multiple subsystems, each of the subsystems is made up of a root keyword and several sub keywords. The command string usually starts with “:”, the keywords are separated by “:” and the followed parameter settings are separated by space. Query commands add “?” at the end of the string.

For example:

```
:SOURce:FREQuency <freq>
```

```
:SOURce:FREQuency?
```

SOURce is the root key of the command, FREQuency is second. The command begins with “:”, and separates the keywords at the same time, <freq> separated by space and represents the parameter available for setting; “?” represents a query.

2.2 Symbol Instruction

The following four symbols are not the content of SCPI commands and can not be sent with the commands, but are usually used in the commands.

1, Triangle Brackets < >

The parameter in the triangle brackets must be replaced by an effective value. For example:

Send the “CALibration:SPC:TARGet <power>” command in “CALibration:SPC:TARGet 0” .

2, Square Brackets []

The content in the square brackets can be ignored. When the parameter is ignored, the instrument will set the parameter to its default. For example,

In the “[:SOURce]:POWER?” command, sending any of the four commands below can generate the same effect:

```
:SOURce:POWER?
```

:POWer?

3, Vertical Bar |

The vertical bar is used to separate multiple parameters and when sending the command, you can choose one of the parameters. For example, In the “[:SOURce]:AM:STATe OFF|ON|0|1” command, the parameters available are “OFF” , “ON” , “0” or “1” .

4, Braces { }

The parameters in the braces are optional which can be ignored or set for one or more times.

2.3 Parameter Type

The parameters in the commands introduced in this manual include 6 types: boolean, enumeration, integer, float and string.

1, Boolean

The parameters in the commands could be “OFF” , “ON” , “0” or “1” . For example:

```
[:SOURce]:FM:STATe OFF|ON|0|1
```

2, Enumeration

The parameter could be any of the values listed. For example:

```
[:SOURce]:SWEep:STATe OFF|FREQuency|LEVel|LEV_FREQ
```

The parameter is “OFF” , “FREQuency” , “LEVel” or LEV_FREQ.

3, Integer

Except other notes, the parameter can be any integer within the effective value range. For example:

```
[:SOURce]:SWEep:STEP:POINts <value>
```

The parameter <value> can be set to any integer between 2 and 65535.

4, Float

The parameter could be any value within the effective value range according to the accuracy requirement (the default accuracy contains up to 9 digits after the decimal

points). For example:

```
[:SOURce]:POWer:OFFSet <value>
```

The parameter <value> can be set to any real number between -100 and 100.

5, String

The parameter should be the combinations of ASCII characters. For example:

```
:SYSTem:COMMunicate:LAN:IPADdress < "xxx.xxx.xxx.xxx" >
```

The parameter can be set as "192.168.1.12" string.

2.4 Command Abbreviation

All of the commands are not case sensitive, so you can use any of them. But if abbreviation is used, all the capital letters in the command must be written completely. For example:

```
:CORRection:FLATness:COUNT?
```

Can be abbreviated to:

```
:CORR:FLAT:COUN?
```

3. System Commands

This chapter introduces the Siglent Technologies SSG3000X SCPI commands, include:

IEEE Common Commands	3.1
System Subsystem	3.2
Preset Subsystem	3.3
Output Subsystem	3.4
Source Subsystem	3.5
Sense Subsystem	3.6

3.1 IEEE Common Commands

3.1.1 Identification Query (*IDN)

Command Format	*IDN?
Instruction	Returns an instrument identification information string. The string will contain the manufacturer, model number, serial number, software number, FPGA number and CPLD number.
Menu	None
Example	*IDN? Return: Siglent Technologies,SSG3032X,1234567890, 03.01.16r2

3.1.2 Reset (*RST)

Command Format	*RST
Instruction	This command presets the instrument to a factory defined condition that is appropriate for remote programming operation. *RST is equivalent to performing the two commands :SOURce:PRESet and *CLS. This command always performs a factory preset.
Menu	None

Example	*RST
---------	------

3.1.3 Clear Status (*CLS)

Command Format	*CLS
Instruction	Clears the status byte register. It does this by emptying the error queue and clearing all bits in all of the event registers. The status byte register summarizes the states of the other registers. It is also responsible for generating service requests.
Menu	None
Example	*CLS

3.1.4 Standard Event Status Enable (*ESE)

Command Format	*ESE <number> *ESE?
Instruction	Set the bits in the standard event status enable register. This register monitors I/O errors and synchronization conditions such as operation complete, request control, query error, device dependent error, execution error, command error and power on. A summary bit is generated on execution of the command. The query returns the state of the standard event status enable register.
Menu	None
Example	*ESE 16

3.1.5 Standard Event Status Register Query (*ESR)

Command Format	*ESR?
Instruction	Queries and clears the standard event status event register. (This is a destructive read.) The value returned reflects the current state (0/1) of all the bits in the register.
Menu	None
Example	*ESR?

3.1.6 Operation Complete Query (*OPC)

Command	*OPC
Format	*OPC?
Instruction	<p>Set bit 0 in the standard event status register to "1" when all pending operations have finished.</p> <p>The query stops any new commands from being processed until the current processing is complete. Then it returns a "1", and the program continues. This query can be used to synchronize events of other instruments on the external bus.</p> <p>Returns a "1" if the last processing is complete. Use this query when there's a need to monitor the command execution status, such as a sweep execution.</p>
Menu	None
Example	*OPC?

3.1.7 Service Request Enable (*SRE)

Command	*SRE <integer>
Format	*SRE?
Instruction	<p>This command enables the desired bits of the service request enable register.</p> <p>The query returns the value of the register, indicating which bits are currently enabled.</p>
Menu	None
Example	*SRE 1

3.1.8 Status Byte Query (*STB)

Command	*STB
Format	*STB
Instruction	This query is used by some instruments for a self test.
Menu	None
Example	*STB

3.1.9 Wait-to-Continue (*WAI)

Command Format	*WAI
Instruction	This command causes the instrument to wait until all pending commands are completed before executing any additional commands. There is no query form to the command.
Menu	None
Example	*WAI

3.1.10 Self Test Query (*TST)

Command Format	*TST?
Instruction	This query is used by some instruments for a self test.
Menu	None
Example	*TST?

3.2 System Subsystem

3.2.1 System Time (:SYSTem:TIME)

Command	:SYSTem:TIME <hhmmss>
Format	:SYSTem:TIME?
Instruction	Set System time. Get System time.
Parameter Type	String
Parameter Range	hour(0 ~ 23), minute(0 ~ 59), second(0 ~ 59)
Return	String
Default	None
Menu	Utility > Setting > Time Setting
Example	Set System time: :SYSTem:TIME 182559

	Get System time: :SYSTem:TIME?
--	-----------------------------------

3.2.2 System Date (:SYSTem:DATE)

Command	:SYSTem:DATE <yyyymmdd>
Format	:SYSTem:DATE?
Instruction	Set system date. Get system date.
Parameter Type	String
Parameter Range	year(four digits), month(1 ~ 12), date(1 ~ 31)
Return	String
Default	None
Menu	Utility > Setting > Time Setting
Example	Set System date: :SYSTem:DATE 20050101 Get System date: :SYSTem:DATE?

3.2.3 IP Address

(:SYSTem:COMMunicate:LAN:IPADdress)

Command	:SYSTem:COMMunicate:LAN:IPADdress < "xxx.xxx.xxx.xxx" >
Format	:SYSTem:COMMunicate:LAN:IPADdress?
Instruction	Set a host name for the signal generator in network. Get IP address.
Parameter Type	String
Parameter Range	Conform to the IP Sets standard(0-255:0-255:0-255:0-255)
Return	IP address string
Default	None
Menu	Utility > Interface > LAN Setting > IP Address
Example	:SYSTem:COMMunicate:LAN:IPADdress "192.168.1.12"

	:SYSTem:COMMunicate:LAN:IPADdress?
--	------------------------------------

3.2.4 Gateway (:SYSTem:COMMunicate:LAN:GATeway)

Command	:SYSTem:COMMunicate:LAN:GATeway < "xxx.xxx.xxx.xxx" >
Format	:SYSTem:COMMunicate:LAN:GATeway?
Instruction	Set the gateway for the signal generator in the network. The gateway will be fetched automatically if the IP assignment is set to DHCP. Get gateway.
Parameter Type	String
Parameter Range	Conform to the IP standard (0~255.0~255.0~255.0~255)
Return	Gateway string.
Default	None
Menu	Utility > Interface > LAN Setting > Gateway
Example	:SYSTem:COMMunicate:LAN:GATeway "192.168.1.1" :SYSTem:COMMunicate:LAN:GATeway?

3.2.5 Subnet Mask

(:SYSTem:COMMunicate:LAN:SMASK)

Command	:SYSTem:COMMunicate:LAN:SMASK < "xxx.xxx.xxx.xxx" >
Format	:SYSTem:COMMunicate:LAN:SMASK?
Instruction	Set the subnet mask according to the PC network Settings. The subnet mask will be set automatically if the IP assignment is set to DHCP.
Parameter Type	String
Parameter Range	Conform to the IP standard (0-255:0-255:0-255:0-255)
Return	Subnet mask string
Default	None
Menu	Utility > Interface > LAN Setting > Subnet Mask
Example	:SYSTem:COMMunicate:LAN:SMASK?

3.2.6 IP Config (:SYSTem:COMMunicate:LAN:TYPE)

Command	:SYSTem:COMMunicate:LAN:TYPE STATIC DHCP
Format	:SYSTem:COMMunicate:LAN:TYPE?
Instruction	Toggles the IP assignment Setting between static (manual) and DHCP (dynamic assignment) mode. Get IP config.
Parameter Type	Enumeration
Parameter Range	STATIC DHCP
Return	Enumeration
Default	None
Menu	Utility > Interface > LAN Setting > DHCP State
Example	:SYSTem:COMMunicate:LAN:TYPE DHCP :SYSTem:COMMunicate:LAN:TYPE?

3.2.7 Power On Type (:SYSTem:PON:TYPE)

Command	:SYSTem:PON:TYPE DFT LAST
Format	:SYSTem:PON:TYPE?
Instruction	Uses command to set signal generator to power on in default, last. Get power on type.
Parameter Type	Enumeration
Parameter Range	DFT LAST DFT: Default LAST: Last
Return	Enumeration
Default	DFT
Menu	Utility > Setting > Power On
Example	SYSTem:PON:TYPE DFT

3.2.8 10M Adjustment State (:SYSTem:REF:DAC:STAT)

Command	:SYSTem:REF:DAC:STAT ON OFF 1 0
Format	:SYSTem:REF:DAC:STAT?

Instruction	Set 10M Adjustment State. Get 10M Adjustment State.
Parameter Type	Boolean
Parameter Range	ON OFF 1 0
Return	Boolean
Default	0
Menu	Utility > Setting > 10M Adjustment
Example	:SYSTem:REF:DAC:STAT ON

3.2.9 Ref Osc Code (:SYSTem:REF:DAC)

Command	:SYSTem:REF:DAC <value>
Format	:SYSTem:REF:DAC?
Instruction	Set ref osc code. Get ref osc code.
Parameter Type	Int
Parameter Range	0 ~ 65535
Return	Int
Default	42885
Menu	Utility > Setting > 10M Adjustment
Example	:SYSTem:REF:DAC 43000 :SYSTem:REF:DAC?

3.2.10 Ref Osc Code Store (:SYSTem:REF:DAC:SAVE)

Command	:SYSTem:REF:DAC:SAVE <file_name>
Format	
Instruction	Save the ref osc code in file.
Parameter Type	String
Parameter Range	None

SIGLENT

Return	None
Default	None
Menu	Utility > Setting > 10M Adjustment
Example	:SYSTem:REF:DAC:SAVE test.dac

3.2.11 Ref Osc Code Load (:SYSTem:REF:DAC:LOAD)

Command Format	:SYSTem:REF:DAC:LOAD <file_name>
Instruction	Load existing ref osc code files.
Parameter Type	String
Parameter Range	None
Return	None
Default	None
Menu	Utility > Setting > 10M Adjustment > Recall Ref Osc Setting
Example	:SYSTem:REF:DAC:LOAD test.dac

3.2.12 Reset Ref Osc Code to Default (:SYSTem:REF:DAC:DEFault)

Command Format	:SYSTem:REF:DAC:DEFault
Instruction	Reset ref osc code to default value.
Parameter Type	None
Parameter Range	None
Return	None
Default	None
Menu	Utility > Setting > 10M Adjustment > Reset to Default
Example	:SYSTem:REF:DAC:DEFault

3.3 Preset Subsystem

3.3.1 Preset (:SOURce:PRESet)

Command	:SOURce:PRESet
Format	
Instruction	Presets all parameters which are related to the selected signal path.
Parameter	None
Type	
Return	None
Default	None
Menu	None
Example	SOUR:PRES

3.3.1 System Preset (:SYSTem:PRESet)

Command	:SYSTem:PRESet
Format	
Instruction	Presets all parameters.
Parameter	None
Type	
Return	None
Default	None
Menu	Utility > Preset
Example	SYSTem:PRES

3.3.2 Preset Save (:SYSTem:PRESet:SAVE)

Command	:SYSTem:PRESet:SAVE
Format	
Instruction	Save status for preset when preset type is user.
Parameter	None
Type	
Return	None
Default	None

SIGLENT

Menu	Utility > Preset
Example	:SYSTem:PRESet:SAVE

3.3.3 Preset Path (:SYSTem:PRESet:PATH)

Command	:SYSTem:PRESet:PATH <path>
Format	
Instruction	Set preset file when preset type is user.
Parameter	String
Type	
Return	None
Default	None
Menu	Utility > Preset
Example	:SYSTem:PRESet:PATH test.xml

3.3.4 Preset Type (:SYSTem:PRESet:TYPE)

Command	:SYSTem:PRESet:TYPE DFT USER
Format	:SYSTem:PRESet:TYPE?
Instruction	Uses this command to preset the signal generator to default, user. Get preset type.
Parameter	Enumeration
Type	
Parameter	DFT: Default
Range	USER: Custom Configuration
Return	Enumeration
Default	DFT
Menu	Utility > Setting > Preset Type
Example	:SYSTem:PRESet:TYPE DFT

3.3.5 Factory Reset (:SYSTem:FDEFault)

Command	:SYSTem:FDEFault
Format	
Instruction	Set both the measure and setting parameters to factory preset parameters.
Parameter	None
Type	

Parameter Range	None
Return	None
Default	None
Menu	None
Example	:SYSTem:FDEFault

3.4 Output Subsystem

3.4.1 RF Output (:OUTPut[:STATe])

Command	:OUTPut[:STATe] ON OFF 1 0
Format	:OUTPut[:STATe]?
Instruction	Activate/Deactivate the RF output. Get the RF state.
Parameter Type	Boolean
Parameter Range	ON OFF 1 0
Return	Boolean
Default	0
Menu	RF
Example	:OUTPut ON

3.5 Source Subsystem

3.5.1 [:SOURce]:FREQuency Subsystem

3.5.1.1 Frequency Display ([:SOURce]:FREQuency:DISPlay)

Command	[:SOURce]:FREQuency:DISPlay <freq>
Format	[:SOURce]:FREQuency:DISPlay?
Instruction	Set the frequency display on parameter bar.

SIGLENT

	Get the frequency display on parameter bar.
Parameter Type	Float, unit: Hz, kHz, MHz, GHz, Default "Hz"
Parameter Range	Frequency offset + Full frequency range
Return	Float, unit: Hz
Default	Maximum frequency
Menu	Freq
Example	FREQUENCY:DISPLAY 2 MHz

3.5.1.2 Frequency ([:SOURce]:FREQUENCY[:FIX])

Command	[:SOURce]:FREQUENCY[:FIX] <freq>
Format	[:SOURce]:FREQUENCY[:FIX]?
Instruction	Set the frequency of the RF output signal. Get the frequency of the RF output signal.
Parameter Type	Float, unit: Hz, kHz, MHz, GHz, Default "Hz"
Parameter Range	Full frequency range
Return	Float, unit: Hz
Default	Maximum frequency
Menu	FREQ > Frequency
Example	FREQUENCY 2 MHz

3.5.1.3 Frequency Offset ([:SOURce]:FREQUENCY:OFFSet)

Command	[:SOURce]:FREQUENCY:OFFSet <freq>
Format	[:SOURce]:FREQUENCY:OFFSet?
Instruction	Set the frequency offset of a downstream instrument. Get the frequency offset of a downstream instrument.
Parameter Type	Float, unit: Hz, kHz, MHz, GHz, Default "Hz"
Parameter Range	-200 GHz ~ 200 GHz
Return	Float, unit: Hz

Default	0 Hz
Menu	FREQ > Freq Offset
Example	FREQuency:OFFSet 2 MHz

3.5.1.4 Phase Offset ([:SOURce]:PHASe)

Command	[:SOURce]:PHASe <phase>
Format	[:SOURce]:PHASe?
Instruction	Set the phase of the RF output signal. Get the phase of the RF output signal.
Parameter Type	Float, unit: deg
Parameter Range	-360 deg ~ 360 deg
Return	Float, unit: deg
Default	0 deg
Menu	FREQ > Phase Offset
Example	PHASe 20

3.5.1.5 Phase Reset ([:SOURce]:PHASe:RESet [:SOURce]:PHASe:REF)

Command	[:SOURce]:PHASe:RESet
Format	[:SOURce]:PHASe:REF
Instruction	Set the current phase to relatively zero.
Parameter Type	None
Parameter Range	None
Return	None
Default	None
Menu	FREQ > Reset phase delta display
Example	:PHASe:RESet

3.5.2[:SOURce]:POWer Subsystem

3.5.2.1 Level Display ([:SOURce]:POWer:POWer)

Command	[:SOURce]:POWer:POWer <power>
Format	[:SOURce]:POWer:POWer?
Instruction	Set the RF level display on parameter bar. Get the RF level display on parameter bar.
Parameter Type	Float, unit: dBm, dBmV, dBuV, V, W, Default: dBm
Parameter Range	Level Offset + Full power range
Return	Float, unit: dBm
Default	-110 dBm
Menu	Level
Example	POWer:POWer 2

3.5.2.2 Level ([:SOURce]:POWer)

Command	[:SOURce]:POWer <power>
Format	[:SOURce]:POWer?
Instruction	Set the RF output level. Get the RF output level.
Parameter Type	Float, unit: dBm, dBmV, dBuV, V, W
Parameter Range	When IQ switched on: -100 dBm ~ 10 dBm Frequency between 9 kHz ~ 100 kHz: -110 dBm ~ 9 dBm Frequency between 100 kHz ~ 1 MHz: -110 dBm ~ 15 dBm Frequency above 1 MHz: -110 dBm ~ 20 dBm
Return	Float, unit: dBm
Default	-110 dBm
Menu	LEVEL > Level
Example	POWer 2

3.5.2.3 Level Offset ([:SOURce]:POWER:OFFSet)

Command	[:SOURce]:POWER:OFFSet <power>
Format	[:SOURce]:POWER:OFFSet?
Instruction	Set the RF offset level of the RF output connector. Get the RF offset level of the RF output connector.
Parameter Type	Float
Parameter Range	-100 dB ~ 100 dB
Return	Float, unit: dB
Default	0 dB
Menu	LEVEL > Level Offset
Example	POWER:OFFSet 2

3.5.2.4 ALC State ([:SOURce]:POWER:ALC)

Command	[:SOURce]:POWER:ALC ON OFF AUTO
Format	[:SOURce]:POWER:ALC?
Instruction	Activate/deactivate automatic level control. Query ALC state.
Parameter Type	Enumeration
Parameter Range	ON OFF AUTO ON Internal level control is permanently activated. OFF Internal level control is deactivated; Sample & Hold mode is activated. AUTO Internal level control is activated/deactivated automatically depending on the operating state.
Return	Enumeration
Default	AUTO
Menu	LEVEL > ALC State
Example	POWER:ALC ON

3.5.2.5 Flatness List State ([:SOURce]:CORRection[:FLATness])

Command	[:SOURce]:CORRection[:FLATness] ON OFF 1 0
Format	[:SOURce]:CORRection[:FLATness]?
Instruction	Activate/deactivate flatness.
Parameter Type	Boolean
Parameter Range	ON OFF 1 0
Return	Boolean
Default	0
Menu	LEVEL > Flatness
Example	CORRection:FLATness ON

3.5.2.6 Flatness List Add Row

([:SOURce]:CORRection:FLATness:PAIR)

Command Format	[:SOURce]:CORRection:FLATness:PAIR <freq>,<power>
Instruction	Insert a new row.
Parameter Type	Float, Float
Parameter Range	Freq: Full freq range Power: Full power range
Return	None
Default	None
Menu	LEVEL > Flatness > [+]
Example	CORRection:FLATness:PAIR 1 MHz,1

3.5.2.7 Flatness List Delete Row

([:SOURce]:CORRection:FLATness:DELeTe)

Command Format	[:SOURce]:CORRection:FLATness:DELeTe <row>
Instruction	Delete the selected row.

Parameter Type	Integer
Parameter Range	Less than the total count of the flatness.
Return	None
Default	None
Menu	LEVEL > Flatness > [-]
Example	CORRection:FLATness:DELeTe 0

3.5.2.8 Flatness List Count

([:SOURce]:CORRection:FLATness:COUNT?)

Command Format	[:SOURce]:CORRection:FLATness:COUNT?
Instruction	Indicates the total count of the flatness.
Parameter Type	None
Parameter Range	None
Return	Integer
Default	0
Menu	LEVEL > Flatness
Example	CORRection:FLATness:COUNT?

3.5.2.9 Flatness List Store ([:SOURce]:CORRection:STORE)

Command Format	[:SOURce]:CORRection:STORE <file_name>
Instruction	Save the correction data in the list.
Parameter Type	String
Parameter Range	None
Return	None
Default	None

SIGLENT

Menu	LEVEL > Flatness > Store
Example	:CORRection:STORe test.uflt

3.5.2.10 Flatness List Load ([:SOURce]:CORRection:LOAD)

Command Format	[:SOURce]:CORRection:LOAD <file_name>
Instruction	Load existing flatness correction files.
Parameter Type	String
Parameter Range	None
Return	None
Default	None
Menu	LEVEL > Flatness > Load
Example	:CORRection:LOAD test.uflt

3.5.2.11 Flatness List Clear

([:SOURce]:CORRection:FLATness:PRESet)

Command Format	[:SOURce]:CORRection:FLATness:PRESet
Instruction	Clear flatness correction list.
Parameter Type	None
Parameter Range	None
Default	None
Menu	LEVEL > Flatness > Clear
Example	:CORRection:FLATness:PRESet

3.5.2.12 Flatness List Fill Type

([:SOURce]:CORRection:FLATness:FILL:TYPE)

Command	[:SOURce]:CORRection:FLATness:FILL:TYPE FLATness MANUa SWEEPlist
---------	--

Format	[[:SOURce]:CORRection:FLATness:FILL:TYPE?
Instruction	Set the Fill Type to generate flatness list. Get the Fill Type to generate flatness list.
Parameter Type	Enumeration
Parameter Range	FLATness MANUal SWEEPlist
Return	Enumeration
Default	FLATness
Menu	LEVEL > Flatness > Set > Fill Type
Example	:CORRection:FLATness:FILL:TYPE FLATness

3.5.2.13 Flatness List Start Freq

([:SOURce]:CORRection:FLATness:STARTfreq)

Command	[[:SOURce]:CORRection:FLATness:STARTfreq <freq>
Format	[[:SOURce]:CORRection:FLATness:STARTfreq?
Instruction	Set the start frequency when you want to fill the flatness list with the sensor and filling type is "Manual Step" . Get the start frequency when you want to fill the flatness list with the sensor and filling type is "Manual Step" .
Parameter Type	Float, unit: Hz, kHz, MHz, GHz, Default "Hz"
Parameter Range	Full frequency range
Return	Float, unit: Hz
Default	Maximum frequency
Menu	LEVEL > Flatness > Set > Fill Type > Manual Step
Example	:CORRection:FLATness:STARTfreq 200 MHz

3.5.2.14 Flatness List Stop Freq

([:SOURce]:CORRection:FLATness:STOPfreq)

Command	[[:SOURce]:CORRection:FLATness:STOPfreq <freq>
Format	[[:SOURce]:CORRection:FLATness:STOPfreq?

SIGLENT

Instruction	Set the stop frequency when you want to fill the flatness list with the sensor and filling type is "Manual Step" . Get the stop frequency when you want to fill the flatness list with the sensor and filling type is "Manual Step" .
Parameter Type	Float, unit: Hz, kHz, MHz, GHz, Default "Hz"
Parameter Range	Full frequency range
Return	Float, unit: Hz
Default	Maximum frequency
Menu	LEVEL > Flatness > Set > Fill Type > Manual Step
Example	:CORRection:FLATness:STOPfreq 500 MHz

3.5.2.15 Flatness List Fill Space

([:SOURce]:CORRection:FLATness:LINStep)

Command Format	[:SOURce]:CORRection:FLATness:SPACe LINear LOGarithmic
Instruction	Set the fill space in Manual Step Fill Type. Get the fill space in Manual Step Fill Type.
Parameter Type	Enumeration
Parameter Range	LINear LOGarithmic
Return	Enumeration
Default	LINear
Menu	LEVEL > Flatness > Set > Fill Type > Manual Step
Example	:CORRection:FLATness:SPACe LINear

3.5.2.16 Flatness List Linear Step

([:SOURce]:CORRection:FLATness:LINStep)

Command Format	[:SOURce]:CORRection:FLATness:LINStep <freq>
Instruction	Set the linear frequency step in Manual Step Fill Type.

	Get the linear frequency step in Manual Step Fill Type.
Parameter Type	Float, unit: Hz, kHz, MHz, GHz, Default "Hz"
Parameter Range	None
Return	Float, unit: Hz
Default	None
Menu	LEVEL > Flatness > Set > Fill Type > Manual Step
Example	:CORRection:FLATness:LINStep 200 MHz

3.5.2.17 Flatness List Log Step

([:SOURce]:CORRection:FLATness:LOGStep)

Command	[:SOURce]:CORRection:FLATness:LOGStep <value>
Format	[:SOURce]:CORRection:FLATness:LOGStep?
Instruction	Set the log frequency step in Manual Step Fill Type. Get the log frequency step in Manual Step Fill Type.
Parameter Type	Float, unit: %
Parameter Range	None
Return	Float, unit: %
Default	None
Menu	LEVEL > Flatness > Set > Fill Type > Manual Step
Example	:CORRection:FLATness:LOGStep 20

3.5.2.18 Flatness List Points

([:SOURce]:CORRection:FLATness:POINT)

Command	[:SOURce]:CORRection:FLATness:POINT <points>
Format	[:SOURce]:CORRection:FLATness:POINT?
Instruction	Set the points of flatness list in Manual Step Fill Type. Get the points of flatness list in Manual Step Fill Type.
Parameter Type	Integer

SIGLENT

Parameter Range	2 ~ 500
Return	Integer
Default	11
Menu	LEVEL > Flatness > Set > Fill Type > Manual Step
Example	:CORRection:FLATness:POINT 5

3.5.2.19 Level Control ([:SOURce]:POWER:SPC:STATE)

Command	[:SOURce]:POWER:SPC:STATE ON OFF 1 0
Format	[:SOURce]:POWER:SPC:STATE?
Instruction	Activate/Deactivate power control using the sensor. Get level control state.
Parameter Type	Boolean
Parameter Range	ON OFF 1 0
Return	Boolean
Default	0
Menu	SENSOR > Level Control
Example	POWER:SPC:STATE ON

3.5.2.20 Target Level ([:SOURce]:POWER:SPC:TARGET)

Command	[:SOURce]:POWER:SPC:TARGET <power>
Format	[:SOURce]:POWER:SPC:TARGET?
Instruction	Set the nominal level expected at the input of the sensor. Get the nominal level expected at the input of the sensor.
Parameter Type	Float, unit: dBm, dBmV, dBuV, V, W, Default: dBm
Parameter Range	-120 dBm ~ 20 dBm
Return	Float, unit: dBm
Default	0 dBm
Menu	SENSOR > Level Control > Target Level
Example	POWER:SPC:TARGET 0

3.5.2.21 Level Limit ([:SOURce]:POWER:LIMit)

Command	[:SOURce]:POWER:LIMit <power>
Format	[:SOURce]:POWER:LIMit?
Instruction	Set an upper limit for the RF output power. Get an upper limit for the RF output power.
Parameter Type	Float, unit: dBm, dBmV, dBuV, V, W, Default: dBm
Parameter Range	-110 dBm ~ 20 dBm
Return	Float, unit: dBm
Default	0 dBm
Menu	SENSOR > Level Control > Level Limit
Example	POWER:LIMit 1

3.5.2.22 Catch Range ([:SOURce]:POWER:SPC:CRANge)

Command	[:SOURce]:POWER:SPC:CRANge <power>
Format	[:SOURce]:POWER:SPC:CRANge?
Instruction	Set the capture range of the control system. Get the capture range of the control system.
Parameter Type	Float
Parameter Range	0 dB ~ 50 dB
Return	Float, unit: dB
Default	0 dB
Menu	SENSOR > Level Control > Catch Range
Example	:POWER:SPC:CRANge 5

3.5.3[:SOURce]:SWEep Subsystem

3.5.3.1 Sweep State ([:SOURce]:SWEep:STATe)

Command	[:SOURce]:SWEep:STATe OFF FREQuency LEVe LEV_FREQ
---------	--

SIGLENT

Format	[[:SOURce]:SWEep:STATE?
Instruction	Activate frequency or/and level sweep.
Parameter	Enumeration
Type	
Parameter Range	OFF FREQUency LEVel LEV_FREQ
Return	Enumeration
Default	OFF
Menu	SWEEP > Sweep State
Example	:SWEep:STATE OFF

3.5.3.2 Sweep Type ([[:SOURce]:SWEep:TYPE])

Command	[[:SOURce]:SWEep:TYPE LIST STEP
Format	[[:SOURce]:SWEep:TYPE?
Instruction	Set sweep type. Get sweep type.
Parameter	Enumeration
Type	
Parameter Range	LIST STEP
Return	Enumeration
Default	STEP
Menu	SWEEP > Step Sweep / List Sweep
Example	:SWEep:TYPE STEP

3.5.3.3 Start Frequency

([[:SOURce]:SWEep:STEP:START:FREQUency])

Command	[[:SOURce]:SWEep:STEP:START:FREQUency <freq>
Format	[[:SOURce]:SWEep:STEP:START:FREQUency?
Instruction	Set the start frequency for the sweep mode. Get the start frequency for the sweep mode.
Parameter	Float, unit: Hz, kHz, MHz, GHz, Default "Hz"
Type	

Parameter Range	Full frequency range.
Return	Float, unit: Hz
Default	Maximum frequency
Menu	SWEEP > Step Sweep > Start Freq
Example	:SWEep:STEP:START:FREQuency 1 GHz

3.5.3.4 Stop Frequency ([:SOURce]:SWEep:STEP:STOP:FREQuency)

Command	[:SOURce]:SWEep:STEP:STOP:FREQuency <freq>
Format	[:SOURce]:SWEep:STEP:STOP:FREQuency?
Instruction	Set the stop frequency for the sweep mode. Get the stop frequency for the sweep mode.
Parameter Type	Float, unit: Hz, kHz, MHz, GHz, Default "Hz"
Parameter Range	Full frequency range.
Return	Float, unit: Hz
Default	Maximum frequency
Menu	SWEEP > Step Sweep > Stop Freq
Example	:SWEep:STEP:STOP:FREQuency 1 GHz

3.5.3.5 Start Level ([:SOURce]:SWEep:STEP:START:LEVel)

Command	[:SOURce]:SWEep:STEP:START:LEVel <level>
Format	[:SOURce]:SWEep:STEP:START:LEVel?
Instruction	Set the start level for the sweep mode. Get the start level for the sweep mode.
Parameter Type	Float, unit: dBm, dBmV, dBuV, V, W, Default: dBm
Parameter Range	Full level range.
Return	Float, unit: dBm
Default	-110 dBm
Menu	SWEEP > Step Sweep > Start Level
Example	:SWEep:STEP:START:LEVel 0 dBm

3.5.3.6 Stop Level ([:SOURce]:SWEep:STEP:STOP:LEVel)

Command	[:SOURce]:SWEep:STEP:STOP:LEVel <level>
Format	[:SOURce]:SWEep:STEP:STOP:LEVel?
Instruction	Set the stop level for the sweep mode. Get the stop level for the sweep mode.
Parameter Type	Float, unit: dBm, dBmV, dBuV, V, W, Default dBm
Parameter Range	Full level range.
Return	Float, unit: dBm
Default	-110 dBm
Menu	SWEEP > Step Sweep > Stop Level
Example	:SWEep:STEP:STOP:LEVel 0 dBm

3.5.3.7 Dwell Time ([:SOURce]:SWEep:STEP:DWELL)

Command	[:SOURce]:SWEep:STEP:DWELL <time>
Format	[:SOURce]:SWEep:STEP:DWELL?
Instruction	Set the duration of the individual sweep steps. Get the duration of the individual sweep steps.
Parameter Type	Float, unit: ns, us, ms, s
Parameter Range	10 ms ~ 100 s
Return	Float, unit: s
Default	30 ms
Menu	SWEEP > Step Sweep > Dwell Time
Example	:SWEep:STEP:DWELL 20 ms

3.5.3.8 Sweep Points ([:SOURce]:SWEep:STEP:POINTs)

Command	[:SOURce]:SWEep:STEP:POINTs <points>
Format	[:SOURce]:SWEep:STEP:POINTs?
Instruction	Set the number of steps in an RF sweep. Get the number of steps in an RF sweep.

Parameter Type	Integer
Parameter Range	2 ~ 65535
Return	Integer
Default	11
Menu	SWEEP > Step Sweep > Sweep Points
Example	:SWEep:STEP:POINTs 2

3.5.3.9 Sweep Shape ([:SOURce]:SWEep:STEP:SHAPE)

Command	[:SOURce]:SWEep:STEP:SHAPE TRIangle SAWtooth
Format	[:SOURce]:SWEep:STEP:SHAPE?
Instruction	Select the waveform shape of the sweep signal. Get the waveform shape of the sweep signal.
Parameter Type	Enumeration
Parameter Range	TRIangle SAWtooth
Return	Enumeration
Default	SAWTooth
Menu	SWEEP > Step Sweep > Sweep Shape
Example	:SWEep:STEP:SHAPE TRIangle

3.5.3.10 Sweep Space ([:SOURce]:SWEep:STEP:SPACE)

Command	[:SOURce]:SWEep:STEP:SPACE LINear LOGarithmic
Format	[:SOURce]:SWEep:STEP:SPACE?
Instruction	Select the sweep spacing. Get the sweep spacing.
Parameter Type	Enumeration
Parameter Range	LINear LOGarithmic
Return	Enumeration
Default	LINear

SIGLENT

Menu	SWEEP > Step Sweep > Sweep Space
Example	:SWEep:STEP:SPACe LOGarithmic

3.5.3.11 Sweep Step in Linear Sweep Space

([:SOURce]:SWEep[:FREQuency]:STEP[:LINear])

Command	[:SOURce]:SWEep[:FREQuency]:STEP[:LINear] <freq>
Format	[:SOURce]:SWEep[:FREQuency]:STEP[:LINear]?
Instruction	Set the sweep step in linear sweep space. Get the sweep step in linear sweep space.
Parameter Type	Float, unit: Hz, kHz, MHz, GHz, Default "Hz"
Parameter Range	None
Return	Float, unit: Hz
Default	0
Menu	SWEEP > Step Sweep > Freq Step Linear
Example	:SWEep:STEP 200 MHz

3.5.3.12 Sweep Step in Log Sweep Space

([:SOURce]:SWEep[:FREQuency]:STEP:LOGarithmic)

Command	[:SOURce]:SWEep[:FREQuency]:STEP:LOGarithmic <value>
Format	[:SOURce]:SWEep[:FREQuency]:STEP:LOGarithmic?
Instruction	Set the sweep step in logarithmic sweep space. Get the sweep step in logarithmic sweep space.
Parameter Type	Float, unit: %
Parameter Range	None
Return	Float, unit: %
Default	0
Menu	SWEEP > Step Sweep > Freq Step Log
Example	:SWEep:STEP:LOGarithmic 20

3.5.3.13 Sweep List Add Row ([:SOURce]:SWEep:LIST:ADDList)

Command Format	[:SOURce]:SWEep:LIST:ADDList <freq>,<level>,<time>
Instruction	Insert a new row.
Parameter Type	Freq: Float, unit: Hz, kHz, MHz, GHz, Default "Hz" Level: Float, unit: dBm Time: Float, unit: ns, us, ms, s
Parameter Range	Full frequency range, full frequency range, 10.0 ms ~ 100.0 s
Return	None
Default	None
Menu	SWEEP > List Sweep > [+]
Example	:SWEep:LIST:ADDList 1 GHz,0 dBm,1 s

3.5.3.14 Sweep List Delete Row ([:SOURce]:SWEep:LIST:DELeTe)

Command Format	[:SOURce]:SWEep:LIST:DELeTe <row>
Instruction	Delete the sweep list pair.
Parameter Type	Integer
Parameter Range	1 to count of sweep list.
Return	None
Default	None
Menu	SWEEP > List Sweep > [-]
Example	:SWEep:LIST:DELeTe 1

3.5.3.15 Sweep List Edit ([:SOURce]:SWEep:LIST:CHANGe)

Command Format	[:SOURce]:SWEep:LIST:CHANGe <row>,<freq>,<power>,<time>
Instruction	Edit sweep list pair value.
Parameter Type	Integer, Float, unit: Hz, kHz, MHz, GHz, Float, unit: dBm, dBmV, dBuV, V, W, Default: dBm, Float, unit: ns, us, ms, s

SIGLENT

Parameter	Raw: 1 ~ count of pair.
Range	Freq: Full frequency range. Power: Full level range. time: 10 ms ~ 100 s.
Return	None
Default	None
Menu	SWEEP > List Sweep
Example	:SWEep:LIST:CHANGe 1,1 GHz,1 dBm, 1 s

3.5.3.16 Sweep List Row Count ([:SOURce]:SWEep:LIST:CPOint?)

Command	
Format	[:SOURce]:SWEep:LIST:CPOint?
Instruction	Get how many rows in sweep list.
Parameter	None
Type	
Parameter	None
Range	
Return	Float
Default	1
Menu	SWEEP > List Sweep
Example	:SWEep:LIST:CPOint?

3.5.3.17 Show Sweep List ([:SOURce]:SWEep:LIST:LIST?)

Command	
Format	[:SOURce]:SWEep:LIST:LIST? <begin_row>,<end_row>
Instruction	View starting row to end row data.
Parameter	Integer, Integer
Type	
Parameter	1 to count of sweep list.
Range	
Return	String
Default	None
Menu	SWEEP > List Sweep
Example	:SWEep:LIST:LIST? 1,3

3.5.3.18 Sweep List Clear

([:SOURce]:SWEep:LIST:INITialize:PRESet)

Command Format	[:SOURce]:SWEep:LIST:INITialize:PRESet
Instruction	Restore the scan list of the factory default settings.
Parameter Type	None
Parameter Range	None
Return	None
Default	None
Menu	SWEEP > List Sweep > Clear
Example	SWEep:LIST:INITialize:PRESet

3.5.3.19 Sweep List Initialize From Step

([:SOURce]:SWEep:LIST:INITialize:FSTep)

Command Format	[:SOURce]:SWEep:LIST:INITialize:FSTep
Instruction	Regenerate the sweep list based on the data points of the current step sweep settings.
Parameter Type	None
Parameter Range	None
Return	None
Default	None
Menu	SWEEP > List Sweep
Example	SWEep:LIST:INITialize:FSTep

3.5.3.20 Sweep List Load ([:SOURce]:SWEep:LOAD)

Command Format	[:SOURce]:CORRection:LOAD <file_name>
-------------------	---------------------------------------

SIGLENT

Instruction	Load existing sweep list file.
Parameter Type	String
Parameter Range	None
Return	None
Default	None
Menu	SWEEP > List Sweep > Load
Example	:SWEep:LOAD test.lsw

3.5.3.21 Sweep List Store ([:SOURce]:SWEep:STORe)

Command Format	[:SOURce]:CORRection:STORe <file_name>
Instruction	Save the sweep data in the list.
Parameter Type	String
Parameter Range	None
Return	None
Default	None
Menu	SWEEP > List Sweep > Store
Example	:SWEep:STORe test.lsw

3.5.3.22 Sweep Direction ([:SOURce]:SWEep:DIRect)

Command Format	[:SOURce]:SWEep:DIRect FWD REV [:SOURce]:SWEep:DIRect?
Instruction	Select the direction for sweep.
Parameter Type	Enumeration
Parameter Range	FWD REV
Return	Enumeration
Default	FWD
Menu	SWEEP > Direction

Example	:SWEep:DIRect REV
---------	-------------------

3.5.3.23 Sweep Mode ([:SOURce]:SWEep:MODE)

Command	[:SOURce]:SWEep:MODE CONTInue SINGle
Format	[:SOURce]:SWEep:MODE?
Instruction	Set the cycle mode of the sweep. Get the cycle mode of the sweep.
Parameter Type	Enumeration
Parameter Range	CONTInue SINGle
Return	Enumeration
Default	CONTInue
Menu	SWEEP > Sweep Mode
Example	:SWEep:MODE SINGLE

3.5.3.24 Trigger Mode ([:SOURce]:SWEep:SWEep:TRIGger:TYPE)

Command	[:SOURce]:SWEep:SWEep:TRIGger:TYPE AUTO KEY BUS EXT
Format	[:SOURce]:SWEep:SWEep:TRIGger:TYPE?
Instruction	Select the trigger mode. Get the trigger mode.
Parameter Type	Enumeration
Parameter Range	AUTO KEY BUS EXT
Return	Enumeration
Default	AUTO
Menu	SWEEP > Trigger Mode
Example	:SWEep:SWEep:TRIGger:TYPE KEY

3.5.3.25 Point Trigger ([:SOURce]:SWEep:POINt:TRIGger:TYPE)

Command	[:SOURce]:SWEep:POINt:TRIGger:TYPE AUTO KEY BUS EXT
Format	[:SOURce]:SWEep:POINt:TRIGger:TYPE?

SIGLENT

Instruction	Select the point trigger. Get the point trigger.
Parameter Type	Enumeration
Parameter Range	AUTO KEY BUS EXT
Return	Enumeration
Default	AUTO
Menu	SWEEP > Point Trigger
Example	:SWEep:POINt:TRIGger:TYPE KEY

3.5.3.26 Trigger Slope ([:SOURce]:INPut:TRIGger:SLOPe)

Command	[:SOURce]:INPut:TRIGger:SLOPe POSitive NEGative
Format	[:SOURce]:INPut:TRIGger:SLOPe?
Instruction	Select the trigger slope. Get the trigger slope.
Parameter Type	Enumeration
Parameter Range	POSitive NEGative
Return	Enumeration
Default	POSitive
Menu	SWEEP > Trigger Slope
Example	:INPut:TRIGger:SLOPe NEGative

3.5.4[:SOURce]:MODulation Subsystem

3.5.4.1 Modulation State ([:SOURce]:MODulation)

Command	[:SOURce]:MODulation ON OFF 1 0
Format	[:SOURce]:MODulation?
Instruction	Switch the modulations on and off. Get the modulations state.
Parameter	Boolean

Type	
Parameter Range	ON OFF 1 0
Return	Boolean
Default	0
Menu	MOD
Example	MODulation ON

3.5.5[:SOURce]:AM Subsystem

3.5.5.1 AM State ([:SOURce]:AM:STATe)

Command	[:SOURce]:AM:STATe ON OFF 1 0
Format	[:SOURce]:AM:STATe?
Instruction	Activate/Deactivate amplitude modulation. Get the AM state.
Parameter Type	Boolean
Parameter Range	ON OFF 1 0
Return	Boolean
Default	0
Menu	AM > AM State
Example	:AM:STATe ON

3.5.5.2 AM Shape ([:SOURce]:AM:WAVEform)

Command	[:SOURce]:AM:WAVEform SINE SQUAre
Format	[:SOURce]:AM:WAVEform?
Instruction	Set the AM modulation waveform. Get the AM modulation waveform.
Parameter Type	Enumeration
Parameter Range	SINE SQUAre

SIGLENT

Return	Enumeration
Default	SINE
Menu	AM > AM Shape
Example	:AM:WAVEform SINE

3.5.5.3 AM Source ([:SOURce]:AM:SOURce)

Command	[:SOURce]:AM:SOURce INTernal EXTernal INT+EXT
Format	[:SOURce]:AM:SOURce?
Instruction	Select the modulation signal source for amplitude modulation. Get the AM source.
Parameter Type	Enumeration
Parameter Range	INTernal EXTernal INT+EXT
Return	Enumeration
Default	INTernal
Menu	AM > AM Source
Example	:AM:SOURce EXTernal

3.5.5.4 AM Depth ([:SOURce]:AM:DEPTH)

Command	[:SOURce]:AM:DEPTH <value>
Format	[:SOURce]:AM:DEPTH?
Instruction	Set the overall modulation depth of the amplitude modulation in percent. Get the AM depth.
Parameter Type	Float
Parameter Range	0.1 % ~ 100 %
Return	Float
Default	50 %
Menu	AM > AM Depth
Example	:AM:DEPTH 0.2

3.5.5.5 AM Rate ([:SOURce]:AM:FREQuency)

Command	[:SOURce]:AM:FREQuency <value>
Format	[:SOURce]:AM:FREQuency?
Instruction	Set the AM modulation frequency. Get the AM modulation frequency.
Parameter Type	Float, unit: Hz, kHz, MHz, GHz, Default "Hz"
Parameter Range	Sine: 0.01 Hz ~ 100 kHz Square: 0.01 Hz ~ 20 kHz
Return	Float, unit: Hz
Default	1 kHz
Menu	AM > AM Rate
Example	:AM:FREQuency 10 kHz

3.5.5.6 AM Sensitivity ([:SOURce]:AM:SENSitivity)

Command Format	[:SOURce]:AM:SENSitivity?
Instruction	Query the input sensitivity of the external modulation input in %/V.
Parameter Type	None
Parameter Range	None
Return	Float, unit: %/V
Default	0 %/V
Menu	AM > AM Sensitivity
Example	AM:SENSitivity?

3.5.6[:SOURce]:FM Subsystem

3.5.6.1 FM State ([:SOURce]:FM:STATE)

Command	[:SOURce]:FM:STATE ON OFF 1 0
Format	[:SOURce]:FM:STATE?

SIGLENT

Instruction	Activate/Deactivate FM. Get the FM state.
Parameter Type	Boolean
Parameter Range	ON OFF 1 0
Return	Boolean
Default	0
Menu	FM > FM State
Example	:FM:STATe ON

3.5.6.2 FM Shape ([:SOURce]:FM:WAVEform)

Command	[:SOURce]:FM:WAVEform SINE SQUAre
Format	[:SOURce]:FM:WAVEform?
Instruction	Selects the shape of FM. Get the shape of FM.
Parameter Type	Enumeration
Parameter Range	SINE SQUAre
Return	Enumeration
Default	SINE
Menu	FM > FM Shape
Example	:FM:WAVEform SQUAre

3.5.6.3 FM Source ([:SOURce]:FM:SOURce)

Command	[:SOURce]:FM:SOURce INTernal EXTernal INT+EXT
Format	[:SOURce]:FM:SOURce?
Instruction	Select the modulation signal source for frequency modulation. Get the FM Source.
Parameter Type	Enumeration
Parameter Range	INTernal EXTernal INT+EXT

Return	Enumeration
Default	INTernal
Menu	FM > FM Source
Example	:FM:SOURce EXTernal

3.5.6.4 FM Deviation ([:SOURce]:FM:DEVIation)

Command	[:SOURce]:FM:DEVIation <value>
Format	[:SOURce]:FM:DEVIation?
Instruction	Set deviation value Get deviation value
Parameter Type	Float, unit: Hz, kHz, MHz, GHz
Parameter Range	0.01 Hz ~ 1 MHz
Return	Float, unit: Hz
Default	100 kHz
Menu	FM > FM Deviation
Example	:FM:DEVIation 500 kHz

3.5.6.5 FM Rate ([:SOURce]:FM:FREQuency)

Command	[:SOURce]:FM:FREQuency <value>
Format	[:SOURce]:FM:FREQuency?
Instruction	Set the FM modulation frequency. Get the FM modulation frequency.
Parameter Type	Float, unit: Hz, kHz, MHz, GHz, Default "Hz"
Parameter Range	INTernal: SQUAre: 0.01 Hz ~ 20 kHz SINE: 0.01 Hz ~ 100 kHz INT+EXT: SQUAre: 0.01 Hz ~ 20 kHz SINE: 0.01 Hz ~ 100 kHz
Return	Float, unit: Hz
Default	10 kHz
Menu	FM > FM Rate
Example	:FM:FREQuency 40 kHz

3.5.6.6 FM Sensitivity ([:SOURce]:FM:SENSitivity)

Command	[:SOURce]:FM:SENSitivity?
Format	
Instruction	Displays the input sensitivity of the FM EXT input in Hz/V.
Parameter	None
Type	
Parameter	None
Range	
Return	Float unit: Hz/V
Default	0 Hz/V
Menu	FM > FM Sensitivity
Example	FM:SENSitivity?

3.5.7[:SOURce]:PM Subsystem

3.5.7.1 PM State ([:SOURce]:PM:STATE)

Command	[:SOURce]:PM:STATE ON OFF 1 0
Format	[:SOURce]:PM:STATE?
Instruction	Activate/Deactivate phase modulation. Get the PM state.
Parameter	Boolean
Type	
Parameter	ON OFF 1 0
Range	
Return	Boolean
Default	0
Menu	PM > PM State
Example	:PM:STATE ON

3.5.7.2 PM Shape ([:SOURce]:PM:WAVEform)

Command	[:SOURce]:PM:WAVEform SINE SQUAre
Format	[:SOURce]:PM:WAVEform?

Instruction	Selects the shape of PM. Get the shape of PM.
Parameter Type	Enumeration
Parameter Range	SINE SQUAre
Return	Enumeration
Default	SINE
Menu	PM > PM Shape
Example	:PM:WAVEform SINE

3.5.7.3 PM Source ([:SOURce]:PM:SOURce)

Command	[:SOURce]:PM:SOURce INTernal EXTernal INT+EXT
Format	[:SOURce]:PM:SOURce?
Instruction	Select the modulation signal source for phase modulation. Get the PM source.
Parameter Type	Enumeration
Parameter Range	INTernal EXTernal INT+EXT
Return	Enumeration
Default	INTernal
Menu	PM > PM Source
Example	:PM:SOURce EXTernal

3.5.7.4 PM Deviation ([:SOURce]:PM:DEVIation)

Command	[:SOURce]:PM:DEVIation <value>
Format	[:SOURce]:PM:DEVIation?
Instruction	Set the modulation deviation of the phase modulation. Get the modulation deviation of the phase modulation.
Parameter Type	Float, unit: rad
Parameter Range	0.00001 rad ~ 5 rad

SIGLENT

Return	Float, unit: rad
Default	1 rad
Menu	PM > PM Deviation
Example	:PM:DEVIation 2

3.5.7.5 PM Rate ([:SOURce]:PM:FREQuency)

Command	[:SOURce]:PM:FREQuency <value>
Format	[:SOURce]:PM:FREQuency?
Instruction	Set the PM modulation frequency. Get the PM modulation frequency.
Parameter Type	Float, unit: Hz, kHz, MHz, GHz, Default "Hz"
Parameter Range	INTernal: SQUAre:0.01 Hz ~ 20 kHz SINE: 0.01 Hz ~ 100 kHz INT+EXT: SQUAre:0.01 Hz ~ 20 kHz 0.01 Hz ~ 100 kHz
Return	Float, unit: Hz
Default	10 kHz
Menu	PM > PM Rate
Example	:PM:FREQuency 10 kHz

3.5.7.6 PM Sensitivity ([:SOURce]:PM:SENSitivity)

Command Format	[:SOURce]:PM:SENSitivity?
Instruction	Query the input sensitivity of the EXT MOD input in rad/v.
Parameter Type	None
Parameter Range	None
Return	Float, unit: rad/V
Default	0 rad/V
Menu	PM > PM Sensitivity
Example	PM:SENSitivity?

3.5.8[:SOURce]:PULM Subsystem

3.5.8.1 Pulse State ([:SOURce]:PULM:STATe)

Command	[:SOURce]:PULM:STATe ON OFF 1 0
Format	[:SOURce]:PULM:STATe?
Instruction	Activate/Deactivate the pulse modulation. Get the state of pulse modulation.
Parameter Type	Boolean
Parameter Range	ON OFF 1 0
Return	Boolean
Default	0
Menu	PULSE > Pulse State
Example	PULM:STAT ON

3.5.8.2 Pulse Out ([:SOURce]:PULM:OUT:STATe)

Command	[:SOURce]:PULM:OUT:STATe ON OFF 1 0
Format	[:SOURce]:PULM:OUT:STATe?
Instruction	Configures the signal at the PULSE OUT connector. Get the Output status.
Parameter Type	Boolean
Parameter Range	ON OFF 1 0
Return	Boolean
Default	0
Menu	PULSE > Pulse Out
Example	PULM:OUT ON

3.5.8.3 Pulse Source ([:SOURce]:PULM:SOURce)

Command	[:SOURce]:PULM:SOURce INTernal EXTernal
---------	---

SIGLENT

Format	[[:SOURce]:PULM:SOURce?
Instruction	Select the source for the pulse modulation signal. Get the source for the pulse modulation signal.
Parameter Type	Enumeration
Parameter Range	INTernal EXTernal
Return	Enumeration
Default	INTernal
Menu	PULSE > Pulse Source
Example	PULM:SOUR INTernal

3.5.8.4 Pulse Polarity ([[:SOURce]:PULM:POLarity)

Command	[[:SOURce]:PULM:POLarity NORMAL INVerted
Format	[[:SOURce]:PULM:POLarity?
Instruction	Set the period of the generated pulse. The period determines the repetition frequency of the internal signal. Get the period of the generated pulse.
Parameter Type	Enumeration
Parameter Range	NORMAl INVerted
Return	Enumeration
Default	NORMAl
Menu	PULSE > Pulse Polarity
Example	PULM:POL INV

3.5.8.5 Pulse Mode ([[:SOURce]:PULM:MODE)

Command	[[:SOURce]:PULM:MODE SINGle DOUBle PTRain
Format	[[:SOURce]:PULM:MODE?
Instruction	Set the mode of the pulse generator. Get the mode of the pulse generator.
Parameter Type	Enumeration

Parameter	SINGLE DOUBLE PTRain
Range	SINGLE Enables single pulse generation. DOUBLE Enables double pulse generation. The two pulses are generated in one pulse period. PTRain A user-defined pulse train is generated The pulse train is defined by value pairs of on and off times that can be entered in a pulse train list.
Return	Enumeration
Default	SINGLE
Menu	PULSE > Pulse Mode
Example	PULM:MODE DOUB

3.5.8.6 Pulse Period ([:SOURce]:PULM:PERiod)

Command	[:SOURce]:PULM:PERiod <value>
Format	[:SOURce]:PULM:PERiod?
Instruction	Set the period of the generated pulse. The period determines the repetition frequency of the internal signal. Get the period of the generated pulse.
Parameter	Float, unit: ns, us, ms, s
Type	
Parameter	40 ns ~ 300 s
Range	
Return	Float, unit: s
Default	10 ms
Menu	PULSE > Pulse Period
Example	PULM:PER 220 us

3.5.8.7 Pulse Width ([:SOURce]:PULM:WIDTh)

Command	[:SOURce]:PULM:WIDTh <value>
Format	[:SOURce]:PULM:WIDTh?
Instruction	Set the width of the generated pulse. Get the width of the generated pulse.

SIGLENT

Parameter	Float, unit: ns, us, ms, s
Type	
Parameter Range	20 ns ~ 300 s
Return	Float, unit: s
Default	2 ms
Menu	PULSE > Pulse Width
Example	PULM:WIDT 33 us

3.5.8.8 Double Pulse Delay ([:SOURce]:PULM:DOUBle:DElay)

Command	[:SOURce]:PULM:DOUBle:DElay <value>
Format	[:SOURce]:PULM:DOUBle:DElay?
Instruction	Set the delay from the start of the first pulse to the start of the second pulse. Get the delay from the start of the first pulse to the start of the second pulse.
Parameter	Float, unit: ns, us, ms, s
Type	
Parameter Range	20 ns ~ 300 s
Return	Float, unit: s
Default	4 ms
Menu	PULSE > Double Pulse Delay
Example	:PULM:DOUBle:DElay 2 ms

3.5.8.9 #2 Width ([:SOURce]:PULM:DOUBle:WIDTh)

Command	[:SOURce]:PULM:DOUBle:WIDTh <time>
Format	[:SOURce]:PULM:DOUBle:WIDTh?
Instruction	Set the width of the second pulse in case of double pulse generation. Get the width of the second pulse in case of double pulse generation.
Parameter	Float, unit: ns, us, ms, s
Type	
Parameter Range	20 ns ~ 300 s

Return	Float, unit: s
Default	2 ms
Menu	PULSE > #2 Width
Example	PULM:DOUBle:WIDTh 2 s

3.5.8.10 Pulse Train Add Row ([:SOURce]:PULM:TRAI:n:PAIR)

Command Format	[:SOURce]:PULM:TRAI:n:PAIR
Instruction	Add default train pair value.
Parameter Type	None
Parameter Range	None
Return	None
Default	None
Menu	PULSE > Pulse Train > [+]
Example	PULM:TRAI:n:PAIR

3.5.8.11 Pulse Train Delete ([:SOURce]:PULM:TRAI:n:DELEte)

Command Format	[:SOURce]:PULM:TRAI:n:DELEte <row>
Instruction	Delete the train pair.
Parameter Type	Integer
Parameter Range	1 ~ 2047
Return	None
Default	None
Menu	PULSE > Pulse Train > [-]
Example	PULM:TRAI:n:DELEte 5

3.5.8.12 Pulse Train Edit ([:SOURce]:PULM:TRAI:n:CHANGe)

Command	[:SOURce]:PULM:TRAI:n:CHANGe <raw>,<on_time>,<off_time>,<count>
---------	---

SIGLENT

Format	
Instruction	Edit train pair value.
Parameter Type	Integer, Float, unit: ns, us, ms, s, Float, unit: ns, us, ms, s, Integer
Parameter Range	Raw: 1 ~ count of pair. On time: 10 ns ~ 300 s. Off time: 10 ns ~ 300 s. Count: 1 ~ 65535
Return	None
Default	None
Menu	PULSE > Pulse Train
Example	:PULM:TRAI:CHANGe 1,10 ms,20 ms,3

3.5.8.13 List Pulse Train ([:SOURce]:PULM:TRAI:LIST?)

Command Format	[:SOURce]:PULM:TRAI:LIST? <begin_row>,<end_row>
Instruction	View starting row to end row data.
Parameter Type	Integer, Integer
Parameter Range	Begin_row: 1 ~ the count of pulse list. End_row: Begin_row ~ the count of pulse list.
Return	String
Default	None
Menu	PULSE > Pulse Train
Example	:PULM:TRAI:LIST? 1,3

3.5.8.14 Pulse Train Count ([:SOURce]:PULM:TRAI:COUNT?)

Command Format	[:SOURce]:PULM:TRAI:COUNT?
Instruction	Get count of train list.
Parameter Type	None
Parameter Range	None

Return	Integer
Default	1
Menu	PULSE > Pulse Train
Example	:PULM:TRAI:COUNT?

3.5.8.15 Pulse Train Clear ([:SOURce]:PULM:TRAI:CLEAr)

Command Format	[:SOURce]:PULM:TRAI:CLEAr
Instruction	Clear train pair list.
Parameter Type	None
Parameter Range	None
Return	None
Default	None
Menu	PULSE > Pulse Train > Store
Example	PULM:TRAI:CLEAr

3.5.8.16 Pulse Train Load ([:SOURce]:PULM:TRAI:LOAD)

Command Format	[:SOURce]:PULM:TRAI:LOAD <file>
Instruction	Load train pair list.
Parameter Type	String
Parameter Range	None
Return	None
Default	None
Menu	PULSE > Pulse Train > Load
Example	PULM:TRAI:LOAD test.pulstrn

3.5.8.17 Pulse Train Store ([:SOURce]:PULM:TRAI:STORE)

Command	[:SOURce]:PULM:TRAI:STORE <file>
---------	----------------------------------

SIGLENT

Format	
Instruction	Store train pair list.
Parameter	String
Type	
Parameter	None
Range	
Return	None
Default	None
Menu	PULSE > Pulse Train
Example	PULM:TRAI:STORE test.pulstrn

3.5.8.18 Trigger Out ([:SOURce]:PULM:TRIGger:STATe)

Command	[:SOURce]:PULM:TRIGger:STATe ON OFF 1 0
Format	[:SOURce]:PULM:TRIGger:STATe?
Instruction	Set the trigger output status. Get the trigger output status.
Parameter	Boolean
Type	
Parameter	ON OFF 1 0
Range	
Return	Boolean
Default	1
Menu	PULSE > Trigger Out
Example	PULM:TRIGger:STATe ON

3.5.8.19 Pulse Trigger ([:SOURce]:PULM:TRIGger:MODE)

Command	[:SOURce]:PULM:TRIGger:MODE AUTO KEY EXTErnal EGATE
Format	[:SOURce]:PULM:TRIGger:MODE?
Instruction	Select the trigger mode for pulse modulation. Get the trigger mode for pulse modulation.
Parameter	Enumeration
Type	
Parameter	AUTO KEY EXTErnal EGATE
Range	

Return	Enumeration
Default	AUTO
Menu	PULSE > Pulse Trigger
Example	PULM:TRIG:MODE EXTERNAL

3.5.8.20 Trig Polarity

([:SOURce]:PULM:TRIGger:EXTernal:GATE:POLarity)

Command	[:SOURce]:PULM:TRIGger:EXTernal:GATE:POLarity NORMAl INVerted
Format	[:SOURce]:PULM:TRIGger:EXTernal:GATE:POLarity?
Instruction	Select the polarity of the gate signal. Get the polarity of the gate signal.
Parameter Type	Enumeration
Parameter Range	NORMAl INVerted
Return	Enumeration
Default	NORMAl
Menu	PULSE > Pulse Polarity
Example	PULM:TRIG:EXT:GATE:POL NORMAl

3.5.8.21 Trig Delay ([:SOURce]:PULM:DELay)

Command	[:SOURce]:PULM:DELay <value>
Format	[:SOURce]:PULM:DELay?
Instruction	Set the pulse delay. Get the pulse delay.
Parameter Type	Float, unit: ns, us, ms, s
Parameter Range	140 ns ~ 300 s
Return	Float, unit: s
Default	140 ns
Menu	PULSE > Trig Delay
Example	PULM:DEL 30 ms

3.5.8.22 Trig Slope ([:SOURce]:PULM:TRIGger:EXTernal:SLOPe)

Command	[:SOURce]:PULM:TRIGger:EXTernal:SLOPe NEGative POSitive
Format	[:SOURce]:PULM:TRIGger:EXTernal:SLOPe?
Instruction	Set the polarity of the active slope of an applied trigger at the PULSE EXT connector. Get the polarity of the active slope of an applied trigger at the PULSE EXT connector.
Parameter Type	Enumeration
Parameter Range	NEGative POSitive
Return	Enumeration
Default	POSitive
Menu	PULSE > Trig Slope
Example	PULM:TRIG:EXT:SLOP NEG

3.5.9[:SOURce]:LFOutput Subsystem

3.5.9.1 LF State ([:SOURce]:LFOutput[:STATe])

Command	[:SOURce]:LFOutput ON OFF 1 0
Format	[:SOURce]:LFOutput?
Instruction	Activate/deactivate the LF output. Get the LF output state.
Parameter Type	Boolean
Parameter Range	ON OFF 1 0
Return	Boolean
Default	0
Menu	LF > LF State
Example	LFOutput ON

3.5.9.2 LF Level ([:SOURce]:LFOutput:VOLTage)

Command	[:SOURce]:LFOutput:VOLTage <volt>
Format	[:SOURce]:LFOutput:VOLTage?
Instruction	Set the voltage of the LF output signal. Get the voltage of the LF output signal.
Parameter Type	Float, unit: dBm, dBmV, dBuV, V, W, Default: V (Here V is the peak-peak value)
Parameter Range	1 mVpp ~ 3 Vpp
Return	Float, unit: Vpp
Default	0.5 Vpp
Menu	LF > LF Voltage
Example	LFOutput:VOLTage 2 V

3.5.9.3 LF Offset ([:SOURce]:LFOutput:OFFSEt)

Command	[:SOURce]:LFOutput:OFFSEt <volt>
Format	[:SOURce]:LFOutput:OFFSEt?
Instruction	Set the voltage offset of the LF output signal. Get the voltage offset of the LF output signal.
Parameter Type	Float, unit: dBm, dBmV, dBuV, V, W, Default: V
Parameter Range	$ LFOffset \leq \max(2.5V - \frac{1}{2} LEVEL, 2V)$
Return	Float, unit: V
Default	0 V
Menu	LF > LF Offset
Example	LFOutput:OFFSEt 1 V

3.5.9.4 LF Frequency ([:SOURce]:LFOutput:FREQuency)

Command	[:SOURce]:LFOutput:FREQuency <freq>
Format	[:SOURce]:LFOutput:FREQuency?
Instruction	Set LF out put frequency. Get LF out put frequency.

SIGLENT

	If signal source "Internal" is set, the instrument performs the analog modulations (AM/FM /PM) with this frequency.
Parameter Type	Float, unit: Hz, kHz, MHz, GHz, Default "Hz"
Parameter Range	0.01 Hz ~ 1 MHz
Return	Float, unit: Hz
Default	1 kHz
Menu	LF > LF Frequency
Example	LFOutput:FREQuency 10 kHz

3.5.9.5 LF Shape ([:SOURce]:LFOutput:SHAPE)

Command	[:SOURce]:LFOutput:SHAPE SINE SQUare TRIangle SAWTooth DC
Format	[:SOURce]:LFOutput:SHAPE?
Instruction	Select the shape of the LF signal. Get the shape of the LF signal.
Parameter Type	Enumeration
Parameter Range	SINE SQUare TRIangle SAWTooth DC
Return	Enumeration
Default	SINE
Menu	LF > LF Shape
Example	LFOutput:SHAPE TRIangle

3.5.9.6 LF Phase ([:SOURce]:LFOutput:PHASe)

Command	[:SOURce]:LFOutput:PHASe <deg>
Format	[:SOURce]:LFOutput:PHASe?
Instruction	Set the phase of the LF output signal. Get the phase of the LF output signal.
Parameter Type	Float, unit: deg
Parameter Range	-360 deg ~ 360 deg

Range	
Return	Float, unit: deg
Default	0 deg
Menu	LF > LF Phase
Example	LFOutput:PHASe 20

3.5.10[:SOURce]:LFOutput:SWEEp Subsystem

3.5.10.1 Sweep State ([:SOURce]:LFOutput:SWEEp)

Command	[:SOURce]:LFOutput:SWEEp ON OFF 0 1
Format	[:SOURce]:LFOutput:SWEEp?
Instruction	Activate/Deactivate the LF frequency sweep signal generation. Get the state of LF frequency sweep.
Parameter Type	Boolean
Parameter Range	ON OFF 0 1
Return	Boolean
Default	0
Menu	LF Sweep > LF State
Example	:LFOutput:SWEEp 1

3.5.10.2 Sweep Direction ([:SOURce]:LFOutput:SWEEp:DIRect)

Command	[:SOURce]:LFOutput:SWEEp:DIRect UP DOWN
Format	[:SOURce]:LFOutput:SWEEp:DIRect?
Instruction	Set the sweep direction. Get the sweep direction.
Parameter Type	Enumeration
Parameter Range	UP DOWN
Return	Enumeration
Default	UP

SIGLENT

Menu	LF Sweep > Sweep Direction
Example	:LFOutput:SWEep:DIRect DOWN

3.5.10.3 Start Freq ([:SOURce]:LFOutput:SWEep:START:FREQuency)

Command	[[:SOURce]:LFOutput:SWEep:START:FREQuency <freq>
Format	[[:SOURce]:LFOutput:SWEep:START:FREQuency?
Instruction	Set the start frequency of sweep mode. Get the start frequency of sweep mode.
Parameter Type	Float, unit: Hz, kHz, MHz, GHz, Default "Hz"
Parameter Range	0.01 Hz ~ Stop frequency
Return	Float, unit: Hz
Default	500 Hz
Menu	LF Sweep > Start Freq
Example	:LFOutput:SWEep:START:FREQuency 100

3.5.10.4 Stop Freq ([:SOURce]:LFOutput:SWEep:STOP:FREQuency)

Command	[[:SOURce]:LFOutput:SWEep:STOP:FREQuency <freq>
Format	[[:SOURce]:LFOutput:SWEep:STOP:FREQuency?
Instruction	Set the stop frequency of sweep mode. Get the stop frequency of sweep mode.
Parameter Type	Float, unit: Hz, kHz, MHz, GHz, Default "Hz"
Parameter Range	Start frequency ~ Maximum frequency of LF
Return	Float, unit: Hz
Default	1.5 kHz
Menu	LF Sweep > Stop Freq
Example	:LFOutput:SWEep:STOP:FREQuency 1000

3.5.10.5 Center Freq

([:SOURce]:LFOutput:SWEEp:CENTer:FREQuency)

Command	[:SOURce]:LFOutput:SWEEp:CENTer:FREQuency <freq>
Format	[:SOURce]:LFOutput:SWEEp:CENTer:FREQuency?
Instruction	Set the center frequency of sweep mode. Get the center frequency of sweep mode.
Parameter Type	Float, unit: Hz, kHz, MHz, GHz, Default "Hz"
Parameter Range	0.01 Hz ~ Maximum frequency of LF
Return	Float, unit: Hz
Default	1 kHz
Menu	LF Sweep > Center Freq
Example	:LFOutput:SWEEp:CENTer:FREQuency 550

3.5.10.6 Freq Span

([:SOURce]:LFOutput:SWEEp:SPAN:FREQuency)

Command	[:SOURce]:LFOutput:SWEEp:SPAN:FREQuency <freq>
Format	[:SOURce]:LFOutput:SWEEp:SPAN:FREQuency?
Instruction	Set the center frequency of sweep mode. Get the center frequency of sweep mode.
Parameter Type	Float, unit: Hz, kHz, MHz, GHz, Default "Hz"
Parameter Range	0 Hz ~ Maximum frequency of LF - 0.01 Hz
Return	Float, unit: Hz
Default	1 kHz
Menu	LF Sweep > Freq Span
Example	:LFOutput:SWEEp:SPAN:FREQuency 550

3.5.10.7 Sweep Time ([:SOURce]:LFOutput:SWEEp:DWELL)

Command	[:SOURce]:LFOutput:SWEEp:DWELL <time>
---------	---------------------------------------

SIGLENT

Format	[[:SOURce]:LFOutput:SWEep:DWELL?
Instruction	Set the sweep time of sweep mode. Get the sweep time of sweep mode.
Parameter Type	Float, unit: ns, us, ms, s
Parameter Range	1 ms ~ 500 s
Return	Float, unit: s
Default	1 s
Menu	LF Sweep > Sweep Time
Example	:LFOutput:SWEep:DWELL 2 s

3.5.10.8 Trigger Mode ([[:SOURce]:LFOutput:SWEep:TRIGger:TYPE])

Command	[[:SOURce]:LFOutput:SWEep:TRIGger:TYPE AUTO KEY BUS EXT
Format	[[:SOURce]:LFOutput:SWEep:TRIGger:TYPE?
Instruction	Select the LF frequency sweep trigger mode. Get the LF frequency sweep trigger mode.
Parameter Type	Enumeration
Parameter Range	AUTO KEY BUS EXT
Return	Enumeration
Default	AUTO
Menu	LF Sweep > Trigger Mode
Example	:LFOutput:SWEep:TRIGger:TYPE KEY

3.5.10.9 Sweep Shape ([[:SOURce]:LFOutput:SWEep:SHAPE])

Command	[[:SOURce]:LFOutput:SWEep:SHAPE TRIangle SAWTooth
Format	[[:SOURce]:LFOutput:SWEep:SHAPE?
Instruction	Select the waveform shape of the sweep signal. Get the waveform shape of the sweep signal.
Parameter Type	Enumeration
Parameter	TRIangle SAWTooth

Range	
Return	Enumeration
Default	SAWTooth
Menu	LF Sweep > Sweep Shape
Example	:LFOutput:SWEep:SHAPE TRIangle

3.5.10.10 Sweep Space ([:SOURce]:LFOutput:SWEep:SPACing)

Command	[:SOURce]:LFOutput:SWEep:SPACing LINear LOGarithmic
Format	[:SOURce]:LFOutput:SWEep:SPACing?
Instruction	Select the mode for the calculation of the frequency sweep intervals. Get the mode for the calculation of the frequency sweep intervals.
Parameter Type	Enumeration
Parameter Range	LINear LOGarithmic
Return	Enumeration
Default	LINear
Menu	LF Sweep > Sweep Space
Example	:LFOutput:SWEep:SPACing LOGarithmic

3.6 Sense Subsystem

3.6.1 Sensor Info (:SENSE[:POWER]:TYPE)

Command	:SENSE[:POWER]:TYPE?
Format	
Instruction	Query the type of sensor connected to the POWER SENSOR connector.
Parameter Type	None
Parameter Range	None
Return	String
Default	None
Menu	SENSOR > Sensor Info

SIGLENT

Example	SENSE:TYPE?
---------	-------------

3.6.2 Sensor State (:SENSE[:POWER]:STATUS)

Command	:SENSE[:POWER]:STATUS OFF ON 0 1
Format	:SENSE[:POWER]:STATUS?
Instruction	Set the sensor state. Get the sensor state.
Parameter Type	Boolean
Parameter Range	OFF ON 0 1
Return	Boolean
Default	0
Menu	SENSOR > Sensor State
Example	SENSE:STATUS ON

3.6.3 Measurement (:SENSE[:POWER]:VALUE)

Command	:SENSE[:POWER]:VALUE?
Format	
Instruction	Indicate the current reading of the sensor.
Parameter Type	None
Parameter Range	None
Return	Float, unit: dBm
Default	None
Menu	SENSOR > Measurement
Example	SENSE:VALUE?

3.6.4 Statistics State

(:SENSE[:POWER]:STATISTICS:STATE)

Command	:SENSE[:POWER]:STATISTICS:STATE ON OFF 1 0
Format	:SENSE[:POWER]:STATISTICS:STATE?

Instruction	Set statistics state. Get statistics state.
Parameter Type	Boolean
Parameter Range	ON OFF 1 0
Return	Boolean
Default	0
Menu	SENSOR > Statistics
Example	SENSE:STATISTICS:STATE ON

3.6.5 Statistics Value (:READ[:POWER])

Command Format	:READ[:POWER]?
Instruction	Indicate the measured mean value and maximum value.
Parameter Type	None
Parameter Range	None
Return	String
Default	None
Menu	SENSOR > Statistics
Example	READ?

3.6.6 Statistics Max Value

(:SENSE[:POWER]:STATISTICS:MAX?)

Command Format	:SENSE[:POWER]:STATISTICS:MAX?
Instruction	Indicate the measured maximum value.
Parameter Type	None
Parameter Range	None
Return	Float, unit: dBm

SIGLENT

Default	None
Menu	SENSOR > Statistics
Example	SENSE:STATISTICS:MAX?

3.6.7 Statistics Min Value

(:SENSE[:POWER]:STATISTICS:MIN?)

Command	:SENSE[:POWER]:STATISTICS:MIN?
Format	
Instruction	Indicate the measured minimum value.
Parameter	None
Type	
Parameter	None
Range	
Return	Float, unit: dBm
Default	None
Menu	SENSOR > Statistics
Example	SENSE:STATISTICS:MIN?

3.6.8 Statistics Mean Value

(:SENSE[:POWER]:STATISTICS:AVG?)

Command	:SENSE[:POWER]:STATISTICS:AVG?
Format	
Instruction	Indicate the measured mean value.
Parameter	None
Type	
Parameter	None
Range	
Return	Float, unit: dBm
Default	None
Menu	SENSOR > Statistics
Example	SENSE:STATISTICS:AVG?

3.6.9 Statistics Count

(:SENSE[:POWER]:STATISTICS:COUNT?)

Command	:SENSE[:POWER]:STATISTICS:COUNT?
Format	
Instruction	Indicate the measured times.
Parameter	None
Type	
Parameter	None
Range	
Return	Integer
Default	None
Menu	SENSOR > Statistics
Example	SENSE:STATISTICS:COUNT?

3.6.10 Statistics Clear

(:SENSE[:POWER]:STATISTICS:CLEAR?)

Command	:SENSE[:POWER]:STATISTICS:CLEAR?
Format	
Instruction	Clear statistics.
Parameter	None
Type	
Parameter	None
Range	
Return	None
Default	None
Menu	SENSOR > Statistics
Example	SENSE:STATISTICS:CLEAR?

3.6.11 Auto Zero (:CALIBRATION:ZERO:TYPE)

Command	:CALIBRATION:ZERO:TYPE INTERNAL EXTERNAL
Format	:CALIBRATION:ZERO:TYPE?
Instruction	Select zero type. Get zero type.

SIGLENT

Parameter	Enumeration
Type	
Parameter Range	INTernal EXTernal
Return	Enumeration
Default	INTernal
Menu	SENSOR > Auto Zero
Example	CALibration:ZERO:TYPE EXTernal

3.6.12 Zeroing (:SENSe[:POWer]:ZERO)

Command	:SENSe[:POWer]:ZERO
Format	
Instruction	Perform zeroing of the sensor.
Parameter	None
Type	
Parameter Range	None
Return	None
Default	None
Menu	SENSOR > Click to perform zeroing
Example	:SENSe:ZERO

3.6.13 Frequency Type (:SENSe[:POWer]:SOURce)

Command	:SENSe[:POWer]:SOURce RF USER
Format	:SENSe[:POWer]:SOURce?
Instruction	Select the signal source for the measurement. Get the signal source for the measurement.
Parameter	Enumeration
Type	
Parameter Range	RF USER
Return	Enumeration
Default	RF
Menu	SENSOR > Frequency

Example	SENSe:SOURce RF
---------	-----------------

3.6.14 Frequency (:SENSe[:POWER]:FREQuency)

Command	:SENSe[:POWER]:FREQuency <type>
Format	:SENSe[:POWER]:FREQuency?
Instruction	Set the frequency for frequency type " USER". Get the frequency for frequency type " USER".
Parameter Type	Float, unit: Hz, kHz, MHz, GHz, Default "Hz"
Parameter Range	9 kHz ~ 3.2 GHz
Return	Float, unit: Hz
Default	None
Menu	SENSOR > Frequency
Example	SENSe:FREQuency 1 MHz

3.6.15 Level Offset State

(:SENSe[:POWER]:OFFSet:STATe)

Command	:SENSe[:POWER]:OFFSet:STATe ON OFF 0 1
Format	:SENSe[:POWER]:OFFSet:STATe?
Instruction	Switch the power offset switch status. Get the power offset switch status.
Parameter Type	Boolean
Parameter Range	ON OFF 0 1
Return	Boolean
Default	0
Menu	SENSOR > Level Offset
Example	SENSe:OFFSet:STATe ON

3.6.16 Level Offset (:SENSe[:POWER]:OFFSet)

Command	:SENSe[:POWER]:OFFSet <power>
---------	-------------------------------

Format	:SENSe[:POWer]:OFFSet?
Instruction	The command enters a level offset which is added to the measured level value. Get the level offset which is added to the measured level value.
Parameter Type	Float
Parameter Range	Limit by power sensor.
Return	Float, unit: dB
Default	0 dB
Menu	SENSOR > Level Offset
Example	SENSe:OFFSet 10

3.6.17 Average Type (:SENSe[:POWer]:FILTer:TYPE)

Command	:SENSe[:POWer]:FILTer:TYPE AUTO USER NSRatio
Format	:SENSe[:POWer]:FILTer:TYPE?
Instruction	Select the averaging mode. Get the averaging mode.
Parameter Type	Enumeration
Parameter Range	AUTO USER NSRatio
Return	Enumeration
Default	None
Menu	SENSOR > Averaging
Example	SENSe:FILTer:TYPE AUTO

3.6.18 Average Times (:SENSe[:POWer]:FILTer:LENGth)

Command	:SENSe[:POWer]:FILTer:LENGth <length>
Format	:SENSe[:POWer]:FILTer:LENGth?
Instruction	Set the average number times.
Parameter Type	Integer
Parameter	Limit by power sensor

Range	
Return	Float
Default	None
Menu	SENSOR > Averaging
Example	SENSE:FILTer:LENGth 10

3.6.19 Internal Noise (:SENSE[:POWER]:FILTer:NSRatio)

Command	:SENSE[:POWER]:FILTer:NSRatio <noise>
Format	:SENSE[:POWER]:FILTer:NSRatio?
Instruction	The power sensor will control the internal noise that does not exceed the set value of the fixed noise parameter.
Parameter Type	Float, unit: dB
Parameter Range	Limit by power sensor.
Return	Float, unit: dB
Default	None
Menu	SENSOR > Averaging
Example	SENSE:FILTer:NSRatio 1

3.6.20 Logging (:SENSE[:POWER]:LOGGing:STATe)

Command	:SENSE[:POWER]:LOGGing:STATe <state>
Format	:SENSE[:POWER]:LOGGing:STATe?
Instruction	Set logging state. Get logging state.
Parameter Type	Boolean
Parameter Range	ON OFF 1 0
Return	Boolean
Default	0
Menu	SENSOR > Logging
Example	SENSE:LOGGing:STATe ON

4. Programming Examples

This chapter gives some examples for the programmer. In these examples you can see how to use the VISA or sockets, in combination with the commands have been described above to control the signal generator. By following these examples, you can develop many more applications.

4.1 Examples of Using VISA

4.1.1 Example of VC++

Environment: Win7 32bit system, Visual Studio

The functions of this example: use the NI-VISA, to control the device with USBTMC or TCP/IP access to do a write and read.

Follow the steps to finish the example:

- 1、 Open Visual Studio, create a new VC++ win32 console project.
- 2、 Set the project environment to use the NI-VISA lib, there are two ways to use NI-VISA, static or automatic:

(1) Static: find files: visa.h, visatype.h, visa32.lib in NI-VISA install path. Copy them to your project, and add them into project. In the projectname.cpp file, add the follow two lines:

```
#include "visa.h"  
#pragma comment(lib,"visa32.lib")
```

(2) Automatic:

Set the .h file include directory, the NI-VISA install path, in our computer we set the path is: C:\Program Files\IVI Foundation \VISA\WinNT\include. Set this path to project---properties---c/c++---General---Additional Include Directories: See the picture.

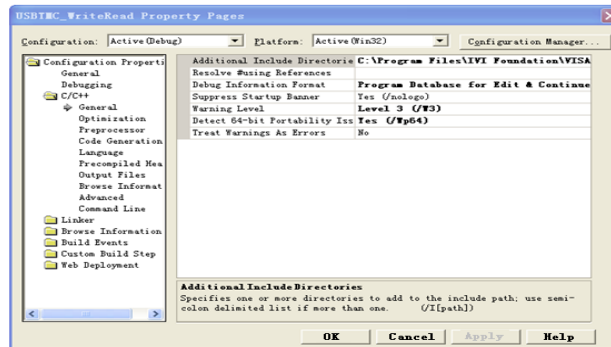

Set lib path set lib file:

Set lib path: the NI-VISA install path, in our computer we set the path is: C:\Program Files\IVI Foundation\VISA\WinNT\lib\msc. Set this path to project---properties---Linker---General---Additional Library Directories: as seen in the pictures below.

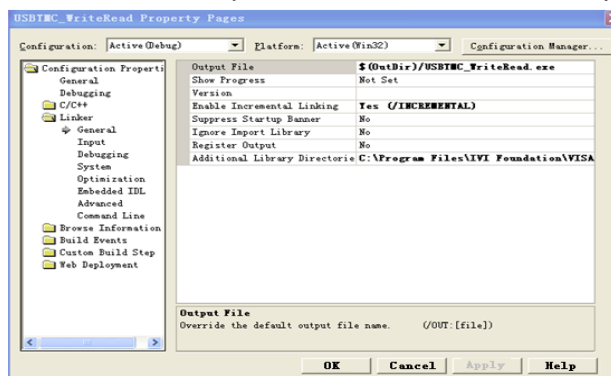

Set lib file: project---properties---Linker---Command Line---Additional Options: visa32.lib

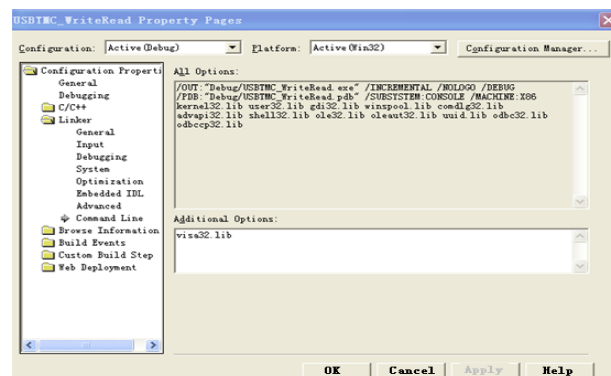

Include visa.h file: In the projectname.cpp file:

```
#include <visa.h>
```

3、 Add codes:

(1) USBTMC access code.

Write a function Usbtmc_test:

```
int Usbtmc_test()
```

```
{
```

```
/* This code demonstrates sending synchronous read & write commands */
```

```
/* to an USB Test & Measurement Class (USBTMC) instrument using */
```

```
/* NI-VISA */
```

SIGLENT

```
/* The example writes the "*IDN?\n" string to all the USBTMC */
/* devices connected to the system and attempts to read back */
/* results using the write and read functions. */
/* The general flow of the code is */
/* Open Resource Manager */
/* Open VISA Session to an Instrument */
/* Write the Identification Query Using viPrintf */
/* Try to Read a Response With viScanf */
/* Close the VISA Session */
/*****/
ViSession defaultRM;
ViSession instr;
ViUInt32 numInstrs;
ViFindList findList;
ViStatus status;
char instrResourceString[VI_FIND_BUFLEN];
unsigned char buffer[100];
int i;
/** First we must call viOpenDefaultRM to get the manager
 * handle. We will store this handle in defaultRM.*/
status = viOpenDefaultRM (&defaultRM);
if (status<VI_SUCCESS)
{
printf ("Could not open a session to the VISA Resource Manager!\n");
return status;
}
/* Find all the USB TMC VISA resources in our system and store the number of resources in the system
in numInstrs.*/
status = viFindRsrc (defaultRM, "USB?*INSTR", &findList, &numInstrs, instrResourceString);
if (status<VI_SUCCESS)
{
printf ("An error occurred while finding resources.\nPress 'Enter' to continue.");
fflush(stdin);
getchar();
viClose (defaultRM);
return status;
}
/** Now we will open VISA sessions to all USB TMC instruments.
 * We must use the handle from viOpenDefaultRM and we must
 * also use a string that indicates which instrument to open. This
 * is called the instrument descriptor. The format for this string
 * can be found in the function panel by right clicking on the
 * descriptor parameter. After opening a session to the
```

```
* device, we will get a handle to the instrument which we
* will use in later VISA functions. The AccessMode and Timeout
* parameters in this function are reserved for future
* functionality. These two parameters are given the value VI_NULL.*/
for (i=0; i<int(numInstrs); i++)
{
if (i> 0)
{
viFindNext (findList, instrResourceString);
}
status = viOpen (defaultRM, instrResourceString, VI_NULL, VI_NULL, &instr);
if (status<VI_SUCCESS)
{
printf ("Cannot open a session to the device %d.\n", i+1);
continue ;
}
/* * At this point we now have a session open to the USB TMC instrument.
* We will now use the viPrintf function to send the device the string "**IDN?\n",
* asking for the device's identification. */
char * cmmand ="**IDN?\n";
status = viPrintf (instr, cmmand);
if (status<VI_SUCCESS)
{
printf ("Error writing to the device %d.\n", i+1);
status = viClose (instr);
continue;
}
/** Now we will attempt to read back a response from the device to
* the identification query that was sent. We will use the viScanf
* function to acquire the data.
* After the data has been read the response is displayed. */
status = viScanf(instr, "%t", buffer);
if (status<VI_SUCCESS)
{
printf ("Error reading a response from the device %d.\n", i+1);
}
else
{
printf ("\nDevice %d: %s\n", i+1, buffer);
}
status = viClose (instr);
}
/** Now we will close the session to the instrument using
```

```
* viClose. This operation frees all system resources. */
status = viClose (defaultRM);
printf("Press 'Enter' to exit.");
fflush(stdin);
getchar();
return 0;
}
```

```
int _tmain(int argc, _TCHAR* argv[])
{
    Usbtmc_test();
    return 0;
}
```

Run result.

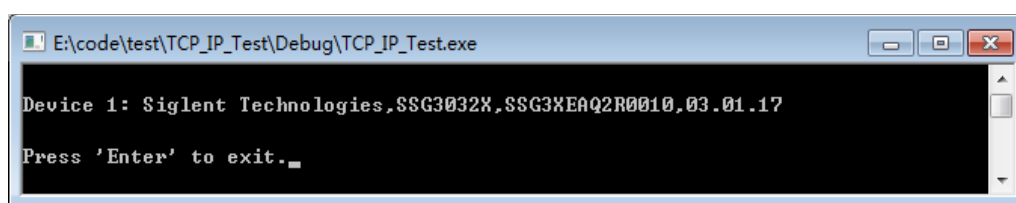

(2) TCP/IP access code.

Write a function TCP_IP_Test:

```
int TCP_IP_Test(char *pIP)
{
    char outputBuffer[VI_FIND_BUFLLEN];
    ViSession defaultRM, instr;
    ViStatus status;

    /* First we will need to open the default resource manager. */
    status = viOpenDefaultRM (&defaultRM);
    if (status<VI_SUCCESS)
    {
        printf("Could not open a session to the VISA Resource Manager!\n");
    }

    /* Now we will open a session via TCP/IP device */
    char head[256] = "TCPIP0::";
    char tail[] = "::INSTR";

    strcat(head,pIP);
    strcat(head,tail);
    status = viOpen (defaultRM, head, VI_LOAD_CONFIG, VI_NULL, &instr);
    if (status<VI_SUCCESS)
    {
```



```
printf("An error occurred opening the session\n");
viClose(defaultRM);
}
status = viPrintf(instr, "*idn?\n");
status = viScanf(instr, "%t", outputBuffer);
if (status<VI_SUCCESS)
{
printf("viRead failed with error code: %x \n",status);
viClose(defaultRM);
}
else
{
printf("\nMessage read from device: %*s\n", 0,outputBuffer);
}
status = viClose (instr);
status = viClose (defaultRM);
printf("Press 'Enter' to exit.");
fflush(stdin);
getchar();
return 0;
}

int _tmain(int argc, _TCHAR* argv[])
{
printf("Please input IP address:");
char ip[256];
fflush(stdin);
gets(ip);
TCP_IP_Test(ip);
return 0;
}
```

Run result.

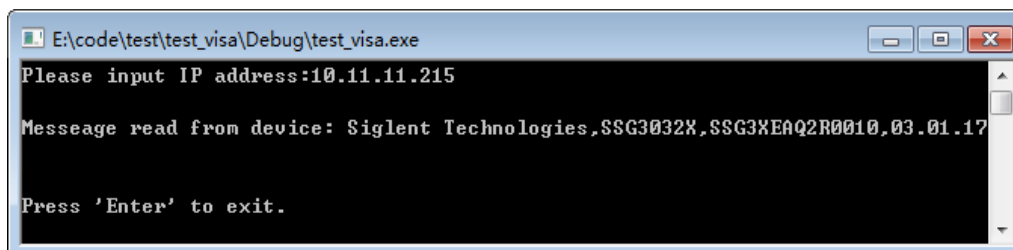

```
E:\code\test\test_visa\Debug\test_visa.exe
Please input IP address:10.11.11.215
Message read from device: Siglent Technologies,SSG3032X,SSG3XEAQ2R0010,03.01.17
Press 'Enter' to exit.
```

4.1.2 Example of VB

Environment: Win7 32bit system, Microsoft Visual Basic 6.0

The function of this example: Use the NI-VISA, to control the device with USBTMC and TCP/IP access to do a write and read.

Follow the steps to complete the example:

- 1、 Open Visual Basic, build a standard application program project (Standard EXE)
- 2、 Set the project environment to use the NI-VISA lib, Click the Existing tab of Project>>Add Existing Item. Search for the visa32.bas file in the include folder under the NI-VISA installation path and add the file.

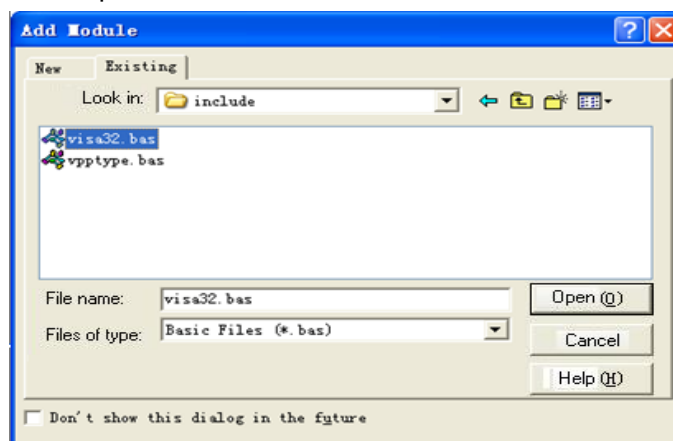

This allows the VISA functions and VISA data types to be used in a program.

- 3、 Add codes:

(1) USBTMC access code.

Write a function Usbtmc_test:

Private Function Usbtmc_test() As Long

```
' This code demonstrates sending synchronous read & write commands
' to an USB Test & Measurement Class (USBTMC) instrument using
' NI-VISA
' The example writes the "*IDN?\n" string to all the USBTMC
' devices connected to the system and attempts to read back
' results using the write and read functions.
' The general flow of the code is
' Open Resource Manager
' Open VISA Session to an Instrument
' Write the Identification Query Using viWrite
' Try to Read a Response With viRead
' Close the VISA Session
Const MAX_CNT = 200
```

```
Dim defaultRM As Long
```

```
Dim instrsesn As Long
```

```
Dim numInstrs As Long
Dim findList As Long
Dim retCount As Long

Dim status As Long
Dim instrResourceString As String * VI_FIND_BUFLEN
Dim Buffer As String * MAX_CNT
Dim i As Integer
' First we must call viOpenDefaultRM to get the manager
' handle. We will store this handle in defaultRM.
status = viOpenDefaultRM(defaultRM)
If (status < VI_SUCCESS) Then
    resultTxt.Text = "Could not open a session to the VISA Resource Manager!"
    Usbtmc_test = status
    Exit Function
End If

' Find all the USB TMC VISA resources in our system and store the
' number of resources in the system in numInstrs.
status = viFindRsrc(defaultRM, "USB?*INSTR", findList, numInstrs, instrResourceString)
If (status < VI_SUCCESS) Then
    resultTxt.Text = "An error occurred while finding resources."
    viClose(defaultRM)
    Usbtmc_test = status
    Exit Function
End If

' Now we will open VISA sessions to all USB TMC instruments.
' We must use the handle from viOpenDefaultRM and we must
' also use a string that indicates which instrument to open. This
' is called the instrument descriptor. The format for this string
' can be found in the function panel by right clicking on the
' descriptor parameter. After opening a session to the
' device, we will get a handle to the instrument which we
' will use in later VISA functions. The AccessMode and Timeout
' parameters in this function are reserved for future
' functionality. These two parameters are given the value VI_NULL.
For i = 0 To numInstrs
    If (i > 0) Then
        status = viFindNext(findList, instrResourceString)
    End If
    status = viOpen(defaultRM, instrResourceString, VI_NULL, VI_NULL, instrsesn)
    If (status < VI_SUCCESS) Then
```

```
    resultTxt.Text = "Cannot open a session to the device " + CStr(i + 1)
    GoTo NextFind
End If

' At this point we now have a session open to the USB TMC instrument.
' We will now use the viWrite function to send the device the string "*IDN?",
' asking for the device's identification.
status = viWrite(instrsesn, "*IDN?", 5, retCount)
If (status < VI_SUCCESS) Then
    resultTxt.Text = "Error writing to the device."
    status = viClose(instrsesn)
    GoTo NextFind
End If

' Now we will attempt to read back a response from the device to
' the identification query that was sent. We will use the viRead
' function to acquire the data.
' After the data has been read the response is displayed.
status = viRead(instrsesn, Buffer, MAX_CNT, retCount)
If (status < VI_SUCCESS) Then
    resultTxt.Text = "Error reading a response from the device." + CStr(i + 1)
Else
    resultTxt.Text = "Read from device: " + CStr(i + 1) + " " + Buffer
End If
status = viClose(instrsesn)
```

```
Next i
```

```
' Now we will close the session to the instrument using
' viClose. This operation frees all system resources.
status = viClose(defaultRM)
Usbtmc_test = 0
End Function
```

(2) TCP/IP access code.

Write a function TCP_IP_Test:

```
Private Function TCP_IP_Test(ByVal ip As String) As Long
    Dim outputBuffer As String * VI_FIND_BUFLEN
    Dim defaultRM As Long
    Dim instrsesn As Long
    Dim status As Long
    Dim count As Long
```

' First we will need to open the default resource manager.

```
status = viOpenDefaultRM(defaultRM)
```

```
If (status < VI_SUCCESS) Then
```

```
    resultTxt.Text = "Could not open a session to the VISA Resource Manager!"
```

```
    TCP_IP_Test = status
```

```
    Exit Function
```

```
End If
```

' Now we will open a session via TCP/IP device

```
status = viOpen(defaultRM, "TCPIP0::" + ip + "::INSTR", VI_LOAD_CONFIG, VI_NULL, instrsesn)
```

```
If (status < VI_SUCCESS) Then
```

```
    resultTxt.Text = "An error occurred opening the session"
```

```
    viClose(defaultRM)
```

```
    TCP_IP_Test = status
```

```
    Exit Function
```

```
End If
```

```
status = viWrite(instrsesn, "*IDN?", 5, count)
```

```
If (status < VI_SUCCESS) Then
```

```
    resultTxt.Text = "Error writing to the device."
```

```
End If
```

```
status = viRead(instrsesn, outputBuffer, VI_FIND_BUFLEN, count)
```

```
If (status < VI_SUCCESS) Then
```

```
    resultTxt.Text = "Error reading a response from the device." + CStr(i + 1)
```

```
Else
```

```
    resultTxt.Text = "read from device:" + outputBuffer
```

```
End If
```

```
status = viClose(instrsesn)
```

```
status = viClose(defaultRM)
```

```
TCP_IP_Test = 0
```

```
End Function
```

(3) Button control code:

```
Private Sub exitBtn_Click()
```

```
    End
```

```
End Sub
```

```
Private Sub tcpipBtn_Click()
```

```
    Dim stat As Long
```

```
    stat = TCP_IP_Test(ipTxt.Text)
```

```
    If (stat < VI_SUCCESS) Then
```

```
        resultTxt.Text = Hex(stat)
```

```
    End If
```

```
End Sub
```

SIGLENT

```
Private Sub usbBtn_Click()  
    Dim stat As Long  
    stat = Usbtmc_test  
    If (stat < VI_SUCCESS) Then  
        resultTxt.Text = Hex(stat)  
    End If  
End Sub
```

Run result:

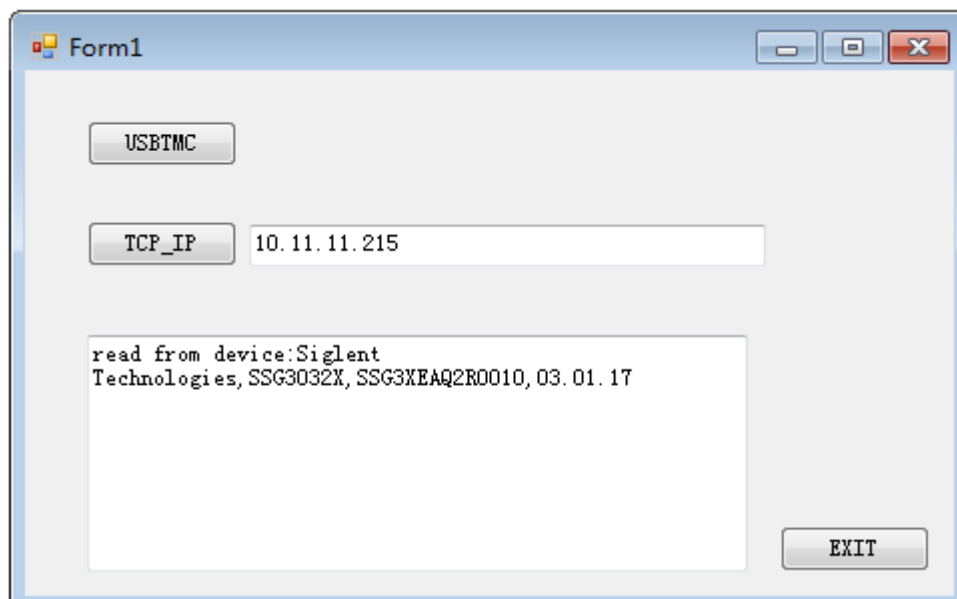

4.1.3 Example of MATLAB

Environment: Win7 32bit system, MATLAB R2013a

The function of this example: Use the NI-VISA, to control the device with USBTMC or TCP/IP access to do a write and read.

Follow the steps to complete the example:

- 1、 Open MATLAB, modify the **current directory**. In this demo, the current directory is modified to D:\USBTMC_TCPIP_Demo.
- 2、 Click **File>>New>>Script** in the Matlab interface to create an empty M file
- 3、 Add codes:

(1)USBTMC access code

Write a function Usbtmc_test.

```
function Usbtmc_test()
```

```
% This code demonstrates sending synchronous read & write commands
```

```
% to an USB Test & Measurement Class (USBTMC) instrument using
```

```
% NI-VISA
```

```

%Create a VISA-USB object connected to a USB instrument
vu = visa('ni','USB0::0xF4EC::0x1501::0123456789::INSTR');

%Open the VISA object created
fopen(vu);

%Send the string "*IDN?",asking for the device's identification.
fprintf(vu,'*IDN?');

%Request the data
outputbuffer = fscanf(vu);
disp(outputbuffer);

%Close the VISA object
fclose(vu);
delete(vu);
clear vu;

end

```

Run result:

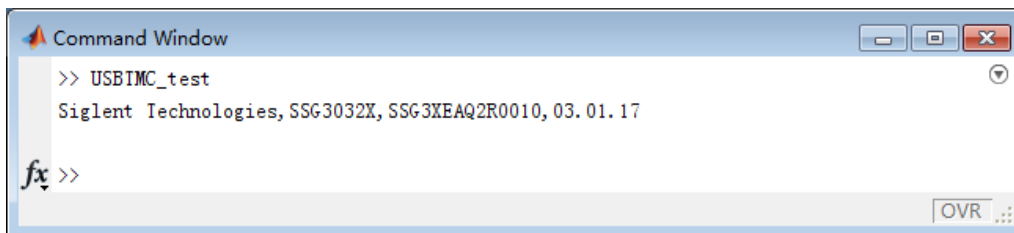

```

Command Window
>> USBIMC_test
Siglent Technologies, SSG3032X, SSG3XEAQ2R0010, 03.01.17
fx >>
OVR

```

(2)TCP/IP access code.

Write a function TCP_IP_Test:

```

function TCP_IP_test()
% This code demonstrates sending synchronous read & write commands
% to an TCP/IP instrument using NI-VISA

%Create a VISA-TCPIP object connected to an instrument
%configured with IP address.
vt = visa('ni',['TCPIP0::','10.11.11.215'],'::INSTR');

%Open the VISA object created
fopen(vt);

%Send the string "*IDN?",asking for the device's identification.
fprintf(vt,'*IDN?');

```

SIGLENT

%Request the data

```
outputbuffer = fscanf(vt);
```

```
disp(outputbuffer);
```

%Close the VISA object

```
fclose(vt);
```

```
delete(vt);
```

```
clear vt;
```

```
end
```

Run result:

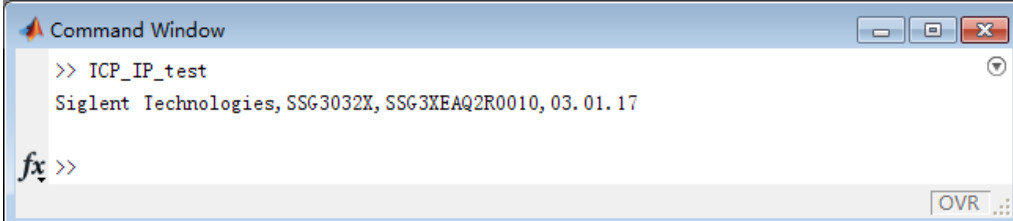

```
Command Window
>> ICP_IP_test
Siglent Technologies, SSG3032X, SSG3XEAQ2R0010, 03. 01. 17
fx >>
```

4.1.4 Example of LabVIEW

Environment: Win7 32bit system, LabVIEW 2011

The functions of this example: use the NI-VISA, to control the device with USBTMC and TCP/IP access to do a write and read.

Follow the steps to complete the example:

- 1、 Open LabVIEW, create a VI file.
- 2、 Add controls. Right-click in the **Front Panel** interface, select and add **VISA resource name**, error in, error out and some indicators from the Controls column.
- 3、 Open the **Block Diagram** interface. Right-click on the **VISA resource name** and you can select and add the following functions from VISA Palette from the pop-up menu: **VISA Write**, **VISA Read**, **VISA Open** and **VISA Close**.
- 4、 Connect them as shown in the figure below

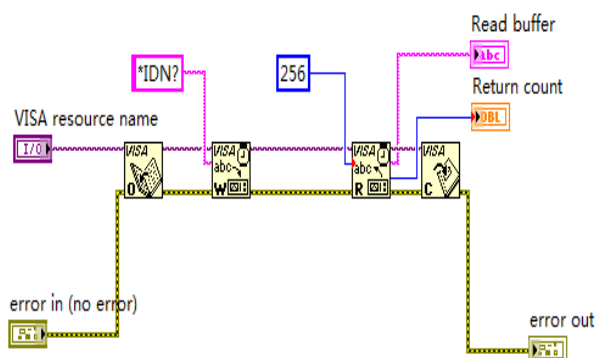

5、 Select the device resource from the VISA Resource Name list box and run the program.

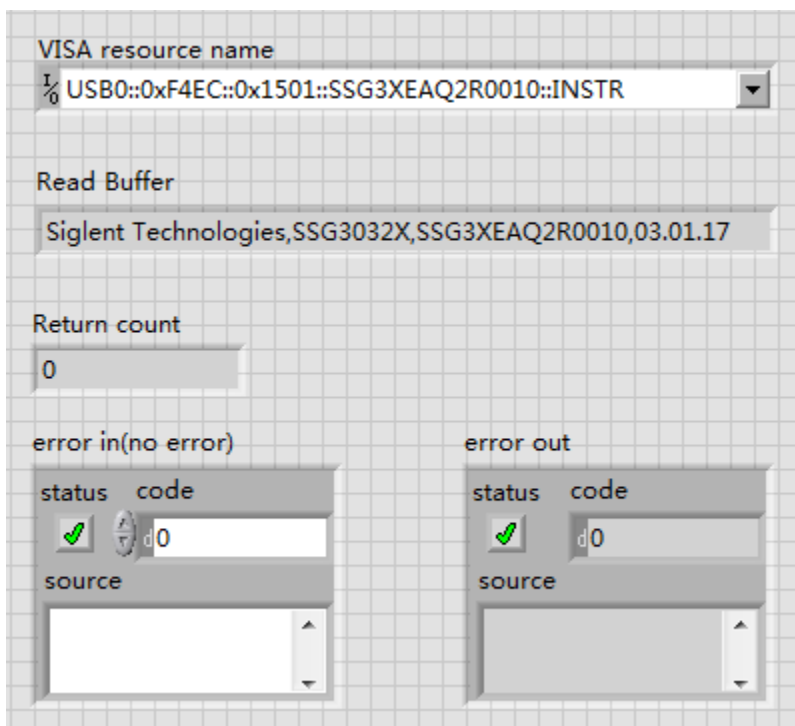

In this example, the VI opens a VISA session to a USBTMC device, writes a command to the device, and reads back the response. In this example, the specific command being sent is the device ID query. Check with your device manufacturer for the device command set. After all communication is complete, the VI closes the VISA session.

6、 Communicating with the device via TCP/IP is similar to USBTMC. But you need to change VISA Write and VISA Read Function to Synchronous I/O. The LabVIEW default is asynchronous I/O. Right-click the node and select Synchronous I/O Mod>>Synchronous from the shortcut menu to write or read data synchronously.

7、 Connect them as shown in the figure below

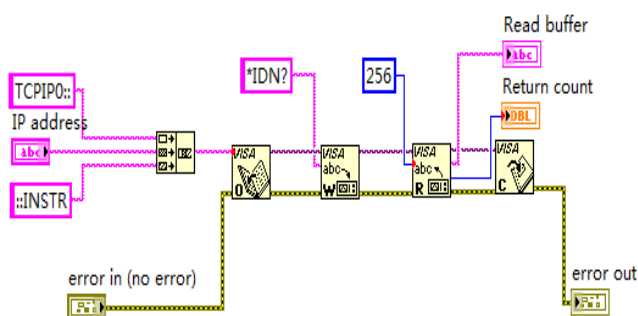

8、 Input the IP address and run the program.

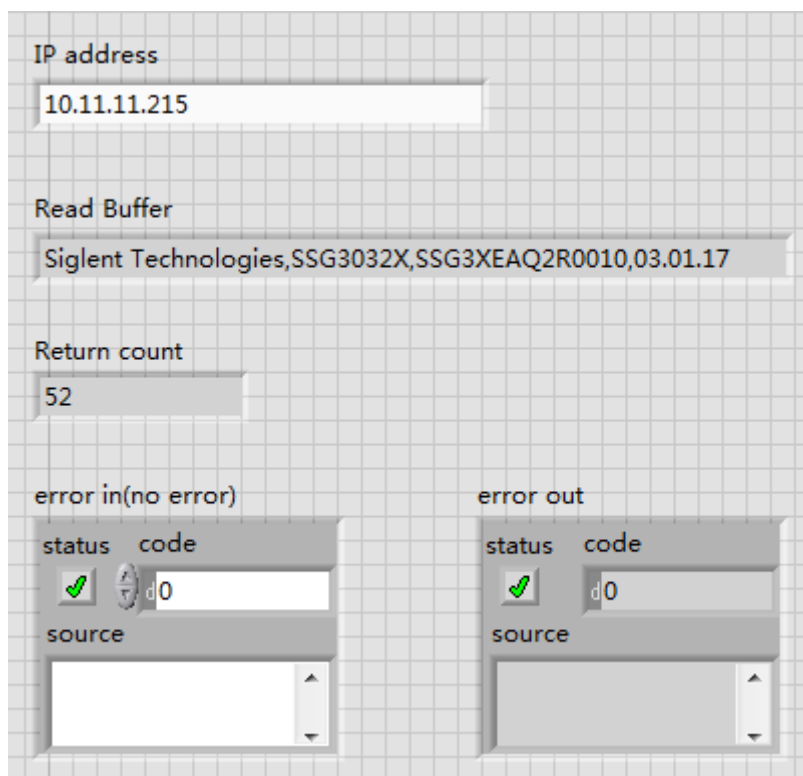

4.2 Examples of Using Socket

4.2.1 Example of Python

Python is an interpreted programming language that lets you work quickly and is very portable. Python has a low-level networking module that provides access to the socket interface. Python scripts can be written for sockets to do a variety of test and measurements tasks.

Environment: Win7 32bit system, Python v2.7.5

The functions of this example: Open a socket, sends a query, and closes the socket. It does this loop 10 times.

Below is the code of the script:

```
#!/usr/bin/env python
#-*- coding:utf-8 -*-
#-----
# The short script is a example that open a socket, sends a query,
# print the return message and closes the socket.
```

```
#-----  
import socket # for sockets  
import sys # for exit  
import time # for sleep  
#-----  
remote_ip = "10.11.13.32" # should match the instrument's IP address  
port = 5024 # the port number of the instrument service  
count = 0  
  
def SocketConnect():  
    try:  
        #create an AF_INET, STREAM socket (TCP)  
        s = socket.socket(socket.AF_INET, socket.SOCK_STREAM)  
    except socket.error:  
        print ('Failed to create socket.')        sys.exit();  
    try:  
        #Connect to remote server  
        s.connect((remote_ip , port))  
        info = s.recv(4096)  
        print (info)  
    except socket.error:  
        print ('failed to connect to ip ' + remote_ip)  
    return s  
  
def SocketQuery(Sock, cmd):  
    try :  
        #Send cmd string  
        Sock.sendall(cmd)  
        time.sleep(1)  
    except socket.error:  
        #Send failed  
        print ('Send failed')        sys.exit()  
    reply = Sock.recv(4096)  
    return reply  
  
def SocketClose(Sock):  
    #close the socket  
    Sock.close()  
    time.sleep(.300)  
  
def main():
```

SIGLENT

```
global remote_ip
global port
global count
```

```
# Body: send the SCPI commands *IDN? 10 times and print the return message
```

```
s = SocketConnect()
for i in range(10):
    qStr = SocketQuery(s, b'*IDN?')
    print (str(count) + ":: " + str(qStr))
    count = count + 1
SocketClose(s)
input('Press "Enter" to exit')
```

```
if __name__ == '__main__':
    proc = main()
```

Run result:

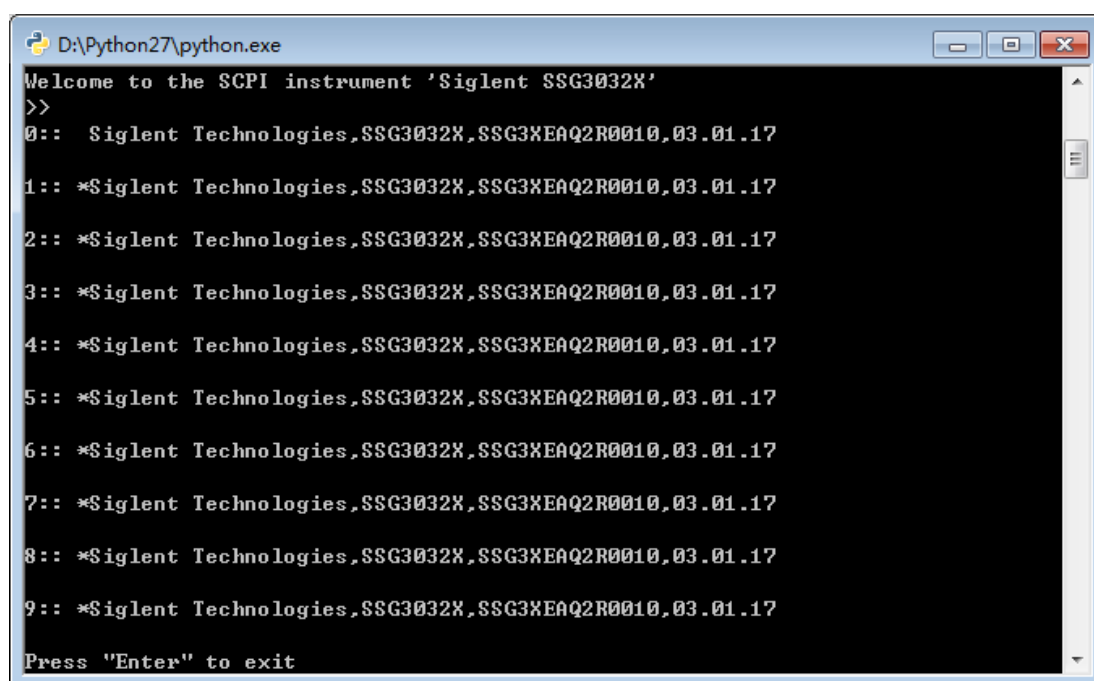

```
D:\Python27\python.exe
Welcome to the SCPI instrument 'Siglent SSG3032X'
>>
0:: Siglent Technologies,SSG3032X,SSG3XEAQ2R0010,03.01.17
1:: *Siglent Technologies,SSG3032X,SSG3XEAQ2R0010,03.01.17
2:: *Siglent Technologies,SSG3032X,SSG3XEAQ2R0010,03.01.17
3:: *Siglent Technologies,SSG3032X,SSG3XEAQ2R0010,03.01.17
4:: *Siglent Technologies,SSG3032X,SSG3XEAQ2R0010,03.01.17
5:: *Siglent Technologies,SSG3032X,SSG3XEAQ2R0010,03.01.17
6:: *Siglent Technologies,SSG3032X,SSG3XEAQ2R0010,03.01.17
7:: *Siglent Technologies,SSG3032X,SSG3XEAQ2R0010,03.01.17
8:: *Siglent Technologies,SSG3032X,SSG3XEAQ2R0010,03.01.17
9:: *Siglent Technologies,SSG3032X,SSG3XEAQ2R0010,03.01.17
Press "Enter" to exit
```

4.2.2 Example of Telnet

Telnet SCPI: Provides the ability to send single SCPI commands from a remote PC to the signal generator using LAN port number 5024.

How to send single SCPI commands using Telnet:

1. On the remote PC, click Start, then Run

2. Type: **telnet** <ip address> **5024**
3. A Telnet window with a >> prompt should appear on the remote PC screen.

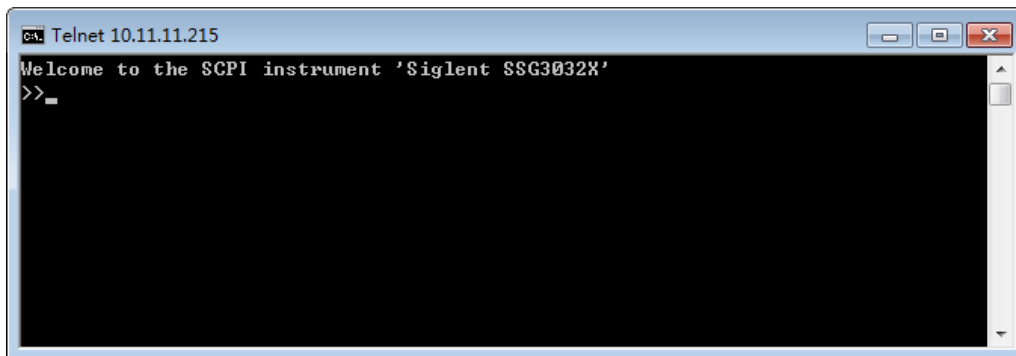

```
Ca. Telnet 10.11.11.215
Welcome to the SCPI instrument 'Siglent SSG3032X'
>>_
```

4. From the SCPI prompt:
 - Type single SCPI commands. Press Enter to send the command.

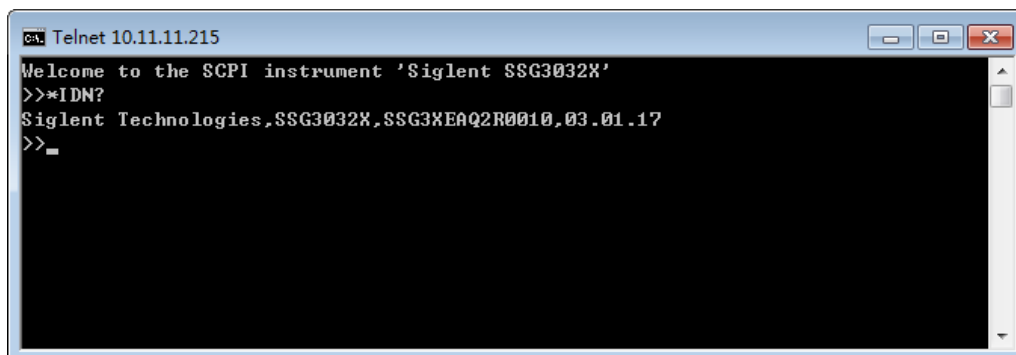

```
Ca. Telnet 10.11.11.215
Welcome to the SCPI instrument 'Siglent SSG3032X'
>>*IDN?
Siglent Technologies,SSG3032X,SSG3XE0Q2R0010,03.01.17
>>_
```

- To exit the telnet window click X in the upper-right corner.
- To get a normal telnet prompt, press Ctrl +] (closing bracket).

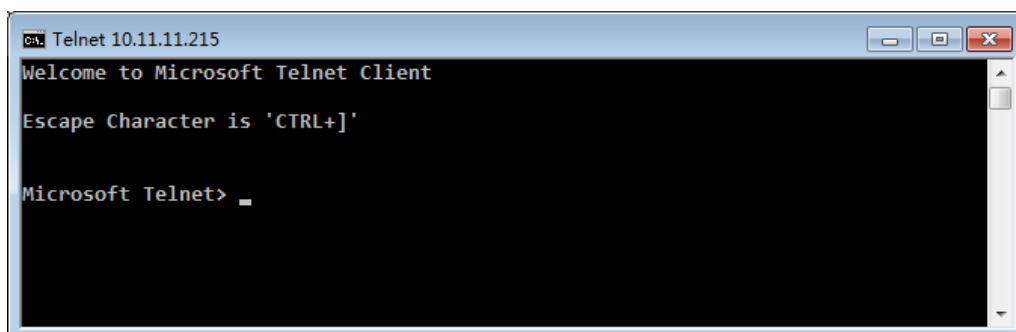

```
Ca. Telnet 10.11.11.215
Welcome to Microsoft Telnet Client
Escape Character is 'CTRL+]'
Microsoft Telnet> _
```

- To get SCPI prompt again, type open <ip Address> 5024.

SIGLENT

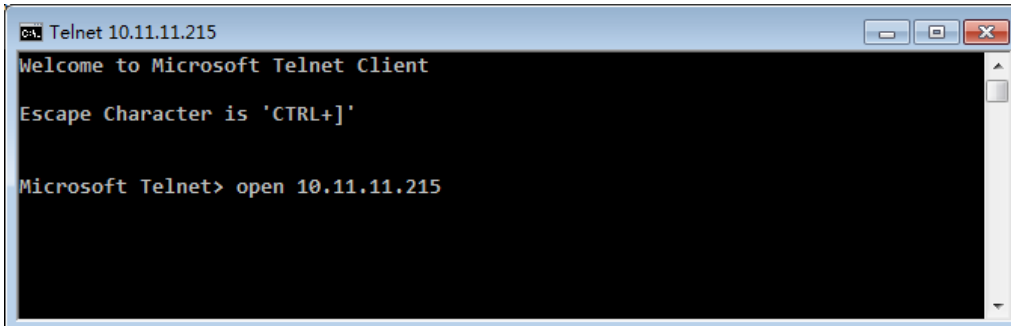

```
Ca: Telnet 10.11.11.215
Welcome to Microsoft Telnet Client
Escape Character is 'CTRL+]'

Microsoft Telnet> open 10.11.11.215
```

Press **Enter**:

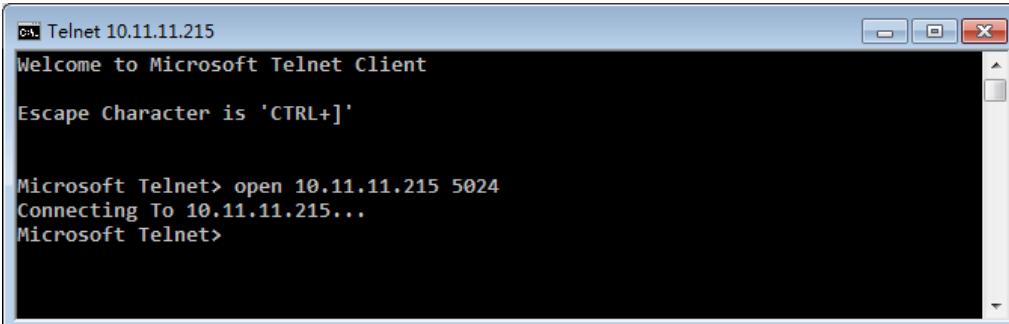

```
Ca: Telnet 10.11.11.215
Welcome to Microsoft Telnet Client
Escape Character is 'CTRL+]'

Microsoft Telnet> open 10.11.11.215 5024
Connecting To 10.11.11.215...
Microsoft Telnet>
```

- To close the normal telnet window, type **Quit** and press **Enter**.