



An ITW Company

Benchtop Ionizing Blower

Aerostat® PC2

INSTALLATION AND OPERATING INSTRUCTIONS

TABLE OF CONTENTS

1. SAFETY WARNINGS.....	1
2. DESCRIPTION.....	2
Product Features.....	2
Performance.....	3
Power Requirements.....	4
3. SPECIFICATIONS.....	5
4. INSTALLATION.....	6
Important Safety Information.....	6
Placement & Mounting.....	6
Power Connections.....	8
5. OPERATION.....	9
Operating Environment.....	9
Controls & LED Indicators.....	9
Balance.....	10
Alarms.....	11
FMS Relay Contact.....	13
Optional Air Filter.....	13
6. MAINTENANCE.....	14
Scheduling.....	14
Cleaning.....	14
7. TROUBLESHOOTING.....	16
8. PARTS & ACCESSORIES.....	17
9. WARRANTY.....	18

1. SAFETY WARNINGS

Carefully read the following safety information before installing or operating the equipment.

Failure to follow these safety warnings could result in damage to your ionization system and/or voiding the product warranty.

This instruction manual uses symbols to identify dangerous situations as follows:

GENERAL SAFETY

 **NOTE** – Statements identified with **NOTE** indicate precautions necessary to avoid potential equipment failure.

 **CAUTION** – Statements identified with **CAUTION** indicate potential safety hazards.

 **WARNING** – Statements identified with **WARNING** indicate potential serious injury hazards.

PRODUCT SAFETY

 **NOTE** – Do not attempt to operate at voltages other than those specified.

 **NOTE** – Do not allow dust, dirt or debris to block or obstruct air flow inlets or outlets.

 **NOTE** – This equipment must be correctly installed and properly maintained. Adhere to the following notes for safe installation and operation:

1. Read instruction manual before installing or operating equipment.
2. Only qualified service personnel are to perform installation and repairs.
3. All equipment must be properly grounded, including the machine frame to which the equipment is mounted.
4. Turn off input power to unit before connecting or disconnecting other equipment.
5. Do not operate the system in close proximity to fumes and flammable liquids.

 **WARNING – Electric Shock Hazard**
Electrical installation and repairs must be performed by a skilled electrical engineer according to the applicable national and local regulations. The equipment must be properly grounded. Grounding is required to ensure safe and proper operation and to prevent electrical shocks upon contact.

 **WARNING – Fire Hazard**
Keep the unit dry. Do not operate the unit in flammable or explosive environments.

2. DESCRIPTION

Simco-Ion's Aerostat PC2 is a lightweight, high-performance benchtop ionizer featuring a three-speed fan for varying applications. The Aerostat PC2 small footprint design occupies much less workspace than traditional blowers. With its universal mounting stand, the Aerostat PC2 can be used at virtually any location to control static charge where contamination, ESD, material-handling problems, or microprocessor lock-up occurs. The Aerostat PC2 is also light enough to be easily mounted above workstations for space-constrained benchtop areas.

The Aerostat PC2 uses the Simco-Ion patented "Micropulse" Technology to meet the performance, particle cleanliness, and low maintenance requirements necessary to maximize production yield in many applications.

The Aerostat PC2 is available with an optional heater to reduce the effects of wind chill.

This manual covers the installation, operation, and maintenance of the Aerostat PC2 Ionizing Blower.

Product Features

The Aerostat PC2 has the following unique features and benefits:

- Patented "Micropulse" Technology with high-efficiency output that provides long periods between maintenance cycles
- Internal closed-loop feedback control maintains balance at +/-10V or better
- LEDs and audible alarm (if ordered) for both high voltage fault and fan status
- Employs a high efficiency, multi-speed fan to produce a strong ionized airflow
- Built-in brush cleaner for easy, periodic cleaning of emitters
- Universal AC input accepts all IEC power cords
- A relay contact is provided for monitoring of ionizer's operational status via the end user's facility monitoring system (FMS)
- An optional heater for reducing the wind chill effect (an optional feature available at the at the time of purchase)

Front Panel

1. Emitter Point Cleaner
2. Status Lights: Power, Fan, Fault
3. Power Switch



Figure 1. Aerostat PC2 Front-panel
(non-heater version)

Rear Panel

1. Fan Speed Switch
2. Balance Adjust
3. FMS Output
4. Ground
5. Fuse Holder
6. Power Cord Clamp
7. Power Cord Inlet



Figure 2. Aerostat PC2 Rear Panel

Performance

The Model Aerostat PC2 is factory adjusted to meet the specifications described below:

- 2.0 seconds or less @ 12" (30 cm)
- 3.0 seconds or less @ 24" (60 cm)
- 5.0 seconds or less @ 36" (91 cm)
- 8.0 seconds or less @ 48" (122 cm)

These decay times are directly in line with the center of the fan, $\pm 1000V$ to 100V. Measurements were taken at the stated distance at high fan speed using a charged plate monitor in accordance with ESD Association Ionization Standard ANSI/ESD STM3.1-2015.

Discharge times may be different when tested within your operating environment.

The PC2 will maintain a balance around zero of $\pm 10V$ or less in a humidity-controlled environment. Performance in extreme environments may vary. When using the optional fan filter, the unit's performance will be reduced between 10-40% depending upon the speed of the blower and the distance to the target.

Power Requirements





The Aerostat PC2 requires different input voltages depending on heater or without heater.

- 100-230 VAC, 50/60 Hz, 0.2A, 10W max (no heater)
- 100-120 VAC, 50/60 Hz, 2.0A, 250W max (with heater)
- 220-230 VAC, 50/60 Hz, 1.0A, 250W max (with heater)



CAUTION – The use of improper input voltage may result in poor performance or damage to the unit. Damage caused to the power supply from operation at levels outside the specified limits will void the warranty.

3. SPECIFICATIONS

Input Voltage	100-230 VAC, 50/60 Hz, 0.2A, 10W max, fuse 0.63A 250V Slo-Blo 120V Heater Option: 100-120 VAC, 50/60 Hz, 2.0A, 250W, fuse 2.5A 250V Slo-Blo 220V Heater Option: 220-230 VAC, 50/60 Hz, 1.0A, 250W, fuse 1.6A 250V Slo-Blo
Discharge¹	2.0 sec @ 1' (30 cm) (1000-100V high fan speed)
Balance	0 ±10V (typ)
Coverage	1'W x 4'L (30 x 122 cm) area
Ion Emission	Micropulse AC Ionization
Emitters	Stainless Steel emitter points
Controls	POWER ON/OFF, FAN SPEED control LOW/MEDIUM/HIGH
Indicators	Green POWER on, red FAN alarm, red FAULT alarm LEDs
Audible Alarm	Fault and Fan stall (optional)
FMS Connector	RJ-9 4P/4C receptacle, relay contact rated +/-24 VDC @ 0.2A max
Air Volume	129 cfm (high fan speed)
Air Velocity²	370 fpm @ 12", 240 fpm @ 24", 164 fpm @ 36", 120 fpm @ 48" (high fan)
Audible Noise	61 dB (low fan speed), 64 dB (high fan speed) measured 2' in front of blower
Ozone	<0.05 ppm measured @ 1' (305 mm) in front of blower
Operating Env.	Temperature 50-95°F (10-35°C); humidity 30-60% RH, non-condensing
Mounting Stand	Powder-coated aluminum with skid resistant rubber feet
Enclosure	Powder-coated aluminum
Air Filter	30 ppi open cell foam filter with bracket (optional)
Dimensions	9.1"H x 6.8"W x 3.3"D (23.1H x 17.3W x 8.4D cm) with stand
Weight	2.8 lbs (1.25 kg) with stand with skid resistant rubber feet
Warranty	Two-year limited warranty
Certifications	    

1. Tested in accordance with ANSI/ESD STM3.1-2015.

2. High fan speed; velocity in fpm measured at centerline of the air stream.

4. INSTALLATION

Important Safety Information

Carefully read the following safety information before installing or operating the equipment. Failure to follow these safety warnings could damage to your ionization system and/or void the product warranty.

- The use of improper input voltage may result in poor performance or damage to the ionizer will also void the warranty.
- This product is supplied with a 3-prong grounding plug, which must be inserted in an appropriate, properly wired, and grounded receptacle. Do not defeat the electrical ground. For safety, the use of extension cords is not recommended.
- Do not use this Blower in an explosive environment. Poorly maintained Ionizers could produce miniscule electric arcs along the emitter which may cause detonation in an explosive environment. Read Section 4 Power Connections and Section 5 Operating Environment before applying power to the unit.
- Avoid personal injury or damage to the equipment, do not perform any maintenance other than that contained in these instructions. Do not insert anything within the intake or outlet grills.
- There are no user-replaceable parts for this blower other than the power fuse. Any unauthorized service will void the warranty and may result in additional repair charges. Contact your local Simco-Ion representative if the blower requires service or repair.
- For indoor use only in a non-condensing environment. This product is not intended for use in tropical climate regions or at altitudes above 2000m.
- Before performing any recommended maintenance, ensure the unit is powered off and unplugged.

Placement & Mounting

Placement

The PC2 should be positioned to cover as much of the target area as possible with the ionized air stream. Keep at least a 6 inches clearance between walls or any objects and the rear of the PC2 to allow for adequate air intake.

The Aerostat PC2 should be placed approximately 1 to 4 feet (0.3 to 1.2m) from neutralized objects or the critical work area. Discharge times are longer the further away the PC2 is placed from the target area. Testing by Simco-Ion has shown that the PC2 can ionize a target area further than 4 feet from the blower.

Operate the Aerostat PC2 ionizer for an initial 24 hours in application area before any performance measurements are conducted.

Mounting

The Aerostat PC2 comes with a mounting stand pre-assembled to the Blower. The mounting stand is designed for a free or fixed position on a tabletop or workbench and mounting to a fixed surface. Holes in the base of the stand are provided for securing the PC2 to a fixed location using 1/4" (or M6) threaded hardware (not provided). Self-adhesive skid-resistant rubber feet are supplied with the Blower and can be installed on the bottom of the stand by the end-user.

Once the Aerostat PC2 is secured to a surface, the mounting stand can be adjusted and locked to the desired position. Loosen, but do not completely remove, the knobs on each side of the blower. Tilt the PC2 to the desired position, so the PC2 ionized airstream is aimed directly at the target with no intervening grounded objects and re-tighten the knobs to lock the PC2 into place.

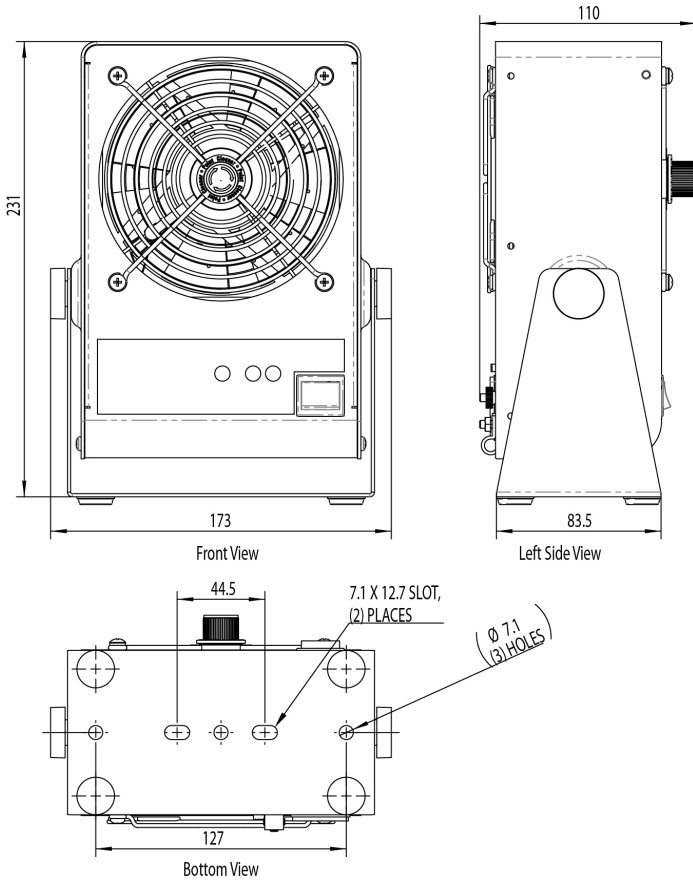

Figure 3. Aerostat PC2 Mounting (dimensions shown are in mm)

Power Connections

The PC2 accepts universal AC input (100-230 VAC 50/60 Hz single phase, no heater option only). The PC2 is available with different line cords to meet the main power connection plug requirements in many world areas. The PC2 must be grounded for safe and proper operation.

Connect the supplied power cord to an appropriate 3-terminal grounded AC power receptacle.

If the PC2 Blower is installed in an environment that is electrically noisy area, an additional ground connection can be made to the Blower using the convenience ground terminal located on the rear panel of the blower.

A cord clamp is supplied with the blower. Use this cord clamp to prevent unwanted disconnection of the power cord or protect against the accidental loosening of the power cord due to vibration.

After connecting the power cord to the power inlet connector, fit the power cord through the cord clamp and secure the clamp to the rear chassis panel with the supplied #6 nut.

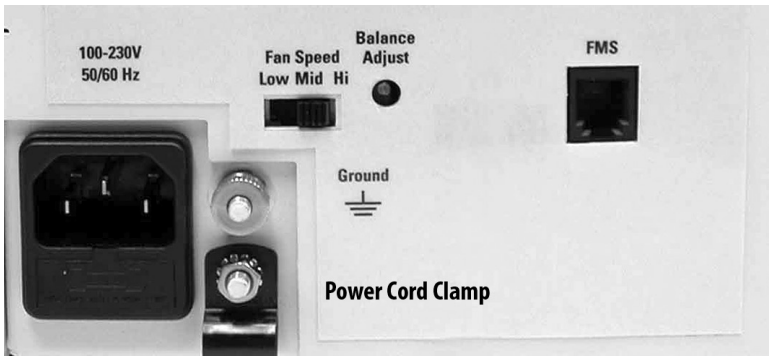

Figure 4. Chassis Ground Stud and Power Cord Clamp

5. OPERATION

Operating Environment



WARNING – Electric Shock Hazard

Do not insert anything within the intake or outlet grills. Electric shock may result.

The output side of the Blower should not be tilted more than 10 degrees upward above the vertical plain blowing across a work surface/table. This is to prevent any object from penetrating the unit from the output side—electric shock may result.

Operate the Model Aerostat PC2 in an environment where the relative humidity is 30-60% (non-condensing). The operating temperature range for the Blower is 50-95°F (10-35°C).

The Model Aerostat PC2 will conform to stated performance specifications when used in an environment that meets the cleanliness limits defined by ISO 14644-1 Class 6 (Fed Std. 209E Class 1000) and if it is serviced according to an appropriate maintenance schedule.

- For indoor use only in a non-condensing environment
- Do not use this Blower in an explosive environment
- The PC2 Blower is not intended for Tropical Climate regions
- The PC2 Blower is not intended for use at altitudes above 2000m

Controls & LED Indicators

Power

Turn on the PC2 by setting the "POWER" switch on the front panel to the ON position ("I"). The green LED "Power" indicator light on the front panel will light, and the fan will startup.

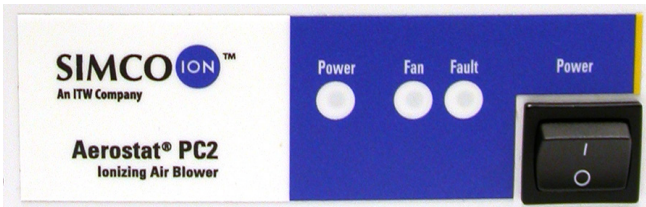

Figure 5a. Power on LED and Power on Switch (non-heater version)

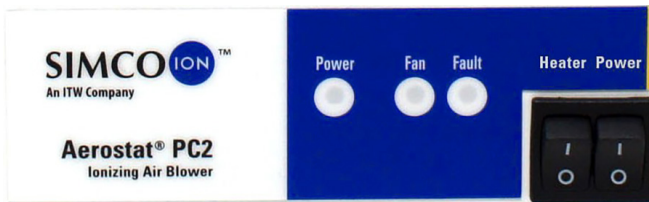

Figure 5b. Power on LED and Power on Switch (heater version)

Fan Speed Adjustment

The fan speed may be adjusted using the Fan Speed slide switch on the back of the Aerostat PC2. The PC2 fan can be set to Low, Medium or High airflow.



Figure 6. Fan Speed Adjustment Switch

Heater ("H" Model Only)

Turn the heater ON by setting the "HEATER" rocker switch to the on ("I") position. NOTE: The heater will only operate when the fan is on.

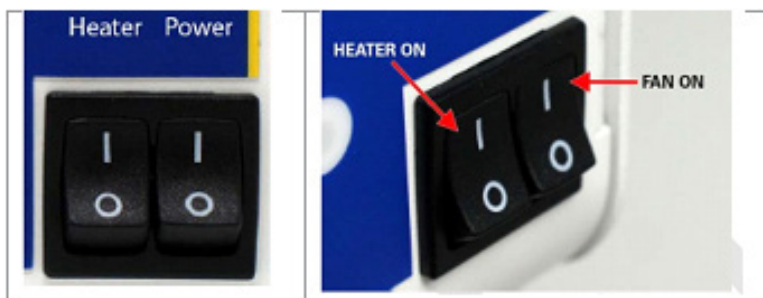

Figure 7. Switches

The heater provides about a 2-3°C rise in the temperature of the ionized air at the face of the Blower, which is just enough to counter the effects of wind chill. The PC2 heater is not meant to act as a space heater.

If the HEATER switch is turned on and the FAN switch is turned off the heater automatically stops. The PC2 heater is protected with a thermal cutout device that will deactivate the heater in the case of overheating, such as inadequate airflow due to a failed fan.

Balance

The Aerostat PC2 has a balance adjust control for setting the initial balance of the Blower. The internal feedback control system will then maintain the balance of the PC2 to +/-10V around the initial balance set point.

The Aerostat PC2 leaves the factory with the Balance Adjust Control set to meet performance specifications during the final factory test. For optimal performance, it is recommended that the PC2 balance setting be checked and adjusted (if required) by the end-user prior to using the Blower. A Charged Plate Monitor (CPM) with a standard 6" x 6" plate, such as the Simco-Ion Model 280A, is required to monitor the balance of the ionizer during the balance adjustment procedure.

 **NOTE** – It is recommended that the PC2 be allowed to run and acclimatize for an initial 12-24 hours in an environment comparable to the application area before any performance measurements are conducted.

1. Set the PC2 fan to the desired speed.
2. Place a Charged Plate Monitor at a distance of about 12" (300 mm) directly in front of the blower with the CPM plate positioned in the ionized air stream. Turn on the CPM and set it for balance monitoring. Observe the balance reading displayed by the CPM.
3. Use a trimpot tool or small flat blade screwdriver to adjust the "Balance" control on the rear panel of the PC2. Turning the balance adjust control clockwise will make the balance voltage more positive. Turning the control counterclockwise will make the balance more negative.

The PC2 should be adjusted so that the CPM displays a balance of about 0V +/-5V.

 **NOTE** – For PC2 with heater option, it is important to re-balance the unit by adjusting the trimpot clockwise or counterclockwise when the heater is turned ON or OFF to achieve the specification performance.

Simco-Ion recommends using the built-in brush emitter point cleaner daily for optimum balance performance. This will ensure that the Aerostat PC2 provides the best decay and balance performance to your target area.

The Aerostat PC2 Blower should be OFF when using the emitter point cleaner. Do not clean the emitter points while the Blower is operating.

Alarms

An alarm condition may be caused by any of the following:

- No power to the fan unit
- The fan in locked-rotor condition or fan failed
- Failed high voltage power supply
- Extremely dirty emitter points (possible)

If you have ordered the Aerostat PC2 with an audible alarm, the audible alarm will sound upon any alarm condition.

There are 2 red LED indicators located on the front panel:

1. **FAN:** When constantly lit, the fan is not rotating properly (stalled fan). This alarm will clear itself if the fan can resume normal operation.
2. **FAULT:**
 - Constantly lit: No high voltage on the emitters. A constant FAULT indicator can be cleared by correcting the fault condition and cycling the power to the Blower OFF and ON again.
 - Blinking: High voltage is ON, but \pm ionization is not controlled. A blinking FAULT indicator will clear if the ionization control condition is corrected. (Suggestion: clean the emitter points using the built-in brush).

When either the FAN stalls or FAULT-HV FAILS conditions occur, the Blower will try to recover. The Blower will wait about 5 sec, then clear all the alarms (clearing the LEDs and the FMS relay) and turn on the high voltage again. If the fault condition still exists, the retry cycle will repeat up to two times. If the Blower fails to recover after 3 attempts, the high voltage will remain off, and the Blower will remain in an alarm state until the input to the Blower is cycled OFF/ON.

Condition	LED Status Indicators			FMS Relay Output	Ionization Voltage State
	POWER (Green)	FAN (Red)	FAULT (Red)		
Power OFF	OFF	OFF	OFF	Open	OFF
Power ON, All Ok	ON	OFF	OFF	Closed	ON
HV Fault	ON	OFF	ON	Open	OFF
FAN Fault	ON	ON	OFF	Open	OFF
Low 24 VDC	Blinking	OFF	OFF	Closed	ON
HV Drive Error	ON	OFF	Blinking	Open	ON

Table 1. Alarms and LED Status Indicators



NOTE – The alarm of the Aerostat PC2 is not designed or calibrated to function as a maintenance alarm. If the emitter points are allowed to become extremely dirty, there is the possibility that the Ionization fault alarm will start to turn ON intermittently. If this happens, clean the emitter points following the procedures described in Section 6 Cleaning.

FMS Relay Contact

The Aerostat PC2 provides an optoisolated relay contact for indicating alarm status to your process equipment or facility monitoring system (FMS). The relay contact is rated for a maximum of +/-24 VDC, 0.20A

- Relay Open - Blower is in alarm or Power is OFF
- Relay Closed - Normal Blower operation



Pin	Function
1	Ground
2	Relay Contact 2
3	Relay Contact 1
4	No Connection

Table 2. FMS Output Connection RJ-9

Optional Air Filter

An optional air filter kit is available for extremely dirty or dusty environments. The air filter kit includes a 30 ppi polyurethane open-cell foam air filter that mounts over the rear fan guard using a stamped metal frame and separate sheet metal screws. No disassembly of the original rear fan guard is required. The foam air filter can be cleaned and reused. Simco-Ion also offers a replacement filter pack (see Section 8 Parts and Accessories).

! **NOTE** – When using the optional fan filter, the unit's performance will be reduced between 10-40% depending upon the speed of the Blower and the distance to the target.

6. MAINTENANCE

Scheduling

The balance of the Model Aerostat PC2 is designed to be maintained by internal circuitry and, after initial setup, should not need further adjustment by the end-user.

The PC2 requires little or no user maintenance other than regular cleaning of the emitter points with the built-in brush emitter cleaner or more extensive cleaning of the emitter points, case, and fan.

 **NOTE** – Simco-Ion recommends using the built-in brush emitter point cleaner daily. This will ensure that the Aerostat PC2 provides the best decay and balance voltage performance to your target area.

The Aerostat PC2 blower should be OFF when using the emitter point cleaner. Do not clean the emitter points while the Blower is operating.

Maintenance schedules will vary depending on environmental conditions. Therefore, determine a schedule that meets the requirements of your application and environment.

 **CAUTION** – Before performing any of the following cleanings, be sure the Aerostat PC2 is powered OFF and unplugged.

Avoid personal injury or damage to the equipment, do not perform any maintenance other than that contained in these instructions.

There are no user-serviceable parts inside this Blower other than the input power fuse. Any unauthorized service will void the warranty and may result in additional repair charges.

Cleaning

Built-in Emitter Point Cleaning Brush

Use the built-in emitter point cleaning brush for routine daily cleaning of the emitter points.

 **CAUTION** – Avoid personal injury or damage to the equipment, do not perform any maintenance other than these instructions.

Before performing any of the following cleanings, be sure the Model Aerostat PC2 is powered off and unplugged.

DO NOT ATTEMPT ANY MAINTENANCE OPERATIONS TO THE BLOWER UNLESS THE UNIT IS SWITCHED OFF AND DISCONNECTED FROM AC POWER.

Turn OFF the PC2 and disconnect the power cord from the rear of the unit.

With the PC2 turned OFF, routine emitter cleaning can be accomplished by manually rotating the knob on the front of the fan grill in a clockwise direction

(about one full rotation) to sweep the internal brush over the tips of the emitter points. At the end of the clockwise rotation, release the knob and allow the brush to spring back to its resting position. Repeat this brushing operation 3 to 5 times to ensure maximum cleaning of the emitter point tips.



Figure 8. Manual Emitter Point Cleaning

Comprehensive Cleaning

Recommended cleaning materials for comprehensive cleaning:

- Lint-free cleaning cloths
- Lint-free cloth swabs (polyester cloth is recommended)
- Cleaning solution of 50% IPA (electronic-grade isopropanol alcohol)/50% de-ionized water
- Clean dry air (CDA)

The fan guards on the front and rear of the PC2 should be kept clean to prevent any airflow restriction. They can be cleaned with a soft brush, vacuum cleaner, or blown off with compressed clean, dry air.

Use clean dry compressed (CDA) air to clean dust or dirt from the inside of the unit.

After cleaning, reconnect the power cord to the unit and turn on the PC2. Allow the PC2 to run for at least five minutes before using it to ionize your target area.

Chassis Cleaning

Thoroughly wipe down the PC2 chassis to remove any accumulated dirt. Moisten a lint-free cloth with a 50% diluted IPA solution. Change the cloth frequently to make sure the dirt is completely lifted.

7. TROUBLESHOOTING

The table below provides a quick troubleshooting reference for the Aerostat PC2.

If the solutions listed do not remedy the problem, contact Simco-Ion Customer Service at customerservice@simco-ion.com.

Problem	Possible Cause	Solution
Fan is noisy or slow	Fan is obstructed	Check fan guards for any obstructions
Fan does not operate	Poor power connection or fan is obstructed	Check power cords and connections Check fan guards for obstructions Check inlet fuse (see below)
Offset balance is >10V	Emitter points are dirty	Clean the emitter points
Decay times are too long	Emitter points are dirty	Clean the emitter points
Fault Alarm Blinks intermittently	Emitter points are dirty	Clean the emitter points
FAN Alarm is on continuously	Fan has stopped	Check fan guards for any obstructions
Fault Alarm is on continuously	Possible HV failure or fan has stopped	Contact Simco-Ion for service



CAUTION – Turn OFF the Model PC2 and disconnect it from power before attempting to access the fuse drawer.

Replace the fuse only with an identically rated part. If replacing the fuse does not restore the unit to operation, leave the unit turned OFF and disconnected from power. Contact Simco-Ion technical support for additional information.

- 100-230 VAC, 50/60 Hz, 0.2A, 10W max (no heater); fuse = 0.63A SLO
- 100-120 VAC, 50/60 Hz, 2.0A, 250W max (with heater); fuse = 2.5A SLO
- 220-230 VAC, 50/60 Hz, 1.0A, 250W max (with heater); fuse = 1.6A SLO

8. PARTS & ACCESSORIES

Contact Simco-Ion Customer Service at customerservice@simco-ion.com for more information about these replacement parts and accessories.

33-6501-01	Aerostat PC2 Air Filter Kit
33-6004-01	Aerostat PC2 Replacement Air Filters (6 pack)

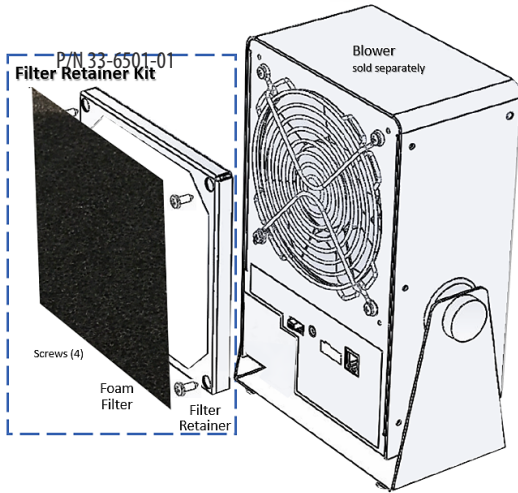

9. WARRANTY

This product has been carefully tested at the factory and is warranted to be free from any defects in materials or workmanship. Simco-Ion will, under this warranty, repair or replace any equipment that proves, upon our examination, to have become defective within one year from the date of purchase.

The equipment being returned under warranty should be shipped by the purchaser to Simco-Ion, 2257 North Penn Road, Hatfield PA 19440, transportation prepaid and insured for its replacement cost. Prior to returning any goods for any reason, contact Simco-Ion Customer Service at (215) 822-6401 for a Return Authorization Number. This number must accompany all returned items.

This warranty does not apply when the equipment has been tampered with, misused, improperly installed, altered, has received damage through abuse, carelessness, accident, connected to improper line voltage, or has been serviced anyone other than an authorized factory representative.

The warranty does not apply when Simco-Ion parts and equipment have been energized by other than the appropriate Simco-Ion power supply or generator, or when a Simco-Ion power supply or generator has been used to energize other than Simco-Ion parts and equipment. Simco-Ion makes no warranty, expressed or implied, nor accepts any obligation, liabilities, or responsibility in connection with the use of this product other than the repair or replacement of parts stated herein.

Simco-Ion

2257 North Penn Road
Hatfield, PA 19440

(215) 822-6401

(800) 203-3419

www.simco-ion.com

customerservice@simco-ion.com



© 2022 Simco-Ion Printed in the U.S.A.