



Cleanroom-rated Overhead Ionizing Blower

GUARDIAN CR2000

Simco-Ion's Guardian CR2000 Cleanroom-rated Overhead Ionizing Blower is designed specifically for use in cleanroom applications. The Guardian CR2000 features a patented circuit that results in a balanced delivery of positive and negative ions, which ensures that the unit will maintain an ion balance of $0 \pm 10V$. Balance stability is further enhanced by the use of Simco-Ion's unique "ion shields" at the fan outputs to reduce parasitic ion loss.

The Guardian CR2000 ensures cleanroom compatibility with all fan and air bearing silicone-free surfaces. Fan assemblies are particle-tested to ISO 14644 Class 4 (Fed Std. 209E Class 10) particle limits.

The Guardian CR2000 is also equipped with Simco-Ion's patented built-in emitter point cleaner. A lockout switch prevents tampering with the desired performance level. Built-in balance and ion output monitors verify the presence of balanced, ionized air. A standard power outlet on each Guardian CR2000 blower allows for daisy-chaining up to 10 units.

Unlike some overhead ionizers which link to an external device to provide real-time monitoring, the Guardian CR2000 has sophisticated internal monitoring circuitry which assures that the unit is ionizing and that the balance circuit is functioning.



Features

- Inherently balanced to $0 \pm 10V$
- Ion balance and ion output monitors
- Lockout key switch
- Silicone-free component surfaces
- Integrated emitter point cleaner

Benefits

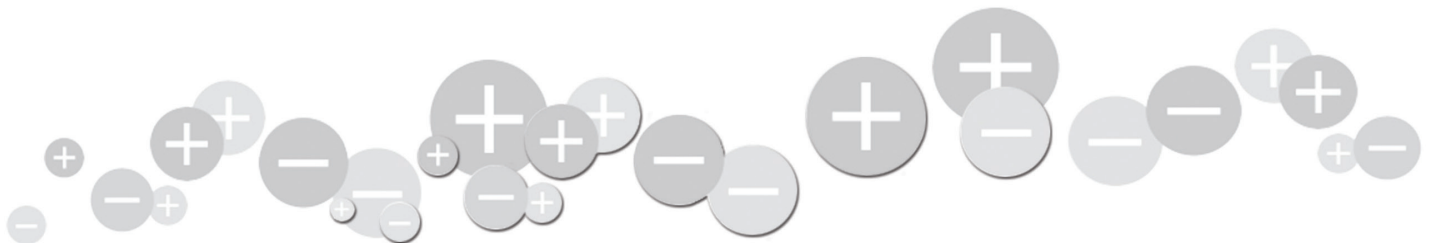
- Protects even the most sensitive electronic components
- Verifies that the unit is ionizing and balanced
- Helps maintain desired ionization performance level
- ISO 14644 Class 4 (Fed Std. 209E Class 10) cleanroom compatibility
- Provides fast, easy maintenance



Specifications	
Input Voltage	2-fan: 120 VAC, 50/60 Hz, 0.2A; 230 VAC, 50/60 Hz, 0.1A 3-fan: 120 VAC, 50/60 Hz, 0.5A; 230 VAC, 50/60 Hz, 0.25A
Balance	0 ±10V @ 18" (46 cm) from blower face
Discharge¹	3.0 sec @ 18" (46 cm) center blower position fan high (1000-100V)
Coverage	2-fan: 2' x 3' (61 x 91 cm) area; 3-fan: 2' x 4' (61 x 121 cm) area
Cleanroom Class	Meets ISO 14644 Class 4 (Fed std. 209E Class 10)
Emitters	Stainless Steel emitter points
Controls	3-position key switch OFF, ADJUSTABLE, HIGH; recessed fan speed control
Indicators	Ionization Status: green NORMAL, red MAINTENANCE LEDs
Air Volume	2-fan: 90 cfm fan low, 180 cfm high fan; 3-fan: 135 cfm fan low, 270 cfm high fan
Air Velocity	200 fpm (1.0 m/s) fan low; 400 fpm (2.0 m/s) fan high measured @ 18" (46 cm)
Audible Noise	48 dBA fan low; 58 dBA fan high measured @ 2' (61 cm)
Operating Env.	Temperature 32-122°F (0-50°C); humidity 30-70% RH, non-condensing
Ozone	0.02 ppm measured @ 18" (46 cm) above test plate
Power Outlets	Input IEC 320; output IEC 320, allows power connection (daisy-chain) of up to 10 units in series from one power source
Mounting	Adjustable brackets and S hooks provided
Enclosure	Aluminum with glossy white polyurethane finish
Dimensions	2-fan: 31.75"W x 4"H x 6.75"D (81 x 10 x 17 cm) 3-fan: 42.75"W x 4"H x 6.75"D (109 x 10 x 17 cm)
Weight	2-fan: 12 lb (5.5 kg); 3-fan: 15 lb (6.8 kg)
Warranty	Two year limited warranty
Certifications	 230V, 50 Hz  120V, 60 Hz 

1. Tested in accordance with ANSI/ESD STM3.1-2015.

Ordering Information

4008729	Guardian CR2000 2-fan, 120V, 60 Hz, UL, North America
4008730	Guardian CR2000 2-fan, 230V, 50 Hz, CE, Continental Europe
4008804	Guardian CR2000 2-fan, 230V, 50 Hz, CE, United Kingdom
4008630	Guardian CR2000 3-fan, 120V, 60 Hz, UL, North America
4008705	Guardian CR2000 3-fan, 230V, 50 Hz, CE, Continental Europe
4008805	Guardian CR2000 3-fan, 230V, 50 Hz, CE, United Kingdom
5050542	Overhead Blower Daisy-chain Kit, 10' power cord

Emitter Point Cleaner

The Guardian CR2000 features a built-in emitter point cleaner for each fan. Using the emitter point cleaner takes only seconds. Cleaning the emitter points prevents the build-up of airborne debris. This keeps your Guardian CR2000 working in top form for the life of the unit.

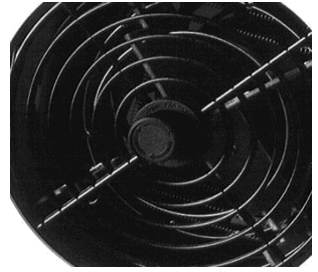

Application-specific Blower Lengths

The Guardian CR2000 Overhead Ionizing Blower comes in either 2-fan or 3-fan chassis lengths. Each length is designed for optimal coverage area and for variety of applications:

- A 2-fan overhead blower will provide coverage for 2-foot by 3-foot area
- A 3-fan overhead blower covers a 2-foot by 4-foot area

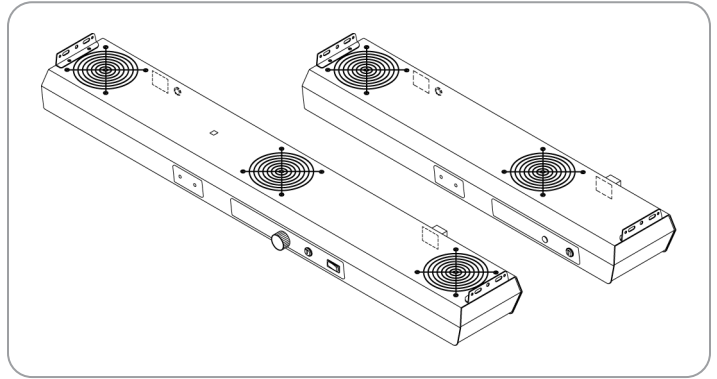

Discharge Time Performance

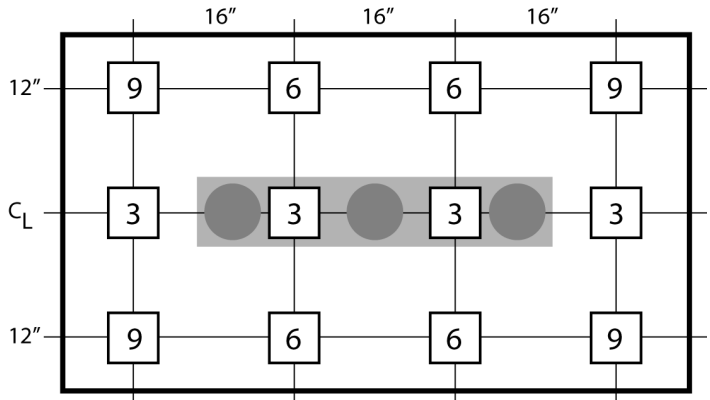

Discharge time in seconds (1000-100V), fan speed set to high; Guardian CR2000 blower 18" from CPM measuring plate; CPM test plate 6" from table; discharge times slightly longer for 230 VAC, 50 Hz unit.

SIMCO IONTM
An ITW Company

DS-Guardian CR2000_V5 - 6/21
© 2021 Simco-Ion
All rights reserved.

Simco-Ion, Technology Group

1141 Harbor Bay Parkway, Suite 201
Alameda, CA 94502

Tel: +1 (800) 367-2452 (in USA)
Tel: +1 (510) 217-0460

ioninfo@simco-ion.com
www.simco-ion.com