

Simpson[®]

**Model 501
Insulation Tester
INSTRUCTION MANUAL**



About this Manual

To the best of our knowledge and at the time written, the information contained in this document is technically correct and the procedures accurate and adequate to operate this Instrument in compliance with its original advertised specifications.

Notes and Safety Information

This Operator's Manual contains warning headings which alert the user to check for hazardous conditions. These appear throughout this manual where applicable and are defined below. To ensure the safety of operating performance of this Instrument, these instructions must be adhered to.



Warning: Refer to accompanying documents.



Caution: Risk of electric shock.

Technical Assistance

SIMPSON ELECTRIC COMPANY offers assistance Monday through Friday 8:00 am to 4:30 pm Central Time. To receive assistance contact Technical Support or Customer Service at (715) 588-3311.

Internet: <http://www.simpsonelectric.com>

Warranty and Returns

SIMPSON ELECTRIC COMPANY warrants each Instrument and other articles manufactured by it to be free from defects in material and workmanship under normal use and service, its obligation under this warranty being limited to making good at its factory or other article of equipment which shall within one (1) year after delivery of such Instrument or other article of equipment to the original purchaser be returned intact to it, or to one of its authorized service centers, with transportation charges prepaid, and which its examination shall disclose to its satisfaction to have been thus defective; this warranty being expressly in lieu of all other warranties expressed or implied and of all other obligations or liabilities on its part, and SIMPSON ELECTRIC COMPANY neither assumes nor authorizes any other persons to assume for it any other liability in connection with the sales of its products.

This warranty shall not apply to any Instrument or other article of equipment which shall have been repaired or altered outside the SIMPSON ELECTRIC COMPANY factory or authorized service centers, nor which has been subject to misuse, negligence or accident, incorrect wiring by others, or installation or use not in accord with instructions furnished by the manufacturer.

This manual represents your meter as manufactured at the time of publication. It assumes standard software. Special versions of software may be fitted, in which case you will be provided with additional details.

The apparatus has been designed and tested in accordance with EN 61010-1, "Safety Requirements for Electrical Equipment for Measurement, Control and Laboratory Use." This operating guide contains information and warnings that must be followed by the user to ensure safe operation and to maintain the apparatus in a safe condition.

SHOCK HAZARD: As defined in American National Standard, C39.5, *Safety Requirements for Electrical & Electronic Measuring & Controlling Instrumentation*, a shock hazard shall be considered to exist at any part involving a potential in excess of 30 volts RMS (sine wave) or 42.4 volts DC or peak and where a leakage current from that part to ground exceeds 0.5 milliamperes, when measured with an appropriate measuring Instrument defined in Section 11.6.1 of ANSI C39.5.

NOTE: The proper measuring Instrument for the measurement of leakage current consists essentially of a network of a 1500 ohm non-inductive resistor shunted by a 0.15 microfarad capacitor connected between the terminals of the measuring Instrument. The leakage current is that portion of the current that flows through the resistor. The Simpson Model 229-Series 2 AC Leakage Current Tester meets the ANSI C39.5 requirements for the measurement of AC leakage current and can be used for this purpose. To measure DC Leakage current, connect a 1500 ohm non-inductive resistor in series with a Simpson 0-500 DC microammeter and use this as the measuring Instrument.

Contents

1.	501 INSULATION TESTER	5
2.	SAFETY PRECAUTIONS	6
2.1	Repair and Replacement of Parts	6
3.	OPERATION	6
3.1	Inserting Batteries	6
3.2	Testing Batteries	6
3.3	Switching Instrument On and Off	7
3.4	Analog Display	7
3.5	Fuse	7
3.5.1	To Test the Fuse	7
3.5.2	To Replace the Fuse	7
4.	MEASURING	7
4.1	Measuring AC and DC Voltages	7
5.	MEASURING THE INSULATION RESISTANCE	8
5.1	How to Check and Adjust the Full-Scale Deflection	8
5.2	Assessing the Measured Values	9
5.3	Fast Control Of The Insulation Resistance	9
5.4	Controlling The Insulation Tester	9
6.	MEASURING LOW-VALUE (0..4V)	10
7.	TECHNICAL SPECIFICATIONS	11
7.1	Specifications	12
8.	Maintenance	13
8.1	Batteries	13
8.2	Fuse	13
8.3	Case	13
8.4	Factory Service	13
8.5.	Technical Assistance	14
9.	NIST CERTIFICATION	14

1. 501 INSULATION TESTER

The Model 501 tester complies to the regulation- IEC 1557-2/EN 61557-2, IEC 1557-4/EN 61557-4 - "Specifications for devices for testing the safety measures in electrical systems."

The 501 measures the insulation resistance of de-energized devices and systems with nominal voltages up to 1000V. The Instrument also tests the resistance of ground conductors, protective conductors and equipotential bonding conductors, including their connections.

The 501 is also equipped with a 1000V measuring range for AC and DC voltages, allowing devices to be tested for isolation from supply, and capacitive devices under test to be discharged.

The figure below represents the parts of the 501 Insulation Tester and its parts.

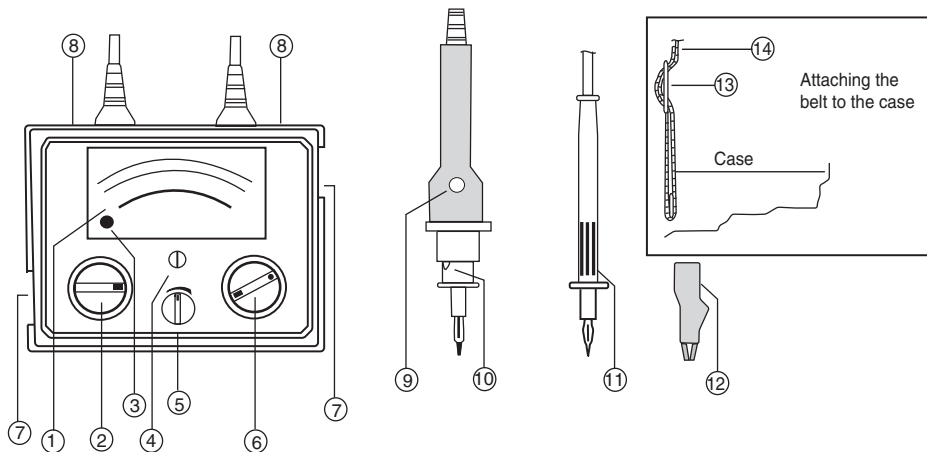

Figure 1-1

1. Analog display
2. Function switch selector
3. Control lamp for battery voltage
4. Adjusting screw for mechanical zero point adjustment
5. Rotary button for electrical zero point adjustment
6. Rotary switch for nominal voltage selection
7. Fixture for attaching the carrying belt
8. Sockets for control resistance
9. Test key
10. Test probe with lamp
11. Test probe
12. Alligator clip
13. Fastening
14. Carrying belt

2. SAFETY PRECAUTIONS

This insulation tester is constructed and tested in accordance with the following standards:

IEC 1010-1/EN 61010-1: IEC 1557-2/EN 61557-2: IEC 1557-4/EN 61557-4.

To ensure safe operation and to prevent damage to the Instrument, read and follow all instructions in this operating manual before using Instrument.

2.1 Repair and Replacement of Parts

When operating the tester, live parts may become exposed. Disconnect from all voltage sources before repairing or replacing parts. Only qualified personnel should replace or repair parts if Instrument must stay connected to voltage sources.

Faults and Unusual Stress

Operating the Instrument safely may be no longer possible if:

- a. Instrument is visibly damaged.
- b. Instrument no longer performs.
- c. Instrument is stored for long period under unfavorable conditions
- d. Instrument has endured heavy transport.



For safety reasons connected test leads are double-insulated. Each insulation has a different color making damage to the outer insulation noticeable before inner insulation is affected.

3. OPERATION

3.1 Inserting Batteries



Be sure that the function switch is in the “1000V” position before opening the battery compartment and that the Instrument is disconnected from all external current circuits.

1. Unscrew lid to the battery compartment.
2. Insert 6 standard 1.5 V batteries (D size) into the battery compartment matching symbols on batteries with the symbols on Instrument
3. Replace compartment lid and screws.

3.2 Testing Batteries

Pressing the test key automatically tests the batteries. The instantaneous load is taken into account by the selected position of the function switch and the nominal voltage. Signal light on the left of the scale shows battery condition as follows:

Green: Batteries are fully charged

Red: Batteries are too weak for the selected type of measurement

3.3 Switching Instrument On and Off

As long as the test key on the test probe is pressed the tester stays on. For transport and maintenance, switch the function switch to the 1000V position to prevent Instrument from being accidentally activated.

3.4 Analog Display

The measured values are clearly displayed on analog scales. Each position of the function switch is assigned its own scale. A signal light indicating the battery strength is positioned on the left side of the scale

3.5 Fuse

When measuring insulation or low-resistance, a common fuse protects the Instrument. If external voltage is accidentally applied to the resistance range, the fuse will blow. The voltage measurement is independent of the fuse state.

3.5.1 To Test the Fuse

- If fuse blows, The Ω and $M\Omega$ ranges will no longer function
- **Low-resistance measuring range:**
The pointer will remain at mechanical zero when pressing the measurement button.
- **Insulation resistance measuring range:**
When shorting the probes, the pointer will remain at mechanical zero when pressing the measurement button

3.5.2 To Replace the Fuse

Replace the fuse as follows:

1. Unscrew the case bottom
2. Unscrew the fuse holder cap
3. Change old fuse with new fuse and replace cap
4. Replace case bottom and screws

4. MEASURING

4.1 Measuring AC and DC Voltages

The 501 measures sinusoidal AC voltages and DC voltages and with frequencies between 40 and 200 Hz. Regardless of the polarity of the connectors, the 501's pointer deflection is always positive with DC measurements. The AC voltage is displayed as effective value.

1. Switch on the function switch to the "1000V" position.
 2. Check if the pointer points to the "0" marking of the V scale in the OFF position. If required, adjust it with the adjusting screw to the mechanical zero point.
 3. Scan the measuring point with the two test probes.
 4. Read the measured value on the V scale.
- The rotary switch is not important for the voltage measurement
 - The maximum overload capacity in the voltage measuring range is 1200V
 - The input resistance in the voltage measuring range is 0.9 $M\Omega$
 - A capacitively charged device under test is automatically discharged by Instrument. The voltage drop is visible on the display

5. MEASURING THE INSULATION RESISTANCE

1. Before measuring, check that the device under test is de-energized, see Section 4.
2. Switch the function switch to the R1 position (smallest resistance to be expected and useful for zero balancing).
3. Depending on the nominal voltage of the device under test, select the nominal voltage 50V, 100V, 250V, 500V or 1000V with the rotary switch.
4. Check the full-scale deflection $R1=0M\Omega$ by short circuiting the test probes and pressing the test key.
5. When in OFF position, the pointer must point to the full-scale deflection stated above. If necessary, use the rotary button that adjusts the electrical zero point to adjust the pointer.

NOTE: Under the following circumstances the full-scale deflection must be checked and adjusted if a measuring accuracy of 1.5% is to be reached:

- Each time a different nominal voltage is selected
- For resistance measurements of long duration

5.1 How to Check and Adjust the Full-Scale Deflection

1. Scan the measuring point with the two test probes.
2. Press the test key and read the measured value of the corresponding scale.
3. If the deflection is too small, use the function switch and switch to the next highest measuring range R2 or R3.
4. Multiply the displayed value with the conversion factor which can be read opposite to the selected nominal voltage.

Nominal Voltage:	50V	100V	250V	500V	1000V
Conversion Factor:	x0.1	x0.2	x0.5	x1	x2

Table 5-1



Do not touch the conducting ends of the test probes when Instrument is switched on.

When measuring a purely ohmic device under test, a current might flow through your body which, although not hazardous, will cause electric shock.

When measuring a capacitive device under test, e.g. a cable, the device can charge itself up to approx. 1200V, depending on the selected nominal voltage. Touching the device under test after measuring is highly dangerous! Therefore, for safety reasons, carry out a controlled discharge of the device under test with a voltmeter or do as described in Section 4.

5.2 Assessing the Measured Values

To ensure that the limit values of the insulation resistance stay within range, consider the measuring error of the insulation tester.

The following table shows the required minimum display values for insulation resistances which must be displayed considering the maximum operating error of the 501 (with nominal conditions of use). To ensure that the demanded limit values stay within range you may interpolate intermediate values (IEC - 1557 - 2/ EN - 61557 - 2).

The table applies for a nominal voltage of 500V. For other nominal voltages multiply the values in the table with a conversion factor.

Scale R1		Scale R2		Scale R3	
Limit Value MΩ	Display Value MΩ	Limit Value MΩ	Display Value MΩ	Limit Value MΩ	Display Value MΩ
0.1	0.13	0.2	0.25	2	2.5
0.2	0.25	0.3	0.38	3	3.8
0.3	0.38	0.4	0.5	4	5
		0.5	0.63	5	6.3
		1	1.25	10	12.5

Table 5-2

5.3 Fast Control Of The Insulation Resistance

The lamp in the test probe lights the measuring point and the fast good-bad assessment of the insulation resistance. As long as this lamp lights, the minimum values of the insulation resistance are kept. The signal lamp lights when the insulation resistance takes the following values:

Insulation Resistance	>0.1MΩ	>0.2MΩ	>0.5MΩ	>1MΩ	>2MΩ
Nominal Voltage	50V	100V	250V	500V	1000V

Table 5-3

5.4 Controlling The Insulation Tester

The sockets above the connectors of the test probes are internally connected with a test resistance. The sum of test resistance and line resistance of the two test leads, including the test probes, is 4 MΩ ± 5%. This value allows fast self-control.

1. Plug the test probes into the sockets
2. Switch the function switch to R1, R2 or R3 and switch the rotary switch to the desired nominal voltage.
3. Divide 4 MΩ by the factor belonging to the selected nominal voltage. The result is the display value to be expected.
4. Press the test key and check the result.

6. MEASURING LOW-VALUE (0...4Ω)

Switch the function switch in the “4Ω” position.

Be sure that the device under test is de-energized before you measure low resistance



Do not press test key if the test probes are used to scan a high-resistance device under test or if test probes are at no-load.

3. To check the full-scale deflection “0Ω”, short circuit the test probes and press the test key.
4. In the OFF position, the pointer must point to the “0” marking of the 4Ω scale. If required, adjust mechanical zero point.
5. Use the test probes to scan the two points between the low-value resistance to be measured.
6. Press the test key and read the measured value on the 4Ω scale.

NOTE: The resistance is measured with DC current. If a dependency of the measured value on the polarity of the measuring current can be expected (e.g. with a diode in the measuring circuit), exchange the test probes and repeat the measurement.

Resistances whose value change at the beginning of a measurement are, for example:

- Resistances with a high inductive part
- Resistances of Incandescent lamps, whose values change because of the heat caused by the measuring current
- Bad contact resistances at the points of contact

7. TECHNICAL SPECIFICATIONS









Test Function	Measuring Range	Intrinsic Error with Reference Conditions ¹⁾	Operating Error	Nominal Voltage U_N ⁴⁾	Frequency	No-Load Voltage U_o	Short Circuit Current I_k ²⁾	Internal Resistance R_i	Lamp in the test probe with resistance ³⁾	Overload	
										Value	Time
1000 V 	0...1000 V 	± 2.5%	± 10%	—	0 or 40...200Hz	—	—	900kΩ	—	1200 V 	Cont.
R1, R2, R3 $U_N=50V$	0...50kΩ	± 1.5%	± 25%	50V		60V		30kΩ	>100kΩ	1200 V 	Max. 10 s
	20kΩ...1MΩ							10kΩ			
	200kΩ...20MΩ							40kΩ			
R1, R2, R3, $U_N=100V$	0...100kΩ	± 1.5%	± 25%	100V		120V		60kΩ	>200kΩ	1200 V 	Max. 10 s
	40kΩ...2MΩ							20kΩ			
	400kΩ...40MΩ							80kΩ			
R1, R2, R3, $U_N=250V$	0...250kΩ	± 1.5%	± 25%	250V		300V	<12mA	150kΩ	>500kΩ	1200 V 	Max. 10 s
	100kΩ...5MΩ							50kΩ			
	1MΩ...100MΩ							200kΩ			
R1, R2, R3, $U_N=500V$	0...500kΩ	± 1.5%	± 25%	500V		600V		300kΩ	>1MΩ	1200 V 	Max. 10 s
	200kΩ...10MΩ							100kΩ			
	2MΩ...200MΩ							400kΩ			
R1, R2, R3, $U_N=1000V$	0...1MΩ	± 1.5%	± 25%	1000V		1200V		600kΩ	>2MΩ	1200 V 	Max. 10 s
	400kΩ...20MΩ							200kΩ			
	4MΩ...400MΩ							800kΩ			
4Ω	0...4Ω	± 1.5%	± 10%	—		9V	>200mA	—	—	0.315A	Cont.

Table 7-1

1 Referred to the scale length

2 With the electrical zero point adjusted correctly

3 Switching accuracy

4 Normal current $I_N \approx 1 \text{ mA}$

7.1 Specifications

Reference Conditions

Position of use:	Horizontal
Temperature:	73°F (23°C) ± 4°F (2°C)
Relative humidity:	45 ... 55%
Frequency of the measured quantity:	45 ... 65Hz
Waveform of the measured quantity:	Sinusoidal
Deviation between effective and rectified value:	<0.5%
Battery voltage:	9 V ± 0.5 V

Nominal Conditions of Use

Temperature:	0 ... 40 °C
Position of use:	Horizontal or vertical
Battery voltage:	7 ... 10 V

Power Supply

Batteries:	six 1.5 V ("D" size)
------------	----------------------

Battery Service Life

Number of possible measurements with one battery set "D" size (lamp 4 in the test probe switched off): at least 3000 measurements of the insulation resistance of 1 MΩ.

(Nominal Voltage = 1000 V, measuring for 5s, switching off for 25s and so on).

Electrical Safety

Protection class:	II
Nominal voltage:	1000V
Test voltage:	5.55 kV~
Overvoltage category:	II
Degree of pollution:	2

Mechanical Configuration

Degree of protection:	Case: IP 52, test probe: IP 30
Dimensions:	W 6.5" (165mm) x H 4.92" (125mm) X D 4.33" (110mm)
Weight:	3.5 lbs. with batteries

Switch-on characteristics when measuring the insulation resistance

An electrical voltage limitation has the effect that when switching on, the voltage at the device under test does not exceed the nominal voltage considerably. See the following characteristics:

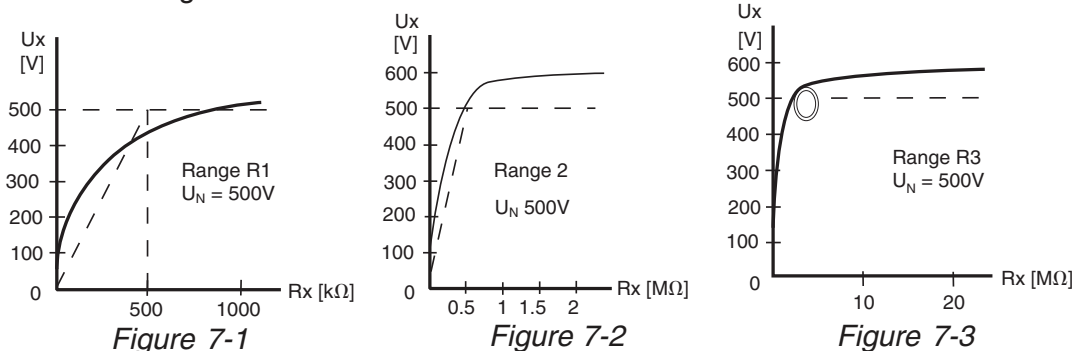

8. Maintenance



Before replacing batteries or fuses, completely disconnect the tester from all external current circuits.

For transport and maintenance we recommend to switch the function switch in the 1000 V position to avoid accidental switching on of the tester.

8.1 Batteries

Check batteries periodically. A decomposing battery will leak if left in battery compartment. In case of leaking batteries, completely remove the battery electrolyte and insert new batteries.

If, during the battery test as described in Paragraph 3.2, the red lamp in the left part of the scale lights, the batteries must also be replaced.

The replacement of batteries must be carried out as described in Section 3.1. Always replace the complete battery set!

8.2 Fuse

The fuse will blow if the maximum voltage is exceeded while connecting the tester to a measuring circuit.

A replacement fuse can be found in the battery compartment.

Only use the specified original fuses of type FF 0.315 A/1000 V !



Do not bridge or repair fuses! Using fuses with other nominal current, other switching capacity or other tripping characteristics may damage the tester

Replace the fuse as described in 3.5.2

8.3 Case

Use a moist cloth for cleaning. Do not use detergents and scouring agents.

8.4 Factory Service

Special training and facilities are required for servicing or repairing the Model 501 Insulation Tester. If tester is not functioning properly, call Simpson Customer service at (847) 697-2260.

8.5. Technical Assistance

Simpson Electric Company offers assistance Monday thru Friday 7:30 a.m. - 5:00 p.m. Central Time. Contact Technical Support or Customer Service at (847) 697-2260.

9. NIST CERTIFICATION

Simpson Electric Company Standards Lab has the technical expertise and proper facility to handle National Institute of Standards and Technology (NIST) certification. Simpson's Quality Assurance Calibration System satisfies the requirements of MIL-I-45208A, MIL-I-45662A and ANSI/NCSS Z540-1-1994. For a nominal charge you can certify that your Instrument has been calibrated under controlled environmental conditions to the manufacturer's specifications. Just call a Simpson Customer Service Representative at (847) 697-2260.

NOTES:

SIMPSON ELECTRIC COMPANY 520 Simpson Avenue
Lac du Flambeau, WI 54538-0099 (715) 588-3311 FAX (715) 588-3326
Printed in U.S.A. Part No. 06-116817 Edition 3, 06/07
Visit us on the web at: www.simpsonelectric.com