

FiberXpert

OTDR 5000



USER MANUAL



SOFTING IT NETWORKS GMBH
FIBERXPRT OTDR 5000

Handheld OTDR designed for the construction, turn-up and maintenance of fiber networks
User Manual



NOTICE: Every effort was made to ensure that the information in this document was accurate at the time of printing. However, information is subject to change without notice, and Softing IT Networks GmbH reserves the right to provide an addendum to this document with information not available at the time that this document was created.

COPYRIGHT: © Copyright 2017 Softing IT Networks GmbH. All rights reserved. Softing IT Networks GmbH, and its logo are trademarks. All other trademarks and registered trademarks are the property of their respective owners. No part of this guide may be reproduced or transmitted electronically or otherwise without written permission of the publisher.

TRADEMARKS: Softing IT Networks GmbH and FiberXpert OTDR 5000 (applied for trademarking) are trademarks or registered trademarks of Softing IT Networks GmbH.

Microsoft, Windows, Windows CE, Windows NT, and Microsoft Internet Explorer are either trademarks or registered trademarks of Microsoft Corporation in the United States and/or other countries.

Specifications, terms, and conditions are subject to change without notice. All trademarks and registered trademarks are the property of their respective companies.

Softing IT Networks GmbH has established processes in compliance with the Waste Electrical and Electronic Equipment (WEEE) Directive, 2002/96/EC.

**WEEE DIRECTIVE
COMPLIANCE:**

This product should not be disposed of as unsorted municipal waste and should be collected separately and disposed of according to your national regulations. In the European Union, all equipment purchased from Softing IT Networks GmbH after 2005-08-13 can be returned for disposal at the end of its useful life. Softing IT Networks GmbH will ensure that all waste equipment returned is reused, recycled, or disposed of in an environmentally friendly manner, and in compliance with all applicable national and international waste legislation.

It is the responsibility of the equipment owner to return the equipment to Softing IT Networks GmbH for appropriate disposal. If the equipment was imported by a reseller whose name or logo is marked on the equipment, then the owner should return the equipment directly to the reseller.

Instructions for returning waste equipment to Softing IT Networks GmbH can be found in the Environmental section of Softing IT Networks GmbH's web site at <http://itnetworks.softing.com>

TABLE OF CONTENTS

ABOUT THIS GUIDE	13
Purpose and scope	14
Assumptions	14
Technical assistance	14
Conventions	15
CHAPTER 1 FiberXpert OTDR 5000 Overview	16
Unpacking the instrument	16
About the FiberXpert OTDR	17
Main features	17
Hard keys and Indicators	19
Front panel hard keys	19
Front panel indicators	20
Power Supply	20
CHAPTER 2 Safety information	21
Battery and AC/DC safety	22
Precautions relating to optical connections	22
Laser Safety instructions	23
Laser classes	23
Warning labels for the laser	23
CHAPTER 3 Starting up	24
Setting the adaptable plug to the mains adapter	24
Connecting the mains adapter	24
First use of the battery	25
Charging the battery	25
Battery charging time	25
Battery charge level display	25
Switching the FiberXpert OTDR 5000 on and off	26
Switching on the FiberXpert OTDR	26



	Switching off the FiberXpert OTDR	27
	Resetting the FiberXpert OTDR	27
	First start: configuring your regional settings	27
CHAPTER 4	Configuring the FiberXpert OTDR 5000	29
	Displaying the System Settings	29
	Defining screen parameters of the FiberXpert OTDR 5000	30
	Backlight	30
	Contrast	30
	Screen Saver	31
	Defining the Audio parameters	31
	Defining the Automatic shutdown	32
CHAPTER 5	Principle of Measurement	33
	Principle of reflectometry measurements	33
	Information yielded by the measurement	33
	Validity of Measurement ITU-Reflectance	34
	Principle of optical power and attenuation measurements	34
	Power measurements	35
	Attenuation measurements (optical link loss)	35
CHAPTER 6	Starting up	37
	Connecting fiber optic cable	37
	Inspecting and cleaning connector end faces.	37
	Optical connector types.	37
	Optical connectors and interchangeable adapters	38
	Adapter types	39
	Switching adapter type	39
	Cleaning universal connectors	40
CHAPTER 7	Activating OTDR function	41
	Principle of the OTDR Expert	41
	Selecting OTDR Expert	41

CHAPTER 8	Configuring the test in Expert OTDR	42
	Configuring the Acquisition parameters	42
	Parameters LOaser	42
	Launch cable parameters	43
	Configuring the Alarms parameters	44
	Configuring the Analysis parameters	45
	Parameters	45
	Measurement	46
	Configuring the Link parameters	49
	Configuring the file storage parameters	51
	Configuration in Test Auto mode	52
	Saving OTDR configuration in a file	53
	Loading an existing OTDR configuration	54
CHAPTER 9	Launching a reflectometry test and displaying results	56
	Performing OTDR acquisitions	56
	Traffic detection	56
	Performing acquisition with Expert OTDR	56
	Performing an acquisition from Results page	58
	Multi-wavelength acquisition	59
	Actions on trace during acquisition	60
	Results display	62
	Common functions	62
	Results table	63
	Cursors	65
	Zoom function	67
	Shift function	68
	Summary	68
	Display of traces in overlay	69
	Traces display in double acquisition mode	70
	Advanced functions in Expert OTDR mode	70
	Automatic measurement and detection	70



Addition of events	71
Manual measurements	72
Measurements of slope	72
Measurement of ORL	73
Measurement of Reflectance	74
Splice measurements	75
Memorization of the position of events	76
Overlay trace function	76
Overlaying several traces stored in memory	77
Display of traces in overlay	77
Adding traces in overlay	77
Swapping overlay traces	77
Removing a trace	78
Quitting the overlay menu	78
Reference Trace function	78
Use of the reference trace function in the Result page	78
Using the reference trace function in the explorer	79
Saving the trace(s) and generating a report	80
Saving results and creating a report from results page	80
Opening a report	81
SmartLinkMapper (SLM) option	82
CHAPTER 10 Power meter and Source options of the OTDR Modules	85
Connection to the power meter	85
Configuring the Power meter	85
Configuring the measurement parameters of the power meter	86
Configuring the alarm parameters	86
Configuring the Measurement parameters	86
Configuring the Link parameters	87
Configuring the File parameters	91
Activating the Source function	92
Result page	92
Result page of the Power meter	92
Table of results	93

Commands of the power meter parameters	93
Result page of the Source	93
Performing the power level measurement	94
Performing the insertion loss measurement	94
Setting the zero value of the power meter	94
Carrying out the reference	95
Carrying out the side by side reference	95
Carrying out the reference in loopback mode	95
Measurements on the fiber under test	95
Storing and reloading results	96
File Setup	96
Storing results.	96
Loading results.	96

CHAPTER 11 Scope	97
Scope feature	97
Overview	97
Installation of tips	98
Configuring the Softing IT Networks GmbH Scope	98
Scope connection	98
Configuring the Scope	98
Test	99
File	99
Fiber	99
Link Description	100
Adding a new profile	100
About page	100
Starting up with the scope	101
Freeze mode	101
High Mag. / Low Mag	101
Camera mode	101
Test of the connector and fiber end-face	102
Overlay	103
Mosaic Mode	103



	Loading a picture	104
	File menu	105
	Saving the test result in a jpg file	105
CHAPTER 12	Transferring the FiberXpert OTDR 5000 Interface	106
	Establishing connection	106
	Connecting the FiberXpert OTDR 5000 and the PC	106
	Configuring the FiberXpert OTDR 5000	107
	Virtual control buttons bar	109
	Equivalence between the keyboard and	110
CHAPTER 13	Web browser	111
	Configuring the Web access	111
	Starting the web browser	111
	Opening an internet page	112
	Navigation into the Web Browser	112
	Creating bookmarks	113
	Opening a PDF document	113
	Leaving the web browser	114
CHAPTER 14	File management	115
	File Explorer Overview	115
	Directories and Files selections	115
	Directory selection	115
	Files selection	116
	Directories & Files editing functions	116
	Copy/Cut & Paste files/directories	116
	Renaming a directory / file	117
	Deleting a directory / file	117
	Working with directories and files in the explorer	117
	Creating a directory	117
	Opening files	118
	File Types	118

Sorting files	119
Transferring files between two Platforms	119
Establishing connection between two devices	119
Transferring files	120
Cancelling the connection	120
Transferring files to a PC with the USB cable	121
Establishing connection FiberXpert OTDR 5000 <-> PC	121
Transferring files onto the PC	122
Cancelling the connection	123
Transferring files to/from a PC with a FTP server	123
Direct connection	123
Connection via a local network	124
Accessing the internal memory	125
Creating a screenshot	126
Configuring the parameters of screenshots	126
Taking a screenshot	126
Name of the screenshots files	126
Creating a report	127
Configuring the report	127
Creating the report	128
Name of the report	128
Merging pdf or txt files	129
Storage media	130
Storage media built into the FiberXpert OTDR 5000	130
External USB storage media	130
USB memory stick connection	130
USB memory stick disconnection	130
Cloud Storage	131
Principle and prerequisites of the Cloud Storage	131
Configuring and connecting to Cloud Storage	131
Transferring files using Cloud Storage	133
Abbreviations for storage media	133
CHAPTER 15 Technical specifications	134
OTDR modules for FiberXpert OTDR 5000	134



Characteristics of reflectometry measurements	134
Manual Measurement	134
Typical specifications	135
Ranges	136
Class of the lasers of the OTDR modules	136
OTDR modules measurement	136
Technical specifications of the Power meter function on module	136
Technical specifications of the Source function on module	137
Display specifications	138
Screen	138
Memory	138
Input/Output	138
Power supply	138
Battery	138
Mains adapters	139
Dimensions – Weight	139
Environment	139
Temperature	139
Humidity	139
EMI/ESD	139
Drop test	139
Shocks	139
Bumps	140
Vibration	140
Flammability	140
CHAPTER 16 Maintenance and Troubleshooting	141
Maintenance procedure	141
Cleaning	141
Cleaning plates and housings	141
Cleaning the screen	141
Cleaning the optical cable connector	141
Cleaning the optical connections	142
Accessing the unit information	142
General page	142

Software options page	142
Services Data page	143
Accessing unit documentation	143
Installing a new version of the software	144
Downloading from Internet	144
Installation from a USB memory stick	145
Launching the upgrade	146
Checking new upgrade on Softing IT Networks GmbH Server	146
Upgrading from the boot	146
Install Option	147
Enter Manually the Licence	147
Import the license from the USB memory stick	148
Locking the FiberXpert OTDR 5000	149
Returning an instrument	150
Guarantee conditions	150
Recycling Information	150
Troubleshooting	151
Interpreting alarms	151
Formatting the USB memory stick onto the	151
Erase disk	152
Touchscreen calibration	152
Changing the battery	153
General information on warranty	154
Hardware Warranty	154
Warranty disclaimer	154



ABOUT THIS GUIDE

The FiberXpert OTDR 5000 of Softing IT Networks GmbH provides a handheld OTDR for the construction, turn-up and maintenance of fiber networks.

The topics discussed in this chapter are as follows:

- “Purpose and scope”
- “Assumptions”
- “Technical assistance”
- “Conventions”

PURPOSE AND SCOPE

The purpose of this guide is to help you successfully use the FiberXpert OTDR 5000 features and capabilities. This guide includes task-based instructions that describe how to install, configure, use, and troubleshoot the FiberXpert OTDR 5000.

Additionally, this guide provides a complete description of Softing IT Networks GmbH's warranty, services, and repair information, including terms and conditions of the licensing agreement.

ASSUMPTIONS

This guide is intended for novice, intermediate, and experienced users who want to use the FiberXpert OTDR 5000 effectively and efficiently. We are assuming that you have basic computer and mouse/track ball experience and are familiar with basic telecommunication concepts and terminology.

TECHNICAL ASSISTANCE

If you need assistance or have questions related to the use of this product, call or e-mail Softing IT Networks GmbH's Technical Assistance Center for customer support.

Region	Phone Number	
Europe, Africa, and Mid-East	+49 (89) 891360 60 (Europe)	support.itnetworks@softing.com
	+33 01 45 17 28 05	info.france@softing.com
	Softing SARL	itnetworks.softing.com
Asia / Pacific	+65 6569 6019 (Singapore)	

DURING OFF-HOURS, YOU CAN REQUEST ASSISTANCE BY DOING ONE OF THE FOLLOWING:

- leave a voice mail message at the Technical Assistance number in your region
- e-mail Technical Assistance Center, support.itnetworks@softing.com
- submit your question using our online Technical Assistance Request form at <http://itnetworks.softing.com>



CONVENTIONS

This guide uses naming conventions and symbols, as described in the following tables.

Table 2 Typographical conventions

Description	Example
User interface actions appear in this typeface. On the Status bar, click Start.	On the Status bar, click Start.
Buttons or switches that you press on a unit appear in this TYPEFACE.	Press the ON switch.
Code and output messages appear in this typeface.	All results okay
Text you must type exactly as shown appears in this type- face.	Type: a:\set.exe in the dia- log box
Variables appear in this type- face.	Type the new hostname
Book references appear in this typeface.	Refer to Newton’s Telecom Dictionary
A vertical bar means “or”: only one option can appear in a single command.	platform [a b e]
Square brackets [] indicate an optional argument.	login [platform name]
Slanted brackets < > group required arguments.	<password>

Table 3 Keyboard and menu conventions

Description	Example
A plus sign + indicates simultaneous keystrokes.	Press Ctrl+s
A comma indicates consecutive key strokes.	Press Alt+f,s
A slanted bracket indicates choosing a submenu from menu.	On the menu bar, click Start > Program Files.

Table 4 Symbol conventions





	This symbol represents a general hazard.
	This symbol represents a risk of electrical shock.
	NOTE This symbol represents a Note indicating related information or tip.
	This symbol, located on the equipment or its packaging indicates that the equipment must not be disposed of in a land- fill site or as municipal waste, and should be disposed of according to your national regulations.

Table 4 Symbol conventions



WARNING

Indicates a potentially hazardous situation which, if not avoided, could result in death or serious injury.



CAUTION

Indicates a potentially hazardous situation which, if not avoided, may result in minor or moderate injury.

1-FIBERXPRT OTDR 5000 OVERVIEW

This chapter provides a general description of the FiberXpert OTDR 5000. Topics discussed in this chapter include the following:

- “Unpacking the instrument”
- “About the FiberXpert OTDR 5000”
- “Main features”
- “Hard keys and Indicators”
- “Power Supply”

Unpacking the instrument

1 Remove the FiberXpert OTDR 5000 and its accessories from the packing case.

2 Check that the module and accessories ordered are all there.

If any part is missing or damaged please contact your local Softing IT Networks GmbH agent. The FiberXpert OTDR 5000 is delivered as standard with:

Table 4 Symbol conventions

A Getting Started Manual

A Li-Polymer battery, set into the equipment and which must be charged before use

A mains adapter used for mains operation of the instrument and battery charging

5 country adaptable plugs (Europe / UK / US / Australia / Japan) A hands-free soft case for the FiberXpert OTDR 5000

A USB cable, to connect the FiberXpert OTDR 5000 to PC

A shoulder strap



About the FiberXpert OTDR 5000

The architecture of the FiberXpert OTDR 5000 is made of one Platform, to which a module is added to perform tests on fiber networks.

The module is fitted to the FiberXpert OTDR 5000

The FiberXpert OTDR 5000 employs multi-tasking for the simultaneous performance of several operations:

- acquisitions
- modifications of parameters
- trace analysis
- report management

It also allows to use simultaneously several functions:

- Power Meter
- Scope
- OTDR measurements

Main features

The FiberXpert OTDR 5000 is equipped with the following elements:

- A 5 inch TFT color touchscreen, high visibility
- RJ45 plug for Ethernet interface
- Two USB 2.0 host connectors for Microscope, USB memory stick, mouse, keyboard...
- One mini USB 2.0 device connector to connect the FiberXpert OTDR 5000 to a PC
- An audio jack to connect a headset
- A connection socket for the mains adapter providing the 12 V power supply and used to charge the battery.
- LED indicators for Charge, On status and Test
- A Li-Polymer battery

With the FiberXpert OTDR 5000, the user can:

- Open/transfer files to a PC via a USB memory stick, USB cable
- Generate pdf reports
- Open all user documentations on the FiberXpert OTDR 5000
- Update the FiberXpert OTDR 5000 firmware
- Remote the screen of the FiberXpert OTDR 5000 onto a PC and issue commands from the keyboard of the PC

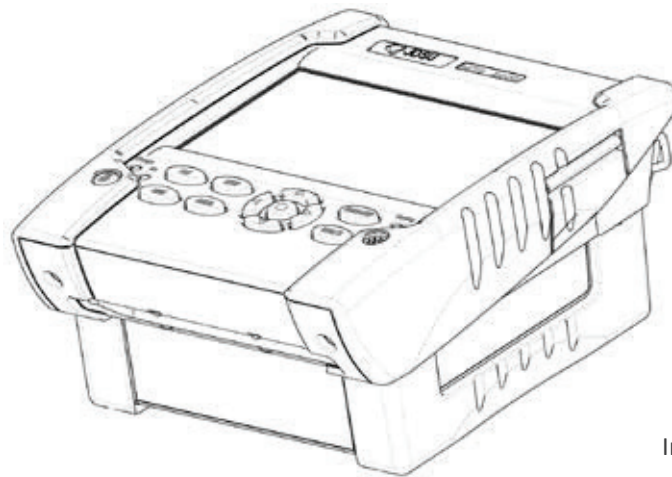

Indicators

Soft keys perform the function on the display above each button.

Fig. 1 FiberXpert OTDR 5000 with module

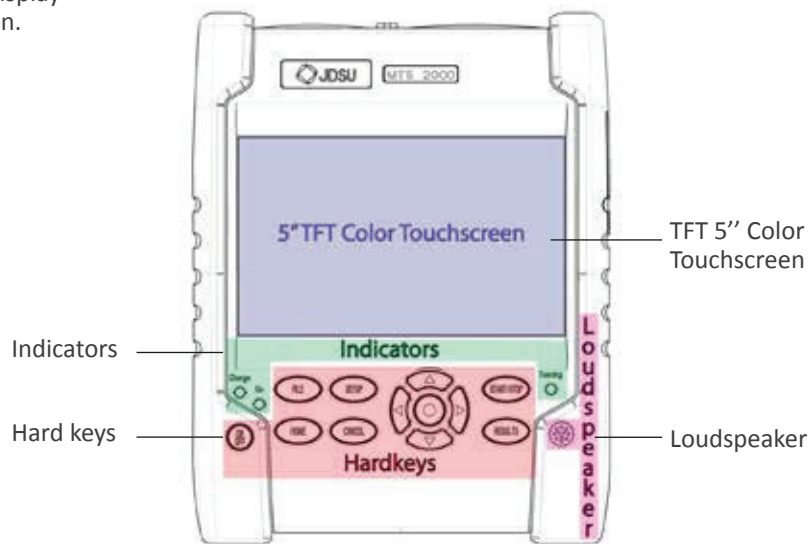

Fig. 2 FiberXpert OTDR 5000: Front view

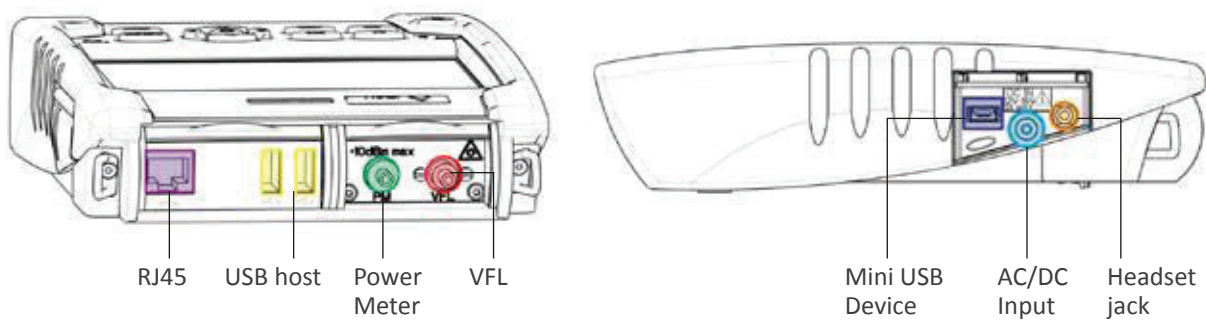

Fig. 3 FiberXpert OTDR 5000: Connectors View



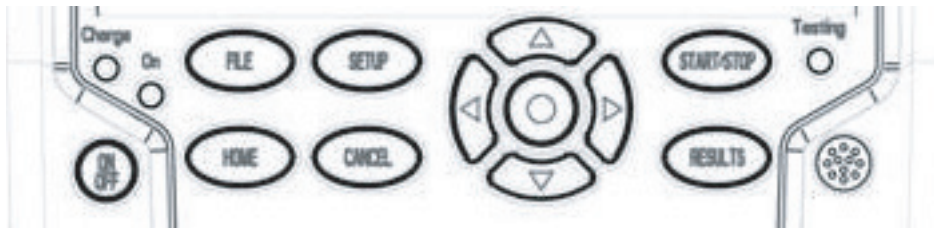









Fig. 4 Hard keys and Indicators

HARD KEYS AND INDICATORS

Front panel hard keys

Table 2 Hard keys description

HARD KEY FUNCTION

	Main on/off switch
	This button calls up the file explorer. It allows to: <ul style="list-style-type: none"> – choose the storage medium: internal memory, USB memory key. – manage files; with facilities for classifying them in directories and sub-directories.
	Gives access to: <ul style="list-style-type: none"> – selection of the different measurement or functions – the settings of the instrument – the help page
	This button calls up the measurement configuration menu. This menu depends on the function in use.
	This button allows to deselect a function or escape a menu
	Starts and stops the measurement.
	This button calls up the results page (with OTDR module: reflectometry trace and table of results).
	The direction keys have two principal functions: <ul style="list-style-type: none"> – on the Results page, they are used to move the cursors or modify the zoom factor. – on the set-up pages, they are used to scroll through the menus, the central button serving to select or confirm the parameter chosen.

Front panel indicators

The FiberXpert OTDR 5000 is equipped with three indicators, lit into a different color according to the status of the unit

Table 3 Indicators Status

On indicator



Blinking green

The instrument, though connected to an external power source, is switched off.



Solid green

The instrument is operating, either by battery or on an external power supply.

Charge indicator



Solid green

The instrument is connected to an external power source and the battery is fully charged.



Solid red

The instrument is connected to an external power source, and the battery is on charge.

Testing indicator



Solid red

At least one function is in measurement phase (for example, the laser emission pilot for an OTDR measurement)

Power Supply

The FiberXpert OTDR 5000 may operate with

- the Li-Polymer battery, already set into the equipment on delivery.
- an AC adapter/charger, via a power cable on which has been set the correct country ad

Power supply plug

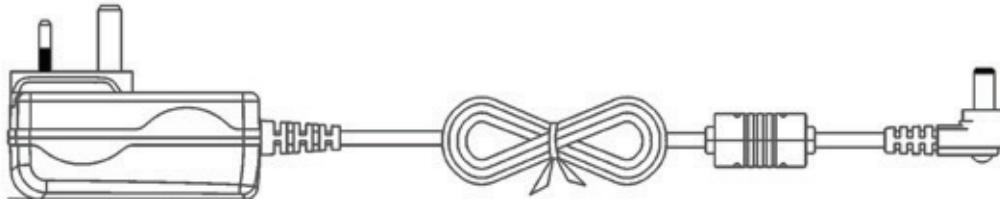

Interchangeable plugs



UK adaptable
plug
(installed by
default)



EUROPE
adaptable
plug



US
adaptable
plug



JAPAN
adaptable plug



AUSTRALIA
adaptable plug

2-SAFETY INFORMATION

This chapter gives the main information on the safety conditions when using the FiberXpert OTDR 5000:

- “Battery and AC/DC safety information”
- “Precautions relating to optical connections”
- “Laser Safety instructions”

Battery and AC/DC safety information

– The Li-Polymer battery is designed for maximum safety. In particular, each cell is provided with a safety valve to prevent excessive internal pressure in the event of overcharging or exposure to very high temperatures.

– Battery supplied by Softing IT Networks GmbH incorporate protection means. Do not use any mains adaptor or battery other than those supplied with the instrument, or supplied by Softing IT Networks GmbH as an option for this instrument.

If another adapter or battery is used, it may damage the FiberXpert OTDR 5000 itself.

Using the FiberXpert OTDR 5000 with a battery other than the one supplied by the manufacturer of the FiberXpert OTDR 5000 may entail risks of fire or explosion.

The battery may explode, leak or catch fire:

- if it is exposed to high temperature or fire
 - if it is opened or dismantled.
-

Other basic safety precautions are as follows:

– Do not use AC/Adapter/Charger outdoors or in wet or damp locations

– Connect the AC/Adapter/Charger to the correct mains voltage, as indicated on the ratings label.

– Do not allow anything to rest on the power cord, and do not locate the product where people can walk on the power cord.

– Avoid using this product during an electrical storm. There may be a remote risk of electric shock from lightning.

– Do not use this product in the vicinity of a gas leak or in any explosive environment.

– Do not attempt to service this product yourself, as opening or removing covers may expose you to dangerous, high voltage points and other hazards. Contact qualified service personnel for all service.

Precautions relating to optical connections

– The normal operating life of an optical connector is usually of the order of a few hundred manipulations. It is then advisable to manipulate the optical connections of the Platform as rarely as possible.

– The proper operation of the instrument and its accuracy of measurement are dependent on the cleanliness of the environment and the optical connectors as well as the care taken in its manipulation.

– The optical connectors must therefore be clean and dust-free. If the optical connection is not being used, protect the connections of FiberXpert OTDR 5000 using the protective caps.

Laser Safety instructions

The provisions contained in two standards define the safety procedures to be observed both by users and by manufacturers when utilizing laser products:

– EN 60825-1: 2001 - Safety of laser products – Part 1: Classification of products, requirements and user guidelines.

– FDA 21 CFR § 1040.10 - Performance standards for light-emitting products - Laser products.

Due to the range of possible wavelengths, power values and injection characteristics of a laser beam, the risks inherent in its usage vary. The laser classes form groups representing different safety thresholds.

Laser classes

Standards EN 60825-1, Edition 1.2, 2001-08 and FDA21CFR§1040.10:

– VFL option: Class 2.

Warning labels for the laser classes

Due to the reduced dimensions of the optical modules, it is not possible to attach the required warning labels to them. In line with the provisions of Article 5.1 of the EN 60825-1 standard, the laser class identification labels are shown below:

– EN 60825-1: 2001 - Safety of laser products – Part 1: Classification of products, requirements and user guidelines.

– FDA 21 CFR § 1040.10 - Performance standards for light-emitting products - Laser products.

Reference standard	EN 60825-1, Edition 1.2, 2001- 08	FDA21CFR§1040.10
Class 1	CLASS 1 LASER PRODUCT	
Class 2	LASER RADIATION DO NOT STARE INTO BEAM CLASS 2 LASER PRODUCT	CAUTION LASER RADIATION - DO NOT STARE INTO BEAM CLASS II LASER PRODUCT

The user must take the necessary precautions concerning the optical output of the instrument and follow the manufacturer's instructions.



Measurements on optical fibers are difficult to execute and the precision of the results obtained depends largely on the precautions taken by the user.

3-STARTING UP

Setting the adaptable plug to the mains adapter

The FiberXpert OTDR 5000 is supplied as standard with a mains adapter and 5 country adaptable plugs (Europe / UK / US / Australia/Japan).

To set the correct plug to the mains adapter:

- 1 Make flush the connector onto the mains adapter with the adaptable plug slots.
- 2 Push the adaptable plug until it stops.

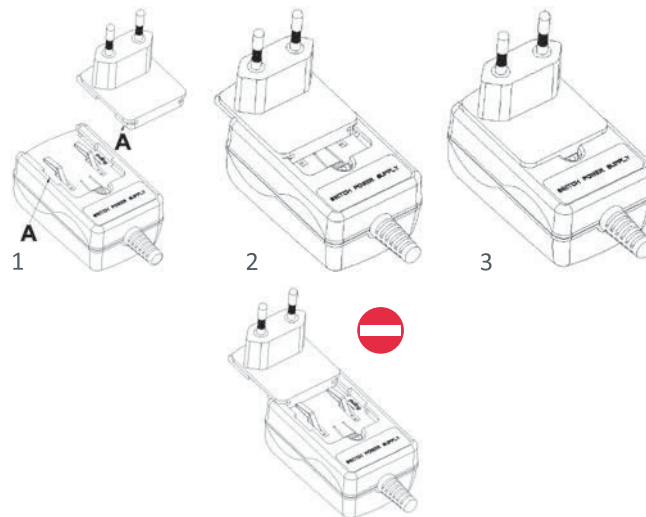

Fig. 6 Setting the adaptable plug onto the mains adapter

If the adapter plug is not correctly set onto the mains adapter,  the connector may be damaged.

Connecting the mains adapter

- 1 Set the appropriate adaptable plug to the power supply cable, according to your country.
- 2 At the right side of the FiberXpert OTDR 5000, lift up the power supply socket protector and plug in the mains adapter.
- 3 Connect the adapter to the mains.

The On indicator lamp starts to blink in green.

Use only the mains adapter supplied with the FiberXpert OTDR 5000. The adapter for some other electronic device may appear to be identical, but entails a risk of damage to the FiberXpert OTDR 5000.



First use

At the delivery, the battery is already set into the Unit, but its charge level is not «recognized» by the equipment.

The icon  is displayed on the upper banner of the screen.

To get a valid indication of the battery, and be able to use correctly the Platform:

- 1 Charge fully the battery
- 2 Once fully charged, discharge the battery by keeping the Unit switched on, but not plugged to mains.
- 3 The battery can then be charged, and the Unit used simultaneously.

Charging the battery

On connection to the mains:

– if the user does not press ON, the battery will start the charge. In this case, the Charge indicator will be lit in red.

– when the user presses the ON key, the instrument starts up and the battery will charge during use (Charge indicator in solid red).

Once the battery is fully charged, the Charge indicator is lit in solid green.

When the Charge indicator is blinking red, this mean the power supply is not compatible with the battery used. Charge is disabled.

It is essential to wait until charging is complete to ensure maximum independent operating time, which may otherwise be considerably reduced.

Battery charging time

If the battery is completely discharged, the time taken to recharge is:

– approximately 3.5 hours, if the apparatus is not in use (Charge indicator solid red)

– about 9.5 hours if the instrument is used during charging (On indicator lit in fix green, Charge indicator lit in solid red).

Battery charge level display

When the battery is installed in the instrument, a battery icon is displayed in the top righthand corner of the screen. Example: 

– if the user does not press ON, the battery will start the charge. In this case, the Charge indicator will be lit in red.

– when the user presses the ON key, the instrument starts up and the battery will charge during use (Charge indicator in solid red).

Once the battery is fully charged, the Charge indicator is lit in solid green.

When the Charge indicator is blinking red, this mean the power supply is not compatible with the battery used. Charge is disabled.

Charging the battery



The battery capacity is superior to 75%



The battery capacity is set between 50% and 75%



The battery capacity is set between 25% and 50%



The battery capacity is inferior to 25%



The battery capacity is unknown. Perform a full charge/ discharge of the battery to get back to a valid indication. This icon may appear if battery is changed or if the battery auto discharges at a very low level (example: if a Unit switches off as battery is empty, and the charge is not done during several months (= auto discharge)).

– When the level becomes too low, the instrument emits a beep ton inform the user until it switches off automatically after saving the current configuration and measurement.

Table 4 Battery icons

SWITCHING THE FIBERXPRT OTDR 5000 ON AND OFF

Switching on

Press the ON/OFF key.

If the Unit is powered to mains, the battery will charge. The On indicator pass from blinking to solid green.

The startup logo appears on the screen briefly, then an auto test is carried out.

The equipment is ready to be used once all the applications are installed.

NOTE

It is possible to switch over from battery to mains operation, or vice versa, without loss of data.

The module cannot be swapped when the unit is ON or AC powered

In the event of an unexpected mains power cut, if there is no battery, the current results and configuration will not be saved. Next time the instrument is switched on, it will return to its initial configuration.



Switching off

While the FiberXpert OTDR 5000 is operating, press the ON/OFF button to switch it off.

NOTE

When the instrument is switched off using the ON/OFF button, current results and configuration are saved. Next time the ON/OFF key is pressed, they are recalled.

Resetting the FiberXpert OTDR 5000

If the FiberXpert OTDR 5000 freezes, prolonged pressure (about 4 s.) on the ON/ OFF key will reset the instrument.

Setting the adaptable plug to the mains adapter

The FiberXpert OTDR 5000 is supplied as standard with a mains adapter and 5 country adaptable plugs (Europe / UK / US / Australia/Japan).

To set the correct plug to the mains adapter:

- 1 Make flush the connector onto the mains adapter with the adaptable plug slots.
- 2 Push the adaptable plug until it stops.

First start: configuring your regional settings

Once the FiberXpert OTDR 5000 is switched on, the first screen displayed allows to configure the regional settings.

Those settings will be kept in memory and automatically applied on the instrument each time it is restarted.



Fig. 7 Regional Settings

1 Click on Language and select the language to be used for the equipment.

2 Click on Date and enter the current date, using the numeric keypad displayed using the menu key Edit Number.

3 Click on Time and enter the current time, using the numeric keypad displayed using the menu key Edit Number.

The date and time are displayed on the upper right side of the screen.

4 Click on Date Time Format and configure the following parameters:

– Date format: select one of the option dd/mm/yy or mm/dd/yy.

– Time format: select one of the option 24 hour clock or 12 hour clock.

5 Click on Net Time parameter to configure the date and time according to a network.

Dynamic Mode: the time is synchronized according to the local network.

The two lines Server Name are displayed but cannot be modified.

Static Mode: in this case, the time is synchronized to the network server which is defined in the two following parameters.

On the parameter Address Type, select if the address of the server which will be used for synchronization is entered via its IP Address or via the Server Name..

If IP Address is selected, enter one or two server addresses in the following parameters. During synchronization, the first address will always be used, but if a fail occurs, the second one will be used.

If Server Name is selected, enter the name of the server, and if necessary a name for second server. During synchronization, the first server name will always be used, but if a fail occurs, the second one will be used.

During synchronization the icon displays on the upper banner between the date and time.

6 Once all parameters have been defined, press Exit menu key to return to System Settings page.



4-CONFIGURING THE FIBERXPRT OTDR 5000

This chapter describes the operations for configuring the instrument. The topics discussed in this chapter are as follows:

- “Displaying the System Settings screen”
- “Defining the screen parameters of the FiberXpert OTDR 5000”
- “Defining the Audio parameters of the FiberXpert OTDR 5000”
- “Defining the Automatic shutdown of the FiberXpert OTDR 5000”

Displaying the System Settings screen

To display the System Settings screen, you must:

- 1 Press the HOME hard key to reach the Home page.

Fig. 8 Home page

- 2 Activate the Settings icon  to open the System Settings screen.

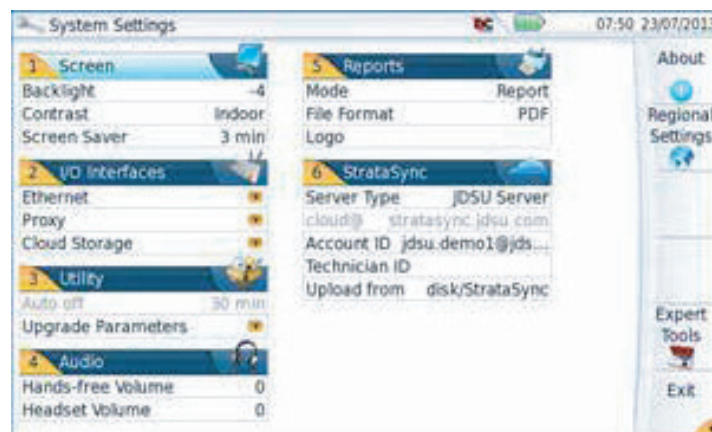
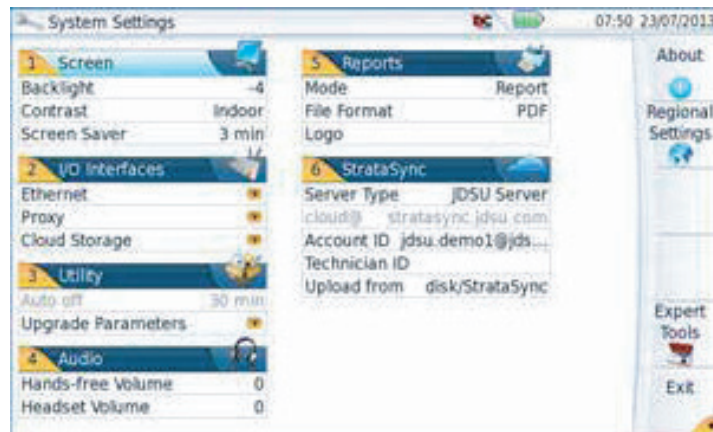

Fig. 9 System Settings page



NOTE

If you are in the Regional Settings page, and you press Exit, then the System Settings page automatically displays.

Defining the screen parameters of the FiberXpert OTDR 5000

In the System Settings page, the following parameters can be defined:

Backlight

1 Click on Backlight

2 Define the backlight level of the screen, using the left and right direction keys, or clicking on Edit Number softkey and using the keypad displayed.

– Min backlight level: -5

– Max backlight level: +5

If the FiberXpert OTDR 5000 is operating on battery, it is advisable to choose a minimum lighting level, acceptable for the user, to keep endurance as long as possible

Contrast

1 Click on Contrast

2 Select the type of environment into which the instrument is used:

– Indoor: to be selected when the instrument is used inside

– Outdoor: to be selected in order to optimize the readability of the screen for an outside use.

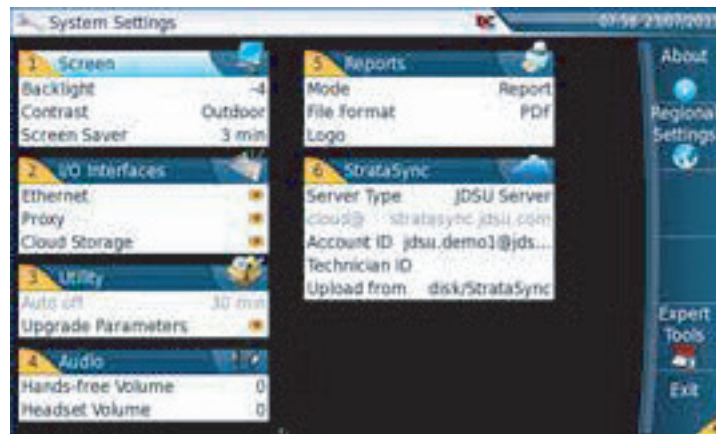

Fig. 10 Example of outdoor contrast

Screen Saver

Click on Screen Save if you wish to activate a screen saver to the equipment, to extend the life of the battery, in case the FiberXpert OTDR 5000 is not used for some time.

Instead of the normal screen, a small animated picture of the Unit is displayed on the blackened screen.

To configure the screen saver:



1 Click on Delay and select the time of inactivity before the screen saver starts: 60s, 3 min, 5 min.

The parameter No deactivates the screen saver function.

Defining the Audio parameters of the FiberXpert OTDR 5000

In the Audio box of the System Settings screen, you can configure the audio parameters according to whether you are using a headset with the Unit.

1 Adjust the volume on the line Hands-free Volume using the left and right direction keys, or the Numeric keypad (displayed with the softkey Edit Number)

- Min volume for Hands-free function: 0
- Max volume for Hands-free function: 100

2 If a headset is used, adjust the volume on the line Headset Volume, using the left and right direction keys, or the Numeric keypad (displayed with the softkey Edit Number):

- Min volume for Headset function: 0
- Max volume for Headset function: 100

Defining the Automatic shutdown of the FiberXpert OTDR 5000

The automatic shutdown function switches off the FiberXpert OTDR 5000 automatically if no operation has been performed and no key actuated for a period selected from this menu. Work in progress is automatically saved.



The function for automatically switching off the FiberXpert OTDR 5000 is available only on battery operation, to save the battery

- 1 In the Utility box, click on Auto off parameter.
 - 2 Choose a time after which the FiberXpert OTDR 5000 will be switched off automatically, if no action has been done for that period: 5, 10 or 30 minutes.
-

Select No if the FiberXpert OTDR 5000 must not be switched off, even if there is inactivity on the equipment.



5-PRINCIPLE OF MEASUREMENT

This chapter gives the principles of the measurements made by the optical modules.

The topics discussed in this chapter are as follows:

- “Principle of reflectometry measurements”
- “Principle of optical power and attenuation measurements”

Principle of reflectometry measurements

Optical time domain reflectometry consists in injecting a light pulse into one end of the optical fiber to be analyzed and observing, at the same end, the optical intensity passing through the fiber in the opposite direction to the propagation of the pulse.

The signal detected is exponentially diminishing in form, typical of the phenomenon of backscattering, with superimposed peaks due to reflections from the ends of the fiber or other variations in the refractive index.

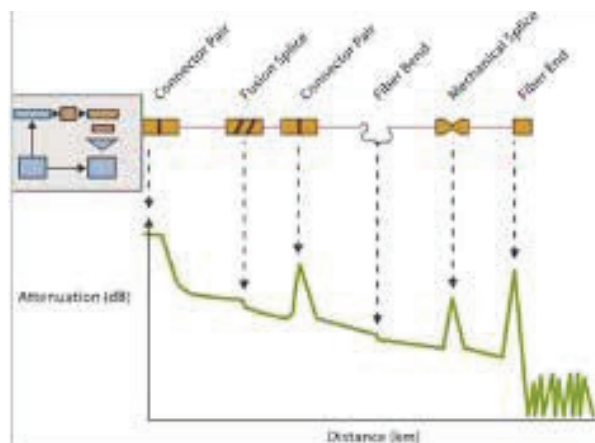

Fig. 11 Trace showing typical backscattering

Information yielded by the measurement

From a backscatter trace it is possible, in particular, to determine the position of a section of fiber within a link. The measurement result must reveal:

- the attenuation
- the location of faults, by their distance from a point of origin,
- attenuation with respect to distance (dB/km)
- the reflectance of a reflective event or a link.



To locate faults, a reflectometer measures only time. Consequently, group velocity must be introduced in order to determine the distance of the location. This is done by introducing the refractive index of the fiber into the instrument

Validity of Measurement ITU-T

ITU-T in recommendations G.650, G.651 and G.652, give backscatter measurement as an alternative method for measuring attenuation, the method of reference being the cut fiber.

The field of application of backscatter is not limited, but the conditions for application of this method are nevertheless stipulated:

- injection conditions: Fresnel reflections must be limited at fiber input.
- a high-power source (laser) should be used.
- receiver bandwidth should be chosen to achieve a compromise between pulse rise time and noise level.
- backscatter power should be represented on a logarithmic scale.

Reflectance

Reflectance is a value with which the coefficient of reflection of a reflecting optical element can be quantified. It is defined as the ratio of the power reflected by the element over the incident power.

These reflections are due to variations in refractive index all along the optical link in certain telecommunications applications. If they are not controlled, they may degrade the performance of the system by perturbing the operation of the emitting laser (especially DFB lasers) or may generate interference noise in the receiver by multiple reflections.

The reflectometer is particularly well suited to the measurement of discrete reflectances on an optical fiber link. To calculate the coefficient of reflection, it is necessary to measure the total amplitude of the Fresnel reflection generated and then to apply a conversion formula to obtain the reflectance value.

This formula takes into account:

- the total amplitude of the reflection measured by the reflectometer.
- the pulse width used to measure the amplitude of the reflection (in nanoseconds)
- the backscatter coefficient of the fiber used:
 - typical values of the backscatter coefficient for a pulse of 1 ns and
 - for a single-mode fiber: -79 dB at 1310 nm -81 dB at 1550 nm and 1625 nm
 - for a multi-mode fiber: -70 dB at 850 nm -75 dB at 1300 nm

NOTE

To measure the widest range of reflection coefficient, it is necessary to insert a variable optical attenuator between the reflectometer and the link to be tested. This attenuator enables the level of the trace to be adjusted so as to avoid saturation of the reflectometer by the reflection to be evaluated.

PRINCIPLE OF OPTICAL POWER AND ATTENUATION MEASUREMENTS

Power measurements

A power meter, is all that is needed to measure emitted or received power:

- to measure emitted power, connect the power meter directly to the output of the optical emitter;
- to measure the power at the input of an optical receiver, the power meter is connected to the end of the fiber, at the point where the optical receiver would be connected.

If the Unit is powered to mains, the battery will charge. The On indicator pass from blinking to solid green.

Attenuation measurements (optical link loss)

For measurement of the attenuation of power in a complete link or in elements such as sections of fiber, connections or optical components, a light source and a power meter are required.

This attenuation is usually deduced from the measurement of optical power at two = points:

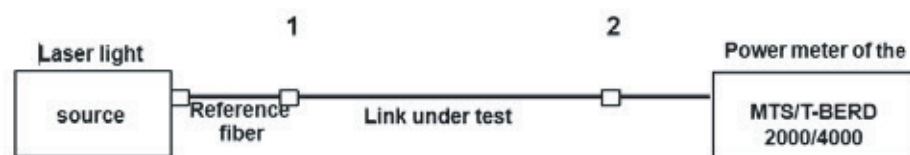

$$\text{Attenuation } A(\text{dB}) = P1 (\text{dBm}) - P2 (\text{dBm})$$

To perform accurate measurements, the following conditions are necessary

- Use a light source which is stable both in time and as a function of temperature.
- Make sure that all connections and fibers and the receiving cell are perfectly clean.
- Use a reference link between the laser source and the test subject.

If several measurements are to be made under identical light injection conditions, this reference fiber must not be disconnected during the period while measurements are taking place.

Insertion loss method

1 The power meter is first connected to the laser source via the reference fiber: P1 is measured.

2 Then the fiber to be tested is inserted between the reference fiber and the power meter: P2 is measured.

The difference between P2 and P1 gives the attenuation of the fiber under test.

It is preferable to use the same type of connector at both ends of the fiber being tested, to ensure the same connection conditions for measuring P1 and P2.

Accuracy of measurements

– A high degree of accuracy is often required. It is then necessary to perform a preliminary calibration without the fiber under test to eliminate the losses due to connections as far as this is possible. To do this, use the «Reference Value» function.



6-STARTING UP

This chapter describes how to start using the FiberXpert OTDR 5000. The topics discussed in this chapter are as follows:

- “Connecting fiber optic cable”
- “Optical connectors and interchangeable adapters”

CONNECTING FIBER OPTIC CABLE

Inspecting and cleaning connector end faces

Always inspect and clean the connector end face of the optical fiber cable and the test port before mating both together.

Softing IT Networks GmbH is not responsible for damage and reduced performance caused by bad fiber handling and cleaning.

– Optical connector contamination is the #1 source of performance degradation and test equipment repair

– A single particle mated into the core of a fiber can cause significant back reflection, insertion loss and equipment damage. Visual inspection is the only way to determine if the fiber connectors are truly clean before mating them.

Follow this simple “INSPECT BEFORE YOU CONNECT” process to ensure fiber end faces are clean prior to mating connectors

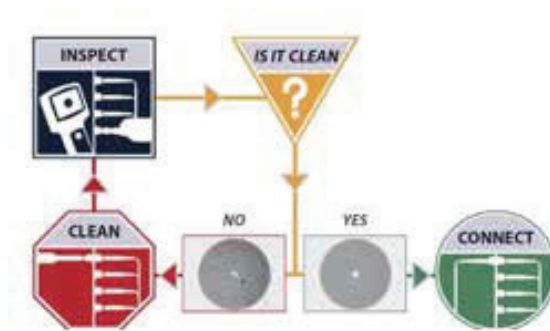

Fig. 12 “Inspect Before You Connect” process

Optical connector types

There are many optical connectors in the market place. Always ensure to use a high quality connector that meets the international standards.

Two main types of connectors are deployed in the telecommunication industry:

- 1 Straight polished connectors, so called PC or UPC
 - 2 Angled polished connectors, so called APC
-

Caution

Never connect a PC connector into an APC test port or vice versa. This will result in damaging the connector end faces

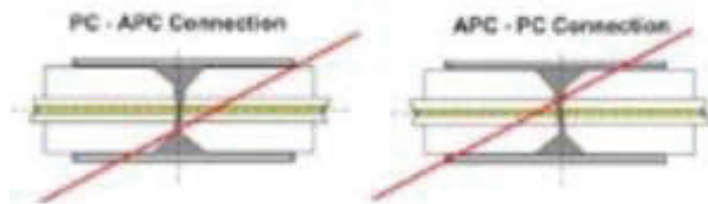

Fig. 13 PC/APC bad connection

Warning

Softing IT Networks GmbH declines responsibilities of connector damages if a poor quality connector is used or APC to PC connections made. Test port connector repair will be charged

Warning

All the universal connectors are available on the OTDR Modules, except on the LA Module

Optical connectors and interchangeable adapters

Connecting Fiber optic cable to test port

After ensuring proper cleaning of both end connectors, follow the below steps in order to correctly and safely connect the optical fiber into the test port:

1 Carefully align the connector and test port to prevent the fiber end from touching the outside of the port and scratching the end face.

NOTE

If your connector features a keying mechanism, ensure that it is correctly fitted into the test port's insert.

2 Push the connector to firmly place it inside ensuring physical end face contact

NOTE

If your connector features a screw-on sleeve, tighten the connector to firmly maintain the fiber in place. Do not over tighten as this will damage the fiber and the test port

WARNING

Never force the connector ferrule or insert it with an angle into the test port adapter. Mechanical stress may permanently damage the ceramic sleeve of the adapter or the end face of the connector. A new adapter purchase only will get the unit back to operation

Optical connectors and interchangeable adapters

Fiber Optic modules may come equipped with a universal connector and adapter selected at time of order.

Adapter types

Softing IT Networks GmbH offers 4 different adapters, all compatible with this connector, allowing the user to switch from one adapter to another according to which fiber type he intends to work with.

Adapter types supplied are: FC, SC, DIN, ST and LC.

DIN Adapter (EUDINAD)

ST Adapter (EUSTAD)

FC Adapter (EUFCAD)

LC Adapter (EULCAD)

SC Adapter (EUSCAD)



Fig. 14 5 different types of adapters may be mounted on the universal connector

Switching adapter types

In order to switch from an adapter to another, proceed as shown.

Pull out in the direction of the arrow in order to release the adapter from the lug holes

To place an adapter, position the handle as shown in order to engage with the the lugs, push hard and pull the handle down

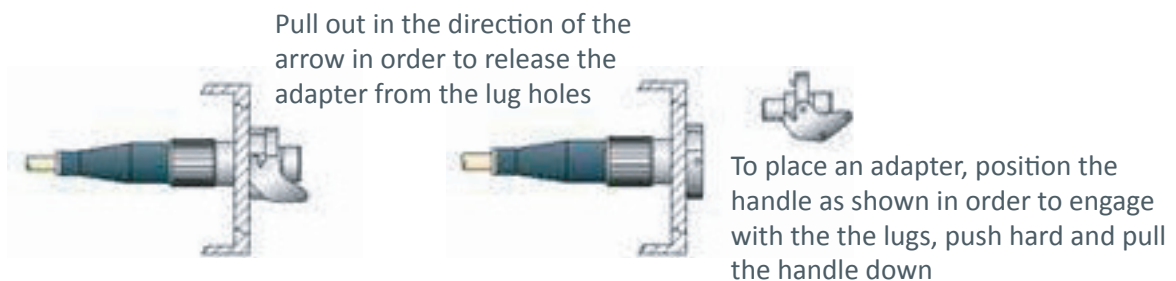

Fig. 15 Removing and refitting an adapter

Changing the adapter on a LA OTDR Module

The LA modules are equipped with specific connector and adapters:

- 1 Unscrew the two screws of the adapter currently mounted onto the connector.
 - 2 Remove the adapter
 - 3 Set the new adapter vertically on the optical connector, making flush the «mark» on the adapter with the mark on the connector.
-



Fig. 16 Position of the adapter onto the connector

-
- 4 Fix the adapter with the two screws.



Fig. 17 Fixing the adapter

NOTE

When changing the optical connector, take caution not to scratch the connector mating surfaces. Carefully align the removable piece and the baseplate ferrule when inserting the adapter part.

7-ACTIVATING OTDR FUNCTION

Once the OTDR module is correctly set onto the equipment and FiberXpert OTDR 5000 is switched on, the desired OTDR function must be selected before any OTDR configuration, or measurement.

The topics discussed in this chapter are as follows:

SELECTING THE OTDR EXPERT FUNCTION

Principle of the OTDR Expert

The OTDR Expert is used to

- perform OTDR acquisitions with full OTDR setup capabilities, and advanced analysis features.
- create configuration files that can be loaded by Smart Test users.

Selecting OTDR Expert

To select this function, after the equipment start:

- 1 Press the HOME button
- 2 Select the OTDR Expert icon 

The icon turns yellow. 

After a few seconds, the Results page displays.

NOTE

In the case a Singlemode/Multimode module, one line contains the Multimode icons and a second one the Singlemode icons. To distinguish both modes, multimode icons contain the MM mark.

8-CONFIGURING THE TEST IN EXPERT OTDR

Once the Expert OTDR icon is selected, the Results page automatically displays.

In Expert OTDR, the parameters for acquisition and for file storage can be configured.

1 To call up the test configuration window, press the SETUP button. Dialog boxes and menu keys on the same screen enable selection of

- Acquisition parameters
- Alarms parameters
- Analysis parameters

Used for the OTDR acquisition

- Link parameters
- File parameters

Used for OTDR result saving

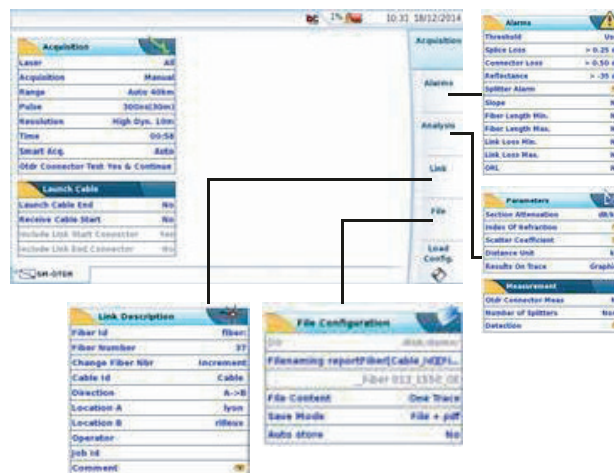

Fig. 18 OTDR setup in Expert OTDR mode In these windows, the parameter selected is in video inverse

Configuring the Acquisition parameters

You can choose the OTDR acquisition parameters.

1 Once the Setup page is displayed, press Acquisition menu key to configure the Acquisition parameters.

The Acquisition Setup page is divided into two parts: the Acquisition box and the Launch cable box.

Parameters Laser

The acquisition will be carried out on the wavelength(s) selected (for multiple wavelength modules). In case of a multi-wavelength module, select All to perform a measurement for all the wavelengths available (this parameter visible exclusively on modules with one single OTDR port). The possible values depend on the module used.



Acquisition

	Select the kind of acquisition to be performed:
Manual	The acquisition parameters Pulse / Range / Resolu- tion can be set by user.
Auto	Auto The acquisition parameters Pulse / Range / Resolu- tion are defined automatically and cannot be modi- fied The Measurement time will be set to Auto, but can be modified (see “Time” page 24).

Range

	The possible range depends on the pulse length selected. This range is given for each pulse length in the paragraph. This parameter is exclusively configurable if Acquisition parameter is set to Manual. It depends on the module used.
Auto	allows to detect automatically the range. The range is selected as a function of the end of the fiber.

Pulse

	From 3ns to 20 μ s according to module used. Parameter selectable only if Acquisition parameter is set to Manual.
	NOTE According to the value selected for Pulse parameter, the Range parameter can be automatically modified, and vice-versa.

Resolution

	This parameter is exclusively configurable if Acquisition parameter is set to Manual.
Auto	resolution is selected automatically according to the last two parameters above.
High Resolution	the highest resolution is applied
High Dynamic	the highest dynamic is applied

Time

Real time	the equipment performs up to ten acquisitions per second. NOTE Whatever is the acquisition mode selected, an acquisition in real time mode can be launched aintaining the START/STOP button pushed for about 2 seconds. NOTE If the Acquisition parameter is defined to Auto, then the Time parameter is defined to Auto, but can be modified.
Manual	Enter the acquisition time desired (from 5 s. to 5 minutes max).

Predefined Select one of the acquisition times predefined: 10 seconds / 20 seconds / 30 seconds / 1minute / 2 minutes / 3 minutes.

Configuring the Alarms parameters

In the Setup page, press Alarms softkey (if one parameter is selected in the current screen, press Top Menu soft key to display the right menu keys and click on Alarms).

Once the Alarms page is displayed, configure the parameters for applying thresholds to results displayed.

Threshold

None The alarm function is not active

User Thresholds can be defined for: Splice Loss / Connector Loss / Reflectance / Splitter Alarm / Slope / Fiber Length Min and Max / Link Loss Min and Max / ORL

TIA-568 C / ISO/IEC 11801 / Default / G.697/G.98x PON / G.697/ IEEE PON
Select one of this parameter to configure the alarm thresholds with predefined values:

Table 1 Singlemode Modules

SOFTING IT NETWORKS

G.697/G.98x PON G.697/IEEE PON

Default

TIA-568C ISO/IEC 11801

Splice Loss	> 0.20 dB	> 0.30 dB	> 0.30 dB
Connector Loss	> 0.50 dB	> 0.50 dB	> 0.75 dB
Slopea	> 1.00 dB/km	-	>1.00 dB/km
Reflectance	> 35 dB		>35 dB
ORL		< 27 dB	
Splitter Alarm	1 X 2	> 5.0 dB	> 4.2 dB
	1 X 4	> 8.0 dB	> 7.8 dB
	1 X 8	> 11.0 dB	> 11.4 dB
	1 X 16	> 14.0 dB	> 15.0 dB
	1 X 32	> 17.0 dB	> 18.6 dB
	1 X 64	> 21.0 dB	> 22.0 dB
Link Loss Max	Select: No/ Manual or:		
	– for G.697/G.98x PON: 20 dB (A) / 25 dB (B) / 30 dB (C) – for G.697/IEEE PON: 30 dB (C) / 23 dB (PX-10) / 26 dB (PX-20)		

a. This parameter is not available in OEO-OTDR configuration



Table 2 Multimode Modules

Default	TIA-568C ISO/IEC 11801	
Splice Loss	> 0.20 dB	> 0.30 dB
Connector Loss	> 0.50 dB	> 0.75 dB
Slope 850 nm	> 3.50 dB/km	> 3.50 dB/km
Slope 1300 nm	> 1.50 dB/km	> 1.50 dB/km
Reflectance -	> - 35 dB	-
ORL	< 27 dB	-

If results are above those thresholds, they are highlighted in red in the table of results, and the  icon appears at the top right of the screen

If all the results lie within the thresholds (no result is in red or yellow), they are displayed in green in the table and the icon  is displayed at the right top of the trace.

Configuring the Analysis parameters

In the Setup page, press Analysis softkey (if one parameter is selected in the current screen, press Top Menu soft key to display the right menu keys and click on Analysis).

The Analysis Setup page is divided into two parts: the Parameters box and the Measurement box.

Parameters	Parameters Section Attenuation
dB/km	Displays the section slope in the table of results. When the fiber is too short to measure the slope accurately, no value is displayed (empty field).
dB	Displays the section Loss in the table of results. With short fiber where the slope cannot be measured with a good accuracy, the loss in dB is approximate and displayed.
None	The section attenuation and Loss values are not displayed in the table of results.

Index of refraction

Choice of group refraction index of the whole fiber.

User	Define for each wavelength (1310 SM, 1360-1510 SM, 1550 SM, 1625 SM) a refraction index of 1.30000 to 1.69999. The selection of an index alters the value of the section AB (actual distance between cursors A and B). or, If the actual distance between the cursors A and B is known, enter its value under Section AB to establish the index of the fiber. Selection of this distance causes the display of the indices. The extreme distance values are given by the index values (1.30000 à 1.70000).
------	--

Predefined

It is possible to choose one of the predefined values given for certain cables. The corresponding indices given in the table below are repeated on the screen.

Wavelength (nm)	1310 SM	1360 - 1510 SM	1550 SM	1625 - 1650 SM
Generic G652 G657	1.46750	1.46800	1.46800	1.46850
Generic G653 G655	1.46750	1.46800	1.46800	1.46850
ATT SM	1.46600	1.46700	1.46700	1.46700
Corning SMF-28	1.46750	1.46810	1.46810	1.46810
Corning SMF-DS	1.47180	1.47110	1.47110	1.47110
Corning SMF-LS	1.47100	1.47000	1.47000	1.47000
Corning-Leaf	1.46890	1.46840	1.46840	1.46900
Draka SMF	1.46750	1.46800	1.46800	1.46850
Draka Longline	1.46700	1.46700	1.46710	1.46750
Draka Teralight	1.46820	1.46820	1.46830	1.46850
Draka Benbright	1.46750	1.46750	1.46800	1.46850
Fitel Furukawa	1.47000	1.47000	1.47000	1.47000
OFS Lucent Allwave	1.46750	1.46750	1.46750	1.46850
Lucent Truewave	1.47100	1.47100	1.47000	1.47000
SpecTran SM	1.46750	1.46810	1.46810	1.46810
Sterlite	1.46700	1.46700	1.46750	1.46750
Sumitomo Litespec	1.46600	1.46600	1.46700	1.47000
Sumitomo Pure	1.46600	1.46600	1.46700	1.47000

Fig. 16 Predefined index values (Single Mode)

Wavelength (nm)	850 MM	1300 MM
Corning 62.5	1.50140	1.49660
Corning 50	1.48970	1.48560
SpecTran 62.5	1.49600	1.49100
Generic 50	1.49000	1.48600
Generic 62.5	1.49000	1.48700
Generic OM1-62/125	1.49600	1.49100
Generic OM2-3- 4 50/125	1.48200	1.47700



Fig. 17 Predefined index values (Multi Mode)



Scatter coefficient

User	Selects for each wavelength, the backscatter coefficient of -99 dB to -50 dB by increments of 0.1dB. Modification of the backscatter coefficient K changes the measurements of reflectance and ORL. Backscatter coefficients are selected automatically for each wavelength.
Auto	In Multimode, two predefined scatter coefficients are available:
Generic 50	850 MM -> -66.3 dB 1300 MM -> -73.7 dB
Generic 62.5	850 MM -> -66.1 dB 1300 MM -> -70.3 dB
	The default values are given in the paragraph

Distance Unit

	Define the unit of the distances displayed: km, kfeet, miles, meter, feet.
--	--

Results on trace

None	the trace alone
All	the trace with results and markers.
Graphics	the trace with markers only.
	If All or Graphics is selected, the reflectometry trace is displayed with a dotted vertical line set on the end of launch cable  (if the Launch Cable is defined in the SETUP menu) and a dotted vertical line on the end of fiber. 

Measurement Otdr Connector Measurement

	This parameter allows to choose if a measurement of the front connector must be performed when acquisition is launched
	Cable start
No	In the results table, the first line corresponds to the first event detected.
Yes	In the results, the first result corresponds to the front connector measurement, at 0 meter (estimated value).

Number of Splitters (not available in Multimode)

	Once parameter is selected, press Edit Number key to display the numeric keypad and select the wished value:
None	there is no splitter set onto the network.
Discover	Auto-detection and identification of PON splitter types.
1 to 3	If the number of splitters is known, select it from the list (from 1 splitter to 3 splitters).
	This selection opens a sub menu into which the splitters types must be defined for all splitters installed.

Splitters types

Splitter 1: define the splitter type among the list:

- 1x2 / 1x4 / 1x8 / 1x16 / 1x32 / 1x64
- 2x2 / 2x4 / 2x8 / 2x16 / 2x32 / 2x64

Splitter 2 and Splitter 3: define the splitter type among the list:

- 1x2 / 1x4 / 1x8 / 1x16 / 1x32 / 1x64

Detection

Splice

Select if a level of detection for splice must be defined.

Press Edit Number soft key and select a value:

- Enter a min level of detection, from 0.01 to 1.99 dB
- No: no splice detection
- Auto: to automatically detect splice

Reflectance

Select if level of detection for reflectance must be defined.

Press Edit Number soft key and select a value:

- Enter a min level of detection, from -98 to -11 dB
- None: no reflectance detection
- All: all reflectances are detected

Ghosts

Choice (Yes / No / No Analysis) of whether information relating to ghosts is to be displayed. If ghosts are displayed, the reflection icon in the table of results appears dotted and the reflection value is displayed in brackets on the trace, for example «(R:-50 dB)».

Fiber end

Once parameter is selected, press Edit Number key to display the numeric keypad and select the wished value:

- Auto (recommended): option in which the iberXpert OTDR 5000 automatically detects the end of a fiber.
- > 3 to > 20 dB(steps of 1 dB): threshold of detection of end of fiber.

Bend

(not available in Multimode) With any dual or triple-wavelength measurement module, the user will have access to the macro bend detection function in the test setup. Each event of the selected wavelengths will then be compared.

Once parameter is selected, press Edit Number key to display the numeric keypad and select the wished value:

- None: Bend will not be detected.
- Auto: Bend will be automatically detected.
- Define by user: Enter the bend value (in dB), with direction keys or numeric keypad.



Configuring the Link parameters

In the Setup page, press Link softkey (if one parameter is selected in the current screen, press Top Menu soft key to display the right menu keys and click on Link).

NOTE

The softkey Copy File/Link to all is displayed when one parameter is selected in the Link or File Setup page and when the Powermeter or Source function is active.

It allows to apply the Link and File configuration parameters of the current applications to all the other active Fiber Optic applications (powermeter, and source).

The information entered in the Link Description window concerns the editing and/or the modifications of the cable and fiber parameters. When a trace is recalled without recall of the configuration, the parameters of this trace will be present only in its signature.

Fiber ID

Select the parameter Fiber Id and enter a name for the fiber, using the edition keypad.

Fiber Number / Fiber Code

The parameter Fiber Number becomes Fiber Code if, in the Cable Structure window, the Cable Content parameter is defined on another parameter than Fiber (Ribbon/ Fiber, Tube/ Fiber or Tube/Ribbon/ Fiber).

The fiber code corresponds to the fiber number if, in the Cable Structure, the parameter Color coding is defined on No.

The fiber code corresponds to the fiber color if, in the Cable Structure, the parameter Color coding is defined on Yes.

1 Select the parameter Fiber Number/Fiber Code and modify the parameter using the left and right direction keys.

The fiber number can be automatically incremented/decremented at each new file save if it has been configured in the File Setup page

NOTE

The Fiber Code and the fiber number concatenated with Fiber Name are interdependent: they are incremented or decremented at the same time. However, the fiber number remains a number only, while the fiber code is alphanumerical. Whether it includes a color code or not it may be composed of one, two or three parts.

Fiber and cable parameters used in the example:

Fiber Name: 'Fiberx'
Cable Content: 'Tube/Fiber' Max Tube: 12
Max Fiber: 24
Coding used for the fiber and the tube: TIA

	Fiber N		Fiber N+1	
ColorCode	Yes	No	Yes	No
<Fiber Name>	Fiberx24	Fiberx24	Fiberx25	Fiberx25
<Fiber Code>	Bl/Aq-	1/24	Gold/Bl	2/1

Fig. 18 Example of incrementation of fiber code

Change Fiber Nbr

Increment	the fiber number is automatically incremented at each new file-save.
Decrement	the fiber number is automatically decremented at each new file-save
User defined	Use Edit Number softkey to enter the increment / decrement value for fiber number.
	NOTE to decrement the number, enter the sign «-» before the number. Example: -1. Min: -999 / Max: 999 / Auto: 0
No	the Fiber number must not automatically modified.

Cable Id

This parameter allows to enter an identification of the cable, using the Edition menu.

Direction

The direction shows if the acquisition has been made from the origin to the extremity (A->B) or from the extremity to the origin (B->A). Changing direction makes it possible, when different extremities are handled, to see the parameters of the fiber for the other extremity.

Location A

The name of the Location A of the link may be entered here.

Location B

The name of the Location B of the link may be entered here.

Operator

Use the arrow to enter the name of the operator carrying out the measurement.

Job Id

Use the arrow to enter a description of the measurement to be performed.



Comment

In contrast to the other data in this menu, the comment is specific to a fiber. This line is thus used to enter a new comment and not to display it. The comment appears at the top of the screen, with the other parameters of the fiber. This comment will remain available for the next acquisition, unless it is deleted. It is also saved when a trace is saved with a comment.

Configuring the file storage parameters

The File storage parameters must be also configured, in order to define how the results traces will be saved onto the FiberXpert OTDR 5000.

In the Setup page, press File softkey (if one parameter is selected in the current screen, press Top Menu soft key to display the right menu keys and click on File).

NOTE

The softkey Copy File/Link to All is displayed when one parameter is selected in the Link or File Setup page and when the Powermeter or Source function is active. It allows to apply the Link and File configuration parameters of the current applications to all the other active Fiber Optic applications (powermeter, and source).

Dir

This parameter cannot be configured, and display the directory selected by default intowhich the file(s) will be saved (the last directory selected).

To modify the directory, go to the Explorer page and select another directory.

This parameter allows to enter an identification of the cable, using the Edition menu.

Filenaming

Select Filenaming parameter and press the right arrow key to modify the name of the file forthe result trace.

In the edition keypad, enter a name manually for the file and/or use the predefined parameters available (Cable_Id, Fiber_Num...). Then, press Enter to validate.

Predefined parameters for naming files

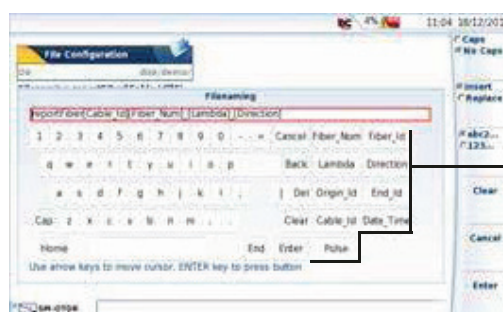

Predefined parameters for naming files

Fig. 19 Filenaming - Edition keypad

or, Press Default Filename to apply the name by default to the file:

Fiber[Cable_Id][Fiber_Num]_[Lambda]_[Direc- tion][Pulse]

The name of the file is displayed in grey under Filenaming parameter

File Content

In this parameter, select the file content for traces saving

One Trace in case of traces in overlay, each trace is saved in a distinct file (.sor extension).

All Traces in case of traces in overlay, all traces are saved in one single file (.msor extension).

Save Mode

When a trace or more is displayed, in the parameter Save Mode, you can select three types of methods for storing traces:

File Only only the trace(s) is/are stored in one/several file(s), with its extension (.sor, .msor)

File + txt the trace(s) is/are stored in one/several file(s), with its extension and one txt file is also generated.

File + pdf the trace(s) is/are stored in one/several file(s), with its extension and one pdf file is also generated.

All the trace(s) is/are stored in one/several file(s), with its extension and one pdf file + one txt file are also generated.

Auto Store

Select Yes to store automatically the trace or traces resulting from each acquisition according to the filenaming rules.

Configuration in Test Auto mode

The Test Auto key imposes the parameters for acquisition, measurement and display of results defined as default settings in factory.

ACQUISITION	Acquisition	Laser	All
		Acquisition	Auto
		Time	Auto
		Smart Acq	No
		OTDR Connector Test	Yes & Cont
		Launch Cable End	No
		Launch Cable Start	No
	Launch Cable		



ALARMS	Alarms	Thresholds	None
ANALYSIS	Parameters	Section Attenuation	dB/km
		Index of Refraction	G652 G657
		Scatter Coefficient	Auto
		Results on trace	Graphics
		OTDR Connector Meas.	No
		Number of Splitters Splice	None
			Auto
	Measurement		

Reflectance	All Ghost	No Fiber End	Auto Bend	Auto
LINK	Link Description	Change Fiber Nr	Increment	
FILE	File configuration	Filenaming	Auto filenaming	

Saving OTDR configuration in a file

Once File and Measurement parameters have been configured, those parameters can be kept in memory and saved in a configuration file.

This configuration file can then be recalled in two cases:

- in order to be applied when acquisition in Smart Test mode is performed.
- in order to be recalled for future acquisition in Expert OTDR To save parameters in a configuration file:

1 If necessary, press SETUP to return to Setup page.

2 Select one parameter in one of the setup page (acquisition, link..)

3 Press menu key. An edition keypad displays

4 Enter a name for the configuration file (max. 20 characters).

NOTE

Configuration file is saved by default in the directory disk/config.

Directory into which file will be saved

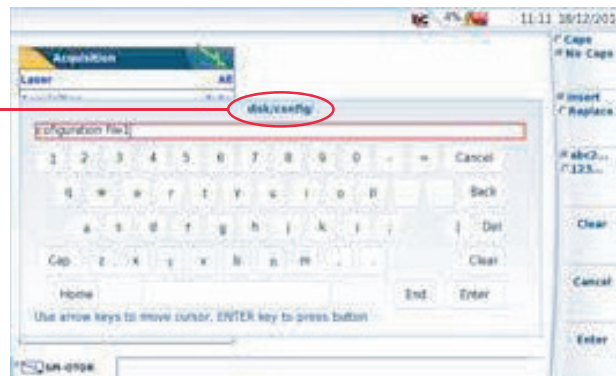

Fig. 20 Save Configuration file - Edition keypad

5 Press Enter to validate. A sound is emitted to indicate the file is saved. The configuration file is saved with the extension .fo_cfg (icon) and can be recalled at any time from the Explorer page.

This configuration file can be selected in Smart Test or loaded for Expert OTDR.

Loading an existing OTDR configuration

To load a configuration file previously created or available in the FiberXpert OTDR 5000 and apply parameters to new OTDR Expert tests:

Saving OTDR configuration in a file

1 Press FILE hard key

2 Select the configuration file desired

3 Press Load > Load Config.

– Press SETUP hard key to display the OTDR acquisition parameters saved in the selected configuration file.

You can modify some acquisition or file storage parameters, and save them in a new configuration file

From the Setup page

- 1 Select one header in either Setup page (Acquisition, Link, File...)
- 2 Press Load Config. menu key. The file Explorer page displays
- 3 Select the configuration file desired
- 4 Press Load Config. to load the configuration file for acquisition in OTDR Expert mode.

A sound is emitted to confirm the loading. The Setup screen is displayed again.

NOTE

Most of the configuration files are available into the equipment, in disk/config.

The main parameters available in the selected configuration file are displayed in the File signature.

Configuration file will be used for Expert OTDR acquisition only

Configuration file will be used for Expert OTDR Test acquisitions

The main parameters available in the selected configuration file are displayed in the File signature.

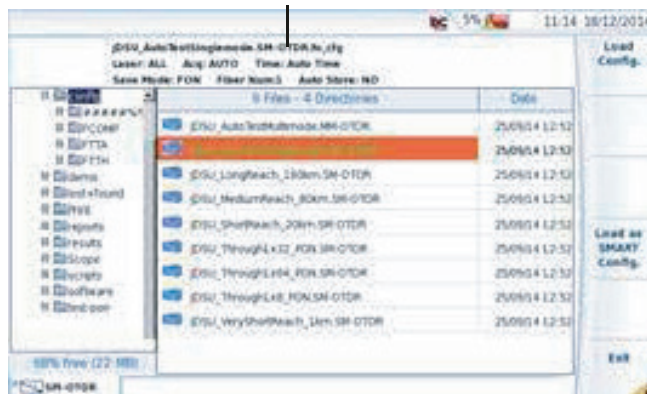

Configuration file will be used for Expert OTDR acquisition only

Configuration file will be used for Expert OTDR Test acquisitions

Fig. 21 Loading a configuration file

LAUNCHING A REFLECTOMETRY TEST AND DISPLAYING RESULTS

Once the configuration for acquisition and file storage has been defined, the instrument is ready to launch an OTDR measurement.

Pressing the START/STOP key is all that is needed to start or stop an OTDR measurement on the FiberXpert OTDR 5000.

This chapter describes the different stages in a reflectometry measurement. It then describes the functions available on trace(s).

The topics discussed in this chapter are as follows:

- “Performing OTDR acquisitions”
- “Results display”
- “Advanced functions
- “Saving the trace(s) and generating a report”

Performing OTDR acquisitions

Performing an acquisition in Real Time mode

Principle of the Real time mode

Acquisition in real time must not be used if a precise measurement is required because of the high noise level, but it is sufficient for rapid optimization of a connection and for observing a fiber in process of utilization.

Performing acquisition in Real Time

To carry out an acquisition in real time:

1 Hold the START/STOP key down for about three seconds, to launch the acquisition in real time.

or

If the Time parameter is defined with Real Time in Setup page, press START/STOP hard key. The red Testing indicator will go on to show that real time acquisition is in progress. The trace acquired is displayed in real time.

An indicator of the state of the connection (Good/Bad) is displayed below the trace:



Table 3 Connection indicator

State	Connection
Good	The connection is OK
Bad	– There are several connectors close to the external connector of the FiberXpert.

– One of the connectors is dirty or badly connected. Replace the launch cable, make the connection again properly or clean the connector of the OTDR or of the jumper.

– No fiber is connected.

If the state of the connection is bad, it is still possible to carry out a measurement, but the results will not be very reliable.



Fig. 22 Example of acquisition in Real Time

Traffic detection

Copy/Cut & Paste files/ directories

Traffic on the fiber under test is automatically detected and reported.

Press the START/STOP key to begin the measurement. A message indicates there is traffic on the fiber and asks you if you wish to continue or not:

– If you click on NO, the measurement is not launched.

– If you click on YES, the measurement is performed, despite the traffic.

NOTE If the measurement is validated despite the traffic (key YES), the next measurement will be automatically performed, even if traffic is still detected on fiber.

If the measurement is cancelled (key NO), and the START/STOP pushed another time, the box asking if you wish to continue or not is displayed.

The functioning of Traffic Detection is then indicated in the scaled down representation of trace, on the upper left part  of screen. During an acquisition in real time, several actions can be made on results in progress: see

Performing an acquisition with Expert OTDR

In this mode, the equipment carries out a number of averagings defined as a function of the maximum acquisition time specified in the Acquisition menu, and then terminates the acquisition.

The acquisition is carried out with the parameters previously selected in the Acquisition menu. It may be stopped at any time using the START/ STOP key.

1 Press the START/STOP key to start the acquisition.

The red indicator goes on to show that the product is in process of acquisition and the screen displays the trace in process of acquisition.

2 The quality of the connection is displayed for a few seconds



3 Then, a bar graph shows elapsed and remaining acquisition time.



Elapsed acquisition time Number of averages calculated Elapsed time Total acquisition time

Fig. 23 Acquisition in progress with FiberXpert OTDR

At the end of the acquisition, a beep is emitted, the trace is displayed and an automatic measurement is started.

NOTE

During acquisition, the traffic on fiber is automatically detected

NOTE

To stop the acquisition, the START/STOP key may be pressed at any time. Then an automatic measurement is carried out, but some events cannot be detected (a manual measurement must then be made).

Performing an acquisition from Results page

Once the results page is displayed, you can perform a new acquisition modifying the main acquisition parameters.



Before launching a new OTDR acquisition, make sure the trace(s) displayed have been previously saved if necessary, as the new acquisition will automatically delete the displayed results.

1 On Results page: in Expert OTDR mode, press the softkey Quick Setup: the acquisition parameters that can be modified display under the results trace. In Smart Test mode, press the softkey Setup: the Setup screen displays



Fig. 24 Results page and Quick Setup menu (Expert OTDR)

2 Modify the acquisition parameters wished in the displayed menu:

– In Expert OTDR mode: Laser / Acquisition / Range / Pulse / Time. – In Smart Test mode: Laser / Fiber Number / Distance unit

3 Once configured, launch the new OTDR test pressing the START/ STOP hard key.

Press again (Quick) Setup menu key to hide the menu under the trace.

Multi- wavelength acquisition

If the module possesses several lasers, to perform successive acquisitions on all the wavelengths:

1 In the SETUP menu, check in Laser line, that several lasers are selected (or select All if a module with only one OTDR port is used).

2 Start the acquisition by pressing the START/STOP button.

3 Once the acquisition for the first wavelength is finished, the acquisition for the following wavelength starts automatically.

or

To stop manually the acquisition for current wavelength, click on Stop Wavelength. This will allow to automatically start the measurement for the following wavelength.

The different traces appear in the same window and can be handled similarly to overlaid traces.

Actions on trace during acquisition

During an acquisition, several actions are available on results in progress.

Actions on trace during acquisition

1 Select Cursor A or Cursor B and:

- Set both cursors A & B to control distance between two points.
 - Set one cursor A or B to get the distance from one point.
 - Set one cursor A or B to zoom on this cursor
-

Zooming on trace

1 Select Zoom function:

- use the menu key in Expert OTDR
-

2 Use touchscreen or validation key to zoom in and zoom out on trace

Shifting the trace

In Expert OTDR mode only, the trace can be shifted vertically or horizontally during the acquisition:

1 Select Shift function on menu key

2 Use touchscreen or direction keys to shift horizontally or vertically the trace

Displaying Trace or Summary page

1 Use the menu key Trace/Summary to display either: – the acquisition trace in progress and the bar graph of time – the Summary page with exclusively the bar graph of time.

In the case of measurement on several wavelengths, once a measurement is completed for one wavelength:

- the Trace function allows to display the trace and results table for this wavelength: once Trace is selected, press validation key (or ENTER) to pass from Trace + results table on 1 line to Trace + results table on 4 lines, and vice-versa,
-

- the Summary function allows to display a summary of results for this wavelength.
-

Modifying acquisition parameters (in Real Time mode only)

You can modify the acquisition parameters without returning to the SETUP menu.

1 Press the Acquisition Param key

2 Use displayed keys to scroll through the possible values of the various acquisition parameters.





Fig. 25 Example of acquisition in Real Time

Zooming on the fiber end (in Real Time mode only)

During a real time acquisition, you can reach the end of the fiber under test at any time:

1 Press Zoom to End menu key.

The display automatically reaches the end of the fiber under test.

The menu key Zoom to End becomes Zoom to Start.

Press Zoom to Start to display the start of the fiber under test.

Performing measurements during acquisition (Real Time mode only)

The real time mode allows to make Loss, ORL or Reflectance measurement using the A & B cursors and the key Loss / ORL / Reflect.:

1 Position A & B cursors on the trace

2 Click as many times as necessary on key  to get the measurement between A & B cursors.



Fig. 26 Example of loss measurement

Results display

The traces acquired or recalled from a memory are displayed on the Results page. According to the mode of acquisition (Expert OTDR or Smart Test), the results page offers similar functions, but also different functions.



Fig. 27 Example of results trace with Smart Test

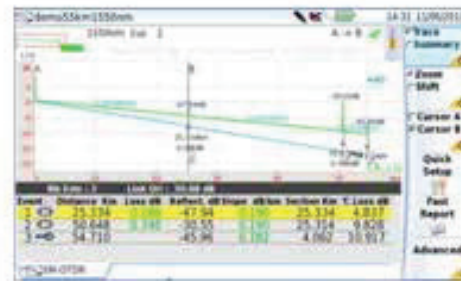

Fig. 28 Example of results trace with Expert OTDR

T– On the upper right side, the alarm icon is displayed (if some alarm thresholds are defined in the pre loaded configuration file).

Table 4 Alarms display

Fail 

Indicates that at least one result exceeds the alarm thresholds defined in the configuration file used for acquisition Results are displayed in red in table.

Valid 

Indicates that all the results lie within the thresholds (no result is in red or yellow). Results are displayed in green in the table.

Common functions

Display of events on the trace

Each event detected is referenced under the trace by a serial number. The reflectometry trace is displayed with a dotted vertical line set on the start of launch cable (if the Launch Cable End parameter is defined in the SETUP menu)

The trace can also be displayed with a dotted vertical line on the end of fiber. 

The icon  is displayed on trace if the Receive Cable Start parameter has been defined in the Setup menu.

The results of the measurements of attenuation, reflectance and slope can be marked on the trace.

The reflectance of a ghost event is displayed in brackets on the trace.

Criteria for display of an event

An event will be displayed if its attenuation or its reflectance exceeds the corresponding threshold selected in the SETUP menu..Attenuation and reflectance results for an event will be displayed if they can be calculated

The reflectance of an event is always measured except when the event causes a saturated Fresnel peak or if it is drowned out by noise. In this case, the FiberXpert OTDR 5000 displays > to show that the actual reflectance exceeds the value displayed.

Results table

Under the trace is displayed the results table with all the events detected during acquisition.

– In Smart Test: if the Total Loss and End of fiber values are displayed under the trace

– click on the trace overview (upper left part of the screen) to display the 4-lines results table

or

– select Trace on Trace/Summary softkey and press validation key (or ENTER) to display the 4-lines results table

Repeat one of this method to come back to Total Loss and End of fiber values.



Fig. 29 Trace + Table results in Smart Test

– In ExpertOTDR mode, once Trace is selected, press validation key (or ENTER) to pass from Trace + results table on 1 line to Trace + results table on 4 lines, and vice-versa

The table with one line displayed under the trace gives the type and characteristics of the event nearest to the cursor.

The 4 lines table gives the type and the characteristics of all the events detected during the measurement: the 4 first lines displayed correspond to the 4 first events nearest to the cursor. The line corresponding to the event nearest to the cursor is highlighted. This highlighting moves if the cursor is moved.



Fig. 30 Example of trace and results table in Expert OTDR

At the top of the table, a line shows the generic parameters of the fiber: numbers of events present, total ORL of the link and, in ExpertOTDR mode, reference trace icon

Each event is referenced under the trace by a number which is repeated in the first column of the table. The table then shows:

– icon symbolizing the type of the event:

	Receive cable Start Launch cable End: the attenuation and distances are measured on the basis of the
	corresponding marker.
	Non-reflective attenuation (e.g. splice).
	Reflective event. (e.g. connector)
	Ghost reflection
	Slope of the fiber (when no fault follows the slope).
	End of fiber
	OTDR connector Merged Connectors Loss

– Total group loss = loss on last connector – Loss connector N-1 = 0 dB)

Event marker when a measurement cannot be carried out. If the event to be added is too close to an existing event, the icon appears on the trace and the table, but no measurement is carried out: to obtain the results for this event, a manual measurement is necessary.

The event underlined in yellow is the one the nearest of the cursor set on trace. To visualize an event, click on this event on the table to set the cursor on it onto the trace.

Detailed description of an event

Click on one event icon in the results table to display the event type and the alarm threshold defined for this event (if Alarms have been defined in the Setup page).

If the value of the event selected exceeds the defined threshold, then the possible causes for this alarm are described in the window:

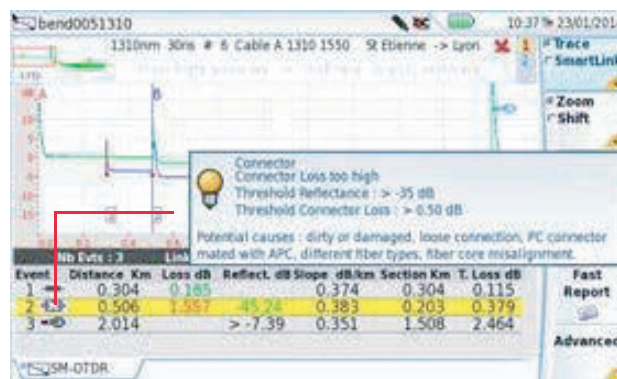

Fig. 31 Event description

The following columns are then displayed next to each event icon:

Distance	The distance of the event from the beginning of the fiber, in meters (or miles)
Loss	The attenuation due to the event, in dB
Reflect.	The reflectance of the event, in dB
Slope (Expert OTDR only)	The slope before the event, in dB/km (or dB/kft) if it can be measured
Section (Expert OTDR only)	The length of the section = the distance between the marker of the event and the previous marker.
T. Loss	The total attenuation of the fiber (total loss), in dB

Cursors

The cursors A and B are represented by vertical lines of different colors:

- in a solid line if the cursor is selected.
- in a dotted line if the cursor is not selected.

Positioning the cursor

1 Press the key  to activate the cursor.

2 Touch the screen on the required location on trace where the active cursor must be set.

You can also use the direction keys ◀ and ▶ to move the selected cursor along the trace

Above the trace is shown the 2-points loss measurement between the two cursors, together with the distance between the two cursors.

The cursors data are displayed exclusively if the Cursor menu key is active. If another key is active, the display shows help tooltips, different according to the selected function.

When the cursor function is selected, the keys ▲ and ▼ move the trace vertically.

Cursors information

The information related to cursors are displayed exclusively when the Cursor function is selected (menu key  selected).

Above the trace are shown the co-ordinates of the points of intersection of the cursors A and B with the trace, together with the distance between the two points.

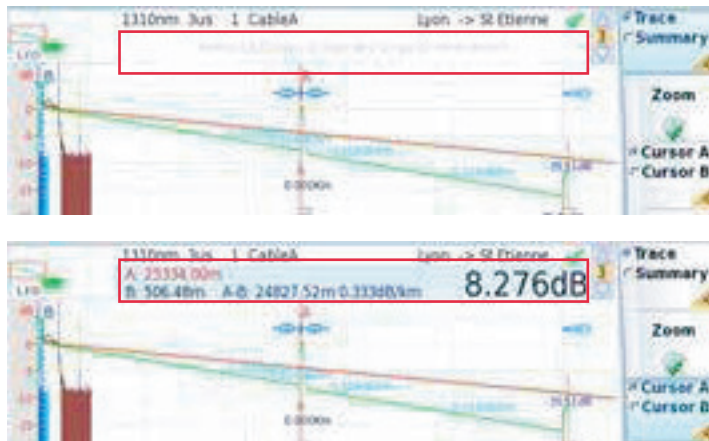

The Cursor function is not selected

The Cursor function is selected

Fig. 32 Cursors information

Cursor function not selected

When Cursor menu key is not selected, the upper banner displays information, different according to the menu key selected:

- If the Trace/Summary key is selected, with Trace function valid, the upper banner indicates that to change the displayed trace, you can click on the banner or on the right arrow key

– If the Zoom/Shift key is selected, and the Zoom function valid, the upper banner indicates that to get an automatic or full zoom, you must press validation key (or ENTER).

Zoom function

The Zoom function is used to analyze part of the trace in greater detail.

The zoom is centered on the active cursor.

The position of the section of trace displayed with respect to the complete trace is represented by a red rectangle on the mini-trace at the top left-hand corner of the screen.

Defining a zoom on the trace using the touchscreen or screen deported on PC

1 Press Zoom or Zoom/Shift softkey to activate the zoom function
– menu key in Expert OTDR

2 Press once in one location on the screen, which will represent the upper left corner of the zoomed area.

The icon  is displayed on the screen

3 Press another time on the location which will represent the lower right corner of the zoom.

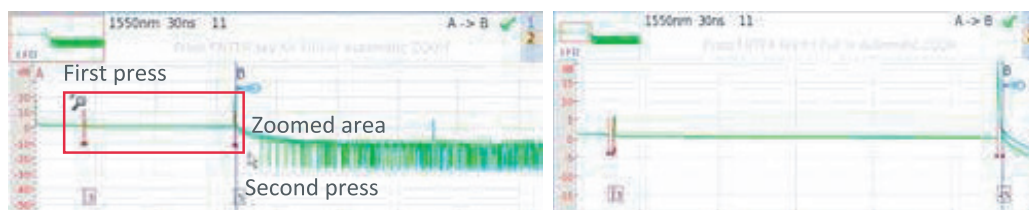

Fig. 33 Zoom on trace using touchscreen

Defining a zoom level on the trace using direction keys

1 Select Cursor A or B and center it on the zone to be examined

2 Press Zoomsoftkey.

3 Use the ◀ or ▶ key to increase or reduce the zoom factor, keeping the selected cursor centered on screen.

Defining a zoom on the trace using the touchscreen or screen deported on PC

Swapping from an automatic zoom to full trace and vice-versa

The automatic zoom allows to get an optimized display of the trace. To apply an automatic or entire zoom on the trace:

1 Press Zoomsoftkey.

2 Press validation key ( or ENTER) to apply an auto zoom on trace.

Press again validation key ( or ENTER) to display the trace in full screen.

Specific functions of the zoom with a touchscreen

With the touchscreen, once the Zoom function is selected on menu key Zoom, you can:

- maintain your finger pressed on screen and shift the traces horizontally or vertically
- position your finger on a cursor and move it on trace maintaining your finger pressed and moving it toward left or right
- once a zoom is performed, double click on the zoomed zone to undo the zoom

Zooming on the different events in succession

- 1 Set the cursor on one event
- 2 Define a zoom on this event.
- 3 Click on another event in the results table

The cursor is automatically positioned on this event, which is always centered on the screen, keeping the zoom level selected.

- select Trace on Trace/Summary softkey and press validation key (or ENTER) to display the 4-lines results table

Repeat one of this method to come back to Total Loss and End of fiber values.

Shift function

The Shift function is used to displace the displayed section of the trace by pressing the direction keys or directly clicking on the touchscreen.

The horizontal shift is performed maintaining the point of intersection between the trace and the selected cursor at the same level, scrolling the trace horizontally while following it vertically, so that it never goes off the screen.

To use this function:

- 1 Select the zoom factor as described above.
- 2 Choose cursor A and cursor B position.
- 3 On the Zoom/Shift key, select Shift.
- 4 Displace trace manually on touchscreen toward left/right or upward/ backward. or Use the direction keys to shift the trace in the desired directio

Summary

To display a summary of the results, select Summary function on Trace/ Summary menu key.

The upper table displays a summary of results for each wavelength onto which measurement has been performed.

Some results can be displayed in color (green or red) if they lie within or exceed the alarm thresholds defined in the Setup screen in ExpertOTDR mode and defined in the configuration file used for acquisition in Smart Test mode.



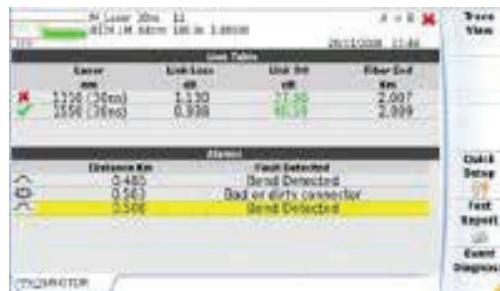

Fig. 34 Summary page & Alarms table

In the lower part of the screen, the Alarms table, gives the summary of the alarms detected (Reflectances, Splices, Splitters, Connectors, Bends...).

Select one event in the Alarm table and click on Event Diagnosis menu key or directly on the event icon in the Alarm table to get a detailed description of the event.

Click on Trace View softkey to return to display of Trace + Results Table.



Abb. 35 Summary key - Event Diagnosis

Display of traces in overlay

- The traces are shown in different colors (the active trace is green).
- The mains acquisition parameters are displayed at the top of the screen.



Fig. 36 Traces in overlay

Selecting one trace from overlaid traces

To make actions on a trace in overlay (move on events, set a cursor...), it must first be swapped with the active trace. To do this:

1 Press the Trace key

2 Press the direction keys and , as many times as necessary, until the active trace is displayed in green. traces numbers

or

Click on the trace numbers in the upper right side of the result page until the trace desired is selected.

or

Click on the upper part of the screen, in Trace information zone to scroll the traces.

NOTE

Actions relative to traces (move cursors, move on events...) are exclusively done on the active trace (in green), not on the other ones.

Traces display in double acquisition mode

When a double acquisition has been performed, i.e. a short acquisition preceding a standard one, two traces are displayed in the same window.

Standard acquisition
(in green)

Short acquisition
(in blue)

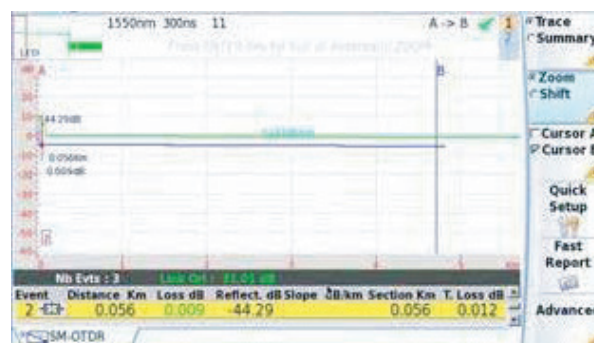

Fig. 37 Traces display in double acquisition mode

The short trace is the one resulting from the short acquisition and stops while the standard

Advanced functions

Automatic measurement and detection

If the instrument does not detect all the expected events, additional manual measurements can be carried out.

To delete all the markers:

1 Press the Advanced key

2 Press the Modify meas.key,

3 Select Delete.

4 Press validation key ( or ENTER)

The following procedure is then recommended:

1 By default, the instrument locates the events and proceeds to the measurements.

2 Addition of events in the cases of splices showing low attenuation and of close events. The FiberXpert OTDR 5000 then automatically measures the slope before and after the markers selected and measures the attenuation of the splice.

3 Addition of manual measurements if necessary (for deeper analysis).
The FiberXpert OTDR 5000 performs the measurements requested by the user.

To start an automatic measurement while a measurement is already in progress:

1 Press the Advanced key.

2 Press the Modify meas.key

3 Select Delete and press validation key ( or ENTER).

4 Select Auto Meas. and press validation key ( or ENTER).

Addition of events

You can also manually place markers in addition to those positioned automatically during automatic measurement.

Addition of events

The events are represented by the symbol  if they are set during a measurement.

The events are represented by the symbol  if they are set manually in Advanced mode.

To add markers of events:

1 Select a cursor (A or B).

2 Use the direction keys or touchscreen to move the cursor to the place where you want to position a marker.

3 Press the keys: Advanced > Set Event.

4 An event marker  is displayed at the position of the cursor and a measurement is carried out on the event.

Measurement of slope before the marker starts just after the previous event (or at the end of the dead zone at the beginning of the fiber); measurement of slope after the marker stops just before the next marker or at the end of the fiber.

Hints on the positioning of markers

- Do not add markers (with the Set Event key) after a manual measurement, as all the results will be recalculated automatically by the instrument.
- If two markers are too close together, they will appear on the trace and the table but no measurement will be carried out on the second marker: to obtain results for this marker, a manual measurement is necessary.
- If you press the Set Event key when the cursor is very close to a marker, the latter will be deleted.

Deleting events

To delete an event, move the cursor onto the event and press the Set Event key. The event selected will be deleted and a complete measurement, without this event, is carried out.

Deletion of events can cause incorrect measurement results.

Manual measurements

As soon as you have made an acquisition, with or without automatic measurement, you can make manual measurements on any event on the trace by means of the cursors A and B, in association with the functions of slope, detection of splice and calculation of ORL.

1 The manual measurements are accessible in the Results page, after pressing the keys: Advanced, Modify meas, then Manual Measurement.

Measurements of slope

To make a manual measurement of slope, press the RESULTS button to call up the trace and then:

- 1 Place the cursor A at the beginning of the section of the trace where the slope is to be measured.
- 2 Place the cursor B at the end of this section.
- 3 Press the Advanced key
- 4 Press the Modify Meas. key
- 5 Press the Manual key, then select Slope.
- 6 Press validation key (⏏ or ENTER) : the slope of the specified trace section is displayed.



Slope

Fig. 38 Manual Measurement results

Result of slope measurement

The result is displayed on the screen between the two slope indicators [and].

The measurement results are also available in the table:

- 1 Press Exit to return to the initial results page.
- 2 Select Trace using Trace/Summary soft key
- 3 Press validation key ( or ENTER) to display results table under the trace.

“Distance” shows the distance between the beginning of the trace and the end of the slope

If no result is displayed in the table, this means that the distance between the cursors A and B is too small.

Deleting a slope measurement

To delete a particular slope measurement result:

- 1 Superimpose the cursors A and B on the slope concerned
- 2 Select Slope (after, if necessary, pressing Advanced > Modify Meas.> Manual Meas.).
- 3 Press validation key ( or ENTER) : the slope of the specified trace section is deleted.

Measurement of ORL

It is possible to carry out an ORL measurement on a part of the fiber. Follow the following procedure to measure a part of the fiber:

- 1 Position the cursors A and B to delimit the section that you wish to measure.
- 2 Press the Advanced > Modify Meas.> Manual Meas., then select ORL.
- 3 Press validation key ( or ENTER) .

The ORL is measured for the section of trace defined.



Fig. 39 Result of ORL measurement

ORL on a saturated trace

If saturation occurs during an ORL measurement, the result is given with the sign <. This means that the actual ORL value is less than the value displayed.

Measurement of Reflectance

It is possible to carry out a reflectance measurement of a Fresnel for a reflective event.

Follow the following procedure to measure the reflectance:

- 1 Position the cursor A at the base of the peak
- 2 Position the cursor B at the top of the peak of the required Fresnel, or after the peak to calculate automatically the maximum reflectance.
- 3 Press the Advanced > Modify Meas.> Manual Meas., then select Reflec..
- 4 Press validation key (**OK** or ENTER) .

The Reflectance value is defined in dB, and displayed in purple.

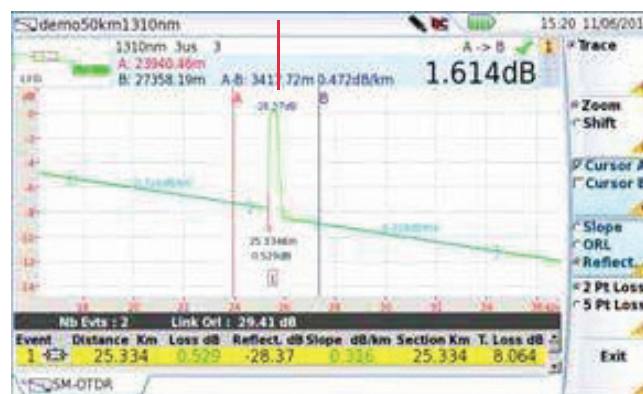

Fig. 39 Result of ORL measurement

Splice measurements

There are two methods of carrying out manual measurements of splices on the trace: the two-cursor method and the five-cursor method.

The five-cursor method is the more accurate, as it takes into account the difference of level between the slope before the splice and the slope after the splice. This method should be used whenever possible.

If very close events have created a dead zone preventing the measurement of slope by the five-cursor method, it is possible to use the two-cursor method. This considers the difference in level between the cursors.

Before performing one of these measurements, define in the Setup menu the splice detection threshold.

Two points method

To perform a splice measurement by the “two-points” method, display the

Results page, then:

1 Place cursor A exactly on the fault, then place cursor B after the splice that you wish to define.

2 Press the Advanced key, then Modify Meas.> Manual Meas., then select the function 2 Pt Loss.

3 Press validation key ( or ENTER).

The splice marker is placed at the point defined by the first (left-hand) cursor and the result is displayed on the screen. If the fault is reflective, the reflectance value is also measured and displayed. These results are added to the table of results.

NOTE

If you try to measure a splice on a slope, the measurement is not carried out and the following error message is displayed: “Slope found between two cursors”.

Five points method

To carry out a splice measurement by the “five points” method:

1 Measure the slope preceding the fault to be measured, then the slope following it.

2 Place the cursor on the fault (between the two sections).

3 Press the Advanced key, then Modify Meas.> Manual Meas., then select 5 Pt Loss.

4 Press validation key ( or ENTER).

The splice event marker is placed on the cursor and the result is displayed on the trace and in the table of results.

NOTE

If no result is displayed, it is possible that the display threshold of the attenuation measurement result is higher than the attenuation that you are trying to measure.

NOTE

If you try to measure a splice on a slope, the measurement is not carried out and the following error message is displayed: Slope found between two cursors.

Memorization of the position of events

To memorize the position of events with a view to repeating the measurements at the same place during a future acquisition or on another trace, press the Advanced key, then select Lock Evt. The event memorization icon  will appear in the title bar.

The positions memorized will then be used in the subsequent measurements, either at the end of the manual acquisition, or when a stored trace is recalled.

NOTE This function memorizes the markers placed on the current trace. The following procedure is recommended to start a measurement with markers:

- 1 Carry out an automatic measurement.
- 2 Memorize the position of the events selecting Lock with the key in the Advanced menu. 
- 3 Add the manual measurements required (keys: Advanced > Manual Meas.).

CAUTION

If an event is added (with the Set Events key) after manual measurements have been performed, then all the events on the trace will be converted into AUTO markers and an automatic measurement will be performed using these events. The previous manual measurements will be lost.

Provided the event memorization icon  is displayed, the automatic measurement following the acquisition is carried out using the events which were present before the acquisition.

If you wish to make a measurement without events, deactivate memorization of events by pressing the Free Events key.

Overlay trace function

This very useful function enables up to eight traces to be displayed on the screen at once:

- either to compare traces acquired on a number of different fibers in the same cable,
- or to observe changes over time in traces taken of one and the same fiber.



Fig. 41 Example of overlaid traces

Overlaying several traces stored in memory

If an event is added (with the Set Events key) after manual measurements have been performed, then all the events on the trace will be converted into AUTO markers and an automatic measurement will be performed using these events. The previous manual measurements will be lost.

To display up to 8 traces from the memory, deleting the current trace(s) already loaded:

1 Press the FILE button.

2 Select the files of the traces for display.

3 Press the Load key.

4 Press View trace(s).

5 When loading is complete, the Results screen appears: the first trace selected is the active trace (in green), the other traces being overlaid.

Display of traces in overlay

– The traces are shown in different colors (the active trace is green).

– Their serial numbers are repeated at the top of the screen.

– The OTDR markers are referenced on the active trace by the symbol, and on the other traces by vertical dashes.

Adding traces in overlay

With one or more traces already displayed, to add further traces to the display (the number of traces displayed cannot exceed 8):

1 Define at least one trace as reference

2 Press the FILE button, and in the Explorer, select the files of the traces to be added.

3 Press Load key.

4 Press the View Trace(s) or Load Trace + Config.

When loading is complete, the new traces are displayed in overlay with those that were defined as reference traces

NOTE

If the number of files selected exceeds the display capacity, a message gives warning that loading will be incomplete: only the trace or traces selected first will be displayed, up to the permitted limit of 8 traces.

Overlaying several traces stored in memory

If an event is added (with the Set Events key) after manual measurements have been performed, then all the events on the trace will be converted into AUTO markers and an automatic measurement will be performed using these events. The previous manual measurements will be lost.

Swapping overlay traces

Measurements can only be made on the active trace and not on overlaid traces. To make measurements on a trace in overlay, it must first be swapped with the active trace.

1 Press the Trace key,

2 Press the ◀ and ▶ direction keys, as many times as necessary, until the active trace is displayed in green.

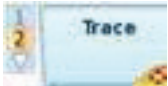

traces numbers

or

Click on the trace numbers in the upper right side of the result page until the trace desired is selected.

Removing a trace Removing the current trace in overlay

It is possible to remove a trace displayed. To do this, first select it (see previous paragraph), then successively press Advanced > Overlay > Remove Current Trace.

Removing all the traces in overlay

To remove all the traces except the current trace, then successively press Advanced > Overlay > Remove Other Traces.

Quitting the overlay menu

To quit the overlay menu, press the Exit key.

Reference Trace function

The reference trace function consists in defining trace(s) which will be «blocked» on screen and used as models before acquiring or loading other standard trace(s).

Use of the reference trace function in the Result page

Once one or several trace(s) is/are displayed, after an acquisition or loaded from the explorer:

1 If several traces are in overlay, check the correct current trace is selected

2 Go in the Advanced menu

3 Click on Overlay

4 Click on Set curve As Reference key.

The active trace becomes the reference trace;

– the icon  appears on the upper right hand part of the results table.

To define all the traces displayed as reference traces, click on Set All As Reference key (whatever is the active trace).

Removing the reference trace(s)

To change one reference trace into a «standard» trace, select it using the Trace/Event key, and in the Advanced > Overlay menu, click once again on Set curve As Reference.

Performing an acquisition once one or several trace(s) is/are defined

To change all the reference traces displayed into «standard» traces, whatever is the active trace, go in the Advanced > Overlay menu and click on Set All As Reference.

Three situations can occur once an acquisition is performed:

– Only reference trace(s) is/are displayed: the trace acquired is added to the reference ones.

– Reference trace(s) and «standard» trace(s) are displayed: the reference trace(s) are «blocked», the standard ones are removed and the new trace acquired is displayed with the reference one(s).

– No reference trace(s) defined: all the «standard» traces are removed and only the new trace acquired is displayed.

Using the reference trace function in the explorer

To open one or several reference trace(s):

A trace stored in memory can be set as reference trace before loading one or several «standard» trace(s).

2 Define a zoom on this event.

2 Select the trace(s) to be defined as reference

3 Click on Load and select Reference = Yes on the key 

4 Click on View Trace(s) or Load Trace + Config.

The icon  appears on the upper right hand part of the results table.

To open «standard» traces to be added to the reference ones:

1 Go back to the Explorer

2 Select the trace(s) to be opened in the same screen as the reference traces

3 Click on Load and select Reference = No on the key

4 Click on View Trace(s) or Load Trace + Config.

Saving the trace(s) and generating a report

Once the results page is displayed, the trace(s) can be saved and a report can be generated directly from the results screen.

The traces saving and report generation can have already been performed automatically if the parameter Auto Store was defined on Yes in the Setup screen with the appropriate Save Mode (file only or file + txt or + pdf).

Saving results and creating a report from results page

To save the trace and generate a report:

1 Press Fast Report key  ->  .

A menu displays under the trace.

2 In the menu, configure the file saving mode (and the report)

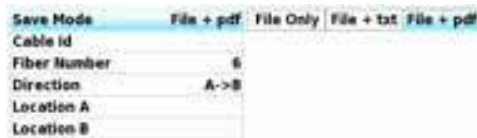



Fig. 42 Fast report configuration

- A In the Save Mode parameter, select:
 - File Only to save exclusively the trace in a sor file
 - File + txt to save the trace in a sor file and to generate a txt file of the results
 - File + pdf to save the trace in a sor file and to generate a report in a pdf format
 - B In the Cable Id parameter, enter/modify the name of the Cable using the edition keypad.
 - C Modify the Fiber Number using the key  .
 - D In the Direction parameter, select/modify the direction, to define if the measurement has been performed from Origin to Extremity (A -> B) or from Extremity to Origin (B -> A)
 - E In the Location A and Location B parameters, enter/modify the name of Origin and Extremity.
- 3 Once saving is configured as wished, press Save All menu key
- 4 Enter a name for the file in the edition keypad. or
- Click on Auto Filenaming menu key to apply the file name defined in the Setup screen, in Filenaming parameter
- 5 Press Enter to validate

NOTE

The sor file and the txt or pdf file will have the same name.
The icon 🗑️ displays during saving process.

Once saving is completed, a sound is emitted onto the Platform.

NOTE

The file and the report are saved in the last storage media and directory selected.

Saving and report for traces in overlay

If several traces are displayed in overlay in the results page, one or several file(s)/ report(s) is/ are generated:

– If in the File Setup page (SETUP > File), the parameter File Content is defined with One Trace, one sor file and one pdf/txt report will be generated for each trace

Example: if 3 traces are displayed in overlay, 3 .sor files and 3 pdf/txt files will be saved.

– If in the File Setup page (SETUP > File), the parameter File Content is defined with All Traces, one single .msor file and one single txt/ pdf report will be generated, bringing together all traces.

Example: if 3 traces are displayed in overlay, one single .msor file and one single txt/ pdf file (with one trace per page; except if the results table is too long for one page) will be saved.

Opening a report

1 To open the report, press FILE hardkey

2 In the Explorer page, in the directory selected, select the file/report.

The file name is:

For the txt file: trace file_sor.txt

For the pdf file: trace file.sor.pdf

3 Press Load.

The file opens on the FiberXpert OTDR 5000.



Fig. 43 PDF report

SLM (SmartLinkMapper) option

The SLM function is usable with OTDR trace exclusively and can be used either with a trace just acquired or with OTDR trace(s) saved onto the equipment.

- 1 Return to the result trace pressing RESULTS hard key (or load an OTDR file from the Explorer).
The Trace/Summary menu key is replaced by the Trace/Smart- Link menu key.
- 2 Click on this menu key to select SmartLink. A screen as the following one is displayed:

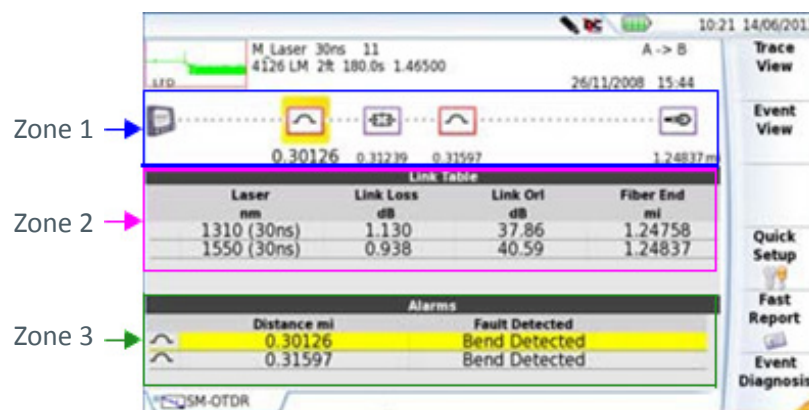

Fig.44 SmartLink Function



The screen is divided into three zones:

Zone 1: Graphical representation of the link, with icons symbolizing the different events detected.

Zone 2: Link Table, which gives a summary of results for each wavelength, with results within/without thresholds in green/red (according to Alarm thresholds defined in the setup screen).

Zone 3: Alarms table (if any)

Show the detailed information of one event

The information concerning the event, its type and the alarm thresholds defined for this event, can be displayed from the SmartLink screen.

1 Select the event for which information must be displayed, on the graphic using the touchscreen or direction keys. The event is highlighted in yellow once selected.



2 Click on the Event Diagnosis menu key. A small window displays. It describes:

- the event type
- the value above which it is on defect



Fig.45 Event Diagnosis

Event View

1 Click on Event View menu key to display a detailed description of one event detected on trace.

2 Select the event to be described on graphic (highlighted in yellow).

The corresponding event description is displayed on the Zone 3, with a recall of alarm threshold for this event:



Fig.46 SmartLink Event View

3 Click on View Trace to display the selected event in the results table and zoomed on trace.

NOTE

The event is framed in red if it is above the alarm thresholds defined in the setup menu.

It is framed in green if it lies within the thresholds.

It is framed in grey if no alarm has been defined in the Setup menu

Changing the type of an event

Once the Event View is displayed, the type of event can be modified:

- 1 Select the event to be modified (framed in yellow)
- 2 Press Event Code menu key
- 3 Click on the event type to be applied to the selected event:



Fig.47 Event Code

- 4 Click on Exit to return to Event View.
- 5 Click back on Event View menu key to return to Summary screen or
- Click on Trace View menu key to return to trace (and table) results screen





NOTE

The event modification is automatically applied on trace and in the results table.

Splitter sub-menus





The Splitter icon is different according to the menu key pressed in the Splitter sub-menus

Example:

If the menu key  is pressed, the icon  is displayed
 If the menu key  is pressed, the icon  is displayed.

Moreover, the icon and splitter configuration is different according to the number of «clicks» on one menu key.

Example with the menu key 

- Click once: the icon is 
- Click twice: the icon is 
- Click three times: the icon is 
- Click four times: the icon is 

Click a sixth time to reset the event by default.



10-POWER METER AND SOURCE OPTIONS OF THE OTDR MODULES

A variety of options are available when ordering an OTDR Module. Option:

The topics discussed in this chapter are as follows:

- “Connection to the power meter”
- “Configuring the Power meter”
- “Activating the Source function”
- “Result page”
- “Performing the power level measurement”
- “Performing the insertion loss measurement”
- “Storing and reloading results”

Connection to the power meter

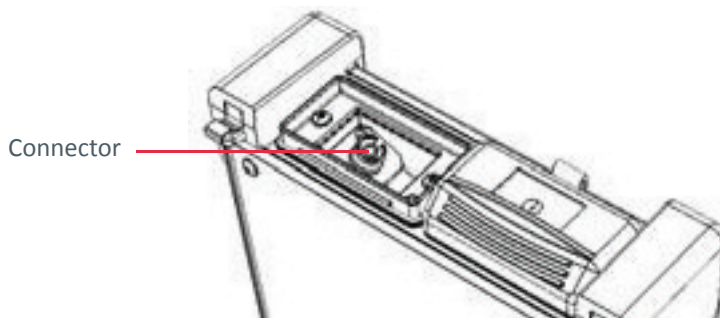

Fig. 48 Optical connector for the Powermeter or Source on the OTDR Module

The type of optical connector used for the power meter is the same as the OTDR port.

With 2 OTDR ports, select the port of connection according to the wave-length available at each port (a label gives information at the back of the OTDR module).



It is not possible to use simultaneously the Source function and the Powermeter function, when both options are set onto the OTDR module, as they use the same connector.

Configuring the Power meter

To activate the function:

1 Press the HOME button

2 Select the power meter icon in the section of the OTDR Module

The icon turns yellow  .

The effect of this action will be to bring the power meter into use.

CAUTION The Powermeter icons of the singlemode port and the one of the Multimode port cannot be selected at the same time. When one is selected, it automatically deselects the other one.

Configuring the measurement parameters of the power meter

The measurement parameters can be accessed with the SETUP key.

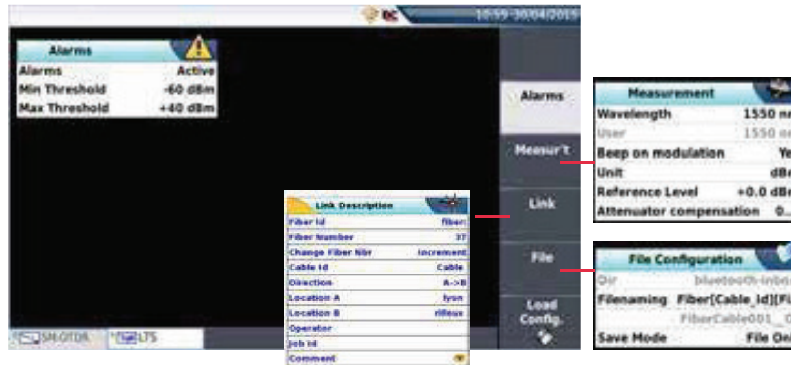

Fig. 49 Configuration of power measurement

Configuring the alarm parameters

Activation of the Alarm function: any result below the lower threshold or above the upper threshold will be displayed in red on the Results page.

Min and max thresholds

Choice of lower and upper thresholds for each available wavelength, from -60 to +40 dBm (selected with the direction keys).

NOTE

To copy one value of the Lower or/and Upper threshold for all wavelengths, select the reference value and click on Update for All Wavel..

NOTE

A continuous push on direction keys increments the value by 10 dBm.

3 On the Zoom/Shift key, select Shift.

4 Displace trace manually on touchscreen toward left/right or upward/ backward. or

Use the direction keys to shift the trace in the desired directio

Configuring the Measurement parameters

In the Setup page, press Measur't soft key (if one parameter is selected in the current screen, press Top Menu soft key to display the right menu keys and click on Measur't)

Wavelength

Select wavelength: Auto: the wavelength of the input signal will be automatically detected and selected to perform the measurement: 1310, 1490, 1550, 1625 or 1650 nm: measurement performed at specified wavelength.

Beep on modulation	Select if a sound must be heard when a modulation occurs (Yes / No)
Unit	Unit of power displayed: Watt, dBm for displaying absolute power dB for displaying a result relative to a reference (link loss)
Reference level	If dB units were chosen in the previous line, selection of the reference value for the wavelength selected. Using the direction keys, first choose the wavelength, then press the > key to access choice of the value (+XXX.XX), then confirm this value with the ENTER key. This reference is also automatically available, in the Results page, using the Set as Reference key.
Attenuator compensation	Choice of level to be applied to the wavelength chosen for measurement to compensate for the loss due to the external attenuator (+XX.XX dB). First use the direction keys to choose the wavelength, then press to access choice of value, then confirm this value pressing ENTER.
	<p>NOTE</p> <p>To copy a Reference Level/Attenuator Compensator on all wave- lengths, select the reference wavelength and click on Update for All Wavel..</p>

Configuring the Link parameters

In the Setup page, press Link soft key (if one parameter is selected in the current screen, press Top Menu soft key to display the right menu keys and click on Link).

NOTE The softkey Copy File/Link To all is displayed when one parameter is selected in the Link or File Setup page and when the Powermeter or Source function is active. It allows to apply the Link and File configuration parameters of the current applications to all the other active Fiber Optic applications (powermeter and source). The information entered in the Link Description window concerns the editing and/or the modifications of the cable and fiber parameters. When a trace is recalled without recall of the configuration, the parameters of this trace will be present only in its signature.

Fiber ID

Select the parameter Fiber Id and enter a name for the fiber, using the edition keypad.

Fiber Number / Fiber Code

The parameter Fiber Number becomes Fiber Code if, in the Cable Structure window, the Cable Content parameter is defined on another parameter than Fiber (Ribbon/ Fiber, Tube/ Fiber or Tube/Ribbon/ Fiber).

The fiber code corresponds to the fiber number if, in the Cable Structure, the parameter Color coding is defined on No.

The fiber code corresponds to the fiber color if, in the Cable Structure, the parameter Color coding is defined on Yes.

Select the parameter Fiber Number/Fiber Code and modify the parameter using the left and right direction keys.

The fiber number can be automatically incremented/decremented at each new file save if it has been configured in the File Setup page (see

NOTE The Fiber Code and the fiber number concatenated with Fiber Name are interdependent: they are incremented or decremented at the same time. However, the fiber number remains a number only, while the fiber code is alphanumerical. Whether it includes a color code or not it may be composed of one, two or three parts

Fiber and cable parameters used in the example:

Fiber Name: 'Fiberx'
 Cable Content: 'Tube/Fiber' Max Tube: 12
 Max Fiber: 24
 Coding used for the fiber and the tube: TIA

	Fiber N		Fiber N+1	
Color Code	Yes	No	Yes	No
<Fiber Name>	Fiberx24	Fiberx24	Fiberx25	Fiberx25
<Fiber Code>	Bl/Aq-	1/24	Gold/Bl	2/1

Fig. 50 Example of incrementation of fiber code

Change Fiber Nbr

the Setup page, press Measur't soft key (if one parameter is selected in the current screen, press Top Menu soft key to display the right menu keys and click on Measur't)

Increment the fiber number is automatically incremented at each new file-save.

Decrement the fiber number is automatically decremented at each new file-save

User defined Use Edit Number softkey to enter the increment/decrement value for fiber number.

NOTE To decrement the number, enter the sign «-» before the number. Example: -1. Min: -999 / Max: 999 / Auto: 0

No the Fiber number must not automatically modified.

Extremities are different

In some cases, it is interesting to save different information for the origin and the extremity of the cable.



If this option is validated, it is possible, after selecting the extremity to be edited in the Cable Structure menu, to modify the values specific to the cable (cable name, color coding, content of the coding), for each of these extremities.

To display/modify the data specific to the fiber (name and code), it is necessary to change direction temporarily. In the "O->E" direction, the information on the origin can be edited, and in the "E->O" direction, that on the extremity.

Cable Id

This parameter allows to enter an identification of the cable, using the Edition menu.

Direction

The direction shows if the acquisition has been made from the origin to the extremity (A->B) or from the extremity to the origin (B->A). Changing direction makes it possible, when different extremities are handled, to see the parameters of the fiber for the other extremity.

Location A

The name of the Location A of the link may be entered here.

Location B

The name of the Location B of the link may be entered here.

Cable structure

This line opens a sub-menu, all the parameters of which can be different for each extremity.

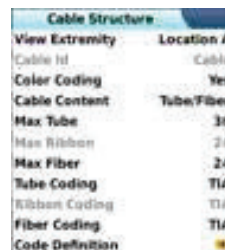

Fig. 51 Cable structure menu

NOTE

The Cable Structure window is specific to an extremity. Each structure keeps its own parameters by default.

Modifications made to the one are not automatically applied to the other. Thus, after the values relating to the origin have been modified, it is normal not to find these same values entered for the extremity.

View extremity	If extremities are declared as different, this parameter allows to navigate between the Extremity and Origin parameters.
Cable Id	If the extremities are different, you can specify the cable identification for the origin and the extremity.
Color Coding	Choice of whether or not to apply a color coding to the fiber. This choice is made at link level, as all the fibers of a given link, for a given extremity, will be coded the same way. This choice modifies the result of the <Fiber Code> line.
Cable content	Shows how the color code is to be used (see figure
– Fiber	Only the color code of the fiber is proposed (example: «Gold»)
– Ribbon/Fiber	The color code of the fiber is preceded by that of the ribbon, and separated by a '/' (example: 'Bl/Or')
– Tube/Fiber	The color code of the fiber is preceded by that of the tube, and separated by a '/' (example: 'Br/ Or')
– Tube/ Ribbon/ Fiber	The color code of the fiber is preceded by that of the tube, then by that of the ribbon; the three being separated by a '/' (example: 'Br/Bl/Or').
Max tube	Shows the maximum number of tubes in the cable for the extremity selected. This information influences the automatic coding of the fiber.
Max ribbon	Shows the maximum number of ribbons in the cable for the extremity selected. This information influences the automatic coding of the fiber.
Max fiber	Shows the maximum number of fibers in the cable for the extremity selected. This information influences the automatic coding of the fiber.
	NOTE
	Some parameters are not valid in the configuration selected. Thus, if no tube is selected in Cable Content, all the lines relating to the tube concept will be deactivated (grayed out in the menu).
Tube Coding, Ribbon Coding, Fiber Coding	The lines Tube Coding, Ribbon Coding and Fiber Coding enable selection of the color coding of the tube, the ribbon and the fiber from 5 different codes described below: TIA, USER 1, USER 2, USER 3 and USER 4.
Code Definition	The Code Definition line opens a sub-menu, with which the different color codes possible on the instrument can be displayed and modified.
	The standard code (TIA) may be displayed but it cannot be modified.
	The other codes, called by default USER1, USER2, USER3 and USER4, can be entirely personalized.
– Edited code	selects the code for display or modification.
– Code name	to give a new name to the code selected, press the ► key, which calls up the edit menu.
– View codes	displays the color codes 1 to 12, 13 to 24 or 25 to 36.



– Code 1...23 Use the arrow ► to modify the codes if necessary.

Operator

Use the arrow ► to enter the name of the operator carrying out the measurement.

Comment

In contrast to the other data in this menu, the comment is specific to a fiber. This line is thus used to enter a new comment and not to display it. The comment appears at the top of the screen, with the other parameters of the fiber.

This comment will remain available for the next acquisition, unless it is deleted. It is also saved when a trace is saved with a comment.

Configuring the File parameters

The File storage parameters must be also configured, in order to define how the results will be saved on to the Product Name/Family Brand.

In the Setup page, press File soft key (if one parameter is selected in the current screen, press Top Menu soft key to display the right menu keys and click on File).

Dir

This parameter cannot be configured, and display the directory selected by default into which the file(s) will be saved (the last directory selected).

To modify the directory, go to the Explorer page and select another directory.

Filenaming

Select Filenaming parameter and press the right arrow key to modify the name of the file for the result trace.

In the edition keypad, enter a name manually for the file and/or use the predefined parameters available (Cable_Id, Fiber_Num...). Then, press Enter to validate.

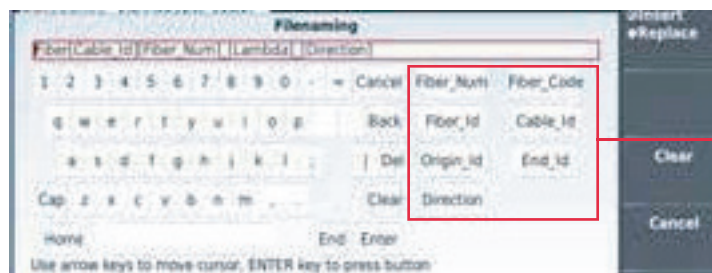

Predefined parameters for naming files

Fig. 52 Filenaming - Edition keypad

or

Press Default Filename to apply the name by default to the file: Fiber[Cable_Id][Fiber_Num]_[Lambda]_[Direction] The name of the file is displayed in grey under Filenaming parameter

Save Mode

When a trace or more is displayed, in the parameter Save Mode, you can select three types of methods for storing traces:

File Only

only the trace(s) is/are stored in one/several file(s), with its extension (.sor, .msor)

File + txt

the trace(s) is/are stored in one/several file(s), with its extension and one txt file is also generated.

Activating the Source function

The Source function is an option chosen at the time of order and incorporated into the OTDR module in the factory. To activate the function:

1 Press the HOME button

2 Click on the icon Source in the OTDR Section The icon turns yellow. 



CAUTION

The Singlemode and Multimode Source icons cannot be selected at the same time. When one is selected, it automatically deselects the other one.

Result page

The results page, automatically displayed after the icon selection, gives the information relating to the measurement in progress, results previously saved and the commands available for measurement and saving.

Result page of the Power meter

The power measured by the power meter is displayed in large characters, in the units selected in the Setup menu, together with:

- the mode of transmission of the signal measured: continuous (CW) or modulated to a frequency of 270Hz, 330Hz, 1KHz, or 2KHz.
 - the wavelength of the signal measured.
 - the reference level expressed in dB.
 - the level of Attenuation Compensation.
-



Table of results

For one and the same fiber, the power meter displays a table of 9 results corresponding to the different possible wavelengths. The table shows the power measured in dBm, the relative power (in dB) and the reference level in dBm (if units = dB), together with the mode.

– A measurement result is displayed in the table when the Keep Result softkey is pressed.

– The Clear Table softkey orders deletion of all the results displayed in the table.

– If the Alarm function has been activated, any result that exceeds the selected thresholds appears in red in the table. Otherwise, results are shown in the table in green.

– When the instrument is switched off, results present in the table are saved.



Fig. 48 Results and commands of the power meter



Fig. 53 Source result page

Laser On / Laser Off Activation or shut-down of the laser (same function as the START/ STOP button)

When the laser is on, the icon is displayed.

The parameters of the source can be accessed directly on the result screen:

Wavelength

To change the wavelength when a multi wavelength source is present (depending on option).

Mode

The wavelength value is displayed.

To vary the mode of emission of the source.

Possible modulation values are:

- 270 Hz / 330 Hz / 1 kHz / 2 kHz
- Auto (the sources emit on determined frequencies to enable the power meter to detect the wavelength used automatically)
- TwinTest (cyclical emission on all available wavelengths for a few seconds on each wavelength),
- CW (continuous emission) The mode used is displayed, above the icon .

Standard Reference: to perform a side by side reference measurement

If the power meter function is selected onto the equipment (either on Base-Unit or on OTDR module) the menu keys are different on screen:

- Source Config: allows to display the Wavelength and Mode menu keys
- The Source Reference menu key allows to open a sub-menu with the following keys:

Standard Ref	To perform a reference in side by side mode (see
Jumper Ref	To perform a reference measurement in loopback mode

Performing the power level measurement

The power meter is started up as soon as the function  is activated in the HOME page.



It is not possible to use simultaneously the Source function and the Powermeter function, when both options are set onto the OTDR module, as they use the same connector.

Power measurement is automatically updated in consequence. The value «<-50 dBm» is displayed when the laser is switched off and if the source output is looped on to the power meter input.

- 1 Connect the light source to be tested to the rear connector
- 2 In the SETUP menu, choose the units dBm or Watts.
- 3 Press the START/STOP key to start the measurement. The result will appear in the results page and can be memorized in the table
- 4 Press the START/STOP key to stop the measurement.

Performing the insertion loss measurement

Using light source and power meter options, an insertion loss measurement can be performed, having previously carried out a reference measurement.

Setting the zero value of the power meter

- 1 Fix the plug over the optical input of the power meter so that no light can reach the photodiode of the power meter. If the zero adjustment is made without this plug, an error message may be displayed, as the photodiode will detect too much light.
- 2 In the Results page, press Powermeter config. > Zero soft key and validate



It is important to set the zero of the power meter before making any measurements where accuracy is required, as the noise from the germanium photodiode fluctuates over time and with variations in temperature.

Carrying out the reference

Using two FiberXpert OTDR 5000 platforms with an OTDR module including a laser source option and a Power meter option, an insertion loss measurement in continuous wave can be performed.

Two types of reference are available: referencing in side by side mode and referencing in loopback mode.

Carrying out the side by side reference

This reference can be carried out when both units are connected together meaning they have to be at the same location.

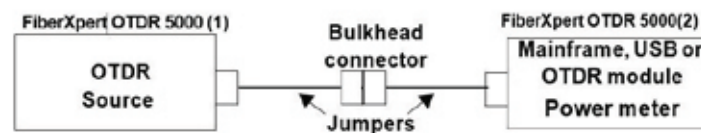

Fig. 54 Side by side reference

1 Before connecting fiber/jumper, use appropriate cleaning tool to clean connector endfaces.

2 Connect the two jumpers together via a bulkhead connector.

3 Set, on equipment (1), the OTDR light source as "Standard Ref"

A Press the HOME key

B Use the arrow keys or touchscreen to select the Source function on Home page .

C Press RESULTS key

D In the Results page, press Source Config.> Source Reference > Standard Ref

E Press Exit and go back to the result Page

F Select the Twintest mode by skipping through the different modes

G Press Laser On key to activate the source

4 Set, on equipment (2), the power meter (from OTDR module, from the Base-unit or from USB) as "Standard Ref"

A Press the HOME key

B	Use the arrow keys or touchscreen to select the Powermeter function in Home page.
C	Press RESULTS key  .
D	In the Results page, press Pow.Reference > Standard Ref. The actual power level is set as the new reference level for the selected wavelength. Then, the displayed value is around 00.00 dB.
E	Press Exit and go back to the Results page. The reference levels are stored into the unit, and have been automatically filled into the setup.

Storing and reloading results

File Setup	Click on the button FILE to access the File setup.
Storing results	<p>In order to save the results of a measurement, click on FILE and select Store trace. Two files are being saved:</p> <ul style="list-style-type: none"> – The first file is to be used with the product and allows to retrieve all measurement results. It is saved with the extension .Lts. – The second file is a ASCII file using tabulations to separate values. It is saved with the extension «.txt» and can be opened by the 4000 Platform via the Web Browser. It has been designed to be used with a spreadsheet program on a PC where it allows to retrieve all measurement results and format them in a nice customized table.
Loading results	<p>In order to load the results of a measurement, select a file with the extension «.Lts» in the file explorer, click on Load > View trace.</p> <p>The LTS tab is displayed with the loaded results in the table.</p>

11-SCOPE

The scope function is a hot-plug feature enabled directly when inserting a Softing IT Networks GmbH microscope supplied as an option:

The topics discussed in this chapter are as follows:

- “Scope feature”
- “Installation of tips”
- “Configuring the Microscope”
- “Starting up with the scope”
- “Launching a test of the connector and fiber end-face”
- “File menu”

Scope feature

<p>Overview</p>	<p>This feature enables you to verify that your optical connectors are in perfect shape and very clean condition.</p>
	<p>The Digital Probe Microscope is a portable handheld microscope used to view and inspect both the bulkhead (female) and patch cord (male) sides of fiber connectors as well as other optical devices, such as transceivers.</p> <p>The microscope requires an inspection tip and is connected to the Unit with a USB 2.0 connector.</p>

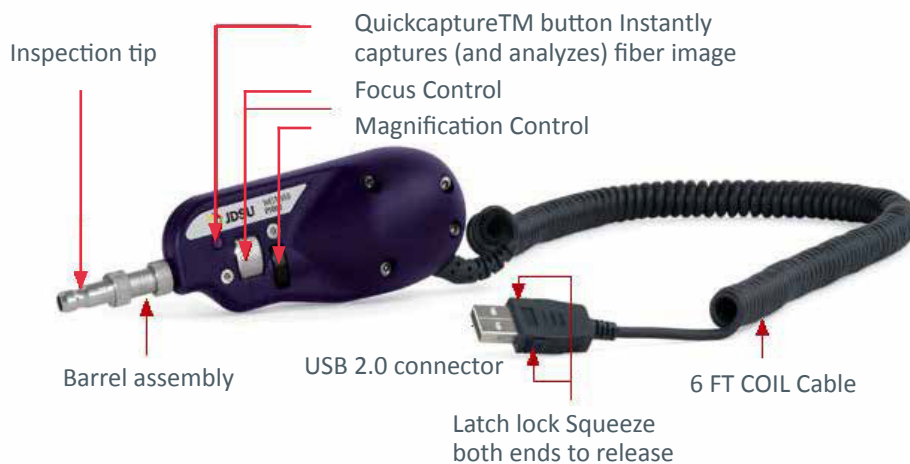

Fig. 55 Probe components

Installation of tips

The Pass/Fail analysis function on the FiberXpert OTDR 5000 can only be used with certain inspection tips mounted on the microscope.

Various tips, patchcords and bulkheads types, are available

Configuring the Microscope

Scope connection

1 Plug in your Softing IT Networks GmbH scope into a USB port of the FiberXpert OTDR 5000.

2 Push the button Home

3 Validate the Scope function .

4 Connect probe with the fiber being inspected.

You may select this option while other options are already selected.

Configuring the Scope

1 Press SETUP key to configure the test.

The following screen displays:

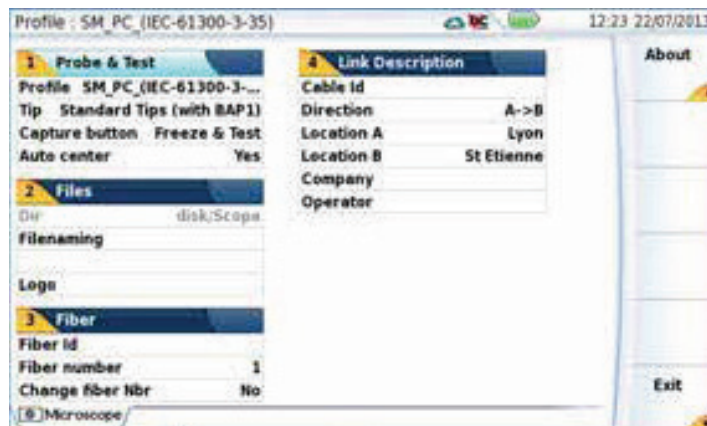

Fig. 56 Scope Setup

Test On the line Profile, select the Profile which will be used for the test of fiber connector:

– SM_UPC: Pass/Fail criteria for single-mode UPC connectors from IEC 61300-3-35 standard.

– SM_APC: Pass/Fail criteria for single-mode APC connectors from IEC 61300-3-35 standard.

– SM_PC: Pass/Fail criteria for single-mode PC connectors from IEC 61300-3-35 standard.

– MM_: Pass/Fail criteria for multimode connectors from IEC 61300-3-35 standard.

	Profiles contain the analysis parameters by which PASS/FAIL criteria are determined.
	Once the line is selected, you can also add a new profile, clicking on the Add Button
Tip	On the line Tip, select the tip set onto the microscope to connect fiber for inspection.
Capture button	This parameter allows to select the action of the Quick Capture button onto the Scope
Freeze & Test	pressing the button will automatically perform a test of fiber and freeze the result
Freeze image	pressing the button onto the Scope will automatically freeze the live image.
Auto Center	This parameter allows to select if the scope image must be centered on screen (select Yes) or not (select No).

File

The File box allows to configure the saving of scope results.

The Dir parameter is displayed in grey, and indicates the directory into which the results will be saved. To change the directory, press FILE hardkey and select another directory from the file Explorer page; then press SETUP hard key to return to Scope Setup page.

On the line Filenaming, use the edition keypad, which will display by clicking on the right arrow key, to enter a specific name for the file. You can enter manually a name and/or use pre-defined parameters (Fiber Id, Cable Id, Locations...).

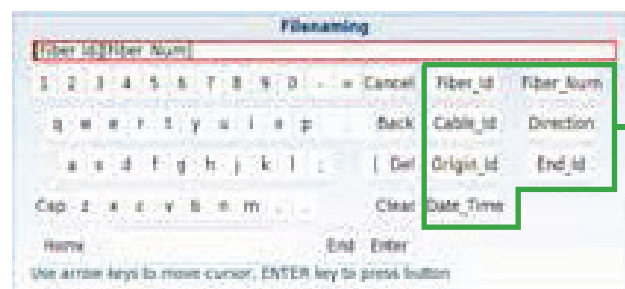

Pre-defined parameters for filenaming

Fig. 57 Edition keypad for filenaming

The line below Filenaming shows the name of the file according to the parameters entered.

In the Logo parameter, click on right arrow key and select in the Explorer a JPG file which will represent the Logo displayed on the upper left part of the report

Fiber

The Fiber box allows to configure the fiber plugged to the scope.

On the line Fiber Id, use the edition keypad, which will display by clicking on the right arrow key, to enter a specific name for the fiber.

On the line Fiber Number, use the numeric keypad, which will display by clicking on the right arrow key, to enter the fiber number.

On the line Change fiber Nbr, select if the fiber number must be modified after each results saving:

No: the fiber number is not modified at each saving

Increment; the fiber number is automatically incremented at each results saving

Decrement: the fiber number is automatically decremented at each results saving.

Link Description

The information entered in the Link Description window concerns the editing and/or the modifications of the cable and fiber parameters.

Cable Id This parameter allows to enter an identification of the cable, using the Edition menu.

Direction The direction shows if the acquisition has been made from the origin to the extremity (A->B) or from the extremity to the origin (B->A). Changing direction makes it possible, when different extremities are handled, to see the parameters of the fiber for the other extremity.

Location A The name of the Location A of the link may be entered.

Location B The name of the Location B of the link may be entered.

Company Enter the name of the company carrying out the test.

Operator Enter the name of the operator carrying out the test.

NOTE

All parameters of the Link Description box will appear in the pdf report or jpg file generated from a test results page.

Press Exit to return to the Results screen of the scope

About page

On the Setup screen, the softkey About, on the right of the screen, allows to display information on scope and current test result displayed

1 Press About softkey to display a page as the following one:



Fig. 58 Microscope: About page



Starting up with the scope

Once the FiberScope icon is validated:

- 1 Press RESULTS hard key

Sharpness level



Fig. 59 Example of the result using the microscope

Use the Focus Control button onto the microscope to adjust the image quality and sharpness.

NOTE

To switch from Scope page to FO results page and vice-versa, press the RESULTS hard key for about 2 seconds (a beep is emitted).

Freeze mode



Once the image is acceptable, you may freeze the picture. This feature allows to store in memory the resulting picture.

Freezing a scope result does not store the picture in a file. The result will be lost if the instrument is shut off, or if more than 3 pictures are frozen

NOTE

The button set on the lead, or the QuickCapture™ on the microscope allows to freeze the picture or to take a snapshot.

High Mag. / Low Mag.

The High Mag./Low Mag. menu key allows to switch the display from High to Low magnification and vice-versa.

This function is also available pressing the button directly on the microscope

Camera mode

If you are in Freeze mode, or in Mosaic mode, with a picture selected (see “Mosaic Mode” on page 59), press Camera menu key to return to live camera picture.

Use the focus control to adjust the focus of the image

Launching a test of the connector and fiber end-face

Once the display is correctly adjusted (magnification, sharpness...), a test of fiber connector can be launched. To launch the test:

1 Press Test key to launch the test of plugged fiber connector.

The test is completed:

– once the LED Testing is no more lit in red

– once the  icon is no more displayed on the upper banner

– once a screen as the following one displays:

NOTE

To configure Pass/Fail criteria, see “Configuring the Scope”

Profile selected in the Setup page

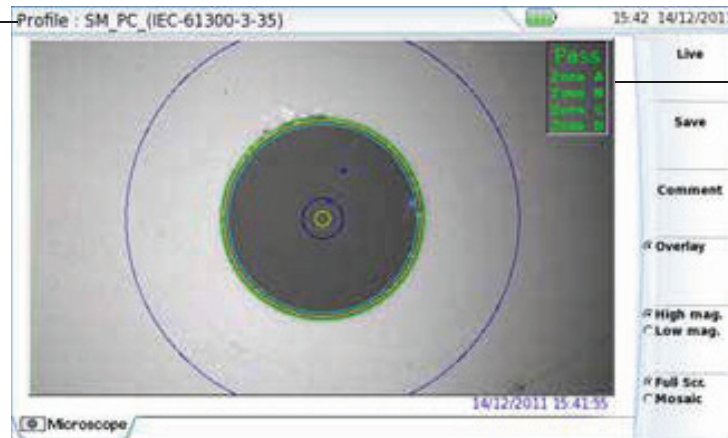

Summary of Test results

Test result in High mag.

Fig. 60 Test results

Once the display is correctly adjusted (magnification, sharpness...), a test of fiber connector can be launched. To launch the test:

A summary of test results is displayed on the right, upper part of the screen.

– Zone A: Core zone: it is the area surrounding the core

– Zone B: Cladding zone. It surrounds the majority of the fiber cladding.

– Zone C: Epoxy ring.

– Zone D: Ferrule/Contact zone: it identifies a portion of the ferrule near and around the fiber

NOTE

To return to a Live Camera image, press the Camera key; or press the Full Screen/ Mosaic key view both the live image and a test result simultaneously.

In Mosaic mode, the result of the test only displays Pass or Fail information; the status of each zone is displayed only in full screen mode.

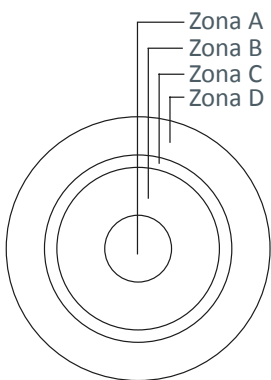

Overlay

The Overlay key allows, when selected, to display the limits of each zone and to display with colors the defaults on the image.

When the key is deselected, the zones and defaults are not graphically identified.

This function is also available in Mosaic Mode.

Mosaic Mode

It is possible to display only one picture in full screen (640 * 390 pixels) or up to four pictures (320*180 pixels each, including the live camera picture) in mosaic mode. Use the key Full scr./Mosaic to switch from one mode to another.

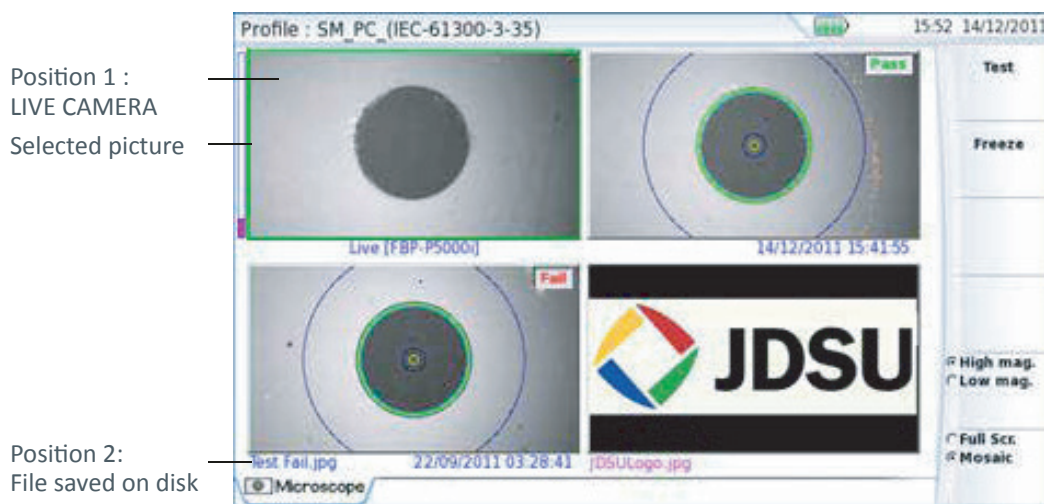

Fig. 61 Mosaic mode

– You may select one of the pictures by clicking on it.

The selected picture is framed in green.

The tool bar on the right varies according to which picture is selected (camera, or static picture):

Mosaic Mode

Test Allows to launch a (new) test of the connector

Freeze The live picture from the camera is frozen but does not replace the live picture at position 1. The new snapshot is placed at the second position, and all existing pictures are pushed to the next position.



If all positions were taken, the picture that was once at the fourth position is unloaded from memory. Frozen pictures and snapshots are lost, unless they were saved on the internal memory.

High mag./
Low mag.

allows to modify the live display from high to low magnification and vice-versa

Picture selected: Image

Comment

allows to add a comment to the selected picture

Save

allows to save the selected picture in the directory Scope, in the disk of the Unit. Press Save key, enter a name for the jpg file and validate. This key is not available with jpg files other than those resulting from scope application.

Overlay

allows to display or hide the limits of each zone and the defaults on image from a test result.

High mag./
Low mag.

allows to switch all the images from scope test results from high to low magnification and vice- versa.

Adding a comment

The key Comment allows you to enter/modify a comment to your picture if necessary. This comment appears at the bottom left of the picture.

The right bottom of the frozen picture also contains the date of the acquisition (where the picture was frozen).

NOTE

Both the comment and the date will be saved with the picture.

Loading a picture

It is possible to retrieve and load a picture stored in the Scope directory and display it in the Scope page.

1 Press the FILE button.

2 Press Explorer.

3 Select the JPEG file to be loaded via the Explorer

4 Click on Load

Recognized pictures are images resulting from the Scope option and saved on disk via the FiberXpert OTDR 5000.



Some pictures resulting from the Scope option may appear nevertheless unrecognized, if they have been stored with a different Scope application, or if the JPG file has been opened and modified under another JPG editor.

Even though the JPG editor of the Scope function has been designed to display Scope pictures in black & white, it is also possible to open any JPG valid file and display in color the corresponding picture. That picture is enlarged or shrunk to the size of the display.



File menu

Saving the test result in a jpg file

Once the test has been performed, and the result is displayed on the FiberXpert OTDR 5000 screen:

- 1 Press FILE key
- 2 Click on Save key to save a jpg file of the test result on the disk of the FiberXpert OTDR 5000.
- 3 On the edition keypad, enter the name of the jpg file
- 4 Press Enter to validate.

The file is automatically saved on the disk, in the directory Scope  (icon).

Generating a report

- 1 Check the correct test result is selected (framed in green in mosaic mode).
- 2 Press the FILE button, then the Report key
- 3 On the edition keypad, enter the name of the pdf file and press ENTER.

The report generation is completed once the icon  is no more displayed on the upper banner.

Display of the report

Once the report has been generated:

- 1 Press FILE hard key.
- 2 On the right menu keys, press Explorer soft key.
- 3 In the File Explorer, select the pdf report just created.
- 4 Press Load.

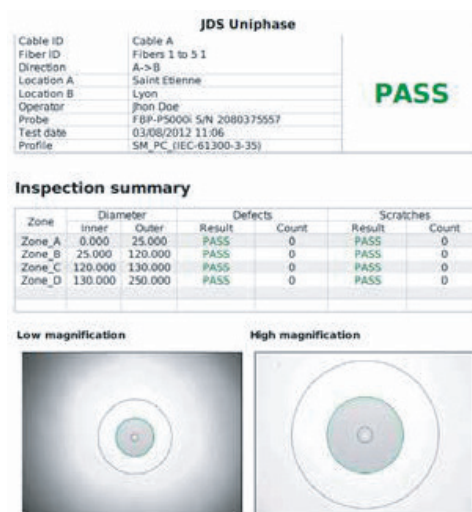

Fig. 62 PDF report of Scope test result

12-TRANSFERRING THE FIBERXPERT OTDR 5000 INTERFACE

The FiberXpert OTDR 5000 can be used in combination with a PC in order to transfer the Unit Interface onto a PC, or to access the internal memory or USB memory stick contents on the PC.

Topics described in this chapter are as follows:

- “Establishing connection”
- “Transferring the Interface”
- “Virtual control buttons bar”
- “Equivalence between the keyboard and FiberXpert OTDR 5000”

Establishing connection

The connection between FiberXpert OTDR 5000 and the PC can be done directly, or via a local network.

The transfer of the interface can be done using a VNC window on PC.



For an intensive use of the depart screen or when it is used via a WAN network, it is strongly recommended to use a dedicated VNC client. The VNC clients recommended are Tight VNC (V 1.2.9 or later) and Real VNC (V 4.1.1 or later).

Connecting the FiberXpert OTDR 5000 and the PC

1 Connect the FiberXpert OTDR 5000 to the PC via an Ethernet cable, using the RJ45 connectors set on both equipments.

2 Check the network connection on the PC is set in Dynamic mode.

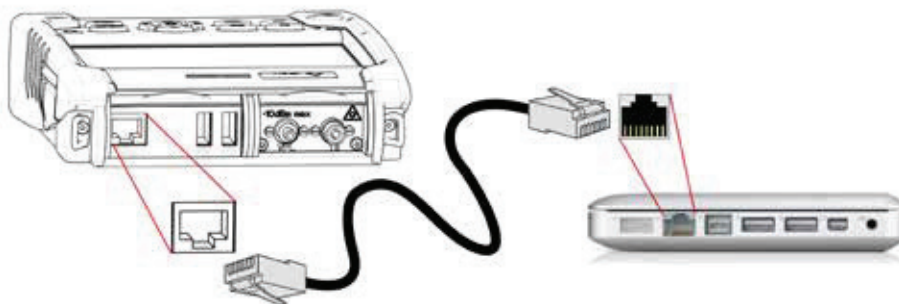

Fig. 63 Connection FiberXpert OTDR 5000 and PC

Picture selected: Image

- 1 In the Home page of the FiberXpert OTDR 5000, validate the Settings icon.
- 2 In the System Settings page, in the I/O Interfaces box, configure the following parameters:

Remote Screen

Remote screen	= Session or Permanent must be confirmed in both cases, in the Interface E/S window.
No	the screen cannot be remote on to a PC or on to another FiberXpert OTDR 5000.
Session Mode	the Remote screen function is inactive once the FiberXpert OTDR 5000 is switched off.
Permanent Mode	the Remote screen function is still active when the FiberXpert OTDR 5000 is switched off and restarted.
Permanent with password	same function as the Permanent mode, with an access to the equipment via VNC protected by a password: 42000
The password to access VNC can be modified:	
1 Click on the menu key Change password.	
2 Enter the current password in the Edition keypad and press Enter to validate.	
3 Enter the new password and press Enter to validate.	

Loading a picture

Parameters of the local Ethernet network to which the FiberXpert OTDR 5000 is connected:	
Config 1 to 4	static mode enabling input of the configuration of 4 sites. If this parameter is selected, the following parameters must be entered:
- Site Name	the user can enter the name of the site in the Edit menu.
- IP Address	IP address of the FiberXpert OTDR 5000
- IP Mask	address of the mask of the sub-network
- IP Gateway	IP address of the machine enabling access outside the sub-network.
- DNS1	IP address of the machine providing the IP address on the basis of the name
- Domain name	name of the local network to which the 2000 Plat- form is connected.
- Dynamic	in this mode, which requires a DHCP server, the FiberXpert OTDR 5000 requests an IP address from this server which will be allocated dynamically if dynamic host configuration is activated on the local network.
After selecting this mode or after power-on, the FiberXpert OTDR 5000 tries to establish a connection to obtain an address from a DHCP server. If for any reason, this process fails, the FiberXpert OTDR 5000 reverses to static IP address mode with User1 IP address.	
1.Domain Name Server	

NOTE

Once the FiberXpert OTDR 5000 is connected to the network, the icon indicates the connection is working.

Proxy > Use proxy

- 1 Select No if no proxy is used.
- 2 If Manual has been selected, enter the Proxy Address.
- 3 If Auto has been selected, enter the Pac Address.



Fig. 64 Example of configuration for I/O Interfaces box

- 4 Note the IP Address displayed in the System Settings page.
- 5 Wait about 10 seconds the connection is established.

The FiberXpert OTDR 5000 Interface can now be transferred onto the PC, or the internal memory or USB key contents can be transferred on PC.

Connecting the FiberXpert OTDR 5000 and the PC



Once the connection is established between the FiberXpert OTDR 5000 and the PC, proceed as follow:

- 1 Open your browser on the PC.
 - 2 Considering 10.33.18.93 is the IP Address of the FiberXpert OTDR 5000, enter the following address in the browser window: <http://10.33.18.93:5800>
 - 3 Press Enter to validate.
- A VNC window opens, demanding a password
- 4 Press OK without typing any password.
- The screen of the FiberXpert OTDR 5000 appears offset on your PC.

Click to install TightVNC software on your PC (not mandatory)

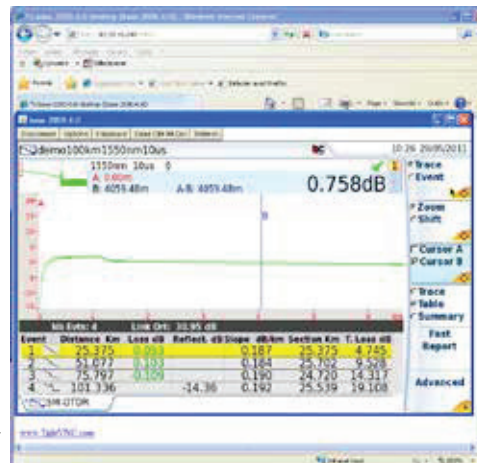



Fig. 65 VNC window

You can use keyboard mouse of the PC to control the FiberXpert OTDR 5000

NOTE

Once Remote screen is accessible via VNC, the  icon displays on the upper banner of the screen until the connection is cut or the FiberXpert OTDR 5000 is switched off.

Virtual control buttons bar

It is possible to emulate hard keys with Virtual Control buttons. This virtual control buttons bar is especially useful when the FiberXpert OTDR 5000 screen is exported on a remote PC.

To display those buttons, click once on the top of the screen in the status bar, at the same height than the date and time.

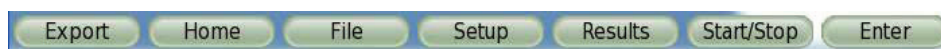

Fig. 66 Virtual control buttons bar

The virtual control buttons bar is displayed during a few seconds. You may click on any of these buttons to obtain exactly the same results than using the hard keys on the front panel of the FiberXpert OTDR 5000.

The FiberXpert OTDR 5000 Interface can now be transferred onto the PC, or the internal memory or USB key contents can be transferred on PC.

Equivalence between the keyboard and FiberXpert OTDR 5000

The PC keyboard can replaced all the buttons and keys of the FiberXpert OTDR 5000 except the ON/OFF button:

- The menu keys to the right of the screen are replaced by the function keys F1 to F6.
- The buttons below the screen are equivalent to Ctrl + a letter (see table below).
- The direction keys have the same function on the external keyboard and on the FiberXpert OTDR 5000.

Function on the FiberXpert OTDR 5000	External keyboard
HOME	Ctrl + H
SYSTEM SETTINGS	F12
SET-UP	Ctrl + U
FILE	Ctrl + F
RESULTS	Ctrl + R
START/STOP	Ctrl + S
EXPORT	Ctrl + Pa
Menu keys 1 to 6 (from top to bottom)	F1-F6
ABOUT	F11
Save and quit (Exit)	Entrée/Enter
Quit without saving (Abort)	Escape/Echap.

a. The Export function is available directly on the FiberXpert OTDR 5000 pushing simultaneously the left and right arrow keys.

NOTE

Those equivalences are also valid with a keyboard directly connected to the FiberXpert OTDR 5000 via one USB port.



13-WEB BROWSER

The FiberXpert OTDR 5000 allows to access to internet, using the Web Browser installed on the equipment.

The topics discussed in this chapter are as follows:

- “Configuring the Web access”
- “Starting the web browser”
- “Creating bookmarks”
- “Opening a PDF document”
- “Leaving the web browser”

Configuring the Web access

Before using the Web Browser on the FiberXpert OTDR 5000, check/modify the proxy configuration in the System Settings page:

1 On the Home page, press Settings key

The System Settings page displays.

2 Select Proxy parameter in the I/O Interfaces box to open a sub- menu.



Fig. 67 Proxy configuration

3 Configure the parameter User Proxy

– If Manual is selected, enter the Proxy Address with edition keypad

– If Auto is selected, enter the Pac Address using the edition keypad.

Starting the web browser

1 In the Home screen, select Web Browser  icon.

The web browser is launched.

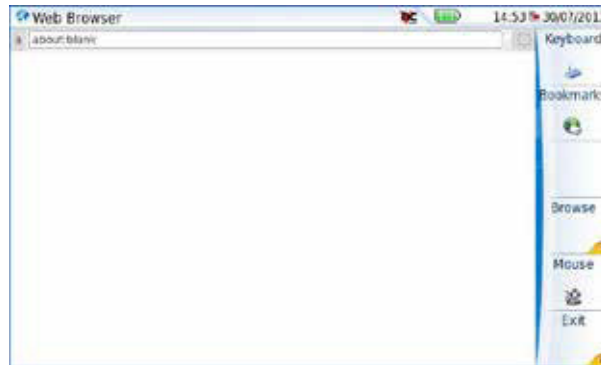

Fig. 68 Web Browser page

Opening an internet page

Once the Web Browser is displayed, you must enter the internet address.

1 Set the cursor in the address bar:

a Use the mouse connected via USB port on the FiberXpert OTDR 5000 or the mouse of the PC if the screen is deported via VNC application on the PC, or use the touchscreen.

b Click on the menu key so that it becomes. This allows to move the cursor toward the address bar.

2 Once the cursor set onto the address bar, enter the address:

a Using a keyboard connected to the FiberXpert OTDR 5000 USB port or the keyboard of the PC with a deport of the screen via VNC, enter the entire address of the site to be opened.

b If none keyboard is available:

– click on the menu key to display the virtual keyboard and enter the address using the buttons on the FiberXpert OTDR 5000 or clicking directly on characters.

3 Push the ENTER hard key.

The page opens

If an error message is displayed in place of the internet page, verify the address you typed, or check the configuration.

Once the Web Browser is open, press the key to display on the right of the screen, the buttons used to navigate.

Navigation into the Web Browser

Icon

Definition

Go to the previous or next page loaded

Refresh the actual page

Exit the Navigation menu

When a link is available, the arrow cursor becomes a hand cursor



Creating bookmarks

Once a page is opened, you can apply it a bookmark, in order to get a shortcut toward this page.

Once the internet page for which a bookmark must be created is opened:

1 Click on  to open the dialog box for bookmarks creation.. A new tools bar is displayed on the right of the screen.

2 Click on menu key  to add a bookmark for the page displayed

3 Click on  to edit the bookmark, and modify if necessary the name of the bookmark.

Click on Ok to confirm the modification or Cancel to cancel the modifications.



Fig. 69 Bookmark edition

– Click on  to open the page of the bookmark selected in the list

– Click on  to delete the selected bookmark from the list

– Click on  to exit bookmark menu and go back to Web Browser.

Opening a PDF document

PDF documents may be opened and read within the Web browser.

1 When you click on a link toward a PDF file, a dialog box during loading is displayed.

2 Once loading is completed, click on Ok to open the pdf file.

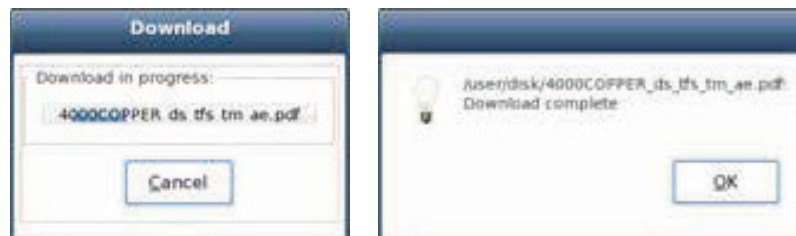

Fig. 70 Downloading a pdf file

Click on the menu key  to go back to the web browser.

NOTE

The web browser will open a PDF document, not a URL including a PDF file.

The PDF is also automatically saved on the disk of the Platform.

Leaving the web browser

Depending on how long you want to leave the web browser and on your connection mode, you may:

– Leave the web browser running and switch to another task. To do this, click on the HOME button.

The web application is still running in the background. Nevertheless, you have now a complete access to all the FiberXpert OTDR 5000 functionalities.

To go back, you must select again the Web Browser in the Home page. The application will reopen much faster, and all your environment will be the same (last current page, possibilities to go back...)

Quit the application using the Web browser application menu: click on the key .

14-FILE MANAGEMENT

The files management with the FiberXpert OTDR 5000 can be performed, whether a module is set onto the FiberXpert OTDR 5000 or not.

The topics discussed in this chapter are as follows:

- “File Explorer Overview”
- “Directories and Files selections”
- “Directories & Files editing functions”
- “Working with directories and files from the explorer”
- “Creating a screenshot”
- “Creating a report”
- “Merging pdf or txt files”
- “Storage media”

File Explorer Overview

To reach the File Explorer page

– On the Home page, select the File Explorer icon.

The File Explorer page appears.

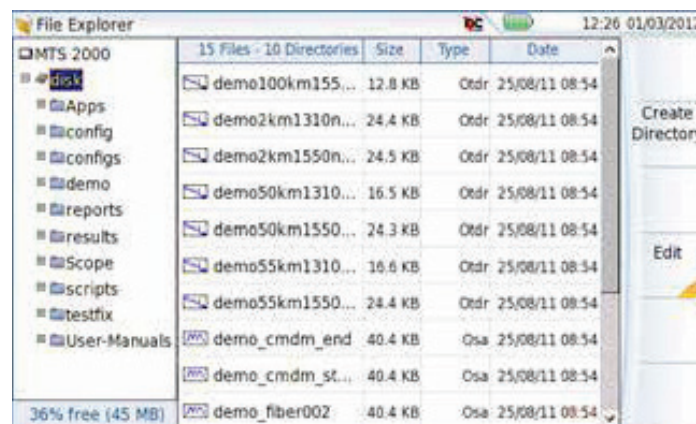

Fig. 71 File Explorer page

Directories and Files selections

Directory selection

To select a directory from the explorer page:

1 Press on the directory that must be selected on the left of the screen.

The list of files the directory contains displays on the right side of the screen

The selected directory is underlined in blue

2 Click on the arrow at the left of the directory name, or press validation hard key, **⊙** to display the sub-directories if any.

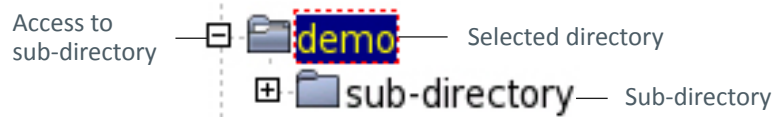

Fig. 68 Directory selection

Files selection

To select one or several files from the explorer page:

1 Press on files that must be selected. or

To select a list of files using the keys of the Unit:

a Select and validate the first file of the list (underlined in red)

b Set the cursor on the last file of the list (underlined in blue)

c Maintain the right direction key pushed until all the files are selected. or

Click on Select all menu key to select all files into the directory.

NOTE

The last selected file is underlined in red and the previous one(s) selected is/are underlined in blue.



Fig. 72 Example of files selection

Directories & Files editing functions

Copy/Cut & Paste files/directories

To copy (cut) one or several files, or one directory, and paste them in another place:

- 1 Select the directory / the file(s).
- 2 Press Edit menu key
- 3 Press Copy to keep the directory / file(s) to their initial location.
or, Press Cut to delete the directory / file(s) from their initial location
- 4 On the left of the screen, select the directory; or select the new storage media.
- 5 Click on Paste menu key.

Renaming a directory / file

- 1 Select the directory / file to be renamed
 - 2 Press Edit > Rename Directory or Rename File.
- The Edition keypad displays.
- The selected directory is underlined in blue

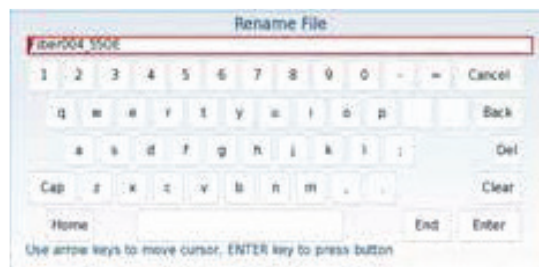

Fig. 73 Edition keypad for renaming file

- 3 Press Clear if you wish to delete the entire name
- 4 Enter a new name for the directory / file.
- 5 Click on Enter to validate the new name.

Deleting a directory / file

- 1 Select the directory or file(s) to be deleted
 - 2 Press Edit > Delete.
- A confirmation dialog box displays.
- 3 Press Yes to delete the selected directory or file(s).
Press No to cancel the deletion.

Working with directories and files from the explorer

Creating a directory

To create a new directory from the explorer page:

- 1 Check the cursor is set on the left of the screen
- 2 Select the storage media into which the directory must be created

3 If you want to create a sub-directory, select the directory into which it must be created.

4 Press the right menu key Create Directory.

The edition keypad displays

5 Enter a name for this directory

6 Press Enter key to validate the new directory

Opening files



Once a file is selected, press Load menu key.

Opening several files at the same time can be done exclusively with trace files (example: all OTDR trace files if a reference trace has been defined). Other type of files (PDF, TXT...) must be open one by one.

If different types of files have been selected in the Explorer, only the last one selected will open.

File Types

For files recognized by the FiberXpert OTDR 5000, the types are symbolized by icons. E.g.

Icon	Type of FO file
	OTDR file (.SOR extension)
	Multi OTDR file (.MSOR extension)
	Power Meter file (.LTS extension)
Icon	Type of file
	HTML file (.HTML extension)
	PDF File (.PDF extension)
	Text file (.TXT extension)
	License file (.LIC extension)
	CSV file (.CSV extension)
	JPEG / JPG file (.JPEG extension)
	PNG file (.PNG extension)
	XML file (.XML extension)



With the FiberXpert OTDR 5000, you can open and load any kind of FO files (OTDR, LTS) even if the corresponding module is not set into the Unit.



Sorting files

Whether files are selected or not, the key Sort allows to access to a sub-menu allowing to sort the file according to pre-defined parameters:

– Sort by name: the files display in an ascending order (from A to Z).

If you click once again on the key, the files display in a descending order (from Z to A).

– Sort by size: by clicking once on this key, the files display from the smallest to the heaviest one. Clicking a second time allows to sort the files in opposite order.

– Sort by type: clicking once on this key; the FiberXpert OTDR 5000 displays files in an ascending order (the file type A to file type W). By clicking again, the FiberXpert OTDR 5000 displays the files in opposite order.

– Sort by date: clicking once on this key; the FiberXpert OTDR 5000 displays files from the more recent to the less one. By clicking again on key, the Unit displays files from the older to the more recent one.

NOTE

You can also sort files clicking on the column titles in the files list

Transferring files between two Units

If some Results traces or other kinds of file need to be transferred to another Unit, or if files from another Unit must be transferred to the FiberXpert OTDR 5000, this can be easily done using a USB cable.

Establishing connection between two Units

1 Connect the FiberXpert OTDR 5000 to another one, plugging the USB cable on the mini USB port of the Unit toward a USB port on the other Unit

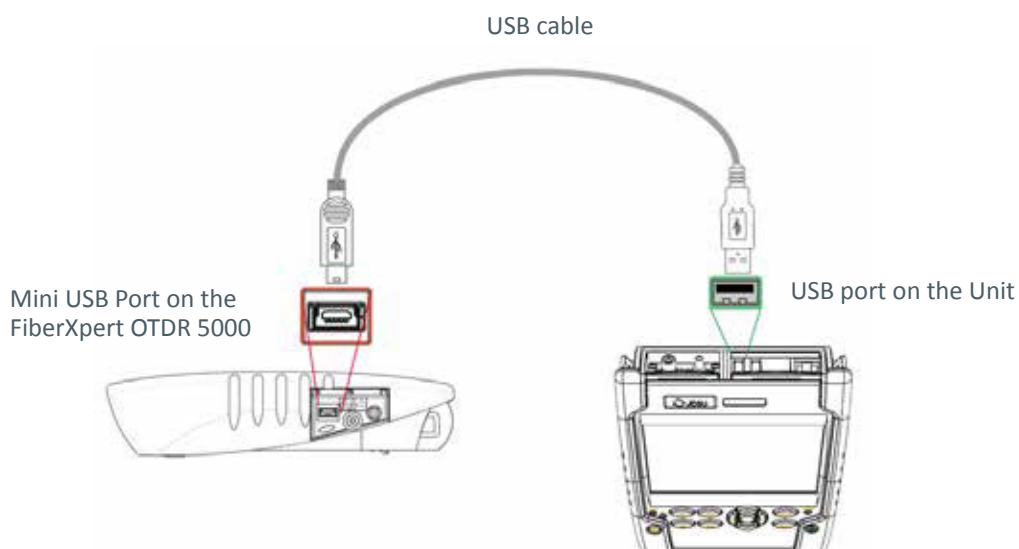

Fig. 74 Direct connection FiberXpert OTDR 5000 <-> FiberXpert OTDR 5000

2 Once connection is established, confirm that you wish to activate the USB link in the popup window on the FiberXpert OTDR 5000.

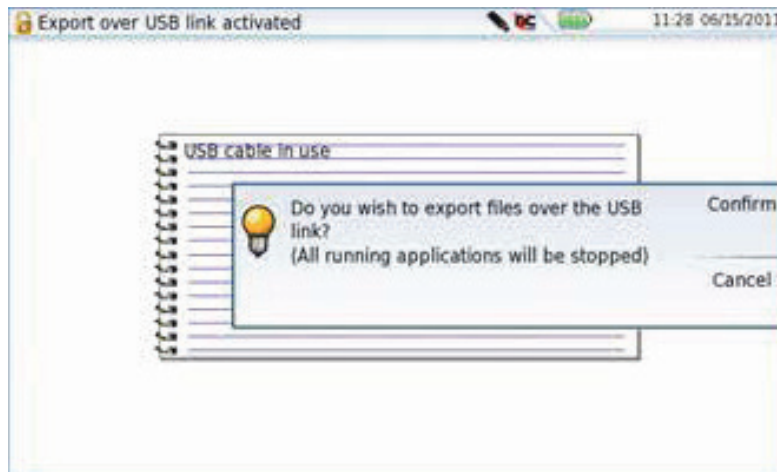

Fig. 75 Confirmation of files export via USB cable

Transferring files

- 1 On the distant Unit, open the File Explorer page
The usbflash driver appears on the left side of the screen.
- 2 Select the file(s) to be transferred from one Unit.
- 3 Press Edit > Copy or Cut softkeys.
- 4 Select on the left of the screen, the directory on the other Unit, into which file(s) must be transferred.
- 5 Press Paste softkey.
File(s) is/are transferred.

Cancelling the connection

Once all desired files have been transferred, connection between both FiberXpert OTDR 5000s can be removed:

- 1 On the distant Unit, press Eject USB key before removing USB plug from connector.
- 2 On the FiberXpert OTDR 5000, remove the mini USB plug from its connector.

The screen displays the results trace of the active function, or returns to the Home page if no function is active.

Transferring files to a PC with the USB cable

If some Results traces or other kinds of file need to be transferred to the PC, this can be easily done using a USB cable.

Establishing connection 2000

1 Connect the FiberXpert OTDR 5000 to a PC, plugging the USB cable on the mini USB port of the Unit toward a USB port on the PC.

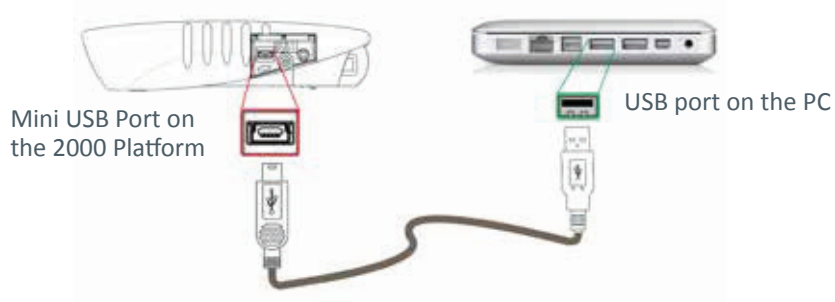

Fig. 76 Direct connection FiberXpert OTDR 5000 <-> PC

2 Once connection is established, confirm that you wish to activate the USB link in the popup window on the FiberXpert OTDR 5000.

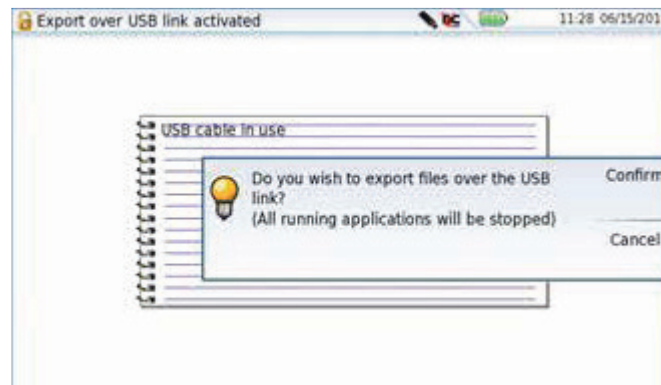
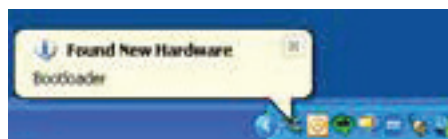

Fig. 77 Confirmation of files export via USB cable

A message displays on the bottom right side of the PC informing a new hardware is detected.



3 Click on the message and select «Open folder to view files» in the dialog box Softing IT Networks GmbH DISK (F:) («F:» is an example, it can be different according to your PC and to the USB port used).



Fig. 78 Open FiberXpert OTDR 5000 disk content

The FiberXpert OTDR 5000 disk content opens onto the PC.

Transferring files onto the PC

1 Select the file(s) from the FiberXpert OTDR 5000 to be transferred onto the PC

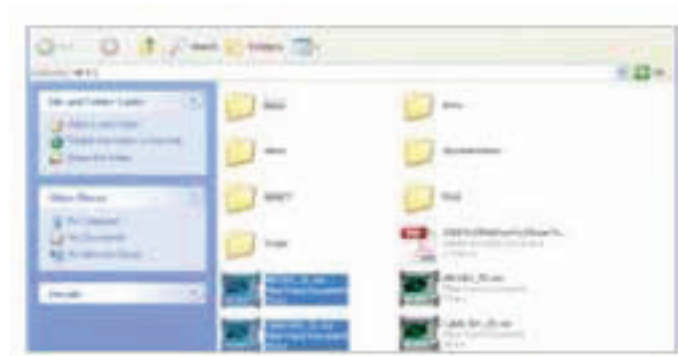

Fig. 79 Files selection from the FiberXpert OTDR 5000

2 Press Ctrl + C, or right click and select Copy.

3 On the PC, select the directory in which file(s) will be transferred.

4 Press Ctrl + V, or right click and select Paste.

Cancelling the connection

Once all desired files have been transferred onto the PC, connection between FiberXpert OTDR 5000 and PC can be removed:

1 On the PC, use the appropriate method to safely remove the USB cable from the USB port.

The screen displays the results trace of the active function, or returns to the Home page if no function is active.

2 Remove the mini USB plug from the FiberXpert OTDR 5000 USB port.

Transferring files to/from a PC with a FTP server

It is possible, from a PC, to access the internal memory of the FiberXpert OTDR 5000 or to the USB memory stick connected to the Unit by means of the FTP server of the FiberXpert OTDR 5000.

Direct connection

1 Connect directly the FiberXpert OTDR 5000 Unit to the PC with an Ethernet cable, using the RJ45 connectors on each equipment.

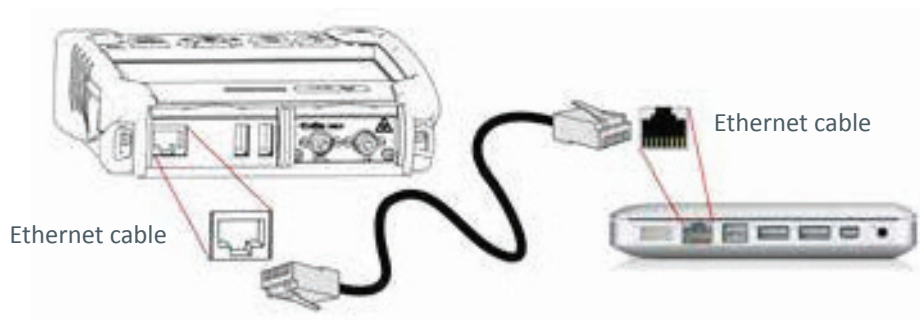

Fig. 80 Ethernet Connection FiberXpert OTDR 5000 <-> PC

Direct connection

2 Make sure the network configuration onto the PC is set to the Dynamic mode:

a Click on Start > Control Panel.

b Double click on Network Connection.

c Double click on Local Area Connection.

d In the dialog box, click on Properties.

e Check the parameter Internet Protocol (TCP/IP) is selected () and click once on it (underlined in blue)

f Click on Properties button.

g On the tab General, check the parameter Obtain an IP address automatically is selected (); if not, click to select it.

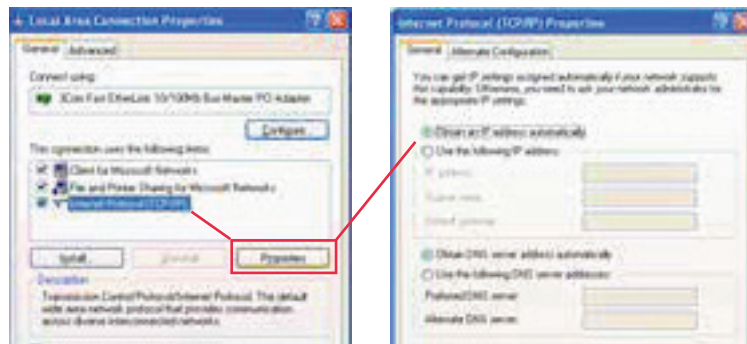

Fig. 81 Internet Protocol

h Click on Ok and close all the dialog boxes opened onto the PC.

3 On the FiberXpert OTDR 5000 Unit, in the System Setup page, under I/O interface > Ethernet, select Dynamic.

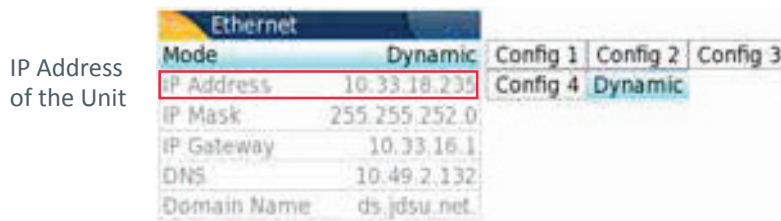

Fig. 82 System Setup > Ethernet: Dynamic mode

4 Note the IP Address and wait for about ten seconds while the connection is established.

Connection via a local network

1 On the PC

– find the IP address and the mask of the PC's sub- network

– With Windows NT, 2000, XP, Vista or 8: select Start > Programs > Accessories > Dos Prompt, type ipconfig", then Enter.

NOTE

the IP address and the mask of the PC's sub-network.

2 Plug the RJ 45 connector of the FiberXpert OTDR 5000 into a hub or Ethernet switch with a straight-through Ethernet cable

3 On the FiberXpert OTDR 5000:

In the system set-up menu, under I/O interfaces > Ethernet, select Config 1 (or 2 / 3 / 4) on the line Mode, then enter the IP address, the IP mask of the PC and the IP gateway previously noted (step 1). or



use Dynamic attribution mode (DHCP). In this case, the address of the FiberXpert OTDR 5000(10.33.18.235 in the example) is displayed but cannot be altered.

4 Wait for about ten seconds while the connection is established.

5 On the PC, make sure that the connection is operational by selecting Start > Execute... and typing ping followed by the address of the FiberXpert OTDR 5000.

Accessing the internal memory of the FiberXpert OTDR 5000

FTP access is obtained through the user account «fiberxpert5000» (password: PSIBER).

1 Make the FiberXpert OTDR 5000 / PC connection as described

2 On the PC, use an FTP client, and access to internal memory via an internet explorer (I.E, Mozilla Firefox...) or Windows Explorer.

3 In the address bar, type the following address (10.33.18.235, being the IP address of the FiberXpert OTDR 5000 defined when the connection was configured):

ftp://fiberxpert5000:PSIBER@10.33.18.235/disk/ This allows to access to internal memory.

ftp://fiberxpert5000:PSIBER@10.33.18.235/usbflash/ This allows to access to the contents of the USB memory stick

connected to the FiberXpert OTDR 5000.

The PC then displays the contents of the internal memory or of the

USB memory stick from the FiberXpert OTDR 5000.

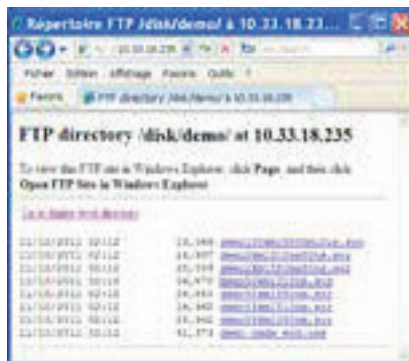

Internal memory open via Internet Explorer

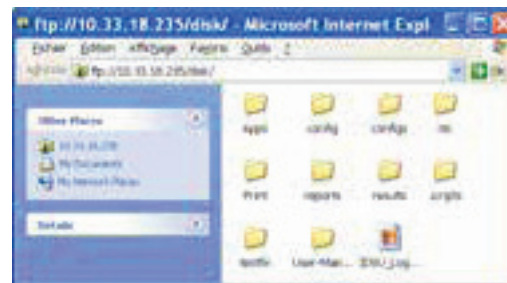

Internal memory open via Windows Explorer

Fig. 83 Internal memory of the FiberXpert OTDR 5000

4 If internal memory of the Unit is accessible via Internet Explorer (or any other explorer), right click on one file and click on Save target as... to transfer file onto the PC.

If internal memory of the Unit is accessible via Windows Explorer, select one / several files and click on Copy, then click on Paste on PC to transfer file.

Creating a screenshot

You can create captures of what is displayed on the screen, directly from the FiberXpertOTDR 5000.

Configuring the parameters of screenshots

To configure the screenshot and choose the format of the generated file:

- 1 Press HOME hard key
- 2 Select the Settings icon to reach the System Settings page.
- 3 In the Report box, on the line Mode, select Screenshot

Choosing this option, you can save the displayed screen in JPG, PNG or PDF format, exactly as it is displayed on the screen.

Therefore, if you make a zoom on the trace for example, the file will only show the zoom section.

- 4 On the line File format, select if the printed file will be a JPG, PNG or PDF file.

Taking a screenshot

Once the screenshot parameters are configured:

- 1 Reach the display which will be saved as a screenshot in a file.
- 2 If necessary, make modifications on this display (example: zoom on trace...)
- 3 Press simultaneously the left and right arrow keys ◀▶ for about 5 seconds or Click on the upper banner of the screen and, in the virtual control buttons bar, press Export key

The icon  displays until the end of process.

- 4 Press the FILE key to find the JPG, PNG or PDF file in the Explorer

Name of the screenshots files

The screenshot is saved in a file, which is automatically named as follow:

- Print_date (year/month/day)_time (hour/minute/second).jpg/png/pdf



Fig. 84 Example of screenshot, open in the Web Browser of the FiberXpert OTDR 5000

Creating a report

Once the results page of a function is opened (example: OTDR trace, Power Meter results...), it can be exported in a report, using the FiberXpert OTDR 5000 Unit.

Configuring the report

To configure the report and choose the format of the report file:

1 Press HOME hard key

2 Select Settings icon to reach the System Settings page.

3 In the Report box, on the line Mode, select Report.

Choosing this option, you can save the open file in a JPG, PNG or PDF file report, exactly as if the file was printed on paper.

Therefore, if the file is too large for one A4 page, several JPG, PNG or PDF files will be created.

4 On the line File format, select if the report file will be a JPG, PNG or PDF file.

5 To display a Logo on the upper right of the report pages, click on Logo line and select the Logo to be displayed on the upper right of the page:

a Press to open the edition keypad

b Enter the path of the logo file with its extension (example: disk/Softing IT Networks GmbH logo.jpg)

c Press Enter to validate.

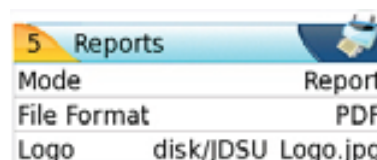

Fig. 85 Example of Report configuration

Creating the report

1 Open the file to be saved in a report in JPG, PNG or PDF format

2 If necessary, make the modifications on the file/trace (see user manual part of the OTDR Modules for OTDR trace files).

3 Set the trace view as wished.

For OTDR traces

– if the function is set to the Trace mode (Trace is selected on the menu key Trace/ Table/ Summary), the JPG/PNG/PDF file will contain the header and the trace (in one page).

– If the function is set to Table mode (Table is selected on the menu key Trace/Table/ Summary), the JPG/PNG/PDF file will contain the header, the trace and the entire results table (several pages may be required)

– If the function is set to Summary mode (Summary is selected on the menu key Trace/ Table/Summary), the JPG/PNG/PDF file will contain the header and the summary page, with either the Bend table or the Alarm Table according to the selected item with the menu key.

This view is only available with OTDR traces.

4 Press simultaneously the left and right arrow keys ◀▶ for about

5 seconds or Click on the upper banner of the screen and, in the virtual control buttons bar, press Export key

The icon  displays until the end of process.

5 Press the FILE key to find the JPG, PNG or PDF file in the Explorer

The files are saved in the directory Print, on the disk media storage.

Name of the report

If a trace has been saved in a report file, the name of the JPG/PNG/PDF file is as follow:

– Name of the stored trace_date (year/month/day)_time (hour/minute/ second).jpg/ png/pdf

NOTE

If several traces are displayed in overlay, a different report file is generated for each trace open.



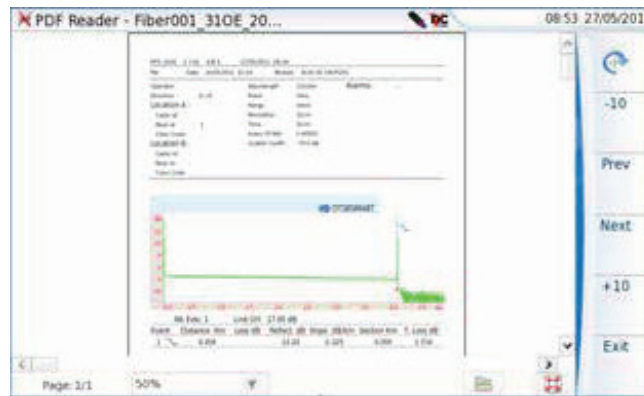

Fig. 86 Example of report (in pdf)

Merging pdf or txt files

In the Explorer page, two pdf/txt files or more, generated via the results traces can be merged in one pdf file.

– The pdf files that can be merged are those generated via the Fast Report key on trace results page or via the Export key on the upper banner (or left and right arrow keys)

– The txt files that can be merged are those saved with the results trace (see OTDR Modules User Manual Part).

1 In the Explorer, select the two or more pdf/txt files generated

2 Press Export menu key

3 Press Merge key

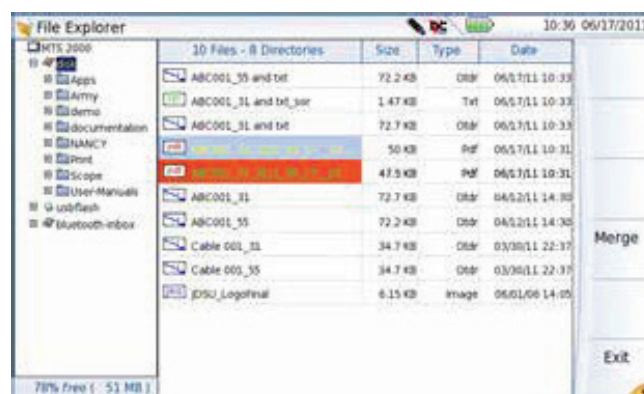

Fig. 87 Files selection and Merge key

The icon  is displayed during merging process.

After a few seconds, the files are merged in one pdf/txt file, which name by default is: merged_year_month_date hour_min_sec.pdf

The file is automatically saved in the same directory as the one where files have been selected.

It gathers all results from pdf/txt files selected (and traces for pdf file), in one single pdf file of several pages (1 results screen per page, if the results table does not exceed one page).

NOTE Once merged file is saved, it can be renamed in the Explorer

Storage media

For saving or recalling data, the FiberXpert OTDR 5000 offers a wide choice of media, both built-in and external.

Free space on selected media is clearly displayed at the bottom of the left panel.

Storage media built into the FiberXpert OTDR 5000

The FiberXpert OTDR 5000 is delivered with an internal memory, which maximum capacity is of 1GB (with a minimum of about 128 Mb are available for data storage).

Storage media built into the FiberXpert OTDR 5000

The FiberXpert OTDR 5000 is equipped with 2 USB ports as standard. One of these can be used to connect an external storage medium, in particular a USB memory stick.

NOTE

Although two USB ports are present, it is not possible to use simultaneously more than one external USB storage medium.

USB memory stick connection

1 Insert the USB memory stick in one of the FiberXpert OTDR 5000's USB port.

A sound is emitted to confirm the successful insertion and recognition of a USB memory stick.

Then, the icon  is displayed in the upper banner to inform the user the USB stick is ready to be used.



When a file is moved in the explorer of the Unit, the end of the move on the screen does not mean that writing of data into the memory is complete. Some data may still be in a writing process if the storage unit is removed prematurely.

USB memory stick connection

1 Before disconnecting the USB memory stick, always select a storage device different from usbflash (select disk for example) in the explorer.

2 Make sure you no longer have any running applications using the usbflash storage media.

3 The user must push the EJECT USB key, available in File Explorer.

The icon becomes  to indicate it can be removed safely. In this state, the USB stick cannot be used anymore

The USB memory stick can then be disconnected from the Unit's USB port.

NOTE

The USB memory stick can also be removed using the Expert Tools

> Media Utilities menu, accessible via the System Settings page.

See "Maintenance and Troubleshooting" if any problem occurs with the USB memory stick

Cloud Storage

Principle and prerequisites of the Cloud Storage

The Cloud storage defined the outsourcing of data on distant servers, which avoid the data storage on a local workstation.

The cloud storage onto a FiberXpert OTDR 5000 allows to transfer the files from the Platform toward a distant server and vice-versa.

Before configuring the Cloud Storage on Platform, you must first create an account on a Cloud Platform on internet.

The Cloud storage function onto the FiberXpert OTDR 5000 works exclusively with sites using the WebDav technology such as CloudSafe (<https://secure.cloudsafe.com/pages/index.html>) or Box (<https://www.box.com/pricing/>).

Once account is created, with WevDav configuration, you get the following information for connection:

- URL
- Login Name
- Login Password

Configuring and connecting to Cloud Storage

Configuring the FiberXpert OTDR 5000



Once an account has been created on the Cloud site, configure the FiberXpert 5000 Unit before establishing the connection:

Before configuring the Cloud Storage, make sure the configuration for Ethernet parameters and Proxy parameters are correctly configured.

- 1 On the Home page, press Settings to reach the System Settings page
- 2 In the I/O Interfaces windows, press Cloud Storage parameter
- A new menu opens
- 3 In the Url parameter, enter the URL define for the Cloud server created on internet
- 4 In the User parameter, enter your Login created on your account
- 5 In the Key / Password, enter the password attributed by the Cloud server.



Configuration on Cloud server
(example with CloudSafe)

Configuration on FiberXpert
OTDR 5000

Fig. 88 Example of configuration

Connecting Cloud Storage

Once configuration has been established on the FiberXpert OTDR 5000, it is ready to be connected with Cloud server:

Select one parameter of the Cloud Storage window on FiberXpert OTDR 5000

1 Press Connect Cloud Storage menu key .



The connection launches



2 Once connection is established, a message displays in the window

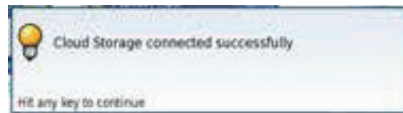

3 Press any key to continue, and start files transfer.

The icon  is displayed on the upper banner as long as the connection is active.

Disconnecting from Cloud storage

To disconnect the FiberXpert OTDR 5000 from Cloud storage:

1 Press HOME hard key.

2 Select a parameter of the Cloud Storage window.

3 Press Disconnect Cloud Storage menu key.



Transferring files using Cloud Storage

Once connection between FiberXpert OTDR 5000 and cloud storage server is successfully established, the files can be transferred from one Unit to the other.

1 Press HOME hard key.

2 Press FILE Explorer on the Home page

In the Explorer page, a new storage media is available: cloud- storage.



The cloud-storage media is not available when File Explorer is from a FO application.

3 Transfer the files from the disk or USB memory stick of the FiberXpert OTDR 5000 Unit toward the cloud storage or vice-versa:

a Select the file(s) to be transferred

b Press the Edit > Copy or Cut menu keys

c Select the storage media (and the directory) into which files must be copied.

d Press Paste menu key

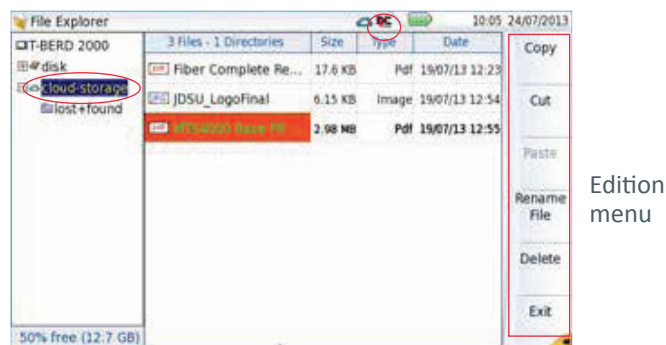

Fig. 89 File Explorer with cloud storage

e Press Paste menu key



The cloud storage is automatically disconnected once the Unit is switched off. Reconnect from the System Settings page of the FiberXpert OTDR 5000 after the Unit restart.

Abbreviations for storage media

Abbreviation	Storage medium
disk	Internal flash memory
usbflash	USB memory stick

15-TECHNICAL SPECIFICATIONS

This chapter contains the technical specifications of the FiberXpert OTDR 5000 mainframe.

The topics discussed in this chapter are as follows:

- “OTDR modules on FiberXpert OTDR 5000
- “Technical specifications of the Power meter function on module”
- “Technical specifications of the Source function on module
- “Display specifications”
- “Memory”
- “Input/Output”
- “Power supply”
- “Dimensions - Weight”
- “Environment”

OTDR modules on FiberXpert OTDR 5000

Characteristics of reflectometry measurements

Distance measurement

– Dual cursor

– Distance displayed takes into account the calibration of the refractive index of the fiber.

– Index adjustable from 1,30000 to 1,70000 in steps of 0,00001

– Resolution of display: 1 cm max.

– Resolution of cursor: 1 cm max.

– Spacing of measurement points: from 4 cm, with up to 256 000 acquisition points.

– Accuracy: $\pm 1\text{m} \pm \text{sampling resolution} \pm 10\text{-}5 \times \text{distance}$ (excluding errors of calibration of refractive index of the fiber).

– Display span: 3.25 m to 260 km

Attenuation measurement

– Dual cursor

– Resolution of display: 0,001 dB

– Resolution of cursor: 0,001 dB

– Linearity: $\pm 0.03 \text{ dB/dB}$ with QUAD/MM Modules

– Display span: 1.25 dB to 55 dB

Reflectance Measurement

– Resolution of display: 0,01 dB

– Accuracy: $\pm 2 \text{ dB}$

- Automatic measurement of all the elements of the signal. Slope measurement by least squares or 2 points of measurement.
- Display threshold of faults:
 - 0 to 5.99 dB in steps of 0.01 dB for event thresholds
 - -11 to -99 dB in steps of 1 dB for the reflectance
 - 0.01 to 5.99 dB in steps of 0.01 dB for attenuation
- Display of slope and attenuation for a segment of fiber.
- Display of the position of a fault and of attenuation.
- Display of the reflectance of the fault.
- Display of ORL

Manual Measurement

- Measurement of slope between the cursors.
- Measurement of attenuation between two segments of fiber.
- Measurement of reflectance of a reflecting element.
- Measurement of ORL between the two cursors.
- Measurement of splice by 2 or 5 points method

Typical specifications

Typical values, measured at 25°C unless specified.

Multimode / Singlemode OTDR Module

Central Wavelength ^a	850 / 1300 nm ± 30 nm
Typical RMS Dynamic Range ^b	26 / 24 dB
Distance Range	Up to 80 km
Pulse width	3 ns to 1 μs
Event Dead Zone ^c	0.8 m
Attenuation Dead Zoned	4 m

a. Laser in CW mode, at 25° C

b. Typical value corresponding to the difference (in dB) between the level of back-diffusion extrapolated at the beginning of the fiber and the RMS noise level, after 3 minutes of averaging, with the largest pulse width.

c. EDZ measured at +/- 1.5 dB below the peak of a non-saturated reflecting event at shortest pulse width.

d. ADZ measured at +/- 0.5 dB on the basis of a linear regression using a -40 dB type reflectance, at shortest pulse width.

e. ADZ measured at +/- 0.5 dB on the basis of a linear regression from a reflectance of type FC/UPC (-55 dB) at shortest pulse width, at 1310 nm.

Ranges for Multimode Modules

	3 ns	10 ns	30 ns	100 ns	300 ns	1 μs
0.5 km	x	x				
1 km	x	x	x			
2 km	x	x	x	x		
5 km	x	x	x	x	x	
10 km	x	x	x	x	x	x
20 km	x	x	x	x	x	x
40 km	x	x		x	x	x
80 km	x			x	x	x

Class of the lasers of the OTDR modules

Module Standard	EN 60825-1, Ed 1.2, 2001 -08	FDA21CFR§1040.10
Singlemode LA, MA & MAE OTDR Modules	Class1	Class 1
Singlemode MP OTDR Module	Class 1M @ 1310 nm, Class 1 @ 1490, 1550, 1625 & 1650 nm	Class 1
Multimode OTDR Modules	Class 1M @ 850 nm, Class 1 @ 1300 nm	Class 1

OTDR modules measurement

Weight: approx. 300 g (0,66 lbs) (400g for the QUAD OTDR Module)

Dimensions (in mm) - w x h x d: 128 x 134 x 41

Technical specifications of the Power meter function on module

Specifications given for 25°C, after 20 minutes stabilization time and after zero setting.

Power meter option for Multi/Single mode Modules



Single / Multi mode	Singlemode Power meter	Multimode Power meter
Measurement Wavelength	1310 / 1490 / 1550 / 1625 / 1650 nm	850 and 1300 nm
Calibrated Wavelength	1310 / 1490 / 1550 / 1625 / 1650 nm	850 and 1300 nm
Input power range	- 50 to - 2 dBm	- 30 to -3 dBm
Maximum resolution		0.01 dB / 0.01nW
Linearity within the specification range	± 0.5 dB (- 45 to - 5 dBm)	

a Using a mode conditioner

Technical specifications of the Source function on module

- Laser Class 1
- Wavelength lasers at 25°C, depending on the wavelengths available in the module:
 - 850 ± 20 nm
 - 1300 ± 30 nm
 - 1310 ± 20 nm
 - 1490 ± 20 nm
 - 1550 ± 20 nm
 - 1625 ± 20 nm
 - 1650 ± 20 nm
- The wavelengths available for the source are the same as those available for the OTDR module.
- Spectral bandwidth: 5 nm RMS typical

Output level

- - 3.5 dBm typical for continuous signal (CW)
- modulated mean level: - 6.5 dBm typical

Emission mode

- Continuous signal (CW), not available for the 1650 nm wavelength on the MP OTDR Module.
- Signal including lambda information for the power meter (Auto).
- Modulated signal to identify the fiber (at 270 Hz/330 Hz/1kHz/2kHz).
- Wavelengths activated one after the other (TwinTest mode).

Display specifications

Screen	– Backlight high visibility color touchscreen
	– Size: 5 inches
	– Resolution: 800 x 480 pixels

Memory

– Standard memory: internal memory, with a capacity of 1GB (with a minimum of about 125 Mb are available for data storage).

Input/Output

- two USB 2.0 host ports.
- one Mini USB 2.0 device
- one RJ 45 connector for Ethernet interface 10/100/1G
- built-in loudspeaker + headset jack

Power supply

Battery The instrument can be supplied with one Li-Polymer battery.

Endurance of the FiberXpert OTDR 5000 with battery

Measurement conditions:

- at +25 °C,
- at full battery capacity (4.5 Ah),
- FiberXpert OTDR 5000 equipped with one OTDR module

Standard Mains Adapter

Input	100-240 V, 50-60 Hz
Output	12V DC 2.5 A max
Compliance	EN 60950

Endurance

Conditions of use	Li-Polymer battery
According to Telcordia GR-196-CORE recommendation: Normal conditions, with normal backlight, 3 acquisition of 30 seconds per quarter of hour, auto off	up to 8 hours
Under continuous acquisition, with high screen backlight:	Up to 3h
- with an OTDR QUAD Module	Up to 3h45
- with an OTDR LM Module	



Mains adapters

Supply or Power assigned in AC and in DC: 25 W

Dimensions - Weight

	Weight	
FiberXpert OTDR 5000 without options, battery nor module	692 g	1.52 lbs
FiberXpert OTDR 5000 with a Li-Polymer battery and one OTDR LM Module	1.21kg	2.67 lbs
Li-Polymer battery	172 g	0.37 lbs
VFL/PWM option	30 g	0.066 lbs

	Dimensions (mm) (H X W X D) Bumpers included	Dimensions (mm) (H X W X D) W/o bumpers
Without module	175 x 138 x 41	169 x 134 x 39
With 1 module	175 x 138 x 80	169 x 134 x 72

Environment

– Operating temperature range	-20°C to +50°C (-4°F to +122°F)
– Operation including all options (guaranteed specifications)	0° to +40°C (+32°F to +104°F)
– Storage	-20°C to +60°C (-4°F to +140°F)

Environment

– 5 to 95% without condensation

EMI/ESD

- CE class B Compliant (EN61326-1)
- FCC 47-1 Part 15 Compliant

Drop test

In accordance with the Telcordia GR-196-CORE recommendations, the FiberXpert OTDR 5000 resists the following test:

- 6 impacts dropped from a height of 1m on a pinwood floor of 5 cm thickness (1 impact on each of its 6 sides, with power off).

Shocks

The FiberXpert OTDR 5000 resists the following test:

- 3 shocks per axis along each of the 3 axes, with power off.
- Impacts of 15g, 1/2 sine, duration 11 ms, at 10 second intervals.

Bumps

The FiberXpert OTDR 5000 resists the following test:

- 1,000 bumps per axis along each of the 3 axes, with power off.
- Jolts of 15g, 1/2 sine, duration 6 ms, at 1 second intervals.

Vibration

The FiberXpert OTDR 5000 resists the following vibration tests:

- Complete test comprising 6 cycles along each of the x, y and z axes.
- One cycle of 5 to 200 Hz and back to 5 Hz with a sweep duration of one minute/octave.
- 3 mm amplitude displacement test, for the range 5 Hz to 15 Hz.
- 3g acceleration test for the range 16 Hz to 200 Hz.

Flammability

The FiberXpert OTDR 5000 housing (in ABS, type V0) does not propagate fire.

Characteristics of the options

Power meter Specifications given for 25°C, after 20 minutes stabilization time and after zero setting.

- Wavelength range: 800 to 1650 nm in steps of 1 nm
- Calibrated wavelengths: 850 / 1310 / 1490 / 1550 / 1625 / 1650 nm¹
- Accuracy at calibrated wavelengths: ± 0.2 dB (at -30 dBm)
- Input power range: -60 dBm to +10 dBm
- Maximum resolution: 0.01 dB / 0.01nW
- Measurement range: +5 to -50 dBm (+5 to -45 dBm from 800 to 1250 nm)
- Linearity within the measurement range: ± 0.2 dB

1. Specifications guaranteed to the calibrated wavelengths, except for 1650 nm

16-MAINTENANCE AND TROUBLESHOOTING

This chapter describes how to maintain your unit and identify and correct problems related to the FiberXpert OTDR 5000.

The topics discussed in this chapter are as follows:

- “Maintenance procedure”
- “Recycling Information”
- “Troubleshooting” on page
- “General information on warranty”

Maintenance procedure

Maintenance work on this instrument must only be undertaken by qualified personnel using suitable equipment.

In most cases, it is advisable to contact the nearest Softing IT Networks GmbH Service Centre, which will undertake the appropriate troubleshooting and repair work. The performance and technical complexity of the FiberXpert OTDR 5000 class this instrument in a new generation of equipment, for which Softing IT Networks GmbH has laid down a maintenance policy based on the principle of standard module replacement. In implementation of this policy, we have set up powerful card trouble- shooting test resources in our factories and a rapid dispatch system operating between our factories and branches. Only by this procedure can the high quality of the instrument continue to be ensured after repair work. This procedure also has the advantage of reducing repair costs and time.

In the interests of quality and efficiency, we strongly recommend adoption of the following procedure in the event of a fault, before any other steps are taken:

– Verify that the instrument is plugged in.

– Check the connections of any peripheral equipment to the Unit.

– If a fault is detected, or in case of doubt, it is advisable to contact the nearest Softing IT Networks GmbH Service Centre, which will undertake the appropriate repair work.

Cleaning

Cleaning plates and housings	The front and rear plates and the housings may become tarnished with handling. To clean them, use only a rag moistened with soapy water. Never use any product containing acetone, trichlorethylene, benzine or alcohol, as these will attack the printed markings
Cleaning the Screen	To clean the screen, use an antistatic product.
Cleaning the optical cable connector	– Use a non-fluffy type of paper, such as Joseph paper, soaked in isopropyl alcohol.

Cleaning the optical connections of the FiberXpert OTDR 5000

- Squirt a highly volatile solvent (such as isopropyl alcohol) into the connector.
- Blow out the connector using a clean dry air supply from an aerosol can fitted with an extension.

NOTE

If your module has a universal connector, unscrew its adaptor to access the ferrule.

Accessing the Unit Information

On the FiberXpert OTDR 5000, some screens allow to display information on different elements of the equipment.

To display the information on the FiberXpert OTDR 5000

- 1 On the Home page, validate Settings icon to reach the System Settings page.
- 2 On the right menu keys, press About to display the presentation screen of the FiberXpert OTDR 5000.

General page

The General page is displayed by default, and allows to display the presentation screen, with all the information concerning the software versions, the hardware options and the module installed.



Fig. 90 General page

This page shows:

- The software version information
- The product contents: base, optical options, battery type, touch- screen used, module installed and date of calibration for options .

The options set into the FiberXpert OTDR 5000 are marked with a green tick.

Software options page

This page allows to visualize the software options available on the FiberXpert OTDR 5000 UnitPlatform.

- 1 Once on the About screen, press Software Options menu key to display the list of software options available on your FiberXpert OTDR 5000.

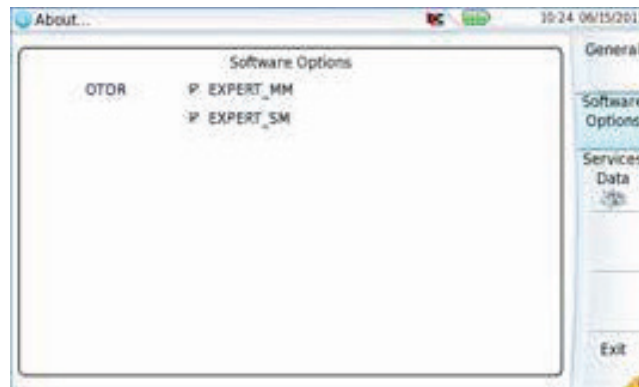

Fig. 91 Software Options page

Services Data page

This page allows to display information about the elements inside the FiberXpert OTDR 5000 (CPU, Memory, hardware revision, screen reference...).

1 Once on the About screen, press Services Data menu key to display the list of elements contained on your FiberXpert OTDR 5000.



Fig. 92 Services Data page

Accessing Unit documentation

All documents necessary for the FiberXpert OTDR 5000 use are directly available onto the equipment.

To display the list of documents available for FiberXpert OTDR 5000 use:

1 Validate the Help icon on the Home page.

2 In the page, click one link to display the corresponding document: User manual, Getting Started Manual, Quick Card...

Installing a new version of the software

When a new software version is loaded, there is a risk of re-initialization of the internal memory. Before installing the new software, it is therefore advisable to save the results in the memory, using the Save function called up by the FILE button.



Do not interrupt the installation process, as this could damage the instrument.





To avoid any interruption of the installation procedure, the FiberXpert OTDR 5000 Unit must be operating on the mains: if the procedure is started while operating on battery, a message indicates that the instrument must be connected to the mains.

Downloading from Internet

When the software is obtained from the Internet, it must be saved on a storage medium before the software upgrade of the product can be carried out. To do this:

- 1 Open Internet Explorer
 - 2 On the Softing IT Networks GmbH web site (<http://itnetworks.softing.com>), open the page of the product concerned – FiberXpert OTDR 5000
 - 3 Click on the tab Downloads.
 - 4 Click on the link FiberXpert OTDR 5000 Firmware Update
- A new page opens, displaying the current version available and several links.
- 5 According to your region, click on the one of the following icon to download the archive.

-  Download from European server
-  Download from North American server
-  Download from Asian server

- 6 In the new dialog box displayed, click on Save to save the exe file on the PC.
- 7 Once completed, connect the USB memory stick to the PC and follow the instructions chapter “Installation from a USB memory stick”

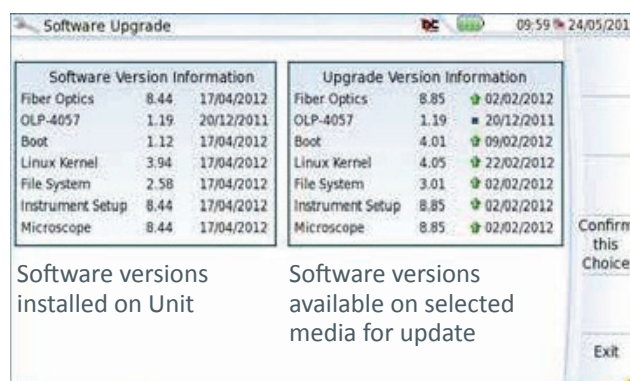

Fig. 93 Software Upgrade



Installation from a USB memory stick



You must be equipped with a USB memory stick with a minimum capacity of 128 MB.

Before installing the upgrade, you must format the USB memory stick

1 Once formatted, disconnect the USB memory stick from the FiberXpert OTDR 5000 Unit using the key Eject USB in the Media Utilities page.

As for any media formatting, please note that all data present on the USB memory stick will be irremediably lost.

2 Connect the USB memory stick to the PC

3 Unzip the upgrade files on the PC and transfer it to the USB memory stick:

a Download and save on your PC the .exe upgrade file that you can get from the web (<http://itnetworks.softing.com>)

b Once the transfer is completed, double click on the .exe file: A window will appear. Check that the folder is correct i.e. the USB memory stick driver is appearing in the line at the bottom of the dialog box then press OK. If not, click on the icon in order to select the right USB drive.

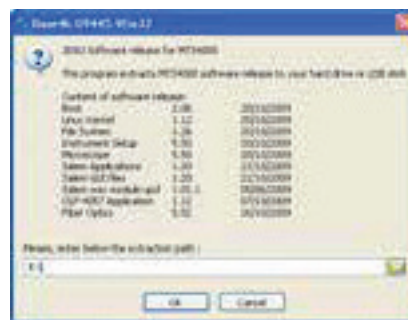

Fig. 94 List of software update

c Press OK and wait for the end of loading.

4 Then remove the USB memory stick, using the appropriate procedure, from your PC

5 Insert the memory stick into one of the USB ports on the Unit.

NOTE A bip is emitted each time the USB memory stick is inserted or removed from the USB port.

6 Press successively Expert Tools > Upgrades > Software Upgrade > Upgrade from USB.

The message Are you sure? is displayed

7 Click on Confirm.

The list of the software versions available on the USB stick is displayed next to the versions installed on the FiberXpert OTDR 5000.

Launching the upgrade

Whatever is the method selected for upgrade (Server, USB key...) and once the list of the software versions available is displayed next to the versions installed on the FiberXpert OTDR 5000 follow these instructions to launch the upgrade:

1 Click on Show Prev choice or Show Next Choice to display the previous and next versions available.

2 Click on Confirm this Choice to start the upgrade of the selected software(s).

or

Click on Confirm All Choices to upgrade all versions.

NOTE

The software versions list does not always appear (cf previous versions) as well as the Previous / Next Choice buttons and the Confirm/Continue key. In this case, the upgrading starts automatically.

Upgrading begins. The FiberXpert OTDR 5000 is automatically rebooted. Upgrading takes several minutes. Finally, the FiberXpert OTDR 5000 is automatically restarted.

During the upgrade, the Testing indicator is lit in red. Do not push any button or remove the USB memory stick while the indicator is lit. The USB stick can be removed if necessary once the Testing indicator is off.

Characteristics of the options

This method is used to make a complete reinstallation of the software versions.

1 Turn off the FiberXpert OTDR 5000 using the ON/OFF button, keeping the equipment connected to the mains.

2 Insert the USB stick onto which the software versions are stored into one of the USB port of the Unit

3 Press simultaneously SETUP + START/STOP buttons

4 Maintaining the two buttons pressed, press ON button to start the FiberXpert OTDR 5000.

5 A menu displays, then the screen allows to select Upgrade from USB

After a few seconds, a new page displays indicating that to continue the reboot, the validation key must be pressed.

Press the hard key.

The reboot starts automatically.



The Testing indicator will be lit in red during upgrade. Do not push any key or remove the USB memory stick until the lit turns off.

Once the upgrade is completed, the FiberXpert OTDR 5000 will automatically turns on and display the Home page.



Install Option

This page allows to import the licence to get a software option.

```
# This license file contains your licenses.
#
# Lines starting with #, blank lines, email header lines, and any
# other lines not starting with a JSDT keyword are comments that
# the license reader ignores.
#
# Except as noted, please do not modify lines starting with keywords.
#
#-----
# This file should be loaded onto your FTTE product in order
# to activate your software options.
#-----
#
# To do so,
# First copy this file onto a USB stick.
# Then, starting from the Home screen (press 'Home' to go to this screen):
#
# Press the following keys:
# "Expert Tools"
#      => "Upgrades"
#           => "Install Option"
#                => "Import License"
#
# You should then select this file from the File Explorer window and press
# "Load".
# Followed by "Confirm".
#
# The challenge codes contained in this file will then be loaded automatically
# and your
# software options will be installed.
#
# At the end of this sequence you will be asked to reboot the unit.
#
# You may also enter these challenge codes manually, if you wish.
#
#-----
# Validation date : 2008-10-13 16:09:14
# Generation date : October 22, 2008, 14:14:03
# Challenge Codes
# Lic_id=02 ( AAAA1A ) Ext=Clear Dongle USB Bluetooth Base_sn=0 CID=0000
# FTTEJSDOLIC AAAA1A-AMV99d#EEEE90E7IyrfjDEE9d5dY5Aa1eF4gwVIE8e8ak _____ Licence
# Code
```

Fig. 95 Example of a License file (.lic)

To import the license, you can either enter manually the licence code, given in the license file, (.lic file) or import this file with a USB memory stick connected to the FiberXpert OTDR 5000.



It is strongly recommended to perform the installation using the importation of Licence via a USB memory stick.

Enter Manually the Licence

1 In the Home page, click on Expert Tools > Upgrades > Install Option > Enter License

The edition keypad is displayed

2 Enter the challenge code of the option, set at the bottom of the file

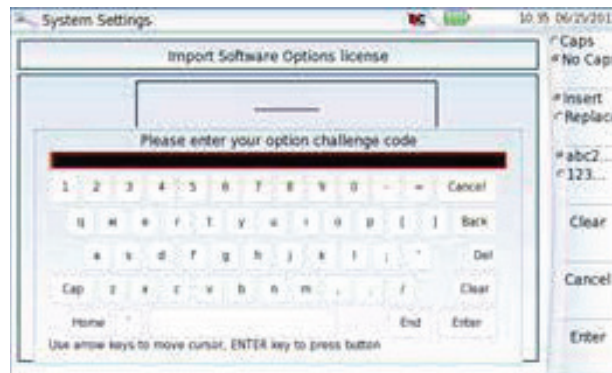

Fig. 96 Enter the Licence code



The license file can be opened via a word processing software such as Word...

The challenge code must be entered exactly as it is in the .lic file, paying attention to the lower-case and upper-case letters etc.

3 Press the Enter key to validate the code

Your software options will be installed

At the end of this sequence you will be asked to reboot the unit to apply the modifications, pushing the key . Confirm the reboot to restart the Unit. 

Import the license from the USB memory stick

1 In the Home page, select the Settings icon

2 In the System Settings page, press Expert Tools > Upgrades > Install Option > Import License

If the USB memory stick is not already connected to the Unit, a message asking the memory stick insertion is displayed. Confirm it once the stick is connected.

3 In the File Explorer, select the USB stick, then the license file (.lic) to be imported,

4 Click on Load > Confirm

5 The challenge codes contained in this file will then be loaded automatically and your software options will be installed



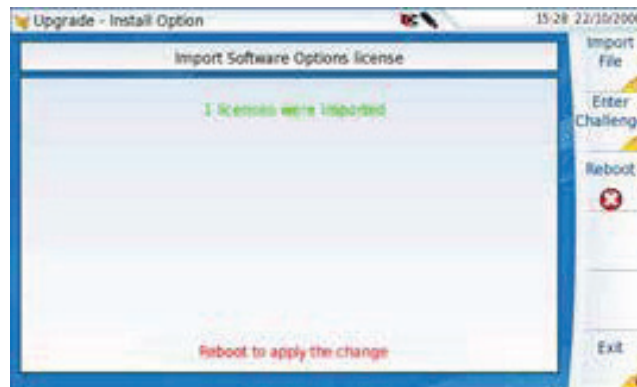



Fig. 97 License imported

6 At the end of this sequence you will be asked to reboot the unit to apply the modifications, pushing the key  .

7 Confirm the reboot

Locking the FiberXpert OTDR 5000

The FiberXpert OTDR 5000 can be locked at any time:

1 In the HOME page, click on Expert Tools

2 Click on Instrument Lock Out

3 Confirm the FiberXpert OTDR 5000 locking by clicking on Confirm (or use the Cancel key to cancel the process).

The numeric keypad is displayed

4 Enter the password to lock the instrument: 42000 with the numeric keypad displayed.

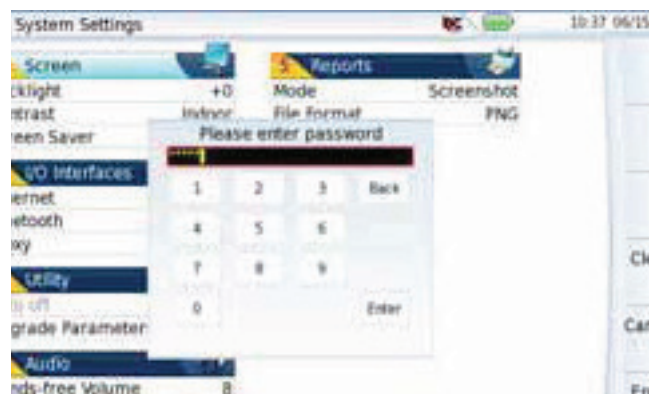

Fig. 98 Passw ord

5 Click on Enter

The FiberXpert OTDR 5000 locking screen is displayed.



Fig. 99 Locking screen

Click on the Notepad Message key to add a message using the text edition.

Unlocking the FiberXpert OTDR 5000

- 1 Once the locking screen is displayed, click on the key Unlock Instrument.
 - 2 Press confirm to confirm the Unit must be unlocked.
 - 3 Enter the password 42000 using the numeric keypad displayed and validate.
- The screen automatically displays the HOME page.

Returning an instrument

To return an instrument get in contact with Softing IT Networks GmbH to follow the appropriate RMA process

When returning an instrument, it is essential to indicate the following minimum information:

- the type and serial number of the instrument (on the identification label) and the configuration code (under the bar code)
- a description of the fault found on the instrument.

The returned instrument will then be repaired and calibrated.

Guarantee conditions

Any repair operation supervening within the guarantee period of the instrument will be carried out at the expense of Softing IT Networks GmbH. However, for any sub-assembly upon which work has been carried out otherwise than by Softing IT Networks GmbH Service Centers, the cost of a replacement sub-assembly will be invoiced.

Recycling Information

Softing IT Networks GmbH recommends that customers dispose of their instruments and peripherals in an environmentally sound manner. Potential methods include reuse of parts or whole products and recycling of products components, and/or materials.

Waste Electrical and electronic Equipment (WEEE) Directive



In the European Union, this label indicates that this product should not be disposed of with household waste. It should be deposited at an appropriate facility to enable recovery and recycling.

Troubleshooting

Troubleshooting	Solution
Nothing happens when the ON/ OFF key is pressed.	- Make sure that the battery is present or charged; or the mains adapter is properly connected
Nothing happens on screen, whatever is the action done (menu key or hard key pressed...)	- The Unit must be rebooted.
You are using the FiberXpert OTDR 5000 in the ordinary way when it suddenly switches off.	- Check the instrument is not configured to Auto off. See - Check the battery charge level.
The battery refuses to charge (the Charge indicator does not go on when the instrument is connected to the mains and is not operating).	- There is no battery in the instrument. - The temperature level of the equipment does not allow the battery charging for safety reasons. Wait the equipment cools down. - The battery needs to be changed.
When using the touchscreen, nothing happens	The touchscreen needs to be calibrate.
Troubleshooting	Solution
Error message when USB has been disconnected	- The USB disconnection has not been done properly - The data transfer was not completed when USB key was disconnected.
No beep is emitted when the USB memory stick is connected	- A previous USB memory stick has not been properly disconnected - The USB memory stick is not detected by the FiberXpert 5000 Unit: use another memory stick, or another storage media; or transfer data via USB cable
Error message when upgrade via Ethernet is confirmed	- Check the Server Name is correctly entered
Error message when upgrade via USB key is confirmed	- Check the USB key is correctly connected
Error message when unlocking the instrument	- The password is not the correct one

Formatting the USB memory stick onto the FiberXpert OTDR 5000

If the USB icon  is displayed on the upper banner of the screen, when a USB memory stick is connected to the FiberXpert OTDR 5000, this may mean the memory stick must be formatted.

If the stick needs to be formatted, proceed as follows:

- 1 Insert the memory stick into one of the USB port on the top of the FiberXpert OTDR 5000.
- 2 Press the HOME button
- 3 Validate the Settings icon to open the System Settings page.
- 4 On the right menu keys, successively select Expert tools > Media utilities > Usbflash Format.
- 5 Confirm your choice to actually format the USB memory stick.



As for any media formatting, please note that all data present on the USB memory stick will be irremediably lost.

Erase disk

To delete all the disk contents of the FiberXpert OTDR 5000:

- 1 On the Home page, Press twice the Settings icon to open the System Settings page
 - 2 Press Expert Tools > Media Utilities,
 - 3 Select Erase Disk to delete all the disk contents into the FiberXpert OTDR 5000 Unit.
- A confirmation must be validated before the deletion.

Touchscreen calibration

If you meet problems when using the touchscreen (example: pressing on an icon does not work correctly...) a calibration can be performed on the FiberXpert OTDR 5000 touchscreen.

To calibrate the touchscreen, proceed as follows:

- 1 Push the HOME button
- 2 Press twice the Settings icon to open the System Settings page.
- 3 Press Expert Tools menu key
- 4 Press Touchscreen Calibration key

A blue slightly smaller screen appears, displaying a little target on the left hand corner.

- 5 Click on this target (preferably with the touchscreen pen).

- 6 A new target appears then and again, for a total of 4 times, in order to click on all corners of the screen.

If all the targets are not correctly touched, the touchscreen cannot be used. Otherwise, the touchscreen may be used directly.





Fig. 100 Touchscreen calibration

Changing the battery

If you meet problems during the Unit functioning, or if the battery does not charge anymore when plugged, this may require the battery to be replaced.



CAUTION

Battery is not interchangeable in the field. It must be replaced by Softing IT Networks GmbH. Please contact support.

Erase disk

The warranties described herein shall apply to all commercially available Softing IT Networks GmbH products. Any additional or different warranties shall apply only if agreed to by Softing IT Networks GmbH in writing. These warranties are not transferable without the express written consent of Softing IT Networks GmbH.

Hardware Warranty

Softing IT Networks GmbH warrants that Hardware Product sold to customer shall, under normal use and service, be free from defects in materials and workmanship. Information regarding the specific warranty period for this product can be obtained by contacting your local Softing IT Networks GmbH Customer Service Representative, or at our web site <http://itnetworks.softing.com>. If installation services have been ordered, the warranty period shall begin on the earlier of (1) completion of installation, or (2) thirty (30) days after shipment to customer. If Installation Services have not been ordered, the warranty period shall begin upon shipment to Customer. Hereafter these periods of time shall be collectively referred to as the Initial Warranty Period. Softing IT Networks GmbH's obligation and customer's sole remedy under this Hardware Warranty is limited to the repair or replacement, at Acterna's option, of the defective product. Softing IT Networks GmbH shall have no obligation to remedy any such defect if it can be shown: (a) that the Product was altered, repaired, or reworked by any party other than Softing IT Networks GmbH without Softing IT Networks GmbH's written consent; (b) that such defects were the result of customer's improper storage, mishandling, abuse, or misuse of Product; (c) that such defects were the result of customer's use of Product in conjunction with equipment electronically or mechanically incompatible or of an inferior quality; or (d) that the defect was the result of damage by fire, explosion, power failure, or any act of nature. Softing IT Networks GmbH performed repairs shall be warranted from defective material and workmanship for a period of ninety (90) days, or until the end of the Initial Warranty Period, whichever is longer. Risk of loss or damage to Product returned to Softing IT Networks GmbH for repair or replacement shall be borne by customer until delivery to Softing IT Networks GmbH. Upon delivery of such product, Softing IT Networks GmbH shall assume the risk of loss or damage until that time that the product being repaired or replaced is returned and delivered to customer. Customer shall pay all transportation costs for equipment or software shipped to Softing IT Networks GmbH for repair or replacement. Softing IT Networks GmbH shall pay all transportation costs associated with returning repaired or replaced product to customer.

Warranty disclaimer

For hardware and/or services furnished by Softing IT Networks GmbH, the foregoing warranties are in lieu of all other warranties and conditions, express or implied. Softing IT Networks GmbH specifically disclaims all other warranties, either express or implied, on any hardware, documentation or services including but not limited to warranties relating to quality, performance, noninfringement, merchantability or fitness for a particular purpose, as well as those arising from any course of dealing, usage or trade practice. Under no circumstances will Softing IT Networks GmbH be liable for any indirect or consequential damages related to breach of this warranty.



INDEX

A

About page 131

Accessories 125

Adapter specifications 121

Attenuation accuracy of measurement 26

B

Battery charging time 17 specifications 120

Bluetooth pairing 113

remove pairing 118 search devices 114 specifications 124

C

Cleaning optical connectors 10

plates, housings and screen 130

Connectors cleaning 130

CSV file 71

E

Environment 122

F

File storage media 84 transfer

connection for 73, 74

process 75

G

Guarantee conditions 143

H

HTML file 71

I

Indicators 5

J

JPG,JPEG file 72

L

Licenseenter manually 140 import from USB 141

License file 71, 140

M

Memory capacity 120

Module fitting and removing 14

MSOR file 71

O

Optical connectors precautions 10

OTDR file 71

P

PDF File 71

Power meter

alarm 28

attenuator compensation 27 connection 26

file management 32 measurement 31 reference 126

reference measurement 30 results 28

specifications 123 zero value 30

Power Meter file 71

Processing software reference 127

R

Guarantee conditions 143

S

Scope

comment 47 load picture 47 mosaic 46

report display 48

Screen specifications 120



Screenshot 79
 Services data 132
 Software update
 via Ethernet 134 via Internet 133 via USB 136
 Storage media 84 abbreviations 88

T

Text file 71
 Transfer interface ethernet Mode 53 proxy config. 54 remote screen 52

U

Unpacking the instrument 2
 Unit access to the internal memory 76
 assembly 14
 dimensions 121 indicators 5
 locking 142
 reset 18
 switching off 18 switching on 17
 troubleshooting 144
 USB connection 84 disconnection 84 upgrade via 136
 User manual reference 127

W

Web Browser bookmarks 64 navigation 63
 pdf document 65 quit 65

V

VFL
 connection 26 emission of light 31 function 31 specifications 123

X

XML file 72

NORTH AMERICA & CANADA

Softing Inc.
Knoxville, Tennessee
Phone: +1.865.251.5252
E-mail: sales@softing.us

ASIA/PACIFIC

Singapore

Softing Singapore Pte. Ltd.
Singapore
Phone: +65-6569-6019
E-mail: asia-sales.itnetworks@softing.com

China

Softing Shanghai
Shanghai
Phone: +86-21-54133123
E-mail: china-sales.itnetworks@softing.com

EUROPE/MIDDLE EAST/AFRICA

Germany

Softing IT Networks GmbH
Haar, Munich
Phone: +49 89 45 656 660
E-mail: info.itnetworks@softing.com

France

Softing SARL
Créteil, Île-de-France
Phone: +33145172805
E-mail: info.france@softing.com

Italy

Softing Italia Srl.
Cesano Boscone, Milano
Phone: +39 02 4505171
E-mail: info@softingitalia.it

Austria

Buxbaum Automation GmbH
Eisenstadt
Phone: +43 2682 7045 60
E-mail: office@myautomation.at

For technical information and support please contact the Softing office in your country.
<http://itnetworks.softing.com>

