

T USA
Equipment
.NET
 An Interworld Highway, LLC Company
 Call Us 1.877.571.7901

GL622N/GL612N

GL622N/GL612N



User Guide
 Bedienungsanleitung
 Manuel de l'utilisateur
 Guida per l'uso
 Guía del usuario
 Gebruikershandleiding
 Operatörshandbok
 Brugermanual
 Guia do Usuário
 Bruksanvisning
 Käyttäjän opas
 Instrukcja obsługi
 Руководство пользователя



Trimble - Spectra Precision Division
 5475 Kellenburger Road
 Dayton, Ohio 45424 U.S.A.

+1-937-245-5600 Phone

www.trimble.com



© 2017, Trimble Inc., All rights reserved.
 PN 111372-00 Rev. A (02/17)



www.trimble.com



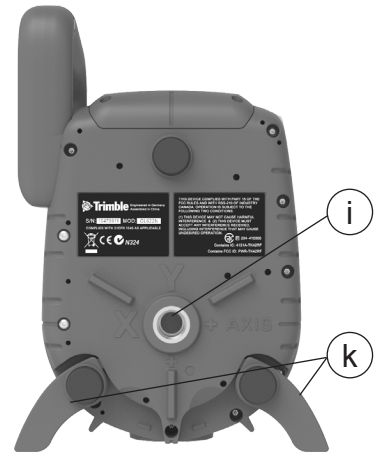
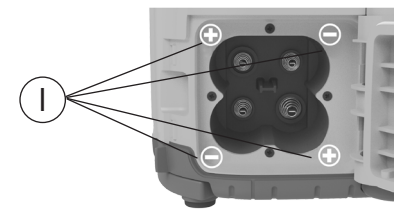
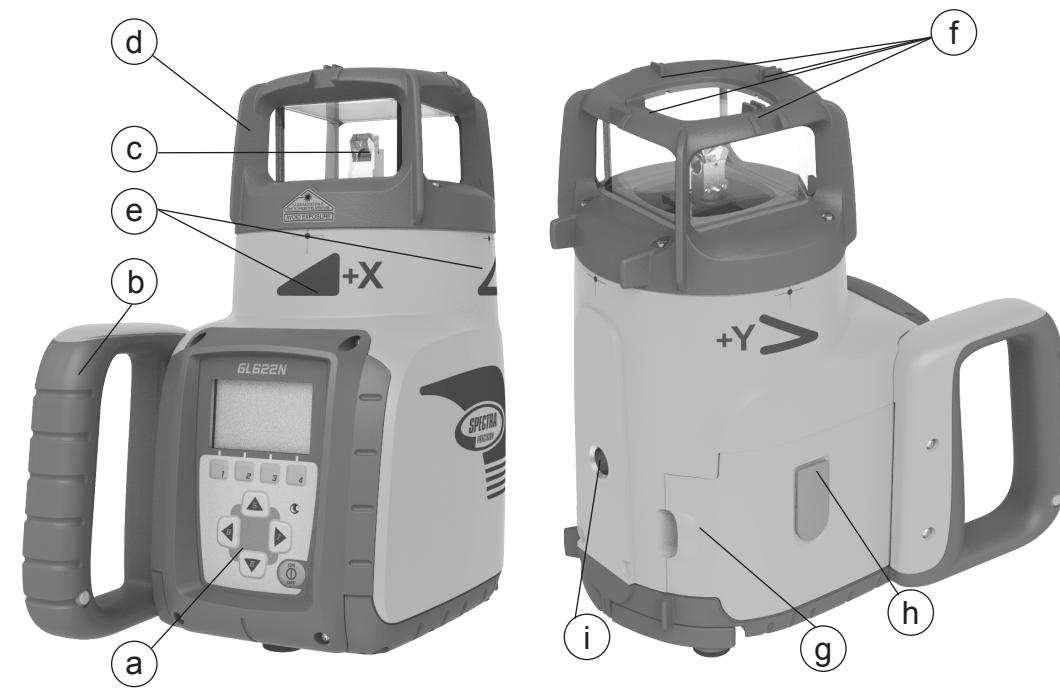

Service and Customer Advice

North America

Trimble - Spectra Precision Division
 5475 Kellenburger Road
 Dayton, Ohio 45424 U.S.A.
 888-527-3771 (Toll Free)
 +1-937-245-5600 Phone
 +1-937-482-0030 Fax
 www.trimble.com
 www.spectraprecision.com
 www.spectralasers.com

Europe

Trimble Kaiserslautern GmbH
 Am Sportplatz 5
 67661 Kaiserslautern
 GERMANY
 +49-6301-711414 Phone
 +49-6301-32213 Fax

Latin America

Trimble Navigation Limited
 6505 Blue Lagoon Drive
 Suite 120
 Miami, FL 33126
 U.S.A.
 +1-305-263-9033 Phone
 +1-305-263-8975 Fax

Africa & Middle East

Trimble Export Middle-East
 P.O. Box 17760
 Jebel Ali Free Zone, Dubai
 UAE
 +971-4-881-3005 Phone
 +971-4-881-3007 Fax

Asia-Pacific

Trimble Navigation
 Australia PTY Limited
 Level 1/120 Wickham Street
 Fortitude Valley, QLD 4006
 AUSTRALIA
 +61-7-3216-0044 Phone
 +61-7-3216-0088 Fax

China

Trimble Beijing
 Room 2805-07, Tengda Plaza,
 No. 168 Xiwai Street
 Haidian District
 Beijing, China 100044
 +86 10 8857 7575 Phone
 +86 10 8857 7161 Fax
 www.trimble.com.cn

1 INTRODUCTION	3
2 FOR YOUR SAFETY	3
3 COMPONENTS	3
4 How to use the Laser System	4
4.1 Powering the Laser	4
4.1.1 Batteries	4
4.1.2 Recharging the batteries	4
4.2 RC602N Radio Remote Control	4
4.2.1 Powering the RC602N	4
4.2.2 Turning On/Off the RC602N	4
4.3 ST802/ST805 Signal Transporter	5
4.3.1 Powering the ST802/ST805	5
4.3.2 Turning On/Off the ST802/ST805	5
5 LASER SETUP	5
5.1 Turning On/Off the Laser	5
5.2 Features and functions	6
5.2.1 Standard Display	6
5.3 Standard Features	6
5.3.1 X-Y-grade entering - Digit Select mode (Default)	6
5.3.2 X-Y-grade - Step and Go mode	7
5.3.3 Rotation Mode	8
5.3.4 Manual Mode	8
6 Special MENU Features	8
6.1 Menu Navigation	8
6.2 Automatic PlaneLok Mode	9
6.3 Automatic Grade Match	10
6.4 Automatic Axis Alignment (only GL622N)	11
6.5 Mask Mode	11
6.6 Activating/Deactivating Standby mode	11
6.7 Start Reference Check	12
6.8 Setting Menu	12

6.9 Info	12
6.10 Service	12
6.11 RC602N Service Menu	13
6.11.1 RF Connectivity	13
7 Special Features - Vertical Setup	13
7.1 Line Scan	13
8 Setting	13
8.1 Pairing	14
8.2 Pairing the laser with remote control	14
8.3 Pairing the laser with receiver HL760	14
8.4 Pairing the laser with the Signal Transporter (ST802/ST805)	14
8.5 Grade Entry	15
8.6 Grade Display	15
8.7 Sensitivity Selection	15
8.8 HI-alert selection	15
8.9 User Name	16
8.10 Set Password	16
8.11 Password On/Off	16
8.12 Radio (RF-Channel)	17
8.13 Select Language	17
9 CALIBRATION	17
9.1 Checking Calibration of the Y- and X-Axes	17
9.2 Checking Calibration of the Z-(vertical) Axis	17
10 TROUBLESHOOTING	18
11 PROTECTING THE UNIT	19
12 CLEANING AND MAINTENANCE	19
13 PROTECTING THE ENVIRONMENT	19
14 WARRANTY	19
15 TECHNICAL DATA	20
15.1 GL612N/GL622N	20
15.2 RC602N	20
16 DECLARATION OF CONFORMATY	20
17 ELECTROMAGNETICAL COMPATIBILITY	21

1 INTRODUCTION

Thank you for choosing one of the Spectra Precision Lasers from the Trimble family of precision lasers. The grade laser is an easy-to-use tool that offers accurate horizontal, vertical and sloped laser reference up to 1300 ft (400 m) away using a receiver.

2 FOR YOUR SAFETY



For hazardless and safe operation, read all the user guide instructions.



- Use of this product by people other than those trained on this product may result in exposure to hazardous laser light.
- Do not remove warning labels from the unit.
- The GL622N/GL612N is a class 2 laser (IEC 60825-1:2014).
- Never look into the laser beam or direct it to the eyes of other people.
- Always operate the unit in a way that prevents the beam from getting into people's eyes.
- If initial service is required, which results in the removal of the outer protective cover, removal must only be performed by factory-trained personnel.



Caution: Use of other than the described user and calibration tools or other procedures may result in exposure to hazardous laser light.

Caution: Using different than described at the GL612N/GL622N user guide, may result in unsafe operation.

3 COMPONENTS

- a Keypad/LCD-Display
- b Handle
- c Rotor
- d Sunshade
- e Axes-Alignment-Marks
- f Sighting Guides/Scope Mounts
- g Battery door
- h Rubber Cover/Recharge Jack
- i 5/8" x 11 Tripod Mounts
- j Rubber Feet
- k Turnable Legs
- l Plus and Minus Battery Diagrams

4 HOW TO USE THE LASER SYSTEM

4.1 POWERING THE LASER

4.1.1 Batteries

WARNING

Ni-MH batteries may contain small amounts of harmful substances. Be sure to charge the battery before using it for the first time, and after not using it for an extended length of time. Charge only with specified chargers according to device manufacturer's instructions. Do not open the battery, dispose of in fire or short circuit; it may ignite, explode, leak or get hot causing personal injury. Dispose in accordance with all applicable federal, state, and local regulations. Keep the battery away from children. If swallowed, do not induce vomiting. Seek medical attention immediately.

4.1.2 Recharging the Batteries

The laser might be shipped with a rechargeable Ni-MH battery pack.

Note: The approximate charge of the batteries is shown at the left top side of the LCD.

The charger requires approx. 10 hours to charge empty rechargeable batteries.

For charging, connect the plug of the charger to the recharge jack of the battery pack.

New or long-time out-of-use rechargeable batteries reach their best performance after being charged and recharged five times. For Indoor applications the charger can be used as a power supply for the laser.

Alkaline batteries can be used as a backup. Insert 4 D-cell batteries noting the plus (+) and minus (-) diagrams inside the battery housing.



The batteries should only be charged when the laser is between 50° F and 104° F (10°C to 40°C). Charging at a higher temperature may damage the batteries. Charging at a lower temperature may increase the charge time and decrease the charge capacity, resulting in loss of performance and shortened life expectancy.

4.2 RC602N Radio Remote Control

4.2.1 Powering the RC602N

1. Open the battery door using a coin or similar pry device to release the battery door tab on the RC602N. RC602N will be shipped with alkaline batteries. Rechargeable batteries can be used optional but need to be charged externally.
2. Insert two AA batteries noting the plus (+) and minus (-) diagrams inside the battery housing.
3. Close the battery door. Push down until it "clicks" into the locked position.



4.2.2 Turning On/Off the Radio Remote Control

The radio remote control is a hand-held device that allows you to send operational commands to the laser from a remote location.

Press the power button to turn on the radio remote control. The symbol "T" and additional vertical bars appear in the right corner of the remote's top display line indicating the radio connection status between the laser and the remote control.

Note: When the remote control is initially turned on, the standard display (model number and software version) appear for the first 3 seconds, then the axes symbols and last-entered grade for each axis appear in the LCD.

With every button press, the LCD backlight is activated and turns off automatically if no button is pressed for 8 seconds.

To turn off the radio remote control, press the power button. for two seconds.

Note: 5 minutes after the last button press, the remote control turns off automatically.

4.3 ST802/ST805 SIGNAL TRANSPORTER

4.3.1 POWERING THE ST802/ST805

1. Open the battery door using a coin or similar pry device to release the battery door tab on the ST802/ST805. ST802/ST805 will be shipped with alkaline batteries. Rechargeable batteries can be used optional but need to be charged externally.
2. Insert two AA batteries noting the plus (+) and minus (-) diagrams inside the battery housing.
3. Close the battery door. Push down until it "clicks" into the locked position.

4.3.2 Turning On/Off the ST802/ST805

The signal transporter (ST) is a hand-held device that which extends the radio range of a laser which is paired with the ST. Press the power button to power on the signal transporter. All LEDs turn on for three seconds. Finally a flashing yellow status LED shows the signal transporter has been paired with a laser but this laser is not available. A solid blinking yellow status LED is showing that the radio connection between the signal transporter and the paired laser has been established.

5 LASER SETUP

Position the laser horizontally (tripod mount and rubber feet downward!) on a **stable** platform, wall mount or tripod at the desired elevation.

The laser recognizes automatically whether it is used horizontally or vertically when switched on.

5.1 Turning On/Off the laser

Press the power button for one second to turn On the laser.

Press the power button for two seconds to turn Off the laser.

Note: When a grade value has been entered and after temperature change of more than 9°F (5°C), the unit starts the temperature/reference check while the thermometer symbol is flashing (Pic 1).

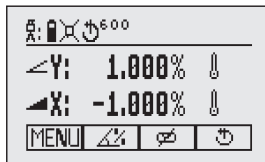

Pic 1 Reference check

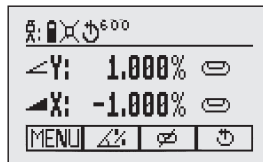

Pic 2 Standard display horizontal



Pic 3 Standard display vertical

Another temperature check takes place after 20 min. and finally every 60 min. When the temperature/reference check has been finished, the standard display appears and the bubble symbols flash until self-leveling has been completed (Pic 2).

If the self-leveling can't be finished based on the selected sensitivity, an error message appears.

5.2 Features and Functions

5.2.1 Standard Display

The remote control mirrors the functionality of the laser keypad

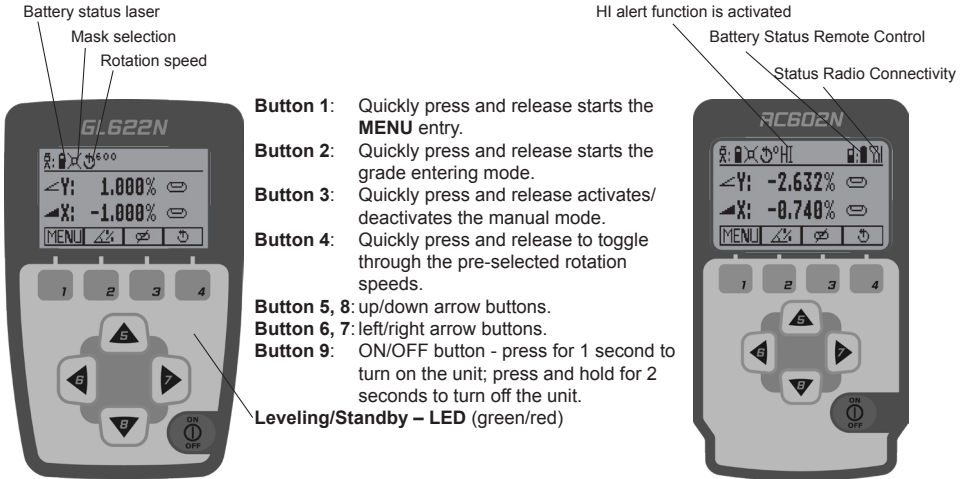

5.3 Standard Features

5.3.1 X-Y-grade entering – Digit Select mode (Default)

Quickly press and release button **2** (Pic 4) starts the grade entering mode.

Both grade values will be shown.

A cursor (Pic 5) blinks at the current position which can be changed.

Press/release button **1** ⇨ quick set to 0%

Press/release button **2** ⇨ change the sign in front of the grade value

Press/release button **3** ⇨ return to the standard display.

Quickly press and release button **4** to confirm the selected grade value and return to the standard display.

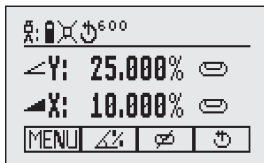

Pic 4 Standard Display

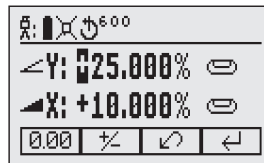

Pic 5 Grade Entry Mode

Press and release button **5** or **8** (down or up) to move the cursor to the X- (only GL622N) or Y-axis

Pressing and releasing button **6** or **7** (right or left) moves the cursor to the right/left.

Use button **1** or **2** (Plus or Minus) to set the desired digit (Pic 6).

The laser will self-level to the required grade position after confirming the grade change with button **4**.

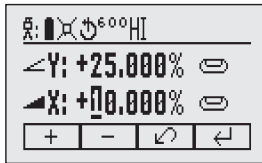

Pic 6 Set Digit

Note: The bubble symbols at the laser and remote control LCD will flash until the laser has been self-leveled to the requested grade position.

5.3.2 X-Y-grade entering – Step and Go mode

How to change to 'Step and Go' mode see chapter 8.5

Quickly press and release button **2** (Pic 7) starts the grade entering mode. Both grade values will be shown. Press/release button **1** ⇨ grade reverse Y (Pic 8)
 Press/release button **2** ⇨ grade reverse X (only GL622N)
 Press/release button **3** ⇨ return to the standard display
 Quickly press and release button **4** to confirm the selected grade value and return to the standard display

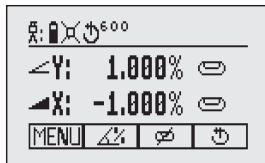

Pic 7 Standard Display

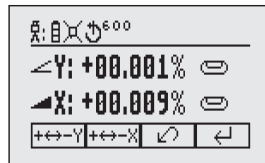

Pic 8 Grade Reverse

Press and hold button **6** or **7** (left/right) to change X- axis grade value (only GL622N) after the comma; press and hold buttons **6** + **7** simultaneously starts X-axis quick change mode where the grade value in front of the comma will be set to 0% and then starts changing in 1% increments.

Press and hold button **5** or **8** (up/down) for changing Y -axis grade value; press and hold buttons **5** + **8** simultaneously starts Y - axis quick change mode where the grade value in front of the comma will be set to 0% and then starts changing in 1% increments.

Note: The speed of the grade value change increases with the amount of time the button is held down.

Note: The grade value for both axes increases in 1.00% increments. When the grade value for either axis reaches its highest amount, the grade value switches to the lowest value for that axis. For example, the value switches from +25% to -25%.

The laser will self-level to the required grade position after confirming the grade change with button **4**.

Note: The bubble symbols at the laser's LCD will flash until the laser has been self-leveled to the requested grade position.

5.3.3 Rotation Mode



Repeatedly pressing the button **4** toggles through 300, 600, 750 rpm regardless if the unit is in automatic or manual mode.

5.3.4 Manual Mode



Pressing and releasing button **3** at the Standard Display activates/deactivates the manual mode regardless if set up horizontal or vertical. Manual mode is indicated by horizontal lines next to the axes symbols.

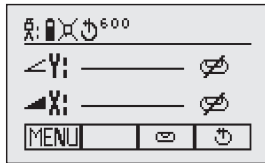

Pic 9 Horizontal manual



Pic 10 Vertical manual

In Manual mode (horizontal), the Y-axis can be sloped by pressing the Up-(5) and Down-Arrow-(8) buttons on the laser's keypad or the remote control. Additionally, the X-axis can be sloped by pressing the Left-(6) and Right-(7) Arrow-buttons on the laser or remote control.

In vertical mode, the up and down arrow buttons adjust the Z-axis slope, and the left and right arrow buttons align the laser beam to the right/left side.

To resume automatic self-leveling mode, press the manual button again.

6 Special MENU Features

6.1 Menu Navigation (Radio controlled)

Press and release button **1** at the Standard Display to enter the MENU.

The menu offers always only the features which can be selected depending on the setup (horizontal or vertical).

The icon of the selected function will be highlighted.

A down arrow at the the right site indicates that the user can scroll down through the menu using the button **8** (down arrow).

After going to the next menu row, an up/down arrow at the the right site indicates that the user can scroll up/down through the menu (4 different screens) using the buttons **5/8** (up/down arrows).

Pressing and releasing button **3** changes the unit always back to the standard or previous display.

Press and release the buttons **6/7** until the desired icon at the selected menu row is highlighted.

Press and release button **4** to open the submenu OR start the selected function.



Call Us 1.877.571.7901

6.2 Automatic PlaneLok Mode

The PlaneLok mode can be activated in horizontal and vertical automatic and manual mode.

In PlaneLok mode when set up horizontal, the beam will be locked to a fixed elevation point (up to 150 m (490 ft) located on one axis at each side of the laser.

For keeping vertical alignments fixed to a direction point, PlaneLok can be used in both directions on the Y-axis (GL622N only) or on the X-axis.

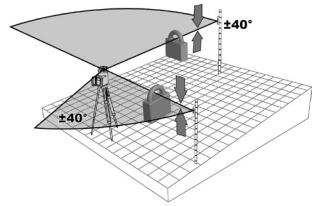

Note: In every PlaneLok mode the laser continues to servo to the receiver's signals. Any loss of signal over an extended period of time (1 minute) causes the laser to go into the HI-alert condition (beam turns off, rotor stops and a warning message occurs at the LCD). PlaneLok mode can be reactivated after the error message has been deleted with button 4. Exiting of PlaneLok mode can be done by pressing button 3 (ESC) or any HL760 button.

Horizontal Set Up:

1. Set up the laser over the reference point.
2. Attach the HL760 receiver to a grade rod. Place the receiver at the second point and adjust it to the On-grade position. The receiver should be permanently mounted at this location and at the desired elevation.
3. Use the sighting guides on the top of the laser to align the laser to the receiver. Turn the laser on the tripod until it is roughly aligned to the receiver's position (the alignment range for both axes is $\pm 40^\circ$).
4. Press and release the MENU button at the Standard Display and select PlaneLok (Pic 11).



Pic 11 PlaneLok horizontal



Pic 12 PlaneLok vertical

5. When set up horizontally, press and release button 4 to open the PlaneLok submenu; select the desired PlaneLok axis Y (Pic 13) or X ((Pic 14)- only GL622N) then press button 4 to start PlaneLok.



Pic 13 PlaneLok Y-Axis



Pic 14 PlaneLok X-Axis

Note: The laser starts to search for the receiver. A flashing Receiver and Lock symbol appears at the selected axis and becomes solid when PlaneLok has been completed.



The HL760 display shows a flashing **-PL-** during the time the laser is searching and adjusting the beam to the on-grade position. When PlaneLok is complete, **-PL-** stops flashing at the HL760 display.

6. Exiting of PlaneLok can be done by pressing button 3 (ESC).

Vertical Set Up:

1. Set up the laser over the reference point
2. Attach the HL760 receiver (with the vertical adapter) to the next reference point
3. Press and release the MENU button at the Standard Display and select PlaneLok (Pic 12). With product GL612N, PlaneLok in X-axis can be started immediately by pressing button 4. With product GL622N press

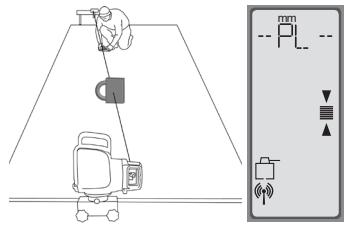

and release button 4 to open the PlaneLok submenu; select the Y axis (Pic 13) or X-axis (Pic 14) and release button 4 to start PlaneLok

Note: When used in vertical mode, the receiver has to be placed with the photocell on the bottom side; for Y-PlaneLok, align the top of the receiver to the top of the laser. The HL760 display shows a flashing – PL – during the time the laser is searching and adjusting the beam to the on grade position. When PlaneLok is complete, - PL – stops flashing at the HL760 display.

4. Exiting of PlaneLok can be done by pressing button 3 (ESC).

6.3 Automatic Grade Match

The Grade Match mode can be activated in horizontal automatic and manual mode.

In Grade Match mode, the laser can be used to measure the existing grade value between two known elevation points (up to 150 m (490 ft) located on one axis at each side of the laser

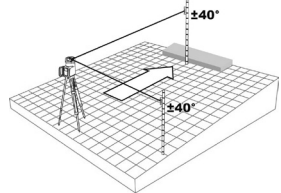

1. Set up the laser over the reference point.
2. Attach the HL760 receiver to a grade rod. Check the laser's elevation next to the laser then position the receiver at the second point WITHOUT changing the receiver's elevation on the rod.
3. Use the sighting guides on the top of the laser to align the laser to the receiver. Turn the laser on the tripod until it is roughly aligned to the receiver's position (the alignment range for both axes is $\pm 40^\circ$).
4. Press and release the MENU button at the Standard Display and select Grade Match. (Pic 15)



Pic 15 Grade Match

5. Select the desired Grade Match axis Y (Pic 16) or X (Pic 17; only GL622N) then press button 4 to start Grade Match.



Pic 16 Grade Match
Y-Axis



Pic 17 Grade Match
X-Axis

Note: The laser starts to search for the receiver. A flashing Receiver and angle symbol appears at the selected axis and disappears when Grade Match has been completed.

While the laser is searching and adjusting the beam to the on-grade position, the HL760 display shows a flashing –GM–.

When Grade Match has been completed, the HL760 goes back to the standard elevation display. The remote control as well as the laser will display the final measured grade value.



Note: If Grade match can't be completed by checking the limits, the laser comes with an Error message (Grade Match has Failed) which can be deleted with button 4 (OK). The HL760 goes back to standard elevation indication.

6.4 Automatic Axis Alignment (only GL622N)

Automatic Axis Alignment mode adjusts automatically the direction the grade axis is pointing to the receiver's location by an electronically simulation of rotating the unit on its base to match the hub. Using Axis Alignment, the laser axis can be aligned to one direction hub (up to 150 m (490 ft) located on one axis at each side of the laser).

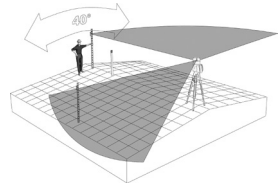

1. Set up the laser over the reference point.
2. Place the grade rod with the attached HL760 receiver at the desired direction hub.
3. Use the sighting guides on the top of the laser to align the laser to the receiver. Turn the laser on the tripod until it is roughly aligned to the receiver's position (the alignment range for both axes is $\pm 40^\circ$).
4. Press and release the MENU button at the Standard Display and select Axis Align. (Pic18)



Pic 18 Axis
Alignment horizontal

5. Select the desired axis Y (Pic 19) or X (Pic 20) then press button 4 to start Axis Align.



Pic 19 Axis
Alignment Y Axis



Pic 20 Axis
Alignment X-Axis

Note: Adjusting the receiver into the beam before starting the automatic Axis Alignment reduces the time needed for finishing the alignment.

6.5 Mask mode



Pic 21
Mask Mode

Select the Mask icon (Pic 21) and press and release button 4 to open the Mask setting menu. Depending on which side or corner the beam should be turned off, the required sector can be selected. Press and release the buttons 5 to 8 for moving a short flashing line around the mask mode symbol. For selecting the sector where the bar is flashing, press and release button 1 (SET). After setting the first sector, button 1 changes to show CLR which offers the capability of deleting the selected mask sector again. Use button 5 to 8 to move the flashing bar to other required areas and repeat the setting process. When all areas have been set, press button 4 to store the mask sector selection until the unit will be turned off.

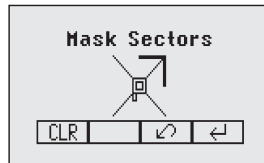
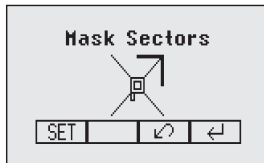

Note: The unit always powers up with the mask mode deactivated (default).

6.6 Activating/Deactivating Standby mode



Pic 22
Standby

Press and release the MENU button at the Standard Display and select Standby (Pic 22).

Pressing and releasing button 4 activates the Standby mode.

The self-leveling will be stopped and the beam will be turned off while the HI alert is still active.

The display shows the standby symbol and the Level/Standby LED flashes red every 5 seconds.

To deactivate Standby mode and restore full operation of the laser, press and release button 4.

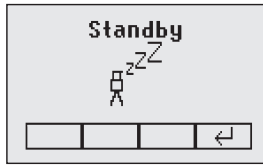

6.7 Start Reference Check



Pic 23
Reference
Check

When working during temperature changes and over long distances the product requires a frequent reference check to maintain accuracy and avoid errors caused by drift. The transmitter will do an automatic upon start up and after 20 minutes of operation. It will repeat the reference check every 60 minutes and when there is a 5°C (9°F) change within the product. When carrying out work where accuracy is paramount it is advised to manually prompt a reference check at regular intervals.

Press and release the MENU button at the Standard Display and select Reference Check (Pic 23).

Pressing and releasing button **4** starts the Reference Check considering the current temperature inside the housing. While the the rotor checks the correct position the rotation will be stopped.

Note: A grade value has to be entered before the unit starts the reference check.

6.8 Setting Menu



Pic 24 Settings

Press and release the MENU button at the Standard Display and select Settings (Pic 24).

Press and release button **4** to open the Setting Menu; select the desired function then press button **4** to open the selected submenu function OR start the selected function.

Please see the Setting Menu details at the end of the user guide.

6.9 Info



Pic 25 Info

Press and release the MENU button at the Standard Display and select Info (Pic 25).

Buttons **6/7** can be used to toggle between GL, RC and Runtime.

Press and release button **4** to confirm the selection.

The GL/RC information (software version, ID, etc.) or the runtime of the GL will be displayed.



Pic 26 Info GL

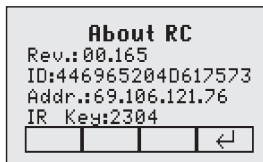

Pic 27 Info RC



Pic 28 Runtimes

6.10 Service



Pic 29
Service

Press and release the MENU button at the Standard Display and select Service (Pic 29). Buttons **6/7** can be used to toggle between **Calibration Y** and **Calibration X** OR **Calibration Z** when set up vertically.

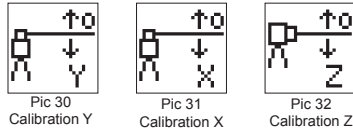

Press and release button **4** to confirm the selection. The calibration at the selected axis starts the field calibration procedure.

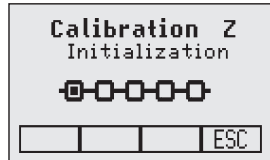
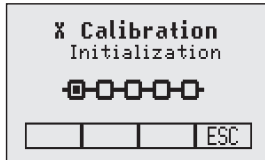
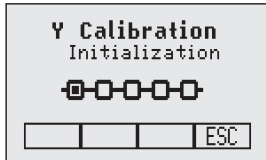

6.11 RC602N Service menu:

6.11.1 RF Connectivity



Pic 33 Radio Connectivity

Press and release button **4** to get a status of the current Radio connectivity (Pic 33).

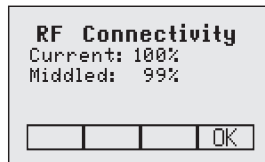

7 Special Features - Vertical Setup

7.1 Line Scan



Pic 34 Line Scan

Line Scan (Pic 34) centers the rotor horizontally and can be used to align the plumb beam to a desired horizontal position. Press and release the MENU button at the Standard Display and select Line Scan. Pressing and releasing button **4** activates the Line Scan mode while the rotor checks the limits of the X- axis and stops at the center position.

Pressing button **3** (ESC) stops the movement and changes the unit into manual mode.

Corrections up and down can be done using button **5/8**; for left/right corrections use button **6/7**.

Press and release the manual button to change the unit back to full automatic mode.

8 Settings



Pic 35 Settings

Press and release the MENU button at the Standard Display and select Settings (Pic 35).

Press and release button **4** to open the Setting Menu; select the desired function then press button **4** to open the selected submenu function OR start the selected function.

The Setting Menu offers the following functions:

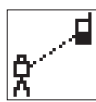

Pairing

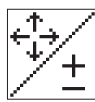

Grade Entry



Grade Display

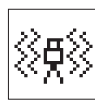

Sensitivity



HI-Alert



User Name



Set Password



Password On/Off



RF-Channel



Select Language

8.1 Pairing



Pic 47 Pairing

Pairing is needed to couple different devices with the laser. The laser is able to communicate with several numbers of other radio network participants and pairing is the process to link these to each other. Buying the laser all devices should be paired but for some reasons this may not be true or the pairing has been lost. So you can pair the devices as described in the following sections.

Note: Make sure that pairing mode is selected only at one transmitter which is within the radio range of the remote during a pairing request. Otherwise pairing procedure can be confused.

8.2 Pairing the laser with remote control

Start with the Laser. When in menu Settings (Pic 35), press and release button 4 to open the pairing menu (Pic 47). The display shows the currently paired units (up to two remotes). Make sure at least one RC slot is free for the remote to be paired. If no free RC slot is available, choose one of them and delete it using button 1 (CLR). Press button 2 to start the pairing process. Continue with the remote choosing the symbol pairing (Pic 47); the pairing starts automatically. After successful pairing, the laser display shows the ID of the remote in the pairing list.

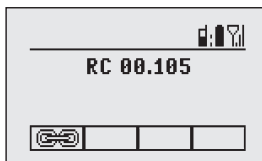
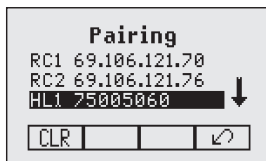

8.3 Pairing the laser with receiver HL760

To pair the transmitter and the receiver select Settings and press and release button 4 to open the Pairing menu (Pic 47). The display shows the currently paired units (up to 2 receivers). If already 2 receivers have been paired, one or both of them have to be deleted using button 1 (CLR).

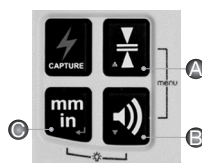
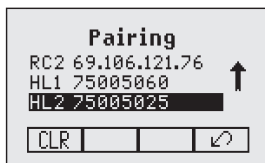

Next, turn on the receiver then press and hold the Deadband (A) and the Audio (B) buttons for two seconds. After two seconds the display shows MENU first, then RDIO.

Press and release the Units (C) button – display shows the current radio mode.



If not already set to **LS**, press Units button and then press Deadband or Audio button until **LS** is displayed. Press Units button again to enter selection. Press and release the Audio button – display shows PAIR. Press the Units button again – the display shows PAIR and a rotating bar. After completing PAIR, OK will be displayed. The GL6X2N pairs now automatically with the new receiver. Press and release the Power button two times to exit the menu. A laser symbol is lit to confirm the receiver can communicate with the laser.

8.4 Pairing the laser with the signal transporter (ST802/ST805)

Make sure the ST802/ST805 is switched off. Start with the Laser. When in menu Settings (Pic 35), press and release button 4 to open the pairing menu (Pic 47). The display shows the currently paired units (one signal transporter max). Make sure the ST slot is free for the signal transporter to be paired. If the slot is not free, choose the ST slot and delete it using button 1 (CLR). Press button 2 to start the pairing process. Switch on the signal transporter. The signal transporter pairs automatically with the laser. If the pairing was successful the address or ID of the paired ST is shown in the pairing list; also the signal transporter shows a solid blinking yellow status LED.

8.5 Grade Entry



Pic 48
Grade Entry

Select the Grade Entry icon (Pic 48) and press and release button 4 to open the Grade Entry menu.

Buttons **6/7** can be used to toggle between Step and Go (Pic 49) and Digit Select (Pic 50).

Press and release button 4 to confirm the selection.



Pic 49
Step and Go



Pic 50
Digit Select

8.6 Grade Display



Pic 52
Grade Display

Select the Grade Display icon (Pic 52) and press and release button 4 to open the Grade Display menu.

The desired Grade Display Mode (Percent (Pic 52)/ Per mille (Pic 53)/Degree (Pic 54)) can be selected using the buttons **6/7**. Press and release button 4 to confirm the selected display mode.



Pic 52
Percent



Pic 53
Per mill



Pic 54
Degree

8.7 Sensitivity Selection



Pic 56
Sensitivity

Select the Sensitivity icon and press and release button 4 to open the Sensitivity menu (Pic 56).

The desired Sensitivity: Low (Pic 56), Mid (Pic 57) (Default) and High (Pic 58)) can be selected using the buttons **6/7**. Press and release button 4 to confirm the selected Sensitivity.



Pic 56 Low



Pic 57 Mid



Pic 58 High

8.8 HI-alert Selection



Select the HI icon (Pic 59) and press and release button **4** to open the HI-alert menu. The desired HI-alert: 5 min.(Pic 60); Default), 30 seconds (Pic 61) and HI-Off (Pic 62) can be selected using the buttons **6/7**. Press and release button **4** to confirm the selected HI-alert.

Pic 59 Hi Alert



Pic 60 HI-alert
5 minutes



Pic 61 HI-alert
30 seconds



Pic 62 HI-alert
OFF

8.9 User Name



Pic 64
User Name

Select the User name icon (Pic 64) and press and release button **4** to open the User name menu. One row for typing names in big font (15) and one row in small font (18) for letters or numbers are available. Button **5** and **8** can be used to toggle between both rows. Changing the characters can be done using the buttons **1** and **2**. Press and release button **4** to confirm the selected user name. The display falls back to the main menu. Any time the unit will be powered up, the User info will be displayed for couple seconds.



8.10 Set Password



Pic 65 Set
Password

“Set password” can be used to define a key that is requested during the unit powering up. This can prevent the unauthorized usage of the transmitter. Enter Menu -> Settings -> Set Password. Select the Set Password icon (Pic 65) and press and release button 4 to open the Password menu. Use Button 1 to 8 to type in a password containing of 4 digits and repeat the password at the second row. (Pic 66) Press and release button 4 to store the selected password; unit falls back to the standard menu. After powering up the unit, the standard display comes up if the correct password has been entered, otherwise the unit turns off automatically.

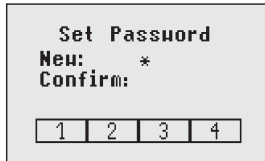

Pic 65 Set Password

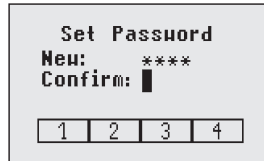

Pic 66 Confirm Password

8.11 Password On/Off



Pic 68 Password
On/Off

Select the Set Password ON-Off icon (Pic 68) and press and release button **4** to open the Password menu. Buttons **6/7** can be used to toggle between Password On (Pic 68) and Password Off (Pic 69) if a Password has been entered before. Press and release button **4** to confirm the selection.



Pic 68 Password
On



Pic 69 Password
Off

8.12 Radio (RF) Channel



Pic 71
RF Channel

In the RF Channel menu the user can change the radio channel. This may help to overcome some radio connectivity issues based on heavy radio traffic at the job site. In the menu "Settings" (Pic 35) select the RF Channel icon (Pic 71) and press and release button 4 to open the Radio Channel menu (Pic 71). The RF channel selection dialog contains six radio channels. Choose one channel and press and release button 4 to confirm the selected radio channel.

Note: After changing the RF channel, the RC, HL and ST needs to be paired again.

Note: To achieve the best radio performance, it is recommended to use the products in a height of app. 1m using a tripod or similar items.



8.13 Select Language



Pic 72
Language

Select the Language icon (Pic 72) and press and release button 4 to open the Language menu. Use button 5 to 8 to select the required local language (EN, DE, IT, FR, ES, PT, NL, DA, NO, SV, FI, PL, TR, CZ). Press and release button 4 to store the selected Language; unit falls back to the standard menu.

9 CALIBRATION

9.1 Checking Calibration of the Y- and X-Axes

1. Set up the laser 30 m (100 ft) from a wall and allow it to level.
2. Set the grade to 0.000% in both axes.
3. Raise/lower the receiver until you get an on-grade reading for the +Y axis. Using the on-grade marking notch as a reference, make a mark on the wall.

Note: For increased precision, use the super fine-sensitivity setting (1.0 mm/ 1/16 in.) on the receiver.

4. Rotate the laser 180° (-Y axis toward the wall) and allow the laser to re-level.
5. Raise/lower the receiver until you get an on-grade reading for the -Y/axis. Using the on-grade marking notch as a reference, make a mark on the wall.
6. Measure the difference between the two marks. If they differ more than 3 mm at 30 m (1/8 inch at 100 feet), the laser needs calibrating.
7. After checking the Y-axis, rotate the laser 90°. Repeat the above starting with the + X axis facing the wall.

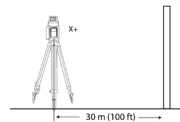
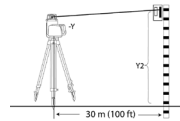
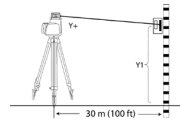

9.2 Checking Calibration of the Z-(vertical) Axis

To check vertical calibration, you need a plumb bob with at least 10m (30ft) of string.

1. Suspend the plumb bob in front of a house i.e., attached to a window frame whose window height is at least 10m (30ft).
2. Set up the laser in vertical so that the laser beam strikes the receiver's on-grade position at the top of the string.
3. Look for any deviation using the receiver from the top of the string to the bottom of it. If the deviation is more than 1mm (<1/16 in.), the vertical axis needs calibrating.

10 Troubleshooting

Any error message can be deleted with a short press of button 4 (OK). The table shows the related description and possible solutions. The next service center should be contacted if a different error message as shown at the table will be displayed.

Error codes	Description	Solution
21	Temporary EEprom problem	Repeat pairing and re-enter the customer settings
120	HI alert - Unit Height changed	Check laser beam elevation after deleting the HI alert
130	Mechanical Limit during Axis Alignment, Grade Match or Spot Match	Re-align the closer to the alignment point; check if existing slope is above +/-25%
131	Rake Angle Limit	Re-align the unit closer to the alignment point
140	Laser beam blocked	Make sure there are no obstacles between the transmitter and the HL760
141	Time Out - Function could not be completed in the allowed time	Check radio operating range/ connection; check stable laser setup
150	No receiver - Receiver not available for single axis automatic function	Make sure the receiver is on and paired
152	No receiver - The laser searched for the receiver but could not find it	Check the operating range for auto function and restart the auto alignment
153	Lost Receiver - The laser searched and found the receiver but then lost it	Check the operating range for auto function and restart the auto alignment
160	X or Y level sensor defect	Contact service center

11 PROTECTING THE UNIT

Do not expose the unit to extreme temperatures or temperature changes (do not leave inside the car). The unit is very robust and can resist damage if dropped even from tripod height. Before continuing your work, always check the leveling accuracy. See Checking Calibration section. The laser is water proof and can be used indoors and outdoors.

12 CLEANING AND MAINTENANCE

Dirt and water on the glass parts of laser or prism will influence beam quality and operating range considerably. Clean with cotton swabs. Remove dirt on the housing with a lint-free, warm, wet and smooth cloth. Do not use harsh cleansers or solvents. Allow the unit to air dry after cleaning it.

13 PROTECTING THE ENVIRONMENT

The unit, accessories and packaging ought to be recycled. This manual is made of non-chlorine recycling paper. All plastic parts are marked for recycling according to material type.



Do not throw used batteries into the garbage, water or fire. Remove them in compliance with environmental requirements.

Notice to Our European Union Customers

For product recycling instructions and more information, please go to:

http://www.trimble.com/Corporate/Environmental_Compliance.aspx

Instructions for Return to ERFC:

- WEEE is to be shipped to the ERFC, clearly stating WEEE on the delivery note and / or packaging
- Specific product number and serial number information is not required
- Additional return authorisation from Trimble Support is not required
- Delivery Address:

Trimble Europe B.V. WEEE Recycling
C/O Menlo logistics
Gate 19 to 26
Meerheide 43
5521 DZ
Eersel
The Netherlands



Confirmation of receipt of the returned WEEE will not be provided by the ERFC

14 Warranty

Trimble warrants the GL622N/GL612N to be free of defects in material and workmanship for a period of 5 years. Trimble or its authorized service center will repair or replace, at its option, any defective part, or the entire product, for which notice has been given during the warranty period. If required, travel and per diem expenses to and from the place where repairs are made will be charged to the customer at the prevailing rates. Customers should send the product to Trimble Inc. or the nearest authorized service center for warranty repairs or exchange, freight prepaid. Any evidence of negligent, abnormal use, accident, or any attempt to repair the product by other than factory-authorized personnel using Trimble certified or recommended parts, automatically voids the warranty. Special precautions have been taken to ensure the calibration of the laser; however, calibration is not covered by this warranty. Maintenance of the calibration is the responsibility of the user. The foregoing states the entire liability of Trimble regarding the purchase and use of its equipment. Trimble will not be held responsible for any consequential loss or damage of any kind. This warranty is in lieu of all other warranties, except as set forth above, including any implied warranty merchantability of fitness for a particular purpose, are hereby disclaimed.

This warranty is in lieu of all other warranties, expressed or implied.

15 TECHNICAL DATA

15.1 GL622N/GL612N

Leveling accuracy ^{1,3} :	± 0.5 mm/10 m, 1/16" @ 100 ft, 10 arc seconds
Grade accuracy ^{1,3} :	± 1.0 mm/10 m, 1/8" @ 100 ft, 20 arc seconds
Grade temperature drift sensitivity:	± 0,3 mm / 10 m / 1°C; 1/16" @ 310 ft. @ 1°F
Rotation:	300, 600, 750 rpm
Operational area ^{1,2} :	appr. 400 m (1300 feet) radius with detector
Laser type:	639 nm
Laser class:	class 2
Self-leveling range:	appr. ± 14°
Grade range (Y, X-GL622N):	± 25% both axes (not simultaneously)
Leveling indicators:	LCD indications and LED flashes
Radio range (HL760) ^{1,2,4} :	up to 150 m (490 ft)
Power source:	4 x 1,5 V D alkaline batteries or NiMH battery pack
Battery life ¹ :	35 hours NiMH; 40 hours alkaline
Operating temp.:	-20°C to 50°C (-4°F to 122°F)
Storage temp.:	-20°C to 70°C (-4°F to 158°F)
Tripod attachments:	5/8 x 11 horizontally and vertically
Dust and Water proof:	IP67
Weight:	3.1 kg (6.8 lbs)
Low voltage indication:	LCD battery indicator
Low voltage disconnection:	unit shuts off

15.2 Remote Control RC602N

Radio Operating range ^{1,2,4} :	up to 150 m (490 ft)
Power source:	2 x 1.5V AA alkaline batteries
Battery life ¹ :	130 hours
Dust and Water proof:	IP66
Weight:	0.26 kg (0.4 lbs)

1) at 21°Celsius

2) under optimal atmospheric circumstances

3) along the axis

4) Height of instruments 1m (e.g. with tripod)

16 DECLARATION OF CONFORMITY

We

Trimble Kaiserslautern GmbH

Declare under our sole responsibility that the products

GL622N/GL612N and RC602N

To which this declaration relates is in conformity with the following standards:

EN 50371:2002, EN 60825-1:2014, ETSI EN 300328 V1.7.1:2006, ETSI EN 301489-1 V1.9.2:2011, ETSI EN 301489-3 V1.4.1:2002

following the provisions of directive **R&TTE 1999/5/EC**.

The managing director

17 ELECTRO-MAGNETIC COMPATIBILITY

Compliance statement (part 15.19) This device complies with part 15 of the FCC Rules and Industry Canada licence-exempt RSS standard(s). Operation is subject to the following two conditions: (1) this device may not cause harmful interference, and (2) this device must accept any interference received, including interference that may cause undesired operation. Warning (part 15.21) Changes or modifications not expressly approved by the party responsible for compliance could void the user's authority to operate the equipment. This in particular is applicable for the antenna which has been delivered with the GL622N/ GL612N and RC602N Under Industry Canada regulations, this radio transmitter may only operate using an antenna of a type and maximum (or lesser) gain approved for the transmitter by Industry Canada. To reduce potential radio interference to other users, the antenna type and its gain should be so chosen that the equivalent isotropically radiated power (e.i.r.p.) is not more than that necessary for successful communication. ELECTRO-MAGNETIC COMPATIBILITY



Call Us 1.877.571.7901