

LP51, LP51G Laser Pointer User Guide



Introduction

Thank you for choosing the Spectra Precision® LP51 or LP51G laser from the Trimble® family of precision handheld lasers. This simple-to-use tool allows you to transfer points between the floor and ceiling and to establish 90° points for laying out wall lines and putting up wall partitions. You can also use the laser for other applications where true plumb, square, and level setups are required.

Before using the laser, be sure to read this operator's manual carefully. Included in it is information about setting up, using, and maintaining the laser. Also included in this manual are **CAUTIONS** and **Notes**. Each of these words represents a level of danger or concern. A **CAUTION** indicates a hazard or unsafe practice that could result in *minor* injury or property damage. A **Note** indicates important information unrelated to safety.

Your comments and suggestions are welcome; please contact us at:

Trimble - Precision Tools
5475 Kellenburger Road
Dayton, Ohio 45424 U.S.A.
Phone: (937) 203-4419
(888) 527-3771
Internet: www.spectralasers.com

Features

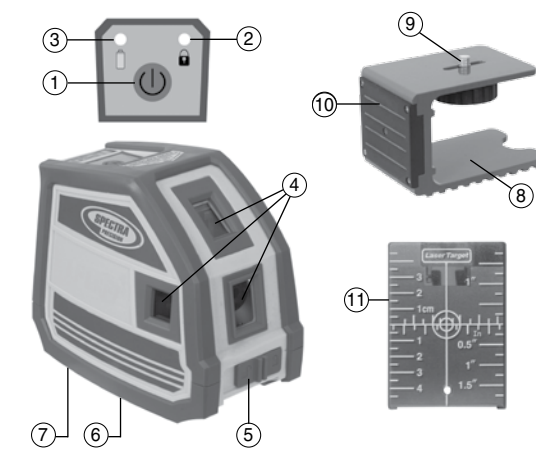

- | | |
|--|---|
| 1. Power button | 7. Battery Door |
| 2. Manual Mode / Compensator Lock On LED | 8. Mounting Bracket (1213-0100) |
| 3. Power On / Low Battery LED | 9. ¼ x 20 Mounting Knob – Sliding |
| 4. Laser Exit Windows | 10. Magnets |
| 5. Compensator Lock / Manual Mode Switch | 11. Ceiling / floor target LP51 - Red (23416) |
| 6. ¼ x 20 Mounting Thread | LP51G - Green (1215-1560) |

Installing/Removing the Batteries

CAUTION: The batteries should be removed when storing the laser more than 30 days.



1. Low Battery is indicated by the Power On / Low Battery LED changing from GREEN to RED.
 2. Release the battery door latch using your fingers, a coin, or a screwdriver. Open the door.
 3. Install/remove the AA batteries.
- NOTE: When installing the batteries, be sure to note the positive (+) and negative (-) diagrams molded on the battery housing.
4. Close the battery door and latch it shut.

Battery Disposal

Some areas have regulations regarding the disposal of batteries. Be sure to dispose of discharged batteries properly.



www.spectralasers.com



- 2 -

Applications

General Leveling and Aligning

1. Place the laser on a flat surface. The laser must be level within its self-leveling range.
2. Adjust the position of the beams so they are at the desired positions.
3. Mark the position of the wall, elevation, floor or ceiling.



Installing and Plumbing a Wall

1. Place the laser so the Plumb-Down Beam is positioned over the desired wall location.

NOTE: If the floor track is already installed the laser should be placed on the Mounting Bracket (0002-3470) to clear the floor track and to position the Plumb-Down Beam over the edge of the track. Magnets are provided on the Mounting Bracket to hold the assembly to the floor track if desired.

2. Use the Plumb-Up Beam to position the top track.

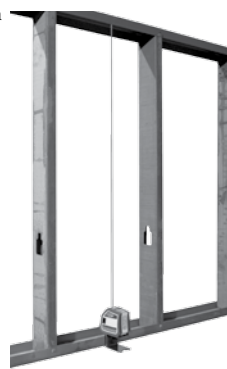

1 m (4 ft) Marks

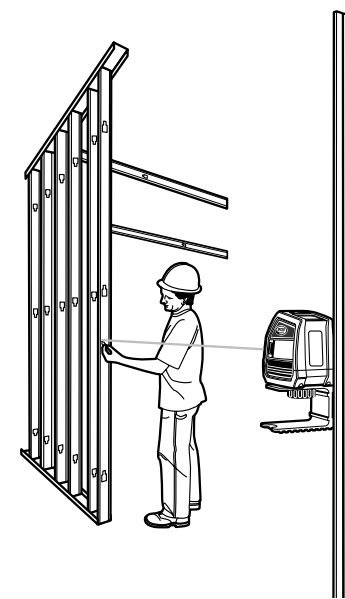

Over Tall Floor Track or Obstacles with U-Mount

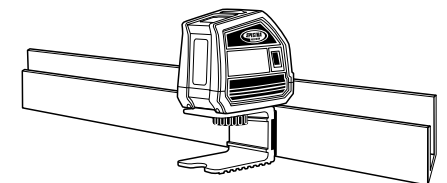

Elevations with ¼ x 20 Tripod Mount



Basic Operation

1. Unlock the laser's compensator by sliding the switch to the LEFT.

NOTE: For added mechanism protection always lock the laser when not in use by sliding the switch to the RIGHT.

2. Press the POWER button - the Power On / Low Battery LED illuminates GREEN. When the unit is tilted out of its self-leveling range the laser beams will blink 2 times per second.
3. The laser can be taken out of automatic self-leveling mode and placed in MANUAL mode to perform slope work by locking the laser's compensator (slide the switch to the RIGHT). In MANUAL mode the Manual Mode / Compensator Lock LED will flash RED.
4. When the batteries need changed the Power On / Low Battery LED changes to RED.
5. To turn OFF the laser, Press the POWER button again.

- 5 -

Specifications

| | |
|--|---|
| Level & Up Beam Accuracy ^{1,2} | ± 3 mm @ 10 m (± 3/16 in. @ 50 ft) |
| Down Beam Accuracy ^{1,2} | ± 4 mm @ 10 m (± 1/4 in. @ 50 ft) |
| Square Beam Accuracy ^{1,2} | ± 3 mm @ 10 m (± 3/16 in. @ 50 ft) |
| Self-Leveling Range | ±4° from level |
| Out-of-Level Indicator | Beam flashes |
| Working Range ³ | Up to 30 m (100 ft) |
| Laser Class | LP51G - 2 / LP51 - 3R, 3A |
| Laser Type | 520 -635 nm |
| Beam Shape | Square |
| Battery Type | 2 AA alkaline |
| Battery Life ¹ | LP51 - 20 hrs; LP51G - 10 hrs |
| Low Battery Indicator | Power/Low Battery LED changes to Red |
| Manual Mode and Compensator Lock Indicator | LED On and beam flashes |
| Operating Temperature Range | -10 °C to 45 °C (14 °F to 113 °F) |
| Size H x L x W | 90 x 104 x 61 mm (3.54 x 4.09 x 2.40 in.) |
| Weight | 0.31 kg (0.69 lb) |

1) at 21° C (70° F)
2) along the axis
3) depending on ambient conditions

- 9 -

Maintenance and Care

You will get years of service from your laser by following the maintenance and care recommendations in this manual. However well the product is designed, mishaps do occur and the most common problems associated with these are covered in the following areas. Any damage to the laser caused by improper maintenance and care voids the warranty.

Handling Precautions

When transferring the laser from a very low temperature to a warmer environment or visa versa, always allow time for the laser to reach the new temperature before using. Allowing this time is especially important when transferring the laser from an extremely heated/cold vehicle to the job site.

- 6 -

System Cleaning

For maximum performance and accuracy always keep the lenses clean. When cleaning, apply very light pressure and use only a good quality glass cleaner on a soft cloth to clean the exterior of the laser and its lenses.

CAUTION: A dry cloth or abrasive organic cleaner could scratch or damage these surfaces.

CAUTION: Do not submerge the laser.

- 7 -

Storage

When you're not using the laser, store it in its pouch/carrying case.

CAUTION: Do not store the laser in a wet pouch/carrying case. If the pouch/carrying case gets wet, let it dry before storing the laser in it.

CAUTION: The batteries should be removed when storing the laser more than 30 days.

Battery Disposal

Some states and local areas have regulations regarding the disposal of batteries. Be sure to dispose of discharged batteries properly.

- 8 -



Call Us 1.877.571.7901

- 11 -

- 10 -

- 12 -

Calibration

Before each use, be sure to check the pocket laser for signs of damage. If the laser has been dropped or subjected to other rough treatment, it should be checked for accuracy.

Checking Accuracy—Plumb

1. Press the power button.

2. Place the laser so that its down beam is over a reference mark on the floor.

3. Locate the position of the up beam on the ceiling and make a mark.



- 13 -

Checking Level to Square Beam 90° Calibration

Refer to the graphic for the location of the laser at each step and for the location of the marks made at each step. All marks can be made on the floor by placing a target in front of the level or square beam and transferring the location to the floor.

1. Find a room at least 10 m (35 ft) long. Mark a point (A) on the floor at one end of the room.

2. Set up the laser so that its down beam is over point A. Make sure the level beam points toward the far end of the room.

3. Mark a point (B) on the floor at the center of the room using a target to transfer the level beam location to the floor.

4. Mark a point (C) on the far wall or transfer the level beam location to the floor.

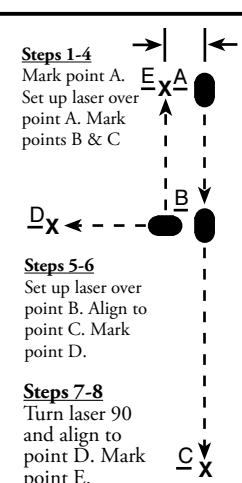

- 17 -

Laser Safety

Use of this product by people other than those trained on this product may result in exposure to hazardous laser light.

- Do not remove warning labels from the unit.
- LP51G is a Class 2 laser product (< 1mW; 520-635 nm).
- LP51 is Class 3A/3R (< 5mW; 635 nm).
- Never look into the laser beam or direct it to the eyes of other people.
- Always operate the unit in a way that prevents the beam from getting into people's eyes.

LP51 NOTE: It is required to post a Laser Safety Sign and to read, sign and carry a Laser Operator's Card when this laser is operated in public places. To download and print the required materials please visit our website at www.spectralasers.com



- 21 -

4. Rotate the laser 180° and realign the down beam over the reference mark on the floor.

5. Locate the position of the up beam on the ceiling, which will be twice the actual error, and make a mark.

6. Measure the difference between the two marks on the ceiling, which will be twice the actual error. If the difference is more than 6 mm in 10 m (1/4 inch in 30 ft), the laser must be serviced at an authorized service center.

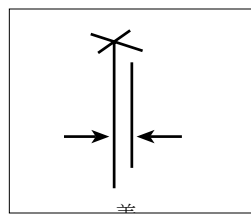

- 14 -

5. Move the laser to point B and align the level beam to point C again.

6. Mark the location of the square beam (D) on the floor.

Note: To ensure accuracy, the distances from A to B, B to C, and B to D should be equal.

7. Turn the laser 90° so that the level beam aligns with point D.

8. Mark the location of the square beam (E) on the floor as close as possible to point A.

9. Measure the distance between points A and E. If the measurement is greater than the values shown below, the laser must be serviced at an authorized service center.

| Room length or distance between points A and C | The 90° angle between the level beam and square beam is out of calibration if the distance between points A and E is: |
|--|---|
| 10 m (35 ft) | >9.0 mm (3/8 in.) |
| 20 m (70 ft) | >18.0 mm (3/4 in.) |

- 18 -

Warranty

Trimble warrants the LP51 and LP51G to be free of defects in material and workmanship for a period of three years. Trimble or its authorized Dealer or service center will repair or replace, at its option, any defective part, or the entire product, for which notice has been given during the warranty period. This warranty period is in effect from the date the system is delivered by Trimble or its authorized Dealer to the purchaser, or is put into service by a Dealer as a demonstrator or rental component.

Trimble or its Authorized Service Center will repair or replace, at its option, any defective part or components of which notice has been given during the warranty period.

Customers should send products to the nearest Authorized Factory, Dealer, or Service Center for warranty repairs, freight prepaid. In countries with Trimble Service Subsidiary Centers, the repaired products will be returned to the customer, freight prepaid.

Any evidence of negligent, abnormal use, accident, or any attempt to repair equipment by other than factory-authorized personnel Trimble certified or recommended parts, automatically voids the warranty.

Special precautions have been taken to ensure the calibration of the laser; however, calibration is not covered by this warranty. Maintenance of the calibration is the responsibility of the user.

- 22 -

Checking Accuracy—Level

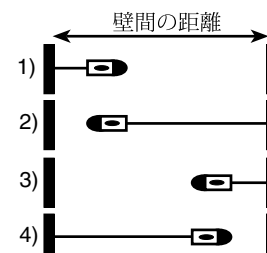

1. In an area with at least 6 m (20 ft) between two parallel walls, place the laser 50–75 mm (2–3 in.) from one wall, facing the wall.

2. Press the power button.

3. Locate the position of the level beam on the wall and make a mark.

4. Rotate the laser 180° so that the laser faces the other wall.

5. Locate the position of the level beam on the wall and make a mark.

6. Move the laser to the far wall, facing the wall.

- 15 -

Request for Service

Our goal is to provide prompt and efficient service through competent service dealers. To locate your local dealer or authorized Trimble Service Center, contact our world centers listed below.

North & Latin America

Trimble - Precision Tools
5475 Kellenburger Road
Dayton, Ohio 45424
U.S.A.
(888) 527-3771 (Toll Free)
+1-937-203-4419 Phone
+1-937-233-9004 Fax

Europe

Trimble Kaiserslautern GmbH
Am Sportplatz 5
67661 Kaiserslautern
GERMANY
+49-06301-71 14 14 Tel
+49-06301-32213 Fax

Africa & Middle East

Trimble Export Middle-East
P.O. Box 17760
Jebel Ali Free Zone, Dubai
UAE
+971-4-881-3005 Phone
+971-4-881-3007 Fax

Asia-Pacific

Trimble Navigation
Australia PTY Limited
Level 1/120 Wickham Street
Fortitude Valley, QLD 4006
AUSTRALIA
+61-7-3216-0044 Phone
+61-7-3216-0088 Fax

China

Trimble Beijing
Room 2805-07, Tengda Plaza,
No. 168 Xiwai Street
Haidian District
Beijing, China 100044
+86 10 8857 7575 Phone
+86 10 8857 7161 Fax
www.trimble.com.cn

- 19 -

7. Adjust the laser's height until the beam is superimposed over the mark made in step 5.

8. Without changing the height of the laser, rotate it 180° to place the beam near the mark on the first wall (step 3).

9. Measure the vertical distance between the beam and the mark made in step 3. If the measurement is greater than the values shown below, the laser must be serviced at an authorized service center.

| Distance Between Walls | Measured Value |
|------------------------|--------------------|
| 6 m (20 ft) | 3.0 mm (1/8 in.) |
| 12 m (40 ft) | 6.0 mm (1/4 in.) |
| 18 m (60 ft) | 8.0 mm (5/16 in.) |
| 24 m (80 ft) | 11.0 mm (7/16 in.) |

- 16 -

Notice to Our European Union Customers

For product recycling instructions and more information, please go to: www.trimble.com/environment/summary.html

Recycling in Europe

To recycle Trimble WEEE, call: +31 497 53 2430, and ask for the "WEEE associate," or

mail a request for recycling instructions to:
Trimble Europe BV
c/o Menlo Worldwide Logistics
Meerheide 45
5521 DZ Eersel, NL



- 20 -



Trimble - Precision Tools
5475 Kellenburger Road
Dayton, Ohio 45424 U.S.A.

www.spectralasers.com



© 2017, Trimble Inc. All rights reserved.
Reorder PN 1213-2030 Rev. B (10/17)

- 23 -