

Technical Specifications

see p.4 for IMC components

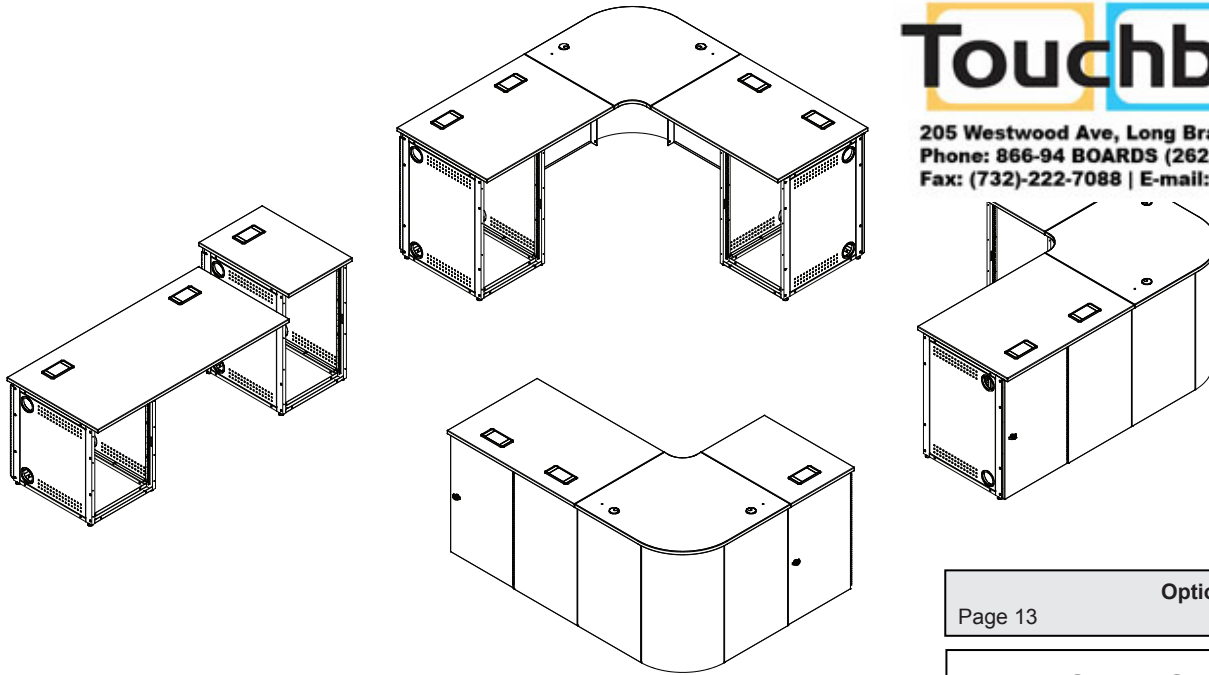

205 Westwood Ave, Long Branch, NJ 07740
Phone: 866-94 BOARDS (26273) / (732)-222-1511
Fax: (732)-222-7088 | E-mail: sales@touchboards.com



A modular system offers the greatest flexibility in addressing classroom needs. Spectrum's Instructor's Media Console offers combinations for every classroom solution. Just as every classroom has different requirements, the IMC can be reconfigured accordingly to help manage many needs. Spectrum's wide array of rack rail options can be used to complement any A/V arrangement with the IMC. Even special ergonomic needs are addressed with two standard worksurface heights. Don't let your educational capabilities be handcuffed to classroom furniture! With Spectrum's IMC system, you can define your classroom needs and then configure your furniture to support those needs. Create a one-of-a-kind console that will inspire your students to achieve greatness.

Features and Benefits

- Modular design and wide variety of optional accessories allow easy configuration for every customer and environment
- Scratch and impact-resistant 1 $\frac{1}{16}$ " high-pressure laminate worksurface
- Worksurface provides ample room for papers, laptops, projectors, and most peripherals
- Rack-rail equipment mounting
- Lockable access doors provide security and quick-access to the front and rear of the console making it easy to maintain audio, video, and multi-media equipment
- Power / Communication module cutout in worksurfaces (cover included)
- Side equipment rack grommet holes and worksurface grommets provide superior cord management
- Ventilated equipment rack side panels keep equipment cool
- Optional locking front doors can be mounted to swing from the left or right-hand side of the equipment rack
- Leveling glides keep unit level on uneven surfaces
- Warranted to be free of all defects in materials and workmanship with a 10-year warranty

Construction

- The worksurface is constructed from 1 $\frac{1}{16}$ " thick NAUF (No Added Urea Formaldehyde) composite board with .030 high-pressure laminate on one face, and a balancing phenolic backer on the opposing face
- Worksurface edges are finished with black 3mm PVC edge band
- Equipment racks are made of welded, 1" x 1" and 1" x 2" rectangular 16-gauge steel tubing
- Equipment rack side panels are 20-gauge steel
- Curved and filler panels are 16-gauge steel
- Front and rear doors have full-length piano hinges
- All metal components are finished with a powder coat epoxy
- IMC components are shipped knocked-down (KD) and require assembly

Options & Accessories

Page 13

Color Options

Standard laminate / color combinations

Wild Cherry / Black (CHB)



Grey Chromatix / Dark Grey (CD)



Grey Chromatix / Black (CB)



Fusion Maple / Black (FMB)



Indigo Organix / Dark Gray (ID)



Indigo Organix / Black (IB)



Standard color combination refers to the quickest deliverable product color combination. Custom laminates and color combinations are available-additional lead-times and up-charges may apply. Call 1-800-235-1262 for further information.

Specifications

Worksurface heights	29"H or 36"H
Worksurfaces	Single: 21 $\frac{3}{16}$ "W x 30"D Double: 42 $\frac{3}{16}$ "W x 30"D Triple: 63 $\frac{9}{16}$ "W x 30"D
Standard rack rail	14RU - (29"H) 18RU - (36"H)
Power / Comm module cutout	7 $\frac{13}{64}$ "W x 3 $\frac{7}{8}$ "D
Shipping weight (nominal)	(See console components on p.4)
Meets or exceeds applicable ANSI-BIFMA test standards	

Specifications subject to change without notice

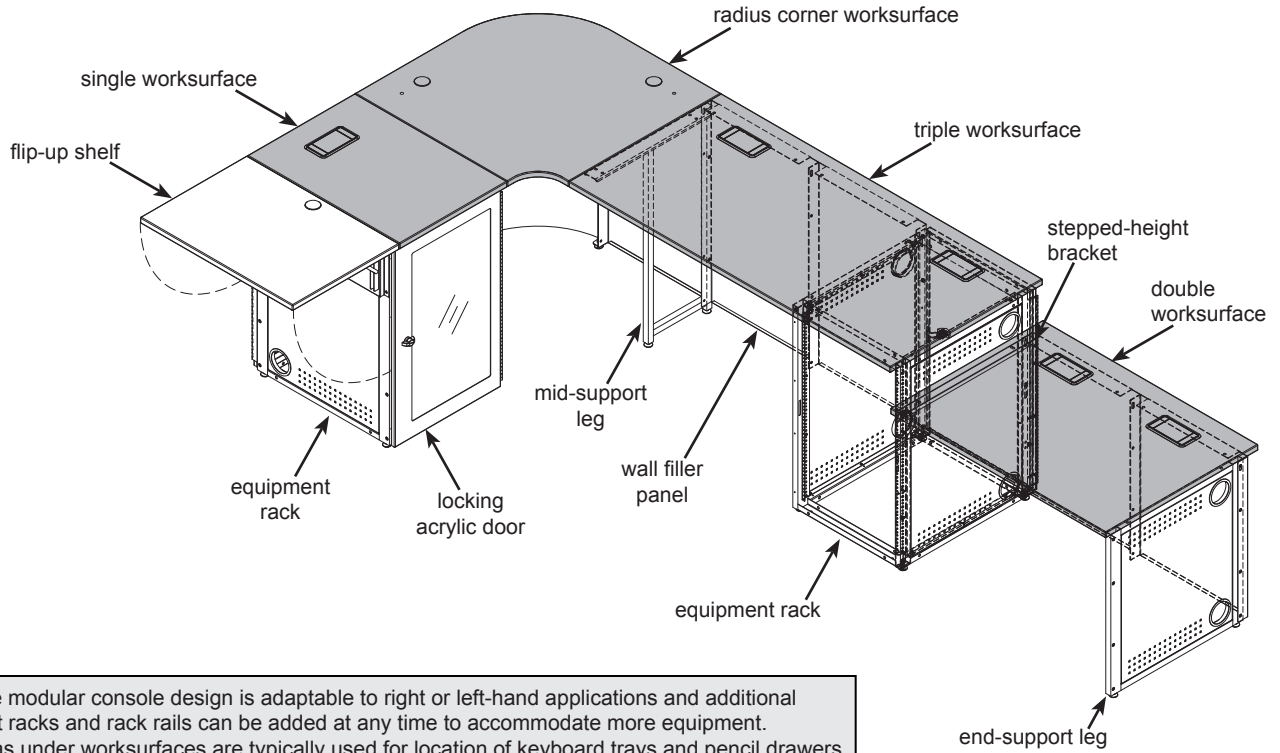

Note: The modular console design is adaptable to right or left-hand applications and additional equipment racks and rack rails can be added at any time to accommodate more equipment. Open areas under worksurfaces are typically used for location of keyboard trays and pencil drawers.

Plastic worksurface grommets can be replaced with 7 $\frac{1}{8}$ "W x 3 $\frac{5}{8}$ "D Power / Comm Module

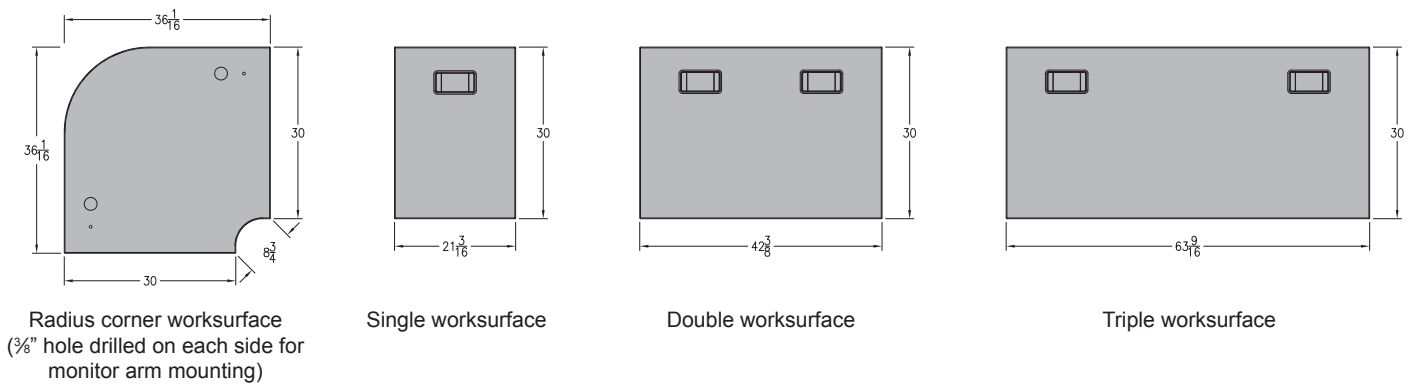

Note: Modified worksurface cutouts should be reviewed by Spectrum to ensure clearance of brackets, keyboard slides, or other objects under the worksurface.

Worksurface Support Guidelines

For adequate support, areas under worksurfaces generally should not exceed a span of more than 2 open spaces (or wall filler panels) wide.

- When a radius corner is used with two double worksurfaces that have equipment rack support, a mid-support leg usually is not necessary
- When a radius corner is next to a double worksurface, an equipment rack or mid-support leg should be used to support the double worksurface
- When a triple worksurface is specified, at least one equipment rack should be used underneath to provide adequate support
- Mid-support legs are used at the joint connection of two worksurfaces
- End-support legs are used at the end of a worksurface

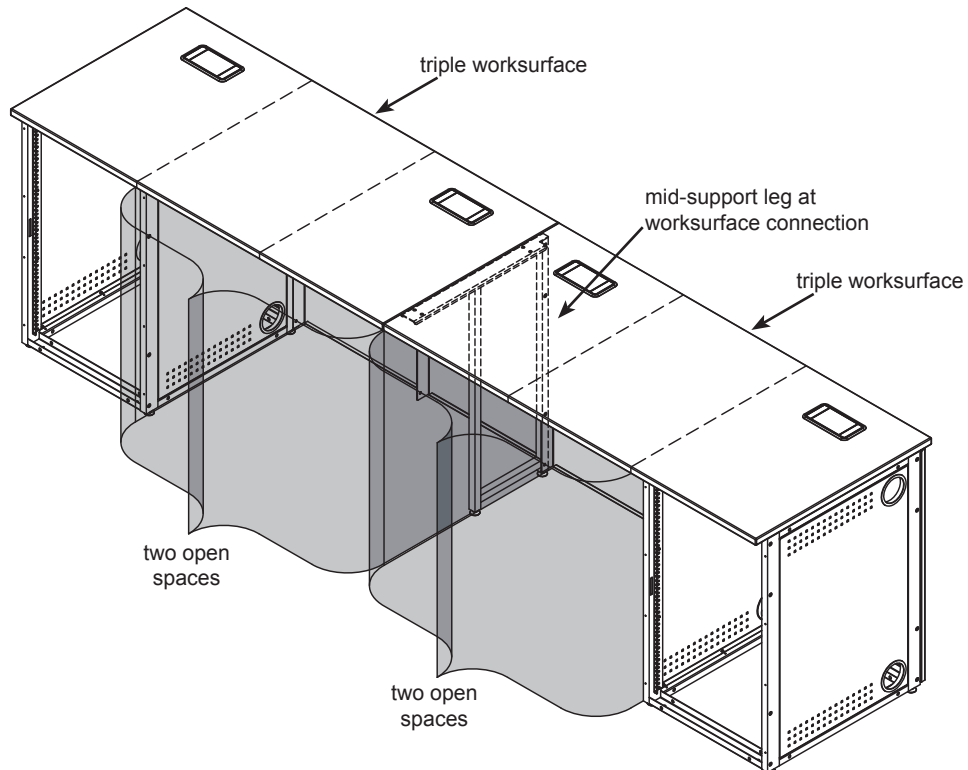
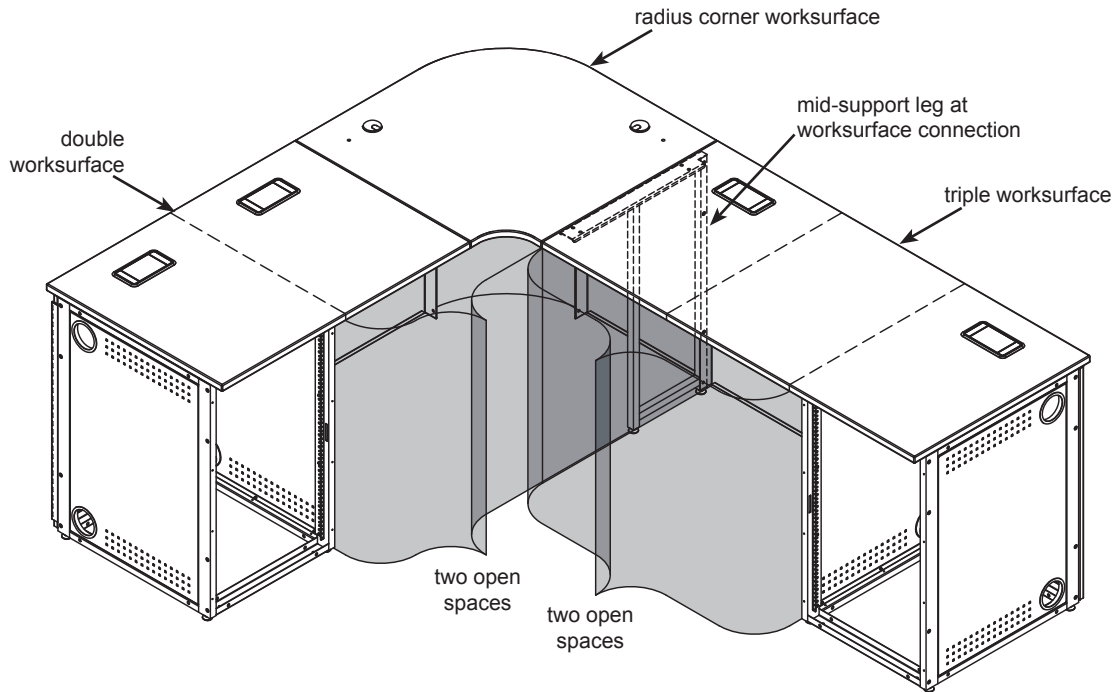

Instructor Media Console Components

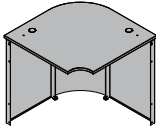
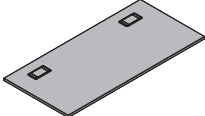
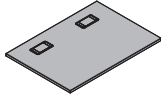
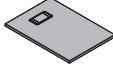
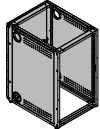
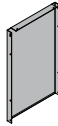
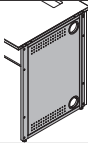
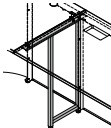
	Product #	Description	Dimensions	Weight (lbs)
	68156	36H Radius Corner	36"W x 36"D x 36"H	135
	68106	29"H Radius Corner	36"W x 36"D x 29"H	130
	68202	Triple worksurface	63 $\frac{3}{16}$ "W x 30"D x 1"H	65
	68201	Double Worksurface	42 $\frac{3}{16}$ "W x 30"D x 1"H	46
	68200	Single Worksurface	21 $\frac{3}{16}$ "W x 30"D x 1"H	28
	68157	36" Equipment Rack	21 $\frac{3}{16}$ "W x 30"D x 36"H	64
	68107	29" Equipment Rack	21 $\frac{3}{16}$ "W x 30"D x 29"H	50
	68151	36" Wall Filler Panel	21 $\frac{3}{16}$ "W x 1"D x 36"H	18
	68101	29" Wall Filler Panel	21 $\frac{3}{16}$ "W x 1"D x 29"H	15
	68155	36" End-Support Leg	1"W x 30"D x 36"H	20
	68105	29" End-Support Leg	1"W x 30"D x 29"H	16
	68154	36" Mid-Support Leg	1"W x 24"D x 28"H	11
	68104	29" Mid-Support Leg	1"W x 24"D x 21"H	9

29" equipment rack
section view

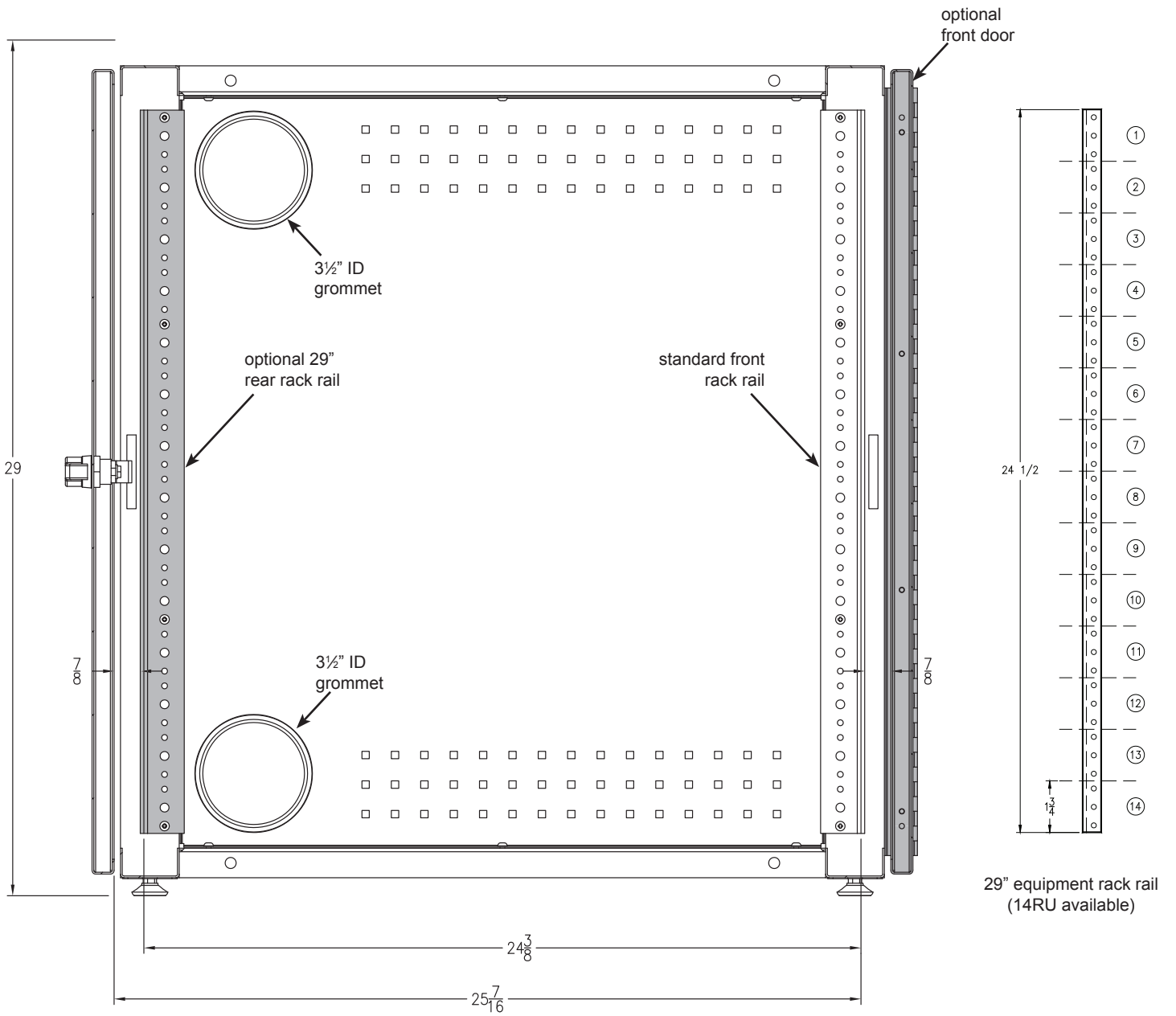

36" equipment rack
section view

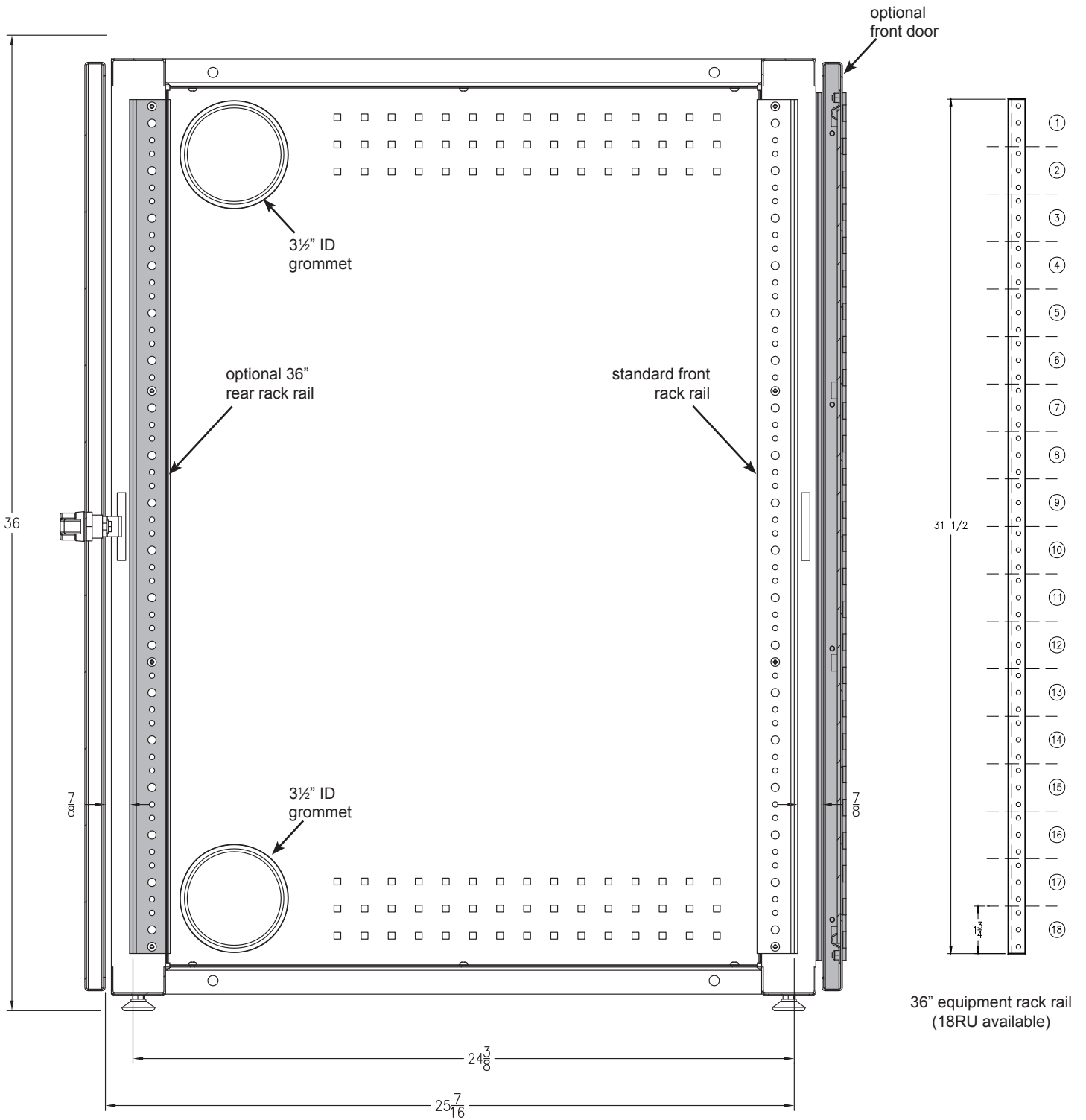

Standard Console Configurations

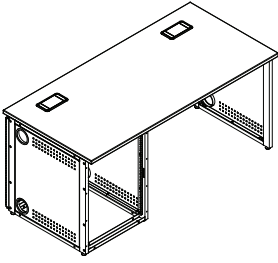

Console #1 (29\"/>		
Qty	Description	Item #
1	Triple Worksurface	68202
1	29\"/>	68107
2	29\"/>	68101
1	29\"/>	68105

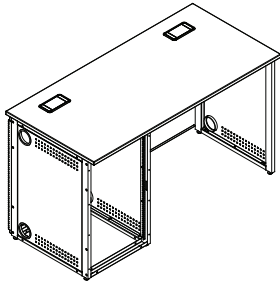
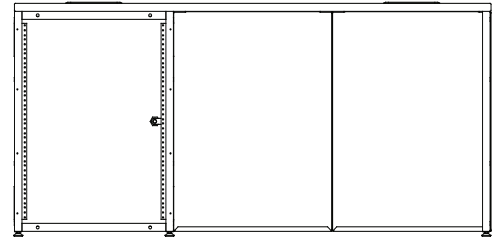
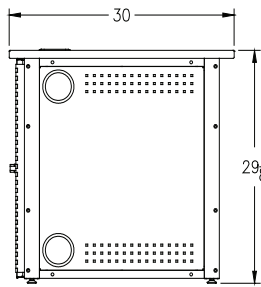
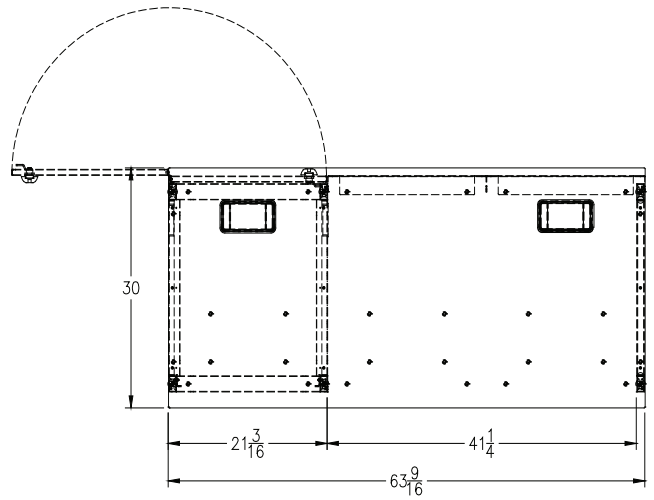

Console #1 (36\"/>		
Qty	Description	Item #
1	Triple Worksurface	68202
1	36\"/>	68157
2	36\"/>	68151
1	36\"/>	68155

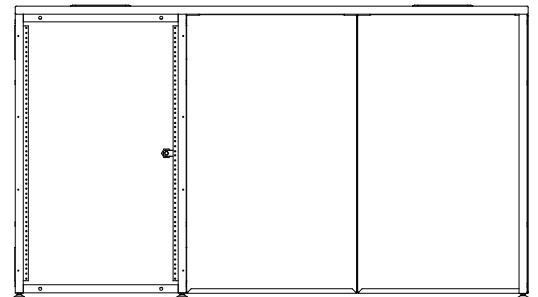
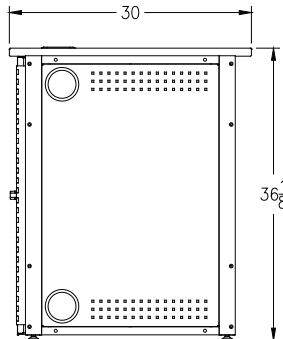
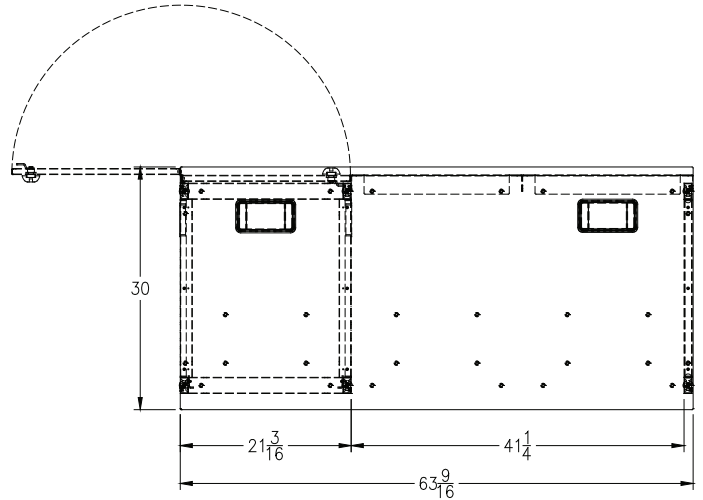

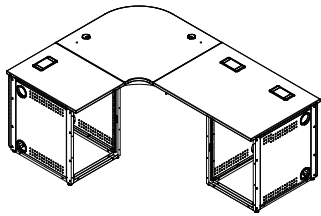

Console #2 (29"H) - 68022		
Qty	Description	Item #
1	29" Radius Corner	68106
1	Double Worksurface	68201
1	Single Worksurface	68200
2	29" Equipment Rack	68107
1	29" Wall Filler Panel	68101

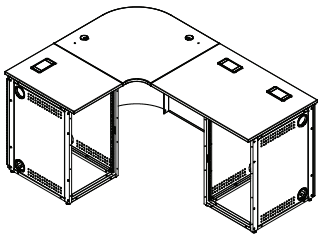
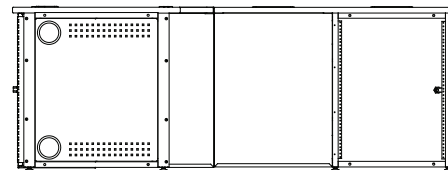
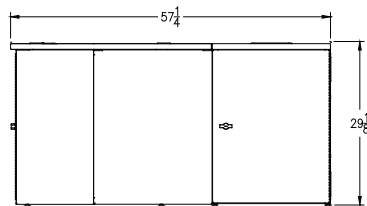
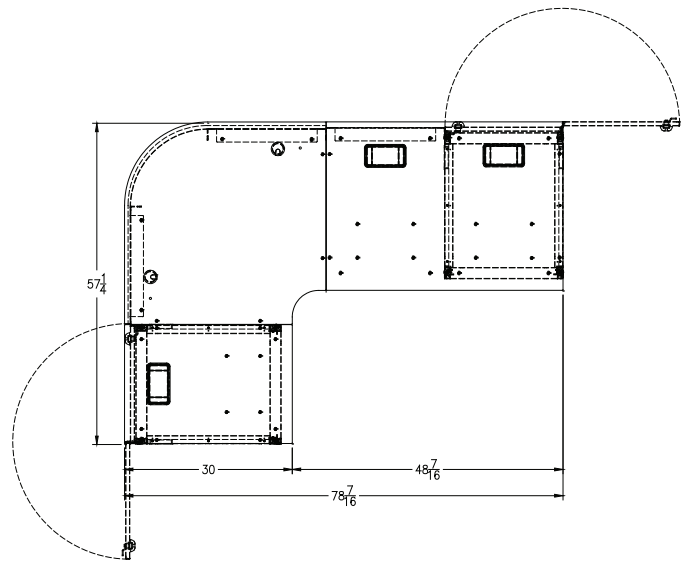

Console #2 (36"H) - 68023		
Qty	Description	Item #
1	36" Radius Corner	68156
1	Double Worksurface	68201
1	Single Worksurface	68200
2	36" Equipment Rack	68157
1	36" Wall Filler Panel	68151

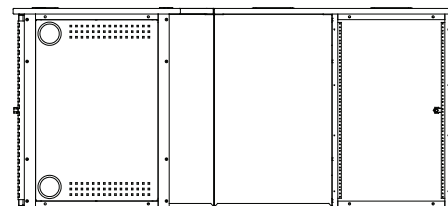
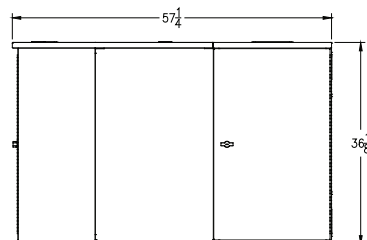
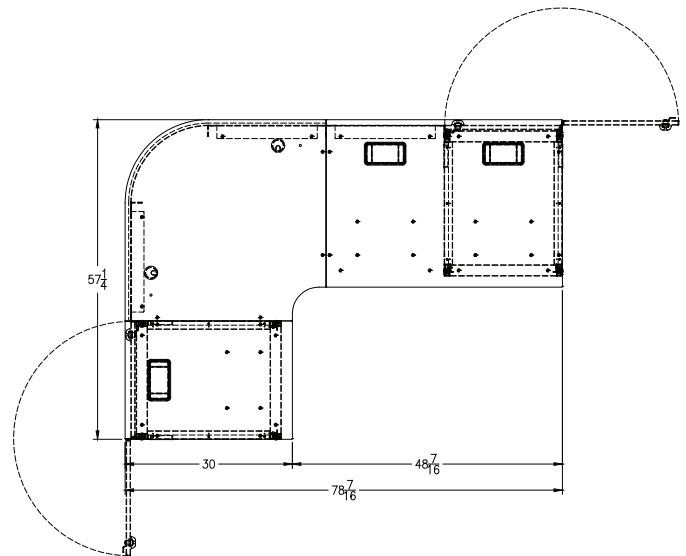

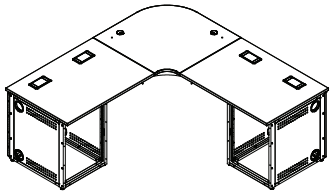

Console #3 (29\"/>		
Qty	Description	Item #
1	29\"/>	68106
2	Double Worksurface	68201
2	29\"/>	68107
2	29\"/>	68101

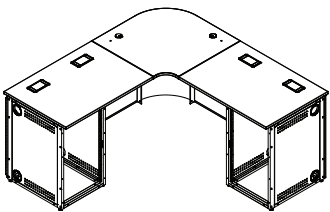
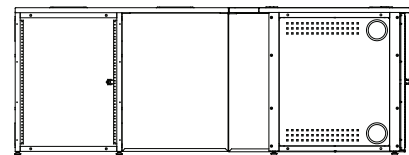
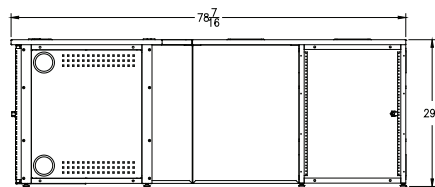
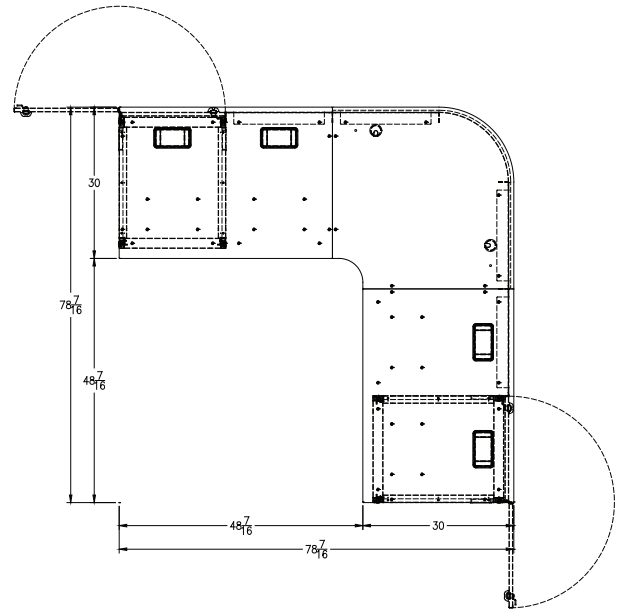

Console #3 (36\"/>		
Qty	Description	Item #
1	36\"/>	68156
2	Double Worksurface	68201
2	36\"/>	68517
2	36\"/>	68151

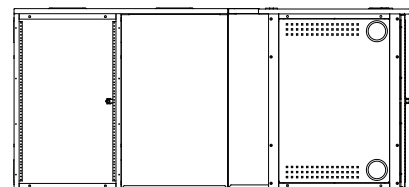
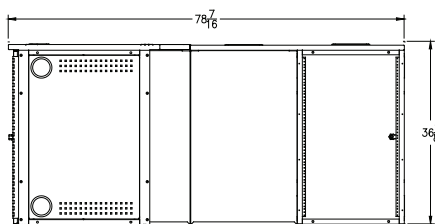
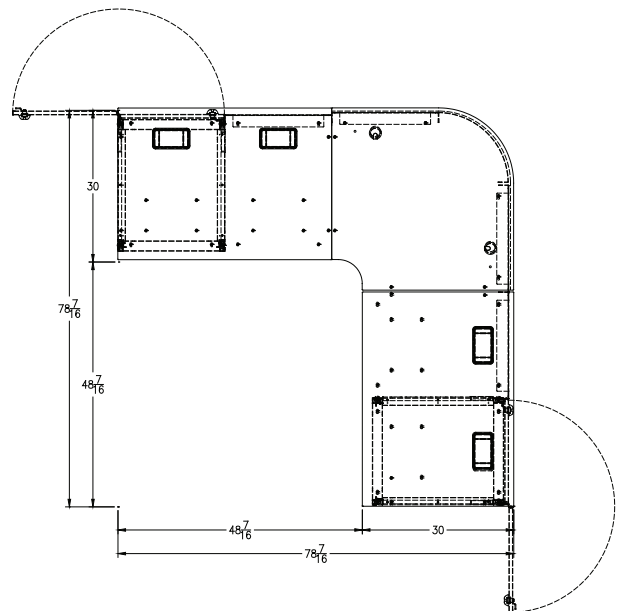

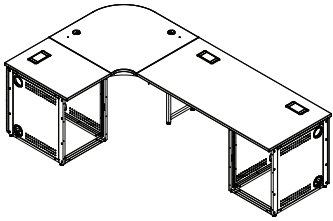

Console #4 (29" H) - 68026		
Qty	Description	Item #
1	29" Radius Corner	68106
1	Triple Worksurface	68202
1	Single Worksurface	68200
2	29" Equipment Rack	68107
2	29" Wall Filler Panel	68101
1	29" Mid-Support Leg	68104

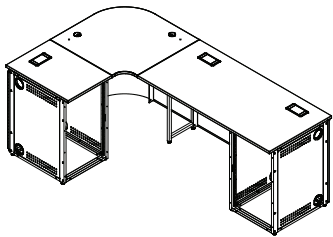
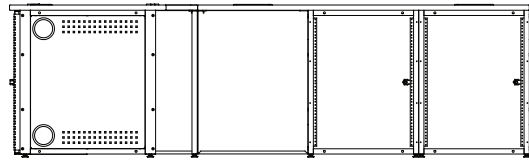
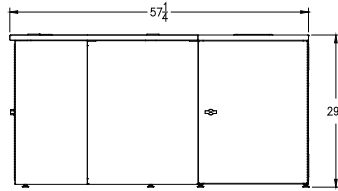
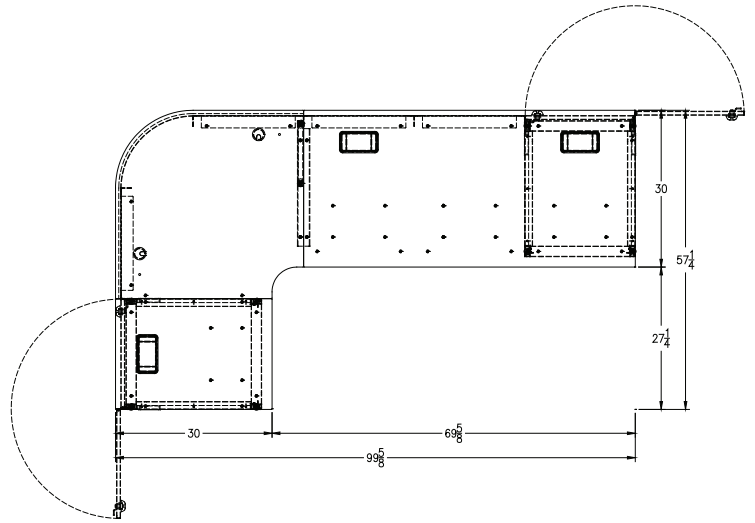

Console #4 (36" H) - 68027		
Qty	Description	Item #
1	36" Radius Corner	68156
1	Triple Worksurface	68202
1	Single Worksurface	68200
2	36" Equipment Rack	68157
2	36" Wall Filler Panel	68151
1	36" Mid-Support Leg	68154

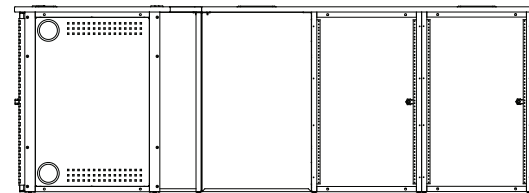
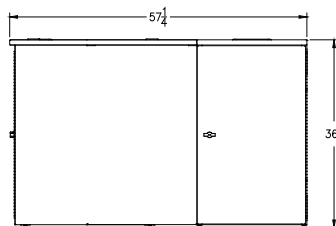
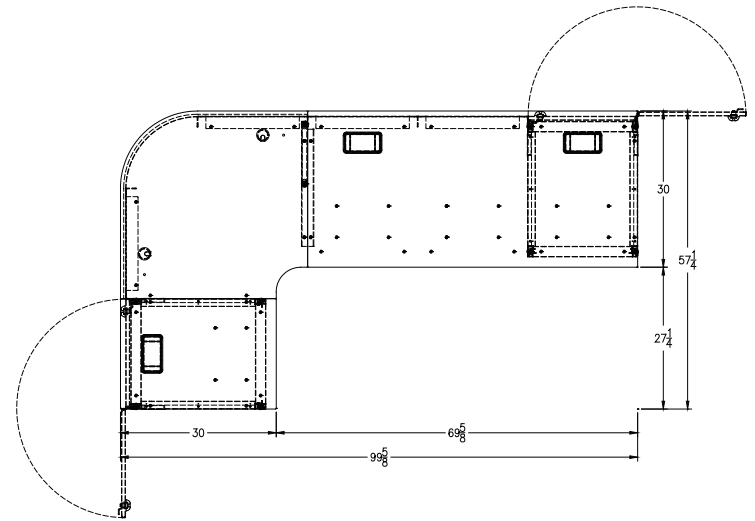

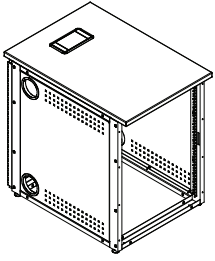

Console #5 (29\"/>		
Qty	Description	Item #
1	Single Worksurface	68200
1	29\"/>	68107

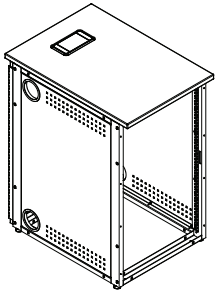
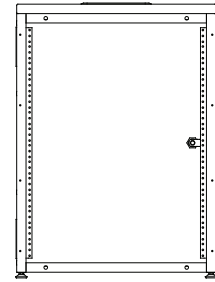
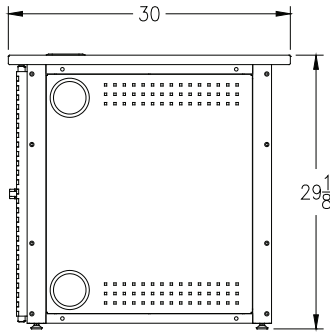
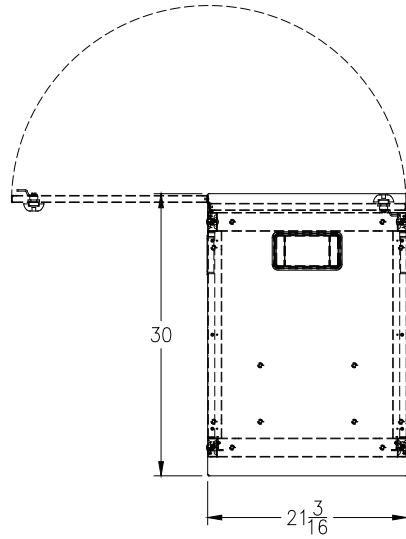

Console #5 (36\"/>		
Qty	Description	Item #
1	Single Worksurface	68200
1	36\"/>	68157

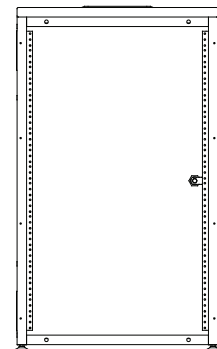
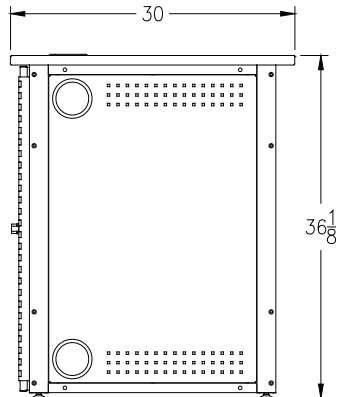
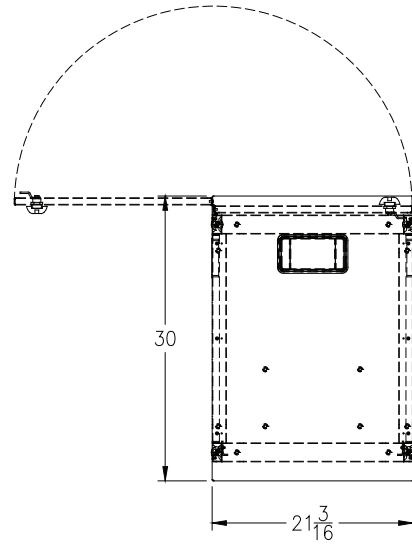

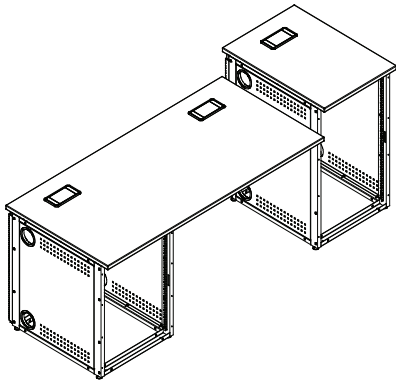

Console #6 - 68030		
Qty	Description	Item #
1	Triple Worksurface	68202
1	Single Worksurface	68200
1	29" Equipment Rack	68107
2	29" Wall Filler Panel	68101
1	36" Equipment Rack	68157
1	Stepped-Height Bracket	68205

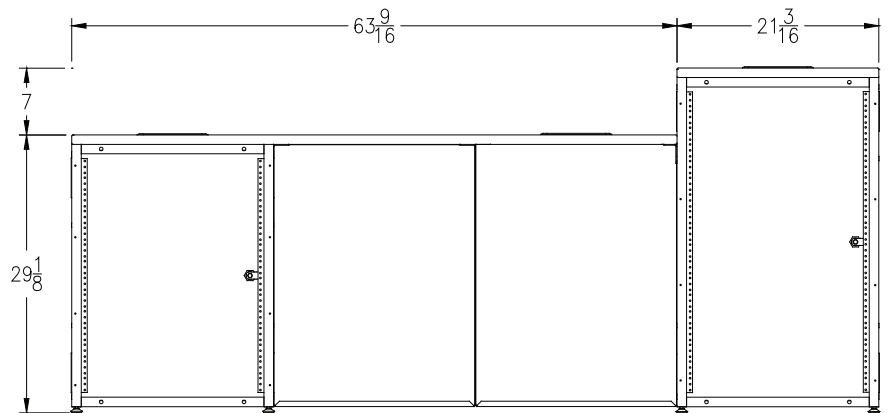
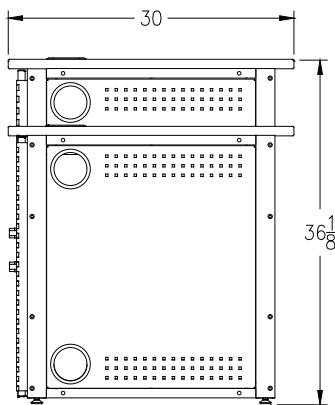
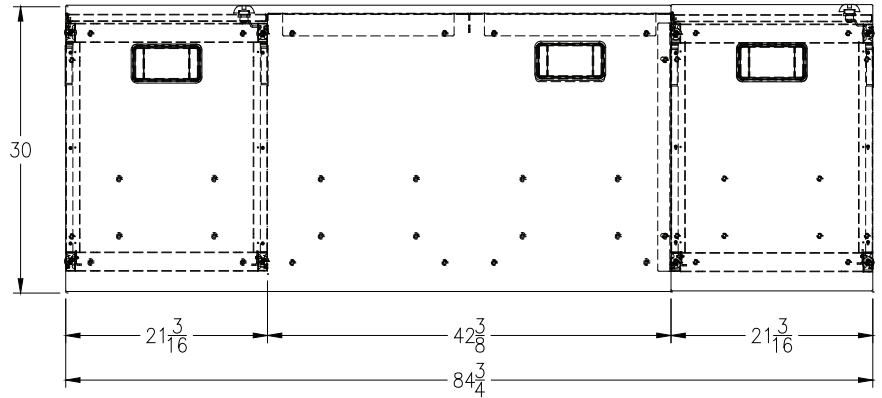

Options

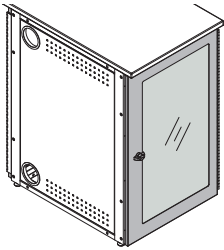

Clear Acrylic Locking Door
 (can be mounted to be hinged
 from the left or right side)
 68153 - 36"H
 68103 - 29"H

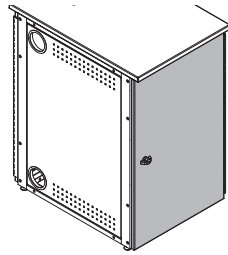

Solid Locking Door
 (can be mounted to be hinged
 from the left or right side)
 68152 - 36"H
 68102 - 29"H

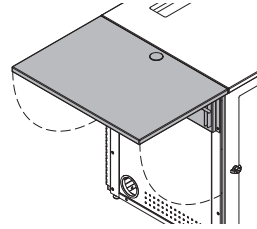

Flip-up Shelf
 21 $\frac{3}{16}$ "W x 30"D
 50 lbs max capacity
 (mtg plate available in black only)
 not for use on end-support legs or
 a stand-alone equipment rack
 68204

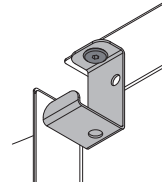

Wire Management Clips
 mount under worksurface
 (set of 3)
 68206

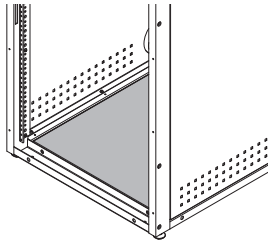

Equipment Rack Bottom Shelf
 (increases security & prevents
 static electricity & dust build-up)
 has 4" grommet at back
 68203

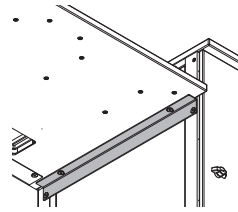

Stepped-Height Bracket
 (connects 29"H console to
 36" console)
 68205

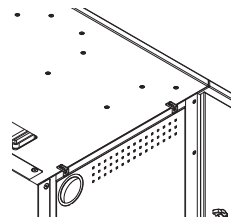

Level-Height Bracket Kit
 (attaches a worksurface to
 another worksurface of equal
 height above an equipment rack)
 68207

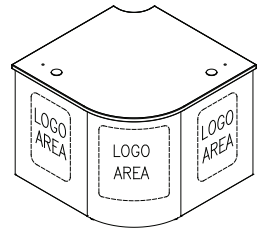

Custom-Cut Logo
 (typical logo location shown
 on wall filler panels)
 55141

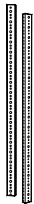

Rear Rack Rail Kit
 set of 2, adds 18RU or 14RU
 to rear of equipment rack
 68150 - 36"H (18RU)
 68100 - 29"H (14RU)

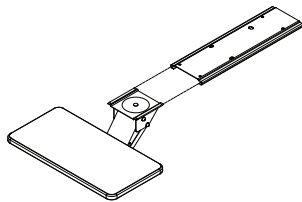

Micro-Arm Keyboard Tray
 moves in, out, up & down
 19 $\frac{3}{4}$ "W x 10"D
 95506

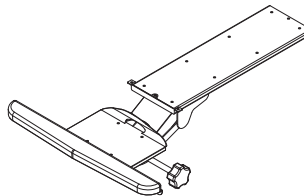

Econo Keyboard Tray
 18 $\frac{3}{8}$ "W x 12"D
 95520



**Mouse arm for Econo
 keyboard tray**
 8"W x 8"D
 95519

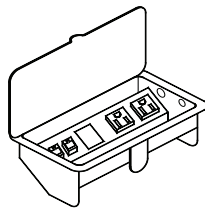

Power/Communication Module
 with 9' power cord, two outlets,
 two data jacks
 7 $\frac{1}{2}$ "W x 3 $\frac{3}{8}$ "D
 99003

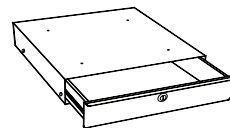

Universal Laptop Drawer
 16"W x 17 $\frac{1}{2}$ "D x 3 $\frac{1}{2}$ "H
 95510

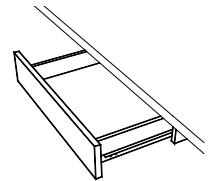

3" Pencil Drawer
 18"W x 11"D x 3"H
 (mounts under worksurface
 or inside equipment rack)
 97500

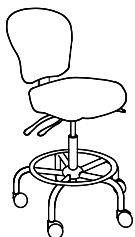

Multi-functional Stool
 38245



Adjustable Drafting Stool
 38202



Flat Panel Monitor Arms & Tablet Mounts
 (See the Spectrum website or catalog for the latest
 available monitor arm & tablet mounting options)

Rack-mount accessories

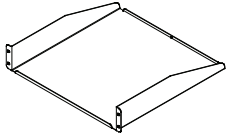

Cantilever Shelf (2RU)
 17½"W x 18"D x 3½"H
 (50 lbs max load)
 97504

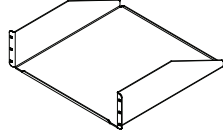

Cantilever Shelf (3RU)
 17½"W x 18"D x 5¼"H
 (80 lbs max load)
 97502

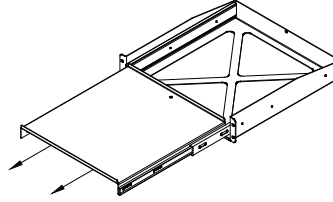

Pull-Out Shelf (2RU)
 16½"W x 17¼"D
 (50 lbs max load)
 97505

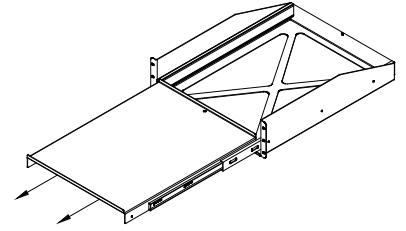

Pull-Out Shelf (3RU)
 16½"W x 21¼"D
 (80 lbs max load)
 97503

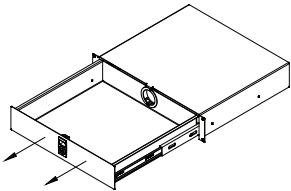

Locking Drawer (2RU)
 interior dims:
 15¾"W x 13¼"D x 2⅞"H
 (25 lbs max load)
 97514

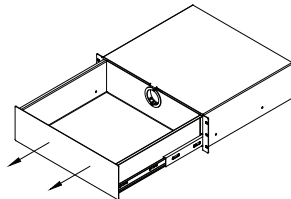

Drawer (3RU)
 interior dims:
 15¹⁵⁄₁₆"W x 14½"D x 5¼"H
 (50 lbs max load)
 97518

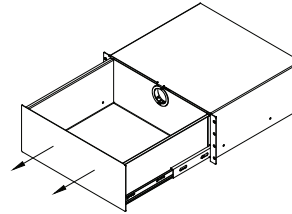

Drawer (4RU)
 interior dims:
 15¹⁵⁄₁₆"W x 14½"D x 7"H
 (50 lbs max load)
 97519

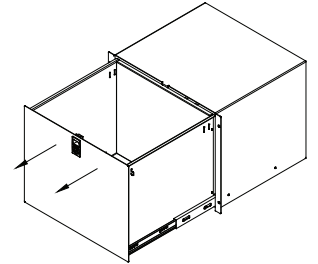

Locking File Drawer (8RU)
 w/ file holder
 interior dims:
 15¾"W x 13⅞"D x 13⅝"H
 (50 lbs max load)
 97515

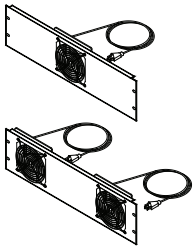

Cooling Fans (3RU)
 19"W x 2"D x 5¼"H
 Single Fan-97507
 Double Fan-97506

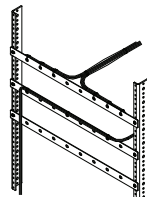

Wire Lace Kit
 3 lace straps included
 95517

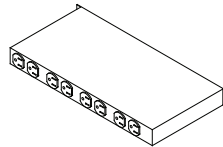

9-Outlet Power Strip (1RU)
 19"W x 9"D x 1¼"H
 99021

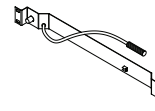

Flexible Halogen Light (1RU)
 19"W x 2"D x 1¼"H
 99033

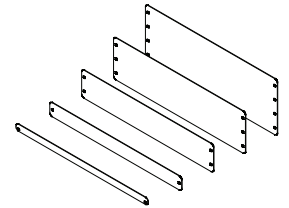

Rack-Mount Blanks
 (fills rack spaces where components are not needed)

- 97516 - (½ RU)
- 97510 - (1RU)
- 97511 - (2RU)
- 97512 - (3RU)
- 97513 - (4RU)

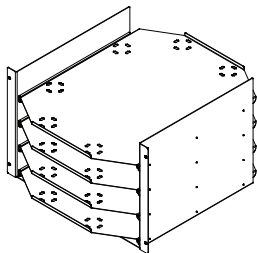

LT-4 Laptop Storage Unit (7RU)
 (stores 4 laptops horizontally)
 laptop tray dims:
 16¼"W x 20½"D x 2⅞"H
 97517

Warranty

WE WILL MAKE IT RIGHT FOR YOU!

Spectrum is committed to provide complete customer satisfaction. Each of our products are manufactured from the best materials available and each product is stringently monitored throughout the production process through our P.A.C.E. program (Product Assurance to meet Customer Expectations). Our Customer Service Help Line 1-800-235-1262 is ready to provide immediate attention to any questions, comments or concerns. We are available to answer your calls Monday through Friday from 7 am to 5 pm CST, excluding observed holidays. In addition your product comments or concerns are welcome via e-mail at: spectrum@spectrumfurniture.com.

Warranty Statement

We guarantee all Spectrum products to be free of all defects in materials and workmanship, for the original owner, for a period of ten years. Any item deemed defective by Spectrum or the original manufacturer, under normal use conditions, will be repaired or replaced at Spectrum's discretion. This warranty applies to all products manufactured and distributed by Spectrum except the products listed below.

Items that have a varying warranty include, but are not limited to, the following:

- Adjustable Crank/Electric Desk Legs (1 yr)
- Flat Panel Desk Gas Cylinders (1 yr)
- Upholstered Soft-Goods (5 yrs)
- Adjustable Height & Stacking Chair Parts – including frames, gas cylinders, wood and plastic parts, and control handles (7 yrs)
- Adjustable Height & Stacking Chair Casters (2 yrs)
- Chair Upholstery & Textiles (2 yrs of normal use of Soft Goods, Adjustable Height, Stacking, Wood and Metal Chairs)
- Chair Upholstery - Graded-In Fabrics and C.O.M (no warranty)
- Height Adjustable Columns and Lifts (1 yr)
- General Use Casters (1 yr)
- Electrical – Electri-Pak, Power Communication Modules, and special order ECA electrical items (1 yr)
- Electrical - Power Strips & Electrical Timers (1 yr)
- Electrical Surge Suppressors (lifetime)
- Electrical - Retractable Power Cords (1 yr)
- Keyboard/Mouse Trays (1 yr)
- Flat Panel Monitor Arm – General Parts (5 yrs)
- Flat Panel Monitor Arm – Gas Cylinders (2 yrs)
- CRT Monitor Arm (1 yr)

Warranty is void if product is not used for its intended purpose or subjected to an unusual application, multiple-shift use, alteration, accident, abuse or abnormal wear and tear. Representations of colors on-line and in printed materials are meant to be a close reference to the actual colors but not an exact match. Slight variations in color and texture of wood stains, powder coating, laminates, fabrics and other materials are normal in different manufacturing lots; as such these variations are not considered defects.

DESIGNED FOR INDOOR USE ONLY – Unless specifically stated in the product specifications, Spectrum's products have been designed and constructed for indoor use only. Moving or using outdoors, or on excessively rough surfaces, may cause damage to the products and will void the warranty. If an outdoor application is desired please contact us to discuss potential custom design solutions.

The warranty, as stated above, supersedes any previous warranties and is effective as of 9/1/2010

Touchboards

205 Westwood Ave, Long Branch, NJ 07740
Phone: 866-94 BOARDS (26273) / (732)-222-1511
Fax: (732)-222-7088 | E-mail: sales@touchboards.com

