

DIAL INDICATORS

81 DIAL INDICATORS WITH DOUBLE ROW FIGURES

AGD GROUP 1

RANGES UP TO .075"

These indicators have the exact same features as our 81 Dial Indicators on the previous page, except the dials have double-row figures, as illustrated, and they cannot be specified with a special non-shock mechanism.

If lift lever is desired, indicator must be ordered with case stem cap.

81 Dial Indicators with Double Row Figures

Cat. No.	EDP	Graduation	Dial Reading	Figures Direction	Color	Range One Rev.	Total
81-111-624J	53380	.0001"	-10 -0-10	Clockwise Counter-clockwise	Black Red	.010"	.025"
81-111-630J	53382	.0001"	-10 -0-10	Counter-clockwise Clockwise	Black Red	.010"	.025"
81-136-622J	53394	.0005"	-30 -0-30	Clockwise Counter-clockwise	Black Red	.030"	.075"
81-136-623J	53396	.0005"	-30 -0-30	Counter-clockwise Clockwise	Black Red	.030"	.075"
81-143-628J	53406	.001"	-30 -0-30	Clockwise Counter-clockwise	Black Red	.030"	.075"
81-143-629J	66666	.001"	-30 -0-30	Counter-clockwise Clockwise	Black Red	.030"	.075"

Other models with double-row figures can be furnished by request.



81-111-624J

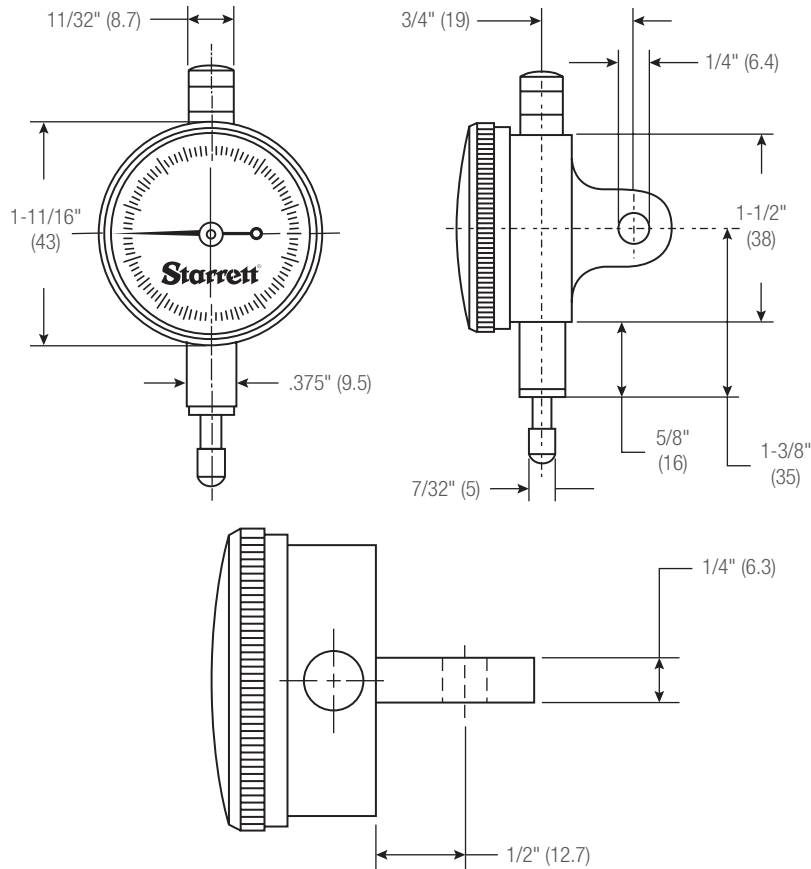

Free drafting template available for this size.

Write The L. S. Starrett Co. at:
121 Crescent Street
Athol, MA 01331

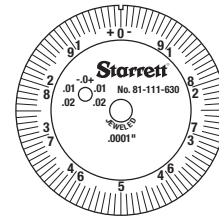

81-111-630J

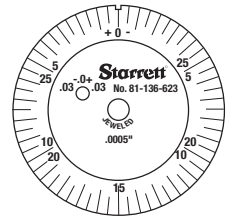

81-136-623J

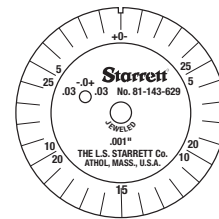

81-143-629J

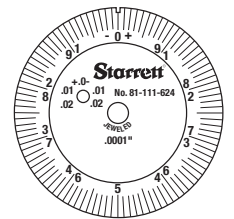

81-111-624J

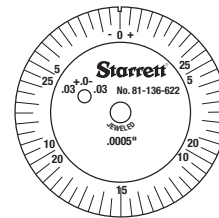

81-136-622J

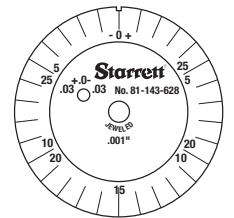

81-143-628J

