



SLIDE CALIPERS

ELECTRONIC CALIPERS

798 ELECTRONIC CALIPERS

0-12"/0-300MM

The 798 Electronic Caliper features a large, easy-to-read, high contrast LCD readout. It includes IP67 protection against coolants, water, chips, dust and dirt often found in machine shop environments. Its induction type linear encoder system and Inch/millimeter conversion makes Starrett precision measuring tools the right choice for any job.

798 Electronic Calipers			
Cat. No.	EDP	Range	Description
798B-6/150	12521	0-6" (150mm)	Caliper with output
798B-6/150 W/SLC	12522		Caliper with output
798BX-6/150	12782		Caliper with output
798A-6/150	20798		Caliper without output
798B-8/200	12523	0-8" (200mm)	Caliper with output
798B-8/200 W/SLC	12524		Caliper with output
798A-8/200	20799		Caliper without output
798B-12/300	12525		Caliper with output
798B-12/300 W/SLC	12526	0-12" (300mm)	Caliper with output
798A-12/300	20800		Caliper without output

Accessories, Cables and Case Information for 798 Electronic Calipers		
Cat. No.	EDP	Description
798SCM	69894	SmartCable to multiplexer
798SCU	73321	SmartCable to USB
798SCKB	69889	USB cable to PC (In focused window)
PT26151	64440	Center distance attachment
PT22431	64640	Depth attachment
PT63388	72517	Computer interface cable to PC (USB) with driver CD
PT63329-1	12733	Replacement non-contact computer interface cable to PC (USB)
PT99492	65650	Two 3-Volt batteries, CR2032
723ZZ-6/722ZZ-6	57070	Deluxe padded case for 0-6" (150mm) calipers
950	63878	Finished wood case for 0-8" (200mm) calipers
946	56695	Finished wood case for 0-12" (300mm) calipers

*Includes redemption card for Standard Letter of Certification (SLC).



FEATURES

- IP67 level of protection
- Fine adjustment
- Hardened stainless steel measuring surfaces
- Large, easy-to-read, high-contrast LCD digital readout
- Induction type linear encoder system
- RS232 output
- Heavy-duty bar and slide
- Slide lock
- One 3-volt battery for over one year of normal usage
- In/mm conversion
- Zero at any position
- Auto-Off after 30 minutes
- Reactivation of display with no loss of position
- Works well with Starrett DataSure® Wireless Data Collection Systems

Approximate Jaw Depths for 798 Electronic Calipers			
	6" (150mm)	8" (200mm)	12" (300mm)
Outside	1-1/2" (38mm)	1-7/8" (47.6mm)	2-1/2" (63.5mm)
Inside	5/8" (16mm)	3/4" (19mm)	3/4" (19mm)



IP PROTECTION

An IP number is composed of two numbers, the first referring to protection against solid objects and the second against liquids.

First number 6: Totally protected against dust

Second number 7: Protection against submersion in water under standardized conditions of pressure for 30 minutes

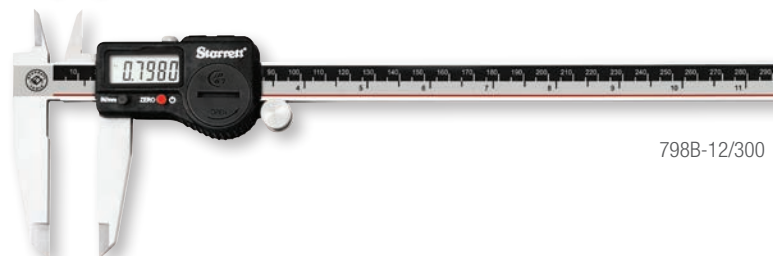
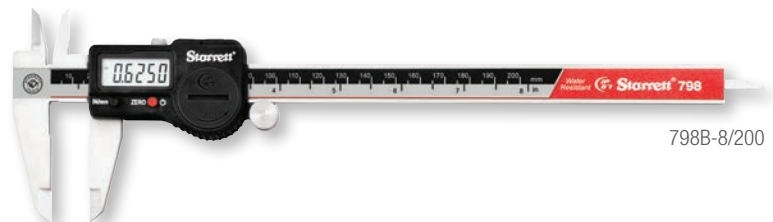

ELECTRONIC CALIPERS

NEW!

EC799 ELECTRONIC CALIPERS

0-40"/0-1000MM

The EC799 Electronic Caliper is light, comfortable, easy-to-use, and constructed with features that have made Starrett slide calipers the machinist's first choice for many years. Output now available.

The EC799 offers a slim, streamlined profile, a large, clear, easy-to-read LCD display, long battery life, and function buttons for zero and inch/mm.

FEATURES

- Lightweight, ergonomic design
- Inch/millimeter conversion reads .0005" or 0.01mm
- Easy access to the single, long-life battery
- Last measuring position retained when shut off
- Hardened stainless steel body for long life
- Fine adjustment thumb wheel
- Lock screw to hold the slide in position
- Resolution is .0005" (0.01mm)
- Zero at any position
- Protective case

6", 8" AND 12" CALIPERS ONLY

- Large easy-to-read LCD, .32" high characters
- Automatic shut-off after 5 minutes of non-use
- Linear accuracy meets DIN862
- Integrated depth rod

EXTENDED RANGE 24" AND 40" CALIPERS

- Preset and hold feature
- Minimum and maximum limits set
- I.D. jaw dimension is 0.800"/20.32mm
- LCD characters are .50" high
- Auto shut-off after 30 minutes of non-use

SLIDE CALIPERS

EC799 Electronic Slide Calipers

Cat. No.	EDP	Range in	mm
EC799A-6/150	00142	0-6	0-150
EC799A-6/150 W/SLC*	72665		
EC799B-6/150	00143		
EC799B-6/150 W/SLC*	00144		
EC799A-8/200	00145	0-8	0-200
EC799A-8/200 W/SLC*	72674		
EC799B-8/200	00146		
EC799B-8/200 W/SLC*	00147		
EC799A-12/300	00148	0-12	0-300
EC799A-12/300 W/SLC*	72673		
EC799B-12/300	00149		
EC799B-12/300 W/SLC*	00150		

799 Extended Slide Calipers

Cat. No.	EDP	Range in	mm
799AZ-24/600	11978	0-24	0-600
799AZ-40/1000	11979	0-40	0-1000

Accessories, Cables and Case Information for 799 Electronic Calipers

Cat. No.	EDP	Description
EC799BSCM	46000	SmartCable to multiplexer
EC799BSCU	46002	SmartCable to USB
EC799BSCKB	46001	SmartCable to USB keyboard
PT26151	64440	Center distance attachment
PT22431	64640	Depth attachment for 6", 9" and 150mm calipers
PT99492	65650	3-volt battery; CR2032
723ZZ-6/722ZZ-6	57070	Deluxe padded case for 0-6" (150mm) calipers
950	63878	Finished wood case for 0-8" (200mm) calipers
946	56695	Finished wood case for 0-12" (300mm) calipers

* Includes redemption card for Standard Letter of Certification (SLC).

Approximate Jaw Depths for 799 Electronic Calipers

	6" (150mm)	8" (200mm)	12" (300mm)	24" (600mm)	40" (1000mm)
Outside	1-1/2" (38mm)	2" (50.8mm)	2-1/2" (63.5mm)	4" (100mm)	6" (150mm)
Inside	5/8" (16mm)	3/4" (19mm)	23/32" (18.3mm)	11/16" (17.46mm)	11/16" (17.46mm)



CARBON CALIPERS

5000, 5001 AND 5002 CARBON FIBER CALIPERS

0-40"

- Carbon fiber construction significantly reduces weight, improving maneuverability
- Titanium coated stainless steel outside measurement jaws for long life and superior flatness
- Coolant resistant
- Two preset modes, REF I and REF II, allow setting one mode to a setting master and a second to a zero setting
- Full-featured, sophisticated electronics with RS232 output
- Ideal for use with Starrett DataSure® Wireless Data Collection Systems using a 1500-3A-1N end node
- Will also transmit to PC through cable

FEATURES AND SPECIFICATIONS

- CR2032 lithium battery included
- Clamping screw
- Protective wooden case
- Resolution: 0.0005"/0.01mm

5000 AND 5002 ONLY

- mm/inch mode button
- On/Off button
- Hold feature will freeze the display when in REF I or REF II mode

5001 ONLY

- Mode and Set buttons
- Min/Max mode displays values referenced from the preset value of the REF mode the tool is in when entering MIN/MAX
- Tolerance mode to set upper and lower measurement tolerances
- Larger display with more information

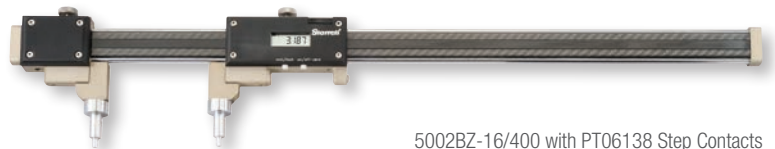

5002BZ-16/400 with PT06138 Step Contacts



5002BZ-24/600 with PT06139 Conical Contacts



5002BZ-40/1000 with PT06137 Disc Contacts



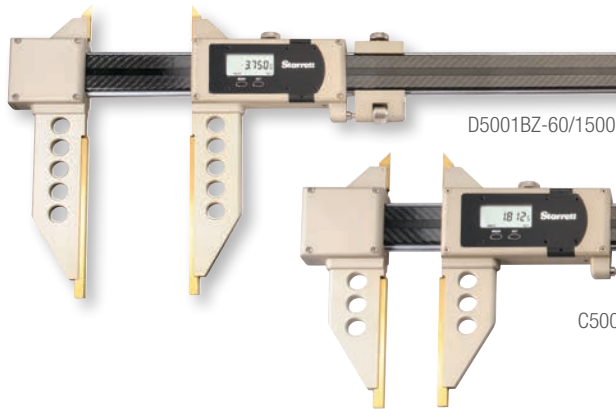
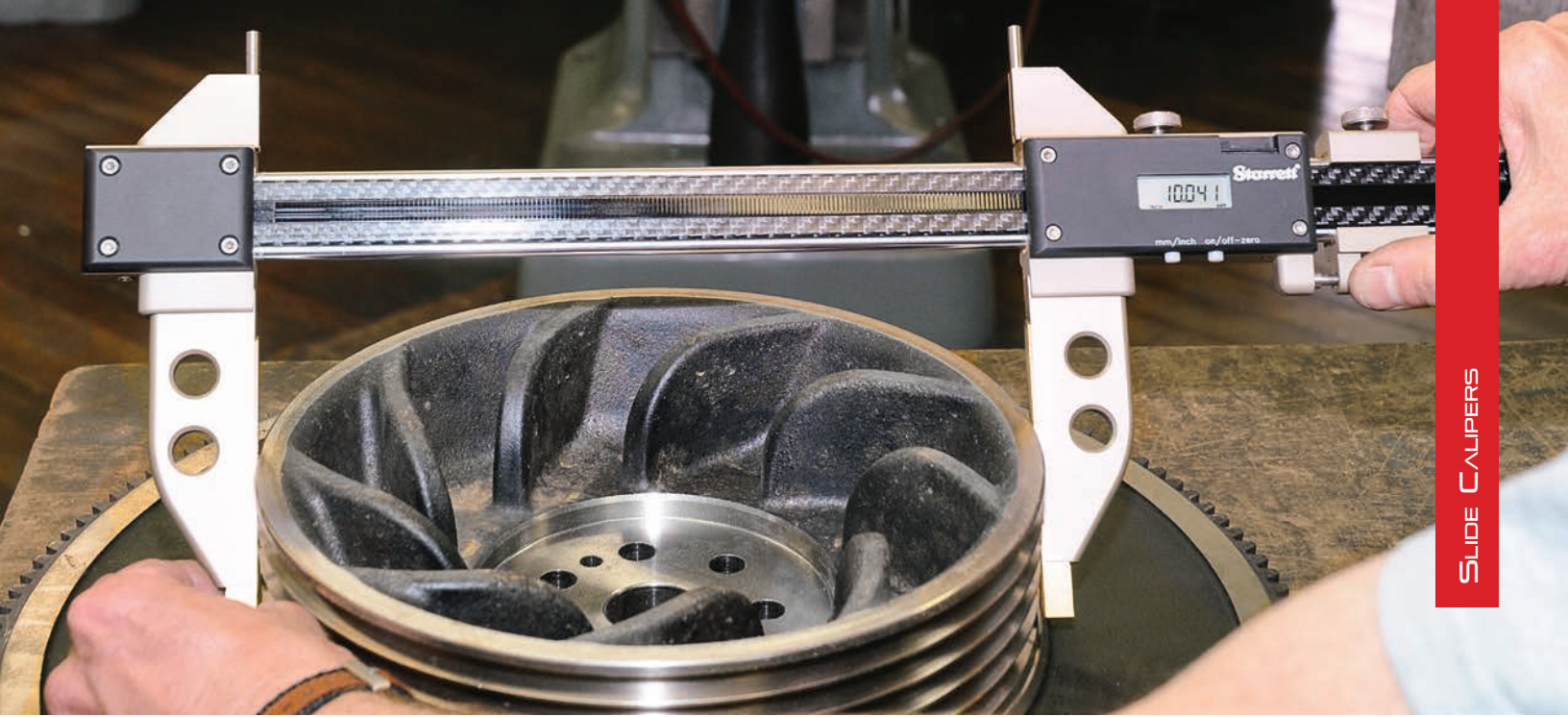

C5001BZ-40/1000



B5000BZ-24/600

B5000BZ-20/500

5000 Carbon Fiber Calipers

Cat. No.	EDP	Outside	Weight	Jaw Depth	Measuring Capacities	
					Inside (w/jaws)	Inside (w/top pins)
B5000BZ-20/500	14571	0-20" (0-500mm)	2.43lb (1.10kg)	4.921" (125mm)	0.787-20" (20-500mm)	0.394-20" (10-500mm)
B5000BZ-24/600	14572	0-24" (0-600mm)	2.56lb (1.16kg)	4.921" (125mm)	0.787-24" (20-600mm)	0.394-24" (10-600mm)
B5000BZ-40/1000	14573	0-40" (0-1000mm)	3.09lb (1.40kg)	4.921" (125mm)	0.787-40" (20-1000mm)	0.394-40" (10-1000mm)

5001 Carbon Fiber Calipers

Cat. No.	EDP	Outside	Weight	Jaw Depth
C5001BZ-40/1000	14574	0-40" (0-1000mm)	5.51lb (2.50kg)	5.906" (150mm)
D5001BZ-60/1500	14575	0-60" (0-1500mm)	7.28lb (3.30kg)	7.875" (200mm)

5002 Carbon Fiber Calipers

Cat. No.	EDP	Outside	Weight
5002BZ-16/400	14576	0-16" (0-400mm)	1.65lb (0.75kg)
5002BZ-24/600	14577	0-24" (0-600mm)	1.98lb (0.90kg)
5002BZ-40/1000	14578	0-40" (0-1000mm)	3.31lb (1.50kg)

Accessories for 5002 Carbon Fiber Calipers

Part No.	EDP	Description
PT06137	12829	Disc Contacts
PT06138	12830	Step Contacts
PT06139	12831	Cone Contacts

Data Collection

Part No.	EDP	Description
797SCKB	69890	USB cable to PC (In focused window)





ELECTRONIC CALIPERS

5005 ELECTRONIC LONG JAW CALIPERS

0-24"/0-600MM

The 5005 Electronic Calipers are built with extra long, 12" (300mm) jaws ideal for applications requiring precise O.D. or I.D. measurement in tight spaces that standard calipers can not reach.

FEATURES AND SPECIFICATIONS

- Hardened stainless steel construction for long life
- Tight, smoothly fitted slides for maximum accuracy and easy adjustment
- Coolant resistant
- Lock nut to hold measurements
- Fine adjustment thumbwheel
- Inch/mm conversion
- Ability to set ZERO at any position
- Two preset modes to install any reading at any point
- Full-featured, sophisticated electronics with Opto RS232 output
- Ideal for use with Starrett DataSure® Wireless Data Collection Systems using a 1500-3A-1N end node
- Will also transmit to PC through cable
- CR2032 lithium battery included
- Large easy-to-read display with resolution of 0.0005"/0.01mm
- Packed in a wood case
- Computers with Excel use 797SCKB
- Computers running SPC Data Collection use 797SCU



F5005BZ-24/600

5005 Electronic Calipers

Cat. No.	EDP	Range	Jaw Depth
F5005BZ-24/600	14588	0-24" (0-600mm)	12" (300mm)





ELECTRONIC CALIPERS

5006 ELECTRONIC GROOVE CALIPERS

FEATURES AND SPECIFICATIONS

- Standard Measuring Tip Diameter: .118" (3mm)
- Two Preset Modes
- Hold Feature will freeze the display when it is in preset mode
- On/Off Button
- RS232 port allows data transmission thru a DataSure® Wireless Data Collection System using a 1500-3A-1N End Node. Will also transmit through a connected cable
- CR2032 lithium battery included
- Includes wooden case
- Resolution: 0.0005" (0.01 mm)
- Generous diameter and jaw depth capacities
- Ideal for measuring internal and external grooves on large workpieces
- Hardened stainless steel construction
- Coolant resistant



5006BZ-14/350

5006 Electronic Groove Caliper

Cat. No.	EDP
5006BZ-14/350	14589

Data Collection

Part No.	EDP	Description
797SCKB	69890	USB cable to PC (In focused window)

Specifications

	Groove Measuring Range	Max. Depth
Outside	0-12.5" (0-318mm)	3.937" (100mm)
Inside	1.654-15" (42-381mm)	3.7" (94mm)



DIAL CALIPERS

120, 120M DIAL CALIPERS

0-12"/0-300MM

The Only American Made Dial Caliper ...

This is one of the handiest measuring tools available, used by mechanics and toolmakers everywhere. It is direct reading, reliable and accurate.

READABILITY FEATURES

- Sharp, clear dial graduations of .001" or 0.02mm – .100" or 2mm in one revolution
- Sharp, black graduations on the satin finished bar, every .100" or 1mm
- Choice of black, red, or white inch dials; millimeter dials are yellow

EASE-OF-HANDLING FEATURES

- Knife-edge contacts for both inside and outside measurements
- One hand use with the thumb-operated, fine adjustment roll
- Lock screw for dial bezel and for holding the sliding jaw in position
- Detachable depth rod available for 12" (300mm) model
- Parallel lines can be scribed on a workpiece by setting the caliper jaw to the required dimensions, locking the movable jaw with the lock screw and then using the front edge of the fixed jaw as the scribing surface

ACCURACY AND LONG-LIFE FEATURES

- Long-wearing carbide faces on outside contacts on model 120AX-6 and 120MX-150 only
- Hardened stainless steel bar, measuring surfaces, rack, gears and depth rod
- Positive, split-gear anti-backlash control
- Rack teeth point down to make it easy to shed foreign matter and thereby keep the area clean



120A-6



R120A-6



B120A-6



120AM-150 metric dial caliper with yellow dial



120Z-12



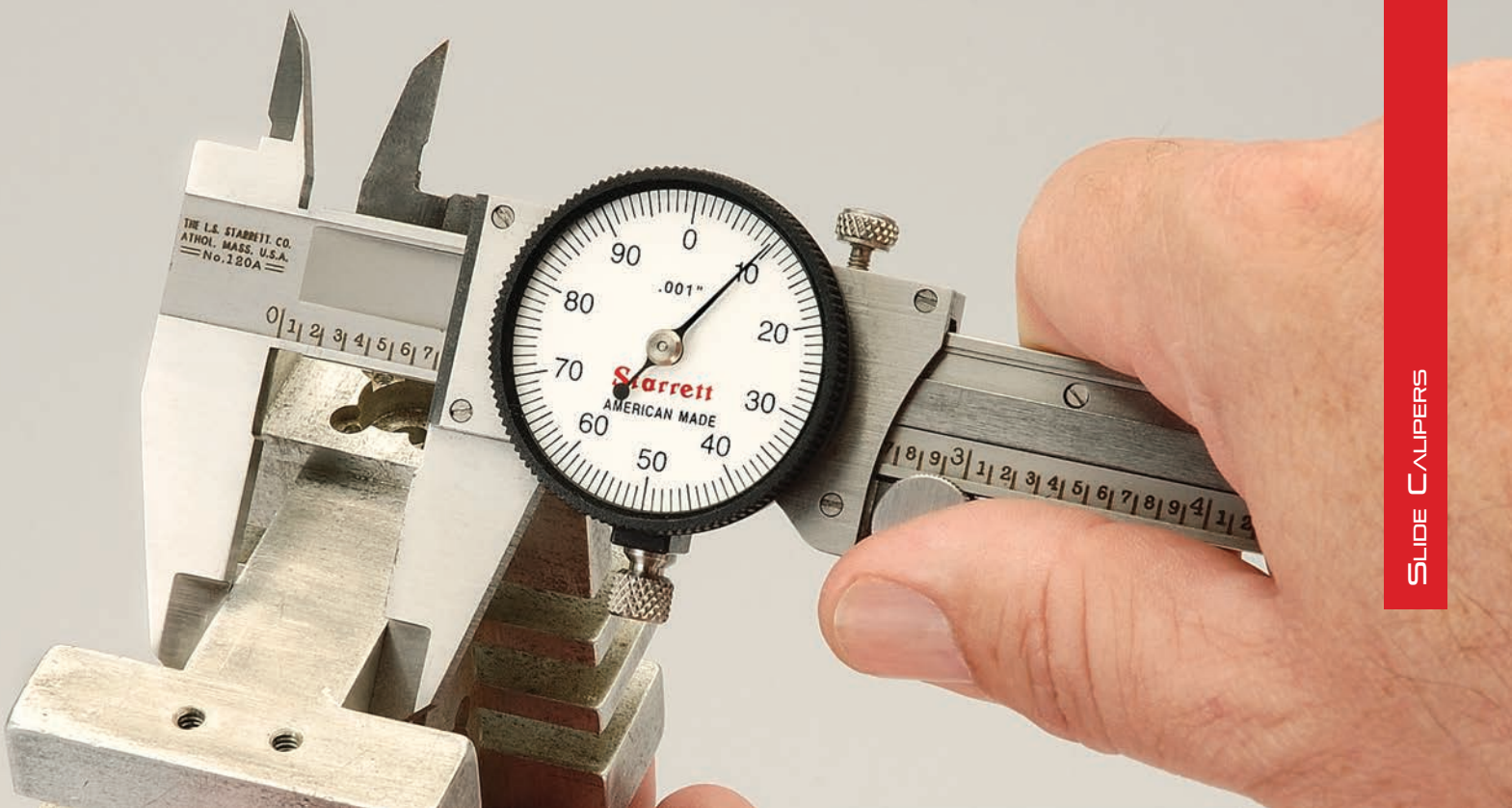

120 Dial Calipers (.001" Graduation)

Cat. No.	EDP	Range	Dial Color	Jaw Depth		Description
				in	mm	
120A-6	64514	0-6"	White	5/8	16	Caliper in fitted plastic case
120A-6 W/SLC†	66568	0-6"	White	5/8	16	Caliper in fitted plastic case
120X-6	65909	0-6"	White	1-1/2	38	Caliper in fitted plastic case
B120A-6	64515	0-6"	Black	5/8	16	Caliper in fitted plastic case
B120A-6 W/SLC†	66917	0-6"	Black	1-1/2	38	Caliper in fitted plastic case
R120A-6	64516	0-6"	Red	5/8	16	Caliper in fitted plastic case
R120A-6 W/SLC†	66918	0-6"	Red	3/4	19	Caliper in fitted plastic case
120AZ-9	64520	0-9"	White	5/8	16	Caliper in finished Wood case
120A-9	64517	0-9"	White	1-1/2	38	Caliper without case
120Z-12	56693	0-12"	White	3/4	19	Caliper in finished wood case
120Z-12 W/SLC†	66569	0-12"	White	3/4	19	Caliper in finished wood case
120-12	56694	0-12"	White	2-1/2	63	Caliper without case
120-12 W/SLC†	66919	0-12"	White	2-1/2	63	Caliper without case

120M Dial Calipers (0.02mm Graduation)

Cat. No.	EDP	Range	Dial Color	Jaw Depth		Description
				in	mm	
120AM-150	66295	0-150mm	Yellow		16	Caliper in fitted plastic case
120AM-150 W/SLC†	66920	0-150mm	Yellow		38	Caliper, without case
120MX-150	65910	0-150mm	Yellow		38	Caliper in fitted plastic case
120MZ-225	64508	0-225mm	Yellow		16	Caliper in wood case
120M-225	64509	0-225mm	Yellow		38	Caliper without case
120MZ-300	64510	0-300mm	Yellow		19	Caliper in wood case
120MZ-300 W/SLC†	66922	0-300mm	Yellow		19	Caliper in wood case
120M-300	64511	0-300mm	Yellow		63	Caliper without case
120M-300 W/SLC†	66921	0-300mm	Yellow		63	Caliper without case

Accessories and Cases Only for 120 and 120M Dial Calipers

Cat. No.	EDP	Description
PT26151	64440	Center distance attachment*
PT22431	64640	Depth attachment for 6", 9" and 150mm calipers
PT26091	65100	Detachable depth rod for 12" calipers
943	55971	Deluxe padded case for 6" (150mm) calipers
950	63878	Finished wood case for 9" (225mm) calipers
946	56695	Finished wood case for 12" (300mm) calipers
915	64166	Leather holster for 6" (150mm) calipers

† Includes redemption card for Standard Letter of Certification (SLC).

* See details in this section.



DIAL CALIPERS

3202 DIAL CALIPERS

0-12"

With the ability to provide quick, accurate measurement of O.D., I.D., depth and step the dial caliper is the most versatile precision hand tool on the market.

3202 Dial Calipers are based on the caliper that has been the first choice of metal working professionals for decades. 3202 Dial Calipers are available in 6", 8" and 12" versions.

FEATURES AND SPECIFICATIONS

- Sharp, clear dial graduations of 0.001"
- 1" per revolution
- Thumb-operated fine adjustment roll
- Sharp, black graduations on the satin finished bar, every .1"
- Hardened stainless steel bar, measuring surfaces, rack, gears, and depth rod
- Positive, spring-loaded double pinion anti-backlash control
- Lock screws for sliding jaw and dial bezel
- Knife-edge contacts
- Adjustable bezel
- 0-6", 0-8" and 0-12" sizes available

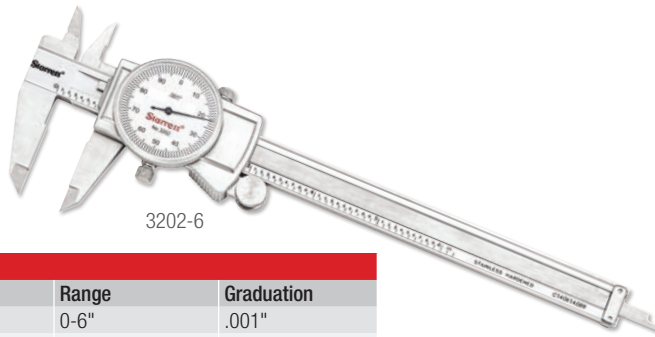

3202-6

3202 Dial Calipers

Cat. No.	EDP	Range	Graduation
3202-6	61467	0-6"	.001"
3202-8	61468	0-8"	.001"
3202-12	61466	0-12"	.001"

1202F FRACTIONAL DIAL CALIPERS

0-12"

The 1202F shows measurements as fractions on the yellow outer scale with 1/64th inch graduations, and decimal measurements on the white inner scale with 1/100th inch graduations.

FEATURES

- 1/64" graduations on the yellow outer scale, and .01" on the white inner scale.
- Except for dial graduation and color, 1202F Calipers have the same features as other 1202 Dial Calipers

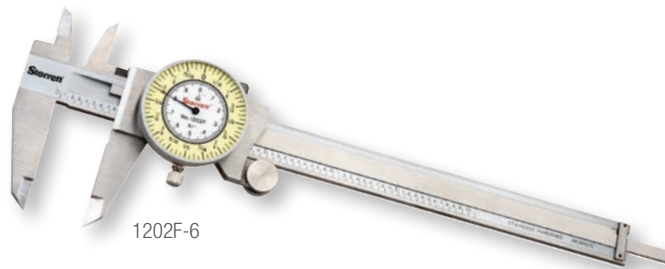

1202F-6

1202F Dial Calipers

Cat. No.	EDP	Range
1202F-6	68931	0-6" Fractional



DIAL CALIPERS

120B, 120MB DIAL CALIPERS WITH LONG NIB JAWS

0-12"/0-300MM

This tool is a direct reading caliper with 3" (75mm) long jaws, ideal for heavy duty use and for gaining access to more measuring area than with conventional calipers. Strong inside and outside nibs measuring from zero for outside measuring and from .300" or 8mm for inside measuring.



120B-12

120B and 120MB Dial Calipers with Long Nib Jaws			
Cat. No.	EDP	Range	Dial Color
120B-12	65067	0-12"	White
120MB-300	65154	0-300mm	Yellow
120MB-300 W/SLC*	66923		

* Includes redemption card for Standard Letter of Certification (SLC).

120J OFFSET DIAL CALIPER

0-6"

This tool has an adjustable jaw for versatility when measuring different planes that can't be reached with a regular caliper. The reference jaw is adjustable in height to be either longer or shorter than the sliding jaw. All other features are the same as our 120 Dial Caliper.

- Adjustable jaw – 3-1/2" (88mm) long
- Extends up to 5/8" (16mm) longer than the sliding jaws
- Caliper in deluxe padded case



120JZ-6

120J 0-6" Offset Dial Caliper	
Cat. No.	EDP
120JZ-6	65866

CENTER DISTANCE ATTACHMENT

PT26151

A set of two jaws with body sizes of .400" and conical points, enabling the user to measure the center distance between holes or center-punched locations that are at least .400" apart and less than .400" in diameter.

- Can be used with metric calipers by setting the caliper to 10.16mm
- Will fit Starrett 797, 798 and 120, 6" through 12", 123, 6" through 24", and 1202, 4" through 12" sizes, and 799 6" and 8" sizes

Center Distance Attachment	
Cat. No.	EDP
PT26151	64440



PT26151



VERNIER CALIPERS

123, 123M, 123EM MASTER VERNIER CALIPERS

0-72" AND 0-24"/0-600MM

Ultimate example of slide caliper design. It is more accurate, has the easiest reading vernier style, is stronger and offered in much longer lengths than other slide calipers.

READABILITY FEATURES

- Long 50-division vernier scales permit half as many bar graduations as conventional single-vernier tools. These widely-spaced graduations make it easy to read to .001" or 0.02mm
- The open-face design of the slide allows both the inside and outside vernier scale on the same side, thus allowing both verniers to be read without turning the tool over
- Black lines and figures against the Starrett satin chrome finish make reading a pleasure, not an effort
- Screw-type adjusting nut allows for fine measuring adjustments and lock nut holds measurements

LONG-LIFE AND ACCURACY FEATURES

- Fine tool steel construction makes the jaws harder and longer-wearing than stainless tools. All tools through 24" (600mm) also have hardened and stabilized bars.
- Hardened, ground and lapped measuring surfaces
- Machine divided graduations for accuracy
- The combination straight and angular ways on the master bar allow for positive alignment of graduations and easy adjustment of the flush-fitting verniers
- Sizes through 24" have divider points on the back side to accurately set dividers and trammels
- Tools with inch and millimeter graduations on the same bar have outside readings only. (Inside readings must be compensated for by adding the nib width to the indicated reading.)
- The longer length of the adjusting jaw slide provides a longer bearing surface on the master bar, ensuring squareness with the solid jaw and extra resistance to springing
- Tight, smoothly fitted slides for maximum accuracy and easy adjustment
- Fitted wood case option

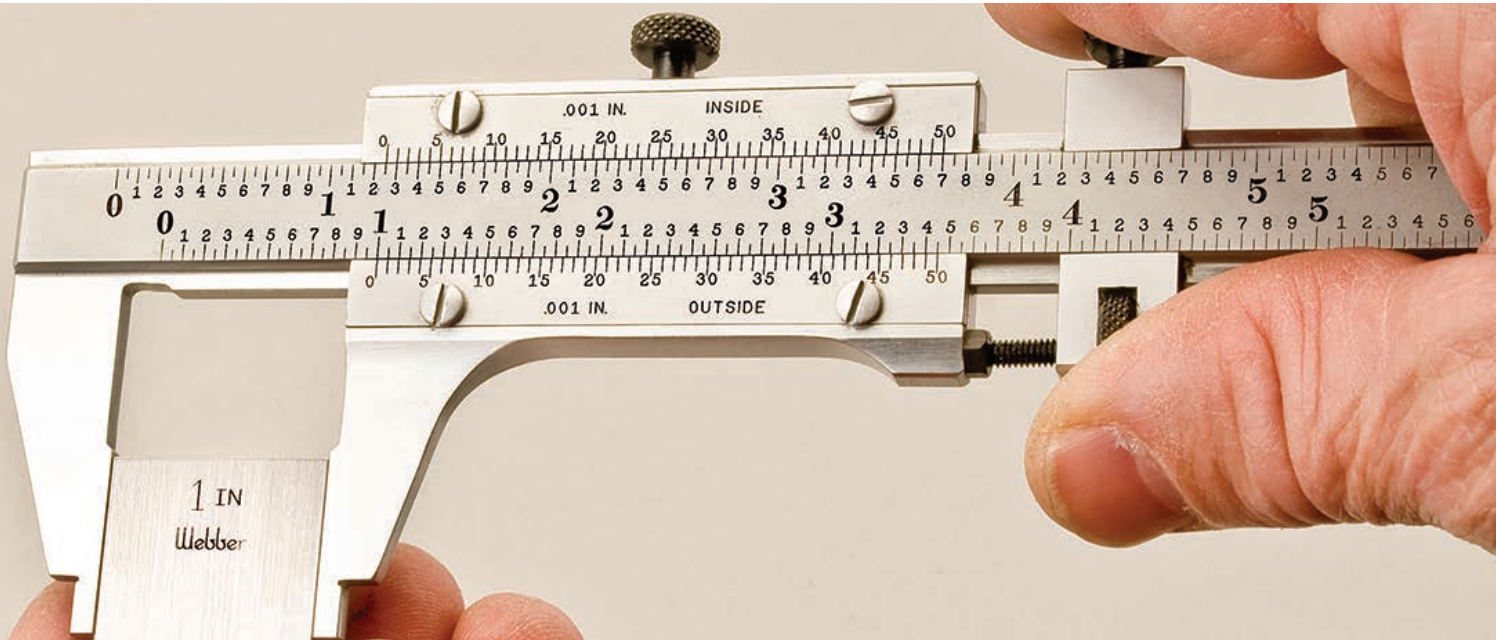
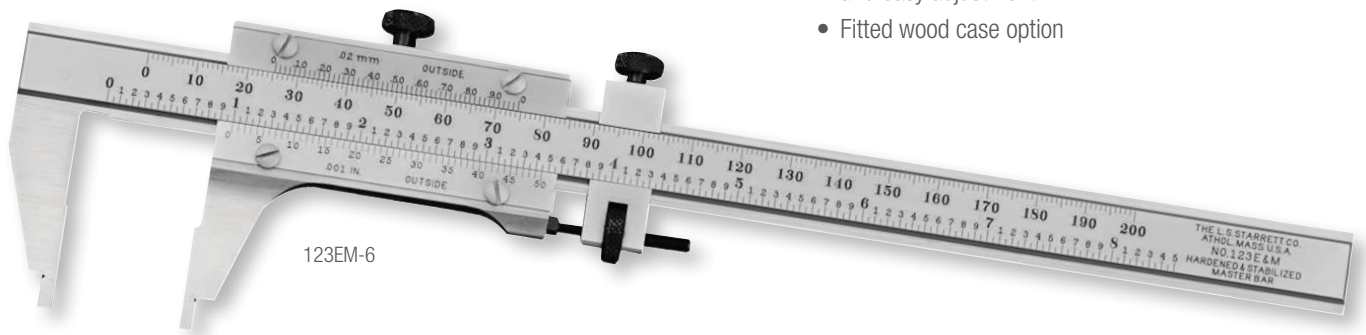

123 Master Vernier Calipers (.001" Graduation)

Cat. No.	EDP	Range	Bar Width	Approx. Jaw Depth	Max. Nib Width Closed
123Z-6	50524	0-6"	11/16"	1-9/16"	.250"
123Z-6 W/SLC*	66925				
123-6	50525				
123-6 W/SLC*	66926	0-12"	15/16"	2-5/16"	.300"
123Z-12	50526				
123Z-12 W/SLC*	66927				
123-12	50527	0-24"	15/16"	2-5/16"	.300"
123-12 W/SLC*	66928				
123Z-24	50528				
123Z-36	50530	0-36"	1-3/8"	3"	.500"
123Z-48	50532	0-48"	1-3/8"	3"	.500"
123Z-60	64383	0-60"	2-1/2"	4-1/2"	.750"

123M Master Vernier Calipers (0.02mm Graduation)

Cat. No.	EDP	Range	Bar Width	Approx. Jaw Depth	Max. Nib Width Closed
123M-150	56099	0-150mm	17.46mm	40mm	6.4mm
123MZ-300	56102	0-300mm	23.81mm	58mm	7.6mm
123M-300	56101	0-600mm	23.81mm	58mm	7.6mm
123MZ-600	56104				

123EM Master Vernier Calipers (.001" and 0.02mm Graduation)

Cat. No.	EDP	Range	Bar Width	Approx. Jaw Depth	Max. Nib Width Closed
123EMZ-6	50534	0-6" (150mm)	11/16" (17.46mm)	1-9/16" (40mm)	.250" (6.35mm)
123EM-6	50535				
123EMZ-12	50536	0-12" (300mm)	15/16" (23.81mm)	2-5/16" (58mm)	.300" (7.62mm)
123EM-12	50537				
123EMZ-24	50538	0-24" (600mm)	15/16" (23.81mm)	2-5/16" (58mm)	.300" (7.62mm)

For Inside Measurements on 123M and 123EM Master Vernier Calipers

Cat. No.	Range	Add Nib Thickness Below to Caliper Reading
123 E and M	0-6" or 150mm	.250" (Inch) or 6.35mm (Metric)
123 E and M	0-12" or 300mm	.300" (Inch) or 7.62mm (Metric)
123 E and M	0-24" or 600mm	.300" (Inch) or 7.62mm (Metric)

Other sizes available on special order – priced on application. Special jaws priced on application.

Hardened Bars on 6", 12" and 24" models: these models are also furnished with center points for dividers.

* Includes redemption card for Standard Letter of Certification (SLC).

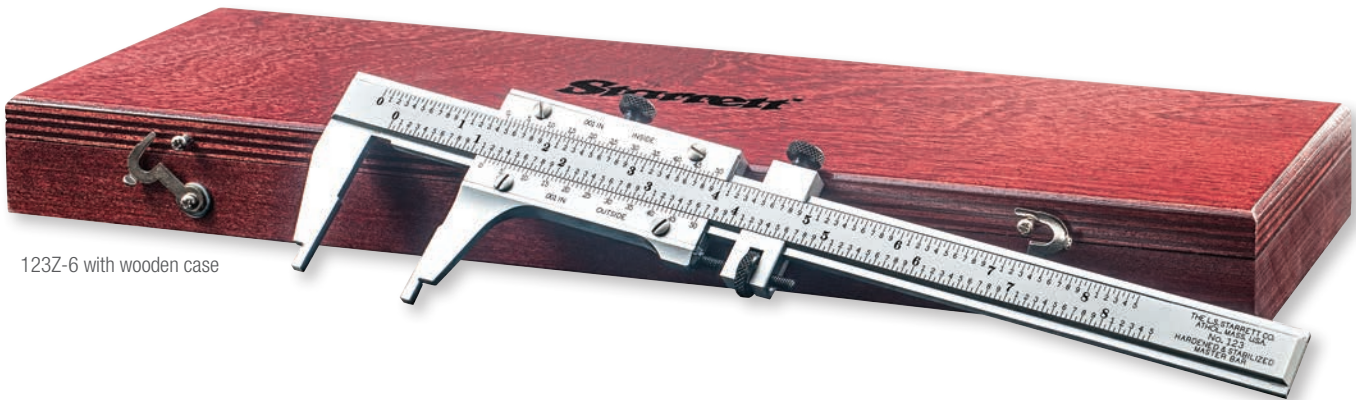

123Z-6 with wooden case



VERNIER CALIPERS

125 VERNIER CALIPERS

0-12"/0-300MM

- High quality, basic vernier caliper that offers inch and metric measurement
- Lock screw for sliding jaw
- Hardened stainless steel depth rod
- Graduations: .001" inch, 0.020mm metric
- Sharp, black graduations on the satin finished bar
- Fitted plastic case

125 Vernier Calipers			
Cat. No.	EDP	Range	
		in	mm
125MEA-6/150	61660	0-6	0-150
125MEA-8/200	61882	0-8	0-200
125MEA-12/300	61886	0-12	0-300



SLIDE CALIPERS

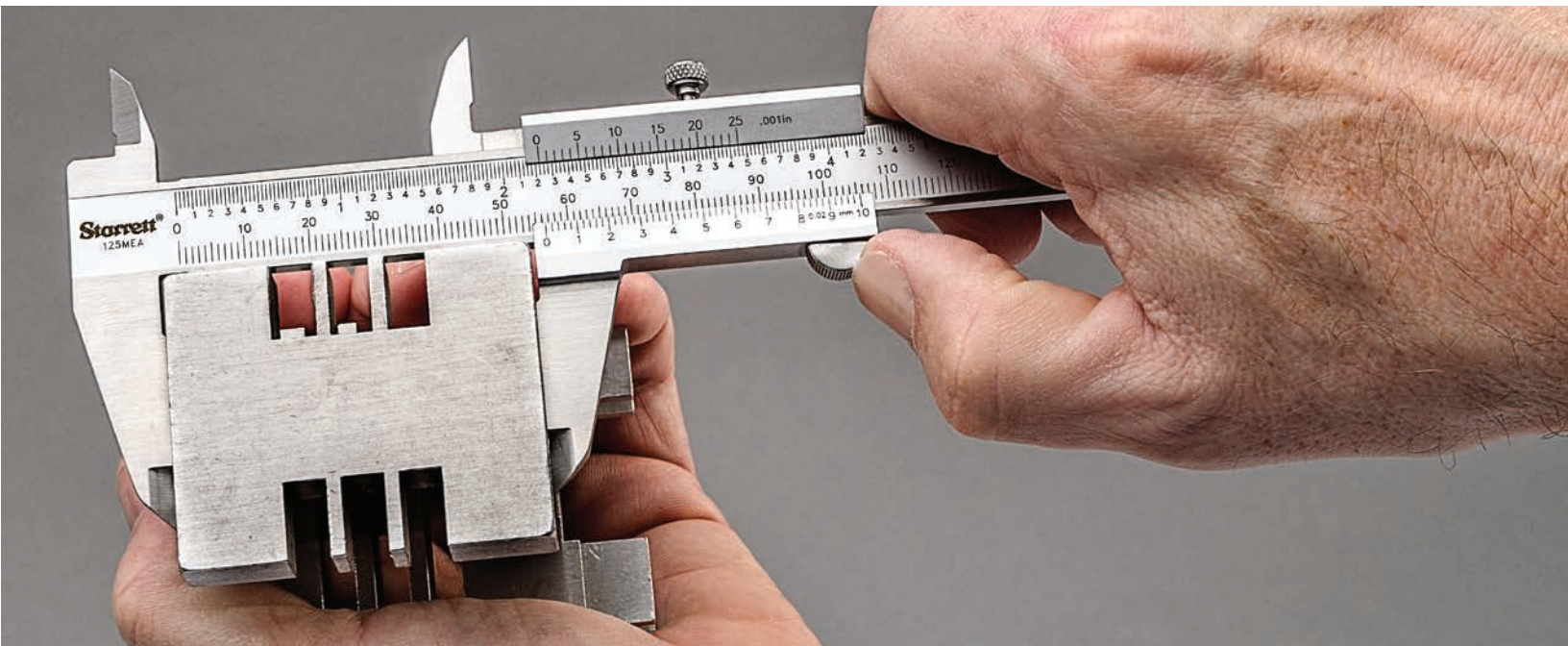

VERNIER CALIPERS

456 GEAR TOOTH VERNIER CALIPERS

20-2 DIAMETRAL PITCH

456M GEAR TOOTH VERNIER CALIPERS

1-1/4-25MM MODULE

The 456 Gear Tooth Vernier Caliper is designed to measure in .001" or 0.02mm the thickness of gear teeth at the pitch line (the chordal thickness of the teeth) using the distance from the top of a tooth to the chord. For the same purpose, it can also be used for measuring hobs, form and thread tools, etc.

The thickness of a tooth at the pitch line is measured by an adjustable jaw after the addendum is set by the adjustable tongue. Each of these is adjusted independently by screws on the graduated bars.

Graduation – .001"

Cat. No.	EDP	Range
456AZ	52420	20-2 Diametral Pitch
456A	52422	
456BZ	52424	
456B	52426	10-1 Diametral Pitch

Graduation – 0.02mm

Cat. No.	EDP	Range
456MAZ	52421	1-1/4-12mm Module
456MA	52423	
456MBZ	52425	2-1/2-25mm Module
456MB	52427	

Available with carbide measuring surfaces on special order. Available with attractive, protective case – sent with case unless otherwise ordered. Packed one in a box.

FOR TOOL OPERATION:

- Find on the chart, furnished with the tool, the number of teeth of the gear in question, and find the corrected addendum (s"). This figure is for one diametral pitch for inch measure, so divide it by the diametral pitch number – this figure is also for a one millimeter module for metric measure, so multiply it by the required module number. This gives a corrected addendum for this particular number of teeth.
- Next, measure the actual outside diameter of the gear and add or subtract one-half the difference between the theoretical gear diameter and actual measured gear diameter from the corrected addendum (s") found in the first step.
- Set the new calculated addendum figure on the adjustable tongue of the tool.
- Now, with the tongue on the top of the tooth, measure the chordal thickness with the horizontal vernier jaw and compare with the figure in the "t" column in the chart.
- All inch graduations are read to .001". However the 456A is graduated by .020" increments and the 456B is graduated by .025" increments. 456MA and 456MB are read to 0.02mm and graduated by 0.5mm increments.

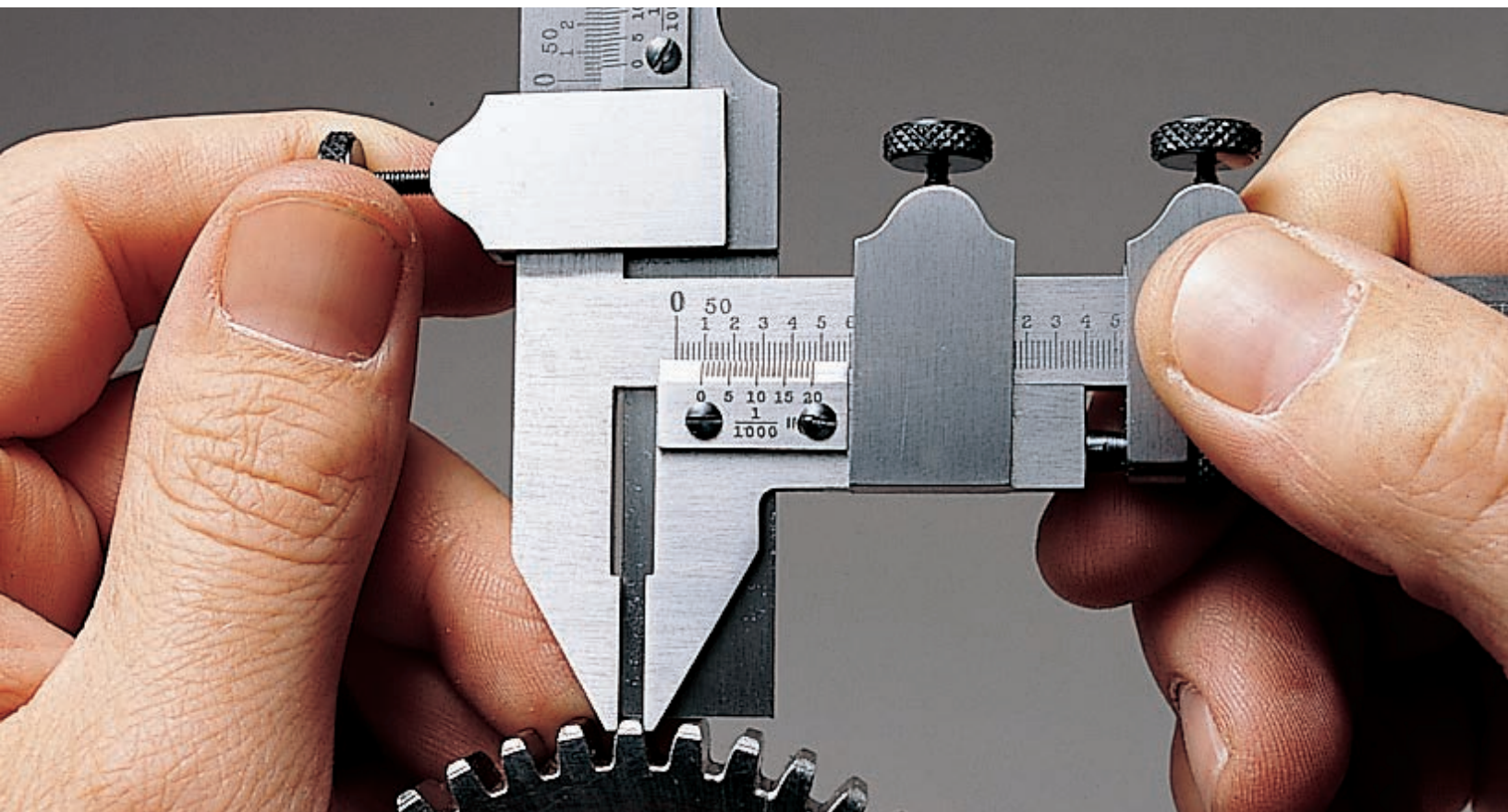

POCKET CALIPERS

1025, 1025ME STAINLESS STEEL POCKET SLIDE CALIPERS

INCH READING 5", 6"/INCH AND MILLIMETER READING 5"/130MM

These handy tools permit quick, accurate outside and inside measurements. Their compact size fits easily in shop coat pockets. Calipers are made of fine quality stainless steel.

- Readings are made directly from the two lines marked "in" and "out" on one side of the stock
- Handy inch or millimeter scale on the back of the stock
- Knurled thumb pieces to activate the slide and slide stop prevents tool from being disassembled
- Knurled clamp screw with a left hand thread for easy one-hand operation
- Straight measuring surface for outside measuring and rounded nibs for inside or hole measurements

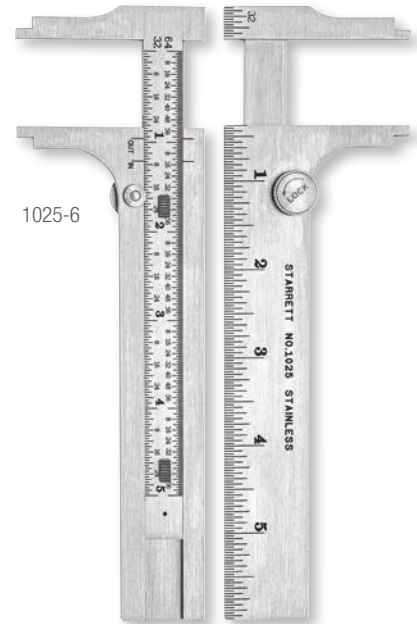

1025-6

SLIDE CALIPERS

1025 Stainless Steel Pocket Slide Calipers

Cat. No.	EDP	Size	Range		Depth of Jaws	Width of Nibs Closed	Graduations Slide	Stock
			Outside	Inside				
1025-5	53123	5"	0-3-3/4"	1/4-4"	1-3/8"	1/4"	32nds and 64ths	32nds
1025-6	53124	6"	0-4-3/4"	1/4-5"	1-3/8"	1/4"	32nds and 64ths	32nds

1025ME Stainless Steel Pocket Slide Calipers

Cat. No.	EDP	Size	Range		Depth of Jaws	Width of Nibs Closed	Graduations Slide	Stock
			Outside	Inside				
1025ME-130	65860	5" (130mm)	0-3-3/4" (0-96mm)	1/4-4" (6-100mm)	1-3/8" or 36mm	.236" or 6mm	64ths and 1/2mm	mm

Cases for 1025 and 1025ME Pocket Slide Calipers

Cat. No.	EDP	Description
1025ZZ-5	55269	5" and 130mm Vinyl Case
1025ZZ-6	55270	6" Vinyl Case

424 STAINLESS STEEL POCKET SLIDE CALIPERS

3-1/2"

This extremely handy caliper gives direct readings of both circumference and diameter in a single setting.

- Especially useful for obtaining instant circumference and diameter measurements of rope, cordage, metal rods, pipe, tubing, etc. and for checking cutting speeds on lathe work
- 1-3/8" deep jaws will caliper a cylinder up to 2-3/4" diameter
- The upper edge of the slide is graduated from 0 to 11 circumference inches in 16ths and the lower edge

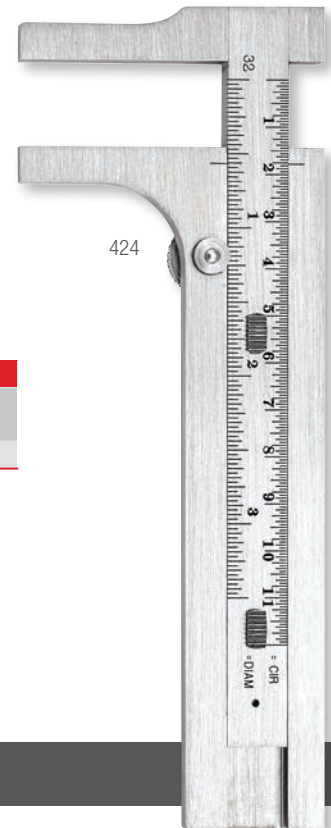

424

424 Stainless Steel Pocket Slide Caliper and Circumference Gage

Cat. No.	EDP	Size	Range		Graduations		Depth of Jaws
			Dia.	Circumference	Dia.	Circumference	
424	51527	3-1/2"	0-3-1/2"	0-11"	32nds	16ths	1-3/8"

Cutting Speed in Feet per Minute = Circumference divided by 12 x Revolutions per Minute

