

STEINEL[®]
PROFESSIONAL



Heat at work.

Professional Tools for Professional Results

Hot Air
Barrel Tools

Pistol Grip
Hot Air Tools

Hot Air
Specials

Precision
Hot Air Tool

Professional
Heat Blower

Hot Air Tool
Accessories

Gas
Torches

Hot-Melt
Adhesive Systems

from page 4

from page 18

from page 36

from page 44

from page 46

from page 50

from page 58

from page 72

HG 2620 E
HG Scan PRO
HG 2220 E
HG 5000 E

HG 2520 E
HG Scan PRO
HG 2320 E / ESD
HL 2020 E
HL 1920 E
HL Scan
HL 1820 S
HL 1620 S

HG 2320 E Kits
HL 2020 E Kits
HL 1920 E Kits
HL 1820 E Kit

HG 350 ESD

HB 1750

Everything for welding floor-
ings, plastics, tarpaulins
and roof sheetings,
removing and shaping,
heat-shrinking, desoldering
and spot heating,
special accessories

Ultimate Butane Kit
TT 270
TT 175
TT 151
TT 30
TS 600 / TS 600 K
TS 550 / TS 550 K
TS 500 / TS 500 K
TH 310

TM 6000
GF 3002



Hot Air Barrel Tools:
Ideal for roofers and floor layers.

Welding, heat-shrinking, shaping, removing – hot air makes all sorts of jobs
incredibly easy. Jobs that demand precision, high performance and reliability.



Professional Floor Layer
"The STEINEL HG 2620 E is
the best tool for floor laying."

The art of understanding heat.

Precision and control on hot air tools is imperative for a wide range of technical applications. STEINEL only uses top quality, long-lasting components that come from our development history. This is where our customers benefit from over 30 years of experience in developing and manufacturing hot air tools to give them a product that has been cleverly engineered in every last detail, only delivering heat where it is needed.

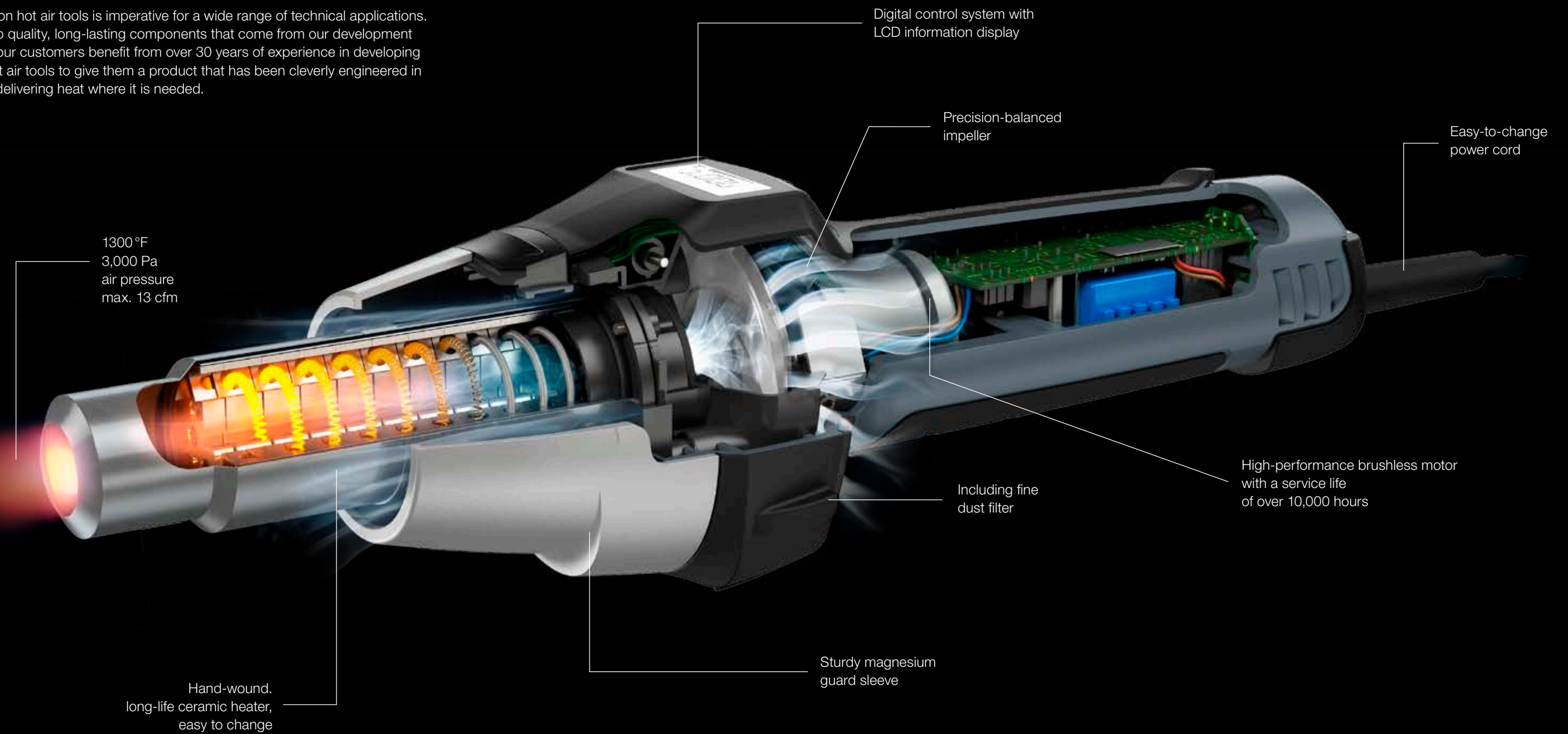

Ideal for the trades and industry. Our flagship.
Hot air tool **HG 2620 E**

If you want the best when it comes to performance and precision: Delivering 1750W of power, the HG 2620 E hot air tool is controlled by a toggle in 10°F steps between 120- 1300°F while letting you set four individually tailored programs. The temperature is indicated on the LCD information display where it is easy to read at any time. The airflow rate is continuously variable between 2-13 cfm and is easy to adjust. Full air-pressure power is 3,000 Pa. The powerful brushless motor gives our flagship tool a working life of over 10,000 hours. Thanks to its robust design as well as the specially protected electronics with fine dust filter, four individually selectable programs and the heavy-duty H07 power cord, it is the safest, most dependable heat tool on any construction site.



Also available in a convenient carrying case.



Welding linoleum floors.

LCD display always in view	Single-hand operation by toggle	Magnesium guard sleeve, plug-in heating element	Residual heat indicator
Restart protection	Includes fine dust filter	Replaceable power cord	Ergonomic soft grip handle

Technical specifications

Power: 1750W
Amps: 14.8A
Temperature: 120 - 1300°F (50-700 °C)
Airflow rate: 2 - 13 cfm (+/- 0.5 cfm)
Air pressure: 3,000Pa
Motor: brushless
Motor life: 10,000 hours
Temperature setting: on display, in 10°F steps by toggle
Heating element: ceramic heating element
Lockable Override Control (LOC): yes
Create Preset Customizable Programs: yes
Thermal cutout: yes
Double Insulated: yes
Power Cord: Industrial grade rubber
Nozzle Diameter: 1.26" (32.00mm)
Dimensions (l x w x h): 14.10" x 3.60" x 3.70"
Voltage: 120VAC, 50/60Hz
Weight: 1.85lbs (29.63oz)
Warranty: One year limited

Ordering details

110025600 (HG 2620 E in a folding box), 3.26lbs (52.10 oz)
110047485 (HG 2620 E in a case), 5.17lbs (82.65 oz)

Accessories

110033508 HG Scan PRO for HG 2620 E
Professional STEINEL nozzles from page 50



HG Scan optional



Fits all 1.26" diameter Industry Standard Nozzles

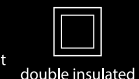

For safety and precision.
Temperature scanner **HG Scan PRO** for HG 2620 E

With the HG Scan PRO, you can be sure of the exact temperature at the work piece. It works in a range of 30 - 570 °F (0 - 300 °C) with absolute precision – and informs you visually as well as audibly if the temperature exceeds or falls below the level you have set. The integrated laser technology ensures the ideal distance from the work piece. And being perfectly compatible with our top HG 2620 E and HG 2520 E tools, all relevant data are intelligently communicated between scanner and hot air tool. The particularly clever way to complement your set of tools.



Hot air and temperature measurement with one hand.

Visual warning: too hot = red	Ideal tempera- ture = green	Visual warning: too cold = blue
Audible warning	Laser technology for maintaining perfect distance	Intelligent data communication

Technical specifications
Power supplied from hot air tool
Temperature detection range: 30 - 570 °F (0 - 300 °C), adjustable in 10 °F steps
Optimum distance from workpiece: 3.94"
Emissivity level: user-selectable, adjustable from 0.10 to 0.99
Dimensions (l x w x h): 3.70" x 3.70" x 6.00"
Weight: 0.26 lbs (4.23 oz)
Warranty: One year limited

Ordering details
110033508 (folding box), 0.37 lbs (6.00 oz)

Ideal for all heat-sensitive materials



Film, sheeting, foil Wood Textiles



Plastic Leather

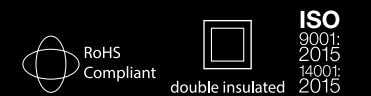

Slim. Lightweight. Ergonomic.
Hot air tool **HG 2220 E**

The HG2220 E weighs only 1.34 pounds (610g) and has a powerful 1500W motor that heats the flow of air across a continuously variable temperature range of 167 - 1166 °F (80 - 630 °C) via an easily adjustable thumbwheel. Nozzles are push-on and simple to attach. A perfect tool for all professionals with a preference for practical things – and, thanks to fine dust filter and long-life brush motor, who also want it to give them lasting service.



Professional edgebanding.



Two-stage airflow



Continuously variable temperature setting



Fine dust filter included



Ergonomic soft grip handle



Replaceable power cord



Fits all 1.34" diameter Industry Standard Nozzles

Technical specifications

Power: 1500 W
Amps: 12.5 A
Temperature: 120 - 1100 °F (50-600 °C)
Airflow rate: 4-7/6-12 cfm (+/- 0.5 cfm)
Temperature setting: thumbwheel
Heating element: ceramic heating element
Thermal cutout: yes
Double Insulated: yes
Power Cord: Industrial grade rubber, length: 6ft
Nozzle Diameter: 1.34" (34.00 mm)
Dimensions (l x w x h): 13.30" x 3.00" x 3.50"
Voltage: 120 VAC, 50/60 HZ
Weight: 1.34 lbs (21.51 oz)
Warranty: One year limited

Ordering details

110025601 (folding box), 2.59lbs (41.48 oz)

Accessories

Pressure fit standard nozzles from page 53



Our most powerful tool. 3400W, 28cfm.
Hot air tool **HG 5000 E**

Bursting with strength and staying power: with its powerful 3400W brushless motor rated for 20,000 hours of service, the HG 5000 E delivers up to 800 litres of air a minute over an infinitely variable temperature range of 80-1100°F (20-600°C). Its generously sized outlet nozzle reaches a pressure of 3,000 Pa. Making it the ideal tool for working on large surfaces. From fully electronic temperature and airflow adjustment to intelligent motor and temperature control and clearly structured LED segment display, it comes with everything that professionals need for working with hot air in industry. The mains power cord and heater are particularly easy to change. Changing the screw-on nozzle attachment is just as simple.



Also available in a convenient carrying case.



Overlap welding on a light dome.



LED segment display



Plug-in heating element



Replaceable power cord



Fits Speciality STEINEL Nozzles

Technical specifications

Power: 3400 W
Amps: 14.8 A
Temperature: 80 - 1100°F (20 - 600°C)
Airflow rate: max. 28 cfm (+/- 0.5 cfm)
Air pressure: 3,000 Pa
Motor: brushless
Motor life: 20,000 hours
Temperature setting: continuously variable in 10°F steps
Heating element: ceramic heating element
Thermal cutout: yes
Double Insulated: yes
Power Cord: Industrial grade rubber (European Plug)
Nozzle Diameter: 1.97" (50.00 mm)
Dimensions (l x w x h): 14.50" x 4.30" x 4.30"
Voltage: 230 VAC, 50 HZ
Weight: 2.62 lbs (41.98 oz)
Warranty: One year limited

Ordering details

104201504 (folding box), 3.70lbs (59.20 oz)
110049782 (case), 10.80lbs (172.60 oz)

Accessories

Speciality STEINEL nozzles from page 50





▲ Welding linoleum
HG 2620 E

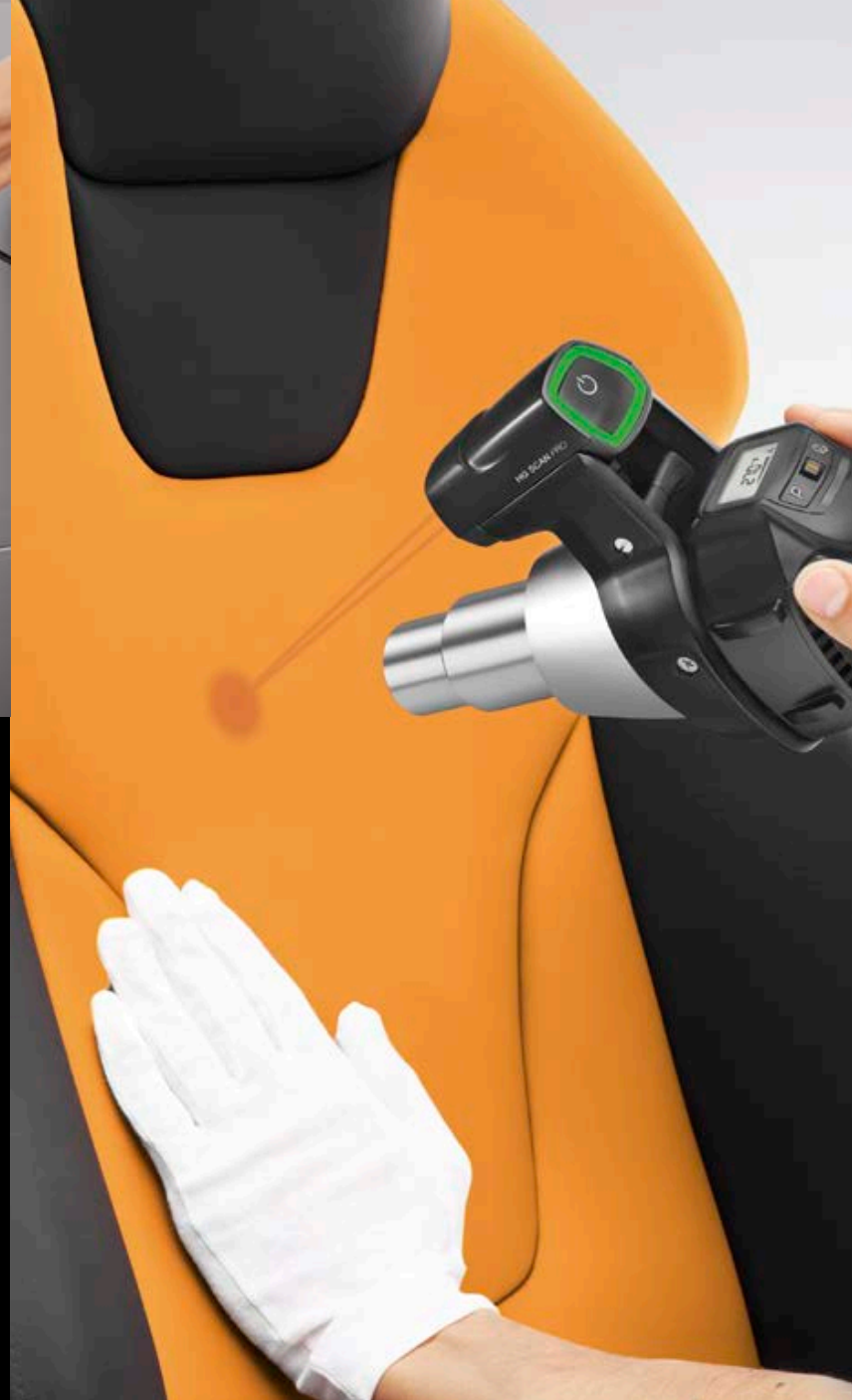

▲ Smoothing leather
HG 2620 E



◀ Overlap welding
HG 2620 E

Experts in every field. Summary of applications.

There's a lot you can do with hot air. And take care of all sorts of jobs with ease, reliability and precision. This is where you will always find the right professional barrel air tool from STEINEL for a virtually unlimited range of applications in industry and the trades.



	HG 2620 E	HG 2220 E	HG 5000 E
Welding / repairing truck side curtains and advertising banners	+++	+	++
Welding / repairing pond liner / landfill membranes, pool construction	+++	+	+++
Car wrapping, window tinting, facade wrapping	+ ⁽¹⁾	+	+
Welding plastics in tank and apparatus construction	+++	+	+++
Smoothing leather	+++ ⁽¹⁾	+	+
Welding roof sheeting	+++		+++
Welding floorings	+++	+	
Heat-shrinking	+++	+++	+++
Drying and heating	+++ ⁽¹⁾	++	+++
Desoldering components from circuit boards	+++	+	
Shaping plastics	+++	+	+++
Stripping oil-based paints / removing sheeting, films and foils	+++	++	+++
Woodworking, edgebanding, redecorating work	+++	++	+++
Refurbishment work, removing tiles	+++		+++
Packaging / shrink-wrapping	+++	++	+++

⁽¹⁾ Using HG Scan PRO

Pistol Grip Hot Air Tool: Pulling out all the stops at work.

Absolute precision is essential when working with a heat tool. It should fit perfectly in your hand and let you work without tiring. This is why we have focused on ergonomics when developing our pistol-type hot air tools. Long life, exact temperature settings, and ease of operation with just one hand are part of the standard repertoire at STEINEL.



Professional Electrician
"Precision is important in my line of work, so I need a heat gun that provides control and accuracy, so I chose STEINEL."

More power. More heat. More life time with brushless motor
Hot air tool **HG 2520 E**

STEINEL's strongest pistol grip hot air tool is equipped with a powerful and extremely durable brushless motor that produces hot air up to 3,000 Pa with absolute precision. The temperature can be varied by toggle with one hand in 10°F steps and read from the clear LCD information display at any time. It's just as easy to adjust the airflow rate between 2-13 cfm and select any of the four individually tailored programs. Weight in at a mere 1.85lbs, this professional hot air tool is perfect for construction site use and uses professional standard nozzles.



Also available in a convenient carrying case.



1300 °F
max.
13 cfm

ELECTRONIC CONTROL



Welding plastic in tank and apparatus construction.



Single-hand operation by toggle



LCD information display always in view



Residual heat indicator



Replaceable power cord



Plug-in heating element



Non-slip standing surface



Built in hanger

Technical specifications

Power: 1750 W
Amps: 14.8 A
Temperature: 120 - 1300 °F (50 - 700 °C)
Airflow rate: 2 - 13 cfm (+/- 0.5 cfm)
Air pressure: 3,000 Pa
Motor: brushless
Motor life: 10,000 hours
Temperature setting: on display, in 10 °F steps by toggle
Heating element: ceramic heating element
Lockable Override Control (LOC): yes
Create Preset Customizable Programs: yes
Thermal cutout: yes
Double Insulated: yes
Power Cord: Industrial grade rubber
Nozzle Diameter: 1.26" (32.00 mm)
Dimensions (l x w x h): 11.20" x 3.80" x 8.20"
Voltage: 120 VAC, 50/60 HZ
Weight: 1.85 lbs (29.63 oz)
Warranty: One year limited

Ordering details

110025599 (HG 2520 E in a Case), 5.15 lbs (82.44 oz)

Accessories

110033594 HG Scan PRO for HG 2520 E
Professional STEINEL nozzles from page 50



HG Scan optional



Fits all 1.26" diameter Industry Standard Nozzles

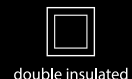

Absolute precision. From the word go.
 Temperature scanner **HG Scan PRO** for HG 2520 E

Precise, reliable, intelligent: the HG Scan PRO is the ideal addition to the HG 2520 E hot air tool. Once fitted on the housing you will have complete control of current temperature and distance from the work surface. Interactive data communication between tool and scanner as well as audio and visual signals let you keep everything in the optimum range. To make your work even easier.



Smoothing leather with the HG Scan PRO.



Visual warning: too hot = red



Ideal temperature = green



Visual warning: too cold = blue



Audible warning



Laser technology for maintaining perfect distance



Intelligent data communication

Technical specifications

Power supplied from hot air tool
 Temperature detection range: 30 - 570 °F (0 - 300 °C), adjustable in 10 °F steps
 Optimum distance from workpiece: 3.94"
 Emissivity level: user-selectable, adjustable from 0.10 to 0.99
 Dimensions (l x w x h): 3.50" x 2.20" x 3.00"
 Weight: 0.19 lbs (2.30 oz)
 Warranty: One year limited

Ordering details

110033594 (HG Scan PRO in a folding box), 0.40 lbs (6.49 oz)

Ideal for all heat-sensitive materials



Film, sheeting, foil

Wood

Textiles



Plastic

Leather



Digital precision. Heat gun **HG 2320 E**

Cutting-edge technology for perfect results: The HG 2320 E generates an impressive 1,600 watts of power and delivers hot air between 120 and 1,200 °F. Temperature is very easy to control via toggle, giving you absolute precision. Together with the residual heat indicator, the LCD information display ensures additional certainty while the four individually selectable and customizable programs provide maximum flexibility. At the same time, all tool settings can be locked using the LOC function to rule out any accidental changes. In conjunction with the various push-on nozzles from the range of accessories, the HG 2320 E is an excellent choice for working on heat-sensitive objects. The heat gun is also available in an ESD version for use in electrostatically sensitive areas.

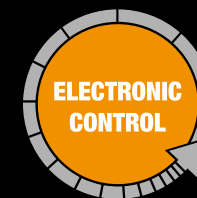

ESD Version



Shrinking cable sleeves in distribution cabinet



Two-stage
airflow



Temperature
easy to set with
toggle



LCD display and
programs



Residual heat
indicator



Replaceable
power cord



Optimised
weight balance



Rubber stand



Built in hanger

Technical specifications

Power: 1600 W
Amps: 13.5 A
Temperature: 120 - 1200 °F (50 - 650 °C)
Airflow rate stage 1: 4-7 (+/- 0.5 cfm)
stage 2: 8-13 cfm (+/- 0.5 cfm)
Temperature setting: on display,
in 10° F steps by toggle
Heating element: ceramic heating element
Lockable Override Control (LOC): yes
Create Preset Customizable Programs: yes
Thermal cutout: yes
Thermostat: yes
Double Insulated: yes
Power Cord: Industrial grade rubber
Nozzle Diameter: 1.34" (34.00 mm)
Dimensions (l x w x h): 10.00" x 3.40" x 7.90"
Voltage: 120 VAC, 50/60 HZ
Weight: 1.66 lbs (26.63 oz)
Warranty: One year limited

Ordering details

110025598 (HG 2320 E in a folding box), 2.60 lbs (41.66 oz)
110025697 (HG 2320 ESD in a folding box), 2.60 lbs (41.66 oz)
Kits see on page 38/39

Accessories

110048403 HL Scan
110028647 fine dust filter
110047650 HL Light
Pressure fit standard nozzles from page 53



HL Scan
optional



Fits all 1.34"
diameter Industry
Standard Nozzles



HL Light
optional



Fine dust filter
optional



Conquers any challenge. Heat gun HL 2020 E

Experts prefer the sturdy HL 2020 E heat gun. The electronically controlled heat tool delivering 1,600 watts of power is easily operated via toggle, regulates temperature between 120 to 1,150 °F and provides convenient handling with its LCD display. The residual heat indicator warns the user that the outlet nozzle is still hot. The precision adjustable heat and powerful blower make the HL 2020 E the ideal choice for virtually any application – heat shrinking tubes and sleeves onto cables, welding and many other challenging jobs.

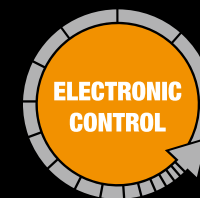

Desoldering components from circuit boards with pinpoint accuracy.



Three-stage
airflow



Temperature
easy to set with
toggle



LCD display



Residual heat
indicator



Replaceable
power cord



Optimised
weight balance



Rubber
stand



Built in hanger

Technical specifications

Power: 1600 W
Amps: 13.3 A
Temperature: 120 - 1150 °F (50 - 620 °C)
Airflow rate stage 1: 4 cfm (+/- 0.5 cfm)
stage 2: 4-8 cfm (+/- 0.5 cfm)
stage 3: 6-13 cfm (+/- 0.5 cfm)
Temperature setting: on display,
in 10° F steps by toggle
Heating element: ceramic heating element
Thermal cutout: yes
Thermostat: yes
Double Insulated: yes
Power Cord: Industrial grade rubber
Nozzle Diameter: 1.34" (34.00 mm)
Dimensions (l x w x h): 10.00" x 3.40" x 7.90"
Voltage: 120VAC, 50/60 HZ
Weight: 1.94 lbs (31.04 oz)
Warranty: One year limited

Ordering details

110025597 (folding box), 2.60 lbs (41.66 oz)
Kits see on page 40/41

Accessories

110048403 HL Scan
110028647 fine dust filter
110047650 HL Light
Pressure fit standard nozzles from page 53



HL Scan
optional



Fits all 1.34"
diameter Industry
Standard Nozzles



HL Light
optional



Fine dust filter
optional

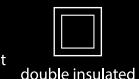

For challenging jobs.
Heat gun **HL 1920 E**

Finished to a high level of quality with optimum weight balance and long life, the HL 1920 E heat gun is an absolute "must" for anyone attaching importance to quality. The multi-talented tool impresses with 1,500 watts of power, infinitely variable temperature adjustment from 120 to 1,150°F and airflow control in three stages. And if it ever gets too hot when welding plastic or stripping paint, the automatic cut-out protects the tool from overheating.

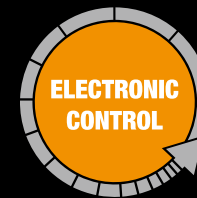

Using heat for getting plastic into exactly the right shape.



Three-stage airflow



Continuously variable temperature



Optimised weight balance



Rubber stand



Built in hanger

Technical specifications

Power: 1500 W
Amps: 13.2 A
Temperature: 120 - 1100°F (50-600°C)
Airflow rate stage 1: 4 (+/- 0.5 cfm)
stage 2: 4-8 (+/- 0.5 cfm)
stage 3: 6-13 cfm (+/- 0.5 cfm)
Temperature setting: in 9 steps by thumbwheel
Heating element: ceramic heating element
Thermal cutout: yes
Double Insulated: yes
Power Cord: Industrial grade rubber, length: 6ft
Nozzle Diameter: 1.34" (34.00 mm)
Dimensions (l x w x h): 10.00" x 3.30" x 7.90"
Voltage: 120VAC, 50/60HZ
Weight: 1.85 lbs (29.63 oz)
Warranty: One year limited

Ordering details

110025596 (folding box), 2.31 lbs (36.93oz)
Kits see on page 42

Accessories

110048403 HL Scan
110028647 fine dust filter
110047650 HL Light
Pressure fit standard nozzles from page 53



HL Scan optional



Fits all 1.34" diameter Industry Standard Nozzles



HL Light optional



Fine dust filter optional



Hot. But never too hot.
 Temperature scanner **HL Scan**
 for HG 2320 E – HL 1820 S

The right solution for every need. And for every tool. To ensure the right working temperature on heat-sensitive work pieces at all times, this is why we offer a solution for our pistol grip hot air tools that is no less intelligent. For practical single-handed operation: simply fitted to the housing of an HG 2320 E/ESD or HL 2020 E/1920 E/1820 S the HL Scan provides the user with all relevant information: the precision digital display and audio signals reliably show whether the temperature is too hot, ideal or too cold.



Ideal for carwrapping.



Visual warning:
too hot = red



Visual warning:
too cold = blue



Ideal tempera-
ture = green



Audible
warning

Technical specifications

Temperature detection range: 32 - 572 °F (0-300 °C)
 Work area marking: by LED light beam
 Optimum distance from workpiece: 5.90"
 Dimensions (l x w x h): 5.77" x 2.00" x 1.70"
 Voltage: 9 V battery
 Special features: adjustable emissivity levels and tolerance ranges
 Weight: 0.36 lbs (5.82 oz)
 Warranty: One year limited

Ordering details

110048403 (folding box), 0.58 lbs (9.28 oz)

Ideal for all heat-sensitive materials



Film,
sheeting,
foil

Wood

Textiles



Plastic

Leather



Multi-purpose heat gun. Heat gun **HL 1820 S**

On the HL 1820 S, the temperature not only adjusts from 120 to 750 to 1,100 °F in three stages – the airflow does too (4, 7 and 13 cfm). The optimized weight balance virtually rules out fatigue while working. The ergonomically shaped handle with soft inlay ensures optimum handling and the integrated thermal cut-out prevents over heating. The tool can be used with all industry standard nozzles, making all sorts of different applications even easier – for example, de-icing, drying, shaping, heat shrinking and much more.



Thawing frozen pipes.



Three-stage
airflow



Optimised
weight balance

Technical specifications

Power: 1400 W
Amps: 12 A
Temperature stage 1: 120 °F (50 °C)
stage 2: 750 °F (400 °C)
stage 3: 1100 °F (600 °C)
Airflow rate stage 1: 4 cfm (+/- 0.5 cfm)
stage 2: 7 cfm (+/- 0.5 cfm)
stage 3: 13 cfm (+/- 0.5 cfm)
Temperature setting: 3 stages
Heating element: ceramic heating element
Thermal cutout: yes
Double Insulated: yes
Power Cord: Industrial grade rubber, length: 6ft
Nozzle Diameter: 1.34" (34.00 mm)
Dimensions (l x w x h): 10.00" x 3.40" x 7.90"
Voltage: 120VAC, 50/60 HZ
Weight: 1.76 lbs (28.22 oz)
Warranty: One year limited

Ordering details

110025541 (folding box), 2.18 lbs (34.92 oz)
Kit see on page 43

Accessories

110048403 HL Scan
110028647 fine dust filter
110047650 HL Light
Pressure fit standard nozzles from page 53



HL Scan
optional



Fits all 1.34"
diameter Industry
Standard Nozzles



HL Light
optional



Fine dust filter
optional



Entry level, big advantages.
Heat gun **HL 1620 S**

Drying plaster work, heat shrinking tubes and sleeves onto cables, thawing frozen water or stripping paint – the HL 1620 S makes light work of any job, with its weight of just 1.48 pounds. Adjustable in two stages of heat and airflow (575 or 950°F, 8 or 13 cfm) the HG 1620 S comes with an optimized weight balance for fatigue free working as well as integrated thermal cut-out.



Stickers are easy to remove with hot air.



Two-stage
airflow



Optimised
weight balance



Fits all 1.34"
diameter Industry
Standard Nozzles

Technical specifications

Power: 1300 W
Amps: 10.9 A
Temperature stage 1: 575 °F (300 °C)
stage 2: 950 °F (500 °C)
Airflow rate stage 1: 8 cfm (+/- 0.5 cfm)
stage 2: 13 cfm (+/- 0.5 cfm)
Heating element: micanite heating element
Thermal cutout: yes
Double Insulated: yes
Power Cord: Industrial grade rubber, length: 6ft
Nozzle Diameter: 1.34" (34.00 mm)
Dimensions (l x w x h): 10.00" x 3.40" x 7.90"
Voltage: 120 VAC, 50/60 HZ
Weight: 1.48 lbs (23.63 oz)
Warranty: One year limited

Ordering details

110023455 (folding box), 2.06 lbs (32.98 oz)

Accessories

Pressure fit standard nozzles from page 53

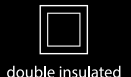

For car mechanics and auto body.

What once had to be repaired or completely replaced at great expense and painstaking effort can now be returned to perfect shape. Hot air provides the key. STEINEL has the right technology with high-quality tools that fit perfectly in your hand. Engineered to meet all the needs of automotive and auto body mechanics. STEINEL provides the right accessory for a one stop shop for precision results every time.



Car Mechanic

"STEINEL offers a full line of precision tools which end up in quality work."

HG 2320 E Kits.

Auto Body Welding Kit with Temp Scanner



HG 2320 E Heat Tool
HL Scan
Welding Iron
Reduction Nozzle 9mm
Reduction Nozzle 20mm
2 pcs Wire Mesh
16 pcs ThermoFlexx Welding Rod
Temperature Guard
Auto Body Repair Guide
Auto Body Welding DVD
Catalog
Heavy Duty Carrying Case

Ordering details
110051530

Auto Body Welding Kit



HG 2320 E Heat Tool
Welding Iron
Reduction Nozzle 9mm
Reduction Nozzle 20mm
2 pcs Wire Mesh
16 pcs ThermoFlexx Welding Rod
Temperature Guard
Auto Body Repair Guide
Auto Body Welding DVD
Catalog
Heavy Duty Carrying Case

Ordering details
110051531

Deluxe Plastic Welding Kit with Temp Scanner



HG 2320 E Heat Tool
HL Scan
TS 600 Soldering Iron
TS 600 Welding Iron
Welding Iron
Reduction Nozzle 9mm
Reduction Nozzle 20mm
2 pcs Wire Mesh
16 pcs ThermoFlexx Welding Rod
Temperature Guard
Deluxe Auto Body Repair Guide
Auto Body Welding DVD
Catalog
Heavy Duty Carrying Case

Ordering details
110051535

Deluxe Plastic Welding Kit



HG 2320 E Heat Tool
TS 600 Soldering Iron
Welding Iron
Reduction Nozzle 9mm
Reduction Nozzle 20mm
2 pcs Wire Mesh
16 pcs ThermoFlexx Welding Rod
Temperature Guard
Catalog
Heavy Duty Carrying Case

Ordering details
110051536

Electronics Kit



HG 2320 E Heat Tool
Reflector Nozzle 9mm
Reflector Nozzle 14mm
Reflector Nozzle 39mm
Reduction Nozzle 9mm
Catalog
Heavy Duty Carrying Case

Ordering details
110051533

Multi Purpose Kit



HG 2320 E Heat Tool
Reflector Nozzle 9mm
Reflector Nozzle 14mm
Reflector Nozzle 39mm
Reduction Nozzle 9mm
Welding Nozzle
Plastic Welding Rod Assortment
Plastic Welding Booklet
Catalog
Heavy Duty Carrying Case

Ordering details
110051534

HL 2020 E Kits

Automotive Kit with Temp Scanner



HL 2020 E Heat Tool
HL Scan
Reflector Nozzle 14mm
Reflector Nozzle 39mm
Reduction Nozzle 9mm
Reduction Nozzle 20mm
Window Nozzle 75mm
Welding Nozzle
PP Plastic Welding Rods
Plastic Welding Book
Auto Body Welding DVD
Catalog
Heavy Duty Carrying Case

Ordering details
110051550

Automotive Kit



HL 2020 E Heat Tool
Reflector Nozzle 14mm
Reflector Nozzle 39mm
Reduction Nozzle 9mm
Reduction Nozzle 20mm
Window Nozzle 75mm
Welding Nozzle
PP Plastic Welding Rods
Plastic Welding Book
Auto Body Welding DVD
Catalog
Heavy Duty Carrying Case

Ordering details
110051537

Plastic Welding Kit



HL 2020 E Heat Tool
Welding Nozzle
Lap Welding Slit Nozzle 20mm
Reduction Nozzle 9mm
Reflector Nozzle 39mm
2 pcs Wire Mesh
Plastic Welding Rod Assortment
Plastic Welding Booklet
Catalog
Heavy Duty Carrying Case

Ordering details
110051538

Silver Kit



HL 2020 E Heat Tool
Spreader Nozzle 75mm
Reflector Nozzle 14mm
Reflector Nozzle 39mm
Reduction Nozzle 9mm
Welding Nozzle
Plastic Welding Rod Assortment
Shrink Tubes
Plastic Welding Booklet
Catalog
Silver Case

Ordering details
110051541

Platinum Kit



HL 2020 E Heat Tool
Spreader Nozzle 75mm
Reflector Nozzle 14mm
Reflector Nozzle 39mm
Reduction Nozzle 9mm
Shrink Tubes
Catalog
Silver Case

Ordering details
110051542

Multi Purpose Kit



HL 2020 E Heat Tool
Reflector Nozzle 9mm
Reflector Nozzle 14mm
Reflector Nozzle 39mm
Reduction Nozzle 9mm
Welding Nozzle
Welding Rod Assortment
Plastic Welding Booklet
Catalog
Heavy Duty Carrying Case

Ordering details
110051539

HL 1920 E Kits

HL 1820 S

Industrial Kit



HL 1920 E Heat Tool
Reflector Nozzle 14mm
Reflector Nozzle 39mm
Reduction Nozzle 9mm
Reduction Nozzle 20mm
Spreader Nozzle 75mm
Catalog
Heavy Duty Carrying Case

Ordering details
110051543

Platinum Kit



HL 1920 E Heat Tool
Spreader Nozzle 75mm
Reflector Nozzle 14mm
Reflector Nozzle 39mm
Reduction Nozzle 9mm
Shrink Tubes
Catalog
Silver Case

Ordering details
110051545

Classic Kit



HL 1920 E Heat Tool
Reflector Nozzle 14mm
Reflector Nozzle 39mm
Reduction Nozzle 9mm
Catalog
Silver Case

Ordering details
110051546

Multi Purpose Kit



HL 1920 E Heat Tool
Reflector Nozzle 9mm
Reflector Nozzle 14mm
Reflector Nozzle 39mm
Reduction Nozzle 9mm
Welding Nozzle
Welding Rod Assortment
Plastic Welding Booklet
Catalog
Heavy Duty Carrying Case

Ordering details
110051544

General Purpose Kit



HL 1820 S Heat Tool
Reduction Nozzle 20mm
Spreader Nozzle 75mm
Reflector Nozzle 39mm
Window Nozzle 75mm
Catalog
Heavy Duty Carrying Case

Ordering details
110051547

Making easy work of soldering, de-soldering,
heat-shrinking.
Heat gun **HG 350 ESD**

The high-tech HG 350 ESD heat gun impresses with maximum precision and optimized ergonomics. The temperature can reach 750 °F as well as 930 °F when using a reduction nozzle. A temperature indicator shows whether the outlet tube is too hot to touch, this tool also comes with an integrated LED light that always provides optimum illumination and perfect visibility. The tool is also ESD-safe, also making it suitable for use in electrostatically sensitive areas. This tool is compact and includes a lightweight design.



Also available in a convenient carrying case.

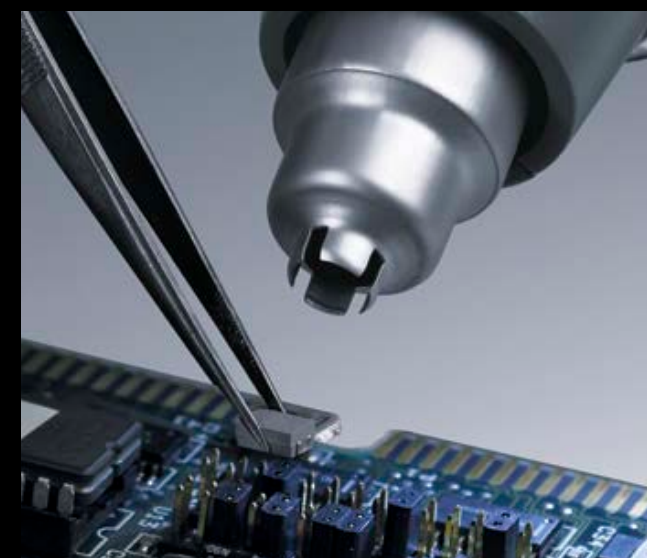

Ideal for desoldering



Integrated LED work light



Optimised weight balance



Ergonomically shaped soft-grip handle



Off/cold/hot



Built in hanger

Technical specifications

Power: 300 W
Amps: 2.5 A
Temperature: 750 - 930 °F (400-500 °C)
Airflow rate: 3.5 cfm
Power Cord: Industrial grade rubber, length: 6ft
Nozzle Diameter: 0.75" (19 mm)
Dimensions (l x w x h): 9.00" x 11.50" x 3.00"
Voltage: 120 VAC, 50/60 HZ
Weight: 1.50 lbs (24.00 oz)
Warranty: One year limited

Ordering details

109964900 (folding box), 2.05 lbs (32.80 oz)
110049739 (Precision Heat Gun Kit), silver case, including Reduction Nozzle 7 mm, Reducer with Guard 5 mm, Reflector Nozzle 10 mm, Precision Reflector Nozzle, Reflector Nozzle 40 mm, Solder Dispenser, Shrink Tube Assortment

Accessories

Push-on nozzles on page 52



More is better.
Heat blower **HB 1750**

Maximum power for perfect results: The HB 1750 delivers almost 30 percent more air than conventional heat blowers. This makes particularly fast and efficient work of any job – whether drying paint, shaping plastic, heating shrink film or heat shrinking tubes and sleeves onto cables. Five interchangeable color coded keys can be used for selecting the perfect temperature for any job from 100 to 1,200°F. Comes complete with an adjustable support stand, this extremely quiet tool is suitable for stationary use. The support stand also provides a practical place to keep the color coded keys that are not being used. The soft grip handle guarantees maximum comfort even after long periods of use.



Also available in a convenient carrying case.



Drying plasterwork faster with hot air.



Adjustable Stand



Baffle Adjusts Air and Temperature within Range



Cool Air Stage



Quick and easy field changeable element



Simple change of temperature keys

Technical specifications

Power: 1750 W
Amps: 14.6 A
Temperature: 200° - 1200 °F (95° - 650 °C) all 5 keys
Airflow rate: up to 23 cfm, adjustable with baffle
Power Cord: Industrial grade rubber, length: 6ft
Nozzle Diameter: 1.70" (43.50 mm)
Dimensions (l x w x h): 10.80" x 5.80" x 9.50"
Voltage: 120 VAC, 50/60 HZ
Weight: 2.90 lbs (46.40 oz)
Warranty: One year limited

Ordering details

109486800 HB 1750 with all 5 keys (folding box), 3.60 lbs (57.60 oz)
110049973 HB 1750 with blue key (folding box)
110049974 HB 1750 with gray key (folding box)
110049975 HB 1750 with yellow key (folding box)
110049976 HB 1750 with orange key (folding box)
110049977 HB 1750 with red key (folding box)
110049745 HB 1750 Kit (case, including Quick Lock Stand, 5 Temperature Keys, Large Reflector, Spare Element)

Accessories
on page 53

HB 1750		200 - 1200 °F (95 - 650 °C)
HB 1750 B		200 - 300 °F (95 - 150 °C)
HB 1750 G		300 - 500 °F (150 - 260 °C)
HB 1750 Y		500 - 750 °F (260 - 400 °C)
HB 1750 O		750 - 1000 °F (400 - 540 °C)
HB 1750 R		1000 - 1200 °F (540 - 650 °C)



Professional down to every last detail. Summary of applications.

STEINEL has the right pistol grip hot air tool for every need, whichever you choose: its only really complete with the right accessories. This is where we can give you a virtually unlimited range of options.



▲ Welding plastic in tank and apparatus construction.
HG 2520 E



▲ Welding water tank
HG 2320 E



HG 2520 E



HG 2320 E/ESD



HL 2020 E



HL 1920 E



HL1820S



HL 1620 S



HG 350 ESD





















HB 1750

	HG 2520 E	HG 2320 E/ESD		HL 2020 E	HL 1920 E	HL1820S	HL 1620 S	HG 350 ESD	HB 1750
Welding / repairing truck side curtains and advertising banners	+++	+++		+++	+				
Welding / repairing pond liner / landfill membranes, pool construction	+++	+++		+++	+				
Window tinting	+++	+++		+++	++				
Vehicle wrapping, wrapping facades	+++ ⁽²⁾	+++ ⁽³⁾		+++ ⁽³⁾	+(1,3)	+	+		+++
Welding plastics in tank and apparatus construction,	+++	+++		+++	++				
Smoothing & Repairing leather / Vinyl (with HG Scan PRO)	+++ ⁽²⁾	+++ ⁽³⁾		+++ ⁽³⁾	++ ⁽³⁾	+	+		++
Welding floorings	+++	+++		+++	++				
Heat Shrink Tubing / Solder Sleeves	+++	+++		+++	+++	++	++	+++	++
Drying and heating	+++	+++		+++	+++	++	++	++	+++
Desoldering and Soldering components from circuit boards	+++	+++		+++	+++			+++	+
Shaping plastics / Prosthetics	+++	+++		+++	++	+	+	++	+++
Stripping oil-based paints / removing sheeting, films and foils	+++	+++		+++	++	+	+		+++
Woodworking, edgebanding, redecorating work	+++	+++		+++	++	+	+		++
Refurbishment work, removing tiles	+++	+++		+++	++	+	+		+
Packaging / shrink-wrapping	+++	+++		+++	++	+	+	+	+++
Heat activated Adhesives (with HG Scan Pro)	+++	+++		+++	++	+	+		++
Composites	+++	+++		+++	++	+	+	+++	++
Inflatable Repair	+++	+++		+++	++	+	+	+++	+
Medical / Clean Room Applications	+++	+++		+++	++	+	+	+++	



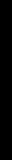
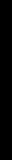
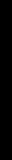

⁽¹⁾ Version with 7.5 m mains power cord, ⁽²⁾ using HG Scan PRO, ⁽³⁾ using HL Scan

Accessories for HG 2620 E, HG 2520 E

Welding floorings or spot heating

				
Speed Welding Nozzle	Speed Welding Nozzle 3mm 110038331 <small>(Pushes onto round nozzle 5mm)</small>	Speed Welding Nozzle 4mm 110038332 <small>(Pushes onto round nozzle 5mm)</small>	Speed Welding Nozzle 5mm 110038333 <small>(Pushes onto round nozzle 5mm)</small>	
				
Speed Welding Nozzle with narrow air slot	Speed Welding Nozzle, 3mm , with narrow air slot 110038676 <small>(Pushes onto round nozzle 5mm)</small>	Speed Welding Nozzle, 4mm , with narrow air slot 110039076 <small>(Pushes onto round nozzle 5mm)</small>	Speed Welding Nozzle, 5mm , with narrow air slot 110039166 <small>(Pushes onto round nozzle 5mm)</small>	
				
Round Nozzle 5mm 110048652	Round Nozzle, extended 5mm 110038668	Round Nozzle 10mm 110048653	Quarter Moon Knife 110014089	Weld Slide 110049703
				
Jointing Plane, including replacement blade 110038478	Scriber 110049706	Pressure Roller Ø 30 mm Brass roller 110048202		
				
Diamond Sharpener 110049705	ABS Plastic Welding Rods 16 pcs 110048756	PP Plastic Welding Rods 16 pcs 110048757	HDPE Plastic Welding Rods 16 pcs 110048753	PVC Plastic Welding Rods 16 pcs 110048754

For welding roof membranes,- sheetings and -tarpaulins

				
Flat Angled Nozzle 20x2 mm 110049713	Flat Angled Nozzle 20x2 mm, straight 110037580	Flat Angled Nozzle 20x2 mm, 100° 106934900	Flat Angled Nozzle 30x2 mm, 60° 110039176	
				
Flat Angled Nozzle 40x2 mm 110049712	Flat Nozzle 40x2 mm perforated 110038670	Flat Nozzle 60x2 mm for bitumen 110038674	Tarpaulin Scissors 110038728	Fillet Weld Feeder 110039165
				
Pressure Roller Ø 45 mm 110049584 <small>(with ball bearing, single arm, silicone roller)</small>	Pressure Roller Ø 35 mm 110031646 <small>(with ball bearing, single arm, silicone roller)</small>	Pressure Roller Ø 50 mm 110038455 <small>(with ball bearing, single arm, rubber roller)</small>	Pressure Roller Ø 33 mm 110048203 <small>(with ball bearing, single arm, teflon roller)</small>	

Heat-shrinking sleeves on cables, joints and mouldings

				
Soldering Reflector Nozzle 110039169	Reflector Nozzle 20mm 110039167	Reflector Nozzle 35mm 110039168	Sieve Reflector Nozzle 35x20mm 110038726	Sieve Reflector Nozzle 50x35mm 110038725
	Shell Reflector Nozzle 150x25mm 110039170 <small>(After use, the hot air tool must be securely placed in a holder with nozzle attached)</small>			

Accessories for HG 2620 E, HG 2520 E

Temperature scanner

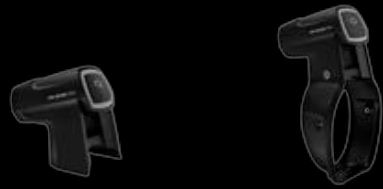

Temperature Scanner
HG Scan PRO
110033594
(HG 2520 E)

Temperature Scanner
HG Scan PRO
110033508
(HG 2620 E)

Accessories for HG 5000 E

Welding roof sheeting



Flat Nozzle 70x10mm
110049715

Flat Angled Nozzle 74x3mm
110049716

Sieve Reflector Nozzle
85x85mm
110039174
(After use, the hot air tool must be securely placed in a holder with nozzle attached)

Hinged Reflector Nozzle
72x70mm
110039171

Shell Reflector Nozzle
250x45mm
110039175

Heat-shrinking plastics

Special accessories



Heavy Duty Metal Case
103944400



Metal Heat Gun Stand
110049032

Accessories for HG 350 ESD

Soldering, de-soldering and spot heating



Reducer with
Guard 5mm
110048651

Reflector Nozzle
40mm
110049699

Reflector Nozzle
10mm
110049698

Precision Reflector Nozzle
110049697

Reduction Nozzle
7mm
110050181

Accessories for HB 1750

Drying and heat-shrinking



Reducer 7mm
110049693

Spreader 200mm
110049696

Large Reflector 50mm
110049694

Small Reflector 20mm
110049695

Key Set (5 pcs)
110050796



Blue Key
200 - 300 °F (95 - 150 °C)
110050525



Gray Key
300 - 500 °F (150 - 260 °C)
110050526



Yellow Key
500 - 750 °F (260 - 400 °C)
110050527



Orange Key
750 - 1000 °F (400 - 540 °C)
110050528



Red Key
1000 - 1200 °F (540 - 650 °C)
110050529

Accessories for HG 2220 E, HG 2320 E/ESD, HL 2020 E, HL 1920 E, HL 1820 S, HL 1620 S

Removing, shaping and heat-shrinking



Spreader Nozzle
50mm
110048643

Spreader Nozzle
75mm
110048644

Window Nozzle
50mm
110048750

Window Nozzle
75mm
110048749

Lap Welding Slit Nozzle
20mm
110048649



Reduction Nozzle
20mm
110048751



Reflector Nozzle
75mm
110048650



Reflector Nozzle
39mm
110048645

Accessories for HG 2220 E, HG 2320 E/ESD, HL 2020 E, HL 1920 E

Soldering, spot heating and heat-shrinking



Reduction Nozzle 6 mm
110037033



Set Reduction + Reflector Nozzle 9 mm
110048646



Reduction Nozzle 14 mm
110048647



Pinpoint Reducer
110049668



Reflector Nozzle 14 mm
110048752



Sieve Reflector Nozzle 50x35 mm
110038724

Welding plastics, tarpaulins and sheetings



Welding Nozzle
110048648
(Pushes onto Reduction Nozzle 9 mm)



Welding Nozzle
110048747
(Pushes onto Reduction Nozzle 9 mm)



Angle Slit Nozzle 40 mm
110048748



Wide-Slit Nozzle
102270901
(Pushes onto Reduction Nozzle 14 mm)



Pressure Roller Ø 45 mm
110049584
(with ball bearing, single arm, silicone roller)



Pressure Roller Ø 35 mm
110031646
(with ball bearing, single arm, silicone roller)



Pressure Roller Ø 50 mm
110038455
(with ball bearing, single arm, rubber roller)



Pressure Roller Ø 33 mm
110048203
(with ball bearing, single arm, teflon roller)



ABS Plastic Welding Rods 16 pcs
110048756

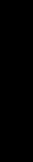

PP Plastic Welding Rods 16 pcs
110048757

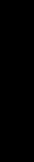

HDPE Plastic Welding Rods 16 pcs
110048753

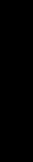

PVC Plastic Welding Rods 16 pcs
110048754



Tarpaulin Scissors
110038728

Auto Body repair accessories



Temperature Guard
110049677

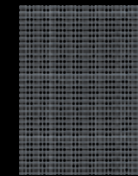

Wire Mesh
110049676

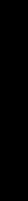

ThermoFlexx Welding Rod
110049675



Welding Iron
110050171



Reduction Nozzle 9 mm
110037435

Special accessories



Temperature Scanner HL Scan
110048403
(HG 2320 E, HL 2020 E, HL 1920 E, HL 1820 S)



HL Light
110047650
(HG 2320 E, HL 2020 E, HL 1920 E, HL 1820 S)



Fine Dust Filter
110028647
(HG 2320 E, HL 2020 E, HL 1920 E, HL 1820 S)



Hot Air Tool Stand with Suction Base
110049586
(HG 2320 E, HL 2020 E, HL 1920 E, HL 1820 S, HL 1620 S)



Hot Air Tool Stand with Magnetic Base
110049588
(HG 2320 E, HL 2020 E, HL 1920 E, HL 1820 S, HL 1620 S)



Plastic Hanger
110045172



Heavy Duty Carrying Case
110049790



Metal Heat Gun Stand
110049032



Wire Protection Tube
110049678

Products at a glance Hot air tools



	HG 2620 E	HG 2220 E	HG 5000 E	HG 2520 E	HG 2320 E / ESD	HL 2020 E	HL 1920 E	HL 1820 E	HL 1620 E	HG 350 ESD	HB 1750
Power	1750 W	1500 W	3400 W	1750 W	1600 W	1600 W	1500 W	1400 W	1300 W	300 W	1750 W
Temperature	120 - 1300 °F (50-700 °C)	120 - 1100 °F (50-600 °C)	80-1100 °F (20-600 °C)	120 - 1300 °F (50-700 °C)	120 - 1200 °F (50-650 °C)	120 - 1150 °F (50-620 °C)	120 - 1100 °F (50-600 °C)	120/750/1100 °F (50/400/600 °C)	575/950 °F (300/500 °C)	750 - 930 °F (400-500 °C)	200° - 1200 °F (95° - 650 °C) all 5 keys
Max. airflow rate	13 cfm (+/- 0.5 cfm)	12 cfm (+/- 0.5 cfm)	28 cfm (+/- 0.5 cfm)	13 cfm (+/- 0.5 cfm)	13 cfm (+/- 0.5 cfm)	13 cfm (+/- 0.5 cfm)	13 cfm (+/- 0.5 cfm)	13 cfm (+/- 0.5 cfm)	13 cfm (+/- 0.5 cfm)	3.5 cfm	23 cfm
Air pressure	3,000Pa	-	3,000Pa	3,000Pa	-	-	-	-	-	-	-
Motor	brushless	-	brushless	brushless	-	-	-	-	-	-	-
Heating element	ceramic	ceramic	ceramic	ceramic	ceramic	ceramic	ceramic	ceramic	ceramic	ceramic	-
Motor life	10,000 hours	-	20,000 hours	10,000 hours	-	-	-	-	-	-	-
Cool air stage	120 °F (50 °C)	-	80 °F (20 °C)	120 °F (50 °C)	120 °F (50 °C)	120 °F (50 °C)	120 °F (50 °C)	120 °F (50 °C)	-	-	-
Temperature setting	continuously variable	9-stage	continuously variable	continuously variable	continuously variable	continuously variable	9-stage	3-stage	2-stage	2-stage	5 coded keys
Airflow setting	continuously variable	2-stage	continuously variable	continuously variable	continuously variable	3-stage	3-stage	3-stage	2-stage	2-stage	continuously variable
Weight without power cord	1.85lbs (29.63 oz)	1.34 lbs (21.51 oz)	2.62lbs (41.98 oz)	1.85lbs (29.63 oz)	1.66lbs 26.63 oz)	1.94 lbs (31.04 oz)	1.85lbs (29.63 oz)	1.76lbs (28.22 oz)	1.48 lbs (23.63 oz)	1.50lbs (24.00 oz)	2.90lbs (46.40 oz)
Power cord	Industrial Grade Rubber	Industrial Grade Rubber, length: 6ft	Industrial Grade Rubber (European Plug)	Industrial Grade Rubber	Industrial Grade Rubber	Industrial Grade Rubber	Industrial Grade Rubber, length: 6ft	Industrial Grade Rubber, length: 6ft	Industrial Grade Rubber, length: 6ft	Industrial Grade Rubber, length: 6ft	Industrial Grade Rubber, length: 6ft
Power cord replacement	•	•	•	•	•	•					
Plug-in heating element	•		•	•							
Residual heat indicator	•			•	•						
LOC function for saving settings	•			•	•						
Four memory programs	•			•	•						
Restart protection	•			•							
Suitable for construction site use	•			•							
Thermal cut-out	•	•	•	•	•	•	•	•	•		
Overheating protection					•	•					
Professional STEINEL Nozzles	•		•	•							
Pressure Fit Standard Nozzles		•			•	•	•	•	•	•	

Gas Torches: Red-hot perfection.

Professionals know how important the right tool is. But we don't just want to offer you a tool for the job you are doing – we want to offer you the best one. This is why we are working on making our gas torches even more powerful, efficient and convenient to use. The consistent use of innovative technologies and high-quality materials lets us make sure that you can rely on the portable torches from STEINEL in any situation. Whether for the odd minor repair or for everyday use in industry



Ready for anything. Ultimate Butane Kit.

The ultimate solution for any conceivable challenge: The kit includes no fewer than three professional tools as well as a wide range of accessories. The cordless TT 175, TT 30 and TS 550 gas torches reach their respective operating temperatures within a maximum of just 20 seconds and are suitable for virtually any application – from soldering or de-soldering to working on foam and heating heat-shrinkable tubing. Providing maximum flexibility, the kit contains a wide selection of attachments that can be changed quickly and easily. Also included in the Ultimate Butane Kit are two gas bottles, cleaning tools and a selection of heat-shrinkable tubes – all perfectly packed in a high-quality tool case.



Available in a convenient carrying case.



Heat Chemicals with the ThermoTorch™ 270



Technical specifications

Temperature: TS 550: 480 - 1000°F (250 - 550°C) soldering tip
2400°F (1316°C) torch
1400°F (750°C) flamesless heat
TH 310: Catalytic Tip 1400°F (750°C)
TT 175: 2400°F (1316°C)
TT 30: 2400°F (1316°C)
Operation Time: TS 550: 160 min
TT 175: 120 min
TT 30: 30 min
Fuel Capacity: TS 550: 25 ml
TT 175: 60 ml refillable fuel tank
TT 30: 5 ml refillable see-through fuel tank
Fuel Type: Standard butane fuel
Dimensions (l x w x h): 12.60" x 4.20" x 12.30"
Weight: 4.80 lbs (76.80 oz)
Warranty: One year limited

Ordering details

110049879 (silver case, including TT 175 Torch, TT 30 Torch, TS 550 Soldering Iron, TS 21 Conical Tip (installed), 2 - 1 oz Butane Canisters, TH 310 Flameless Catalytic Tip, TS 20 Deflector, TS 25 Hot Knife, TS 23 Chisel, TS 27 Heat Blower, TS 29 Spare Orifice, Hands-Free Stand, Tip Cleaning Sponge, Solder Dispenser, Shrink Tube Assortment)

Top model for the most exacting of demands.
Gas torch **TT 270**

The ThermaTorch™ 270 keeps even the most extreme of temperatures perfectly under control: It produces a 2,500 °F flame that burns steadily and evenly all the time. The flame intensity can be infinitely varied. Featuring a refillable tank holding 60 milliliters of butane gas, the TT 270 can be operated continuously for up to 120 minutes. This makes it the ideal tool for challenging jobs whenever maximum performance is required.



Preferred choice for hundreds of applications.
Gas torch **TT 175**

From automotive repairs and plumbing jobs to industrial use, the ThermaTorch™ 175 makes very easy work of heating, soldering and de-soldering. The steady flame reaches a temperature of 2,400 °F and, like the airflow rate, can be adjusted to suit any application. In addition to its exceptional quality finish, the tool also leaves no margin of doubt with its 60-milliliter tank that enables over 120 minutes of uninterrupted use.



Solder joints on copper piping

Technical specifications

Temperature: 2500 °F (1300 °C)
Operation Time: Up to 120 min (90 min at mid setting)
Fuel Capacity: 60 ml refillable fuel tank
Fuel Type: Standard butane fuel
Ignition: Water proof piezo electronic system
Dimensions (l x w x h): 6.25" x 4.70" x 2.50"
Weight: 0.64 lb (10.24 oz)
Warranty: One year limited

Ordering details

110049861 (folding box)
Single Sell Pack Dimensions: 9.50" x 5.60" x 3.00"
Single Sell Pack Weight: 0.87 lb (13.92 oz)

Accessories

110049855 BT 01 Triple filtered Butane 1 oz (28.4 gm)
110049856 BT 05 Triple filtered Butane 5 oz (142 gm)



Butane optional



Repair, bend and mold prosthetics

Technical specifications

Temperature: 2400 °F (1316 °C)
Operation Time: 120 min continuous use
Fuel Capacity: 60 ml refillable fuel tank
Fuel Type: Standard butane fuel
Ignition: Water proof piezo electronic system
Dimensions (l x w x h): 5.25" x 4.00" x 1.50"
Weight: 0.59 lb (9.44 oz)
Warranty: One year limited

Ordering details

110049860 (folding box)
Single Sell Pack Dimensions: 7.40" x 5.50" x 1.75"
Single Sell Pack Weight: 0.78 lb (12.48 oz)

Accessories

110049855 BT 01 Triple filtered Butane 1 oz (28.4 gm)
110049856 BT 05 Triple filtered Butane 5 oz (142 gm)



Butane optional



More ergonomics, less weight.
Gas torch **TT 151**

The ThermaTorch™ 151 weighs in at a mere 0.3 pounds but is still packed with powerful advantages: The temperature of the butane flame reaches 2,400 °F and can be adjusted in any way to suit the job in hand. In addition its compact size, the multi-purpose tool impresses with its ergonomically designed grip handle and stable standing surface. The refillable butane gas tank holds 20 milliliters and produces approximately 60 minutes of work with a medium flame.



Mini-tool providing maximum performance.
Gas torch **TT 30**

Small, practical, reliable – the ThermaTorch™ 30 not only fits into any pocket, it also does a great job even under difficult conditions. The flame even burns in strong winds at an adjustable temperature of up to 2,400 °F. The ignition system is watertight. And the self-closing cap protects the tool from soiling. This makes the TT 30 a great helper in the field – whether for professional or personal use.



Caramelize Crème Brulee easily

Technical specifications

Temperature: 2400 °F (1316 °C)
Operation Time: 60 min at mid setting
Fuel Capacity: 20 ml refillable fuel tank
Fuel Type: Standard butane fuel
Ignition: Water proof piezo electronic system
Dimensions (l x w x h): 5.50" x 4.00" x 2.50"
Weight: 0.31 lb (4.96 oz)
Warranty: One year limited

Ordering details

110049860 (folding box)
Single Sell Pack Dimensions: 8.00" x 4.88" x 2.63"
Single Sell Pack Weight: 0.50 lb (8.00 oz)

Accessories

110049855 BT 01 Triple filtered Butane 1 oz (28.4 gm)
110049856 BT 05 Triple filtered Butane 5 oz (142 gm)



Butane optional



Thaw Frozen Locks with a wind proof flame.

Technical specifications

Temperature: 2400 °F (1316 °C)
Operation Time: 30 min
Fuel Capacity: 5 ml refillable see-through fuel tank
Fuel Type: Standard butane fuel
Dimensions (l x w x h): 0.88" x 0.63" x 1.50"
Weight: 0.11 lb (1.76 oz)
Warranty: One year limited

Ordering details

110049857 (blister)
Single Sell Pack Dimensions: 6.00" x 4.00" x 1.63"
Single Sell Pack Weight: 0.15 lb (2.40 oz)

Accessories

110049855 BT 01 Triple filtered Butane 1 oz (28.4 gm)
110049856 BT 05 Triple filtered Butane 5 oz (142 gm)



Butane optional

The authority in its field.
Gas soldering iron
TS 600 / TS 600 K

The ThermaSolder™ 600 lets you get more done. Its tank has a capacity of 38 milliliters, providing an amazing 200 minutes of use. But these are not the only top specifications the gas soldering iron can offer. It also produces a powerful output of 30 to 125 watts as well as temperatures of up to 2,400°F. The wide range of accessories makes it ideal for countless applications. The TS 600 K kit contains a heat blower tip that generates flameless heat of 1,400°F, a soldering tip that can be heated to 1,000°F and many other attachments for getting virtually any job done professionally and quickly.



Create an even seal on solder sleeves

Technical specifications

Soldering Iron Tip: 480 - 1000°F (250 - 550°C)
Torch: 2400°F (1316°C)
Flameless Heat: 1400°F (750°C with available hot air blower tip)
Operation Time: 200 min
Fuel Capacity: 38ml refillable fuel tank
Fuel Type: Standard butane fuel
Ignition: Piezo electronic system with 15 sec. heat-up
Dimensions (l x w x h): 9.75" x 1.20" x 1.25"
Weight: 0.34 lbs (5.44 oz)
Warranty: One year limited
Kit Contents: TS 600 Soldering Iron, Heat Blower Tip, Reflector Tip, Hot Knife Tip, Chisel Tip, Soldering Tip, Spare Orifice, Solder with Dispenser, Tip Cleaning Sponge, Protective Cap and Case

Ordering details

TS 600: 110049875 (blister)
TS 600 K: 110049876 (case)
Single Sell Pack Dimensions: TS 600 12.00" x 4.00" x 1.25"
TS 600 K 12.00" x 6.60" x 2.00"
Single Sell Pack Weight: TS 600 0.50 lb (8.00 oz)
TS 600 K 1.47 lbs (23.52 oz)

Accessories

110049855 BT 01 Triple filtered Butane 1 oz (28.4 gm)
110049856 BT 05 Triple filtered Butane 5 oz (142 gm)



Butane optional



One tool – countless options.
Gas soldering iron
TS 550 / TS 550 K

Prepared for anything: The powerful and quality-crafted ThermaSolder™ 550 gas soldering iron delivers a temperature of 2,400°F – and top results in numerous applications. The TS 550 Kit features accessories that are ideal for soldering at up to 1,000°F, cutting foam, repairing jewelry and working on many other materials with ease. The gas soldering iron can be used continuously for approximately 160 minutes on a single butane gas filling of 25 milliliters. It generates an output of 30 to 125 watts – without any power cords to get in the way. As with the TS 600, it features a reliable piezo igniter and reaches its optimum operating temperature in a mere 15 seconds.



Jewelry repair and fine detailed work

Technical specifications

Soldering Iron Tip: 480 - 1000°F (250 - 550°C)
Torch: 2400°F (1316°C)
Flameless Heat: 1400°F (750°C with available hot air blower tip)
Operation Time: 160 min
Fuel Capacity: 25ml refillable fuel tank
Fuel Type: Standard butane fuel
Ignition: Piezo electronic system with 15 sec. heat-up
Dimensions (l x w x h): 9.00" x 1.20" x 1.22"
Weight: 0.20 lb (3.20 oz)
Warranty: One year limited
Kit Contents: TS 550 Soldering Iron, Heat Blower Tip, Reflector Tip, Hot Knife Tip, Chisel Tip, Soldering Tip, Spare Orifice, Solder with Dispenser, Tip Cleaning Sponge, Protective Cap and Case

Ordering details

TS 550: 110049873 (blister)
TS 550 K: 110049874 (case)
Single Sell Pack Dimensions: TS 550 12.00" x 4.00" x 1.35"
TS 550 K 13.50" x 5.70" x 2.10"
Single Sell Pack Weight: TS 550 0.35 lb (5.60 oz)
TS 550 K 1.41 lbs (22.56 oz)

Accessories

110049855 BT 01 Triple filtered Butane 1 oz (28.4 gm)
110049856 BT 05 Triple filtered Butane 5 oz (142 gm)



Butane optional



A whole raft of benefits.
Gas soldering iron
TS 500 and TS 500 K

Heat up for 20 seconds – work for 120 minutes: The cordless ThermaSolder™ 500 has a 20-milliliter butane tank that enables uninterrupted use of the gas soldering iron even over prolonged periods. The gas soldering iron flame reaches a temperature of 2,400 °F while producing an output of 25 to 80 watts. The medium-sized TS 500 K contains the most important extras for professional soldering or de-soldering, for modeling plastics, cutting foam, fitting plug connectors and more. As with the TS 600 K and TS 550 K, all parts come in a practical case that ensures space-saving and safe storage.

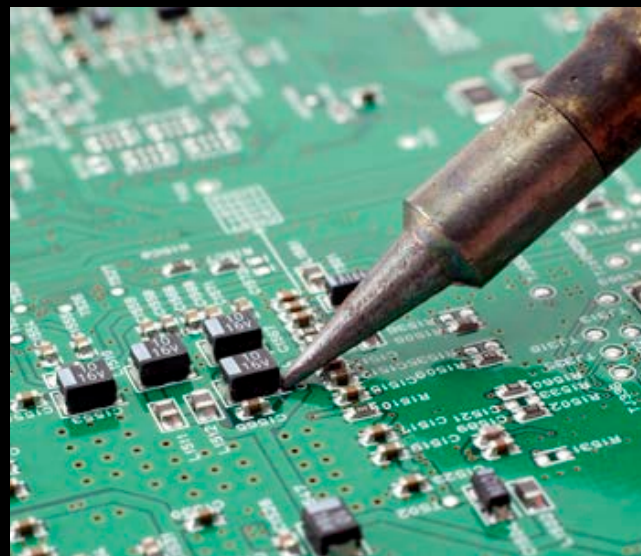

Desolder and solder circuit boards with precision

Technical specifications

Soldering Iron Tip: 410 - 850 °F (210 - 450 °C)
Torch: 2400 °F (1316 °C)
Flameless Heat: 1400 °F (750 °C with available hot air blower tip)
Operation Time: 120 min
Fuel Capacity: 20ml refillable fuel tank
Fuel Type: Standard butane fuel
Ignition: Manual ignition
Dimensions (l x w x h): 8.50" x 1.00" x 1.00"
Weight: 0.14 lb (2.24 oz)
Warranty: One year limited
Kit Contents: TS 500 Soldering Iron, Heat Blower Tip, Reflector Tip, Hot Knife Tip, Blow Torch Tip, Soldering Tip, Tip Cleaning Sponge, Protective Cap and Case

Ordering details

TS 500: 110049871 (blister)
TS 500 K: 110049872 (case)
Single Sell Pack Dimensions: TS 500 10.00" x 4.00" x 1.10"
TS 500 K 10.75" x 10.40" x 1.90"
Single Sell Pack Weight: TS 500 0.23 lb (3.68 oz)
TS 500 K 0.87 lbs (13.92 oz)

Accessories

110049855 BT 01 Triple filtered Butane 1 oz (28.4 gm)
110049856 BT 05 Triple filtered Butane 5 oz (142 gm)



Butane optional



STEINEL quality to take with you.
Gas torch **TH 310**

Whether in the workshop or in the field, the portable high-performance ThermaHeat™ 310 gas torch is always handy and reaches an operating temperature of 1,400 °F in just 15 seconds. It generates flameless heat that can be used for all manner of applications. The TH 310 comes with a convenient piezo igniter and a butane gas tank with a capacity of 38 milliliters, and can be operated for a full 120 minutes on a single tank. It also comes with an attachable deflector for working with heat-shrinkable tubing.



Including deflector



Work on dental products with accuracy

Technical specifications

Flameless Heat: 1400 °F (750 °C)
Operation Time: Up to 120 min continuous use
Fuel Capacity: 38ml refillable fuel tank
Fuel Type: Standard butane fuel
Ignition: Piezo electronic system with 15 sec. heat-up
Dimensions (l x w x h): 8.75" x 1.20" x 1.25"
Weight: 0.23 lb (3.68 oz)
Warranty: One year limited

Ordering details

110049877 (blister including deflector)
Single Sell Pack Dimensions: 12.00" x 4.00" x 1.50"
Single Sell Pack Weight: 0.30 lb (4.80 oz)

Accessories

110049855 BT 01 Triple filtered Butane 1 oz (28.4 gm)
110049856 BT 05 Triple filtered Butane 5 oz (142 gm)



Butane optional



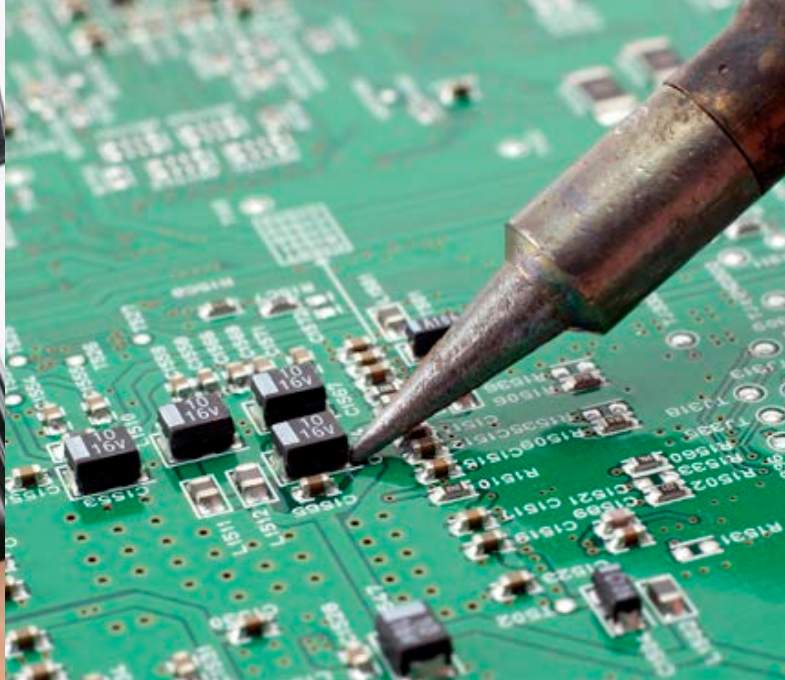

Products at a glance Gas Torches

▲ **TT270**
Solder joints on copper piping

▲ **TS 500**
Desolder and solder circuit boards with precision



TT 270



TT 175



TT 151



TT 30



TS 600



TS 550



TS 500



TH 310

Temperature	2500°F (1300°C)	2400°F (1316°C)	2400°F (1316°C)	2400°F (1316°C)	-	-	-	-
Soldering Iron Tip	-	-	-	-	480° - 1000°F (250 - 550°C)	480° - 1000°F (250 - 550°C)	410° - 850°F (210 - 450°C)	-
Torch	-	-	-	-	2400°F (1316°C)	2400°F (1316°C)	2400°F (1316°C)	-
Flamesless Heat	-	-	-	-	1400°F (750°C) with available hot air blower tip	1400°F (750°C) with available hot air blower tip	1400°F (750°C) with available hot air blower tip	1400°F (750°C)
Fuel Capacity fuel tank	60 ml refillable	60 ml refillable	20 ml refillable	5 ml refillable see-through	38 ml refillable	25 ml refillable	20 ml refillable	38 ml refillable
Operation Time	Up to 120 min (90 min at mid setting)	120 min continuous use	60 min at mid setting	30 min	200 min	160 min	120 min	Up to 120 min continuous use
Fuel Type	Standard butane fuel	Standard butane fuel	Standard butane fuel	Standard butane fuel	Standard butane fuel	Standard butane fuel	Standard butane fuel	Standard butane fuel
Ignition	Water proof piezo elec- tronic system	Water proof piezo elec- tronic system	Water proof piezo elec- tronic system	Water proof automatic ignition system	Piezo electronic system with 15 sec. heat-up	Piezo electronic system with 15 sec. heat-up	Manual ignition	Piezo electronic system with 15 sec. heat-up
Nozzle Diameter / Tip Dimensions	0.87" (22.1 mm)	0.78" (19.8 mm)	0.79" (20.0mm)	0.66" (16.75 mm)	0.06" (1.52 mm)	0.06" (1.52 mm)	0.06" (1.52 mm)	0.78" (19.9 mm)
Dimensions (l x w x h)	6.25" x 4.70" x 2.50"	5.25" x 4.00" x 1.50"	5.50" x 4.00" x 2.50"	0.88 x 0.63" x 1.50"	9.75" x 1.200" x 1.25"	9.00" x 1.20" x 1.22"	8.50" x 1.00" x 1.00"	8.75" x 1.20" x 1.25"
Weight	0.64 lb (10.24 oz)	0.59 lb (9.44 oz)	0.31 lb (4.96 oz)	0.11 lb (1.76 oz)	0.34 lb (5.44 oz)	0.20 lb (3.20 oz)	0.14 lb (2.24 oz)	0.23 lb (3.68 oz)
Warranty	One year limited	One year limited	One year limited	One year limited	One year limited	One year limited	One year limited	One year limited
Adjustable airflow setting	-	yes	-	-	-	-	-	-
Adjustable flame control	-	yes	yes	yes	-	-	-	-
Adjustable heat output	-	-	-	-	-	-	-	yes

The declaration of independence for professionals. Hot-melt glue applicator TM 6000

Full freedom of movement rather than an annoying cable: Operating on butane gas, the TM 6000 requires no electrical power source which means it can be used virtually anywhere. The extremely sturdy hot-melt glue applicator reaches its operating temperature in just 3 minutes. Its fuel cells are based on innovative LEC™ technology. The cells can be quickly changed in just a few seconds and enable continuous use for up to 100 minutes. At the same time, the TM 6000 impresses with a fast, even flow of glue during use – and stops the glue from flowing immediately afterwards. This reduces dripping to a minimum. The professional tool is suitable for glue cartridges with a diameter of 1/2 inch and a melting temperature of 320 to 464 °F.



Glue packaging with ease and efficiency.



Instant Glue Flow Cut-Off



Sturdy Metal Stand



LEC™ Fuel Cell



Ignition Button

Technical specifications

Melt Temperature: 320 °F - 464 °F (160 °C - 240 °C)
Operating Time: 100 min
Fuel Type: standard butane fuel
Ignition: Piezo electronic system
Nozzle Diameter: 0.08" (2 mm)
Dimensions (l x w x h): 9.00" x 7.50" x 2.00"
Weight: 0.75 lbs (12.00 oz)
Warranty: One year limited

Ordering details

110049878 (blister), 1.30 lbs (43.52 oz)
Single Sell Pack Dimensions: 12.50" x 12.50" x 2.20"
Single Sell Pack Weight: 1.30 lbs (43.52 oz)

Accessories

Glue sticks with 1/2" diameter on page 76

Combines simplicity and high-tech.
Hot-melt glue applicator GF 3002

Designed for making gluing work even easier: The GlueFix™ 3002 weighs just 0.7 pounds, impresses with intuitive operation and enables fatigue-free working over long periods. It produces a constant, precision flow of glue which is instantly interrupted by the anti-drip nozzle after use. Made of die-cast aluminum, the heating chamber stores heat to optimize throughput. At the same time, the unique PTC (positive temperature control) electronic heating system constantly ensures the ideal gluing temperature – throughout the entire period of use. Given its exceptional level of performance, the GF 3002 is appreciated both in industry as well as in the trades where it is used for bonding all kinds of materials.



Glue woodwork with precision



Ready for use in 7 min



Interchangeable gluing nozzles

Technical specifications

Melt Temperature: 400 °F (204 °C)
Melting Capacity: High 7.5 gm / minute
Warm Up Time: Quick 7 minutes
Nozzle Diameter: 0.08" (2mm)
Dimensions (l x w x h): 8.00" x 7.00" x 1.85"
Weight: 0.71 lb (11.36oz)
Warranty: One year limited

Ordering details

110049902 (folding box)
Single Sell Pack Dimensions: 10.25" x 6.75" x 1.75"
Single Sell Pack Weight: 1.10 lbs (17.60 oz)

Accessories

Interchangeable nozzles and glue sticks: 1/2" diameter on page 76



Better gluing results with the right glue.
The right stick for any demand.

1/2" dia. glue sticks for TM 6000 and GF 3002



G 200 C - Clear Glue Sticks
110049649, 1 lb
110049794, 1 kg



GF 14 - Carton Glue Sticks
110049643, 1 lb
110049644, 11 lbs



GF 23 - Wood Glue Sticks
110049637, 1 lb
110049638, 11 lbs



GF 213 - Laminate Glue Sticks
110049640, 1 lb
110049641, 11 lbs



GF 232 - General Purpose Glue Sticks
110049634, 1 lb
110049635, 11 lbs



GF 260 - High Strength Glue Sticks
110049646, 1 lb
110049647, 11 lbs

Interchangeable nozzles for GF 3002



Nozzle 2 mm
Ideal for all normal gluing jobs
110049583



2.8 mm Fine Tip Nozzle
Precision metering at
hard-to-reach places
110049582



1 mm Nozzle
Exact metering for high-precision
gluing applications
110019581



12 mm Spreader Nozzle
Wide nozzle for carton sealing
110049580

Application Glue Guide

	Open Time	ABS	PP / PC / HDPE / LDPE	Polystyrene	PVC	Glass Reinforced Plastic	Aluminum Stainless Steel	EPS Foam	Wood	Sand Mold	Glass	Cardboard
GF 232 General	Medium	+	+	+++	+	+	+	++++	++	++	+++	+++
GF 14 Carton	Fast	+	+	++	+	++	+++	++	+	++++	+	++++
GF 23 Wood	Long	++	+	+++	+	++	+++	+++	++++	++++	+	+++
GF 213 Laminate	Long	+	+	+++	+++	++	+++	+++	++	++	+	+++
HG 260 Hi Strength	Long	+++	+	+++	++	+++	+++	++	++++	+	+++	+++

+ Poor ++ Fair +++ Good ++++ Very Good

Summary of order numbers

Hot Air Barrel Tools

HG 2620 E	110025600 (folding box).....	9
HG 2620 E	110047485 (case).....	9
Temperature scanner HG Scan PRO for HG 2620 E	110033508 (folding box).....	11
HG 2220 E	110025601 (folding box).....	13
HG 5000 E	104201504 (folding box).....	15
HG 5000 E	110049782 (case).....	15

Pistol Grip Hot Air Tool

HG 2520 E	110025599 (case).....	21
Temperature scanner HG Scan PRO for HG 2520 E	110033594 (folding box).....	23
HG 2320 E	110025598 (folding box).....	25
HG 2320 E ESD	110025697 (folding box).....	25
HL 2020 E	110025597 (folding box).....	27
HL 1920 E	110025596 (folding box).....	29
Temperature scanner HL Scan for HG 2320 E – HL 1820 S ..	110048403 (folding box).....	31
HL 1820 S	110025541 (folding box).....	33
HL 1620 S	110023455 (folding box).....	35

Hot Air Tool Specials

HG 2320 E Auto Body Welding Kit with Temp Scanner	110051530	38
HG 2320 E Auto Body Welding Kit	110051531	38
HG 2320 E Deluxe Plastic Welding Kit with Temp Scanner....	110051535	38
HG 2320 E Deluxe Plastic Welding Kit.....	110051536	39
HG 2320 E Electronics Kit	110051533	39
HG 2320 E Multi Purpose Kit.....	110051534	39
HL 2020 E Automotive Kit with Temp Scanner	110051550	40
HL 2020 E Automotive Kit	110051537	40
HL 2020 E Plastic Welding Kit	110051538	40
HL 2020 E Silver Kit	110051541	41
HL 2020 E Platinum Kit	110051542	41
HL 2020 E Multi Purpose Kit	110051539	41
HL 1920 E Industrial Kit	110051543	42
HL 1920 E Platinum Kit.....	110051545	42
HL 1920 E Classic Kit	110051546	42
HL 1920 E Multi Purpose Kit	110051544	43
HL 1820 S General Purpose Kit.....	110051547	43

Precision Hot Air Tool

Heat gun HG 350 ESD	109964900 (folding box)	45
Heat gun HG 350 ESD	110049739 (Precision Heat Gun Kit).....	45

Professional Heat Blower

Heat blower HB 1750	109486800 HB 1750 with all 5 keys (folding box)	47
Heat blower HB 1750	110049973 HB 1750 with blue key (folding box)	47
Heat blower HB 1750	110049974 HB 1750 with gray key (folding box)	47
Heat blower HB 1750	110049975 HB 1750 with yellow key (folding box)	47
Heat blower HB 1750	110049976 HB 1750 with orange key (folding box)	47
Heat blower HB 1750	110049977 HB 1750 with red key (folding box).....	47
Heat blower HB 1750	110049745 HB 1750 Kit (case)	47

Hot Air Tool Accessories

Accessories for HG 2620 E, HG 2520 E

Speed Welding Nozzle 3 mm.....	110038331	50
Speed Welding Nozzle 4 mm.....	110038332	50
Speed Welding Nozzle 5 mm.....	110038333	50
Speed Welding Nozzle, 3 mm, with narrow air slot	110038676	50
Speed Welding Nozzle, 4 mm, with narrow air slot	110039076	50
Speed Welding Nozzle, 5 mm, with narrow air slot	110039166	50
Round Nozzle 5 mm	110048652	50
Round Nozzle, extended 5mm	110038668	50
Round Nozzle 10 mm	110048653	50
Quarter Moon Knife	110014089	50
Weld Slide	110049703	50
Jointing Plane, including replacement blade.....	110038478	50
Scriber	110049706	50
Pressure Roller Ø 30 mm Brass roller.....	110048202	50
Diamond Sharpener	110049705	50
ABS Plastic Welding Rods 16 pcs	110048756	50
PP Plastic Welding Rods 16 pcs	110048757	50
HDPE Plastic Welding Rods 16 pcs.....	110048753	50
PVC Plastic Welding Rods 16 pcs	110048754	50
Flat Angled Nozzle 20x2 mm.....	110049713	51
Flat Angled Nozzle 20x2 mm, straight	110037580	51
Flat Angled Nozzle 20x2 mm, 100°	106934900	51
Flat Angled Nozzle 30x2 mm, 60°	110039176	51
Flat Angled Nozzle 40x2 mm	110049712	51
Flat Nozzle 40x2 mm perforated	110038670	51
Flat Nozzle 60x2 mm for bitumen.....	110038674	51
Tarpaulin Scissors	110038728	51
Fillet Weld Feeder	110039165	51

Pressure Roller Ø 45 mm	110049584	51
Pressure Roller Ø 35 mm	110031646	51
Pressure Roller Ø 50 mm	110038455	51
Pressure Roller Ø 33 mm	110048203.....	51
Soldering Reflector Nozzle	110039169.....	51
Reflector Nozzle 20mm	110039167	51
Reflector Nozzle 35mm	110039168.....	51
Sieve Reflector Nozzle 35x20mm.....	110038726.....	51
Sieve Reflector Nozzle 50x35mm.....	110038725.....	51
Shell Reflector Nozzle 150x25mm.....	110039170	51

Accessories for HG 2620 E, HG 2520 E

Temperature Scanner HG Scan PRO for HG 2520 E.....	110033594.....	52
Temperature Scanner HG Scan PRO for HG 2620 E.....	110033508	52

Accessories for HG 5000 E

Flat Nozzle 70x10mm	110049715	52
Flat Angled Nozzle 74x3mm	110049716	52
Sieve Reflector Nozzle 85x85mm.....	110039174	52
Hinged Reflector Nozzle 72x70mm	110039171	52
Shell Reflector Nozzle 250x45mm.....	110039175	52
Heavy Duty Metal Case.....	103944400	52
Metal Heat Gun Stand	110049032	52

Accessories for HG 350 ESD

Reducer with Guard 5mm	110048651	52
Reflector Nozzle 40mm	110049699	52
Reflector Nozzle 10mm	110049698	52
Precision Reflector Nozzle.....	110049697	52
Reduction Nozzle 7mm	110050181	52

Accessories for HB 1750

Reducer 7mm	110049693	53
Spreader 200mm	110049696	53
Large Reflector 50mm.....	110049694	53
Small Reflector 20mm	110049695	53
Key Set (5 pcs)	110050796.....	53
Blue Key 200 - 300°F (95 - 150 °C).....	110050525.....	53
Gray Key 300 - 500°F (150 - 260 °C).....	110050526.....	53
Yellow Key 500 - 750°F (260 - 400 °C).....	110050527.....	53
Orange Key 750 - 1000°F (400 - 540 °C)	110050528.....	53
Red Key 1000 - 1200°F (540 - 650 °C).....	110050529.....	53

Accessories for HG 2220 E, HG 2320 E/ESD, HL 2020 E, HL 1920 E, HL 1820 S, HL 1620 S

Spreader Nozzle 50mm	110048643	53
Spreader Nozzle 75mm.....	110048644	53
Window Nozzle 50mm	110048750	53
Window Nozzle 75mm	110048749	53
Lap Welding Slit Nozzle 20mm.....	110048649	53
Reduction Nozzle 20mm	110048751	53
Reflector Nozzle 75mm	110048650	53
Reflector Nozzle 39mm	110048645	53

Accessories for HG 2220 E, HG 2320 E/ESD, HL 2020 E, HL 1920 E

Reduction Nozzle 6mm	110037033.....	54
Set Reduction + Reflector Nozzle 9mm	110048646	54
Reduction Nozzle 14mm	110048647	54
Pinpoint Reducer	110049668	54
Reflector Nozzle 14mm	110048752	54
Sieve Reflector Nozzle 50x35mm.....	110038724	54
Welding Nozzle	110048648	54
Welding Nozzle	110048747	54
Angle Slit Nozzle 40 mm	110048748	54
Wide-Slit Nozzle.....	102270901	54
Pressure Roller Ø 45 mm	110049584	54
Pressure Roller Ø 35 mm	110031646	54
Pressure Roller Ø 50 mm	110038455	54
Pressure Roller Ø 33 mm	110048203.....	54
ABS Plastic Welding Rods 16 pcs	110048756.....	54
PP Plastic Welding Rods 16 pcs	110048757	54
HDPE Plastic Welding Rods 16 pcs.....	110048753.....	54
PVC Plastic Welding Rods 16 pcs	110048754.....	54
Tarpaulin Scissors	110038728.....	54
Temperature Guard	110049677	55
Wire Mesh.....	110049676.....	55
ThermoFlexx Welding Rod	110049675	55
Welding Iron	110050171	55
Reduction Nozzle 9mm	110037435	55
Temperature Scanner HL Scan	110048403	55
HL Light	110047650.....	55
Fine Dust Filter	110028647	55
Hot Air Tool Stand with Suction Base.....	110049586	55
Hot Air Tool Stand with Magnetic Base	110049588	55
Plastic Hanger.....	110045172	55
Heavy Duty Carrying Case	110049790.....	55
Metal Heat Gun Stand.....	110049032	55
Wire Protection Tube	110049678.....	55

Gas Torches

Ultimate Butane Kit	110049879 (silver case).....	61
TT 270.....	110049861 (folding box).....	62
TT 175	110049860 (folding box).....	63
TT 151	110049860 (folding box).....	64
TT 30	110049857 (blister)	65
TS 600	110049875 (blister).....	66
TS 600 K.....	110049876 (case).....	66
TS 550	110049873 (blister).....	67
TS 550 K.....	110049874 (case).....	67
TS 500	110049871 (blister).....	68
TS 500 K.....	110049872 (case).....	68
TH 310	110049877 (blister including deflector)	69

Gas Torches Accessories

Triple filtered Butane 1 oz (28.4 gm)	110049855
Triple filtered Butane 5 oz (142 gm)	110049856

Hot-Melt Adhesive Systems

Hot-melt glue applicator TM 6000	110049878 (blister).....	73
Hot-melt glue applicator GF 3002	110049902 (folding box)	75

Hot-Melt Adhesive Systems Accessories

G 200 C - Clear Glue Sticks, 1 lb	110049649	76
G 200 C - Clear Glue Sticks, 1 kg	110049794.....	76
GF 14 - Carton Glue Sticks, 1 lb.....	110049643	76
GF 14 - Carton Glue Sticks, 11 lbs.....	110049644	76
GF 23 - Wood Glue Sticks, 1 lb.....	110049637.....	76
GF 23 - Wood Glue Sticks, 11 lbs	110049638	76
GF 213 - Laminate Glue Sticks, 1 lb	110049640	76
GF 213 - Laminate Glue Sticks, 11 lbs	110049641	76
GF 232 - General Purpose Glue Sticks, 1 lb.....	110049634	76
GF 232 - General Purpose Glue Sticks, 11 lbs	110049635	76
GF 260 - High Strength Glue Sticks, 1 lb.....	110049646	76
GF 260 - High Strength Glue Sticks, 11 lbs	110049647	76
Nozzle 2 mm	110049583	77
2.8 mm Fine Tip Nozzle	110049582.....	77
1 mm Nozzle	110019581	77
12 mm Spreader Nozzle	110049580	77

Quality and service.



STEINEL Brand

- STEINEL has been brand leader in hot air tools for over 30 years
- German engineering
- Produced in Europe



STEINEL Customer Service

- Phone: (952) 888-5950 (800) 852-4343
- Fax: (952) 888-5132
- Monday – Friday 7 a.m. – 5 p.m.



Certified Quality

All products from STEINEL comply with European safety standards. Despite involving a huge effort and not always easy from a technical point of view, we're never deterred. Because it's all worth it. So you get certified quality – every step of the way.



www.steinell.net

- Product overview
- Operating instructions for downloading
- Product videos



STEINEL Replacement Parts Service

- Availability guaranteed for genuine STEINEL parts



STEINEL Warranty

Our management system holds certification under Quality Standard DIN EN ISO 9001 and Environmental Management Systems Standard DIN EN ISO 14001. The warranty for STEINEL heat tools is one year from the date of original purchase.



Steinel America, Inc. | 9051 Lyndale Ave. South | Bloomington, MN 55420 | USA
Support: (800) 852-4343 | Office: (952) 888-5950 | Fax:(952) 888-5132
sales@steinel.net | www.steinel.net