

OPERATOR'S MANUAL

GH2T Gantry Lift

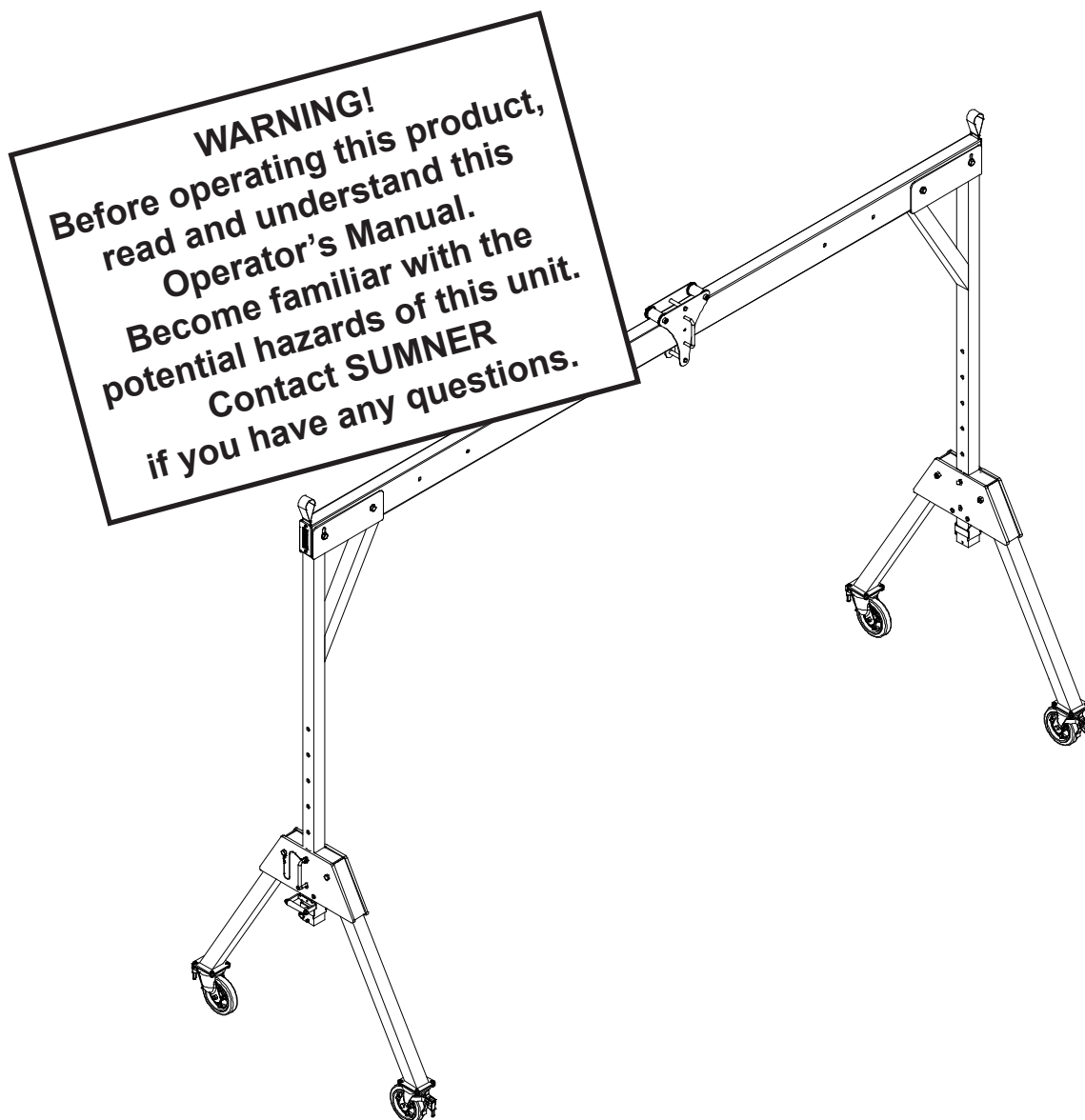

SUMNER*

 A Southwire Company

USA

7514 Alabonson Road
Houston, Texas 77088
phone: 281.999.6900
fax: 281.999.6966

CANADA

75 Saltsman Drive, Unit 5
Cambridge, ON N3H 4R7
phone: 519.653.5300
fax: 519.653.5305

NETHERLANDS

Midden Engweg 21
NL-3882TS Putten
Netherlands
europeansales@sumner.com
phone: +31 (0) 85 489 0284

UNITED KINGDOM

Unit 3 Kempton Road
Keytec 7 Business Park
Pershore, Worcestershire
WR10 2TA, UK
phone: (44) 01386 556278
fax: (44) 01386 556776

Index

Introduction.....	3
Gantry Components	3
Operator Safety Instructions.....	3
GH2T Gantry Lift Assembly	3-6
1. Erect A-Frame.....	4
2. Assemble Components	5-6
Gantry Height Adjustment.....	6-7
1. Unlock casters	6
2. Adjust lifting handle.....	6
3. Remove locking pins.....	6-7
Gantry Span Adjustment.....	7
Moving Gantry Lift	7
GH2T Gantry Specifications	8

OWNER'S RESPONSIBILITIES

Throughout this publication, the words **WARNING**, **CAUTION** and **IMPORTANT** will be used to alert the user to special instructions concerning a particular operation that may be hazardous if performed incorrectly or carelessly.

OBSERVE THEM CAREFULLY !!



WARNING

Hazards or unsafe practices which could result in severe personal injury or death.



CAUTION

Hazards or unsafe practices which could result in minor personal injury, product or property damage.



IMPORTANT

Indicates information or instructions that are necessary for proper operation and/or maintenance.

Introduction

Thank you for choosing Sumner's GH2T Gantry Lift to meet your material lifting needs. The GH2T Gantry Lift has a load capacity of 2 metric tons (2,000 kg) or 4,400 lbs. Following proper procedures for use and maintenance of Sumner's GH2T Gantry Lift described in this manual will provide you with years of dependable service.

Gantry Components

Sumner's GH2T Gantry Lift consists of the below components. Before attempting to assemble Gantry Lift be certain that all components are available.

- 2 - A-frames
- Cross Beam (3m, 4m, 5m, 8', 10', 12' or 15')
- Trolley
- Attaching hardware (4 bolts, 4 nuts & 8 washers)

Operator Safety Instructions



IMPORTANT

Read and understand this manual prior to operating or performing maintenance on this lift.

1. **ALWAYS** Inspect all equipment prior to use to make certain it is in proper working order.
2. **NEVER** use unit if any part of equipment appears damaged or does not assemble properly.
3. **ALWAYS** use only Sumner replacement parts. Any replacement parts not supplied by Sumner Manufacturing will severely compromise the quality and safety designed into this unit as well as invalidate the warranty.
4. As a precaution, **ALWAYS** wear proper clothing when operating unit, including hard hat, work gloves and safety shoes.
5. **ALWAYS** avoid horseplay around equipment, and keep bystanders at a safe distance. Do not allow children to operate this unit and always keep them out of work areas.
6. **NEVER** misuse the unit. Perform only the functions for which the unit is designed. Never attempt to operate the equipment at more than the recommended capacity.
7. No riders on unit. This unit was designed for material lifting purposes **ONLY** and is not designed to function as a personnel lift or carrier.
8. **NEVER** stand under an elevated load.
9. **NEVER** exceed rated load capacity.
10. **NEVER** operate during high winds or electrical storms.
11. **NEVER** use Gantry lift to support ladders or other climbing devices.
12. When possible **ALWAYS** move loads by moving the trolley on the Gantry cross beam while the lift is stationary with all casters locked.
13. It is not recommended to move the Gantry lift with a load. When moving the Gantry lift with a load be sure to secure trolley in center of cross beam to evenly distribute the weight across the unit and lower load as close to the ground as possible. Move lift by pushing the Gantry, not the load.
14. **NEVER** leave a load on the Gantry lift unattended.
15. **ALWAYS** adjust A-frame heights prior to attaching a load and make certain cross beam is level prior to attaching a load. See instructions in this manual on how to adjust A-frame heights.
16. **NEVER** adjust A-frame heights without first securing trolley to center of cross beam.
17. **ALWAYS** use Gantry lift on a hard, level, smooth surface that is free of debris and obstructions. Be certain the surface the Gantry is on can support the full weight of the intended load.
18. **NEVER** move a fully assembled Gantry lift using a fork lift or other lifting device.
19. **NEVER** use Gantry lift as an electrical ground.
20. **ALWAYS** ensure load is not secured to the ground before attempting to lift it.

GH2T Gantry Lift Assembly

The following tools are required to properly assemble the GH2T Gantry Lift:

- 1" wrench
- 1" socket wrench
- Ladder

1. Erect A-Frame

Begin with the A-frames lying flat on the ground. Assemble Gantry following instructions below.

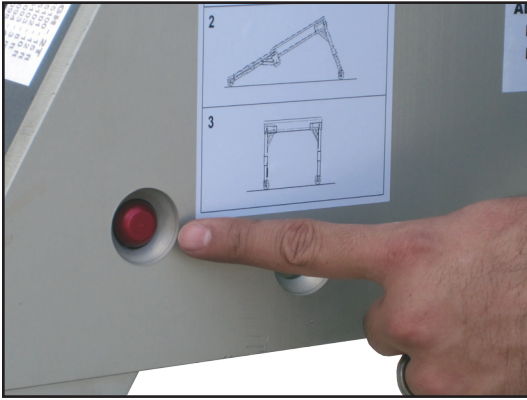

1. To extend one leg push the red leg locking button. The leg is now free to extend.



2. Extend each leg until the button clicks in place locking the leg in the open position.

Repeat process for second A-frame.



3. Lock all casters on both A-frames by pushing down on caster brake mechanism.

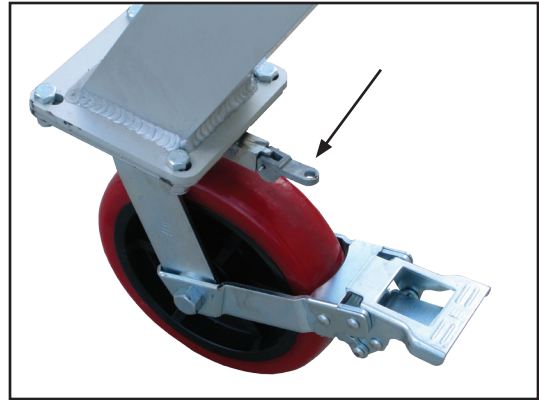

4. Casters can be locked at 90 degree angles to make transport easier. To lock castor at a 90 degree angle, flip the castor lock lever as indicated in above illustration.



5. Position A-frames as necessary at either end of cross beam.

2. Assemble Components



1. Lay out cross beam in a cleared area. Place one A-frame at either end of the cross beam as shown.



2. Lift one side of cross beam onto A-frame and line up outside bolt hole on A-frame with desired bolt hole on cross beam. Place bolt through bolt hole on A-frame and cross beam with washers on either side of the bolt. Loosely tighten so A-frame can swivel when A-frame is erected.



3. Place trolley at the opposite end of the cross beam. Center trolley on cross beam and tighten with set screw.



4. Lift cross beam end without bolt inserted and position on A-frame lining up outside bolt hole on A-frame with desired bolt hole on cross beam.



5. Place bolt through bolt hole on A-frame and cross beam with washers on either side of the bolt. Loosely tighten so A-frame can swivel when A-frame is erected.



6. Erect one A-frame and line up inside bolt hole on the A-frame with corresponding bolt hole on the cross beam. Using a ladder, place bolt through bolt hole on A-frame and cross beam. Tighten both sets of bolts.



CAUTION

Be certain both casters on both A-frames are locked before erecting A-frames.



7. Erect second A-frame and line up inside bolt hole on the A-frame with corresponding bolt hole on the cross beam. Place bolt through bolt hole on A-frame and cross beam with washers on either side of the bolt. Fully tighten both sets of bolts.

Gantry Height Adjustment

1. Unlock casters

Unlock both casters on the A-frame for which you will be adjusting the height.



CAUTION

NEVER attempt to adjust the height while the lift is holding a load.



CAUTION

Be certain trolley is centered and held in place with set screw before attempting to adjust A-frame height.

2. Adjust lifting handle location



Release the plunger pin on the lifting handle and slide handle to desired position most convenient for lifting or lowering A-frame height. Release plunger pin and be certain it locks into place through pre-set holes before attempting to make height adjustment.

3. Remove locking pin



1. With one hand lift on lifting handle. Remove locking pin with other hand.



2. Once locking pin is removed, lift or lower A-frame to desired height. Replace locking pin.
3. Repeat above steps on other A-frame.



CAUTION
It may be necessary to replace locking pin and readjust lifting handle location in order to properly lift or lower A-frame to desired height comfortably. Failure to adjust lifting handle to a comfortable location for lifting may result in injury.



CAUTION
Be certain to check that lift is level after adjusting A-frame heights before attempting to add a load.

Gantry Span Adjustment

5m and 15 ft GH2T Gantry beams have two inner span adjustments on each end of the beam. 3m, 4m, 10 ft and 12 ft Gantry beams have one inner span adjustment. Span adjustments are by increments of 13" (33 cm). 8 ft Gantry beams have no span adjustments.

To make span adjustments during assembly, simply place the outermost bolt on the A-Frame in the second or third inside bolt hole on the beam. It is not neces-

sary to adjust the span symmetrically on either end of the beam.

Moving Gantry Lift



CAUTION
It is not recommended to move Gantry lift with a load. When moving Gantry lift with a load be sure to secure trolley in center of cross beam and lower load as close to the ground as possible prior to moving. Move lift by pushing the Gantry, not the load. Use caution to avoid the load swinging, possibly hitting the support structure.



CAUTION
Never move assembled Gantry lift with or without a load with a forklift or other lifting mechanism.



1. Adjust A-frame heights to lowest possible position prior to moving.
2. Unlock all casters on both A-frames.
3. Gantry should be moved with at least two people, one on each end. Move by pushing or pulling on the Gantry, not the load.

GH2T GANTRY SPECIFICATIONS

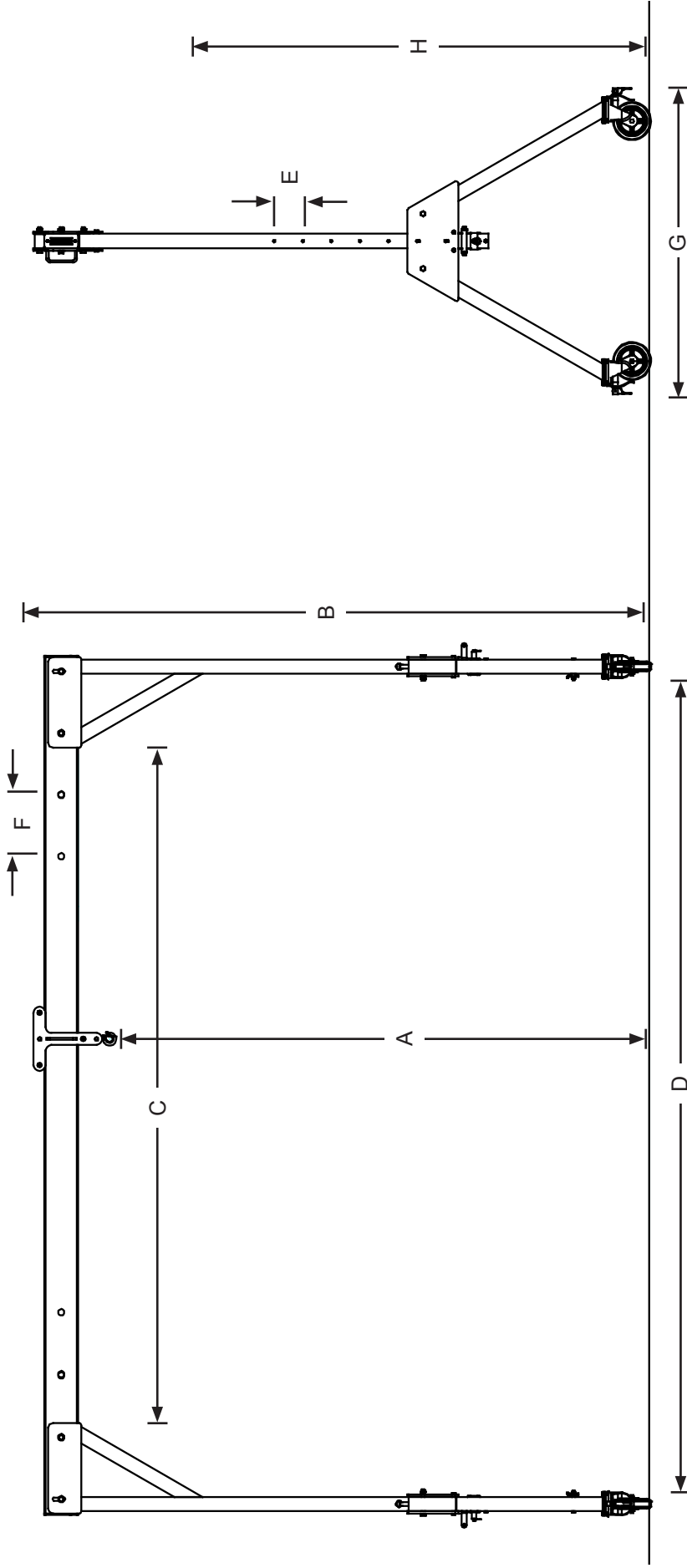

Part No.	Gantry Model	A Max/Min Height To Lifting Eye	B Max Height To Top Of Trolley	C Max Working Span	D Span Between Wheels	E Height Adjustment	F Span Adjustment*	G Max Width Of "A" Frame	H Stored Height of "A" Frame	Weight lbs	Weight kg
785093	GH2T-3 (3 m Beam)			2 m (80")	3 m (118")					295.0	133.8
785094	GH2T-4 (4 m Beam)			3 m (119")	4 m (157")					313.0	142.0
785095	GH2T-5 (5 m Beam)	114" (289.56 cm)		4 m (159")	5 m (197")					331.0	150.0
785100	GH2T-15 (15' Beam)		128.5" (326.39 cm)	142" (360.68 cm)	15' 1" (459.74 cm)	6" (15.24 cm)	13" (33.02 cm)	60.625" (153.98 cm)	100" (254 cm)	323.0	146.5
785101	GH2T-12 (12' Beam)	84" (213.36 cm)		106" (269.24 cm)	12' (365.76 cm)					307.0	139.2
785102	GH2T-10 (10' Beam)			82" (208.28 cm)	10' (304.8 cm)					296.0	134.2
785103	GH2T-8 (8' Beam)			58" (147.32 cm)	8' (243.84 cm)					285.0	129.2

* 15 ft & 5 m Gantry beams have 2 span adjustments. 8 ft Gantry beams have none.