

T3EL150302P / T3EL150303P Programmable Electronic Loads Data Sheet



T3EL150303P

T3EL150302P

Product Overview

T3EL150302P/T3EL150303P series Programmable DC Electronic Load has a 3.5 inch TFT-LCD display, a user-friendly interface and superb performance specifications. The T3EL150302P models feature an input range of 150 V/30 A 200 W while the T3EL150303P have an input range of 150 V/30 A 300 W. The T3EL15030xP series leads with measurement resolution of 1 mV/1 mA and adjustable current rise times from 0.001 A/ μ s~2.5 A/ μ s.

For remote communication and control, the T3EL15030xP series includes RS232/USB/LAN interface types. The T3EL15030xP series delivers stability over a wide range of applications and can meet all kinds of testing requirements. Including: Power, battery/handheld device design, industry, LED lighting, automotive electronics, and aerospace.

Main Feature

- T3EL150302P (Single channel): DC 150 V/30 A, total power up to 200 W
- SDL1030X (Single channel): DC 150 V/30 A, total power up to 300 W
- 4 static modes / Dynamic mode: CC/CV/CR/CP
- CC Dynamic mode: Continuous, pulsed, toggled
- CC Dynamic mode: 25 kHz, CP Dynamic mode: 12.5 kHz, CV Dynamic mode: 0.5 Hz
- Measuring speed of voltage and current: up to 500 kHz
- Adjustable current rise time range: 0.001 A/ μ s~2.5 A/ μ s
- Min. readback resolution: 1 mV, 1 mA
- Short-circuit, Battery test, CR-LED mode, and factory test functions
- 4-wire SENSE compensation mode function
- List function supports editing as many as 100 steps
- Program function supports 50 groups of steps
- OCP, OVP, OPP, OTP and LRV protection
- External analog control
- Voltage, Current monitoring via 0-10 V
- 3.5 inch TFT-LCD display, capable of displaying multiple parameters and states simultaneously
- Built-in RS232/USB/LAN communication interface, USB-GPIB module (optional)
- Waveform trend chart and ease-to-use file storage and call functions
- Includes PC software: Supports SCPI, LabView driver



Design Features

Steady state operating mode

The T3EL15030xP features four operating modes to provide flexible test capabilities. In CC mode, the electronic load will sink a constant current, regardless of the voltage at its terminals. In CV mode, the electronic load will cause a constant voltage to appear at its terminals. In CR mode, the electronic load will behave as a fixed resistance value. As shown in the figure, the electronic load will linearly change the current according to the input voltage. In CP mode, the electronic load will cause a constant power to be dissipated in the load.

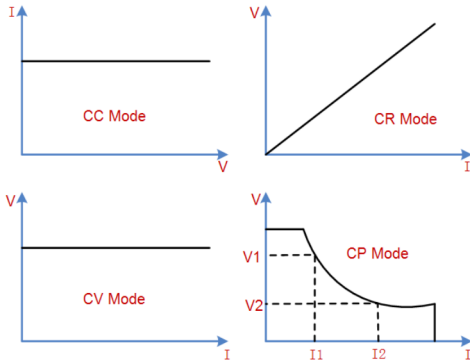

Dynamic test mode up to 25 kHz (CC)

The transient test allows switching between two different load values. A common application is to test the dynamic characteristics of a DC source or DUT (Device Under Test). The transient test function enables the load to periodically switch between two set levels (Level A and Level B). The highest frequency can be set to 25 kHz in CC mode. The highest frequency can be set to 12.5 kHz in CP modes.

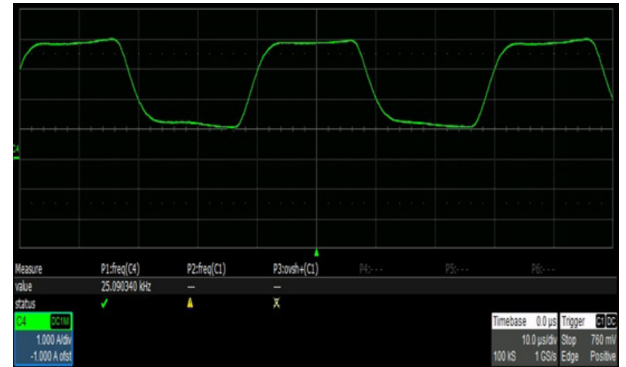

Simplify complex sequencing using the list operation function

You can generate complex load sequences quickly using the list operation function. Here, you can edit the setpoints, dwell time, and slew rate for each step in the test. *Slew rate can only be edited in CC mode.

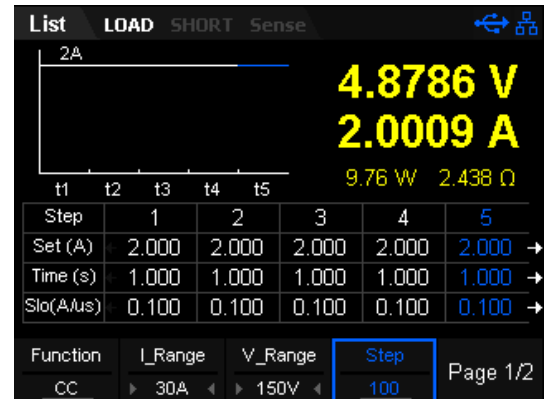
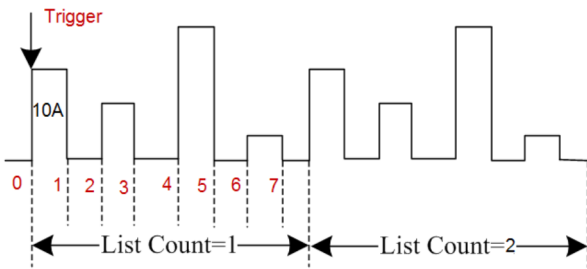

4-wire SENSE compensation mode function

In CC/CV/CR/CW mode, when a load is connected to a power supply, it will cause a large voltage-drop on the connection lines between tested instrument and terminals of load. Using remote sense, you can measure the voltage at the DUTs input terminals, effectively removing the additional error due to the voltage drop in the connection wires.

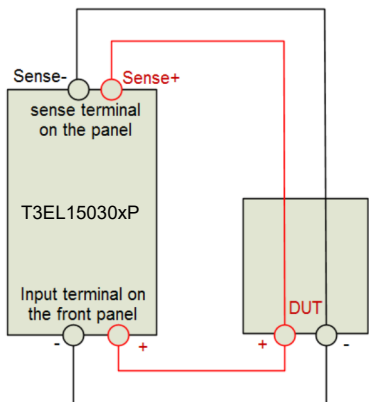

Program function

In program (auto-test) mode, you can generate a sequence of tests using different modes, mode parameters and durations. This function is useful for automatically executing a set of tests on a device then display whether the tests passed or failed. Test results are easily viewed by pressing the up and down buttons. The load provides 8 nonvolatile registers to save auto-test file for recall later. Each file contains 1-50 steps to set up. Auto-test function is especially useful in the designing battery charging circuitry.

| step | 1 | 2 | 3 | 4 | 5 |
|--------|---------|--------|--------|--------|--------|
| mode | CC | CC | CC | CC | CC |
| Irange | 30A | 30A | 30A | 30A | 30A |
| Vrange | 150V | 150V | 150V | 150V | 150V |
| paus | OFF | OFF | OFF | OFF | OFF |
| short | OFF | OFF | OFF | OFF | OFF |
| Ton | 10.000s | 1.000s | 1.000s | 1.000s | 1.000s |
| Toff | 1.000s | 1.000s | 1.000s | 1.000s | 1.000s |
| Tdly | 1.000s | 1.000s | 1.000s | 1.000s | 1.000s |

| | | | |
|------|---------|------|--------|
| Step | Storage | Trig | Result |
| 5 | | | |

Battery discharge function

The T3EL15030xP can also provide insight into battery performance by analyzing the discharge characteristics of the DUT. The T3EL15030xP features three stop conditions for the discharge test: Voltage, capacity or time. The discharge process is immediately terminated if the stop conditions are met. This provides more control over the test termination and an extra layer of safety during critical tests. Throughout the test process the battery voltage, discharge current, discharge time and discharged capability is displayed clearly on the LCD panel.

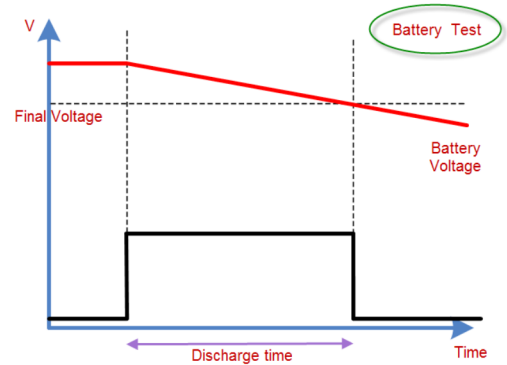

OCPT/OPPT Mode

Over-current protection (OCPT) mode prevents drawing too much current from the DUT. After the input voltage reaches the Von point, the DC load will start to draw a current from the source after a delay time. The current value will increase by a certain step size at regular intervals. Simultaneously, the DC load will compare the input voltage to the OCP voltage: If it is lower, then the present current value will be compared to see if it is in the current range you have set. Within the range, the OCP test will evaluate Pass or Fail. If it is outside of the set range, the DC load will increase drawing current and compare the voltage again.

| OCPT | LOAD | SHORT | Sense |
|----------|----------|-------|-------|
| 4.9395 V | 0.9973 A | | |
| 4.93 W | 4.952 Ω | | |

| | | | | |
|---------|---------|-------|--------|----------|
| I_Range | V_Range | OCP_V | I_Step | Page 1/3 |
| 30A | 150V | 1.00V | 1.000A | |

Overpower-protection (OPPT) mode: When the input voltage has reached the Von point, the load will draw power after a delay time. The power value will increase by a step size at regular intervals. Simultaneously, the DC load will judge whether the input voltage is lower than OPP voltage you have set, if it is, then the present current value will be compared to see if it is in the current range you have set. Within the range, the OPP test will Pass or Fail. If it is outside of the set power, the load will continue to increase the power draw within the cut-off current range and compare OPP voltage with the input.

CR-LED Mode

The T3EL15030xP includes a CR-LED mode specifically for LED driver testing. Basing on the traditional CR mode, CR-LED mode adds a diode break-over voltage setting. When the input voltage is above this set value, the DC load start to work. Thus, it can emulate the actual characteristics of an LED.

| LED | LOAD | SHORT | Sense |
|----------|----------|-------|-------|
| 4.7505 V | 0.8566 A | | |
| 4.07 W | 5.501 Ω | | |

| | | | | |
|---------|---------|--------|-------|--------|
| I_Range | V_Range | Io | Vo | Rco |
| 30A | 150V | 1.000A | 5.00V | 0.2000 |

Voltage Rise/Fall speed test

The electronic load is also equipped to directly measure voltage rise and fall times. It can calculate the time from one voltage to another without the need for additional measurement instrumentation. With an T3EL15030xP, you can save money and improve efficiency.

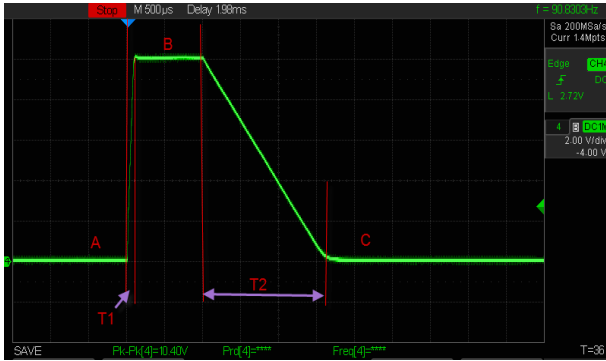

Waveform trend chart function

The electronic load includes a waveform display function and supports the following operations for the waveform: Pause, recording, and capturing the waveform. You can quickly observe the trends of parameter changes as they occur throughout the test.

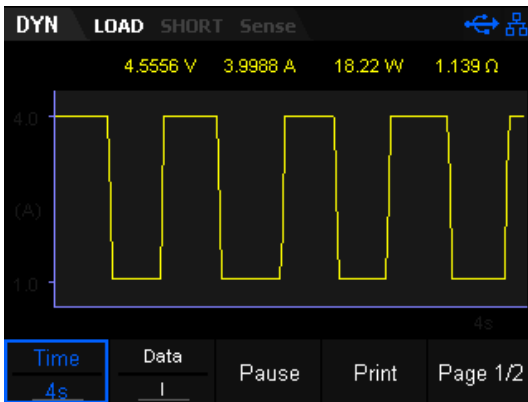

External analog control

The load allows the user to control current or voltage through external analog terminals (EXT PRG). Input a 0-10 V analog to adjust 0-100% rated voltage and current. It is very useful for those applications that need to change the input value with external signals.

Voltage threshold function

The T3EL15030xP can be set to turn on or off if the input voltage is at, above, or below a set value. By defining these thresholds, you control when the load is active. Which minimizes test time and increases safety.

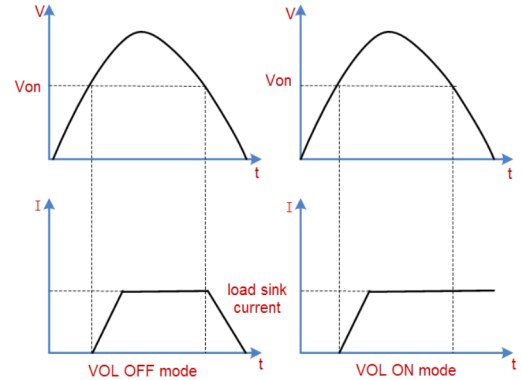

Save/Recall setting parameters

The load allows you to save different types of files to the internal and external memories. You can recall and read them when necessary.

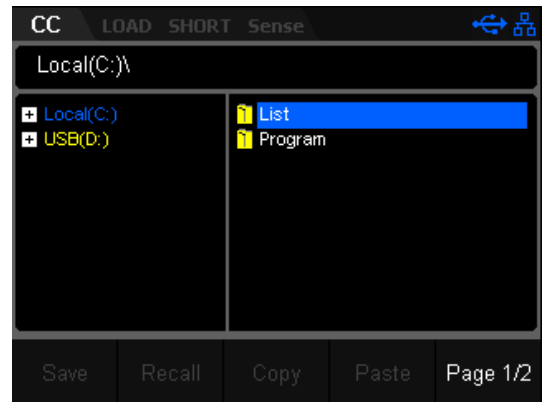

Multiple protection modes

The T3EL15030xP series Programmable DC Electronic Load provides five protection types: OVP, OCP, OPP, OTP and LRV. When OVP/OCP/OPP/OTP/reverse voltage protection (LRV) occurs, the load will immediately turn off the input and stop sinking. Then, a prompt message is displayed.

Specifications

Unless otherwise noted, all specifications are guaranteed within the temperature range of 25°C ± 5 °C with warm-up time of 30 minutes.

| Model | | T3EL1500303P | | T3EL1500302P | |
|---------------------------|--------------------------------|---|----------------|---|----------------|
| Input Rating (0~40 °C) | Input voltage | 0~150 V | | 0~150 V | |
| | Input current | 0~5 A | 0~30 A | 0~5 A | 0~30 A |
| | Input power | 300 W | | 200 W | |
| | Minimum Operating Voltage (DC) | 0.15 V at 5 A | 0.9 V at 30 A | 0.15 V at 5 A | 0.9 V at 30 A |
| CV Mode | Range | 0~36 V | 0~150 V | 0~36 V | 0~150 V |
| | Resolution | 1 mV | | 1 mV | |
| | Accuracy | ± (0.05%+0.025%FS) 50 ppm/°C | | ± (0.05%+0.025%FS) 50 ppm/°C | |
| CC Mode | Range | 0~5 A | 0~30 A | 0~5 A | 0~30 A |
| | Resolution | 1 mA | | 1 mA | |
| | Accuracy *2 | ± (0.1%+0.1%FS) 100 ppm/°C | | ± (0.1%+0.1%FS) 100 ppm/°C | |
| CR Mode *1 | Range | 0.03 Ω~10 kΩ | | | |
| | Resolution | 1mA/Vsense | | | |
| | Accuracy | 0.01%+0.0008 s [1] | | | |
| CP Mode *3 | Range | 300 W | | 200 W | |
| | Resolution | 10 mW | | | |
| | Accuracy | 0.1%+0.1% FS | | | |
| Dynamic Model | | | | | |
| CC Mode | | | | | |
| T1&T2 | | 20 us~999 S/Res: 1 uS | | 20 us~999 S/Res: 1 uS | |
| Accuracy | | 20 us~200 ms/Acc: 5 us, 200 ms ~999 s/Acc: 5 ms | | 20 us~200 ms/Acc: 5 us, 200 ms ~999 s/Acc: 5 ms | |
| Current Slew Rate *4 | | 0.001~0.5 A/us | 0.001~2.5 A/us | 0.001~0.5 A/us | 0.001~2.5 A/us |
| Minimum Rise Time | | ≈10 uS | ≈12 uS | ≈10 uS | ≈12 uS |
| Measuring Range | | | | | |
| Readback Voltage | Range | 0~36 V | 0~150 V | 0~36 V | 0~150 V |
| | Resolution | 1 mV | 1 mV | 1 mV | 1 mV |
| | Accuracy | ± (0.05%+0.02% FS) 20 ppm/°C | | ± (0.05%+0.02% FS) 20 ppm/°C | |
| Readback Current | Range | 0~5 A | 0~30 A | 0~5 A | 0~30 A |
| | Resolution | 1 mA | | 1 mA | |
| | Accuracy | ± (0.05%+0.05% FS) 50 ppm/°C | | ± (0.05%+0.05% FS) 50 ppm/°C | |
| Readback Power | Range | 300 W | | 200 W | |
| | Resolution | 10 mW | | | |
| | Accuracy | ± (0.1%+0.1% FS) | | | |
| Readback Resistance | Range | 0.03 Ω ~10 KΩ | | | |
| | Resolution | 0.001Ω | | | |

| Protection Range | | | | | |
|----------------------------|--|-------|-------|-------|-------|
| OPP | 310 W | | | 210 W | |
| OCP | | 5.1 A | 31 A | 5.1 A | 31 A |
| OVP | | 41 V | 155 V | 41 V | 155 V |
| OTP | 95 °C | | | 85 °C | |
| Battery Measurement | Battery Input: 0.5~150 V; Max Measurement: Capacity=999 AH Resolution=0.1 mA;Time Range=1 s~24 H | | | | |
| Input Resistance | >200 kΩ | | | | |
| Dimension | 256 * 115 * 410 (WxHxD mm) | | | | |
| Weight | 5.8 kg | | | | |

| CR Mode *1 | | | | | |
|--|---------|--------------|---|--|--|
| I Range | V Range | R Range | Accuracy | Test Condition | |
| 5 A | 36 V | 0.03 Ω~10 kΩ | 0.01%+0.08 s (0.05~10 Ω) 0.01%+0.0008 s (10~10000 Ω) [1] | The input voltage/current value should not be smaller than 10% of the full scale | |
| | 150 V | | | | |
| 30 A | 36 V | | | | |
| | 150 V | | | | |
| [1] Resistance Range : (1/(1/R+(1/R)*0.01%+0.0008),1/(1/R-(1/R)*0.01%-0.0008)) | | | | | |

*2 Current Slew rate>0.2 A/us

*3 The input voltage/current value should not be smaller than 10% of the full scale.

*4 Current slew rate: rising slew rate for 10%~90% of the current (0-maximum current).

| Product information | Product No |
|--|-------------|
| 150 V/30 A 200 W Programmable DC Electronic Load | T3EL150302P |
| 150 V/30 A 300 W Programmable DC Electronic Load | T3EL150303P |
| Standard Accessories | |
| USB Cable -1 | |
| Quick Start -1 | |
| Calibration Certificate -1 | |
| Power cord -1 | |

Warranty

Three-year warranty, excluding accessories.



ABOUT TELEDYNE TEST TOOLS

Company Profile

Teledyne LeCroy is a leading provider of oscilloscopes, protocol analyzers and related test and measurement solutions that enable companies across a wide range of industries to design and test electronic devices of all types. Since our founding in 1964, we have focused on creating products that improve productivity by helping engineers resolve design issues faster and more effectively. Oscilloscopes are tools used by designers and engineers to measure and analyze complex electronic signals in order to develop high-performance systems and to validate electronic designs in order to improve time to market.

The Teledyne Test Tools brand expands on the Teledyne LeCroy product portfolio by adding a comprehensive range of test equipment solutions for its customers. The new range of product solutions deliver engineers with a broad range of quality test solutions that enables speed to market product validation and design. More and more designers, engineers and lecturers are relying on Teledyne Test Tools to meet their testing, education and electronics validation needs with confidence and within budget.

Location and Facilities

Headquartered in Chestnut Ridge, New York, Teledyne Test Tools and Teledyne LeCroy have sales, service and development subsidiaries in the US and throughout Europe and Asia. Teledyne Test Tools and Teledyne LeCroy products are employed across a wide variety of industries, including semiconductor, computer, consumer electronics, education, military/aerospace, automotive/industrial, and telecommunications.

Teledyne LeCroy (US Headquarters)

700 Chestnut Ridge Road
Chestnut Ridge, NY. USA
10977-6499

Phone: 800-553-2769 or 845-425-2000

Fax Sales: 845-578-5985

Email Sales: contact.corp@teledynelecroy.com

Email Support: support@teledynelecroy.com
(Oscilloscopes, Waveform Generators, Signal Integrity)

Web Site: <http://teledynelecroy.com/>

Phone Support: 1-800-553-2769

Teledyne LeCroy (European Headquarters)

Teledyne LeCroy GmbH

Im Breitspiel 11c
D-69126 Heidelberg, Germany

Phone: + 49 6221 82700

Fax: +49 6221 834655

Fax Sales: +49 6221 834655

Fax Service: +41 22 719 22 99

Email Sales: contact.gmbh@teledynelecroy.com

Email Service: service.gmbh@teledynelecroy.com

Email Support: applications.de@teledynelecroy.com

Web Site: <http://teledynelecroy.com/germany>

Phone Service: +49 6221 8270 85

Phone Support: +49 6221 8270 28

