

TB-IPS

"TILT 'N SELECT" TABLE BOXES

FSR

Metal Products Group

TB-IPS



IPS plates and connectors ordered separately.

DESCRIPTION

The TB-IPS Table Box offers convenience at a price that fits within your budget. The tilt top style box can be easily custom configured for any job specific cabling scenario. The unit has openings for up to (8) eight single IPS insert plates or a variety of multiple plate arrangements.

The TB-IPS table box is available in Black Anodized finish. In the open position, the connectors will be at approximately a 35° angle from vertical. This is to accommodate a seated person at the table, with the box being 22" from the edge of the table. There is up to 4" of clearance behind the IPS plate surface.

IPS INSERTS

The IPS (Intelligent Plate Solutions) line offers a wide variety of interconnect solutions that satisfy virtually any AV and DATACOM interface application. Customizing just became standard at budget friendly prices. Create unlimited combinations of connector inserts with this diverse assortment of IPS inserts that work well with the TB-IPS table box.

The insert connectors are mounted to steel plates insuring a lifetime of service. The inserts are available with no labeling, standard labeling, or FSR will custom label them for you as well. Additionally, our IPS inserts can be changed at any time for easy upgrade. All IPS inserts carry a limited lifetime warranty.

APPLICATIONS

- Court Rooms
- Desks
- Boardroom Tables
- Lecterns
- Control Consoles
- Lab Tables
- Classrooms

FEATURES

- Can be mounted in a wide variety of tables with thicknesses ranging from .75" to 2.25"
- IPS openings can use FSR IPS-D717S USB Chargers
- Connector plates can be populated to match the specific application and customer needs
- Can be reconfigured at any time as requirements change
- Available in Black Anodized finish

Touchboards

205 Westwood Ave, Long Branch, NJ 07740
Phone: 866-94 BOARDS (26273) / (732)-222-1511
Fax: (732)-222-7088 | E-mail: sales@touchboards.com

FSR Inc.

244 Bergen Boulevard, Woodland Park, NJ 07424
Phone: 973.785.4347 · Fax: 973.785.4207
Web: www.fsrinc.com · E-mail: sales@fsrinc.com LIT1498A







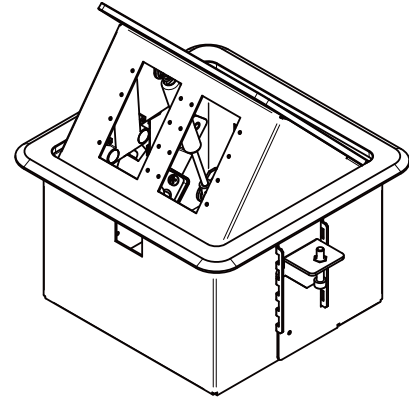
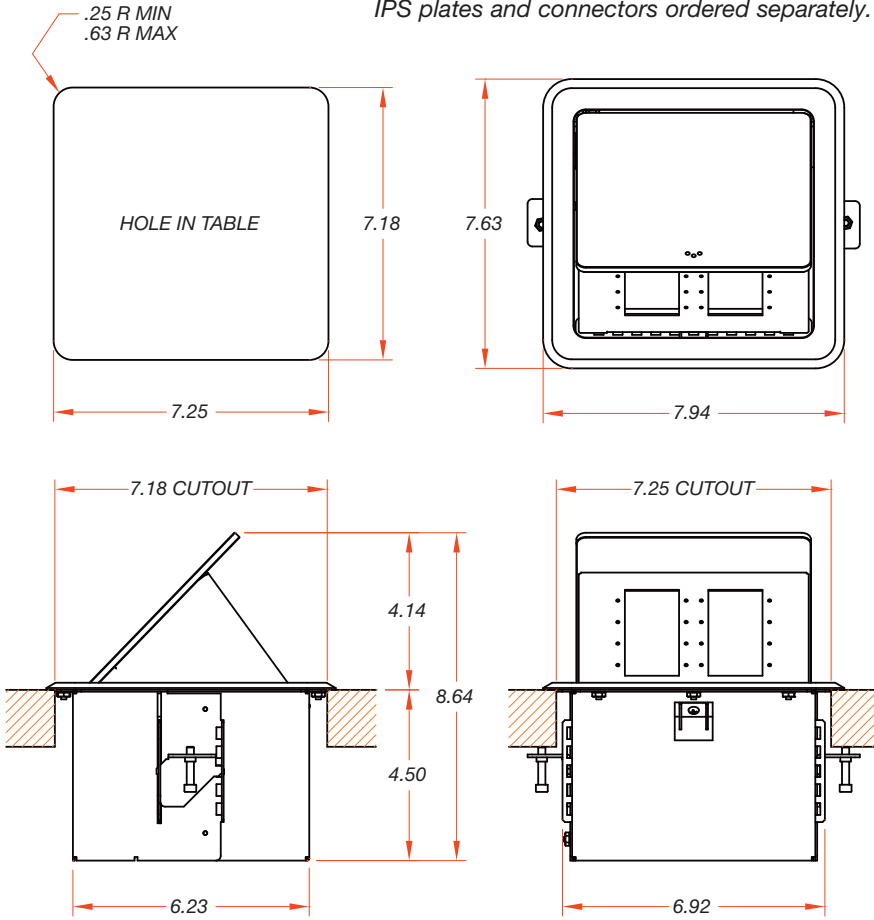



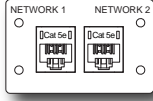
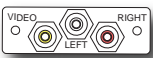

OVERALL DIMENSIONS

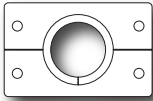
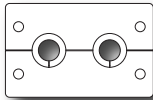
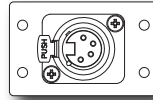
IPS plates and connectors ordered separately.

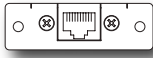
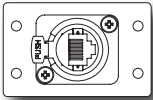
There is up to 4" of clearance behind the IPS plate surface.

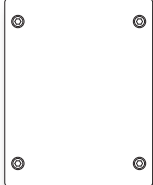

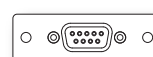
IPS INSERT ASSORTMENT

 <p>IPS-AC110D AC Outlet to Edison Plug (Under Table Use Only) Black Only</p>	 <p>IPS-V610S HDMI to HDMI Bulkhead</p>	 <p>IPS-D720D-LB 2 x RJ-45 Punch-Down (Labeled)</p>	 <p>IPS-AV231S-LB Red, White and Yellow RCA's to RCA's (Labeled)</p>	 <p>IPS-B040S 1 Keystone Opening</p>	 <p>IPS-B041D 2 Keystone Opening</p>	 <p>IPS-B010D 1 x .812" ID Split Bushing</p>
 <p>IPS-B020D 2 x .312" ID Split Bushing</p>	 <p>IPS-C610D 2 x 4 Pin Female XLR to Solder</p>	 <p>IPS-C611S 4 Pin Mini XLR to Captive Screw Terminal</p>	 <p>IPS-C612S TPS Block 10 Connector</p>	 <p>IPS-C710D Neutrik EtherCon RJ-45</p>	 <p>IPS-C410S 9 Pin DSub Male to Female Bulkhead</p>	 <p>IPS-B000Q Quad Height Blank</p>
 <p>IPS-B000D Double Height Blank</p>	 <p>IPS-B000S Single Height Blank</p>	 <p>IPS-C411S 9 Pin DSub Male to Solder</p>	 <p>IPS-D717S (Blk, Wht, Iv) USB Charging Port</p>	<p>Some of the hundreds of IPS Inserts offered by FSR. For more options visit www.fsrinc.com or refer to LIT1443</p>		

Specifications are subject to change without notice.



205 Westwood Ave, Long Branch, NJ 07740
Phone: 866-94 BOARDS (26273) / (732)-222-1511
Fax: (732)-222-7088 | E-mail: sales@touchboards.com