

Digital Storage Oscilloscope

TBS1000C Series Datasheet

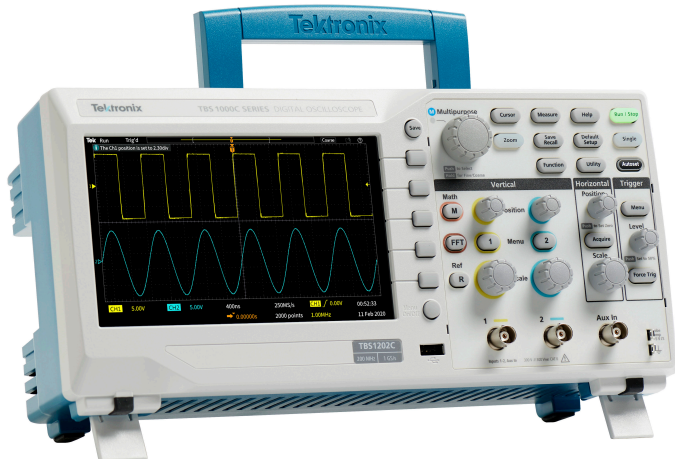

The TBS1000C Series Digital Storage Oscilloscope offers affordable performance in a compact design. It is designed to meet the needs of today's educational institutions, embedded design engineers, and maker community. The instrument includes a 7-inch WVGA color display with up to 1 GS/s sample rate, bandwidths from 50 MHz to 200 MHz and a five-year warranty. The instrument comes with an innovative courseware system that integrates the lab exercises with step-by-step instructions for use, by the students. HelpEverywhere® system provides useful tips and hints throughout the user interface, to make the instrument more approachable to a new user.

Key performance specifications

- 200 MHz, 100 MHz, 70 MHz, and 50 MHz bandwidth models
- 2-channel models
- 1 GS/s sample rate on all channels
- 20k point record length on all channels
- Advanced triggers include pulse, runt, and line triggers
- Five-year warranty

Key features

- 7-inch WVGA color display with 15 horizontal divisions that shows 50% more signal
- 32 automated measurements
- Dual window FFT with simultaneous time and frequency domain views

- Trigger frequency counter
- Pan and Zoom capability
- Multi-language user interface with support for 10 languages in the user interface and front panel overlay
- Small footprint and light weight
- Fanless design contributes to low noise operation

Connectivity

- USB 2.0 host port on the front panel for quick and easy data storage.
- USB 2.0 device port on rear panel to connect to a PC and remotely control the instrument.

Education

- HelpEverywhere® provides helpful on-screen tips for users
- Built-in oscilloscope handbook provides operating instructions and oscilloscope fundamentals
- Integrated courseware feature provides lab exercise guidance on the display
- Autoset, Cursors, and Automated measurements can be disabled to help educators to teach basic concepts to students

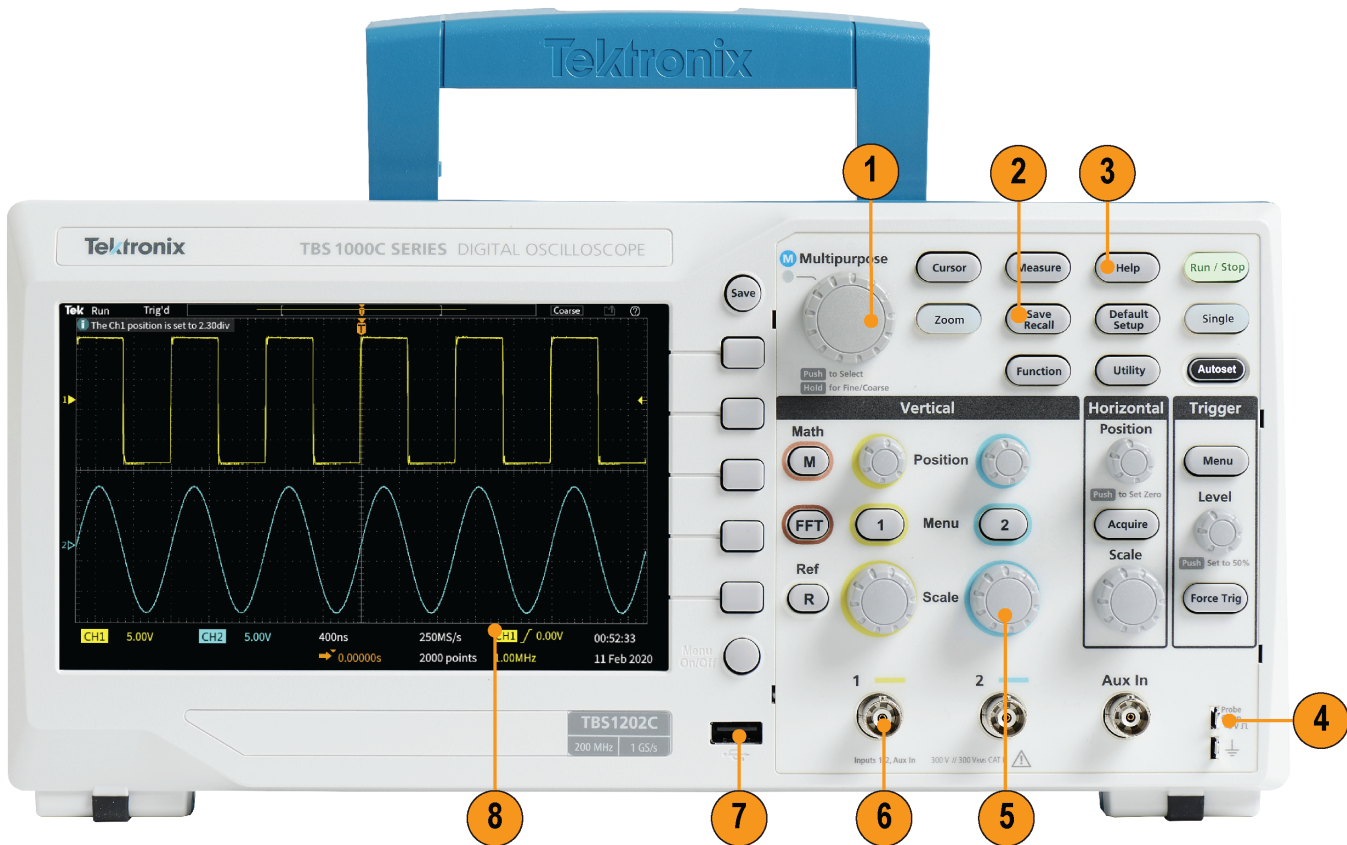

Figure 1: TBS1000C front panel

Image Reference	Description
1	Multipurpose knob for waveform navigation, zoom, and cursors
2	Save Recall
3	HelpEverywhere®

Image Reference	Description
4	Probe Compensation
5	Dedicated control knobs per channel
6	BNC probe interface
7	USB Host port for save/recall
8	7-inch display



Figure 2: TBS1000C rear panel

Image Reference	Description
1	IEC power connector
2	USB device port for remote control
3	Kensington Lock

Designed to make you learn and work faster

The TBS1000C Series Oscilloscope is designed for quick hands-on learning and easy operation with just the right combination of features and capabilities. Dedicated front panel controls provide easy access to all the important settings. The graticule with 10 vertical divisions and 15 horizontal divisions enables you to see more signals per screen.

The large menus with clearly labeled and colored information on the screen make it easy to navigate and find information of interest. The zoom function lets you to quickly pan through the record and zoom in to see the signal details in areas of interest.

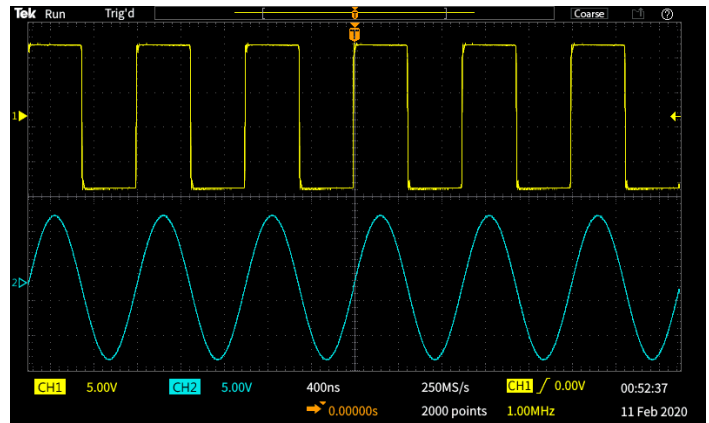

Figure 3: In Zoom mode, an overview of the entire record is shown in the upper part of the display and the lower part displays the detailed Zoomed view.

Versatile triggering and acquisition modes

The trigger system is designed for troubleshooting today's mixed signal designs. Beyond a basic edge trigger, it also includes pulse width and runt triggering, which are especially useful for troubleshooting digital sections of your designs.

Pulse width triggering is perfect for hunting narrow glitches or time out conditions. Runt trigger is designed to capture signals that are shorter in amplitude than expected.

The TBS1000C Series Oscilloscope offers several acquisition modes. The default acquisition mode is Sample Mode which works well for most applications. The Peak Detect Mode is useful for hunting spikes, and Average Mode can help to reduce noise on the repetitive signals.

Automated measurements and analysis

A comprehensive set of automated measurements enable fast and convenient testing of a wide variety of signal conditions for different applications.

Measurements are displayed on a single screen. They are grouped into four categories: Frequency, Time, Amplitude, and Area. All measurements are displayed on a single measurement selection screen making it easy to choose from 32 automated measurements; no more hunting through various menus.

Measurements are color coded by the source and are presented on a transparent background; so waveforms are not obscured by the readouts.

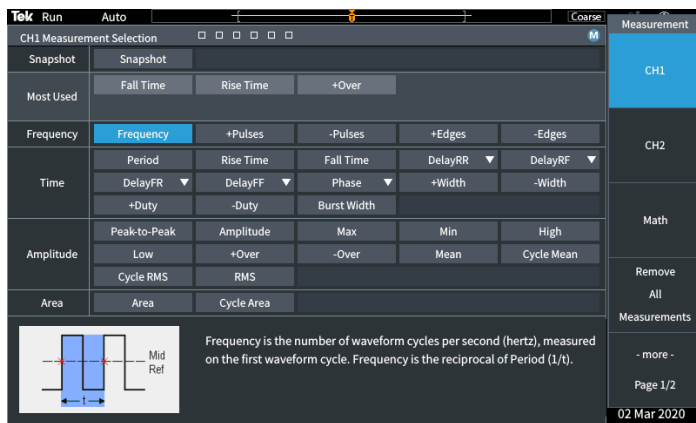

Figure 4: Measurements are all listed and selected on a single screen

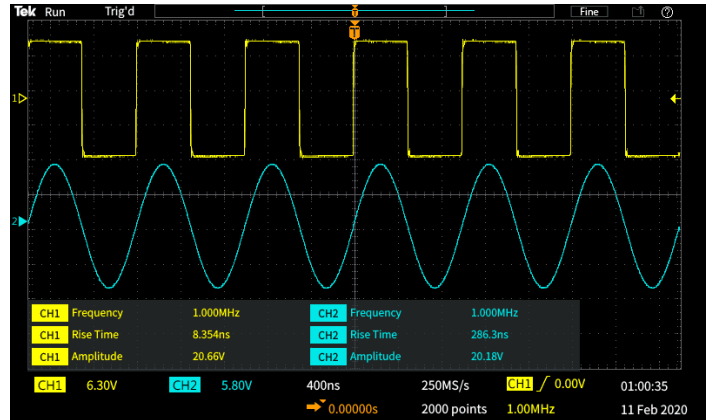

Figure 5: Measurements are transparent so waveforms are not obscured

FFT function

You can understand the frequency content of your signals with the FFT function by pressing FFT button in the front-panel .

Display only the FFT or turn on the source waveform display to see both the frequency and the time domain waveform. A transparent readout shows important settings without blocking the FFT display.

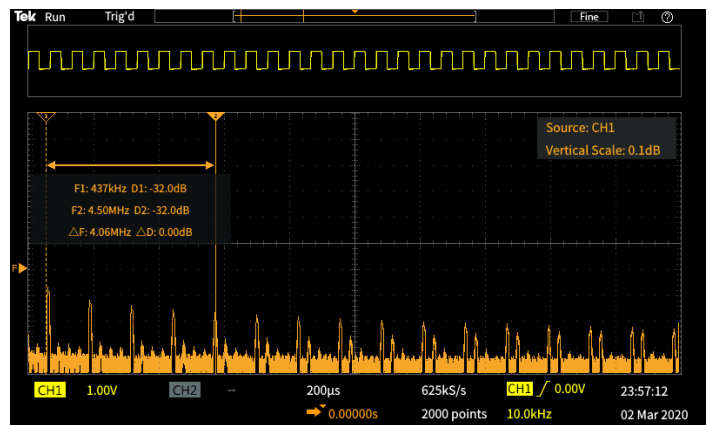

Figure 6: The time domain source waveform can be displayed above the FFT frequency spectrum

HelpEverywhere®

The HelpEverywhere® system provides help text with graphics to explain the different settings on the instrument, making it easier for new users to know which measurement to use and interpret the results. Help is provided in the same language as the user interface.

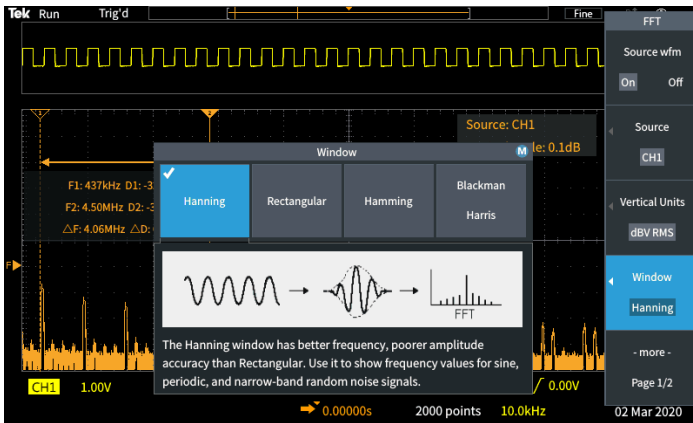

Figure 7: HelpEverywhere® tips explain important settings.

Innovative new education solutions

The TBS1000C Series Oscilloscope offers several features that enable the educator to devote more time to teach fundamental concepts. The Scope Intro handbook is embedded into the TBS1000C help system. Pressing the help button in the front panel gives you access to information on oscilloscope basic operations, as well as an overview of the TBS1000C oscilloscope, controls, and tips to use it.

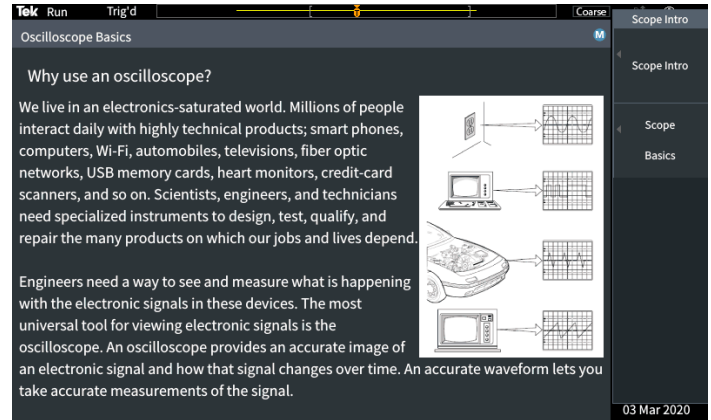
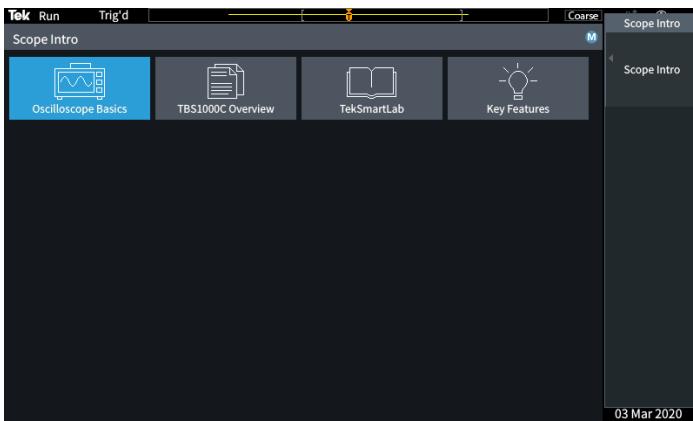

Figure 8: Scope Intro covers basic oscilloscope and TBS1000C usage

Features such as Autoset, Cursors, and automated measurements can be disabled on the instruments. By disabling features, students can learn the basic concepts and understand how to use the horizontal and vertical controls to get the waveform, use the graticule to measure time, voltage, and manually plot/calculate the signal characteristics.

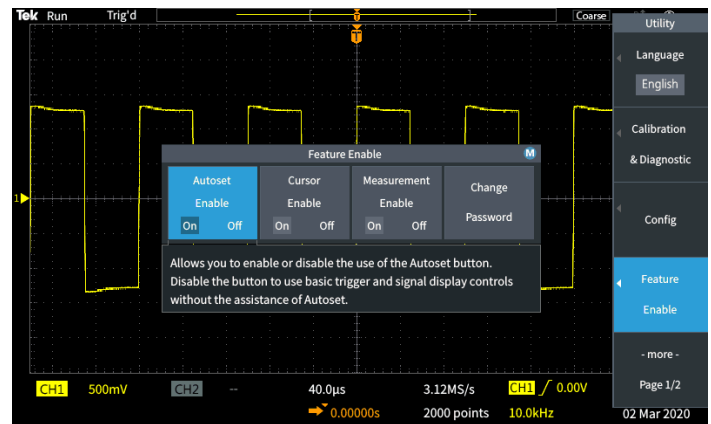

Figure 9: Features with menus

The integrated Courseware function allows professors to load lab exercises on the instrument to give guidance to the students at each station and provides a structured framework into which students can capture data to incorporate into their reports. Over 100 sample lab exercises are available for download from the [Tektronix Courseware Resource Center](#).

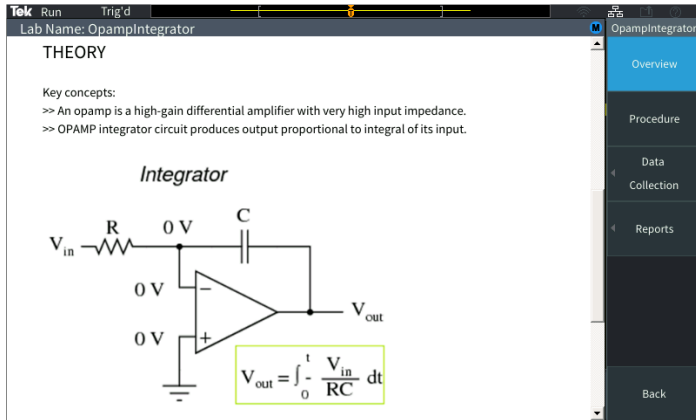

Figure 10: The Courseware function allows students to see lab information on the instrument display

Flexible data transfer

The USB host port on the front of the instrument makes it easy to save the instrument settings, screenshots, and waveform data into a USB flash drive.

TekScope

TekScope software expands the capabilities of your instrument by enabling you to easily transfer data directly from your oscilloscope to your PC for offline analysis. With the remote analysis for bench oscilloscopes package, you can run protocol decode on the most common buses (I2C, SPI, CAN, CAN-FD, LIN, and UART), advanced analysis capabilities with unlimited measurement, trends, histograms, search and mark as well as offline waveform analysis all in a user environment that is very similar to our high performance instruments.



Figure 11: Waveform analysis with TekScope on a PC

PC connectivity

Easily capture, save, and analyze measurement results by connecting to your PC to the USB device port on the rear of the instrument and using the OpenChoice® PC Communications Software available on the Tektronix website. Simply pull screen images and waveform data into the stand-alone desktop application or directly into Microsoft Word and Excel.

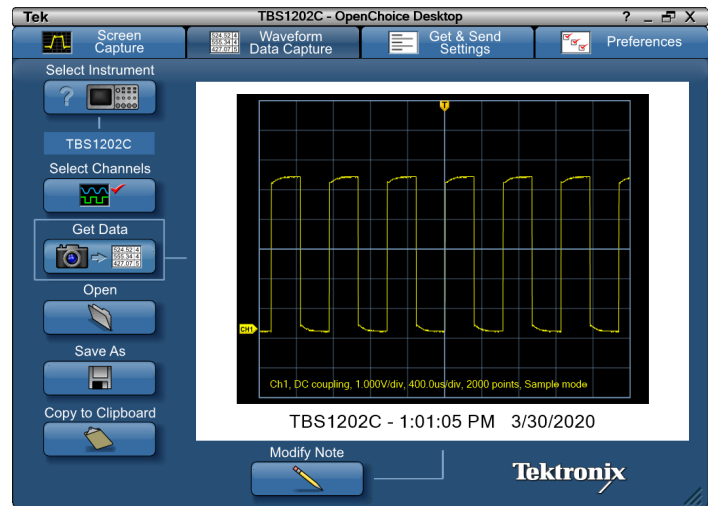

Figure 12: OpenChoice desktop

Kickstart

Kickstart software offers bench instrument control, automated data, and measurement logging capability of multiple instruments on a bench. The collected data can be charted to get further insights or exported in multiple formats for further analysis. It supports Oscilloscopes, Digital Multi Meters (DMM), Power supplies, and Source Measure Units (SMU).

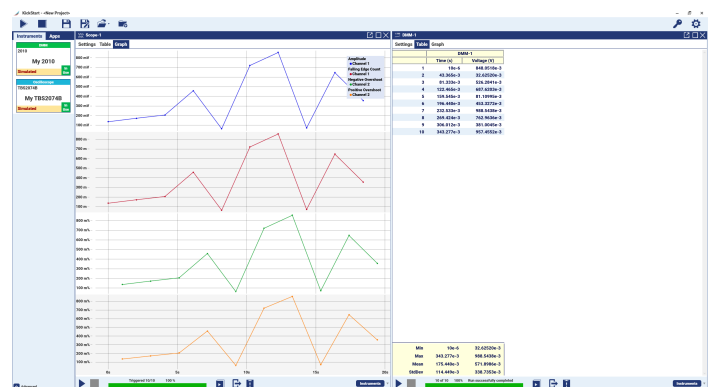

Figure 13: Control multiple instruments and data logging with Kickstart

Performance you can count on

Tektronix has industry-leading service and support, and every TBS1000C Series Oscilloscope is backed with a standard five-year warranty.

Specifications

All specifications are guaranteed unless noted otherwise. All specifications apply to all models unless noted otherwise.

Model overview

Parameters	TBS1052C	TBS1072C	TBS1102C	TBS1202C
Bandwidth	50 MHz	70 MHz	100 MHz	200 MHz
Channels	2	2	2	2
Sample Rate	1 GS/s	1 GS/s	1 GS/s	1 GS/s
Record Length	20 K points	20 K points	20 K points	20 K points

Vertical system - Analog channels

Vertical resolution	8 bits
Input sensitivity range	1 mV/div to 10 V/div max. in 1-2-5 sequence with probe attenuation set to 1X
DC gain accuracy	$\pm 3.0\%$ step gain, derated at $0.1\%/^{\circ}\text{C}$ above 30°C
Maximum Input Voltage	300 VRMS, Installation Category II; derate above 4 MHz at 20 dB per decade to 200 MHz
Offset range	1 mV/div to 50 mV/div: $\pm 1\text{ V}$ 100 mV/div to 500 mV/div: $\pm 10\text{ V}$ 1 V/div to 5 V/div : $\pm 100\text{ V}$
Bandwidth limit	20 MHz (Typ)
Input coupling	DC, AC
Input impedance	$1\text{ M}\Omega \pm 2\%$ in parallel with $14\text{ pF} \pm 2\text{ pF}$
Vertical zoom	Vertically expand or compress a live or stopped waveform
Acquisition modes	
Sample	Acquire sampled values
Peak Detect	Captures glitches as narrow as 4 nsec at all sweep speeds.
Average	From 2 to 256 waveforms included in average.
Hi-Resolution	Averages multiple sample of one acquisition interval into one waveform point.
Roll	Scrolls waveforms right to left across the screen at sweep speeds slower than or equal to 40 ms/div

Horizontal system - Analog channels

Timebase accuracy	20 ppm
-------------------	--------

Timebase range

TBS1202C, TBS1052C,
TBS1072C, TBS1102C 2 ns/div to 100 sec/div in a 1-2-4 sequence

Horizontal zoom

Horizontally expand or compress a live or stopped waveform

Deskew range

± 100 nsec

Trigger system**External trigger input**

Included on all models

Trigger modes

Auto, Normal, Single Sequence

Trigger Types**Edge**

Positive or negative slope on any channel. Coupling includes DC, HF reject, LF reject, and noise reject.

Pulse Width

Trigger on width of positive or negative pulses that are >, <, =, or ≠ a specified period of time.

Runt

Trigger on a pulse that crosses one threshold but fails to cross a second threshold before crossing the first again.

Trigger source

CH1, CH2, AUX IN, AC Line

Trigger Coupling

DC, Noise Reject, High Frequency Reject, Low Frequency Reject

Trigger signal frequency readout

Provides a frequency readout of the trigger source up to instrument bandwidth.

Waveform measurements**Cursors**

Time, Amplitude, Screen

Automated measurements

32, of which up to six can be displayed on-screen at any one time. Measurements include: Period, Frequency, Rise Time, Fall Time, Positive Duty Cycle, Negative Duty Cycle, Positive Pulse Width, Negative Pulse Width, Burst Width, Phase, Positive Overshoot, Negative Overshoot, Peak to Peak, Amplitude, High, Low, Max, Min, Mean, Cycle Mean, RMS, Cycle RMS, Positive Pulse Count, Negative Pulse Count, Rising Edge Count, Falling Edge Count, Area, Cycle Area, Delay FR, Delay FF, Delay RR, and Delay RR.

Gating

Isolate the specific occurrence within an acquisition to take measurements on, using either the screen, between waveform cursors or full record length.

Waveform math**Arithmetic**

Add, Subtract, and Multiply waveforms

FFT

Spectral magnitude. Set FFT Vertical Scale to Linear RMS or dBV RMS, and FFT Window to Rectangular, Hamming, Hanning, or Blackman-Harris.

Display system

Display Type	7-inch TFT Color Display
Display Resolution	800 horizontal by 480 vertical displayed pixels (WVGA)
Waveform styles	Vectors, Variable persistence, and Infinite persistence.
Format	YT and XY

Input Output Ports

USB 2.0 Host Port	Supports USB mass storage devices
USB 2.0 device port	Rear-panel connector allows for communication/control of oscilloscope through USBTMC or GPIB with a TEK-USB-488
Probe Compensator	
Amplitude	5 V
Frequency	1 KHz
Kensington Style Lock	Rear-panel security slot connects to standard Kensington style lock

Power source

Power source	100 to 240 VAC RMS \pm 10%
Power source frequency	45 Hz to 65 Hz (100 to 240 V) 360 Hz to 440 Hz (100 to 132 V)
Power consumption	30 W maximum

Physical characteristics

Dimensions	Parameters	mm	in.
	Height	154.95	6.1
	Width	325.12	12.8
	Depth	106.68	4.2

Shipping dimensions	Parameters	mm	in.
	Height	266.7	10.5
	Width	476.2	18.75
	Depth	228.6	9.0

Weight

Parameters	kg	lb
Instrument only	1.979	4.36
Instrument with accessories	2.2	4.9

RM2000B rackmount

Parameters	mm	in
Height	177.8	7.0
Width	482.6	19.0
Depth	108.0	4.25

Cooling Clearance

50 mm (2 in) required on left side, right side, and rear of instrument.

Environmental and safety**Temperature**

Operating	0 °C to +50 °C
Non-operating	-30 °C to +71 °C

Humidity

Operating	5% to 90% relative humidity (% RH) at up to +30 °C, 5% to 60% RH above +30 °C up to +50 °C, non-condensing.
Non-operating	5% to 90% RH (Relative Humidity) at up to +30 °C, 5% to 60% RH above +30 °C up to +60 °C, non-condensing.

Altitude

Operating	Up to 3,000 m (9,842 ft.)
Non-operating	Up to 12,000 meters (39,370 ft.)

Regulatory

Electromagnetic compatibility	EC Council Directive 2014/30/EU UL61010-1, UL61010-2-030, CAN/CSA-C22.2 No. 61010.1, CAN/CSA-C22.2 No. 61010-2:030; EN61010-1, EN61010-2-030
Safety	Complies with the Low Voltage Directive 2014/35/EU for Product Safety

Ordering Information

Models

Model	Description
TBS1052C	Digital Storage Oscilloscope: 50 MHz bandwidth, 1 GS/s sample rate, 2 Channel
TBS1072C	Digital Storage Oscilloscope: 70 MHz bandwidth, 1 GS/s sample rate, 2 Channel
TBS1102C	Digital Storage Oscilloscope: 100 MHz bandwidth, 1 GS/s sample rate, 2 Channel
TBS1202C	Digital Storage Oscilloscope: 200 MHz bandwidth, 1 GS/s sample rate, 2 Channel

Instrument Options

Language Options

Opt. L0	English front panel overlay
Opt. L1	French front panel overlay
Opt. L2	Italian front panel overlay
Opt. L3	German front panel overlay
Opt. L4	Spanish front panel overlay
Opt. L5	Japanese front panel overlay
Opt. L6	Portuguese front panel overlay
Opt. L7	Simplified Chinese front panel overlay
Opt. L8	Traditional Chinese front panel overlay
Opt. L9	Korean front panel overlay
Opt. L10	Russian front panel overlay

Power Plug Options

Opt. A0	North America power plug (115 V, 60 Hz)
Opt. A1	Universal Euro power plug (220 V, 50 Hz)
Opt. A2	United Kingdom power plug (240 V, 50 Hz)
Opt. A3	Australia power plug (240 V, 50 Hz)
Opt. A5	Switzerland power plug (220 V, 50 Hz)
Opt. A6	Japan power plug (100 V, 50/60 Hz)
Opt. A10	China power plug (50 Hz)
Opt. A11	India power plug (50 Hz)
Opt. E1	Universal Euro, United Kingdom, and Switzerland

Standard accessories

Probe

Accessory	Description
TPP0200	200 MHz models, 10x passive probe one per analog channel
TPP0100	50 MHz, 70 MHz, and 100MHz and models, 10x passive probe one per analog channel

Accessories

Accessory	Description
071-3660-00	Compliance and Safety Instructions
077-1691-00	Programmer manual, available on www.tek.com
-	Power cord
-	Calibration certificate documenting traceability to National Metrology Institute(s) and ISO9001 quality system registration

Warranty

Five-year warranty covering all parts and labor, excluding probes.

Recommended accessories

Accessory	Description
TEK-USB-488	GPIB-to-USB converter
AC2100	Soft carrying case for instrument
HCTEK4321	Hard plastic carrying case for instrument (requires AC2100)
RM2000B	Rackmount kit
174-4401-xx	USB host to device cable, 3 ft. long

Recommended probes

Probe	Description
TPP0100	10X passive probe, 100 MHz bandwidth
TPP0200	10X passive probe, 200 MHz bandwidth
P2221	1X/10X passive probe, 200 MHz bandwidth
P6101B	1X passive probe (15 MHz, 300 VRMS CAT II rating)
P6015A	1000X high-voltage passive probe (75 MHz)
P5100A	100X high-voltage passive probe (500 MHz)
P5200A	50 MHz, 50X/500X high-voltage differential probe
P6021A	15 A, 60 MHz AC current probe
P6022	6 A, 120 MHz AC current probe
A621	2000 A, 5 to 50 kHz AC current probe
A622	100 A, 100 kHz AC/DC current probe
TCP303/TCPA300 ¹	150 A, 15 MHz AC/DC current probe/amplifier
TCP305A/TCPA300 ¹	50 A, 50 MHz AC/DC current probe/amplifier
TCP312A/TCPA300 ¹	30 A, 100 MHz AC/DC current probe/amplifier
TCP404XL/TCPA400 ¹	500 A, 2 MHz AC/DC current probe/amplifier

¹ 50 Ω termination adapter (part number 011-0049-xx) is required



Tektronix is registered to ISO 9001 and ISO 14001 by SRI Quality System Registrar.



Product(s) complies with IEEE Standard 488.1-1987, RS-232-C, and with Tektronix Standard Codes and Formats.



Product Area Assessed: The planning, design/development and manufacture of electronic Test and Measurement instruments.

ASEAN / Australasia (65) 6356 3900
 Belgium 00800 2255 4835*
 Central East Europe and the Baltics +41 52 675 3777
 Finland +41 52 675 3777
 Hong Kong 400 820 5835
 Japan 81 (3) 6714 3086
 Middle East, Asia, and North Africa +41 52 675 3777
 People's Republic of China 400 820 5835
 Republic of Korea +822 6917 5084, 822 6917 5080
 Spain 00800 2255 4835*
 Taiwan 886 (2) 2656 6688

Austria 00800 2255 4835*
 Brazil +55 (11) 3759 7627
 Central Europe & Greece +41 52 675 3777
 France 00800 2255 4835*
 India 000 800 650 1835
 Luxembourg +41 52 675 3777
 The Netherlands 00800 2255 4835*
 Poland +41 52 675 3777
 Russia & CIS +7 (495) 6647564
 Sweden 00800 2255 4835*
 United Kingdom & Ireland 00800 2255 4835*

Balkans, Israel, South Africa and other ISE Countries +41 52 675 3777
 Canada 1 800 833 9200
 Denmark +45 80 88 1401
 Germany 00800 2255 4835*
 Italy 00800 2255 4835*
 Mexico, Central/South America & Caribbean 52 (55) 56 04 50 90
 Norway 800 16098
 Portugal 80 08 12370
 South Africa +41 52 675 3777
 Switzerland 00800 2255 4835*
 USA 1 800 833 9200

* European toll-free number. If not accessible, call: +41 52 675 3777

For Further Information. Tektronix maintains a comprehensive, constantly expanding collection of application notes, technical briefs and other resources to help engineers working on the cutting edge of technology. Please visit www.tek.com.

Copyright © Tektronix, Inc. All rights reserved. Tektronix products are covered by U.S. and foreign patents, issued and pending. Information in this publication supersedes that in all previously published material. Specification and price change privileges reserved. TEKTRONIX and TEK are registered trademarks of Tektronix, Inc. All other trade names referenced are the service marks, trademarks, or registered trademarks of their respective companies.

15 Dec 2020 3GW-61674-1
www.tek.com

Tektronix[®]