



TBS1000C Series Oscilloscopes

User Manual



077-1571-01



TBS1000C Series Oscilloscopes User Manual

Register now!
Click the following link to protect your product.
www.tek.com/register

Copyright © Tektronix. All rights reserved. Licensed software products are owned by Tektronix or its subsidiaries or suppliers, and are protected by national copyright laws and international treaty provisions. Tektronix products are covered by U.S. and foreign patents, issued and pending. Information in this publication supersedes that in all previously published material. Specifications and price change privileges reserved.

TekVPI and e*Scope are registered trademarks of Tektronix, Inc.

TEKTRONIX and TEK are registered trademarks of Tektronix, Inc.

Contacting Tektronix

Tektronix, Inc.

14150 SW Karl Braun Drive

P.O. Box 500

Beaverton, OR 97077

USA

For product information, sales, service, and technical support:

- In North America, call 1-800-833-9200.
- Worldwide, visit www.tek.com to find contacts in your area.

Table of Contents

List of Figures.....	9
List of Tables.....	10
TEKTRONIX SOFTWARE LICENSE AGREEMENT.....	11
Important safety information.....	15
General safety summary.....	15
Symbols and terms on the product.....	17
Compliance information.....	19
EMC compliance.....	19
Safety compliance.....	19
Environmental considerations.....	21
Preface.....	22
Key features.....	22
Conventions used in this manual.....	22
Installation.....	23
Unpacking the Oscilloscope.....	23
Operating requirements.....	27
Environment requirements.....	27
Power requirements.....	27
TPP0100, TPP0200 series 10X passive probes information.....	27
Connecting the probe to the oscilloscope.....	28
Compensating the probe.....	28
Connecting the probe to the circuit.....	29
Standard accessories.....	29
Optional accessories.....	30
Specifications.....	30
Performance graphs.....	32
Getting acquainted with the oscilloscope.....	34
Powering the oscilloscope.....	34
Changing the user interface language.....	35
Changing the date and time.....	38
Supported probe types.....	41
Reducing electrostatic damage while taking measurements.....	41
Doing a functional check.....	41
What is Autoset.....	44
Probes and ground leads tip.....	44
Getting on-screen help for settings HelpEverywhere™	45
Signal path compensation SPC.....	47
The Scope Intro function.....	48
Sampling oscilloscope concepts.....	50
Sampling and acquisition concepts.....	50
Acquisition mode concepts.....	50
Trigger concepts.....	51
Trigger slope and level concepts.....	52
Available trigger types.....	53

Trigger coupling.....	53
Trigger modes.....	54
Auto Untriggered Roll trigger mode.....	54
Normal trigger mode.....	54
Holdoff trigger mode.....	54
Trigger delay acquisition mode.....	54
Setting channel input parameters.....	56
Setting input signal coupling.....	56
Inverting the input signal.....	56
Setting the oscilloscope bandwidth.....	57
Setting the probe type voltage or current.....	57
Setting the probe attenuation factor.....	58
Quickly setting the probe attenuation to 1X or 10X.....	58
Setting the measure current mode for voltage probes.....	59
Setting the input signal vertical offset.....	59
Setting the waveform vertical position.....	60
The difference between vertical position and vertical offset.....	60
Setting channel deskew.....	61
Deskew tips.....	61
Trigger setup.....	63
Triggering on a waveform edge.....	63
Triggering on a specified pulse width.....	64
Triggering on a runt pulse.....	64
Setting the trigger mode.....	65
Trigger on an external signal using the AUX input.....	66
Acquisition setup.....	67
Using Autoset.....	67
Autoset tips.....	67
How to enable/disable Autoset in the oscilloscope.....	68
How to change the Autoset password.....	69
Starting and stopping an acquisition.....	70
Setting the acquisition mode.....	71
Setting the acquisition trigger delay time.....	72
Setting the record length.....	73
Using the roll display mode.....	74
Roll mode tips.....	74
Setting the oscilloscope to factory default values - Default Setup.....	75
Waveform display settings.....	76
Displaying and removing a waveform.....	76
Setting the waveform persistence.....	76
Waveform persistence tip.....	77
The XY display mode.....	77
XY display mode tips.....	79
Setting the backlight intensity.....	79
Analyzing a waveform.....	80
Taking automatic measurements.....	80
Automatic measurements tip.....	81
Taking a measurement snapshot.....	81
Snapshot measurement tip.....	82

Automatic measurement descriptions.....	82
Frequency measurement descriptions.....	82
Time measurement descriptions.....	83
Amplitude measurement descriptions.....	84
Area measurement descriptions.....	86
Taking a measurement on just a part of the waveform Gating.....	86
How to enable / disable measurement in the oscilloscope.....	87
Using cursors to take manual measurements.....	88
Cursor types.....	90
How to enable / disable cursor in the oscilloscope.....	91
Creating math waveforms.....	92
Math waveform tips.....	94
Using FFT to see signal frequency information.....	94
FFT tips.....	98
About FFT windows.....	98
FFT and display waveform aliasing.....	100
Displaying reference waveforms.....	100
Reference waveform tips.....	101
How to view long record length waveforms Zoom.....	101
How to pan a waveform.....	102
How to change the measurement password.....	103
Saving data.....	104
Saving screen images to a file.....	104
About saved image file formats.....	104
Saving waveform data.....	105
Saving oscilloscope setup information.....	106
Saving files to USB with the Save File button.....	106
About waveform data files.....	107
Recalling data.....	108
Recalling oscilloscope setup information.....	108
Recalling waveform data.....	108
Using the USB file utility functions.....	110
Overview of the File Utility pane.....	110
Changing the default file save location on the USB drive.....	111
Default save folder location rules.....	111
Creating a new folder on the USB drive.....	112
Folder creation tip.....	112
Deleting files or folders from the USB drive.....	112
Renaming files or folders on the USB drive.....	113
File folder renaming tip.....	114
About automatically generated file names.....	114
Image setting and waveform file tips.....	115
Erasing data from oscilloscope memory (TekSecure).....	116
Setting or viewing USB Device port parameters.....	117
Disabling the USB Device port.....	117
Selecting which device is attached to the USB Device port.....	117
Viewing the USBTMC information.....	118
Appendices.....	120
Installing new firmware on the oscilloscope.....	120

Running diagnostic tests.....	121
Courseware on-instrument education and training.....	121
Courseware file content information.....	122
Loading a courseware file from a USB drive.....	122
Dealing with error message.....	123
Running Courseware lab exercises.....	123
Saving Courseware lab results.....	124
The oscilloscope controls.....	124
The Navigation controls.....	124
The Horizontal controls.....	126
The Trigger controls.....	127
The Vertical controls.....	127
Using the menu system.....	128
Front-panel connectors.....	130
Rear-panel connectors.....	131
The graphical user interface elements.....	131
Labeling channels.....	135
Warranted specifications.....	137
Cleaning.....	137
General care.....	137
Cleaning.....	137
The default oscilloscope settings Default Setup.....	138
Oscilloscope settings that are not reset by Default Setup.....	139
Physically securing the oscilloscope.....	139
Environmental considerations.....	140
Product end-of-life handling.....	140
Equipment recycling.....	140
Index.....	141

List of Figures

Figure 1: Untriggered display.....	51
Figure 2: Triggered display.....	52

List of Tables

Table 1: Electrical and mechanical specifications.....	30
Table 2: Electrical and mechanical specifications.....	31
Table 3: Environmental specifications.....	31
Table 4: Certifications and compliances.....	32
Table 5: Roll mode is enabled when:.....	74
Table 6: Frequency measurements.....	83
Table 7: Time measurements.....	83
Table 8: Amplitude measurements.....	85
Table 9: Area measurements.....	86
Table 10: FFT windows.....	99

TEKTRONIX SOFTWARE LICENSE AGREEMENT

This End User Agreement (“Agreement”) is an agreement between Tektronix, Inc., an Oregon corporation, and its corporate affiliates, subsidiaries, and divisions as applicable (collectively, “Tektronix,” “we,” “us,” or “our”) and You (including any entity or organization you represent, collectively, “Customer” or “You”). Please read this Agreement carefully as this Agreement governs the terms and conditions under which You are permitted to use Tektronix’s software and services.

THE SOFTWARE, ENCODED OR INCORPORATED WITHIN EQUIPMENT OR ACCOMPANYING THIS AGREEMENT, IS FURNISHED SUBJECT TO THE TERMS AND CONDITIONS OF THIS AGREEMENT. BY INDICATING YOUR ACCEPTANCE OF THESE TERMS BY SELECTING AN “ACCEPT” OR SIMILAR BUTTON IN A SOFTWARE MENU, OR BY RETAINING THE SOFTWARE FOR MORE THAN THIRTY DAYS OR USING THE SOFTWARE IN ANY MANNER YOU (A) ACCEPT THIS AGREEMENT AND AGREE THAT YOU ARE LEGALLY BOUND BY ITS TERMS; AND (B) REPRESENT AND WARRANT THAT: (I) YOU ARE OF LEGAL AGE TO ENTER INTO A BINDING AGREEMENT; AND (II) IF YOU ARE A REPRESENTATIVE FOR A CORPORATION OR OTHER LEGAL ENTITY, YOU HAVE THE RIGHT, POWER, AND AUTHORITY TO ENTER INTO THIS AGREEMENT ON BEHALF OF SUCH ENTITY AND BIND SUCH ENTITY TO ITS TERMS. IF YOU DO NOT AGREE TO THE TERMS OF THIS AGREEMENT, TEKTRONIX WILL NOT AND DOES NOT LICENSE THE SOFTWARE TO YOU AND YOU MUST NOT DOWNLOAD, INSTALL, OR USE THE SOFTWARE. UNITED STATES GOVERNMENT CUSTOMERS OR END-USERS MAY REQUEST A GOVERNMENT ADDENDUM TO THIS AGREEMENT.

NOTWITHSTANDING ANYTHING TO THE CONTRARY IN THIS AGREEMENT OR YOUR ACCEPTANCE OF THE TERMS AND CONDITIONS OF THIS AGREEMENT, NO LICENSE IS GRANTED (WHETHER EXPRESSLY, BY IMPLICATION, OR OTHERWISE) UNDER THIS AGREEMENT TO ANY SOFTWARE THAT YOU DID NOT ACQUIRE LAWFULLY OR THAT IS NOT A LEGITIMATE, AUTHORIZED COPY OF TEKTRONIX’S SOFTWARE. THIS AGREEMENT EXPRESSLY EXCLUDES ANY RIGHTS CONCERNING SUCH ILLEGITIMATE COPIES.

IF THESE TERMS ARE NOT ACCEPTABLE, THE UNUSED SOFTWARE AND ANY ACCOMPANYING DOCUMENTATION SHOULD BE RETURNED PROMPTLY TO TEKTRONIX (WITHIN 30 DAYS OF PURCHASE) FOR A FULL REFUND OF THE LICENSE FEE PAID. (FOR INFORMATION REGARDING THE RETURN OF SOFTWARE ENCODED OR INCORPORATED WITHIN EQUIPMENT, CONTACT THE NEAREST TEKTRONIX SALES OFFICE.)

DEFINITIONS

“Equipment” means Tektronix equipment that the Software is encoded or incorporated within or installed onto.

LICENSE

Subject to the terms and conditions of this Agreement, Tektronix grants You a non-exclusive, non-transferable license to the Software, as follows

You may:

1. Use the Software with the Equipment, or if the Software is not encoded or incorporated in any Tektronix equipment, on no more than one machine at a time; and
2. Copy the Software for archival or backup purposes, provided that no more than one (1) such copy is permitted to exist at any one time, and provided that each copy includes a reproduction of any patent or copyright notice or restrictive rights legend that was included with the Software, as received from Tektronix;
3. Fully transfer the Equipment to a third party but only if prominently accompanied by this End User License Agreement, and such third-party recipients agree to be bound by the terms of this Agreement; and
4. Integrate Tektronix products that contain the Software into a system and sell or distribute that system to third parties, provided that those third parties are bound by the terms of this Agreement, and provided that You (i) do not separate the Software from any Equipment it is incorporated into, (ii) do not retain any copies of the Software, and (iii) do not modify the Software.

You may not:

1. Use the Software other than for its intended purpose as provided above in the section “You may,” or in conflict with the terms and restrictions of this Agreement;
2. Distribute or transfer the Software to any person or organization outside of Your organization without Tektronix’s prior written consent, except in connection with a permitted use authorized in “You may” paragraphs 3 or 4 above;

3. Decompile, decrypt, disassemble, or otherwise attempt to derive the source code, techniques, processes, algorithms, know-how, or other information (collectively "Reverse Engineer") from the Software or permit or induce any third party to do so, except to the limited extent allowed by directly applicable law or third party license (if any), and only to obtain information necessary to achieve interoperability of independently created software with the Software;
4. Modify, translate, adapt, or create derivative works of the Software, or merge the Software with any other software;
5. Copy the documentation accompanying the Software;
6. Remove any copyright, trademark, or other proprietary notices from the Software or any media relating thereto; or
7. Export or re-export, directly or indirectly, the Software or Equipment, any associated documentation, or systems created in accordance with "You may" section 4 above, to any country to which such export or re-export is restricted by law or regulation of the United States or any foreign government having jurisdiction without the prior authorization, if required, of the Office of Export Administration, Department of Commerce, Washington, D.C. and the corresponding agency of such foreign government;
8. Use the Software or Equipment in any manner or for any purpose that infringes, misappropriates, or otherwise violates any intellectual property rights or other proprietary rights of any person, or any applicable laws;
9. Use the Software or Equipment in a network or system with other products or services that are incompatible, insecure or not compliant with applicable laws;
10. Bypass, circumvent, damage or otherwise interfere with any security or other features of the Software or Equipment designed to control the manner in which they are used, or harvest or mine Tektronix's proprietary content or information from the Software or Equipment.

THE SOFTWARE MAY NOT BE USED, COPIED, MODIFIED, MERGED, OR TRANSFERRED TO ANOTHER EXCEPT AS EXPRESSLY PERMITTED BY THESE TERMS AND CONDITIONS.

FEEDBACK

If You provide feedback to Tektronix concerning the functionality and performance of the Software or Equipment, including without limitation identifying potential errors and improvements, any comments, questions, suggestions, or the like ("Feedback"), Tektronix is free to use such Feedback without any attribution, compensation, or restriction in any manner to improve or enhance its products, irrespective of any other obligation or limitation between the Parties governing such Feedback. You hereby grant Tektronix an irrevocable, worldwide, perpetual, royalty-free license to use Your Feedback for any purpose whatsoever and waive any moral rights You may have in the Feedback. Tektronix is not obligated to use Your Feedback.

OWNERSHIP

Title to the Software and all copies thereof, but not the media on which the Software or copies may reside, shall remain with Tektronix or others from whom Tektronix has obtained a respective licensing right.

GOVERNMENT NOTICE

If the Software or any related documentation is acquired by or for an agency of the U.S. Government, the Software and documentation shall be considered "commercial computer software" or "commercial computer software documentation" respectively, as those terms are used in 48 CFR §12.212, 48 CFR §227.7202, or 48 CFR §252.227-7014, and are licensed with only those rights as are granted to all other licensees as set forth in this Agreement.

TERM

The license granted herein is effective until terminated. The license may be terminated by You at any time upon written notice to Tektronix. The license may be terminated by Tektronix if You fail to comply with any term or condition and such failure is not remedied within fifteen (15) days after notice hereof from Tektronix. Upon termination by either party, You shall return to Tektronix or destroy, the Software and all associated documentation, together with all copies in any form.

IF YOU TRANSFER, DISTRIBUTE, OR OTHERWISE MAKE AVAILABLE ANY COPY, MODIFICATION, OR MERGED PORTION OF THE SOFTWARE WITHOUT THE AS EXPRESS PERMISSION OF THESE TERMS AND CONDITIONS OR PRIOR WRITTEN CONSENT OF TEKTRONIX, YOUR LICENSE WILL BE IMMEDIATELY AND AUTOMATICALLY TERMINATED.

LIMITED WARRANTY

Tektronix does not warrant that the functions contained in the Software will meet Your requirements or that the operation of the Software will be uninterrupted, secure, or error-free.

EXCEPT AS SEPARATELY PROVIDED IN A WRITTEN WARRANTY FROM TEKTRONIX, THE SOFTWARE IS PROVIDED "AS IS" WITHOUT ANY WARRANTY OF ANY KIND, EXPRESS OR IMPLIED, INCLUDING BUT NOT LIMITED TO, THE WARRANTIES OF MERCHANTABILITY, FITNESS FOR A PARTICULAR PURPOSE, TITLE, QUIET ENJOYMENT, AND NON-INFRINGEMENT.

THE SOFTWARE IS NOT DESIGNED OR INTENDED FOR USE IN HAZARDOUS ENVIRONMENTS REQUIRING FAIL-SAFE PERFORMANCE INCLUDING WITHOUT LIMITATION, IN THE OPERATION OF NUCLEAR FACILITIES, AIRCRAFT NAVIGATION OR COMMUNICATION SYSTEMS, AIR TRAFFIC CONTROL, WEAPONS SYSTEMS, DIRECT LIFE-SUPPORT MACHINES, OR ANY OTHER APPLICATION IN WHICH THE FAILURE OF THE SOFTWARE COULD LEAD TO DEATH, PERSONAL INJURY OR SEVERE PHYSICAL OR PROPERTY DAMAGE (COLLECTIVELY "HAZARDOUS ACTIVITIES"). TEKTRONIX AND ITS AFFILIATES, LICENSORS, AND RESELLERS EXPRESSLY DISCLAIM ANY EXPRESS OR IMPLIED WARRANTY OF FITNESS FOR HAZARDOUS ACTIVITIES.

LIMITATION OF LIABILITY

IN NO EVENT SHALL TEKTRONIX, ITS AFFILIATES, LICENSORS, OR RESELLERS BE LIABLE FOR: (1) ECONOMICAL, INCIDENTAL, CONSEQUENTIAL, INDIRECT, SPECIAL, PUNITIVE OR EXEMPLARY DAMAGES, WHETHER CLAIMED UNDER CONTRACT, TORT OR ANY OTHER LEGAL THEORY, (2) LOSS OF OR DAMAGE TO YOUR DATA OR PROGRAMMING, LOSS OF PROFITS, BUSINESS INTERRUPTION, OR OTHER PECUNIARY LOSS ARISING FROM THE USE OF (OR INABILITY TO USE) THE SOFTWARE, (3) PENALTIES OR PENALTY CLAUSES OF ANY DESCRIPTION, (4) ANY DAMAGE, CLAIMS, OR LOSSES RESULTING FROM THE USE OF THE SOFTWARE IN CONJUNCTION WITH OTHER PRODUCTS OR SERVICES (INCLUDING THIRD-PARTY PRODUCTS OR SERVICES); OR (5) INDEMNIFICATION OF YOU OR OTHERS FOR COSTS, DAMAGES, OR EXPENSES RELATED TO THE GOODS OR SERVICES PROVIDED UNDER THIS LIMITED WARRANTY, EVEN IF TEKTRONIX OR ITS AFFILIATES, LICENSORS, OR RESELLERS HAVE ADVANCE NOTICE OF THE POSSIBILITY OF SUCH DAMAGES. BECAUSE SOME STATES/JURISDICTIONS DO NOT ALLOW THE EXCLUSION OR LIMITATION OF LIABILITY FOR CONSEQUENTIAL OR INCIDENTAL DAMAGES, SOME OF THE ABOVE LIMITATIONS MAY NOT APPLY TO YOU, BUT THEY SHALL APPLY TO THE MAXIMUM EXTENT PERMITTED BY LAW. NOTWITHSTANDING ANYTHING HEREIN TO THE CONTRARY, IN NO EVENT SHALL TEKTRONIX'S TOTAL AGGREGATED LIABILITY TO YOU FOR ALL DAMAGES IN ANY ONE OR MORE CAUSES OF ACTION EXCEED THE AMOUNT RECEIVED BY TEKTRONIX FROM YOU FOR THE SOFTWARE OR EQUIPMENT.

You are solely responsible for Your data. You must back up Your data before Tektronix or a third party performs any remedial, upgrade, or other work on Your systems, including any Equipment. If applicable law prohibits exclusion of liability for lost data, then Tektronix will only be liable for the cost of the typical effort to recover the lost data from Your last available back up.

SECURITY DISCLAIMER

This Software and its associated Equipment are not designed or intended to be used with unsecure networks. You acknowledge that use of the Equipment may rely upon certain networks, systems, and data communication mediums that are not controlled by Tektronix and that may be vulnerable to data or security breaches, including, without limitation, internet networks used by Your internet providers and the databases and servers controlled by Your internet providers. Tektronix shall not be liable for any such breaches, including without limitation, damages and/or loss of data related to any security breach, and disclaims all warranties, including any implied or express warranties that any content will be secure or not otherwise lost or altered.

For the avoidance of doubt, if You choose to connect this Software or Equipment to a network, it is Your sole responsibility to provide and continuously ensure a secure connection to that network. You agree to establish and maintain appropriate measures (e.g., firewalls, authentication measures, encryption, anti-virus applications, etc.) to protect the Software and Equipment and any associated data against security breaches including unauthorized access, destruction, use, modification, or disclosure. Notwithstanding the foregoing, You shall not use any Products in a network with other products or services that are incompatible, insecure or not compliant with applicable laws.

THIRD-PARTY DISCLAIMER

The Software may contain software owned by third parties and obtained under a license from those parties ("Third Party Software"). Your use of such Third Party Software is subject to the terms and conditions of this Agreement and the applicable Third Party Software licenses. Except as expressly agreed otherwise, third parties do not warrant the Third Party Software, do not assume any liability with respect to its use, and do not undertake to furnish any support or information relating thereto.

GENERAL

Unless the Customer is the United States Government, this Agreement contains the entire agreement between the parties with respect to the use, reproduction, and transfer of the Software, and shall be governed by the laws of the state of Oregon.

You shall be responsible for any taxes that may now or hereafter be imposed, levied or assessed with respect to the possession or use of the Software or the rights and licenses granted under this Agreement, including any sales, use, property, value added, and excise taxes, and similar taxes, duties, or charges.

Any waiver by either party of any provision of this Agreement shall not constitute or be deemed a subsequent waiver of that or any other portion.

You may not assign this Agreement or any right or obligation under this Agreement, or delegate any performance, without Tektronix's prior written consent. This section does not prohibit You from transferring the Equipment in accordance with Subsections 3 and 4 of the Section titled "You may" above.

All questions regarding this Agreement should be directed to the nearest Tektronix Sales Office.

Important safety information

This manual contains information and warnings that must be followed by the user for safe operation and to keep the product in a safe condition. To safely perform service on this product, additional information is provided at the end of this section.

General safety summary

Use the product only as specified. Review the following safety precautions to avoid injury and prevent damage to this product or any products connected to it. Carefully read all instructions. Retain these instructions for future reference.

Comply with local and national safety codes.

For correct and safe operation of the product, it is essential that you follow generally accepted safety procedures in addition to the safety precautions specified in this manual.

The product is designed to be used by trained personnel only.

Only qualified personnel who are aware of the hazards involved should remove the cover for repair, maintenance, or adjustment.

Before use, always check the product with a known source to be sure it is operating correctly.

This product is not intended for detection of hazardous voltages.

Use personal protective equipment to prevent shock and arc blast injury where hazardous live conductors are exposed.

While using this product, you may need to access other parts of a larger system. Read the safety sections of the other component manuals for warnings and cautions related to operating the system.

When incorporating this equipment into a system, the safety of that system is the responsibility of the assembler of the system.

To avoid fire or personal injury

Use proper power cord	Use only the power cord specified for this product and certified for the country of use. Do not use the provided power cord for other products.
Ground the product	This product is grounded through the grounding conductor of the power cord. To avoid electric shock, the grounding conductor must be connected to earth ground. Before making connections to the input or output terminals of the product, ensure that the product is properly grounded. Do not disable the power cord grounding connection.
Ground-referenced oscilloscope use	Do not float the reference lead of this probe when using with ground-referenced oscilloscopes. The reference lead must be connected to earth potential (0 V).
Power disconnect	The power cord disconnects the product from the power source. See instructions for the location. Do not position the equipment so that it is difficult to access the power cord; it must remain accessible to the user at all times to allow for quick disconnection if needed.
Connect and disconnect properly	Do not connect or disconnect probes or test leads while they are connected to a voltage source. Use only insulated voltage probes, test leads, and adapters supplied with the product, or indicated by Tektronix to be suitable for the product.
Observe all terminal ratings	To avoid fire or shock hazard, observe all ratings and markings on the product. Consult the product manual for further ratings information before making connections to the product. Do not exceed the Measurement Category (CAT) rating and voltage or current rating of the lowest rated individual component of a product, probe, or accessory. Use caution when using 1:1 test leads because the probe tip voltage is directly transmitted to the product. Do not apply a potential to any terminal, including the common terminal, that exceeds the maximum rating of that terminal.

	Do not float the common terminal above the rated voltage for that terminal.
Do not operate without covers	Do not operate this product with covers or panels removed, or with the case open. Hazardous voltage exposure is possible.
Avoid exposed circuitry	Do not touch exposed connections and components when power is present.
Do not operate with suspected failures	If you suspect that there is damage to this product, have it inspected by qualified service personnel. Disable the product if it is damaged. Do not use the product if it is damaged or operates incorrectly. If in doubt about safety of the product, turn it off and disconnect the power cord. Clearly mark the product to prevent its further operation. Before use, inspect voltage probes, test leads, and accessories for mechanical damage and replace when damaged. Do not use probes or test leads if they are damaged, if there is exposed metal, or if a wear indicator shows. Examine the exterior of the product before you use it. Look for cracks or missing pieces. Use only specified replacement parts.
Do not operate in wet/damp conditions	 Note: Be aware that condensation may occur if a unit is moved from a cold to a warm environment.
Do not operate in an explosive atmosphere	
Keep product surfaces clean and dry	Remove the input signals before you clean the product.
Provide proper ventilation	To ensure proper cooling, keep the sides and rear of the instrument clear of obstructions. Slots and openings are provided for ventilation and should never be covered or otherwise obstructed. Do not push objects into any of the openings.
Provide a safe working environment	Always place the product in a location convenient for viewing the display and indicators. Avoid improper or prolonged use of keyboards, pointers, and button pads. Improper or prolonged keyboard or pointer use may result in serious injury. Be sure your work area meets applicable ergonomic standards. Consult with an ergonomics professional to avoid stress injuries. Use care when lifting and carrying the product. This product is provided with a handle or handles for lifting and carrying. Use only the Tektronix rackmount hardware specified for this product.

Probes and test leads

Before connecting probes or test leads, connect the power cord from the power connector to a properly grounded power outlet.

Keep fingers behind the finger guards on the probes.

Remove all probes, test leads and accessories that are not in use.

Use only correct Measurement Category (CAT), voltage, temperature, altitude, and amperage rated probes, test leads, and adapters for any measurement.

Beware of high voltages	Understand the voltage ratings for the probe you are using and do not exceed those ratings. Two ratings are important to know and understand: <ul style="list-style-type: none"> • The maximum measurement voltage from the probe tip to the probe reference lead • The maximum floating voltage from the probe reference lead to earth ground <p>These two voltage ratings depend on the probe and your application. Refer to the Specifications section of the manual for more information.</p>
--------------------------------	---



Warning: To prevent electrical shock, do not exceed the maximum measurement or maximum floating voltage for the oscilloscope input BNC connector, probe tip, or probe reference lead.

Connect and disconnect properly

Connect the probe output to the measurement product before connecting the probe to the circuit under test. Connect the probe reference lead to the circuit under test before connecting the probe input. Disconnect the probe input and the probe reference lead from the circuit under test before disconnecting the probe from the measurement product.

Connect and disconnect properly

De-energize the circuit under test before connecting or disconnecting the current probe.

Connect the probe reference lead to earth ground only.

Do not connect a current probe to any wire that carries voltages or frequencies above the current probe voltage rating.

Inspect the probe and accessories

Before each use, inspect probe and accessories for damage (cuts, tears, or defects in the probe body, accessories, or cable jacket). Do not use if damaged.

Service safety summary

The Service safety summary section contains additional information required to safely perform service on the product. Only qualified personnel should perform service procedures. Read this *Service safety summary* and the *General safety summary* before performing any service procedures.

To avoid electric shock

Do not touch exposed connections.

Do not service alone

Do not perform internal service or adjustments of this product unless another person capable of rendering first aid and resuscitation is present.

Disconnect power

To avoid electric shock, switch off the product power and disconnect the power cord from the mains power before removing any covers or panels, or opening the case for servicing.

Use care when servicing with power on

Dangerous voltages or currents may exist in this product. Disconnect power, remove battery (if applicable), and disconnect test leads before removing protective panels, soldering, or replacing components.

Verify safety after repair

Always recheck ground continuity and mains dielectric strength after performing a repair.

Terms in product manuals

These terms may appear in the product manuals:



Warning: Warning statements identify conditions or practices that could result in injury or loss of life.



CAUTION: Caution statements identify conditions or practices that could result in damage to this product or other property.

Symbols and terms on the product

These terms may appear on the product:

- DANGER indicates an injury hazard immediately accessible as you read the marking.
- WARNING indicates an injury hazard not immediately accessible as you read the marking.
- CAUTION indicates a hazard to property including the product.



When this symbol is marked on the product, be sure to consult the manual to find out the nature of the potential hazards and any actions which have to be taken to avoid them. (This symbol may also be used to refer the user to ratings in the manual.)

The following symbols may appear on the product:



Compliance information

This section lists the EMC (electromagnetic compliance), safety, and environmental standards with which the instrument complies. This product is intended for use by professionals and trained personnel only; it is not designed for use in households or by children.

Questions about the following compliance information may be directed to the following address:

Tektronix, Inc.

PO Box 500, MS 19-045

Beaverton, OR 97077, USA

www.tek.com

EMC compliance

EU EMC Directive

Meets intent of Directive 2014/30/EC for Electromagnetic Compatibility. Compliance was demonstrated to the following specifications as listed in the Official Journal of the European Communities:

EN 61326-1, EN 61326-2-1 EMC requirements for electrical equipment for measurement, control, and laboratory use. ^{1 2 3 4 5}

- CISPR 11. Radiated and conducted emissions, Group 1, Class A
- IEC 61000-4-2. Electrostatic discharge immunity
- IEC 61000-4-3. RF electromagnetic field immunity
- IEC 61000-4-4. Electrical fast transient / burst immunity
- IEC 61000-4-5. Power line surge immunity
- IEC 61000-4-6. Conducted RF immunity
- IEC 61000-4-11. Voltage dips and interruptions immunity

EN 61000-3-2 AC power line harmonic emissions

EN 61000-3-3 Voltage changes, fluctuations, and flicker

Australia / New Zealand Declaration of Conformity – EMC

Complies with the EMC provision of the Radiocommunications Act per the following standard, in accordance with ACMA:

- CISPR 11. Radiated and conducted emissions, Group 1, Class A EN 61326-1 and EN 61326-2-1. Radiated and conducted emissions, Group 1, Class A.

FCC – EMC

Emissions are within the limits of FCC 47 CFR, Part 15, Subpart B for Class A equipment.

Safety compliance

This section lists the safety standards with which the product complies and other safety compliance information.

¹ This product is intended for use in nonresidential areas only. Use in residential areas may cause electromagnetic interference.

² Emissions which exceed the levels required by this standard may occur when this equipment is connected to a test object.

³ Equipment may not meet the immunity requirements of applicable listed standards when test leads and/or test probes are connected.

⁴ For compliance with the EMC standards listed here, high quality shielded interface cables that incorporate low impedance connection between the cable shield and the connector shell should be used.

⁵ 10 mV/division to 1 V/division: ≤ 1.0 division waveform displacement or ≤ 2.0 division increase in peak-to-peak noise is allowed when the instrument is subjected to fields and signals as defined in the IEC 61000-4-3 and IEC 61000-4-6 tests.

EU Low Voltage Directive

Compliance was demonstrated to the following specification as listed in the Official Journal of the European Union:

Low Voltage Directive 2014/35/EU.

- EN 61010-1. Safety Requirements for Electrical Equipment for Measurement, Control, and Laboratory Use – Part 1: General Requirements.
- EN 61010-2-030. Safety Requirements for Electrical Equipment for Measurement, Control, and Laboratory Use – Part 2-030: Particular requirements for testing and measuring circuits.

U.S. nationally recognized testing laboratory listing

- UL 61010-1. Safety Requirements for Electrical Equipment for Measurement, Control, and Laboratory Use – Part 1: General Requirements.
- UL 61010-2-030. Safety Requirements for Electrical Equipment for Measurement, Control, and Laboratory Use – Part 2-030: Particular requirements for testing and measuring circuits.

Canadian certification

- CAN/CSA-C22.2 No. 61010-1. Safety Requirements for Electrical Equipment for Measurement, Control, and Laboratory Use – Part 1: General Requirements.
- CAN/CSA-C22.2 No. 61010-2-030. Safety Requirements for Electrical Equipment for Measurement, Control, and Laboratory Use – Part 2-030: Particular requirements for testing and measuring circuits.

Additional compliances

- IEC 61010-1. Safety Requirements for Electrical Equipment for Measurement, Control, and Laboratory Use – Part 1: General Requirements.
- IEC 61010-2-030. Safety Requirements for Electrical Equipment for Measurement, Control, and Laboratory Use – Part 2-030: Particular requirements for testing and measuring circuits.

Equipment type

Test and measuring equipment.

Safety class

Class 1 – grounded product.

Pollution degree description

A measure of the contaminants that could occur in the environment around and within a product. Typically the internal environment inside a product is considered to be the same as the external. Products should be used only in the environment for which they are rated.

- Pollution Degree 1. No pollution or only dry, nonconductive pollution occurs. Products in this category are generally encapsulated, hermetically sealed, or located in clean rooms.
- Pollution Degree 2. Normally only dry, nonconductive pollution occurs. Occasionally a temporary conductivity that is caused by condensation must be expected. This location is a typical office/home environment. Temporary condensation occurs only when the product is out of service.
- Pollution Degree 3. Conductive pollution, or dry, nonconductive pollution that becomes conductive due to condensation. These are sheltered locations where neither temperature nor humidity is controlled. The area is protected from direct sunshine, rain, or direct wind.
- Pollution Degree 4. Pollution that generates persistent conductivity through conductive dust, rain, or snow. Typical outdoor locations.

Pollution degree

Pollution Degree 2 (as defined in IEC 61010-1). Note: Rated for indoor, dry location use only.

Measurement and overvoltage category descriptions

Measurement terminals on this product may be rated for measuring mains voltages from one or more of the following categories (see specific ratings marked on the product and in the manual).

- Measurement Category II. For measurements performed on circuits directly connected to the low-voltage installation.
- Measurement Category III. For measurements performed in the building installation.
- Measurement Category IV. For measurements performed at the source of low-voltage installation.



Note: Only mains power supply circuits have an overvoltage category rating. Only measurement circuits have a measurement category rating. Other circuits within the product do not have either rating.

Mains overvoltage category rating

Overvoltage Category II (as defined in IEC 61010-1)

Environmental considerations

This section provides information about the environmental impact of the product.

Product end-of-life handling

Observe the following guidelines when recycling an instrument or component:

Equipment recycling

Production of this equipment required the extraction and use of natural resources. The equipment may contain substances that could be harmful to the environment or human health if improperly handled at the product's end of life. To avoid release of such substances into the environment and to reduce the use of natural resources, we encourage you to recycle this product in an appropriate system that will ensure that most of the materials are reused or recycled appropriately.



This symbol indicates that this product complies with the applicable European Union requirements according to Directives 2012/19/EU and 2006/66/EC on waste electrical and electronic equipment (WEEE) and batteries. For information about recycling options, check the Tektronix Web site (www.tek.com/productrecycling).

Battery recycling

This product also contains a small installed lithium metal button cell. Please properly dispose of or recycle the cell at its end of life according to local government regulations.

Perchlorate materials

This product contains one or more type CR lithium batteries. According to the state of California, CR lithium batteries are classified as perchlorate materials and require special handling. See dtsc.ca.gov/perchlorate for additional information.

Transporting batteries

The small lithium primary button cell contained in this equipment does not exceed 1 gram of lithium metal content per cell, and the cell type has been shown by the manufacturer to comply with the applicable requirements of the UN Manual of Tests and Criteria Part III, Sub-section 38.3. Consult your carrier to determine which lithium battery transportation requirements are applicable to your configuration, including to its re-packaging and re-labeling, prior to reshipment of the product by any mode of transport

Preface



Key features

This oscilloscope can help you verify, debug, and characterize electronic designs. Key features include:

- Bandwidth variants 50 MHz, 70 MHz, 100 MHz and 200 MHz.
- 2 channel models
- Large 7 inch WVGA wide-screen color display
- Sample Rates of 1 GS/s on all Channels
- Up to 20K points record length on every channel
- Up to 5,000 waveforms/second capture rate
- Supports 32 automated measurements
- **Edge, Runt and Pulse Width** triggers
- **FFT** analysis for waveform spectrum analysis
- USB 2.0 Host ports for quick and easy storage of screen images, instrument settings, and waveforms to USB flash drives; installing firmware updates; and loading waveforms and settings from saved files
- USB 2.0 Device port for direct PC control of the oscilloscope using TekVISA connectivity, and other remote connectivity tools that support USBTMC
- **Scope Intro** provides a built-in overview of oscilloscope concepts and an introduction to the TBS1000C controls and features
- **HelpEverywhere™** displays graphics and short text descriptions when you access the menus for most oscilloscope settings
- **Courseware** function provides on-oscilloscope teaching instruction, with hundreds of courses available on the Tektronix Education Web page and the ability to easily create courses specific to your education needs

Conventions used in this manual

The following icons are used throughout this manual.

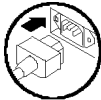
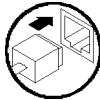
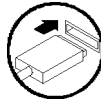
Sequence Step	Front panel power	Connect power	Network	USB
				

Installation

Unpacking the Oscilloscope

Unpack the oscilloscope and check that you received all items listed as standard accessories. The following pages list recommended accessories and probes, oscilloscope options, and upgrades. Check the Tektronix Web site (www.tek.com) for the most current information.

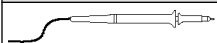
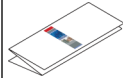
Standard Accessories	
	<p>TPP0100 (TBS1052C, TBS1072C, TBS1102C) 10X Passive Voltage Probe</p> <p>The TPP0100 probes have a system bandwidth of DC to 100 MHz at -3 dB and ship standard with TBS1000C oscilloscope models that have bandwidths up to 100 MHz.</p> <p>TPP0200 (TBS1202C) 10X Passive Voltage Probe</p> <p>The TPP0200 probes have a system bandwidth of DC to 200 MHz at -3 dB and ship standard with TBS1000C models with bandwidths greater than 100 MHz.</p>
	<p>TBS1000C Oscilloscope Compliance and Safety Instructions. (English, Japanese, Russian, Korean, Simplified Chinese, Traditional Chinese) (071-3660-XX) A single printed document is included. Refer to the Optional Accessories for a complete list of available language manuals.</p>
Power cord	Specify plug option
NIM/NIST	Traceable certificate of calibration

Optional Accessories



- P2220.** 1X/10X passive probe, 200 MHz bandwidth.
- P6101B.** 1X passive probe (15 MHz, 300 V_{RMS} CAT II rating).
- P6015A.** 1000X high-voltage passive probe (75 MHz).
- P5100A.** 100X high-voltage passive probe (500 MHz)
- P5200A.** 50 MHz, 50X/500X high-voltage differential probe.
- P6021A.** 15 A, 60 MHz AC current probe
- P6022.** 6 A, 120 MHz AC current probe.
- A621.** 2000 A, 5 to 50 kHz AC current probe
- A622.** 100 A, 100 kHz AC/DC current probe/BNC.
- TCP303/TCPA300.** 150 A, 15 MHz AC/DC current probe/amplifier.
- TCP305A/TCPA300.** 50 A, 50 MHz AC/DC current probe/amplifier.
- TCP312A/TCPA300.** 30 A, 100 MHz AC/DC current probe/amplifier.
- TCP404XL/TCPA400.** 500 A, 2 MHz AC/DC current probe/amplifier
- TPP0050.**
- TPP0100.**
- TPP0200.**

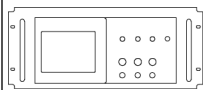

RM2000B Rackmount Kit. The RM2000B Rackmount Kit lets you install a TBS1000B series oscilloscope into an industry-standard 19 inch rack. The rackmount kit requires seven inches (18 cm) of vertical rack space. You can turn the oscilloscope power on or off from the front of the rackmount kit. The rackmount kit does not have slide-out capability.

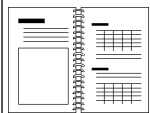

TBS1000C, TDS2000C and TPS2000 Series Digital Oscilloscopes Programmer Manual . The PDF programmer manual (077-0444-XX, English) provides command and syntax information. Download manuals at www.tektronix.com/manuals.

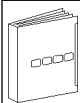

TBS1000C Series Digital Storage Oscilloscope Service Manual. The PDF service manual (077-0897-XX, English) provides module-level repair information. Download manuals at www.tektronix.com/manuals.

Table continued...



Optional Accessories	
	<p>TBS1000C Series Digital Storage Oscilloscope User Manuals. The PDF user manual is available in these languages. Download manuals at www.tektronix.com/manuals.</p> <p>English, 077-1571-XX</p> <p>French, 077-1572-XX</p> <p>Italian, 077-1574-XX</p> <p>German, 077-1573-XX</p> <p>Spanish, 077-1576-XX</p> <p>Japanese, 077-1579-XX</p> <p>Simplified Chinese, 077-1580-XX</p> <p>Traditional Chinese, 077-1581-XX</p> <p>Korean, 077-1577-XX</p> <p>Russian, 077-1582-XX</p>
	<p>TEK-USB-488 Adapter. The GPIB adapter allows you to connect your oscilloscope to a GPIB controller.</p>
	<p>Soft Case. The soft case (AC2100) protects the oscilloscope from damage and provides space for probes, a power cord, and manuals.</p>
	<p>Transit Case. The transit case (HCTEK4321) provides shock, vibration, impact and moisture protection for the oscilloscope when you transport it from one place to another. The required soft case fits inside the transit case.</p>
Options	
	<p>Probe option: TBS1XX2C P2220. Replaces standard probes with P2220 probes (200 MHz passive voltage probes with 1x/ 10x attenuation)</p>
	<p>Service option: Option D1: Calibration Data Report Probes and accessories are not covered by the oscilloscope warranty and Service Offerings. Refer to the datasheet of each probe and accessory model for its unique warranty and calibration terms.</p>

Table continued...

Options

Front-panel overlays. In addition to the default English front panel shipped with your oscilloscope, you can obtain the following overlays:

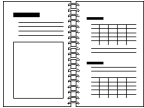
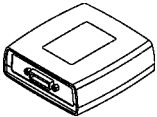
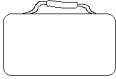
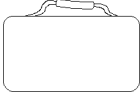
Option L1: French front-panel overlay

Option L2: Italian front-panel overlay

Option L3: German front-panel overlay

Option L4: Spanish front-panel overlay

Option L5: Japanese front-panel overlay

Option L7: Simplified Chinese front-panel overlay

Option L8: Traditional Chinese front-panel overlay

Option L9: Korean front-panel overlay

Option L10: Russian front-panel overlay

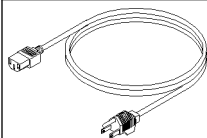

International Power Cords. In addition to the power cord shipped with your oscilloscope, you can obtain the following cords:

Option A0, North American 120 V, 60 Hz, 161-0066-00

Option A1, European 230 V, 50 Hz, 161-0066-09

Option A2, United Kingdom 230 V, 50 Hz, 161-0066-10

Option A3, Australian 240 V, 50 Hz, 161-0066-13

Option A5, Switzerland 230 V, 50 Hz, 161-0154-00

Option A6, Japan 100 V, 50/60 Hz, 161-0342-00

Option A10, China 220 V, 50 Hz, 161-0304-00

Option A11, India 230 V, 50 Hz, 161-0400-00

Operating requirements

Environment requirements

Characteristic	Description
Operating and Non-Operating temperature	Operating: 0°C to +50°C Non-Operating: -30°C to +71°C, with 5°C/minute maximum gradient.
Operating and Non-Operating humidity	Operating: <ul style="list-style-type: none"> 5% to 90% relative humidity (% RH) at up to +30°C 5% to 60% RH above +30°C up to +50°C non-condensing Non- Operating: <ul style="list-style-type: none"> 5% to 90% relative humidity (% RH) at up to +30°C 5% to 60% RH above +30°C up to +60°C non-condensing
Operating and Non-Operating altitude	Operating: Up to 3,000 meters (9,842 feet) Non-Operating: Up to 12,000 meters (39,370 feet)

Power requirements

Characteristic	Description
Power source voltage	100 to 240 V _{AC} RMS ±10%, Single Phase
Power source frequency	50/60 Hz over entire source voltage range 400 Hz (360 Hz to 440 Hz) for 115 V _{AC} (100 V _{AC} - 132 V _{AC}) RMS source voltage range
Power consumption	All models: 80 W maximum



CAUTION: A ground connection through the power cord grounding conductor is essential for safe operation.

TPP0100, TPP0200 series 10X passive probes information

The TPP0100, TPP0200 Series 10X Passive Probes are high impedance, passive probes with 10X attenuation. They are designed for use with TBS1000C oscilloscopes. These oscilloscopes have 14 pF of input capacitance.

The compensation range of these probes is 8 to 18 pF.

The probes have no user- or Tektronix-serviceable parts.

 **Warning:** Do not float the TPP0100, TPP0200 probes on any oscilloscope.

Connecting the probe to the oscilloscope

Connect the probe as shown in the illustrations below.

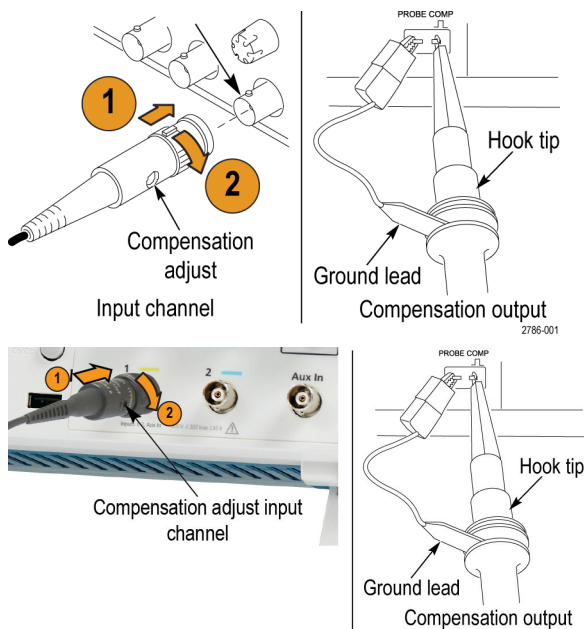

Compensating the probe

Due to variations in oscilloscope input characteristics, the low-frequency compensation of the probe may need adjustment after moving the probe from one oscilloscope channel to another.

If a 1 kHz calibrated square wave displayed at 1 ms/division shows significant differences between the leading and trailing edges, perform the following steps to optimize low-frequency compensation:

1. Connect the probe to the oscilloscope channel that you plan to use for your measurements.
2. Connect the probe to the probe compensation output terminals on the oscilloscope front panel.

 **Warning:** To avoid electric shock, only connect to the Probe Comp signal on the oscilloscope when making this adjustment.

3. Push **Autoset** or otherwise adjust your oscilloscope to display a stable waveform.
4. Adjust the trimmer in the probe until you see a perfectly flat-top square wave on the display. (See illustration.)

 **Warning:** To avoid electric shock, only use the insulated adjustment tool when making compensation adjustments.

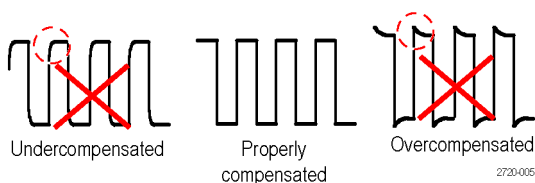

Connecting the probe to the circuit

Use the standard accessories included with the probe to connect to your circuit.



Warning: To avoid electric shock when using the probe or accessories, keep fingers behind the finger guard of the probe body and accessories.

To reduce risk of shock, ensure the ground lead and ground spring are fully mated before connecting the probe to the circuit under test.

Standard accessories

The accessories included with the probe are shown below.



Item	Description
	<p>Color bands</p> <p>Use these bands to identify the oscilloscope channel at the probe head.</p> <p>Reorder Tektronix part number 016-0633-xx (5 pairs)</p>
	<p>Hook tip</p> <p>Press the hook tip onto probe tip and then clamp the hook onto the circuit.</p> <p>Reorder Tektronix part number 013-0362-xx</p>
	<p>Ground lead, with alligator clip</p> <p>Secure the lead to the probe head ground and then to your circuit ground.</p> <p>Reorder Tektronix part number 196-3521-xx</p>
 <p> Do not use on circuits that exceed 30 V_{RMS}</p>	<p>Ground spring</p> <p>The ground spring minimizes aberrations on high-frequency signals caused by the inductance of the ground path, giving you measurements with good signal fidelity.</p> <p>Attach the spring to the ground band on the probe tip. You can bend the spring out to ~0.75 in. away from the signal test point.</p> <p>Reorder Tektronix part number 016-2028-xx (2 ea.)</p>

Table continued...

Item	Description
 2720-015	Adjustment tool Reorder Tektronix part number 003-1433-xx

Optional accessories

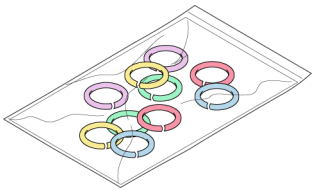
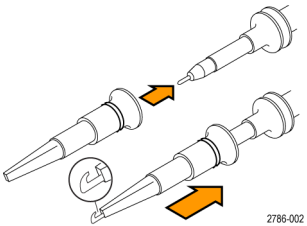
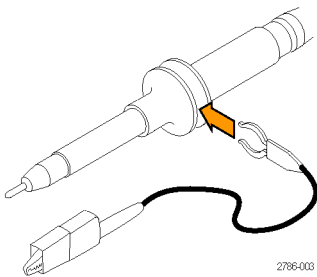
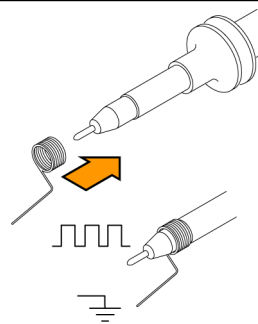
You can order the following accessories for your probe.

Accessory	Part number
Alligator Ground Lead, 12 in	196-3512-xx
6" Clip-on Ground Lead	196-3198-xx
Ground Spring, Short, 2 ea.	016-2034-xx
MicroCKT Test Tip	206-0569-xx
Micro Hook Tip	013-0363-xx
Universal IC Cap	013-0366-xx
Circuit Board Test Point/PCB Adapter	016-2016-xx
Wire, spool, 32 AWG	020-3045-xx

Specifications

Table 1: Electrical and mechanical specifications

Characteristic	TPP0100	TPP0200
Bandwidth (–3 dB)	DC to 100 MHz	DC to 200 MHz
System attenuation accuracy	10:1 \pm 3.2%	10:1 \pm 3.2%
Compensation range	15 pF – 25 pF	15 pF – 25 pF
System input resistance @ DC	10 M Ω \pm 1.5%	10 M Ω \pm 1.5%
System input capacitance	<12 pF	<12 pF
System rise time (typical)	<3.5 ns	<2.3 ns
Propagation delay	~6.1 ns	~6.1 ns
Maximum input voltage	300 V _{RMS} CAT II	300 V _{RMS} CAT II
Cable length	1.3 m	1.3 m

Table 2: Electrical and mechanical specifications

Characteristic	TPP0051	TPP0101	TPP0201
Bandwidth (–3 dB)	DC to 50 MHz	DC to 100 MHz	DC to 200 MHz
System attenuation accuracy	10:1 \pm 3.2%	10:1 \pm 3.2%	10:1 \pm 3.2%
Compensation range	15 pF – 25 pF	15 pF – 25 pF	15 pF – 25 pF
System input resistance @ DC	10 M Ω \pm 1.5%	10 M Ω \pm 1.5%	10 M Ω \pm 1.5%
System input capacitance	<12 pF	<12 pF	<12 pF
System rise time (typical)	<3.5 ns	<3.5 ns	<2.3 ns
Propagation delay	~6.1 ns	~6.1 ns	~6.1 ns
Maximum input voltage	300 V _{RMS} CAT II	300 V _{RMS} CAT II	300 V _{RMS} CAT II
Cable length	1.3 m	1.3 m	1.3 m

Table 3: Environmental specifications

Characteristics	Description
Temperature	
Operating	–10 °C to +55 °C (14 °F to +131 °F)
Nonoperating	–51 °C to +71 °C (–60 °F to +160 °F)
Humidity	
Operating and Non-Operating	5% to 95% relative humidity (%RH) up to +30 °C (86 °F), 5% to 65% RH above +30° C up to +55 °C (131 °F)
Altitude	
Operating	3.0 km (10,000 ft) maximum
Nonoperating	12.2 km (40,000 ft) maximum

Performance graphs

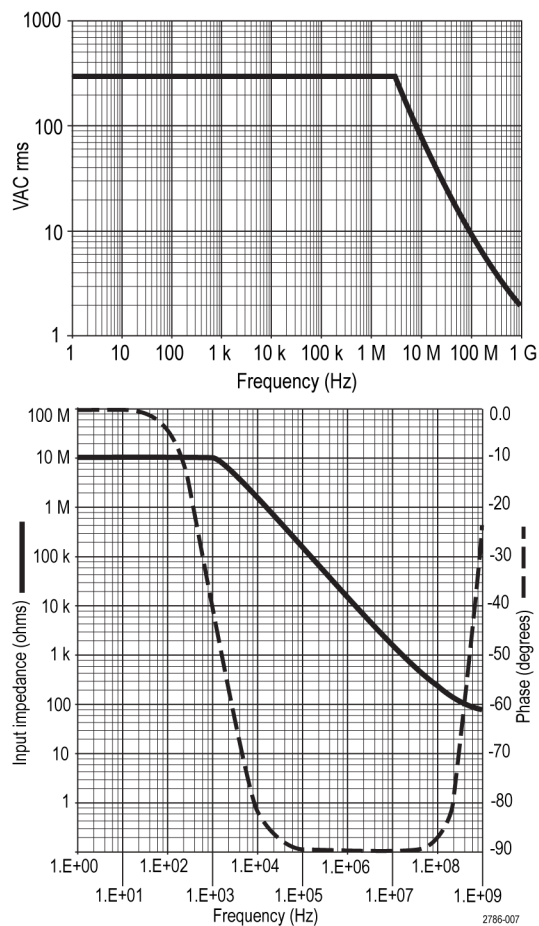

Table 4: Certifications and compliances

Characteristics	Description	
EC Declaration of Conformity	Compliance was demonstrated to the following specification as listed in the Official Journal of the European Communities: Low Voltage Directive 2006/95/EC: EN61010-031: 2002	
Safety Standards	UL61010-031;2007 CAN/CSA C22.2 No. 61010-031-07 IEC61010-031; IEC 61010-031/A1:2008	
Measurement Category Descriptions	<i>Category</i>	<i>Examples of Products in this Category</i>
	CAT III	Distribution-level mains, fixed installation
	CAT II	Local-level mains, appliances, portable equipment
	CAT I	Circuits not directly connected to mains.

Table continued...

Characteristics	Description
Pollution Degree 2	Do not operate in environments where cond– active pollutants may be present (as defined in IEC 61010-1). Rated for indoor use only.



Equipment Recycling. This product complies with the European Union's requirements according to Directive 2002/96/EC on waste electrical and electronic equipment (WEEE). For more information about recycling options, check the Support/Service section of the Tektronix Web site (www.tektronix.com).

Getting acquainted with the oscilloscope

Powering the oscilloscope

Grounding the oscilloscope is necessary for safety and to take accurate measurements. The oscilloscope must share the same ground as any circuits that you are testing. You connect the oscilloscope to ground by plugging the three-pronged power cord into an outlet grounded to earth ground.

To power the oscilloscope on:

1. Connect the power cord supplied with the instrument to the oscilloscope power connector.
2. Connect the power cord to the appropriate AC main source.

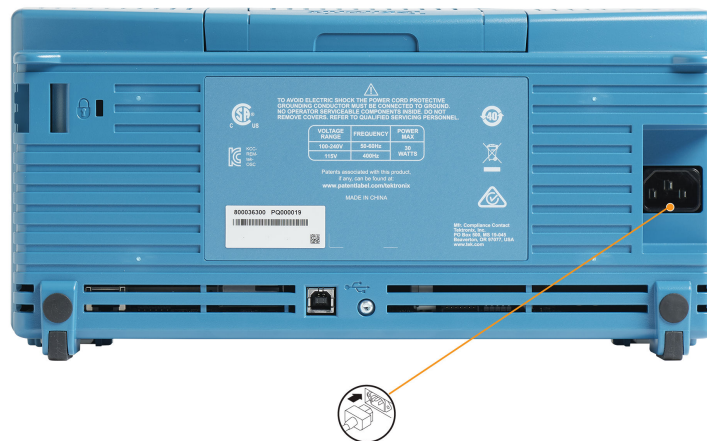

3. Push the **Power** button on the top.

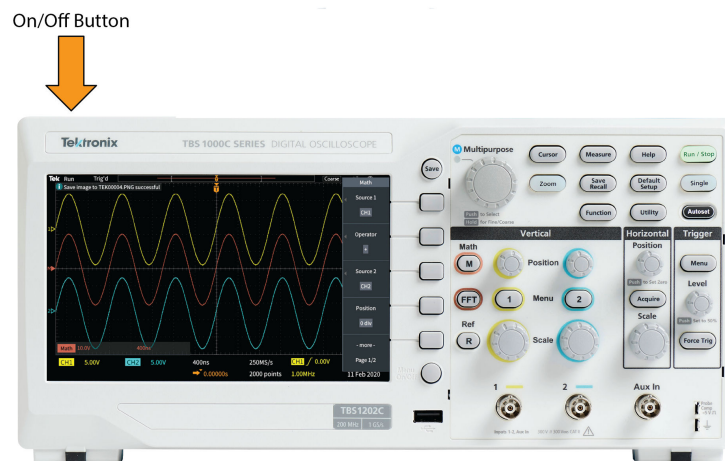

To power off the oscilloscope on: cord :

1. Push the **Power** button on the top.
2. Disconnect the power cord from the main source and the oscilloscope power connector.

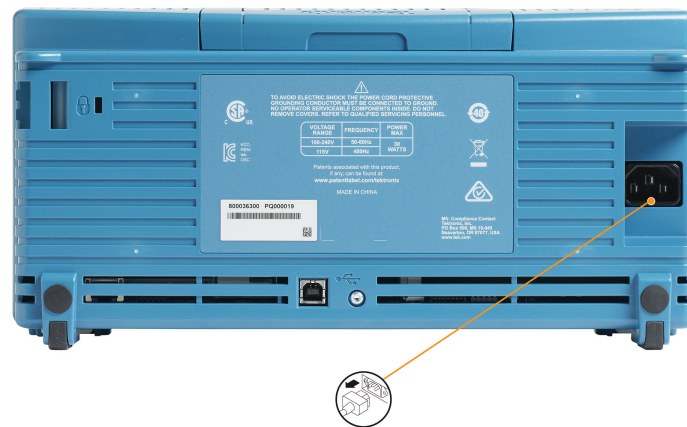

Note: The current instrument settings are stored in nonvolatile memory when you power off the oscilloscope. The oscilloscope restores the settings when you power on.

Changing the user interface language

You can change the language used for the oscilloscope on-screen display, measurements, readouts, and menus to one of 10 languages. The following steps show how to change the user interface language. These steps also introduce you to the oscilloscope menu system.

1. Push the **Utility** front-panel button. The oscilloscope displays a side menu on the right side of the screen.

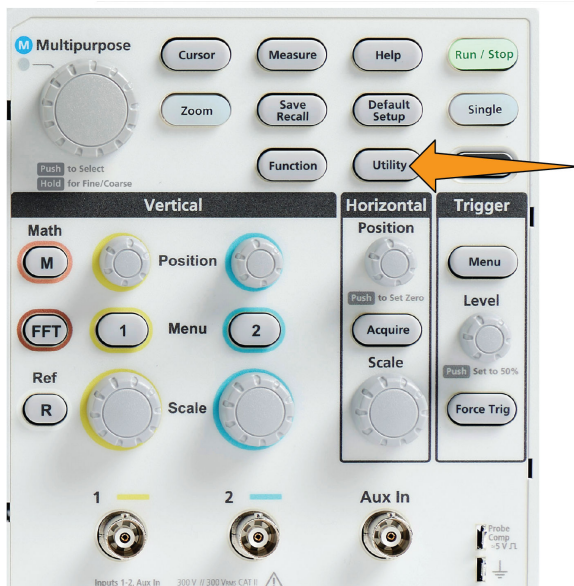

2. Push the **Language** side-menu button.

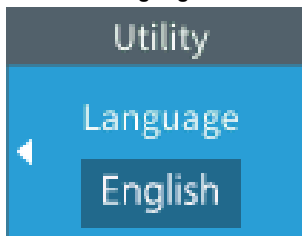

The oscilloscope opens the **Language** menu.

You will use the **Multipurpose** knob to select and click menu items. The following text describes how the **Multipurpose** knob works.



The **Multipurpose** knob lets you interact with on-screen menus, messages, and dialog boxes.

A **M** icon on a menu, message, or dialog box label means that you can use the Multipurpose knob to select and click values in that item.



The knob has two functions:

- **Select** function, where you *turn* the knob to select (highlight) a menu item. Selecting a menu item does not execute (run) that function.



- **Click** function, where you *push* the knob to either run the selected menu item or enable a field in that menu item to enter numbers or select values.



3. Turn the **Multipurpose** knob to select a language.



4. Push the **Multipurpose** knob to select the highlighted language. The selected language takes effect immediately.



5. Push the **Menu On/Off** button to close the **Utility** menu.



6. If you load a language other than English, install the plastic overlay on the front panel to provide labels in that language. Fold the overlay tabs. Push the overlay over the knobs until the knob hole tabs click over the bottom edges of the knobs. Insert the overlay tabs into the small slots.

If you are changing from a non English language to English, remove the front-panel language overlay.

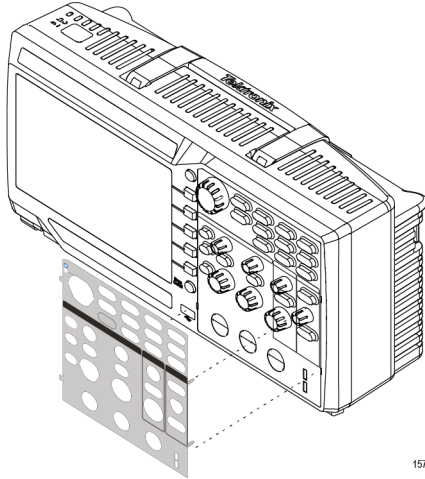

1571-04

Changing the date and time

Set the current date and time so that files that you save are marked with the correct date and time. The date and time are shown in the lower-right corner of the screen. Time is shown using a 24-hour clock.



Note: The clock does not automatically adjust for seasonal time changes. The calendar does adjust for leap years.

The following steps show how to set the oscilloscope clock with the current date and time. These steps also introduce you to more functions of the menu system.

1. Push **Utility** front-panel button.

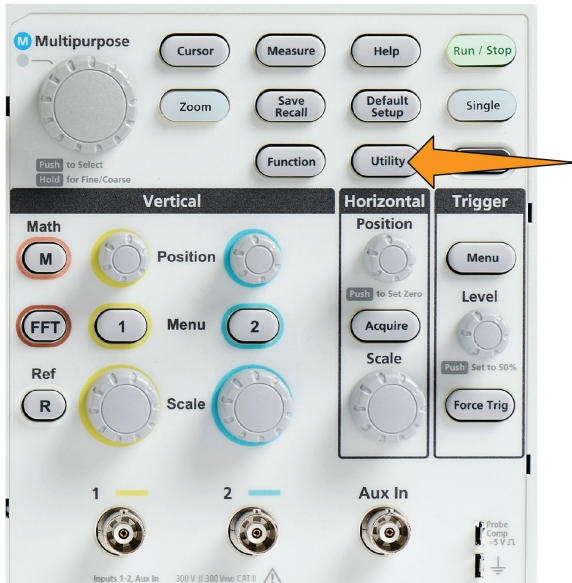

2. Push **-More- Page 1/2** side-menu button.
3. Push **Display & Date** side-menu button. Turn the **Multipurpose** knob to select **Display Date & Time** option. The oscilloscope shows the **Set Date & Time** menu.

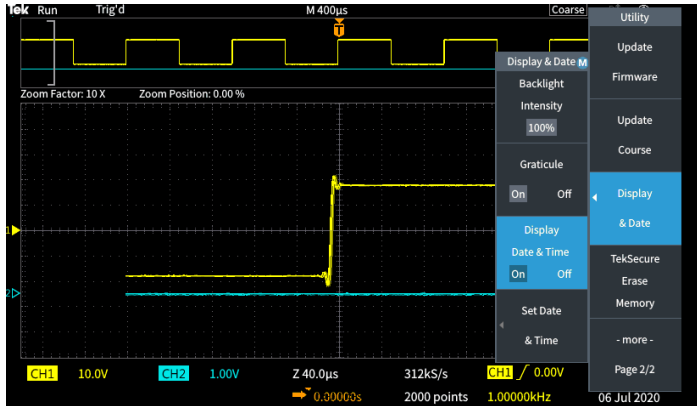

4. Turn the **Multipurpose** knob to select the **Year** field.

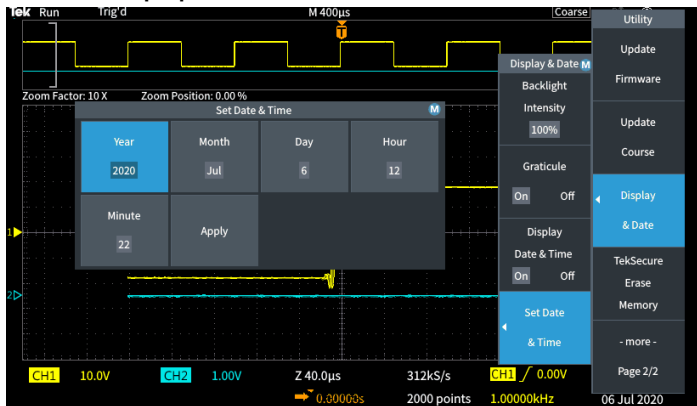

5. Click the **Multipurpose** knob to enable setting the year value. A white box is drawn around the number field, indicating that you can use the **Multipurpose** knob to change that value.

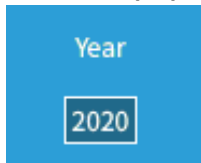

6. Turn the **Multipurpose** knob to change the year value in the field.

When the value is correct, click the **Multipurpose** knob. This enters the number and returns the knob to menu select mode.

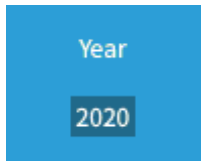

7. Repeat steps 2 - 5. to select and change the remaining date and time settings (**Month, Day, Hour, Minute**).

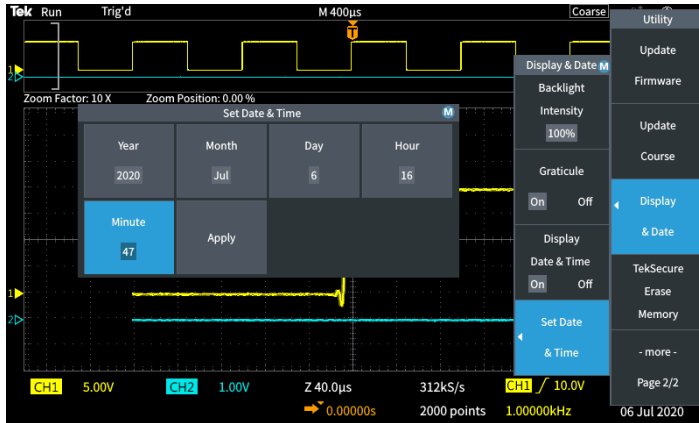

8. When you have finished making all date and time changes, turn the **Multipurpose** knob to select **Apply**, then click the knob to enter the date/time settings into the oscilloscope.

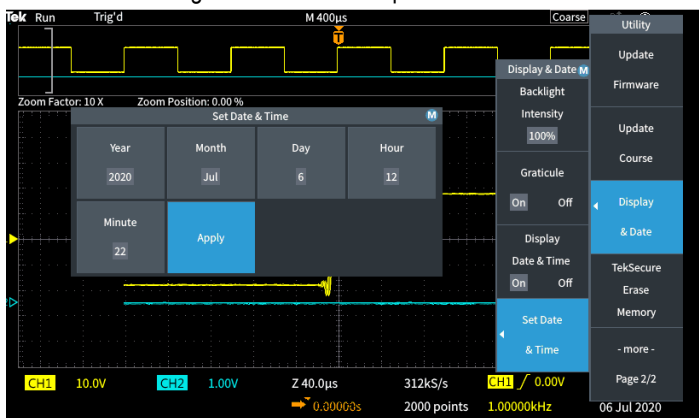

9. To turn off displaying the date and time, select **Display Date & Time** and click the **Multipurpose** knob to toggle **On** or **Off**.

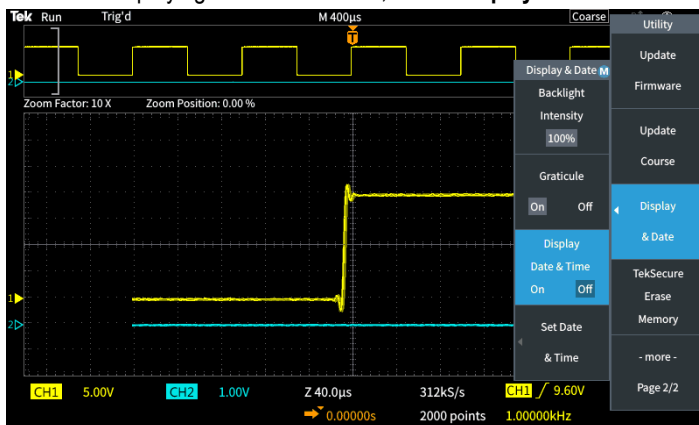

10. Push the **Menu On/Off** button to close the **Utility** side menu.
The new date and time are shown in the lower-right corner of the screen.

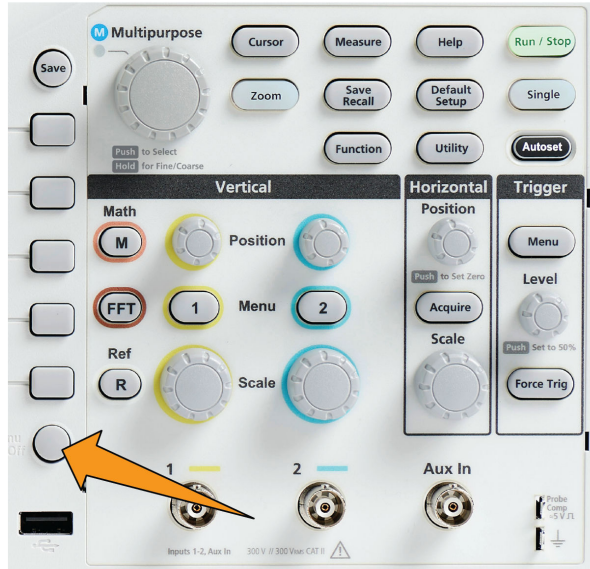

Supported probe types

For more information on the many probes available for use with TBS1000C Series oscilloscopes, visit the Oscilloscope Probe and Accessory Selector tool on the Tektronix Web site (www.tek.com).

Reducing electrostatic damage while taking measurements

Static electricity that builds up on your body can damage static-sensitive components. If you are working with static-sensitive components, ground yourself when using probes. Wearing a grounding strap safely sends static charges on your body to earth ground. Connect the grounding strap to the oscilloscope ground, or to the same ground circuit that the oscilloscope is connected to.

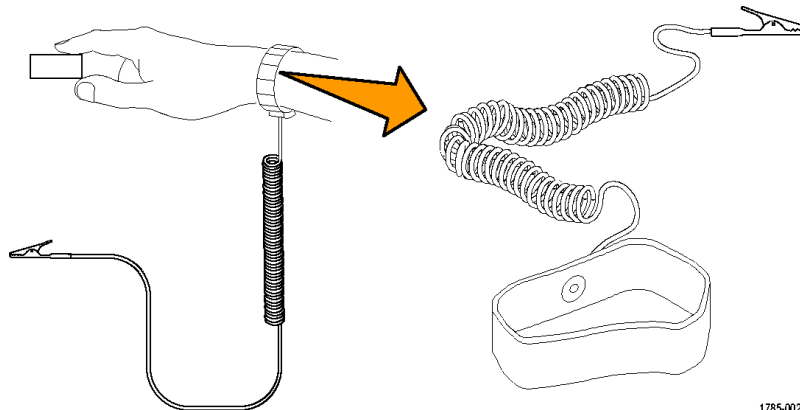

1785-002

Doing a functional check

Perform this quick functional check to verify that your oscilloscope is operating correctly.

Connect the oscilloscope power cable as described in *Powering On the Oscilloscope*. See [Powering the oscilloscope](#) on page 34.

Table continued...

Power on the oscilloscope.

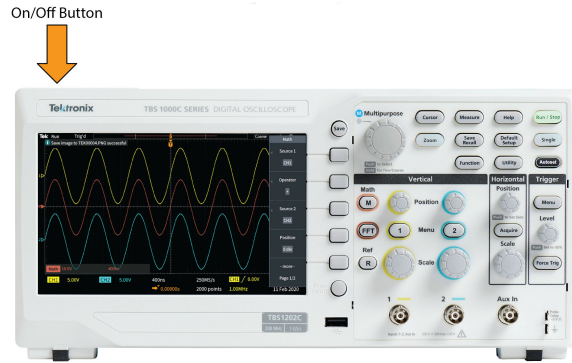

Connect a probe to channel 1.

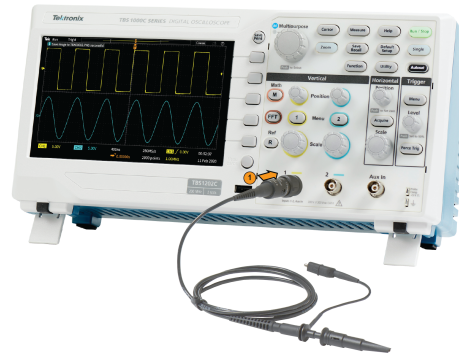

Connect the probe tip and ground lead to the **PROBE COMP** connectors on the oscilloscope front panel. The probe tip connects to the 5 V connector, and the ground clip connects to the ground connector.



Push **Default Setup**. Default Setup returns the oscilloscope settings to factory default values. See [The default oscilloscope settings Default Setup](#) on page 138.

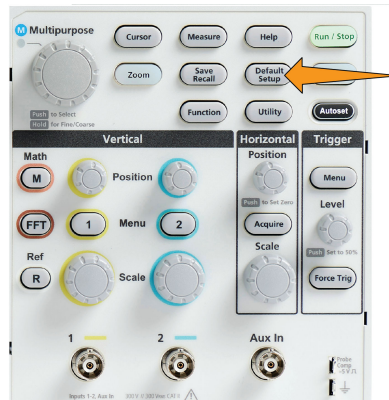
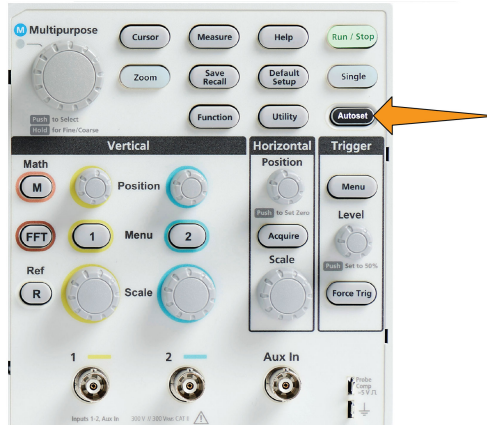

Table continued...

Push **Autoset**.



The screen displays a square wave.



If the displayed square wave tops are not flat, perform the procedures to compensate the probe high frequency response. You can compensate the probe after completing this functional check.

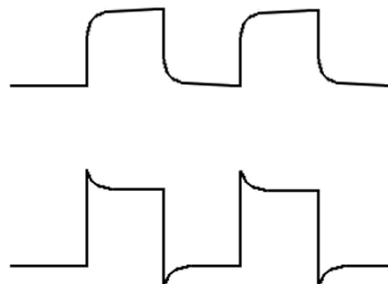

Push **Measure** to open the **Measurement Selection** menu.

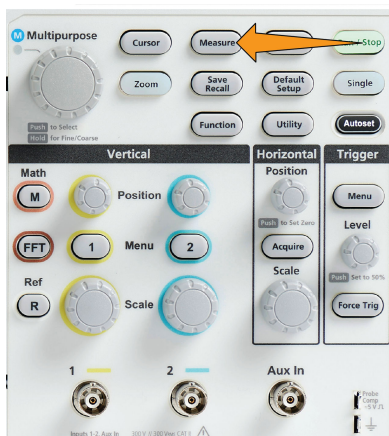
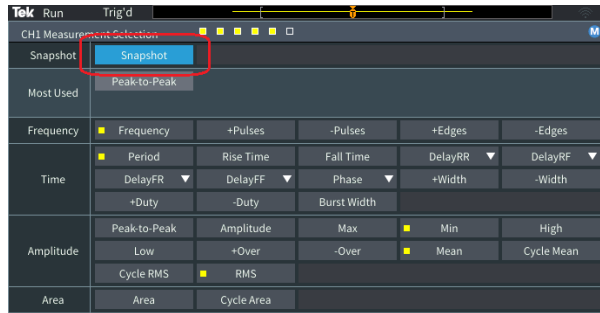

Table continued...

Turn the **Multipurpose** knob to select **Snapshot**.



Click the **Multipurpose** knob to show the **Snapshot** screen. See [Taking a measurement snapshot](#) on page 81.

Verify that the **Frequency** value is ~1 kHz and the **Period** value is ~1 ms, respectively.

Snapshot On Ch1		
Frequency	Frequency	998.5Hz
	-Pulses	5
	-Edges	6
Time	Period	1.001ms
	Fall Time	2.611μs
	-Width	502.3μs
	-Duty	50.16%

Push the **Menu On/Off** button to close the **Snapshot** screen. Push the **Menu On/Off** button again to close the **Measurement** screen.

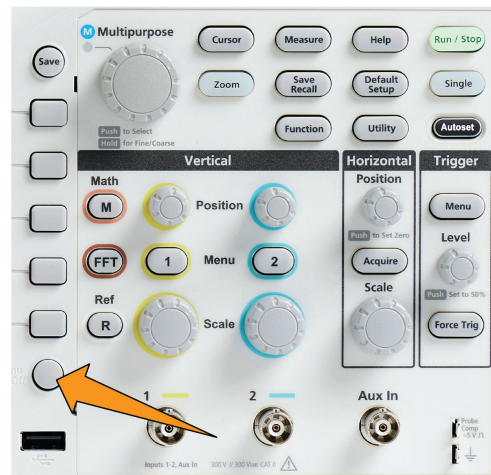

What is Autoset

The functional check used the **Autoset** button to display a stable waveform. **Autoset** automatically adjusts the oscilloscope acquisition, horizontal, trigger, and vertical controls to display five or six waveform cycles for an active (displayed) channel. This powerful function can save you time when you need to view an unknown signal. See the [Autoset](#) topic for more information. See [Using Autoset](#) on page 67.

Probes and ground leads tip

When taking a real measurement, use the shortest possible ground lead and signal path to minimize probe-induced ringing and distortion on the measured signal.



Signal with a short length ground lead

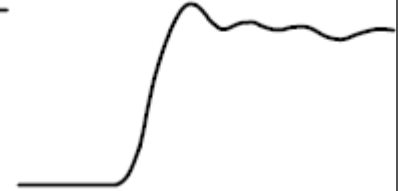

Signal with a long ground lead

Getting on-screen help for settings HelpEverywhere™

HelpEverywhere™ is a mode that displays graphics and short text descriptions when you access the menus for most oscilloscope settings. This is very useful for when you are first learning the functions of oscilloscope controls.

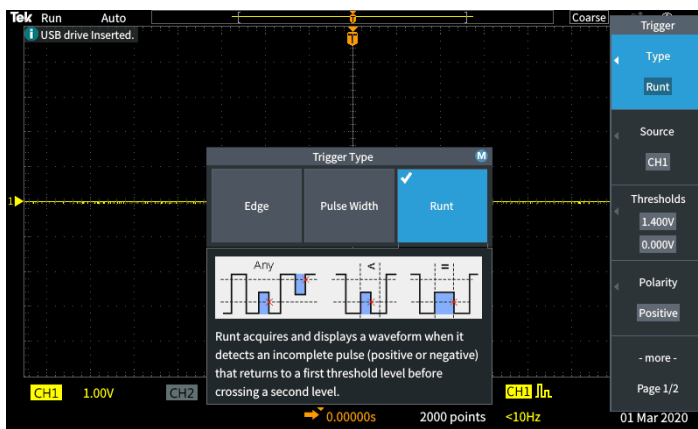

You can enable **HelpEverywhere™** content for all supported settings, or enable it for specific function groups, such as **Trigger** controls, **Vertical** controls, and so on.

1. Push the **Help** front-panel button.
2. Push the **HelpEverywhere™** side-menu button to display the menu. All **HelpEverywhere™** content is set to **Off** by default except for the **Measurement** category, which is **On**.

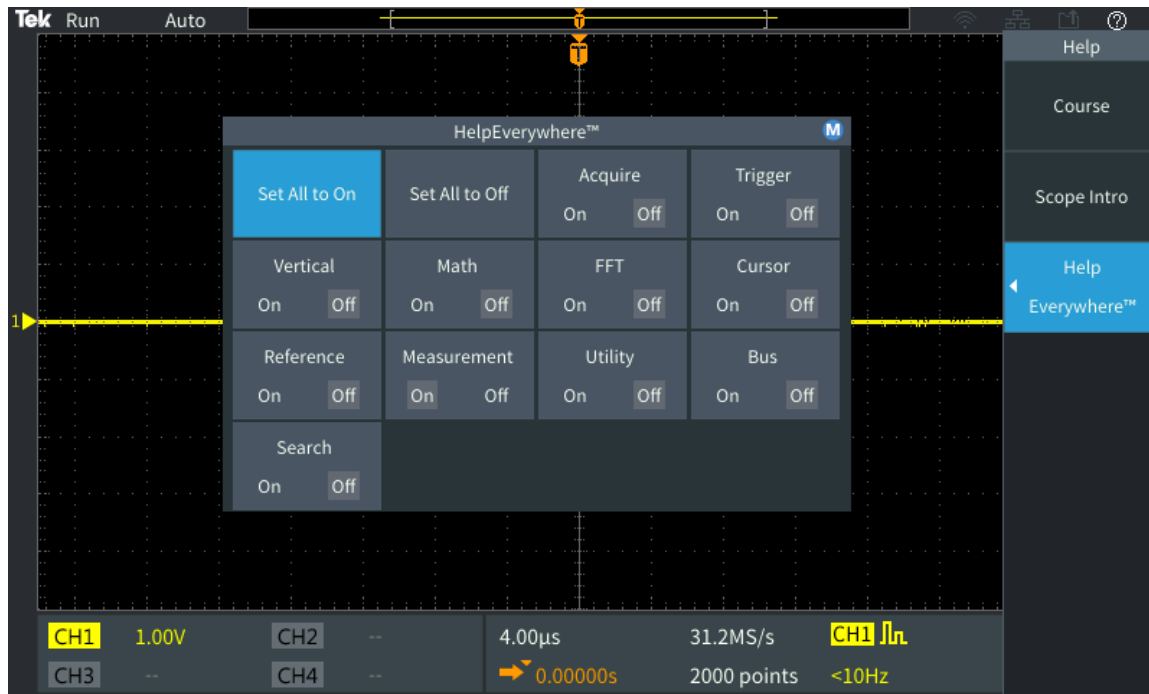

- To turn all **HelpEverywhere™** content on or off, use the **Multipurpose** knob to select **Set All to On** or **Set All to Off**, then click the knob.

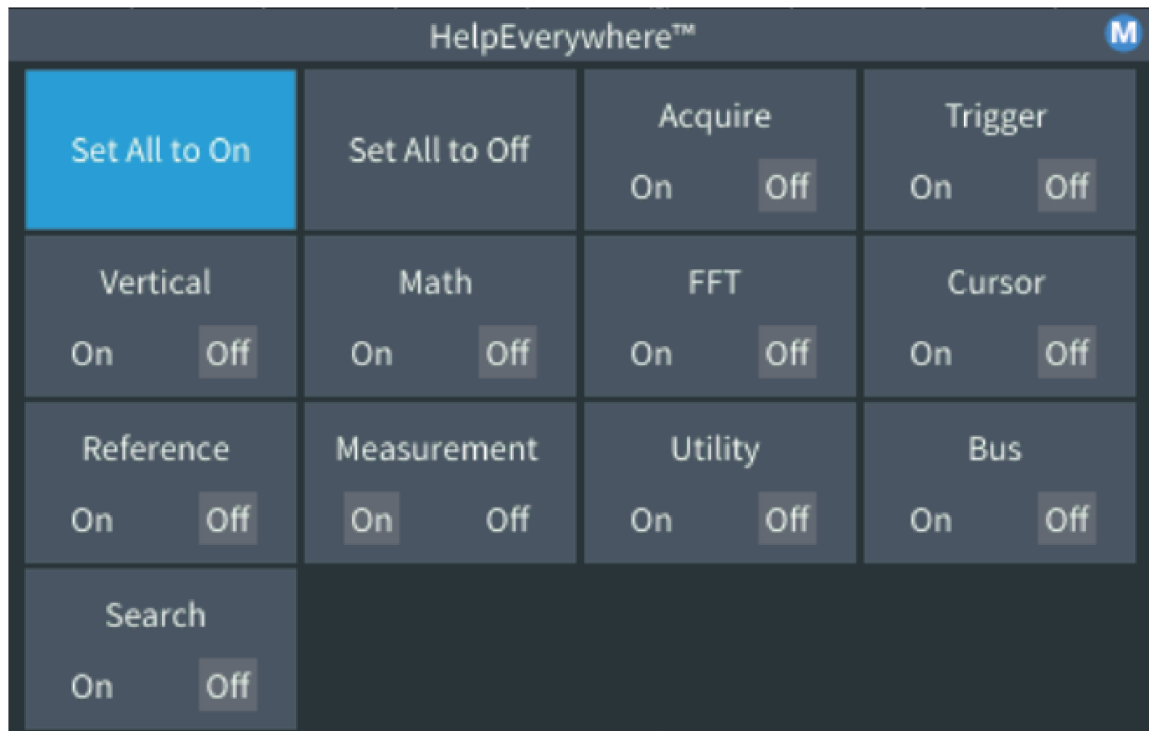

- To set individual menu categories to show **HelpEverywhere™**, use the **Multipurpose** knob to select a category, then click the knob to toggle that selection **On** or **Off**.

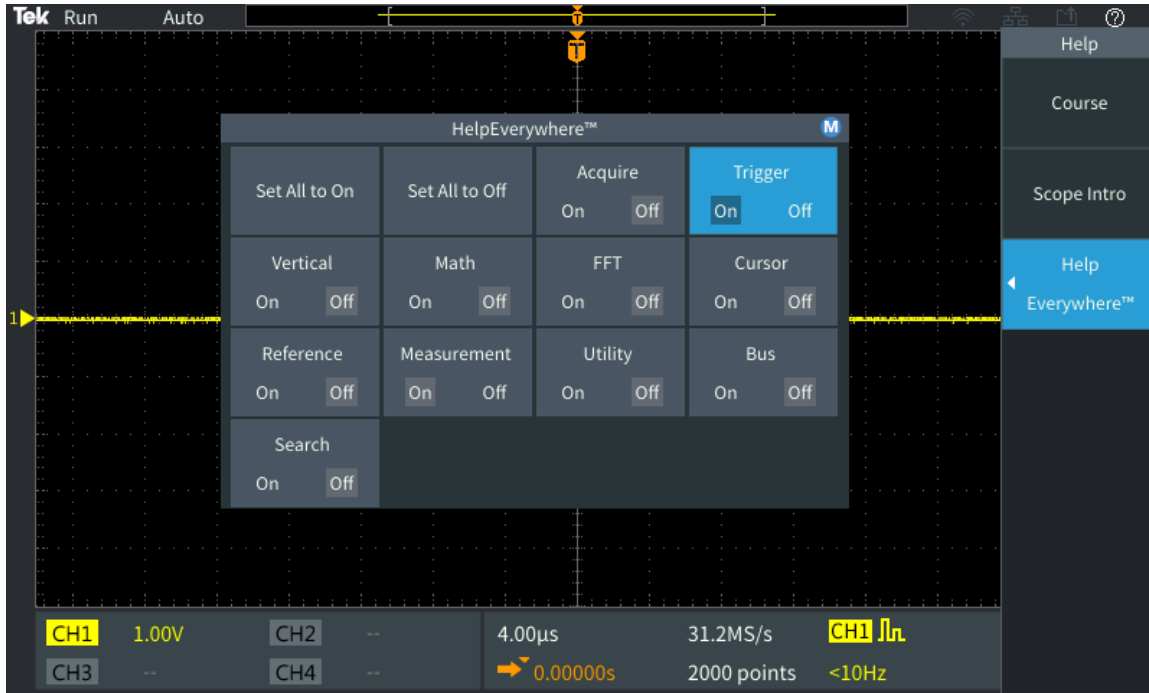

The next time you access a **HelpEverywhere™** supported menu setting, the oscilloscope displays the help for that item.



Note: You may need to turn the **Multipurpose** knob and select another menu item to show the **HelpEverywhere™** content.

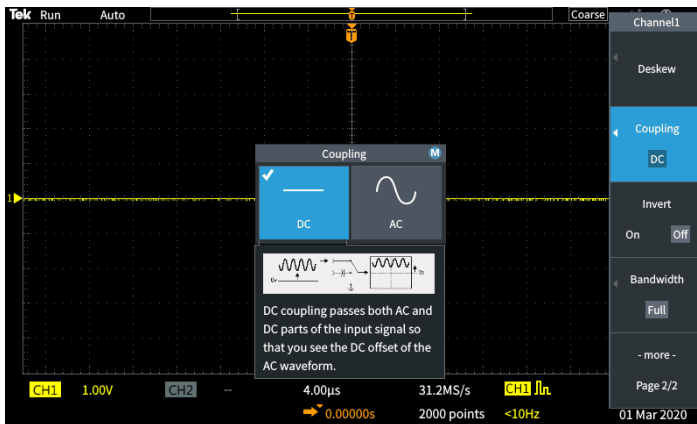

When any **HelpEverywhere™** content is enabled, the **HelpEverywhere™** icon is highlighted (in upper right corner of screen). 

Signal path compensation SPC

Signal Path Compensation (SPC) corrects for DC level inaccuracies in the internal signal path caused by temperature variations and/or long-term signal path drift. You should run the SPC whenever the ambient (room) temperature has changed by more than 10 °C, or once a week if you use vertical scale settings of 5 mV per division or less. Failure to run a SPC may result in the oscilloscope not meeting warranted performance levels at those volts per division settings.

To compensate the signal path for all channels:

1. Power on and warm up the oscilloscope for at least 20 minutes.

2. **IMPORTANT:** Remove all input signals (probes and cables) from channel inputs and the **Aux In** connector on the front of the oscilloscope.
3. Push **Utility**.

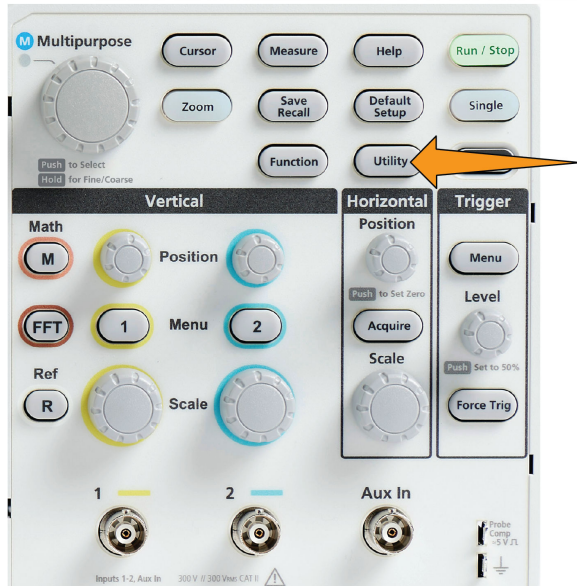

4. Push the **Calibration & Diagnostic** side-menu button.
5. Turn the **Multipurpose** knob to select **Signal Path**, then click the **Multipurpose** knob to start the SPC process.
The oscilloscope shows a Signal Path Compensation information message.
6. Push the **Compensate Signal Paths** side-menu button to start the process.
The screen shows rotating dots while the SPC is run. The oscilloscope displays a message when the SPC is complete. SPC can take several minutes to run, so wait until the oscilloscope shows a message that SPC is completed.
7. Push **Menu Off** to remove the message and menus.
8. Reconnect probes to the oscilloscope.

The Scope Intro function

The **Scope Intro** function provides a brief history of oscilloscopes, some basic oscilloscope concepts, and an overview of the oscilloscope features and controls.

You can view any topic in any order.

1. Push the **Help** front-panel button.

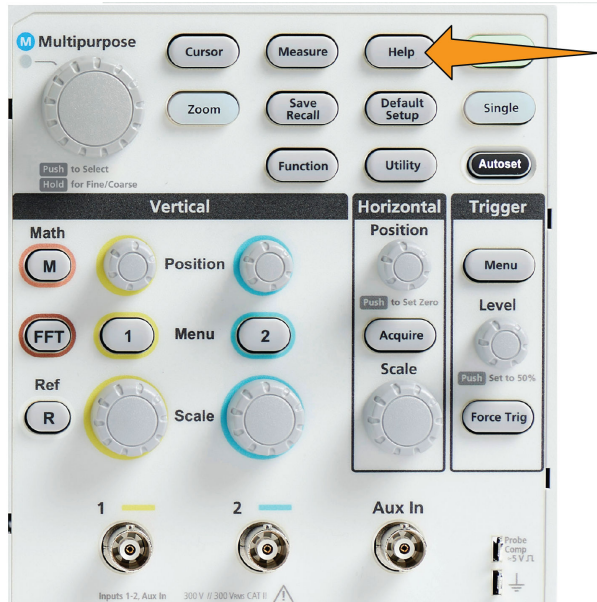

2. Push the **Scope Intro** side-menu button.
3. Use the **Multipurpose** knob to select and click a topic heading.
4. Use the **Multipurpose** knob to select and click a topic to read.
5. Push the relevant side-menu button to return to the menu for the subject category, and select and click the next topic to view.
6. When you are done viewing the topics for that category, push the **Scope Intro** side-menu button to return to the main menu, and select a new category to read.
7. Push the **Menu On/Off** button to close the **Scope Intro** mode.



Note: The **Scope Intro** function does not remember which topics you have read.

Sampling oscilloscope concepts

Sampling and acquisition concepts

Before the oscilloscope can display or measure a signal, it must be sampled. **Sampling** is the process of measuring the input signal amplitude value at regular intervals (called the sampling rate, in samples per second), converting the sampled levels into digital data, and storing the sampled values in memory to create a **waveform record**. The oscilloscope uses the digitized values in the waveform record to create, display, and measure waveforms. Each oscilloscope channel has its own waveform record memory storage.

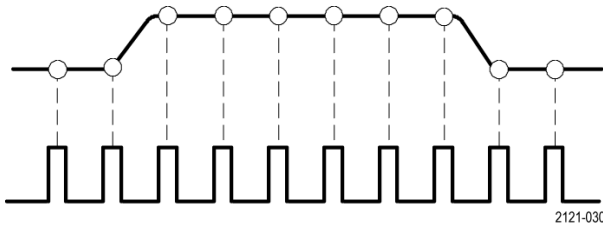

TBS1000C Series oscilloscopes use real-time sampling. In real-time sampling, the oscilloscope samples and digitizes all of the sampled points at one time, in sequence, stores the sampled data in memory, and then repeats the sampling and storage process.

Use the **Horizontal Scale** knob to change the sample rate (samples per second). The oscilloscope automatically sets the sample rate so that there are more than enough samples to accurately capture the signal information. The sample rate is shown on the screen at all times in the horizontal position/scale readout.



Note:

- The maximum sample rate of 1 GS/s is available on both channels, when both channels are active.

You can set the waveform **record length** (number of sample points in the waveform record) from 1000 points to 20k points. A longer (larger) waveform record is useful to capture several waveform cycles to search for a waveform of interest, or to capture a great deal of detail for just a few waveform cycles and then use the **Zoom** function to search the waveform for areas of interest.

Each time the oscilloscope fills the waveform record is called a **waveform acquisition**, or **acquisition** for short. Each acquisition stores new sample data into the same waveform record for that channel.

A waveform record is further divided into **acquisition intervals**, which are equally sized groups of samples. Acquisition intervals let the oscilloscope perform calculations to analyze and display data such as the minimum and maximum data values per interval, or the average signal value per interval. How the values in the acquisition interval are used is set by the acquisition mode.

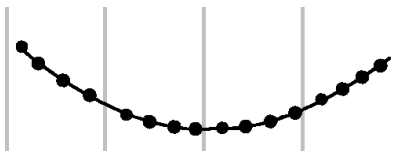

Acquisition mode concepts

The **acquisition mode** sets how the oscilloscope uses the sampled data points in each acquisition interval to create and display a waveform. You can set the acquisition mode to one of the following modes.

Sample mode retains and uses the first sampled point from each acquisition interval to create the displayed waveform. This is the default mode.

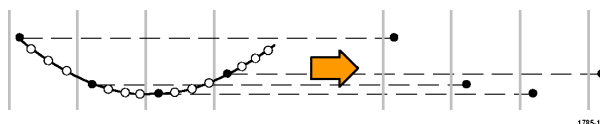

Peak Detect mode uses the highest and lowest of all the samples contained in two consecutive acquisition intervals. Use this mode to help detect short rapid transitions in a waveform. Peak Detect is not available at faster time per division settings.

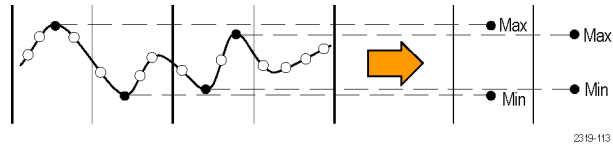

Hi Res mode oversamples lower-frequency signals and calculates the average of all the samples for each acquisition interval. Use Hi Res mode to provide higher-resolution (16-bit) sample points for lower-frequency waveforms.

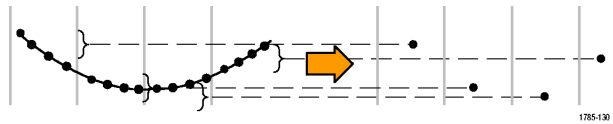

Average mode calculates and displays the average value for each sample point over a user-specified number of acquisitions. Use Average mode to reduce random noise.



Trigger concepts

The oscilloscope uses the data in the waveform record to construct and display a waveform on the oscilloscope screen. However, as the oscilloscope is constantly acquiring samples into the waveform record, each waveform record starts at a random point of the input signal. This means that the waveform record sample values are constantly changing, which results in a displayed waveform that is unstable or jittering. An unstable waveform cannot be accurately measured, making this display useless except for very broad measurements (type of signal, approximate peak to peak signal amplitude).

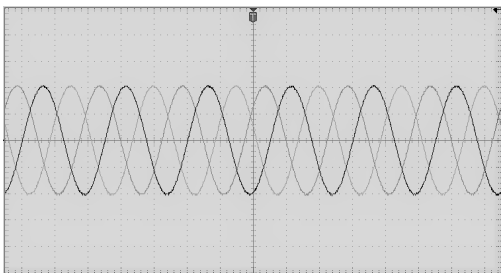

Figure 1: Untriggered display

What is needed is a way to set the oscilloscope to detect, or trigger on, the same signal condition or state on the input signal for each waveform acquisition, and store the samples in the waveform record such that the same signal condition is at the same sample time location in the waveform record.

A **trigger** sets when the oscilloscope detects a defined waveform condition, such as at a specified signal voltage level on the rising edge of the signal. The oscilloscope uses that trigger condition to store the waveform samples in the waveform record so that the signal sample point that meets the trigger condition is at the same location in the waveform record. When displayed, the waveform record for each acquisition shows the waveform at the same trigger point, resulting in a stable waveform on the screen.

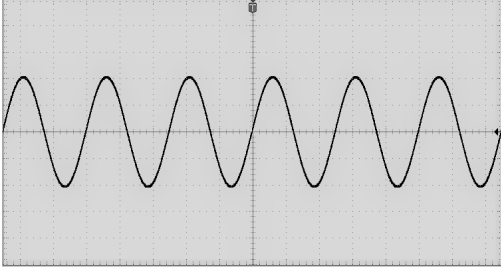

Figure 2: Triggered display

Understanding and using triggers is probably the most important skill needed to quickly display and analyze waveforms. A trigger condition can be as simple as when the signal passes through a specified voltage level when going from a low level to a high level (positive slope). A trigger condition can also be very specific, such as when the signal level is falling and the width of a single pulse of the signal is less than a specified time period.

The trigger point in a waveform record also sets the zero time-reference point in a waveform record. By default, the trigger point in a waveform record is in the center of the waveform record. This means that half of the record shows the signal waveform before the trigger condition (pretrigger), and the other half shows the waveform after the trigger condition (post-trigger).

Pretrigger data can help you troubleshoot signal problems. For example, to find the cause of an unwanted glitch in your test circuit, trigger on the glitch signal and look at the pretrigger waveform. By analyzing what happens before the glitch, you may uncover information that helps you find the source of the glitch.

Trigger slope and level concepts

The oscilloscope must detect both the slope and level conditions before it can trigger and display a stable waveform.

The minimum trigger conditions needed to display a stable waveform are the signal slope and threshold level. The slope sets the oscilloscope to find the trigger point on the rising or the falling edge of a signal. The level sets where on that edge the trigger point occurs.

The trigger Slope sets the oscilloscope to find the trigger event on the rising or the falling edge of a signal.

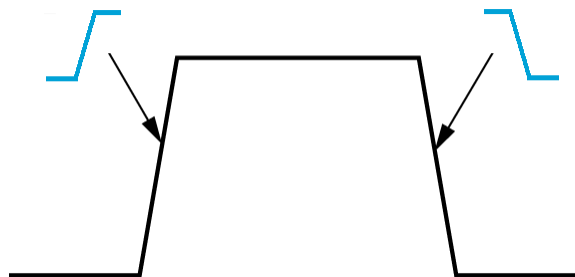

The trigger threshold Level (or just level) is the signal amplitude value on a slope that must occur for the oscilloscope to trigger on a signal.

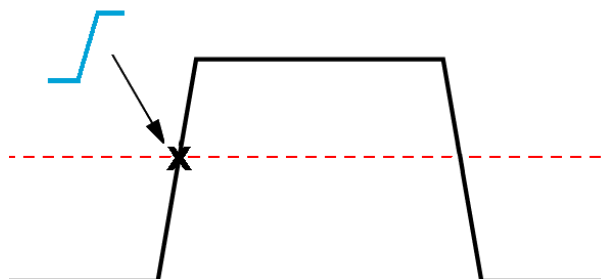

A runt trigger needs two thresholds to define the two levels that a signal must pass through to be considered a valid (nonrunt) signal.

The arrow at the far right of the screen marks the threshold level(s) for that signal.

Turning the Trigger Level knob changes the threshold level and momentarily displays a long horizontal line (or two lines for a runt trigger) across the waveform to show the trigger level(s) in relation to the overall waveform.

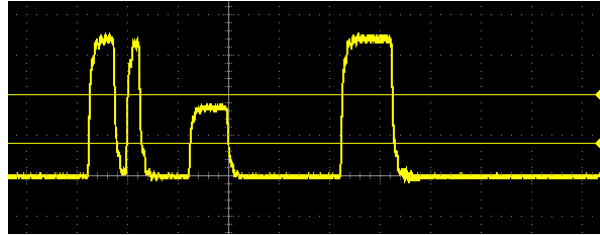

Available trigger types

The oscilloscope lets you trigger on several signal conditions:

Trigger type	Trigger conditions
<p>Edge</p>	<p>Edge triggers are the simplest and most commonly used trigger type. An edge trigger event occurs when the trigger source passes through a specified voltage threshold (trigger level) when the signal is transitioning in the specified slope (rising or falling).</p> <p>You can trigger on a rising or falling edge, as defined by the slope control.</p>
<p>Pulse Width</p>	<p>You can trigger on pulses that are less than, greater than, equal to, or not equal to a specified time period. You can trigger on positive or negative pulses.</p> <p>Pulse width triggers are primarily used to analyze digital signals.</p>
<p>Runt</p>	<p>A runt pulse is a pulse that crosses one threshold but fails to cross a second threshold before recrossing the first. Therefore, a runt trigger needs two thresholds to define the two levels that a signal must pass through to be considered a valid (nonrunt) signal.</p> <p>You can trigger on any positive or negative (or either) runt signal. You can also trigger on runt signals with pulse widths that are less than, greater than, equal to, or not equal to a specified width.</p> <p>Runt triggers are primarily used to analyze digital signals.</p>

Trigger coupling

Trigger coupling sets what part of the input signal is used by the trigger circuit. Trigger coupling choices are **DC**, **LF Reject**, **HF Reject**, and **Noise Reject**.

- **DC Coupling** passes the trigger signal to the trigger circuit with no filtering. The scope may trigger on false events if the signal is noisy.
- **HF Reject** attenuates signals above 85 kHz from the trigger circuit. This reduces false triggering on high-frequency noise when measuring lower-frequency signals.
- **LF Reject** attenuates signals below 65 kHz from the trigger circuit. This reduces false triggering from low frequency noise when measuring higher-frequency signals.
- **Noise Reject** reduces the trigger circuit input sensitivity. This reduces false triggering when measuring signals with higher levels of noise.

Trigger modes

The Trigger **Mode** sets how the oscilloscope behaves in the absence or presence of a trigger. Trigger mode also enables the trigger holdoff function.

Auto Untriggered Roll trigger mode

The **Auto (Untriggered Roll)** mode sets the oscilloscope to acquire a waveform even if a trigger does not occur. Auto mode uses a timer that starts when the acquisition is started, and the pretrigger information is obtained. If a trigger event is not detected before the timer times out, the oscilloscope forces a trigger. The length of time it waits for a trigger event depends on the time base setting (**Horizontal Scale**).

Auto mode, when forcing triggers in the absence of valid triggering events, does not synchronize the waveform on the display. The waveform will appear to roll across the screen. If valid triggers occur, the display will become stable.

Normal trigger mode

Normal mode sets the oscilloscope to acquire a waveform only when a trigger condition occurs. If no trigger occurs, the last waveform record acquired remains on the display. If no last waveform exists, no waveform is displayed.

Holdoff trigger mode

The **Holdoff** trigger mode lets you set a time period during which the oscilloscope ignores trigger events. For example, to trigger on the first pulse of a pulse burst, you would set the trigger conditions to trigger on a positive edge, and set the holdoff value so that the trigger is disabled for a period of time after the trigger event but before the next burst occurs. Using Holdoff in this case prevents the oscilloscope from triggering on any positive signal edge.

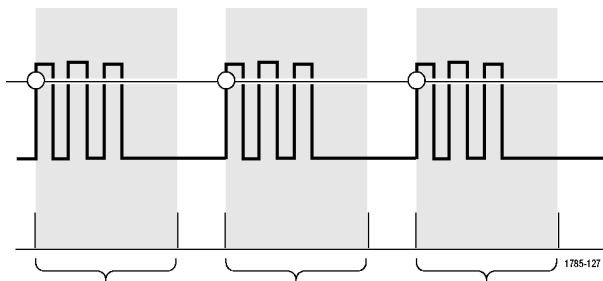

Use **Set Holdoff to minimum** to set the holdoff value to the minimum value.



Note: The trigger mode does not set the trigger conditions; those are set with the trigger **Type** controls. See [Available trigger types](#) on page 53.

Trigger delay acquisition mode

In normal acquisition modes, the trigger point is located at the center of the waveform record, and is positioned at the center-screen expansion point so that horizontal scale changes are centered around the trigger point. The **Delay** function in the **Acquire** menu disconnects the trigger point from the center-screen expansion point. This feature lets you use the **Horizontal Position** knob to reposition (delay) the trigger point from the expansion point by a specified amount.

The most common use for **Delay** is to acquire and display waveform detail that is separated after the trigger event by a significant interval of time. For example, you can trigger on a pulse that occurs once every 10 ms and then use **Delay** to look at the signal characteristics that occur 6 ms after the trigger point.

Setting channel input parameters

Use the **Vertical Menu** buttons to select the waveform to be displayed or open the menu options used to set the input parameters for each channel. Setting for each channel are independent of the other channel.

Setting input signal coupling

Input signal coupling sets how the input signal is passed to the oscilloscope sampling circuit.

1. Push the **Vertical Menu** button for the channel input that you want to set.

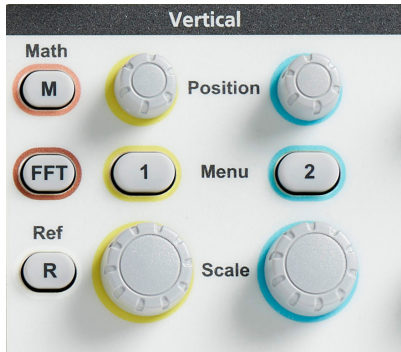

2. Push **-More- Page 1/2** side-menu button.
3. Push the **Coupling** side-menu button.
4. Use the **Multipurpose** knob to select and click the coupling type:
 - DC coupling passes both AC and DC signal components.
 - AC coupling blocks the DC component and passes only the AC signal.

Inverting the input signal

Use this procedure to invert (flip vertically) the signal. A typical reason to invert a signal is to use the inverted signal to create a math waveform.

1. Push the **Vertical Menu** button for the channel input that you want to set.

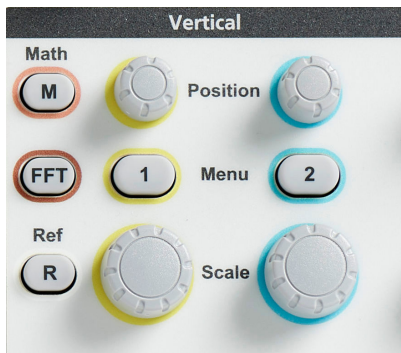

2. Push **-More- Page 1/2** side-menu button.
3. Push the **Invert** side-menu button to toggle between **Off** for normal operation and **On** to invert the polarity of the signal in the preamplifier.

Setting the oscilloscope bandwidth

Use this procedure to set the oscilloscope bandwidth. Bandwidth is the maximum frequency that an oscilloscope can accurately display and measure. The oscilloscope gradually attenuates (reduces) the signal level of frequencies that are higher than the bandwidth. This means that although you can display signals that are above the bandwidth limit, their amplitude values and other characteristics are not guaranteed to be accurate.

1. Push the **Vertical Menu** button for the channel input that you want to set.

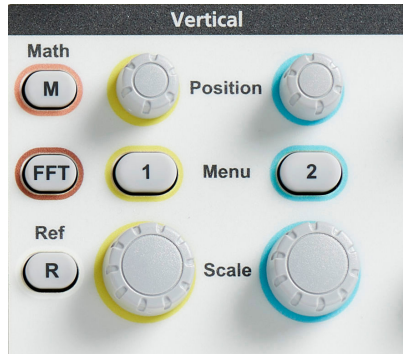

2. Push **-More- Page 1/2** side-menu button.
3. Push the **Bandwidth** side-menu button.
4. Use the **Multipurpose** knob to select and click the bandwidth setting.
 - **Full** sets the bandwidth to the maximum bandwidth of which the oscilloscope is capable.
 - **20 MHz** sets the bandwidth to 20 MHz.

Setting the probe type voltage or current

The **Probe Type** submenu sets the type for probe that is connected to the oscilloscope. The default probe type is **Voltage**. The other valid probe type is current.

Push the **Vertical Menu** button for the channel input that you want to set.

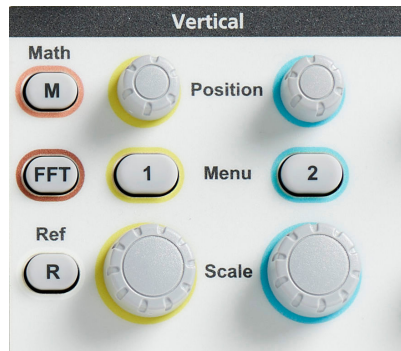

Push the **Probe Setup** side menu to display the **Probe Setup** submenu.

Use the **Multipurpose** knob to select and click **Probe Type** submenu item.

Select and click the probe type (**Voltage** or **Current**).

Setting the probe attenuation factor

Attenuation is the amount that the probe reduces or amplifies the input signal amplitude before sending it to the oscilloscope input. The **Attenuation** submenu sets the probe attenuation factor for probes. The default attenuation is **10x**.

Push the Vertical Menu button for the channel input that you want to set.

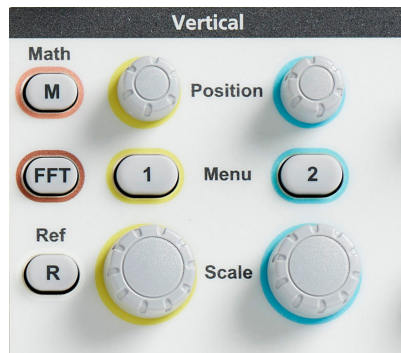

Push the Probe Setup side menu to display the Probe Setup submenu.

Use the Multipurpose knob to select and click the Attenuation submenu item.

Use the Multipurpose knob to select and change the attenuation factor.

Quickly setting the probe attenuation to 1X or 10X

The **Set To 1X** and **Set To 10X** submenu items let you quickly set the probe attenuation to either 1X or 10X.

Push the Vertical Menu button for the channel input that you want to set.

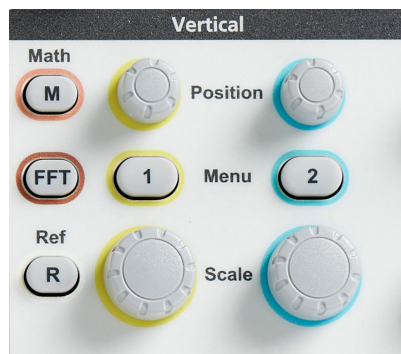

Push the Probe Setup side menu to display the Probe Setup submenu.

Use the Multipurpose knob to highlight either Set To 1X or Set To 10X submenu item. Then click the Multipurpose knob to set that value.

Setting the measure current mode for voltage probes

If you are measuring current by using a standard voltage probe to measure the voltage drop across a resistor, use the **Measure Current** field to set the Amps/Volts or Volts/Amps ratio of your measurement setup. For example, if you are measuring the voltage drop across a $2\ \Omega$ resistor to determine the current, set the V/A ratio to 2.

Push the Vertical Menu button for the channel input that you want to set.

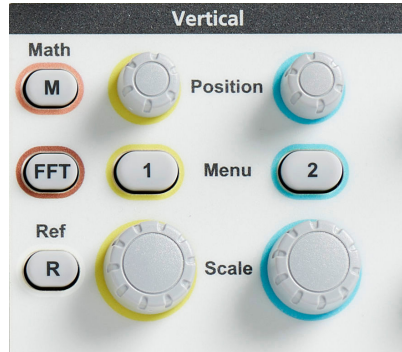

Push the Probe Setup side menu to display the Probe Setup submenu.

Use the Multipurpose knob to highlight the Measure Current submenu item.

Push the Multipurpose knob to toggle between Yes and No.

If you select Yes, the area below the Measure Current submenu displays the Amps/Volts or Volts/Amps ratio menu item. Use the Multipurpose knob to select and change the current measurement parameter.

Setting the input signal vertical offset

The **Offset** menu lets you set the vertical signal offset, which changes the waveform position relative to the oscilloscope ground (0 volts) reference. This menu also lets you quickly set a signal's vertical offset to 0. See [The difference between vertical position and vertical offset](#) on page 60.

Push the Vertical Menu button for the channel input that you want to set.

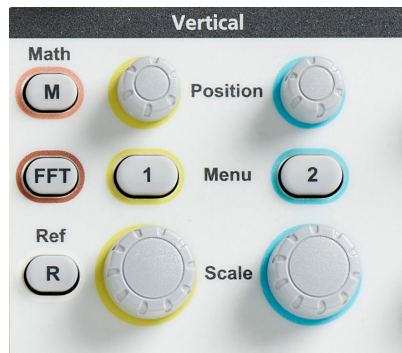

Push the **Offset** side-menu button.

To set a specific offset voltage, use the **Multipurpose** knob to select and click the offset value field. Use the knob to change the value; the waveform on the screen moves as you change the value. Click the knob again to exit the field.

To set the offset value to 0, use the **Multipurpose** knob to select and click **Set to 0**.

Setting the waveform vertical position

To quickly position a waveform position, use the **Vertical Position** knob on the front panel for the channel that you want to move.

The **Position** submenu lets you set the vertical signal position, which moves the waveform up or down on the screen. This menu also lets you quickly set the waveform 0 (ground) value to the center horizontal graticule. See [The difference between vertical position and vertical offset](#) on page 60.

1. Push the **Vertical Menu** button for the channel input that you want to set. Each channel's settings are independent of the other channels.

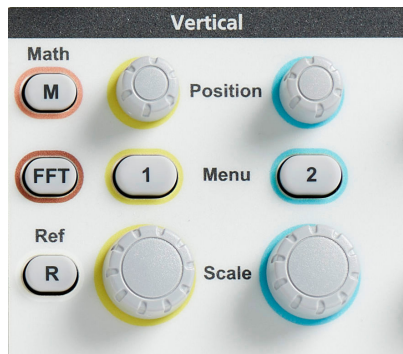

2. Push the **Position** side-menu button to select and show the Position submenu.
3. To set a specific position value, use the **Multipurpose** knob to select and click the position field. Use the knob to change the value; the waveform on the screen moves as you change the value. Click the knob again to exit the field.
4. To set the position to 0 (center graticule), use the **Multipurpose** knob to select and click **Set to 0**.

The difference between vertical position and vertical offset

- Vertical *position* is a display function that moves the waveform image on the screen. Moving the signal on the screen does not change the ground (0 volt) baseline level for that signal.
- Vertical *offset* is a signal function that adds a DC voltage to the input signal before the oscilloscope preamplifier. Adding this DC voltage moves, or offsets, the signal from the ground (0 volts) level. You use offset to increase the effective dynamic range of a signal.

For example, you can set the vertical offset to match the peak area of a signal, use the **Vertical Position** knob to move the peak area to the center graticule, and then set the **Vertical Scale** knob to smaller voltage/division settings to look at more detail in that waveform peak area.

Setting channel deskew

Deskew compensates for differences in signal delays between different cable lengths or probe types. Use **Deskew** to adjust the signal delay for individual channels so that all signals arrive at the oscilloscope at the same time. Deskewing channels lets you take accurate time-related measurements between two or more channels, or when using a current probe with a voltage probe.

Select one probe as a reference signal and adjust the deskew values for the other channels so that they all align. For best results, use a deskew fixture, such as the Tektronix 067-1686-xx.

The following image shows before and after using deskew to set channel 1 and 2 deskew to minimize the delay with channel 1.

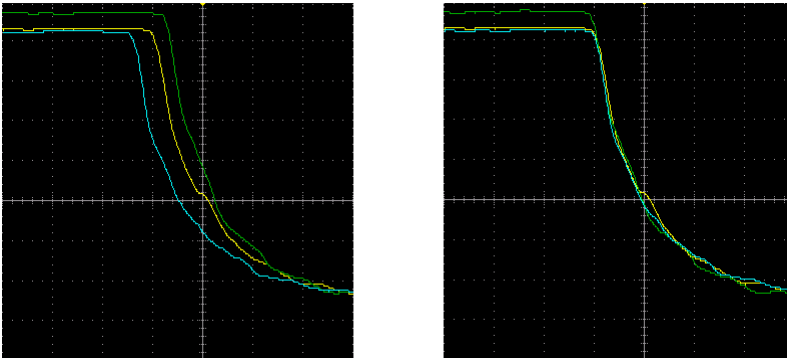

Push the Vertical Menu button for the channel input that you want to set.

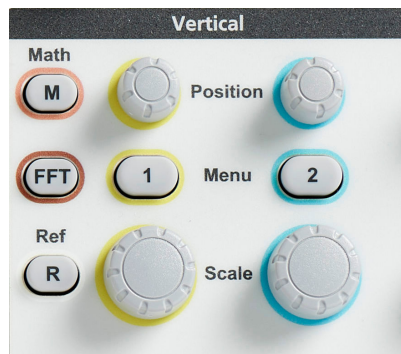

Push the More side-menu button.

Use the Multipurpose knob to select and click Deskew.

To set a specific deskew delay, use the Multipurpose knob to select and click 0s. Then use the knob to change and set the value. The waveform on the screen moves as you adjust the value.

To set the deskew to the oscilloscope default (0 delay), use the Multipurpose knob to select and click Set to Default.

Deskew tips

- **Deskew** settings are stored in nonvolatile memory until changed manually for each channel.

- **Deskew** settings are included in saved setup files.
- Doing a **Default Setup** resets deskew values to 0 on all channels.

Trigger setup

Triggering on a waveform edge

Use this procedure to set the oscilloscope to trigger on the rising or falling edge of a waveform.

1. Push the **Trigger Menu** front-panel button.

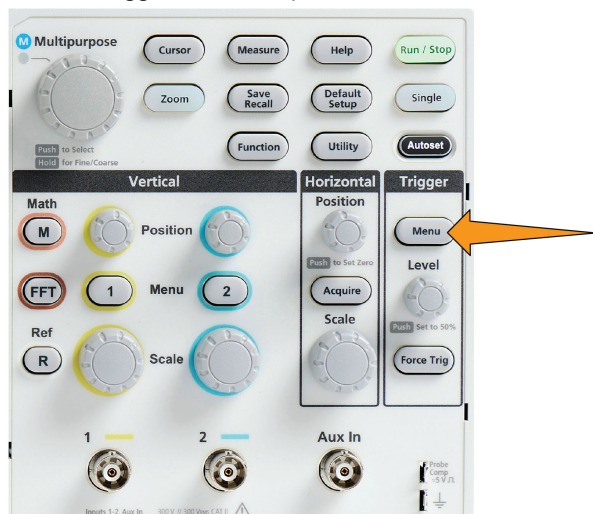

2. Push the **Type** side-menu button.
3. Use the **Multipurpose** knob to select and click **Edge**.
4. Push the **Source** side-menu button and use the **Multipurpose** knob to select and click the channel to use as the trigger signal source, or select **AC Line** to use the AC power source frequency as the trigger signal.
5. Push the **Slope** side-menu button to select between rising and falling slope edges on which to trigger the oscilloscope.

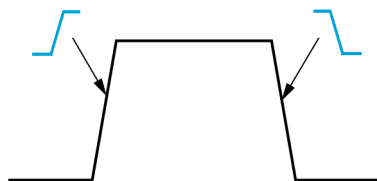

6. Push the **Level** side-menu button and use the **Multipurpose** knob to select and click the trigger level entry method:
 - Click **Level** and use the **Multipurpose** knob to manually set the trigger level.
 - Click **Choose Preset** and use the **Multipurpose** knob to set the trigger level to a predefined signal logic family level (TTL, CMOS, ECL, and so on) or to 0.
 - Click **Set to 50%** to set the trigger level to 50% of the signal peak-to-peak level.
7. Push **-More- Page 1/2** side-menu button.
8. Push the **Coupling** side-menu button and use the **Multipurpose** knob to select and click the trigger coupling. See [Trigger coupling](#) on page 53.



Note: You can use the **Trigger Level** knob to immediately change the trigger level and momentarily display a long horizontal line (or two lines for a **Runt** trigger) across the waveform to show the trigger level(s) in relation to the waveform.

Push the **Trigger Level** knob to immediately set the trigger to 50% of the signal peak-to-peak level.

Triggering on a specified pulse width

Use this procedure to set the oscilloscope to trigger on a specified signal pulse condition. You can trigger when a pulse is less than, greater than, equal to, or not equal to a set time period (width). The minimum pulse width setting is 1 ns. See [Available trigger types](#) on page 53.

Pulse width triggering is most often used to troubleshoot or analyze digital signals.

1. Push the **Trigger Menu** front-panel button.

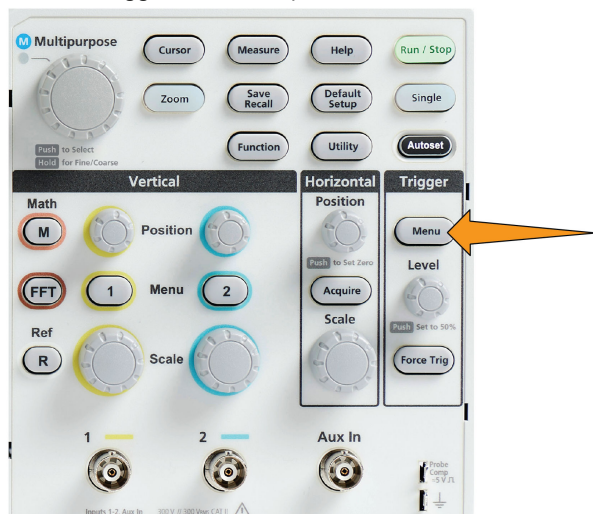

2. Push the **Type** side-menu button.
3. Use the **Multipurpose** knob to select and click **Pulse Width**.
4. Push the **Source** side-menu button and use the **Multipurpose** knob to select and click the channel to use as the trigger signal source.
5. Push the **Polarity** side-menu button and use the **Multipurpose** knob to select and click the pulse polarity (positive or negative) to trigger on.
6. Push the **Threshold** side-menu button and use the **Multipurpose** knob to select and click the trigger level entry method:
 - Click the threshold field and use the **Multipurpose** knob to manually set the trigger level.
 - Click **Choose Preset** and use the **Multipurpose** knob to set the trigger level to a predefined signal logic family level (TTL, CMOS, ECL, and so on) or to 0.
 - Click **Set to 50%** to set the trigger level to 50% of the signal peak-to-peak level.
7. Push **-More- Page 1/2** side-menu button.
8. Push the **Trigger When** side-menu button and use the **Multipurpose** knob to select and click the pulse width condition on which to trigger. Then use the **Multipurpose** knob to enter the pulse width time parameter.

Triggering on a runt pulse

Use this procedure to set the oscilloscope to trigger when a runt pulse occurs. You can also trigger when a runt pulse is less than, greater than, equal to, or not equal to a set time period (width).

A runt pulse is a pulse that crosses one threshold level but fails to cross a second threshold before recrossing the first. Therefore, a runt trigger needs two threshold levels to define the two levels that a signal must pass through to be considered a valid (nonrunt) signal. See [Available trigger types](#) on page 53.

Runt pulse triggering is most often used to troubleshoot or analyze digital signals.

The minimum runt pulse width setting is 1 ns.

1. Push the **Trigger Menu** front-panel button.



2. Push the **Type** side-menu button.
3. Use the **Multipurpose** knob to select and click **Runt**.
4. Push the **Source** side-menu button and use the **Multipurpose** knob to select and click the channel to use as the trigger signal source.
5. Push the **Polarity** side-menu button and use the **Multipurpose** knob to select and click the runt pulse polarity (positive, negative, or either) to trigger on.
6. Push the **Thresholds** side-menu button and use the **Multipurpose** knob to select and click the trigger levels (thresholds) to use to detect a runt pulse:
 - Click **High** and use the **Multipurpose** knob to manually set the level that defines a valid high signal threshold level.
 - Click **Low** and use the **Multipurpose** knob to manually set the level that defines a valid low signal threshold level.
 - Click **Choose Preset** and use the **Multipurpose** knob to set the trigger threshold levels to predefined signal logic family levels (TTL, CMOS, ECL, and so on) or to 0.
7. Push **-More- Page 1/2** side-menu button.
8. Push the **Trigger When** side-menu button and use the **Multipurpose** knob to select and click **Runt Occurs** to trigger on any runt event. If triggering on a runt width, use the **Multipurpose** knob to select and click the runt pulse width condition to test for, and enter the runt width time parameter.

Setting the trigger mode

Use this procedure to set the oscilloscope trigger **Mode**. The trigger mode sets how the oscilloscope behaves in the absence or presence of a trigger. Trigger mode also enables the trigger holdoff function. See [Trigger modes](#) on page 54.

Trigger mode does not set the trigger conditions; those are set with the **Trigger Type** side-menu buttons.

1. Push the **Trigger Menu** front-panel button.

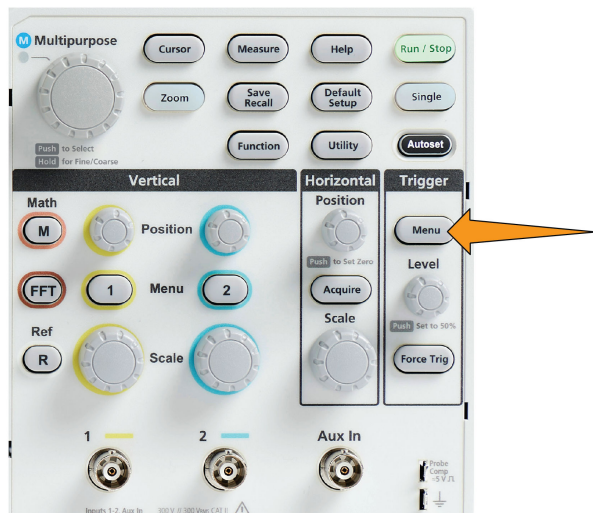

2. Push **-More- Page 1/2** side-menu button.
3. Push the **Mode** side-menu button.
4. Use the **Multipurpose** knob to select and click a trigger mode or holdoff mode:
 - Click **Auto (Untriggered Roll)** to set the oscilloscope to acquire and display a waveform even if a trigger does not occur. If there is no valid triggering event, the waveform will appear to roll across the screen. See [Auto Untriggered Roll trigger mode](#) on page 54.
 - Click **Normal** to set the oscilloscope to acquire and display a waveform only when a valid trigger event occurs. See [Normal trigger mode](#) on page 54.
 - Click **Holdoff** to set a time period after a trigger event, during which the oscilloscope ignores new trigger events. Once the holdoff period is over, the oscilloscope starts looking for the trigger condition. See [Holdoff trigger mode](#) on page 54.
 - Click **Set Holdoff to Minimum** to set the HoldOff value to the minimum value. The minimum holdoff period is 20 ns.

Trigger on an external signal using the AUX input

Use this procedure to trigger the instrument from an external signal connected to the AUX input.

1. Push the **Trigger Menu** front-panel button.
2. Push the **Trigger Type** side-menu button.
3. Use the Multipurpose knob to select and click **Edge** trigger type.
4. Push the **Source** side-menu button.
5. Use the Multipurpose knob to select and click **AUX** source.



Note: The Aux setting is available only for the Edge and Pulse Width trigger types.

6. Set the values for **Coupling**, **Level** and **Slope** to trigger on the AUX connector signal.

Acquisition setup

Using Autoset

Autoset is a fast way to acquire and display a waveform. **Autoset** automatically sets the trigger type to edge, sets the threshold level to 50% of the signal level, and analyzes the input signal and adjusts the oscilloscope acquisition, horizontal, and vertical settings to display five to six waveform cycles. **Autoset** is ideal for quickly displaying a repeating signal waveform.

Complete the following steps to Autoset:

1. Connect a probe to the oscilloscope and signal source.
2. Push the **Vertical Menu** button for the channel input that you want to **Autoset**, to enable that channel.

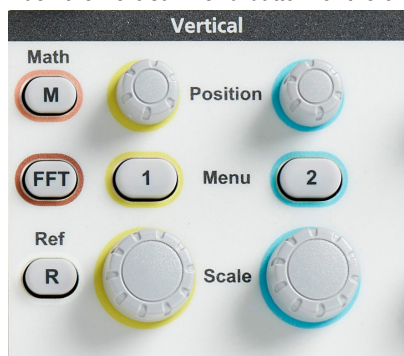

3. Push **Autoset**. The oscilloscope takes a few moments to analyze and display the signal.

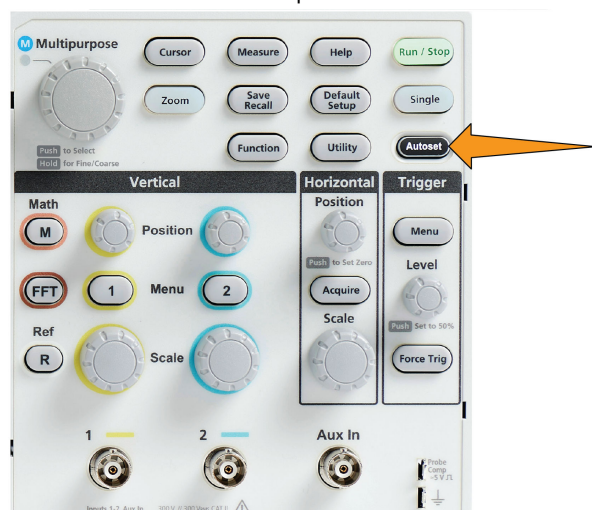

4. You can push the **Undo Autoset** side-menu button to undo the last Autoset.

Autoset tips

- If more than one channel is active, **Autoset** triggers on the lowest-numbered displayed channel, and displays all active channels from the top to the bottom of the screen.
- Autoset always sets vertical offset to 0 V.
- Channel 1 is a special case: If all channels are off (not displayed), or channel 1 is on, **Autoset** attempts to detect, trigger, and display the waveform for channel 1 even if no signal is present (resulting in a flat waveform for channel 1). It will not trigger on, or display the other channels, even if there are signals present on those channels.

How to enable/disable Autoset in the oscilloscope

Use this procedure to enable/disable the Autoset function to set up a waveform manually.



Note: To disable or enable the Autoset function requires a password. The default factory password is 000000.

1. Push **Utility**.

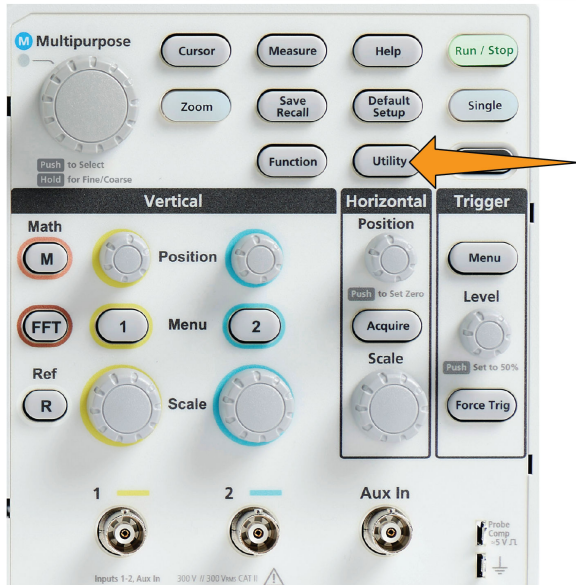

2. Push **Feature Enable** side-menu button.

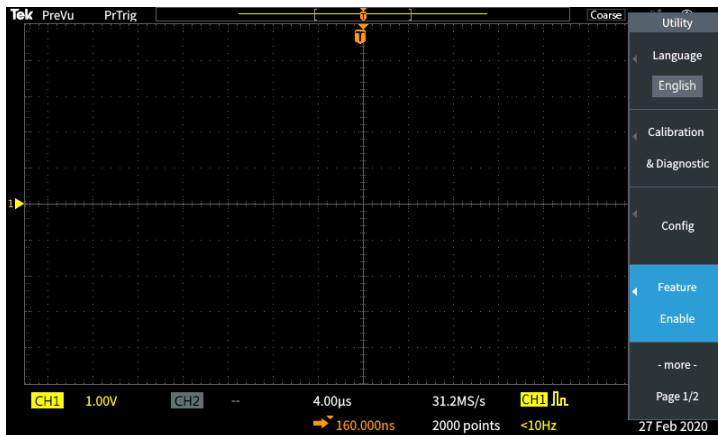

3. Use the **Multipurpose** knob to select and click **Autoset Enable**. The oscilloscope opens the **Feature Enable** password entry screen.

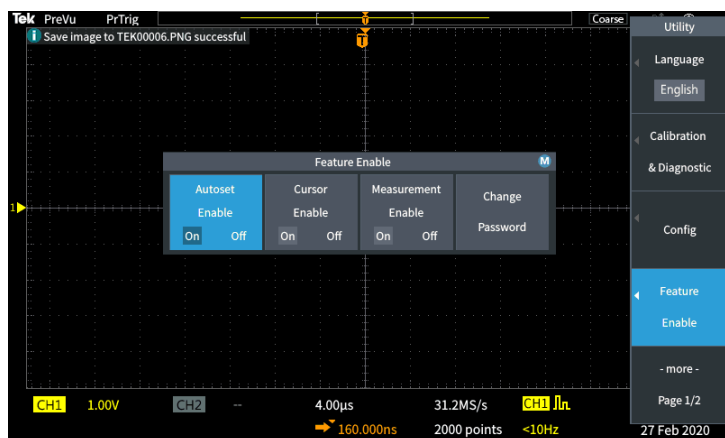

4. Use the **Multipurpose** knob and side-menu buttons to enter the password that lets you disable Autoset. The factory default password is **000000**.
5. Push **OK** side-menu button to enter the password and let you disable Autoset.

How to change the Autoset password

Use this procedure to change the Autoset enable/disable password. Autoset requires a password to enable or disable the Autoset mode.

1. Push **Utility**.

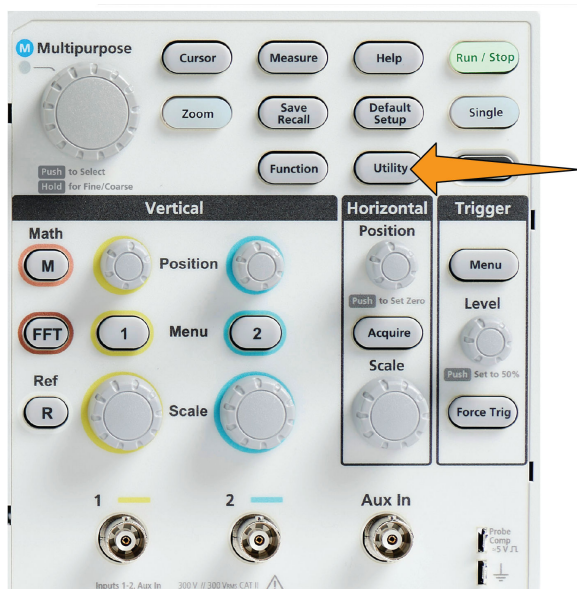

2. Push **Feature Enable** side-menu button.
3. Use the **Multipurpose** knob to select and click **Autoset Enable**.
4. Use the **Multipurpose** knob to select and click **Change Password**. The oscilloscope opens the **Change Password** entry screen.

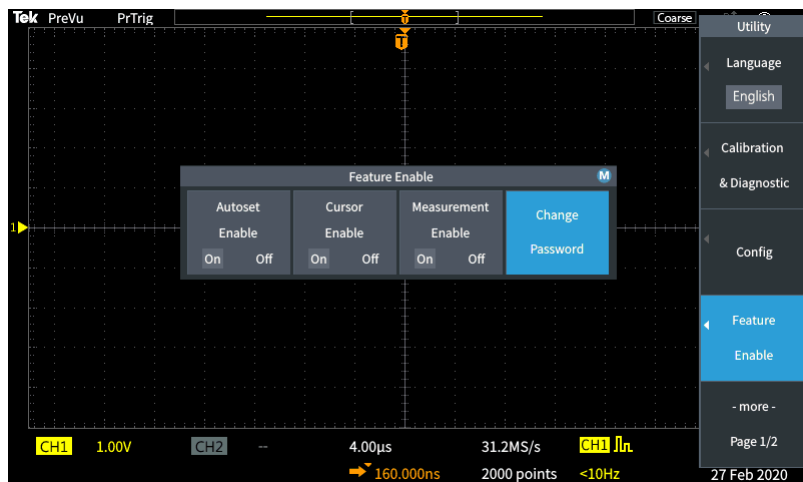

5. Use the **Multipurpose** knob and side-menu buttons to select alphanumeric and enter characters for the current password. Then push the **OK** side-menu button. The factory default password is 000000.
6. Use the **Multipurpose** knob and side-menu buttons to enter the new password. Then push the **OK** side-menu button. Reenter the new password to confirm it and push the **OK** side-menu button.



Note: The Autoset enable/disable can be done using the PI commands. Refer Programmer manual for detailed instructions.

Starting and stopping an acquisition

After you have defined the acquisition and trigger parameters, start acquiring and displaying a waveform with the **Run/Stop** or **Single** controls.

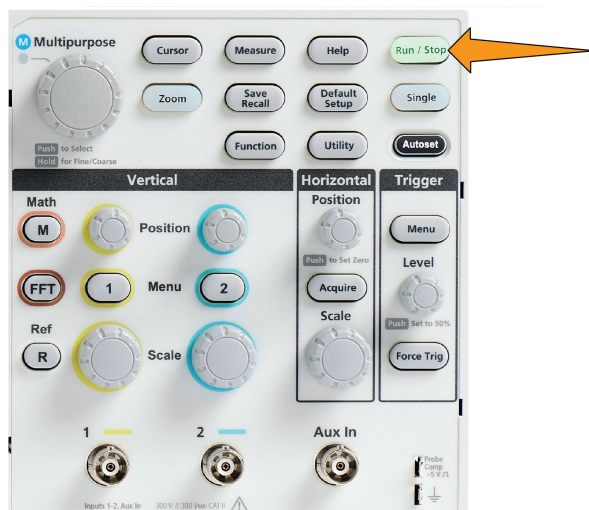

Single sets the trigger mode to Normal for the single acquisition.

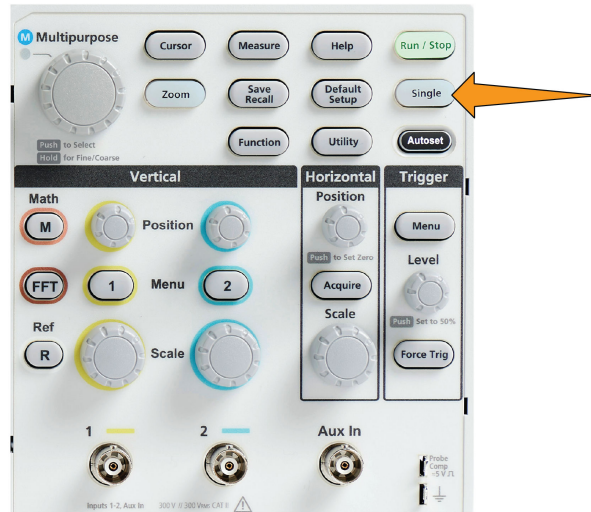

Setting the acquisition mode

Use the **Acquisition mode** to set how the oscilloscope uses the sampled data points in each acquisition interval to create and display a waveform. See [Acquisition mode concepts](#) on page 50.

1. Push **Acquire**.

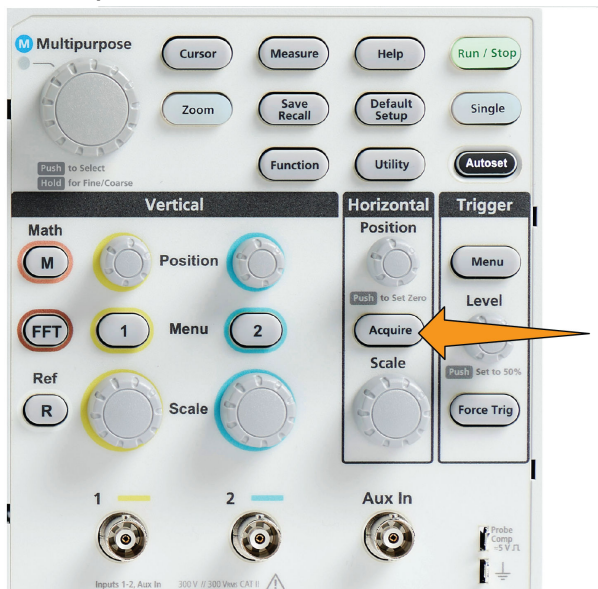

2. Push the **Mode** side-menu button.
3. Turn the **Multipurpose** knob to select a mode (**Sample**, **Peak Detect**, **Hi res**, **Average**), then click the **Multipurpose** knob to enable that mode.
4. If you select **Average**, use the **Multipurpose** knob to select of how many acquisitions to average to create the waveform.



Note: Sampling frequency for Peak Detect and Hi res modes are limited to 250MS/s. You can zoom in to view the waveforms in lower horizontal scales.

Setting the acquisition trigger delay time

Push Acquire.

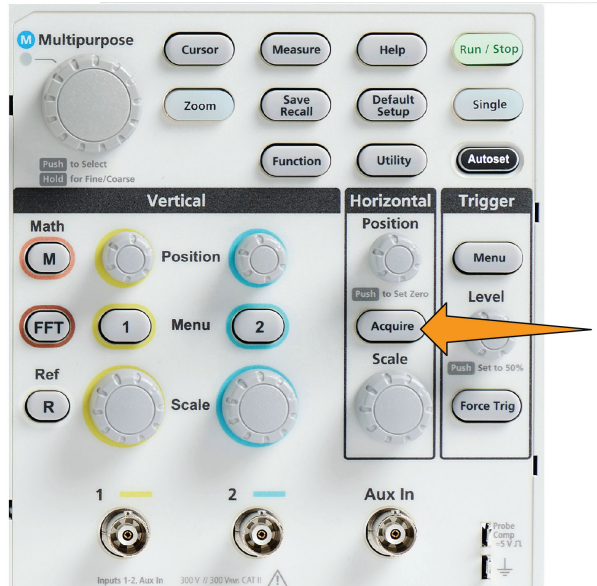

Push the Delay side-menu button to toggle between On and Off. When set to Off, the expansion point is tied to the trigger point so that horizontal scale changes are centered around the trigger point.

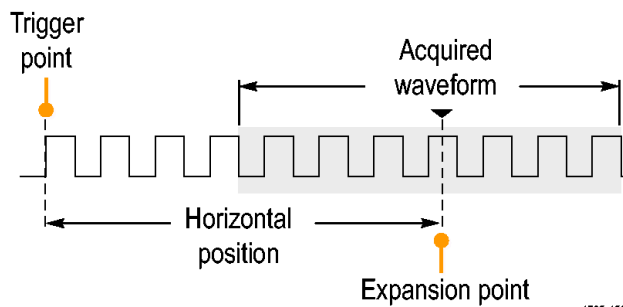

1785-159

With Delay set to On, the trigger point is disconnected from the expansion point. Turn the Horizontal Position knob to move the trigger point away from the expansion point (center graticule). The amount of delay is shown in the Horizontal Status area at the bottom-center of the graticule, referenced to 0 s (center graticule).

The trigger point can move off the screen; when this happens, the trigger marker changes to show the direction of the trigger point.

Trigger point is off-screen (delay time shown on readout at bottom of the screen)

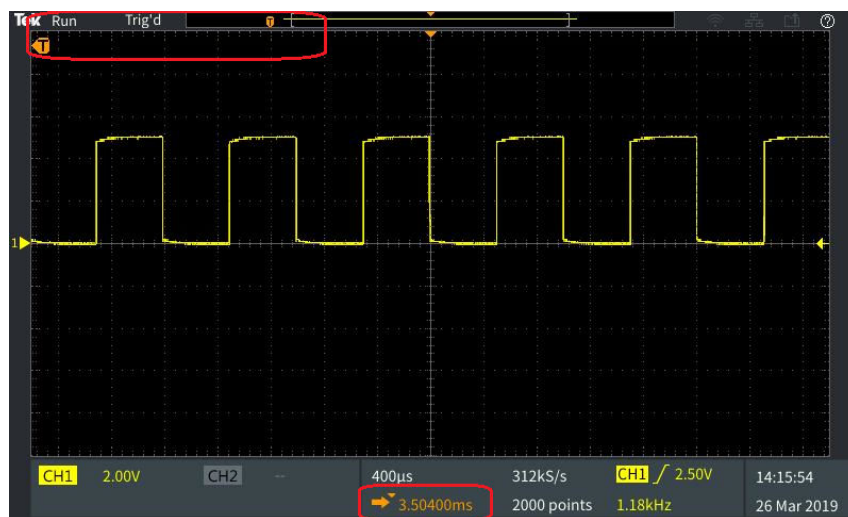

Trigger point is off-screen (delay time shown on readout at bottom of the screen)

Once you are displaying a waveform area of interest at the center of the screen, adjust the Horizontal Scale knob to acquire more points for the area of interest, and use the controls to view more detail.

Push the Set Horizontal Position to 0s side-menu button to return the trigger point to the center of the waveform record (setting delay to 0). Pushing this button does not turn off the delay mode.

You can also push the front-panel Horizontal Position knob to return the trigger point to the center of the waveform record.

Trigger Delay is different than Trigger Holdoff. See [Holdoff trigger mode](#) on page 54.

Setting the record length

Use this procedure to set the record length. The record length sets how many samples (data points) are added to a waveform record. Available record lengths are 1000, 2000, 20,000 points.

Push Acquire.

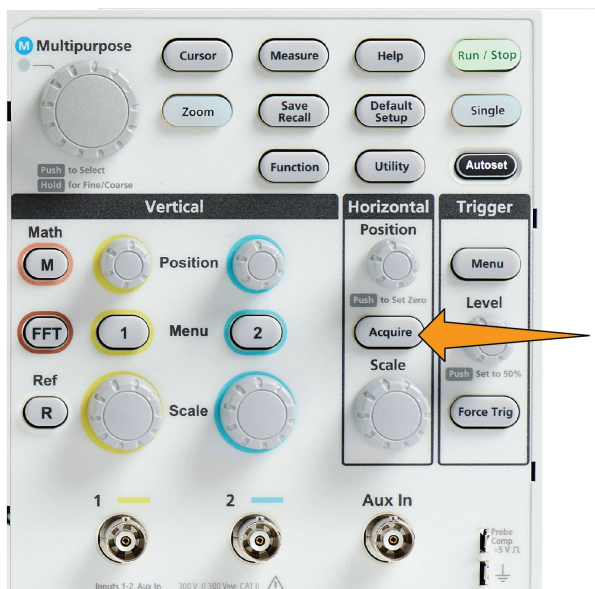

Push the Record Length side-menu button.

Use the Multipurpose knob to select and set the record length.

Use longer record lengths to either capture more samples for a waveform record, or capture more cycles of a waveform, then use the Zoom controls to investigate the waveform in more detail.

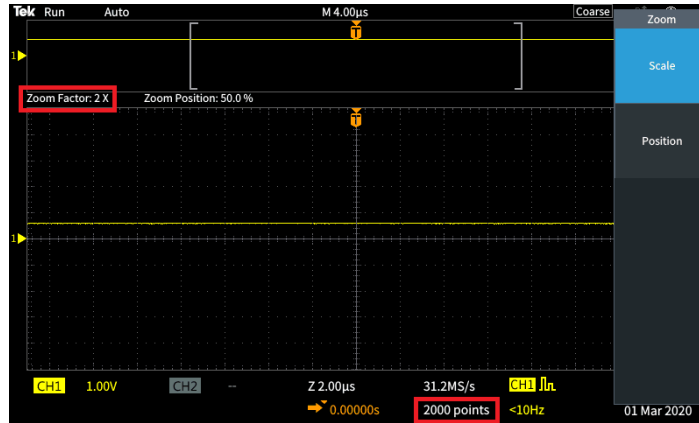

Maximum zoomed waveform record captured with 5000 points

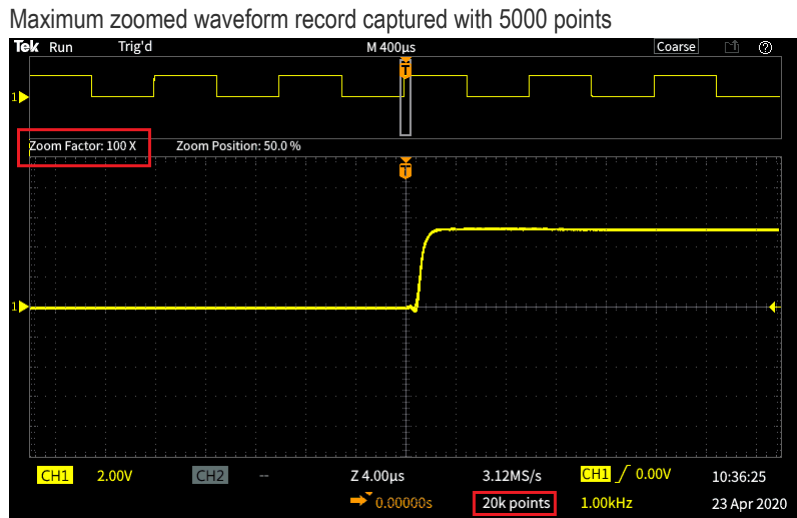

Using the roll display mode

Roll mode gives a display similar to a strip chart recorder, in that the waveform moves slowly, or rolls, from right to left on the screen. Roll mode is used to display low-frequency signals. Roll mode lets you see acquired data points without waiting for the acquisition of a complete waveform record.

Roll mode is not a button- or menu-selected mode, but is present when the trigger mode is Auto and the horizontal scale and record lengths are set as follows:

Table 5: Roll mode is enabled when:

Horizontal scale setting	Record length (number of samples)
40 ms/div	1000, 2000, 20k

Roll mode tips

- Push **Run/Stop** to halt Roll mode.
- Roll mode is disabled under the following conditions:
 - When using **Reference**, **Math**, or **FFT** waveforms
 - Using the **Zoom** function
 - Taking measurements (**Measure** menu)

- When trigger mode is changed to **Normal**
- When horizontal scale is set to 40 ms/division or higher



Note: The **Average** acquisition mode is unavailable when you are using Roll mode.

Setting the oscilloscope to factory default values - Default Setup

Default Setup clears the current oscilloscope settings and loads factory-defined settings. This lets you quickly reset the oscilloscope to a known state before setting up to take a new measurement.

See [Setting the oscilloscope to factory default values - Default Setup](#) on page 75.

To return the oscilloscope to its factory default settings:

Push Default Setup.

If you change your mind, push Undo Default Setup side-menu button to return the oscilloscope to the settings present before you pushed Default Setup. You must push this button before doing any other action.

Waveform display settings

Displaying and removing a waveform

Use this procedure to turn on or off the display of each channel's waveform.

To add or remove a waveform from the display, push the corresponding front-panel channel **Menu** button.

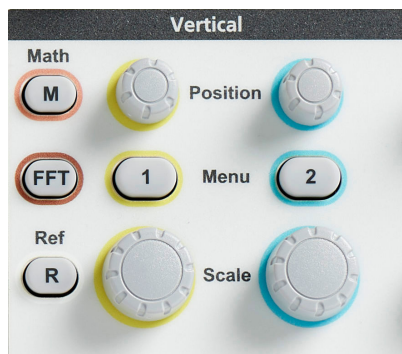

If the selected channel is already active, pushing the channel **Menu** button removes the waveform.

If the channel is not active, pushing the channel **Menu** button selects that channel; another push removes the waveform from the screen.

If more than one waveform is displayed on the screen, selecting a channel brings the corresponding waveform on top of all other waveforms.

Setting the waveform persistence

Persistence sets the time for how long the oscilloscope retains and displays the sampled waveform points on the screen. Using longer or infinite persistence time helps to display infrequent or random signal anomalies such as glitches.

Normal persistence sets the oscilloscope to erase the current waveform data as it draws the newest acquisition. Changing the persistence time (from 1 second to 10 seconds) sets how long to retain waveform data points in memory and on the screen until they are erased. The older data points are erased first.

Infinite persistence sets the oscilloscope to retain and display all acquisition waveform data points without erasing the previous data.

Changing an acquisition setting, such as Horizontal Position or Scale, Autoset, and Single, resets the persistence period to start over.

1. Push **Acquire**.

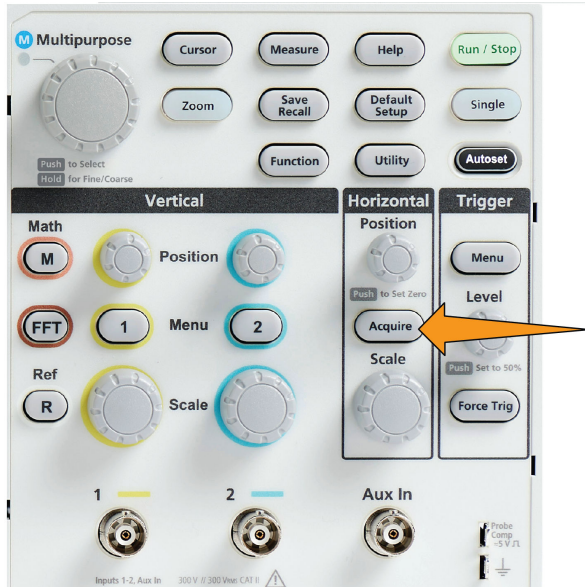

2. Push **Waveform Display** side-menu button.
3. Use the **Multipurpose** knob to select and click **Persist Time**.
4. Use the **Multipurpose** knob to change and set the **Persist Time** value. The range is **Auto** 0 s - 10 s (in one second increments), and infinity.

Auto is not same as 0 seconds. Auto is persistence time that gives the most number of waveforms per second, for a given horizontal scale. The range of persistence is 1s - 10s in the steps of 1s. There is an option to have persistence set to 0 seconds. This is mode can be enabled when Persistence is set to OFF. When persistence is set to ON, there is an option to select the amount of persistence in terms of time ranging from 1s -10s. Further, the amount of persistence can be set to Auto, that gives the best performance.

5. To clear the persistence of the displayed waveform, select and click **Clear Persistence**. This does not change the persistence setting, but just clears the displayed waveform persistence data.

Waveform persistence tip

To quickly clear the displayed waveform persistence data, push **Single**, then push **Run/Stop** to restart active waveform acquisition.

Note: For FFT waveform, the behavior of the persistence will be as follows.



- Setting the persistence to infinite, will make the display to retain all the waveforms.
- Setting the persistence to ON (Auto 0 s - 10 s), will have the similar behavior as Persistence set to OFF.

The XY display mode

The XY display mode plots the signal amplitude of channel 1 (X) against the amplitude of channel 2 (Y), where channel 1 is the horizontal axis and channel 2 is the vertical axis. XY display mode is useful for showing signal phase or frequency relationships between periodic signals. The resulting XY plots are called Lissajou patterns.

You can display Ch 1 versus Ch 2 on two-channel models.

1. Select the two signal sources that you want to plot. Push the **Vertical Position** knob for each channel to set the ground reference of both signals to 0 V (center horizontal graticule) so that the XY plot is centered on the screen.

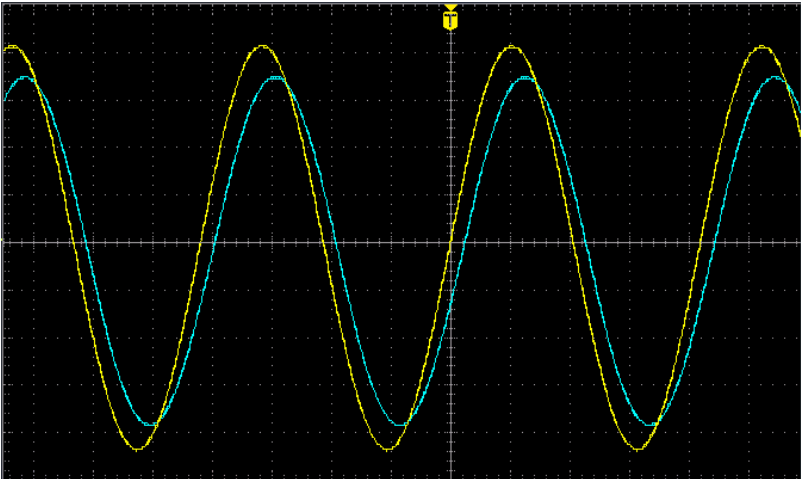

2. Push **Acquire**.



- 3. Push **-More- Page 1/2** side-menu button.
- 4. Push **XY Display** side-menu button to toggle XY display mode **On** and **Off**.

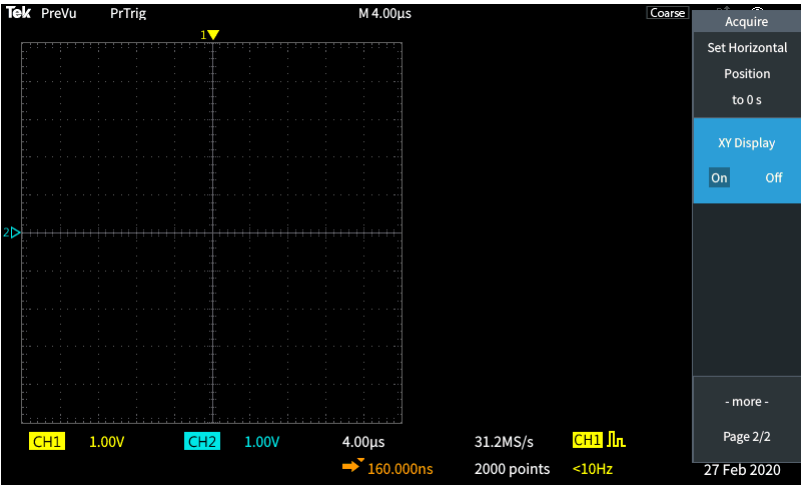

XY display mode tips

- Because the XY display is simply a different way of displaying pairs of waveforms, the underlying waveforms are available for measurements, and for saving to reference memory or a USB drive for off-line analysis.
- Use a Web browser and search on the keyword “lissajou patterns” to find more information on XY plots.

Setting the backlight intensity

Use this procedure to change the overall screen lighting level. Higher settings are better for brightly lighted areas, and lower values are better for dimly lit areas.

1. Push **Utility**.

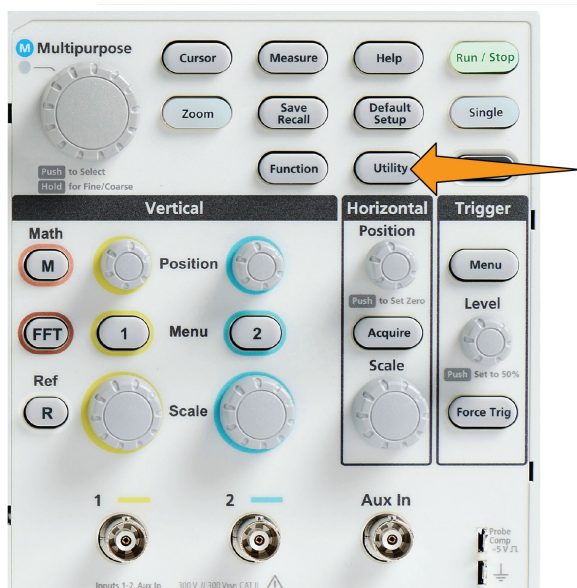

2. Push **-More- Page 1/2** side-menu button.
3. Push the **Display & Date** side-menu button.

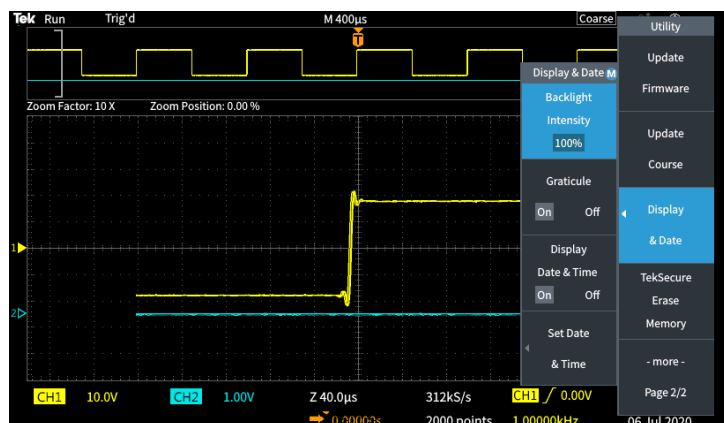

4. Use the **Multipurpose** knob to select and click **Backlight Intensity**.
5. Use the **Multipurpose** knob to change and set the backlight value.

Analyzing a waveform

Taking automatic measurements

Automatic measurements are a way to quickly take common measurements on a waveform, such as signal frequency, period, rise and fall times, and so on. You can take up to a total of six measurements at once, on any combination of input channels and a math waveform. The measurements are shown on the main screen in the order they were selected.

To take an automatic measurement:

Acquire and display a triggered waveform.

Push Measure.

Push the side-menu button to select the channel on which to take measurements.

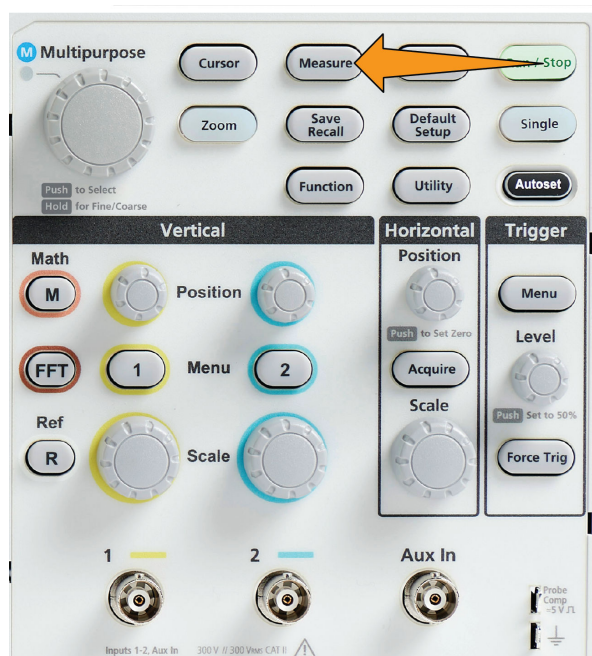

Use the Multipurpose knob to select and click a measurement.

See [Automatic measurement descriptions](#) on page 82.

The Measurement Selection bar at the top of the screen updates to show that a measurement was selected for that channel (indicated by color), up to a maximum of six measurements total to display.

Measurements with a down triangle contain a list of the input channels to use for that measurement when selected. Select and click the input

channels. Then push the Menu On/Off button to close the list.

To unselect a measurement, highlight that measurement and click the Multipurpose knob. To deselect a measurement for a different channel than the current channel, push the side-menu button for the channel of the measurement, then use the knob to select and click the measurement to remove it.

To unselect all measurements, push the Remove All Measurements side-menu button.

To close the measurement menu and show the selected measurements on the screen, push the Menu On/Off button.

Measurements are shown on the screen. Pushing the Menu On/Off button also turns on or off showing the measurements on the screen.

Menu
On/Off 

CH1	Frequency	57.76kHz ?
CH1	Period	17.31μs ?
CH2	Frequency	OFF

Automatic measurements tip

A  symbol appears next to a measurement if a vertical signal clipping condition exists. Part of the waveform is above or below the upper or lower edge of the screen. Signal clipping causes inaccurate measurements. To obtain an accurate measurement, turn the **Vertical Scale** and **Position** knobs so that all of the waveform is on the screen.

A  symbol appears next to a measurement if the measurement accuracy is not guaranteed. Wait for measurement module to get proper measurement. As soon as the proper measurement is available, the symbol will disappear.

Taking a measurement snapshot

The **Snapshot** measurement (in the **Measurement** menu) displays all single-channel measurements on one screen for a single acquisition of one channel. You can view the snapshot results and save a screen image of the snapshot measurements to a file.

To take a measurements snapshot:

1. Acquire and display a triggered waveform.
2. Push **Measure**.

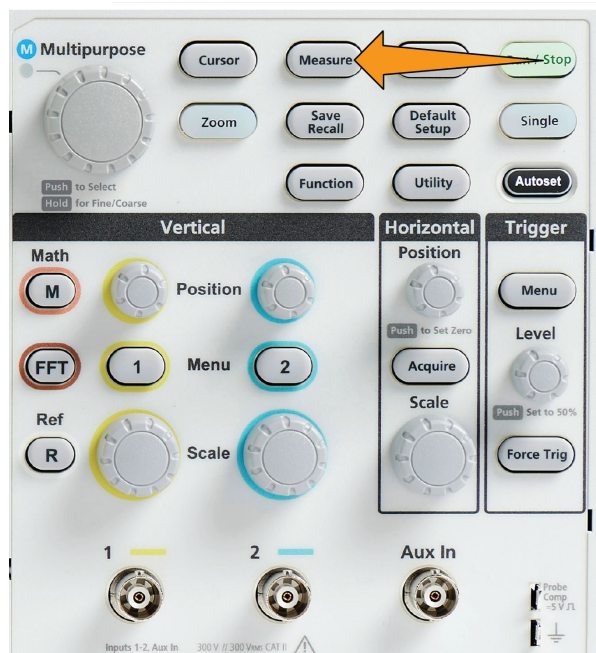

3. Push the side-menu button of the channel for which to show the measurement snapshot. You can only take a snapshot of one channel at a time.
4. Use the **Multipurpose** knob to select and click **Snapshot**. The snapshot screen opens immediately.
5. If the **File Save** button is set to save an image, push the **File Save** button to save the snapshot image to a file. See [Saving files to USB with the Save File button](#) on page 106.



6. Push the **Menu On/Off** button to close the **Snapshot** screen and return to the measurements menu.



Snapshot measurement tip





- The measurement snapshot does not mark a measurement if a vertical clipping condition exists. Clipping is where part of the waveform is above or below the display. To obtain a proper measurement snapshot, use the **Vertical Scale** and **Position** knobs to make all of the waveform appear in the display.
- You can also use **Gating** to analyze only a specified part of a waveform when you take a measurement snapshot. See [Taking a measurement on just a part of the waveform Gating](#) on page 86.

Automatic measurement descriptions

The following tables list the automatic measurements, grouped as shown on the measurements menu. Measurement descriptions can also be shown on the oscilloscope by enabling **HelpEverywhere™** (**Help > HelpEverywhere™**). See [Getting on-screen help for settings HelpEverywhere™](#) on page 45.

Frequency measurement descriptions

Table 6: Frequency measurements

Measurement		Description
Frequency		The first cycle in a waveform or gated region. Frequency is the reciprocal of the period; it is measured in hertz (Hz) where one Hz is one cycle per second.
+Pulses		The number of positive pulses that rise above the mid reference crossing in the waveform or gated region.
-Pulses		The number of negative pulses that fall below the mid reference crossing in the waveform or gated region.
+Edges		The number of positive transitions from the low reference value to the high reference value in the waveform or gated region.
-Edges		The number of negative transitions from the high reference value to the low reference value in the waveform or gated region.

Time measurement descriptions

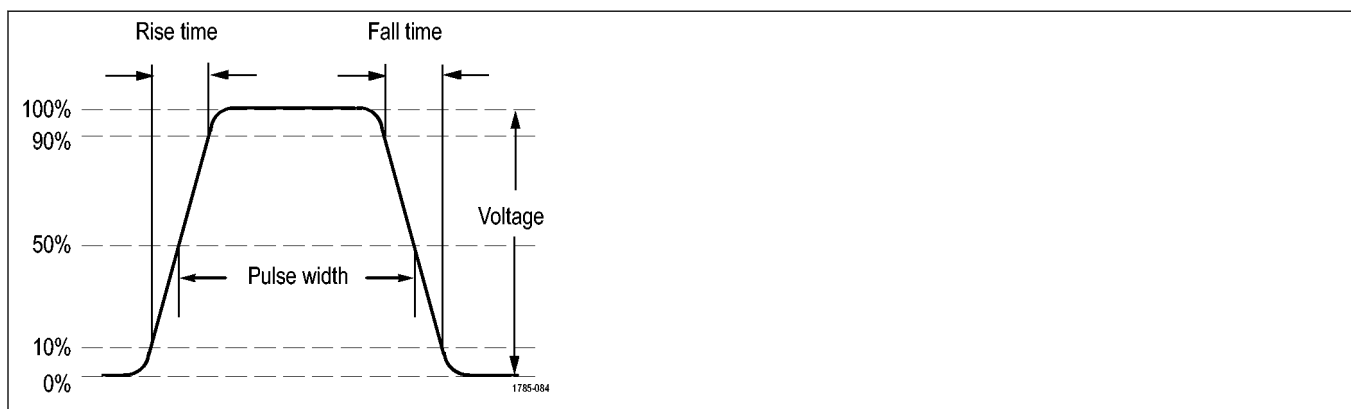
**Table 7: Time measurements**









Measurement		Description
Period		The time required to complete the first cycle in a waveform or gated region. Period is the reciprocal of frequency and is measured in seconds.
Rise Time		The time required for the leading edge of the first pulse in the waveform or gated region to rise from the low reference value to the high reference value of the final value.
Fall Time		The time required for the falling edge of the first pulse in the waveform or gated region to fall from the high reference value to the low reference value of the final value.

Table continued...

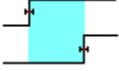
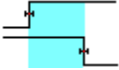
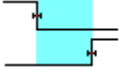
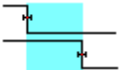
Measurement		Description
DelayRR		The time between the mid reference (default 50%) amplitude point of the rising edge of two different waveforms. See also <i>Phase</i> . This measurement requires inputs from two channels.
DelayRF		The time between the mid reference (default 50%) amplitude point of the rising edge of one waveform and the falling edge of a second waveforms. See also <i>Phase</i> . This measurement requires inputs from two channels.
DelayFR		The time between the mid reference (default 50%) amplitude point of the falling edge of one waveform and the rising edge of a second waveforms. See also <i>Phase</i> . This measurement requires inputs from two channels.
DelayFF		The time between the mid reference (default 50%) amplitude point of the falling edge of one waveform and the falling edge of a second waveforms. See also <i>Phase</i> . This measurement requires inputs from two channels.
Phase		The amount of time that one waveform leads or lags another waveform, expressed in degrees, where 360° makes up one waveform cycle. See also <i>Delay(RR, RF, FR, FF)</i> . This measurement requires inputs from two channels.
+Width		Positive pulse width. The distance (time) between the mid reference (default 50%) amplitude points of a positive pulse. The measurement is made on the first pulse in the waveform or gated region.
-Width		Negative pulse width. The distance (time) between the mid reference (default 50%) amplitude points of a negative pulse. The measurement is made on the first pulse in the waveform or gated region.
+Duty		The ratio of the positive pulse width to the signal period expressed as a percentage. The duty cycle is measured on the first cycle in the waveform or gated region.
-Duty		The ratio of the negative pulse width to the signal period expressed as a percentage. The duty cycle is measured on the first cycle in the waveform or gated region.
Burst Width		The duration of a burst (a series of transient events) and is measured over the entire waveform or gated region.

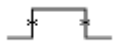
Amplitude measurement descriptions

**Table 8: Amplitude measurements**

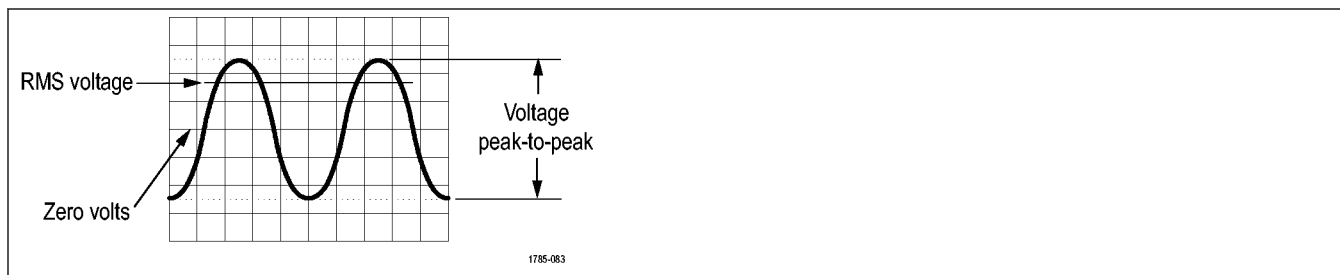

Measurement		Description
Peak-to-peak		The absolute difference between the maximum and minimum amplitude in the entire waveform or gated region.
Amplitude		The average high value less the average low value measured over the entire waveform or gated region.
Max		The most positive peak voltage. Max is measured over the entire waveform or gated region.
Min		The most negative peak voltage. Min is measured over the entire waveform or gated region.
High		This value is used as 100% whenever high reference, mid reference, or low reference values are needed, such as in fall time or rise time measurements. Calculated using either the min/max or histogram method. The min/max method uses the maximum value found. The histogram method uses the most common value found above the midpoint. This value is measured over the entire waveform or gated region.
Low		This value is used as 0% whenever high reference, mid reference, or low reference values are needed, such as in fall time or rise time measurements. Calculated using either the min/max or histogram method. The min/max method uses the minimum value found. The histogram method uses the most common value found below the midpoint. This value is measured over the entire waveform or gated region.
+Over		This is measured over the entire waveform or gated region and is expressed as: Positive Overshoot = (Maximum – High) / Amplitude x 100%.
–Over		This is measured over the entire waveform or gated region and is expressed as: Negative Overshoot = (Low – Minimum) / Amplitude x 100%.
Mean		The arithmetic mean over the entire waveform or gated region.
Cycle Mean		The arithmetic mean over the first cycle in the waveform or the first cycle in the gated region.
RMS		The true Root Mean Square voltage over the entire waveform or gated region.

Table continued...

Measurement	Description
Cycle RMS	 The true Root Mean Square voltage over the first cycle in the waveform or the first cycle in the gated region.

Area measurement descriptions

Table 9: Area measurements

Measurement	Description
Area	 A voltage over time measurement. The measurement returns the area over the entire waveform or gated region in volt-seconds. Area measured above ground is positive; area measured below ground is negative.
Cycle Area	 A voltage over time measurement. The measurement is the area over the first cycle in the waveform or the first cycle in the gated region expressed in volt-seconds. The area above the common reference point is positive, and the area below the common reference point is negative.

Taking a measurement on just a part of the waveform Gating

Gating sets the automatic measurements to use only a specified part of a waveform for the measurements. The **Gating** function applies to all channels and all measurements (in other words, you cannot set a different gating region for individual measurements or different channels).

1. Push **Measure**.

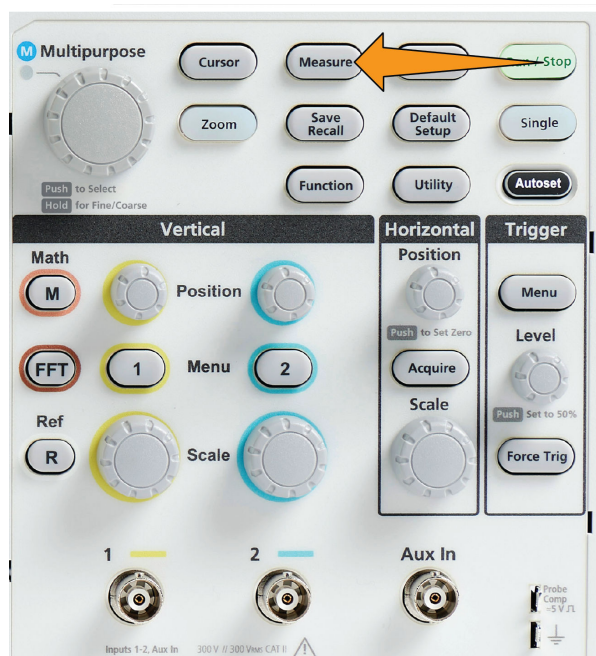

2. Push **-More-** Page 1/2 side-menu button.
3. Push the **Gating** side-menu button.

- Use the **Multipurpose** knob to select and click the area of the waveform to use for taking measurements (**Off (Full Record), Screen, Between Cursors**).

If selecting **Between Cursors**, use the **Multipurpose** knob to select and move the gating cursors to mark the waveform area to use for

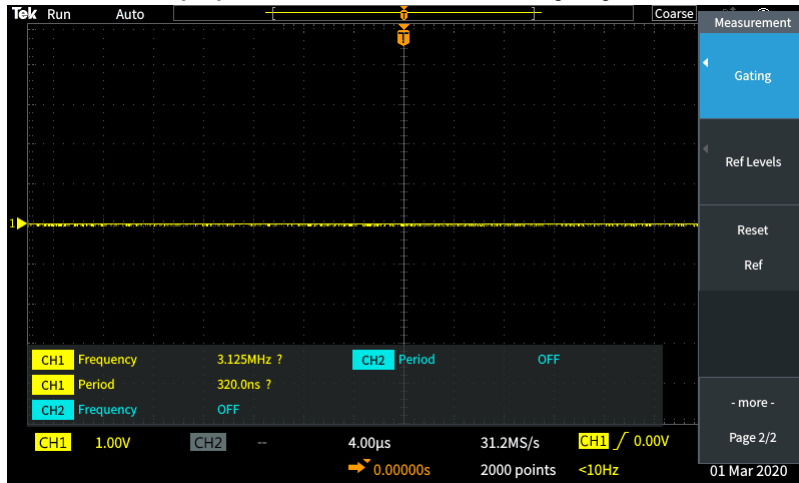

automatic measurements.

How to enable / disable measurement in the oscilloscope

Use this procedure to enable / disable waveform measurements manually.

Note:



- To disable or enable the measurement function requires a password. The default factory password is 000000.
- An instructor in a TekSmartlab™ equipped education lab can enable or disable Measurement from the TekSmartLab application, for all the connected oscilloscopes.

- Push **Utility**.

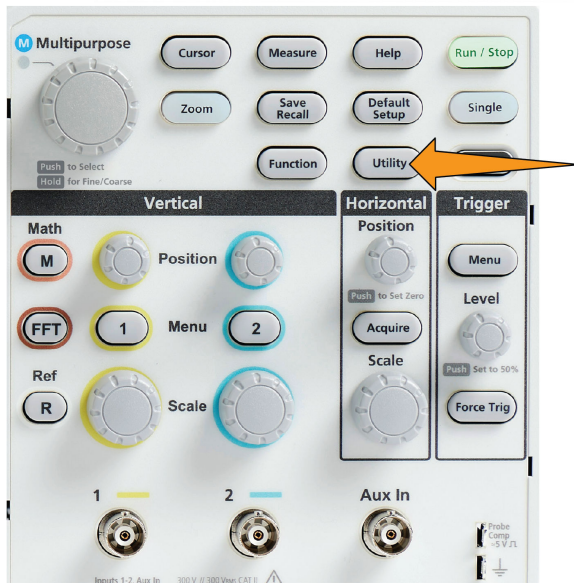

- Push **Feature Enable** side-menu button.
- Use the **Multipurpose** knob to select and click **Measurement Enable**. The oscilloscope opens the **Feature Enable** password entry screen.



4. Use the **Multipurpose** knob and side-menu buttons to enter the password that lets you disable Measurement.
5. Push **OK** side-menu button to enter the password and let you disable Measurement.

Using cursors to take manual measurements

Cursors are on-screen vertical and horizontal lines that you position on a waveform to take measurements. The cursors have readouts that show the value at their position or where they cross a waveform. Cursors also show the absolute difference measurement value (or delta) between two cursor positions.

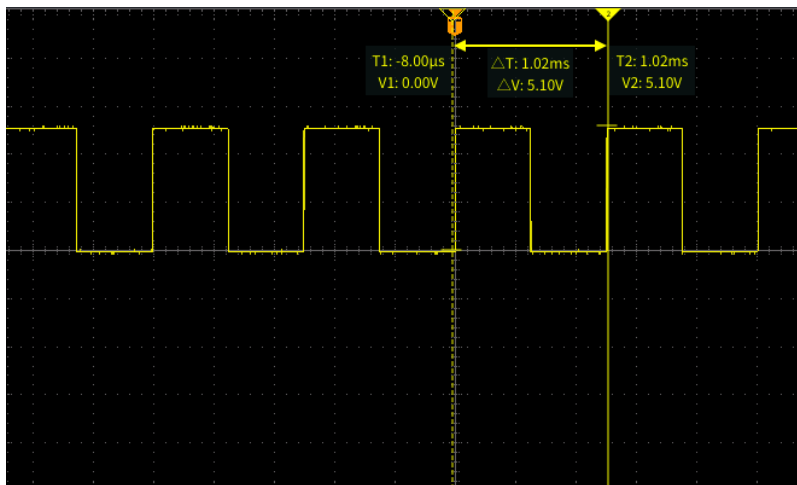

Cursor readouts appear next to the cursors. The readouts show the signal values at the current cursor positions. The readouts also show the difference (delta, marked with a Δ symbol) between the cursor measurements. The oscilloscope always shows the readouts when the cursors are turned on.



Note: Cursors are not available in XY display mode.

1. Push **Cursors** to display two vertical **Time** cursors by default.

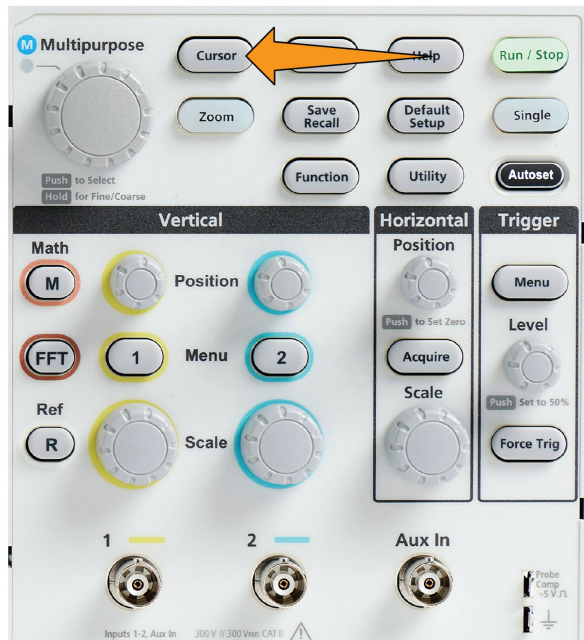

The color of the cursors indicates the channel on which they are taking measurements.

The solid line cursor is the active (selected) cursor, and is controlled by the **Multipurpose** knob.

- Use the **Multipurpose** knob to move the solid line (selected) cursor. The readouts associated with that cursor change as you move the cursor.

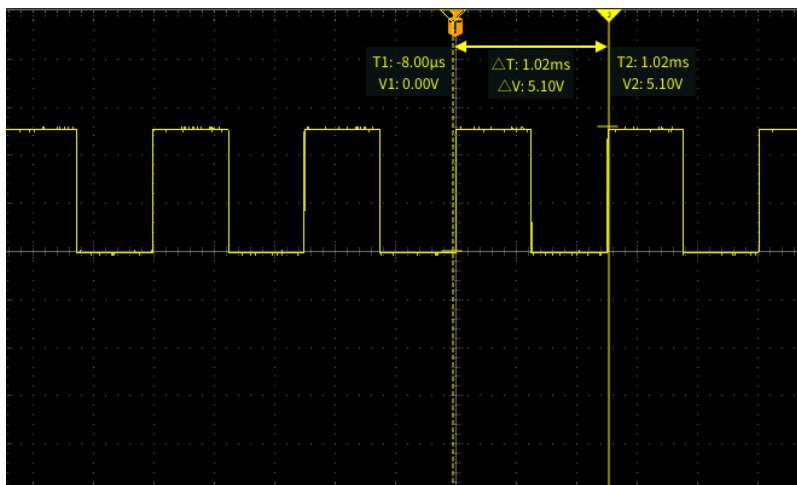

- Push the **Multipurpose** knob to select the other cursor (which becomes a solid line), then turn the knob to move that cursor. The first cursor is now drawn with a dotted line.
- To make smaller cursor position adjustments, push the **Function** button to toggle between making coarse and fine cursor position adjustments.

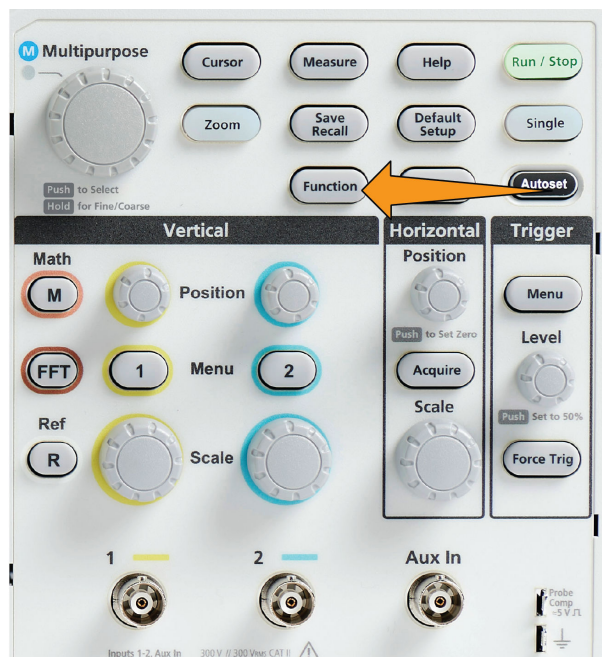

The **Fine** knob sensitivity in the **Function** button also enables smaller adjustments on the **Vertical** and **Horizontal Position** knobs, the **Trigger Level** knob, and many adjustment operations of the **Multipurpose** knob.



Note: You can also switch between Fine and Coarse by pressing and holding the Multipurpose knob.

5. Push the **Amplitude** or **Screen** side-menu button to select a different cursor for taking measurements. See [Cursor types](#) on page 90.
6. Push the **Link** side-menu button to turn cursor linking **On** or **Off**. If linking is **On**, turning the **Multipurpose** knob moves both cursors at the same time.
7. If one or both of the cursors are off of the screen, push the **Bring Cursor On Screen** side-menu button to bring off-screen cursors back to the screen.
8. Push the **Cursors** front panel button to turn the cursors off.

Cursor types

The cursor types are:

Time or Frequency cursors. These vertical cursors measure time or frequency, the signal amplitude where the cursors cross the waveform, and the absolute difference (delta) between the two cursors cross points (both time and amplitude delta).

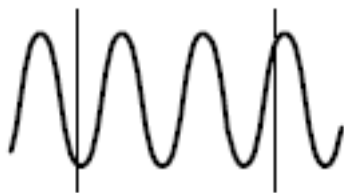

Note: Frequency cursors for FFT only

Time readouts are relative to the trigger point (which is 0 s). For example, cursors to the left of the trigger are minus time values.

Amplitude cursors. These horizontal cursors measure vertical amplitude parameters, typically voltage.

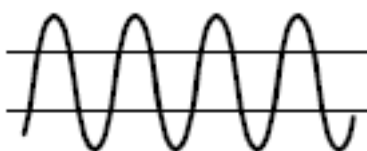

Screen cursors: A combination of both the vertical and horizontal cursors. Click the Multipurpose knob to cycle through selecting the cursors.

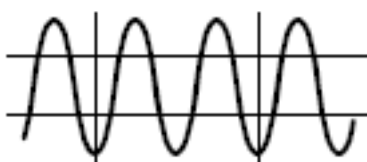

How to enable / disable cursor in the oscilloscope

Use this procedure to enable / disable cursor manually.



Note: To disable or enable the Cursor function requires a password. The default factory password is 000000.



Note: An instructor in a TekSmartlab™-equipped education lab can enable or disable Cursor from the TekSmartLab application, for all connected oscilloscopes.

1. Push **Utility**.

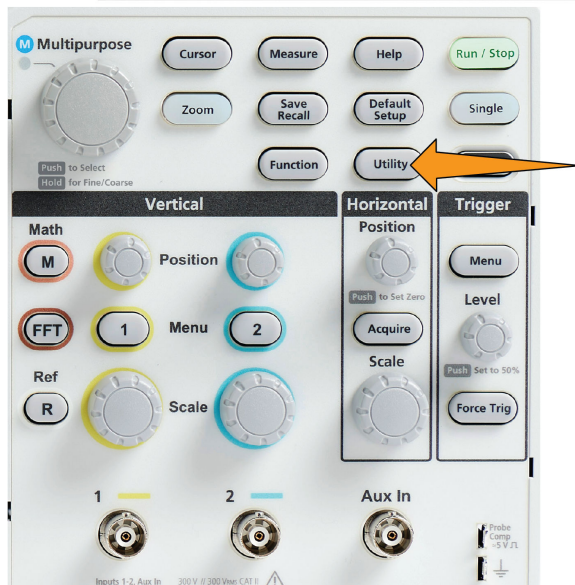

2. Push **Feature Enable** side-menu button.
3. Use the **Multipurpose** knob to select and click **Cursor Enable**. The oscilloscope opens the **Feature Enable** password entry screen.



4. Use the **Multipurpose** knob and side-menu buttons to enter the password that lets you disable Cursor.
5. Push **OK** side-menu button to enter the password and let you disable Cursor.

Creating math waveforms

Math waveforms let you add, subtract, and multiply any two channel waveforms to create a new math waveform. You can then take measurements on the math waveform, or save it to a reference memory or an external waveform data file.

Push Math. The oscilloscope displays a red math waveform using the current side menu settings.



Push the Source 1 side-menu button.

Use the Multipurpose knob to select and click the first channel to use for the math waveform.

Push the Operator side-menu button.

Use the Multipurpose knob to select and click the math operation to apply to the two waveforms (add, subtract, or multiply).

Push the Source 2 side-menu button.

Use the Multipurpose knob to select and click the second channel to use for the math waveform. The oscilloscope immediately displays the math waveform.

To move the math waveform vertical position, push the Position side-menu button and use the Multipurpose knob to move the waveform.

To change the size (vertical scale) of the math waveform, push the Vertical Scale side-menu button and use the

Multipurpose knob to change the waveform scale.

Note that the math vertical scale setting only applies to the math waveform.

An example of using a math waveform is to calculate instantaneous power (current times voltage) by multiplying a voltage waveform and a current waveform.

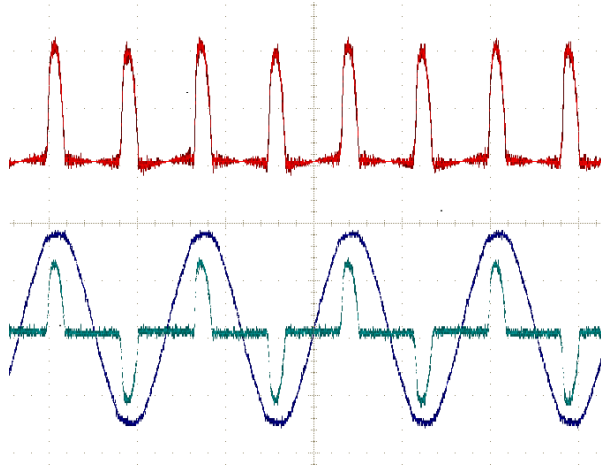

Math waveform tips

- Math waveforms get their horizontal scale and position from the sources channels. Adjusting these controls for the source waveforms also adjusts the math waveform.
- Adding or subtracting waveforms with different units sets the math waveform units to “?”.
- You can take automatic measurements on math waveforms similarly as on channel waveforms. Just select the **Math** side menu in the **Measure** screen and select the measurements to apply.
- You can save a math waveform to a reference memory or to a file on a USB drive. You can also recall (load) math waveforms into reference memory. See [Recalling waveform data](#) on page 108.
- You can zoom in on math waveforms using the **Navigation** controls (**Zoom** button and **Multipurpose** knob).

Using FFT to see signal frequency information

There are many signals that have some sort of distortion or unwanted characteristics. Sometimes these distortions do not affect how that signal works in the circuit. But often system clock pulses, signals induced from a nearby printed circuit path, or noise from a power supply or other source can affect a signal and prevent it from operating correctly. The FFT function is a powerful tool to help you find the frequencies of unwanted signals that are embedded in your main signal.

The FFT function uses Fast Fourier Transformation (FFT) mathematical calculations on the waveform data to determine the component frequencies in the signal. The resulting waveform shows a series of ‘spikes’ along a horizontal axis, where each spike represents a frequency component of the waveform and its amplitude. In other words, an FFT is a basic spectrum analyzer function to analyze frequency components of a waveform.

1. Acquire and display several cycles of the waveform.



Note: You can only display FFT waveforms for 2000 and 20K point record length waveforms.

2. Push FFT button.

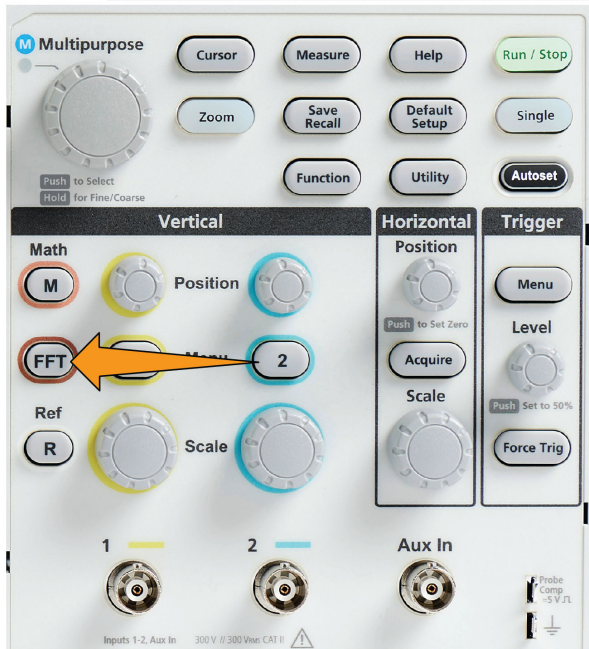

The oscilloscope shows the default FFT screen. The lower main screen shows the FFT waveform.

Use the **Vertical Position** knob of the source channel to move the FFT waveform up or down.

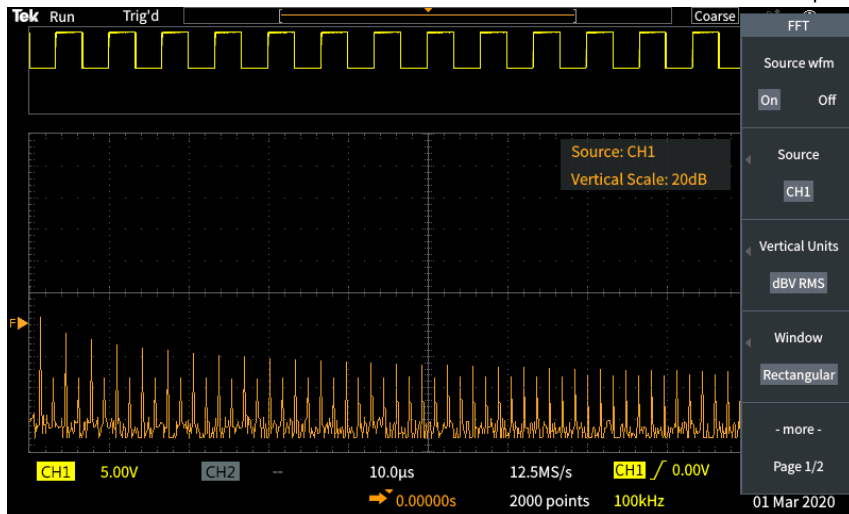

3. Push **Source wfm** side-menu button to toggle the display of the source waveform (at the top of the screen) **On** or **Off**.
4. Push the **Source** side-menu button and use **Multipurpose** knob to set the source to channel 1 or 2. The default source is whatever channel was selected before opening the FFT window.
5. Push the **Vertical Units** side-menu button and use the **Multipurpose** knob to select and click **dBV RMS** or **Linear RMS**.

Use the default **dBV RMS Vertical Units** scale to see a detailed view of multiple frequencies, even if the frequencies have very different amplitudes.

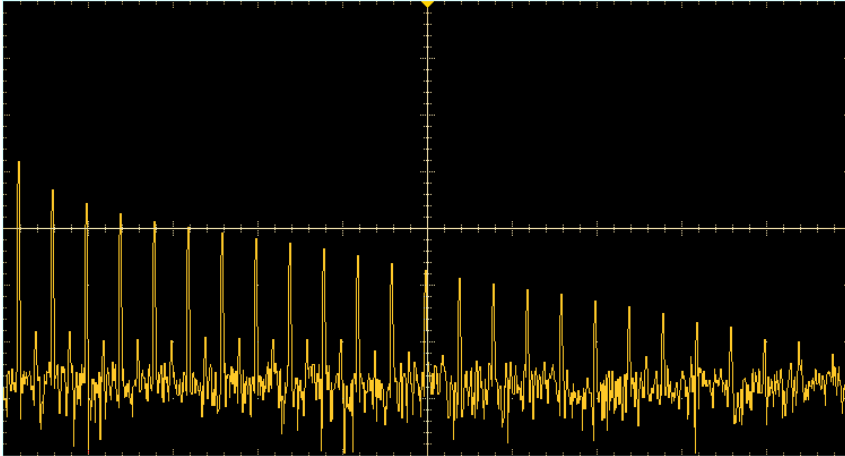

Use the **Linear RMS** vertical scale to see an overall view of how all frequencies levels compare to each other.

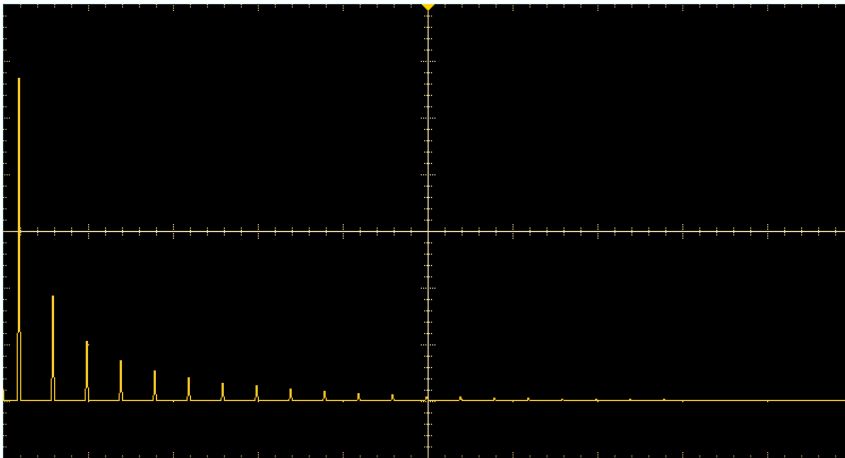

6. Push the **Window** side-menu button and use the **Multipurpose** knob to select and click **Hanning**, **Rectangular**, **Hamming**, or **Blackman-Harris**. See [About FFT windows](#) on page 98.
7. Push **-More- Page 1/2** side-menu button.
8. Push the **Horizontal Center Position** side-menu button and use the **Multipurpose** knob to position the FFT graph horizontally. The readout on the side menu is the frequency of the waveform point that is positioned on the center vertical graticule. Use this to quickly measure FFT 'spike' frequencies.

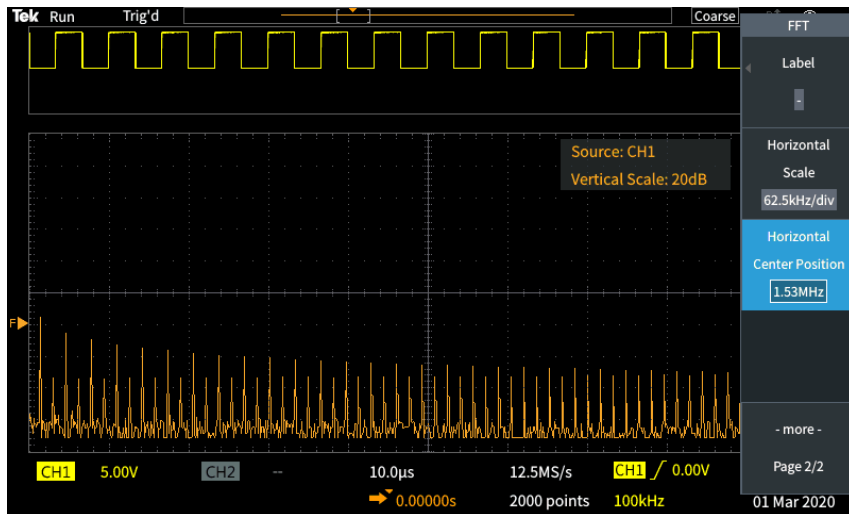

9. Push the **Horizontal Scale** side-menu button and use the **Multipurpose** knob to set the horizontal scale (frequency per major graticule division) value. Use this to expand or contract the FFT waveform to show more or less detail. The FFT waveform expands around the center cursor.

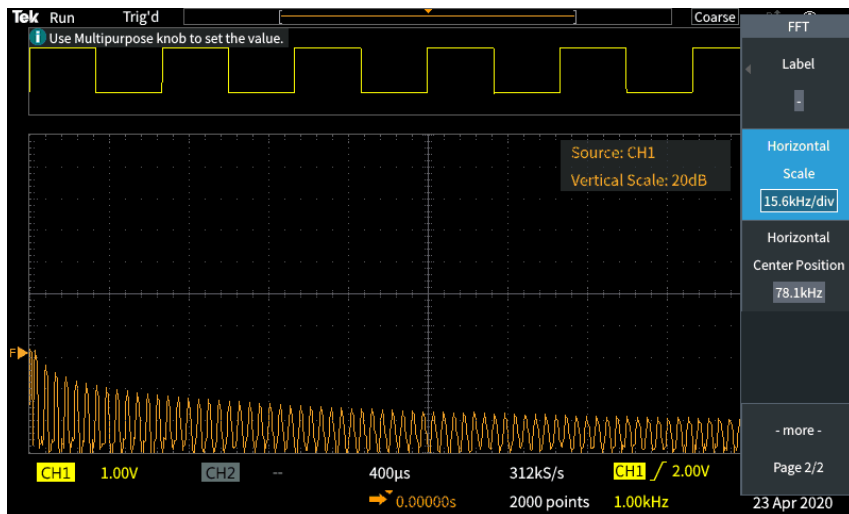

10. Push the **Cursors** front-panel button and use the cursors to take measurements.

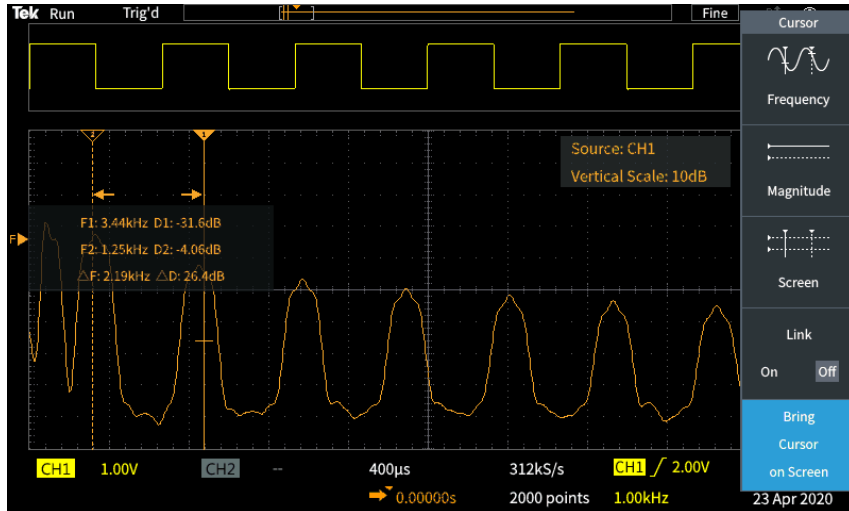

FFT tips

- You can only display FFT waveforms for 1000, 2000 and 20K record length waveforms.
- Use the **Vertical Position** knob of the source channel to change the vertical position of the FFT waveform.
- Use the **Vertical Scale** knob of the source channel to change the vertical size of the FFT waveform.
- Use cursors to measure frequencies and relative signal levels.
- Input signals that have a DC component or offset can cause incorrect FFT waveform component magnitude values. To minimize the DC component, use **AC Coupling** on the input signal.
- To reduce random noise and aliased components See [FFT and display waveform aliasing](#) on page 100. In repetitive or single-shot events, set the oscilloscope acquisition mode to average over 16 or more samples. Average mode attenuates signals not synchronized with the trigger.
- Do not use the **Average** acquisition mode if the source signal contains frequencies of interest that are not synchronized with the trigger rate.
- For transient (impulse, one-shot) signals, set the oscilloscope trigger conditions so that the transient pulse waveform is centered in the waveform record.

About FFT windows

The FFT algorithm applies a 'window' process to the source waveform record to 'shape' the record so that the start and stop values for the FFT waveform are close to the same amplitude. Starting and stopping the waveform at close to the same amplitude reduces adding artificial waveform that are not present in the actual signal. Using a window on the source signal results in an FFT waveform that more accurately represents the source signal frequency components.

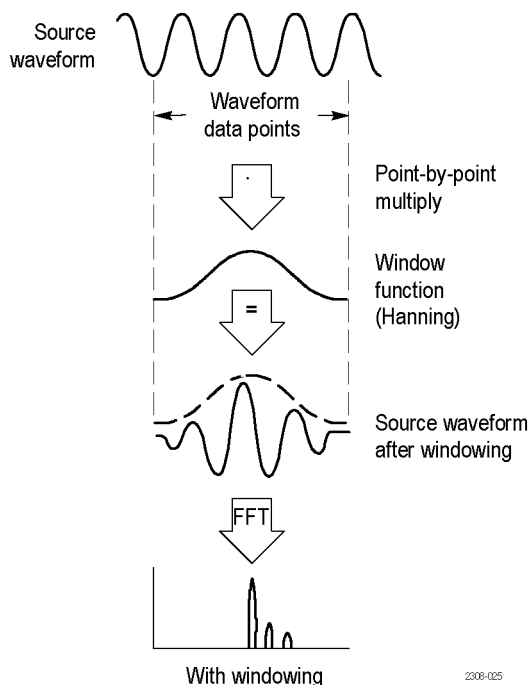

The different window shapes are trade-offs between frequency accuracy and magnitude accuracy. What you want to measure, and your source signal characteristics, help you to select which window to use. Use the following guidelines to select the best window for your signal analysis needs. The Hanning window is a good starting point for FFT measurements.

Table 10: FFT windows

Window type	Window 'shape'
<p>Hanning</p> <p>This is a very good window for measuring amplitude accuracy but less so for resolving frequencies.</p> <p>Use Hanning for measuring sine, periodic, and narrow band random noise. This window works on transients or bursts where the signal levels before and after the event are significantly different.</p>	
<p>Rectangular</p> <p>This is the best type of window for resolving frequencies that are very close to the same value but worst for accurately measuring the amplitude of those frequencies. It is the best type for measuring the frequency spectrum of nonrepetitive signals and measuring frequency components near DC.</p> <p>Use Rectangular for measuring transients or bursts where the signal level before and after the event are almost equal. Also, use this window for equal-amplitude sine waves with frequencies that are very close, and for broadband random noise with a relatively slow varying spectrum.</p>	
<p>Hamming</p> <p>This is a very good window for resolving frequencies that are very close to the same value with somewhat improved amplitude accuracy over the rectangular window. It has a slightly better frequency resolution than the Hanning.</p> <p>Use Hamming for measuring sine, periodic, and narrow band random noise. This window works on transients or bursts where the signal levels before and after the event are significantly different.</p>	

Table continued...

Window type	Window 'shape'
<p>Blackman-Harris</p> <p>This is the best window for measuring the amplitude of frequencies but worst at resolving frequencies.</p> <p>Use Blackman-Harris for measuring predominantly single frequency waveforms to look for higher order harmonics.</p>	

FFT and display waveform aliasing

FFT waveform problems occur when the oscilloscope acquires a signal that contains frequency components that are greater than the Nyquist frequency (the Nyquist frequency is 1/2 of the sample rate). The frequency components that are above the Nyquist frequency are undersampled and appear to "fold back," or reflect, around the right edge of the graticule, showing as lower-frequency components in the FFT waveform. These incorrect components are called aliases.

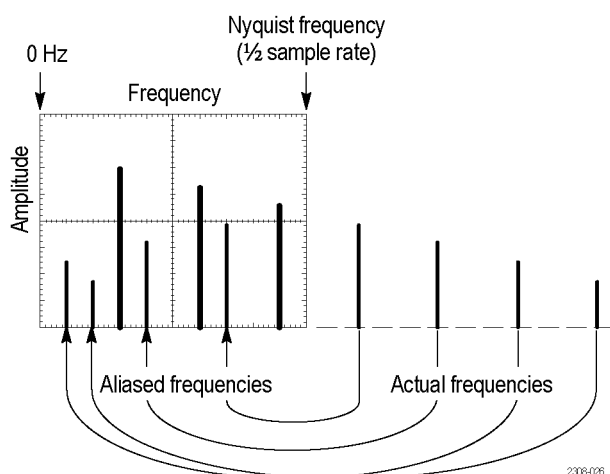

You can use the following methods to reduce or eliminate aliases:

- Increase the sample rate by adjusting the **Horizontal Scale** front-panel knob to a faster frequency setting. Since you increase the Nyquist frequency as you increase the horizontal sampling rate (samples/second), the aliased frequency components should appear at their proper frequency. If the increased number of frequency components shown on the screen makes it difficult to measure individual components, use the **Horizontal Scale** side-menu button in the FFT menu to display more detail of the FFT waveform.
- Use a filter on the input signal to limit the signal to frequencies below that of the Nyquist frequency. If the frequency components you are interested in are below the built-in 20 MHz bandwidth setting, push the **Vertical Menu** button and set the channel bandwidth to 20 MHz.

Displaying reference waveforms

A reference waveform is a waveform that you have stored in a nonvolatile memory location on the oscilloscope. You can use a reference waveform as a standard against which to compare other waveforms.

You can save channel, math, and FFT waveforms to reference memory. Reference waveforms remain in memory when the oscilloscope is powered off.

See the *Saving waveform data* topic to learn how to save waveforms to reference memory or external files. See [Saving waveform data](#) on page 105.

1. Push the **Ref** front-panel button.

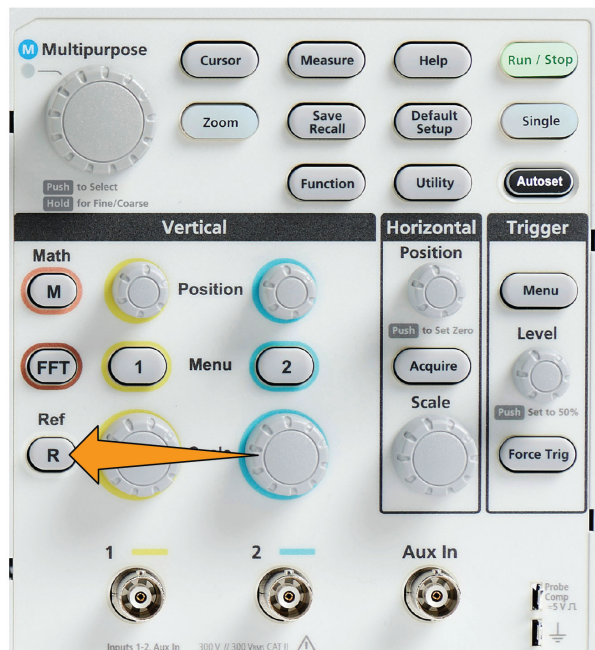

2. Push the **Ref1** or **Ref2** side-menu button to toggle displaying that waveform **On** or **Off**.

You can display both reference waveforms at the same time.

Reference waveform tips

- You cannot position or scale a reference waveform. You should set the source waveform position and scale before saving to a reference location, so that you have space on the screen to display both the reference waveform and the live signal.
- You can use **Zoom** to show more detail on reference waveforms.

How to view long record length waveforms Zoom

The **Navigation** controls (**Zoom** button, the **Zoom** side menu, and the **Multipurpose** knob) let you magnify and examine portions of a waveform (Ch1-Ch2, Math, Reference).

A zoomed display consists of two parts. The upper display shows the entire displayed waveform record and the position and size of the zoomed part in the waveform (in brackets) within the entire record. The lower display shows the zoomed view of the waveform (the part enclosed in brackets in the upper display).

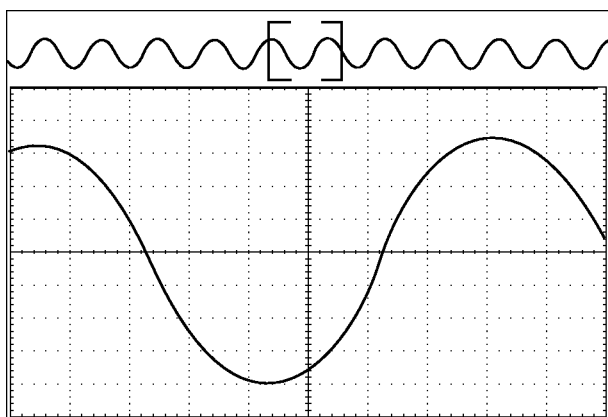

1785-154

Select the channel that you want to zoom.
Push Zoom.

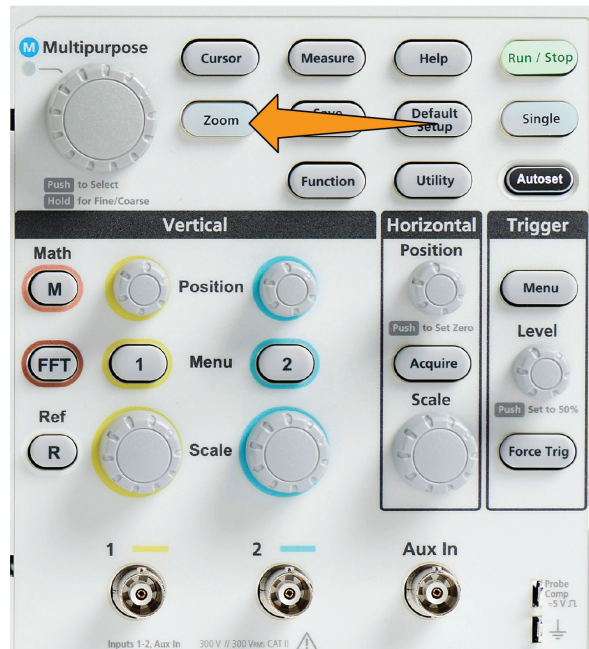

Push the Scale side-menu button and use the Multipurpose knob to adjust the size of the area to zoom (magnify).

Push the Position side-menu button and use the Multipurpose knob to adjust the position of the zoom area in the waveform record.

How to pan a waveform

While the zoom feature is on, you can use the pan feature to quickly scroll through the waveform. To use pan:

To pan a waveform, turn the **Multipurpose** knob when the side-menu button of **Position** is selected in the Zoom menu.

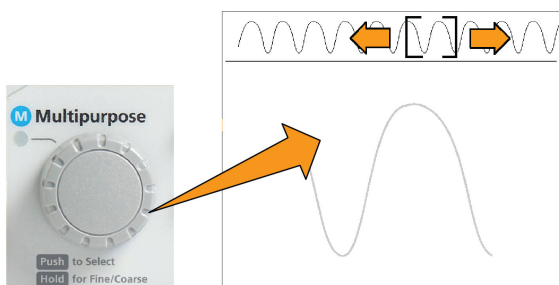

Turn the **Multipurpose** knob clockwise to pan forward. Turn it counterclockwise to pan backwards. The further you turn the knob, the faster the zoom window pans.

How to change the measurement password

Use this procedure to change the Measurement password. The measurement requires a password to enable or disable the measurement function.

1. Push **Utility**.

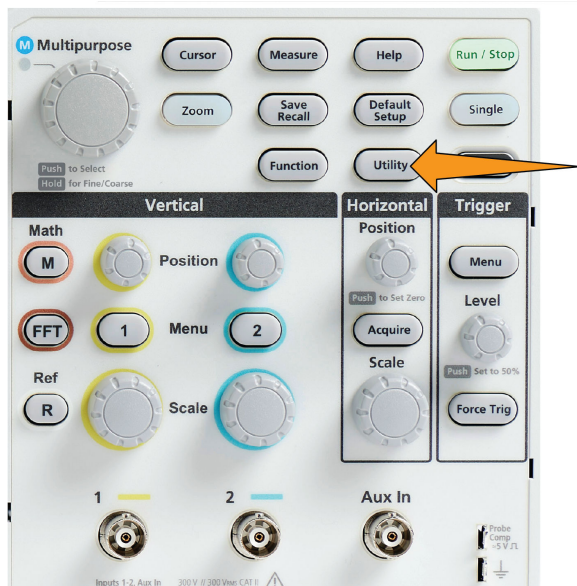

2. Push **Feature Enable** side-menu button.
3. Use the **Multipurpose** knob to select and click **Change Password**. The oscilloscope opens the **Change Password** entry screen.

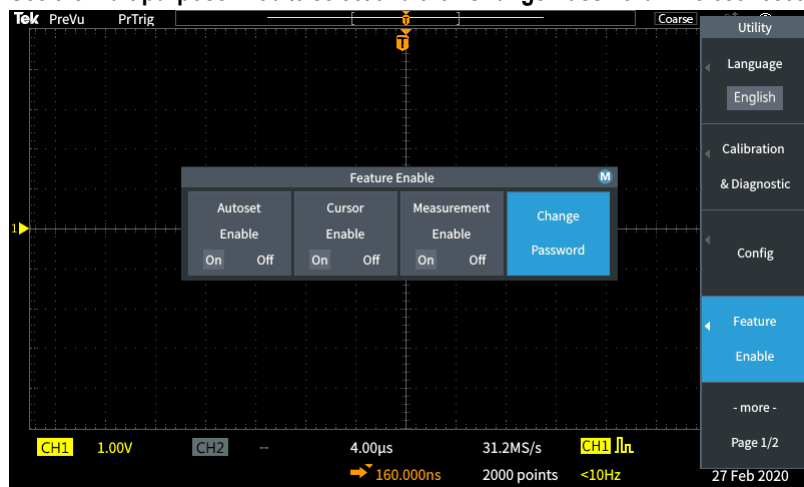

4. Use the **Multipurpose** knob and side-menu buttons to select the alphanumeric and enter characters for the current password.
5. Push **OK** side-menu button.
6. Use the **Multipurpose** knob and side-menu buttons to enter the new password to confirm it.
7. Push **OK** side-menu button.



Note: The measurement password can be changed using the PI commands. Refer to Programmer manual for detailed instructions.

Saving data

Saving screen images to a file

Use this procedure to save a screen image to a file on a USB drive. A screen image is a 'picture' of the oscilloscope screen. Screen images are useful to include in reports or to compare with other screen images over time.



Note: A screen image is different than waveform data. A screen image is a picture of the screen, and does not contain any data about the signals shown in the image. Waveform data is a file that contains the numeric values of all the sampled points in a single channel waveform. You cannot use a screen image file for further analysis, whereas you can load the data from a waveform file into other oscilloscopes, or into PC-based analysis programs to perform advanced signal measurements.

1. Install a USB drive.
2. Set up the display to show the waveforms and other readouts that you want to save.
3. Push the **Save Recall** front-panel button.

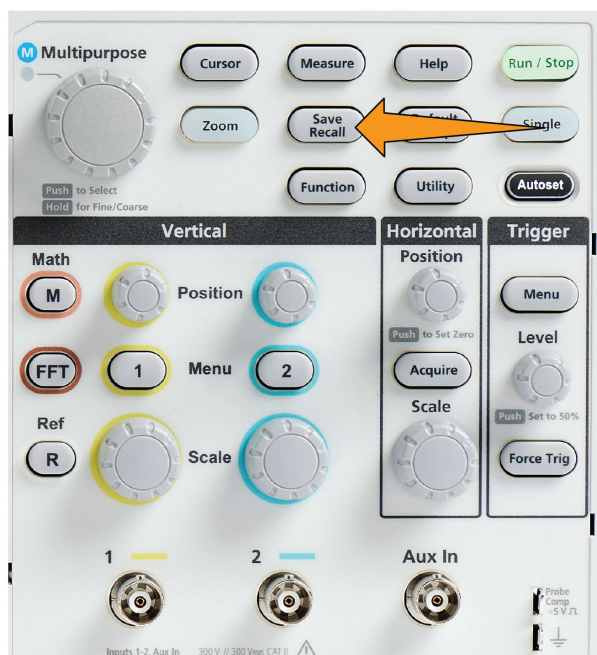

4. Push the **Action** side-menu button.
5. Use the **Multipurpose** knob to select and click **Save Image**.
6. Push the **Save As** side-menu button.
7. Select and click a graphical file format (**BMP**, **JPG**, or **PNG**) to save the screen image to an automatically-named file at the top level of the USB drive .

You can also set the **File Save** button to automatically save an image file to the USB drive. See [Saving files to USB with the Save File button](#) on page 106.

About saved image file formats

The image save function saves screen information to three common image formats.

- **BMP:** This bitmap format uses a lossless algorithm, and is compatible with most word processing and spreadsheet programs; this is the default. Creates the largest file size.

- **JPG:** This bitmap format uses a lossy compression algorithm, and is compatible with most word processing and spreadsheet programs. Creates the smallest file size.
- **PNG:** This bitmap format uses a lossless compression algorithm, and is compatible with most word processing and spreadsheet programs.

Saving waveform data

Use this procedure to save waveform data to a reference (**Ref**) memory location or an external file.

1. (Optional) Install a USB drive to save the waveform data to a file on the USB drive.
2. Acquire and display the waveform that you want to save.
3. Push the **Save Recall** front-panel button.

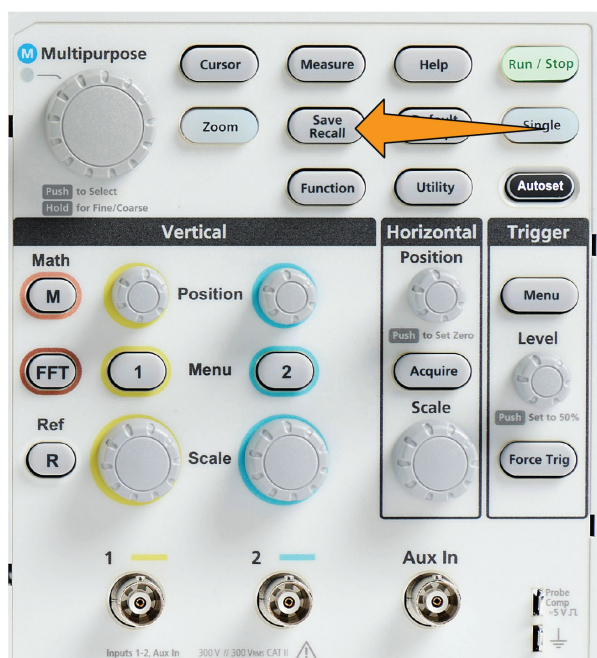

4. Push the **Action** side-menu button.
5. Use the **Multipurpose** knob to select and click **Save Waveform**.
6. To save waveform data to internal reference memory:
 - a. Push the **Source** side-menu button
 - b. Select and click the waveform data source (**CH1**, **CH2**, **Math**, or **FFT**).



Note: The selected waveform must be displayed on the screen to save waveform data.

- c. Push the **Save As** side-menu button.
 - d. Select and click **Ref1** or **Ref2**.
7. To save waveform data to a file on the USB drive:
 - a. Push the **Source** side-menu button
 - b. Select and click the waveform data source (**CH1**, **CH2**, **Math**, or **FFT**).



Note: The selected waveform must be displayed on the screen to save waveform data.

- c. Push the **Save As** side-menu button.
- d. Select and click **USB File (*.ISF)** or **USB File (*.CSV)** to save the waveform data to an automatically named file on the USB drive . See [About waveform data files](#) on page 107.

Saving oscilloscope setup information

You can save the oscilloscope internal settings to an internal memory location (setup 1–10) or to an external file on the USB drive. A setup file contains most of the oscilloscope settings, including vertical, horizontal, trigger, cursor, and measurement parameters. It does not include communications information, such as GPIB addresses. You can then use the setup data to quickly set the oscilloscope to take a certain measurement.

Use this procedure to save the current oscilloscope settings to a memory location or external file.

1. (Optional) Install a USB drive to save the setup data to a file on the USB drive.
2. Push the **Save Recall** front-panel button.

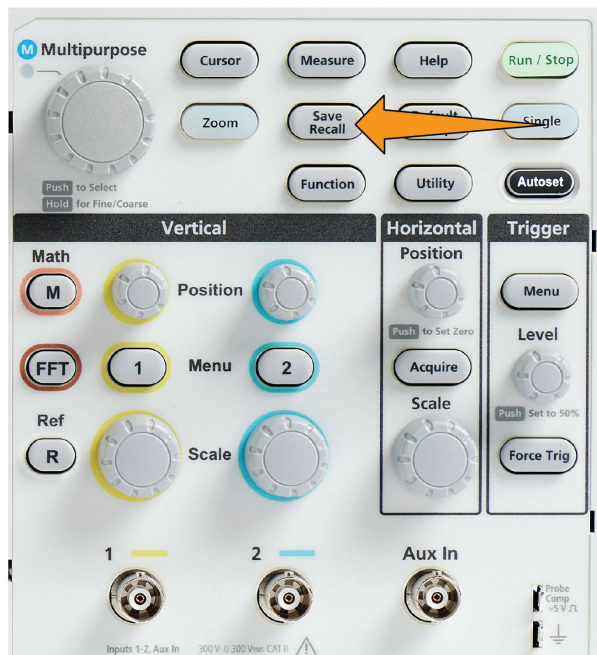

3. Push the **Action** side-menu button.
4. Use the **Multipurpose** knob to select and click **Save Setup**.
5. To save setup data to internal setup memory:
 - a. Push **Save As** side-menu button.
 - b. Use the **Multipurpose** knob to select and save the setup memory location (1-10).
6. To save setup data to a file on the USB drive:
 - a. Push **Save As** side-menu button.
 - b. Use the **Multipurpose** knob to select and click **USB File (*.SET file)** to save the waveform data to an automatically-named file at the top level of the USB drive. See [About automatically generated file names](#) on page 114

Saving files to USB with the Save File button

The **Save** button is a quick, one-push way to save a specified data files to the USB drive. After you have defined the save parameters with the **Save Recall** button and **Action** side-menu button, you can assign that save action to the **Save File** button. For example, if you assign **Save** to write waveform data to a USB drive, then each push of the **Save** button saves the current waveform data to the USB drive.



Note: The **Save** button only saves files to the USB drive. You cannot assign the **Save** button to save information to reference or setup memory, or to recall files from the USB drive.



Note: The oscilloscope saves files to the top level of the USB drive by default. You can use the **Change folder** button in the **File Utility** side menu to set the oscilloscope to save files to a specific location on the USB drive. See [Changing the default file save location on the USB drive](#) on page 111.

Files are saved to the USB drive using a specific naming convention. See [About automatically generated file names](#) on page 114.

1. Push the **Save Recall** front-panel button.

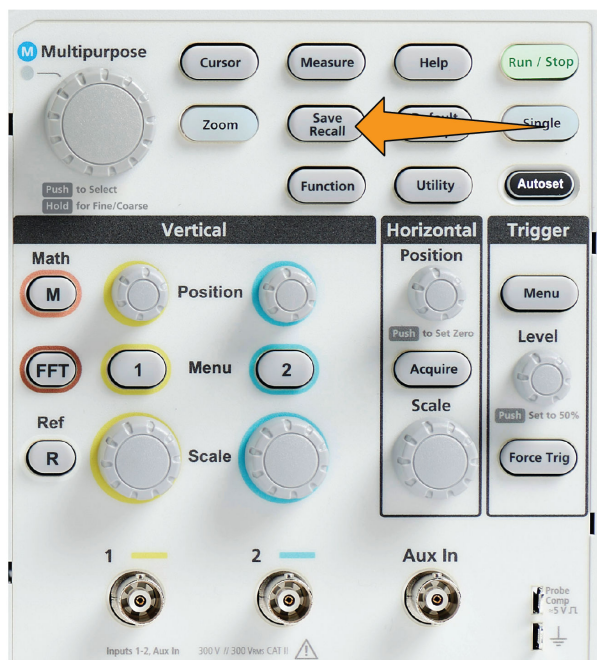

2. Push the **Settings** side-menu button.
3. Push the **Assign Save Button To** side-menu button.
4. Push the side-menu buttons for the action that you want to assign to the **Save** button (**Screen Image**, **Waveform**, or **Setup**). The save button is now assigned to that action.
5. For image or setup files: Use the **Save As** side-menu buttons to select the output format for the action you assigned to the Save button (BMP, JPG, or PNG for screen images; .SET for Setup).
6. For waveform files: Use the **Save As** side-menu buttons to select the signal source for saving waveforms (**CH1**, **CH2**, **Math**, **FFT**, **Ref1-2**).



Note: The **Assign To** button does not store the current save settings (such as file format or waveform source). The **Save** button uses the settings of the **Save As** side menu to save files.

About waveform data files

- **.ISF (Internal File Format):** Sets the oscilloscope to save waveform data from analog channels (and math and reference waveforms derived from analog channels), in internal waveform save file (ISF) format. This format is the fastest to write and creates the smallest-sized file. Use this format if you intend to recall a waveform to reference memory for viewing or measuring.
- **.CSV (comma separated values):** Sets the oscilloscope to save waveform data as a comma-separated data file compatible with popular spreadsheet programs. This file cannot be recalled to reference memory. A CSV file is significantly larger than an ISF file, and takes longer to write to the USB drive.
- To find out the channel for which the file was written, open the file in a text editor. The channel name is in the top few lines of the file.

Recalling data

Recalling oscilloscope setup information

Use this procedure to recall (load) oscilloscope settings from a memory location or external file and set the oscilloscope to those settings.

You can recall (load) saved setup data to quickly configure the oscilloscope to take a certain measurement. A setup file contains most of the oscilloscope settings, including vertical, horizontal, trigger, cursor, and measurement parameters. It does not include communications information, such as GPIB or LAN configuration.

1. (Optional) Install a USB drive to recall the setup data from a file on the USB drive.
2. Push the **Save Recall** front-panel button.

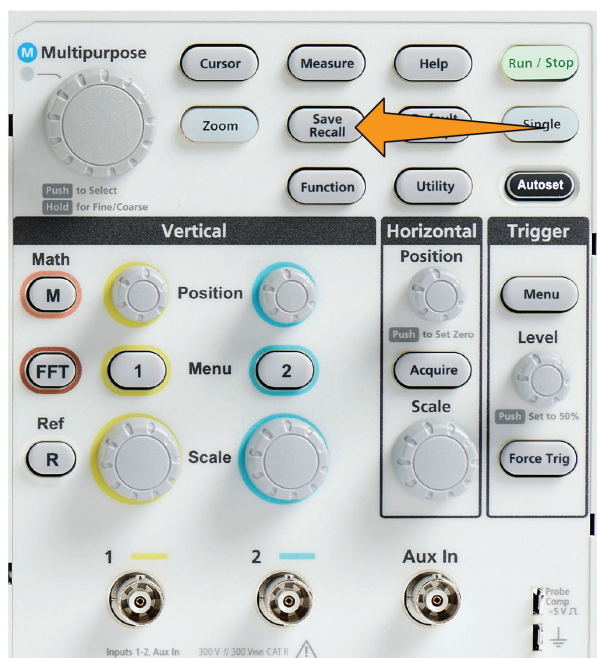

3. Push the **Action** side-menu button.
4. Use the **Multipurpose** knob to select and click **Recall Setup**.
5. To recall setup data from internal setup memory:
 - a. Push the **Recall From Setup** side-menu button.
 - b. Use the **Multipurpose** knob to recall the setup from the memory location (1-10).
6. To recall (load) setup data from a file on the USB drive:
 - a. Push the **Recall From USB** side-menu button.
 - b. Highlight the setup file (*.SET) to load.
 - c. Push the **Multipurpose** knob or the **Recall** side-menu button. The oscilloscope loads and implements the settings.

Recalling waveform data

Use this procedure to recall (load) waveform data from an external .ISF file to load into a reference memory location and display on the oscilloscope. The oscilloscope can only load .ISF waveform data files.

1. Install a USB drive that contains the .ISF waveform data file.
2. Push the **Save Recall** front-panel button.

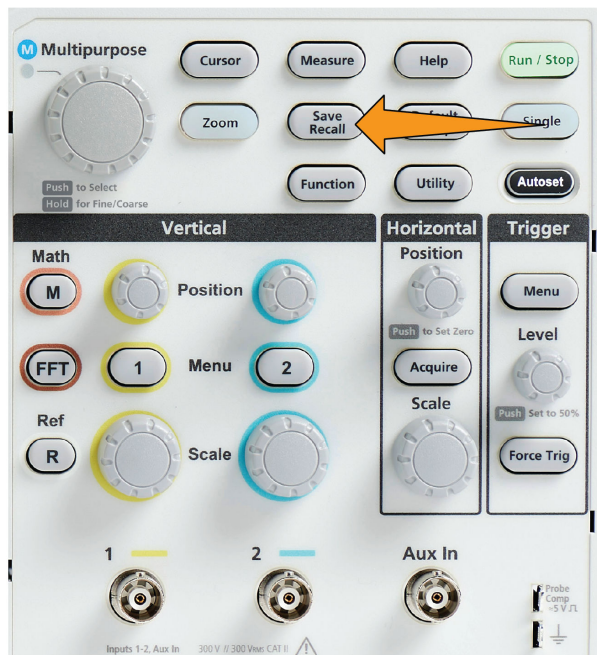

3. Push the **Action** side-menu button.
4. Use the **Multipurpose** knob to select and click **Recall Waveform**.
5. Push the **To** side-menu button.
6. Select and click **Ref1** or **Ref2**.
7. Push **Select File** side-menu button to open the File Utility pane.
8. Use the **Multipurpose** knob to select the waveform file (*.ISF). The oscilloscope loads the waveform data into the selected reference memory.

Using the USB file utility functions

Overview of the File Utility pane

To open the **File Browser** pane, push the **Save Recall** front-panel button and push the **File Browser** side-menu button.

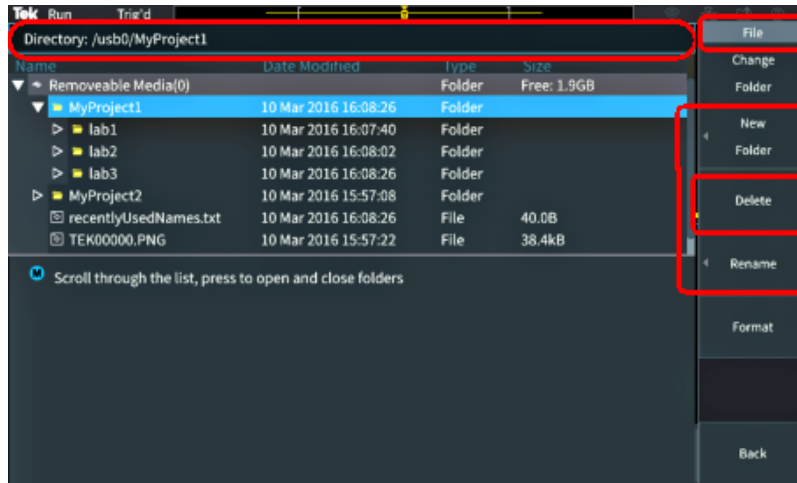

- The **Directory** field lists the path for the highlighted folder or file. This is also the field you use to enter text to create or rename files or folders.
- The area below the Directory field shows the files and folders. Use the **Multipurpose** knob to highlight a name. Push the **Multipurpose** to open or close a folder. Folders are marked with a ► when closed, and with a ▼ when that folder is open.
- The **File** side-menu buttons perform the indicated file utility functions. **Change Folder**, and **Delete** directly perform the indicated tasks.
- **New Folder** and **Rename** open the character entry field, keyboard, and side-menu buttons, shown in the following image.

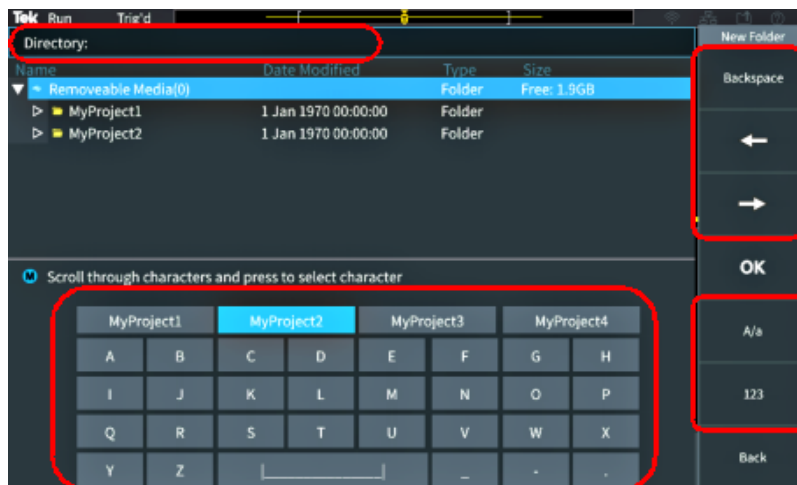

- Use the **Multipurpose** knob to select and click a recently created name (listed at top of the characters list), or highlight the individual letters of the name that you want to enter. Then push the **Multipurpose** knob to add that letter to the **Directory** field. Repeat this process to enter the entire name.



Note: If you are renaming an image, waveform, or setting file, you do not need to add the extension name when renaming the file.

- Use the upper side-menu buttons to delete the character to the left of the cursor (**Backspace**), or move the cursor left or right in the **Directory** field.

- Use the lower side-menu buttons to show upper-or lower-case letters on the keyboard or show a numeric keypad.
- Push the **OK** side-menu button to create or rename the file or folder with the name in the **Directory** field.

Changing the default file save location on the USB drive

By default, the oscilloscope saves image, waveform, and setup files to the top directory of the USB drive. Use this procedure to select a different default save folder on the USB drive in which to save files.

1. Push the **Save Recall** front-panel button.

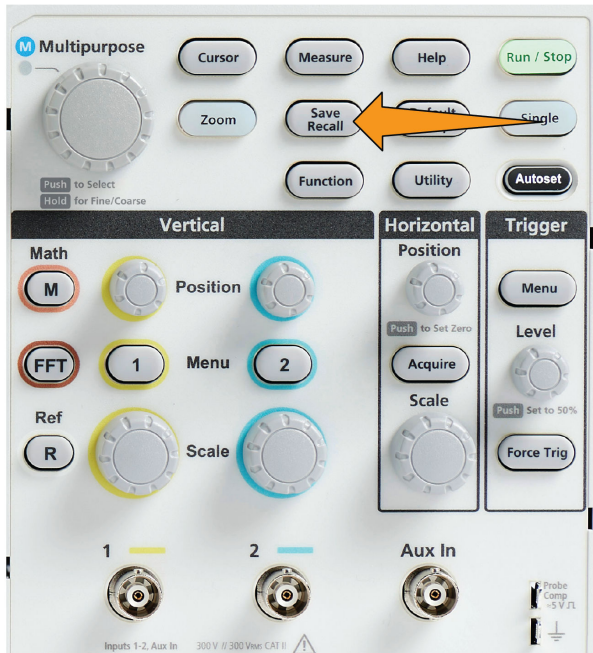

2. Push the **File Browser** side-menu button.
3. Use the **Multipurpose** knob to navigate to and highlight a folder in which to save files.
4. Push **Back** side-menu button.
5. Push the **Settings** side-menu button.
6. Push the **Assign Save Button To** side-menu button.
7. Push the **Change Folder** side-menu button. Saved files will now be saved to this location.

Default save folder location rules

- The new save folder location remains in effect until:
 - A new location is set with the **Change Folder** button.
 - The oscilloscope is powered down. The save location changes back to the top level of the USB drive.
- The following actions do not change the file save location. The oscilloscope shows an error message when it tries to save the file to a location that it cannot find. Use the **Change Folder** function to change the working folder location to an existing folder and try the save operation again.
 - Deleting the save location folder.
 - Removing or inserting a USB drive.
 - Pushing the **Default Setup** front-panel button.

Creating a new folder on the USB drive

Use this procedure to create a new folder on the USB drive.

1. Push the **Save Recall** front-panel button.

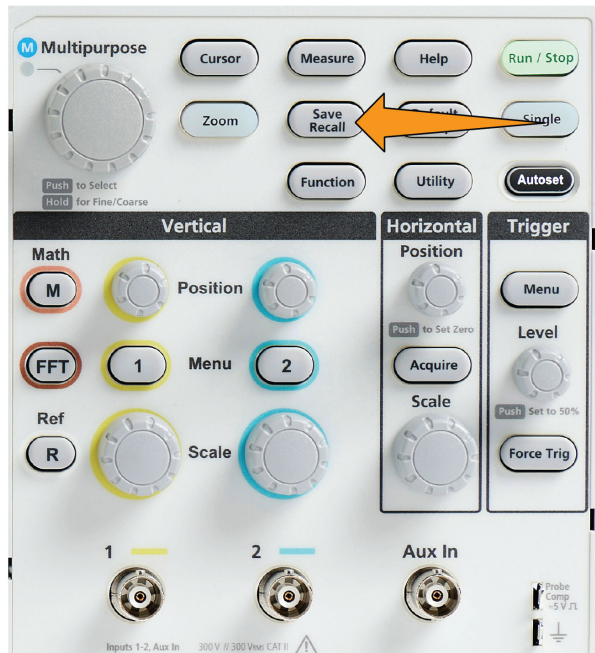

2. Push the **File Browser** side-menu button.
3. Use the **Multipurpose** knob to navigate to the location at which to create the new folder.
4. Push the **New Folder** side-menu button.
5. Use the **Multipurpose** knob to select and click a recently created name (listed at top of the characters list), or enter the folder name using the **Multipurpose** knob and side-menu buttons to scroll through and highlight letters, numbers, and valid characters in the list.
Click the **Multipurpose** knob to enter the highlighted character. The characters that you enter are shown at the top of the file pane.
6. Repeat step 5 on page 112. until you have entered the folder name.
7. Push the **OK** side-menu button to add the new folder name to the USB drive.



Note: There are four names at the top of the character list (default values are MyProject1-4). These names will change to show the most recent file or folder names that you have created. These names change back to the default values when you power off the oscilloscope or push the **Default Setup** front-panel button.

Folder creation tip

If you need to create many folders on a USB drive, it is faster to insert the USB drive into a PC and use the standard Microsoft Windows or other OS folder creation utilities.

Deleting files or folders from the USB drive

Use this procedure to delete files or folders from the USB drive.

1. Push the **Save Recall** front-panel button.

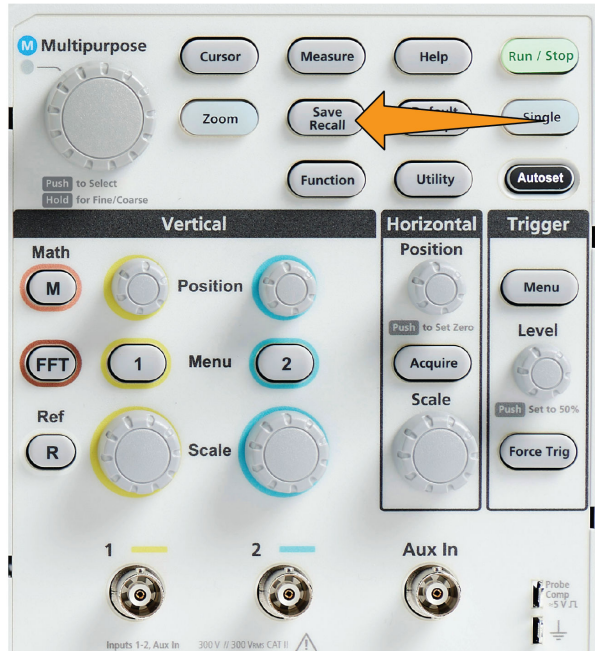

2. Push the **File Browser** side-menu button.
3. Use the **Multipurpose** knob to navigate to and highlight a file or folder name to delete.
4. Push the **Delete** side-menu button. the oscilloscope asks you confirm the delete action.
5. Highlight **Yes** (to delete) or **No** (to cancel the delete).
6. Push the **Multipurpose** knob to delete the file or folder.



Note: Deleting a folder also deletes all files and subfolders contained in that folder.



CAUTION: Deleting a file or folder on the USB drive does not remove the data on the drive. It deletes the FAT table entries for the names of the files and folders and marks the memory as available. If you have critical or secure data that must be removed from the USB drive, connect the USB drive to a PC and use a file 'shredding' program to replace the file data with zeros.

Renaming files or folders on the USB drive

Use this procedure to rename files and folders from the USB drive.

1. Push the **Save Recall** front-panel button.

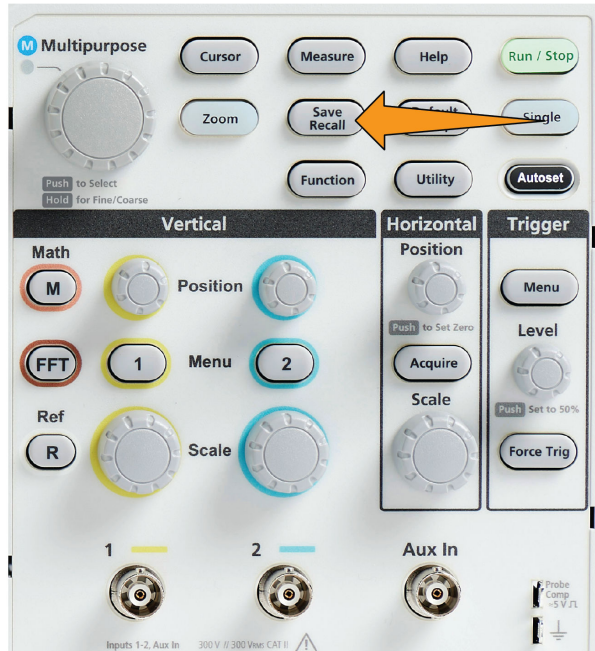

2. Push the **File Browser** side-menu button.
3. Use the **Multipurpose** knob to navigate to the location at which to create the new folder.
4. Push the **Rename** side-menu button.
5. Select and click a recently created name (listed at top of the characters list), or enter the folder or file name using the **Multipurpose** knob and side-menu buttons to scroll through and highlight letters, numbers, and valid characters in the list.

Push the **Multipurpose** knob to enter the highlighted character. The characters that you enter are shown at the top of the file pane.

6. Repeat step 5 on page 114. until you have entered all characters of the folder name.
7. Push the **OK** side-menu button to add the new folder name to the USB drive.



Note: You do not need to add the file extension name (.ISF, .SET, and so on) when renaming an image, waveform, or setting file.

File folder renaming tip

If you need to rename many files or folders, it is faster to insert the USB drive into a PC and use the standard Microsoft Windows or other OS file renaming utilities.

About automatically generated file names

The oscilloscope automatically creates a numbered file name for the files that it saves to the USB drive.

The naming convention is TEKXXXXX.<ext>, where:

- XXXXX is an integer from 00000 to 99999
- <ext> is the file type (.PNG, .BMP, or .JPG for screen image files; .SET for setup files; .ISF or .CSV for waveform files)

To create a new file name, the oscilloscope scans the USB drive to determine the highest-numbered file name present for the file type being saved. The oscilloscope then increments that number and uses it for the new file name. For example, the first time you save a file, the oscilloscope creates the file name TEK00000. The next time you save the same type of file, the new file is named TEK00001.

Image setting and waveform file tips

- If there are nonsequential jumps in the file numbering, such as TEK00001, TEK00002, TEK00005, the oscilloscope uses the highest-numbered file as the starting point for new file names (TEK00006 in this example).
- If you select a different USB drive or folder location, the oscilloscope creates the file number based on the files present in that USB drive or folder. For example, if you select the save folder as /usb0/MyProject1, which contains file TEK00006.png, the next saved .png file in that folder is named TEK00007.png.
- To determine the channel or waveform type (**Math, FFT, Ref**) of a saved waveform file, open the waveform file (.CSV or .ISF) in a text editor. The channel name or waveform type is at or near the top of the file structure.

Erasing data from oscilloscope memory (TekSecure)

The TekSecure™ function erases all setup and waveform information saved in the nonvolatile oscilloscope memory. If you have acquired confidential waveform data on your oscilloscope, or use the oscilloscope in a restricted area, use the TekSecure function to erase memory and setup data before you return the oscilloscope to general use.

The TekSecure function:

- Replaces all waveforms in all reference memories with zero (0) values
- Replaces the current front-panel setup and all stored setups with the default setup
- Displays a confirmation or warning message, depending on whether the verification is successful or unsuccessful

1. Push **Utility**.

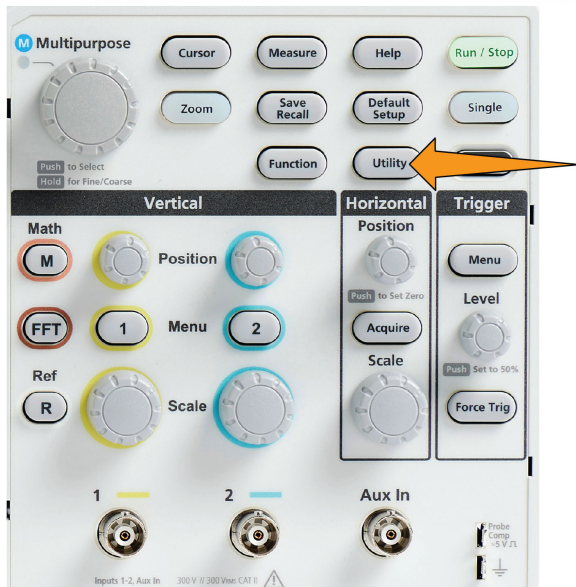

2. Push **-More- Page 1/2** side-menu button.
3. Push the **TekSecure Erase Memory** side-menu button.
4. This procedure will erase all non-volatile RAM. All reference waveforms and saved setups will be erased. Calibration constants will be retained and the system will be rebooted. This will take approximately 5 minutes.
5. Select and click **Yes** to start the TekSecure procedure. The erase operation takes up to three minutes.
6. To cancel the procedure, select **No** or push the **Menu Off** button.
7. When the TekSecure procedure is finished, the oscilloscope automatically powers off and then powers back on.

Setting or viewing USB Device port parameters

Disabling the USB Device port

Use this procedure to disconnect the **USB Device port** access, to prevent remote access to the oscilloscope over the USB Device port connection.



Note: This function only disables the rear-panel **USB Device port**; it does not disable the **USB Host ports** on the front and rear panel.

1. Push **Utility** front-panel button.

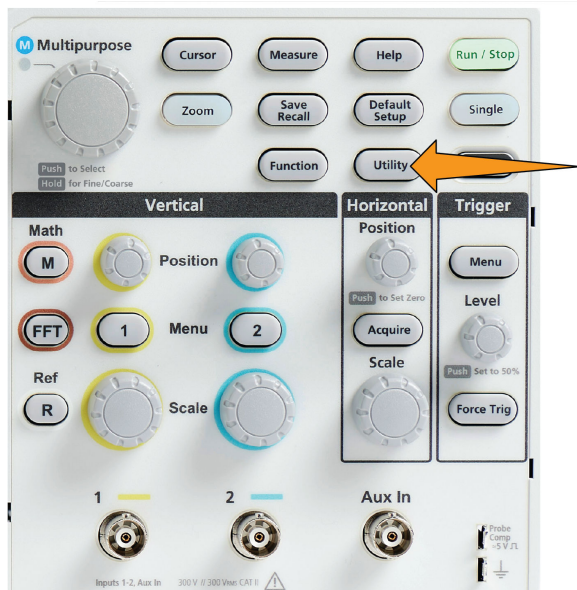

2. Push the **Config** side-menu button.
3. Use the **Multipurpose** knob to select and click **USB**.
4. Select and click **Disabled (Off Bus)**.

Selecting which device is attached to the USB Device port

Use this procedure to select which device is connected to the **USB Device port**. A supported device does not need to be connected to the **USB Device port** to select that item.



Note: The current software release only supports a PC connection.

1. Push **Utility** front-panel button.

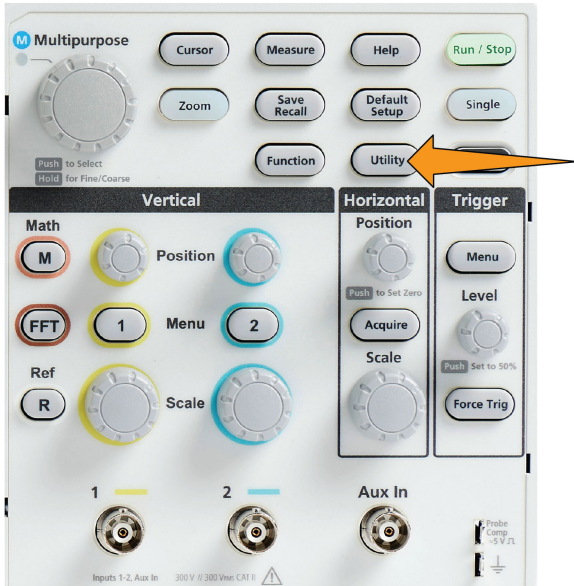

2. Push the **Config** side-menu button. The USB menu item (at top of the **Config** side menu) shows the USB Device port connection status.
3. Use the **Multipurpose** knob to select and click **USB**. The **USB Device Port** menu lists available devices to which you can connect. A grayed out menu item cannot be selected.
4. If the USB Device port is **Disabled (off Bus)**, select and click the device to which you want to connect.

Viewing the USBTMC information

USBTMC stands for USB Test & Measurement Class. USBTMC is a protocol that allows USB devices to communicate using IEEE488 style messages. This protocol lets you run your GPIB software applications on USB hardware. Use this screen to view protocol registration information. There are no active controls on this screen.

1. Push **Utility** front-panel button.

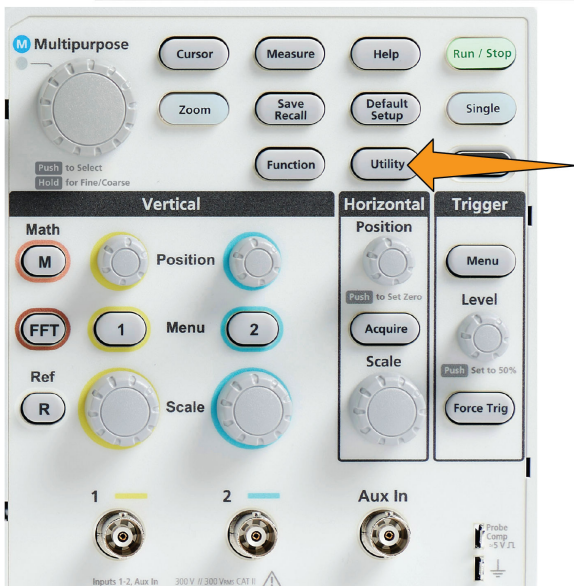

2. Push the **Config** side-menu button.
3. Use the **Multipurpose** knob to select and click **USB**.

4. Select and click **USBTMC Configuration**. The oscilloscope shows the USBTMC protocol registration information.

Appendices

Installing new firmware on the oscilloscope

Tektronix releases new oscilloscope firmware to improve existing functions or add new functions. Complete the following steps to install new firmware in the oscilloscope.

1. Go to tek.com.
2. Click **Downloads**. In the Downloads menu, select DOWNLOAD TYPE as Software and enter TBS1000C in the MODEL OR KEYBOARD field and click **SEARCH**.
3. Select the latest version of the software and follow the instructions to download. Download the latest firmware for your oscilloscope on your PC.
4. Unzip the files and copy the TBS1000C.TEK file into the root folder of a USB flash drive.



Note: TBS1000C.TEK file is supported ONLY for TBS1052C, TBS1072C, TBS1102C and TBS1202C.

5. Power on the oscilloscope.
6. Insert the USB flash drive into the front-panel USB port on your oscilloscope.
7. Push the **Utility** button.

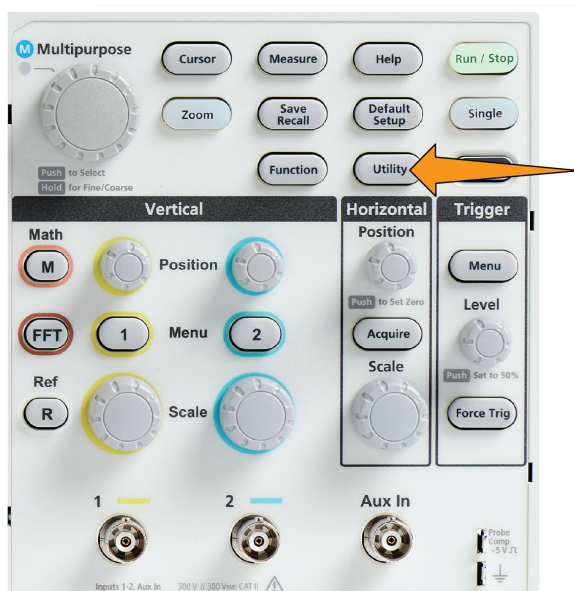

8. Push **-More- Page 1/2** side-menu button.
9. Push the **Update Firmware** side-menu button. Screen shows **Update Firmware** message.
10. Turn the **Multipurpose** knob to select **Yes**, then click the **Multipurpose** knob to install the firmware.
11. Follow the on-screen instructions.



Note: Do not power off the oscilloscope or remove the USB flash drive until the oscilloscope finishes installing the firmware. It displays a message saying it is OK to turn off the oscilloscope.

12. When the firmware install is finished, power off the oscilloscope, remove the USB drive, and power on the oscilloscope. Let the oscilloscope power-up to the oscilloscope screen.
13. To confirm the firmware installation:
 - a. Push the **Utility** button.
 - b. Push the **Config** side-menu button.
 - c. Use the **Multipurpose** knob to select and click **System Status** to open the System Status message screen.

- d. Check that the software version number shown on the screen is the same version that you just installed.

Running diagnostic tests

Use this procedure to test instrument functional modules.



Note: Running self test, resets the oscilloscope settings. Save the current setup to memory or a file, if you do not want to lose the current settings.



Note: Remove all probes and cables from the oscilloscope inputs.

1. Push the **Utility** button.

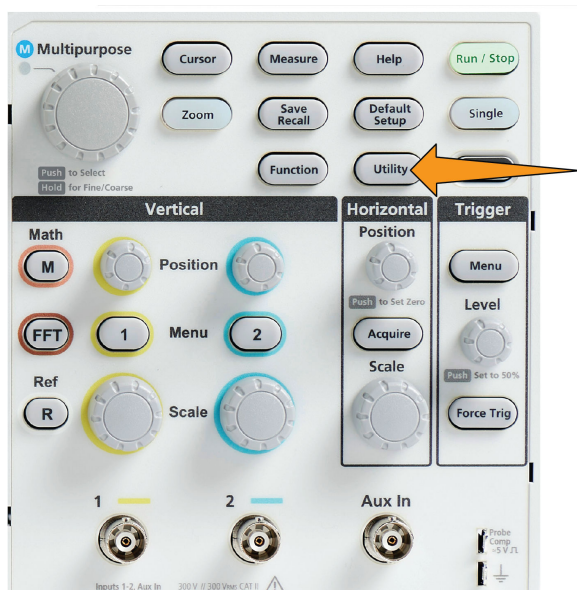

2. Push the **Calibration & Diagnostic** side-menu button.
3. Turn the **Multipurpose** knob to choose **Diagnostics**, then click the **Multipurpose** knob to select.
4. Push the **Self Test** side-menu button to display the **Self Test** menu and **Self Test Results** readout.
5. Turn the **Multipurpose** knob to select **Run Self Test**, then click the **Multipurpose** knob to start testing using the default settings. the self test takes a few seconds to run.
6. Use the other **Self Test** menu items to refine how to run the self test; you can run the tests a specified number of times (**Loop Times**), run tests forever (**Loop Forever**), run tests until a test fails and stop testing (**Loop Until Fail**), or run a test on a failed tests (**Loop On Failure**).



Note: The oscilloscope resets to the factory default settings after running the self tests.

Courseware on-instrument education and training

Run guided lab exercises right on your oscilloscope. Read overview theory and procedures, and capture your lab results right there as well.

Create new course materials on a PC with separate PC-based Courseware software, which you can download from www.tek.com/ software. After you create the course materials, you can distribute them to supported oscilloscopes using a USB drive or from the TekSmartLab software server.



Note: TekSmartLab uses wireless connectivity to connect multiple oscilloscopes and other test bench instruments to a central server and software interface. Using The TBS1000C series oscilloscope with TekSmartLab requires either a Wi-Fi Transceiver

USB dongle (Option TEKUSBWIFI) or a communication box to connect to the TekSmartLab server. See the **Scope Intro** topic on TekSmartLab for more information (**Help ► Scope Intro ► TekSmartLab**).

You can also go to the Courseware Web page at www.tek.com/courseware to download courseware files that others have created and uploaded to share.



Note: Courseware files are compressed using .zip format. Unzip the Courseware file and copy the uncompressed files to a USB drive.

Courseware file content information

- A Courseware file can contain up to 12 courses, with up to 100 MB total of course file storage available on the oscilloscope.
- Each course can have up to 14 labs, with each lab having overview and procedure files.
- Courses can contain example waveforms, data results, and waveform masks for student reference use.
- Refer to the Courseware and TekSmartLab documentation for more information on these applications. You can download electronic versions of these manuals from the Tektronix Web site (www.tek.com).

Loading a courseware file from a USB drive

Use this procedure to load a Courseware file. A Courseware file can have up to 12 courses. Each course can contain up to 14 labs.

1. Insert the USB drive that contains the course folder into the front-panel USB connector.
2. Push the **Utility** button.

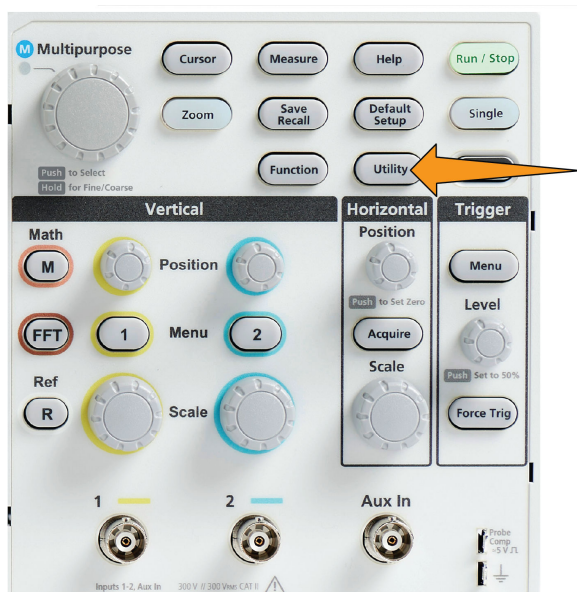

3. Push **-More- Page 1/2** side-menu button.
4. Push the **Update Course** side-menu button.
5. Use the **Multipurpose** knob to scroll through the file list and open the course folder to load. Folder and file names are shown in the **Directory** field at the top of the screen as you highlight each one.
6. Look for and highlight the **folder** that contains the file with the .workspace extension.
7. Push the **Change Folder** side-menu button to temporarily change the working folder to this location for reading the courseware files. The selected folder is highlighted in the list.
8. Push the **Upload Course** side-menu button to load the course into your oscilloscope. The oscilloscope displays a brief message saying that the file loaded successfully.

Dealing with error message

If you get the “No course material package files found” error message, make sure that you selected the folder that *contains* the .workspace file, and not the .workspace file itself, or any other folders that may be in the Courseware folder.

In the following image, the .workspace file (colored blue) is part of the ST_AFG_EN_MathAddition_PKG folder (green boxes), so you would highlight ST_AFG_EN_MathAddition_PKG to load this course. The Package_RSZI folder (red box) is a subfolder of ST_AFG_EN_MathAddition_PKG.

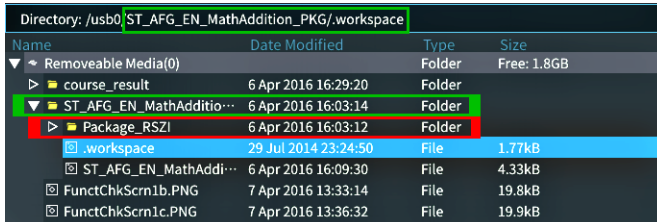

If you still get a load error message, try downloading the courseware file again and reload it.

Running Courseware lab exercises

You can access the lab content by pushing the **Course** button located on the on the front panel. Use the oscilloscope’s soft keys and the **Multipurpose** knob to access up to 12 courses, which can have up to 14 labs each.

Once you choose a lab, you can review the overview section, perform the lab using the step-by-step procedure, collect data, check and save the data results, and generate reports that show the waveforms created for each step.

Prerequisite: You have loaded a course on the oscilloscope.

1. Push the **Help** front-panel button.

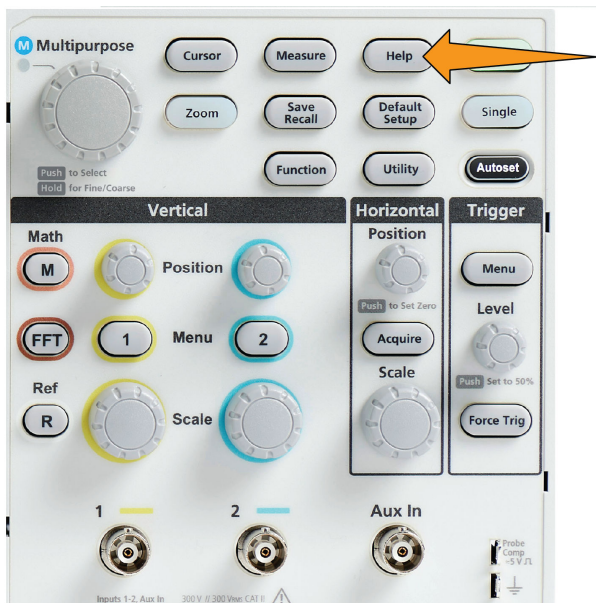

2. Push a side-menu button to select a course from those listed. The main screen area lists the labs that are available for that course.
3. Turn the **Multipurpose** knob to select and click the lab to run (if there is more than one lab).
4. Push the **Overview** side-menu button to read a high-level description of what this lab will teach you.
5. Push the **Procedure** side-menu button. Follow the instructions in the procedure:

- If a step says to compare your results, push the **Data Collection** side-menu button, push the **Step** side-menu button, use the **Multipurpose** knob to select the step number, and push the **Show Reference** side-menu button to **On**. The oscilloscope shows the reference material associated with that step.
- If a step says to show a waveform mask, push the **Data Collection** side-menu button, push the **Step** side-menu button, use the **Multipurpose** knob to select the step number, and push the **WFM Mask** side-menu button to **On**. The oscilloscope shows a reference waveform mask and a readout that counts the number of waveform mask errors (pass= the waveform is within the waveform mask area; Fail = part or all of the waveform is out of the mask area).
- If a step says to save a result, push the **Data Collection** side-menu button, push the **Step** side-menu button, use the **Multipurpose** knob to select the step number, push the **Data Type** side-menu button, and select the type of data to save (Measure(ment), screen Image, or waveform CSV). Then push the **Save Result** side-menu button. The oscilloscope saves the result to temporary memory.



Note: Results that you collect while running a lab are stored in temporary memory on the oscilloscope. Results are not saved permanently until you save a report to the USB drive. Make sure to save results to a report

6. Save lab results to a report file on the USB drive. See [Saving Courseware lab results](#) on page 124.

Saving Courseware lab results

Use this procedure to save your results to a report when you are done running Courseware courses and labs.

1. Push the **Report** side-menu button. Use the resulting side-menu buttons and the **Multipurpose** knob to enter a report identifier name.
2. Push the **OK** side-menu button. The oscilloscope creates and shows the report on the screen. If the report has any errors or is missing information, push the **Back** side-menu button and redo the step or steps that are missing information, and rerun the **Report** procedure.
3. If the report is OK, push the **Save** side-menu button. The oscilloscope saves the report to the USB drive.
4. To confirm the report was written, push **Save Recall** side-menu button, push File Utility side-menu button, search for and open the course_result folder, search for and open the folder for the active course, search for and open the folder of the lab name, and verify that there is a file called report.html.

The oscilloscope controls

The front panel has menu buttons and control knobs for the functions that you use most often. The following sections provide a high-level description of the controls and what they do. Use the text links within these sections to go to sections that contain more information about that control.

The Navigation controls

The buttons or knobs control waveforms, cursors, and other data input.



- The **Multipurpose** knob lets you select and click menu or other choices, to move a cursor, and to set a numerical parameter values for a menu item.



A **M** icon on a menu, message, or dialog box means to use the **Multipurpose** knob to interact with that item.

Turn the knob to highlight a menu item or control a screen object (such as a cursor, or when entering file name characters).

Push the knob to select or enter a highlighted menu item, switch between cursors, or activate a menu field to enable entering values.

- The **Cursors** button toggles on and off displaying cursors on the screen.

Turn the **Multipurpose** knob to change the position of the active cursor (solid line). Push the **Multipurpose** knob to change the active cursor. See [Using cursors to take manual measurements](#) on page 88.

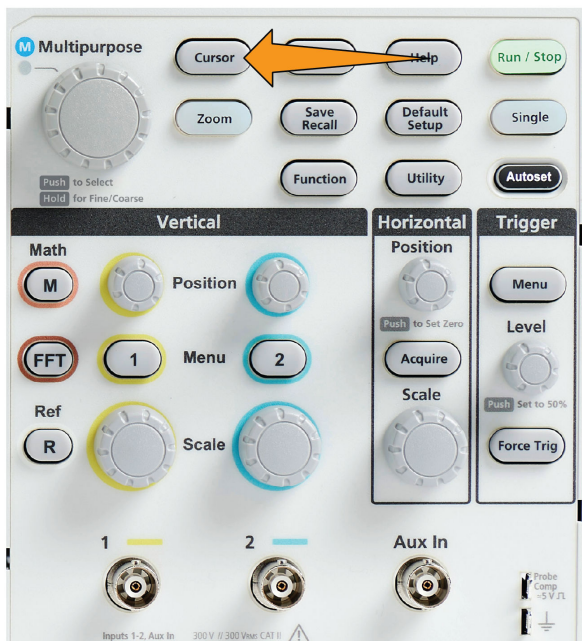

- The **Fine** knob sensitivity in the **Function** button enables making fine adjustments with the **Multipurpose** knob, vertical and horizontal **Position** knobs, vertical **Scale** knob, and the trigger **Level** knob.

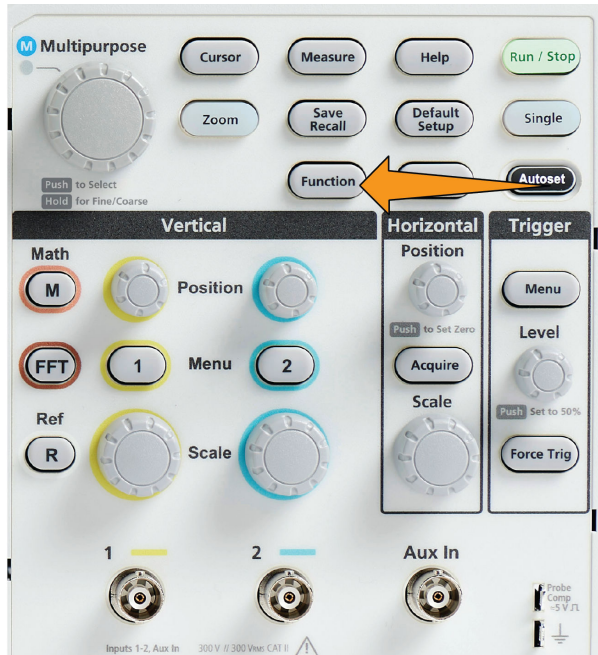

⚠ Note: You can also switch between Fine and Coarse by pressing and holding the Multipurpose knob.

- The **Zoom** button displays a magnified waveform. See [How to view long record length waveforms Zoom](#) on page 101.

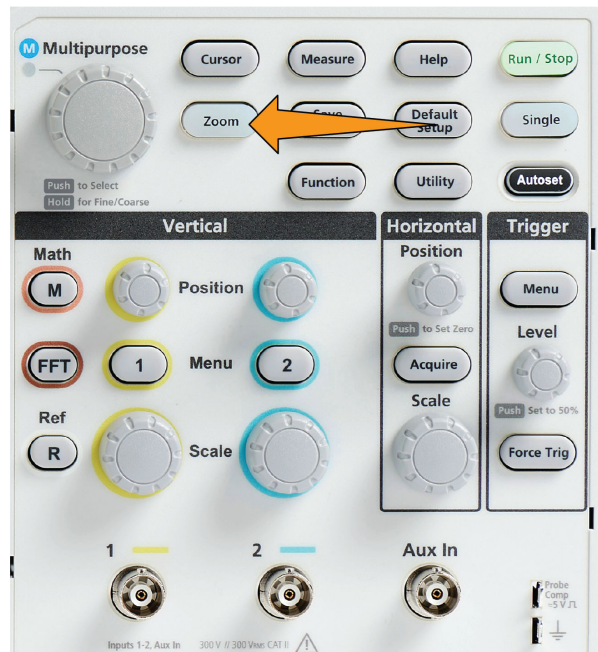

The Horizontal controls

The **Horizontal Position** knob adjusts the trigger point location left or right relative to the acquired waveform record.



Push the **Position** knob to return the trigger point to the center of the screen (center vertical graticule).

 **Note:** You can choose the **Fine** knob sensitivity in the **Function** button (**Navigation** controls) to enable smaller adjustments with the position knob.

The **Acquire** button opens the menu that you use to set the acquisition mode and adjust the record length.

The Trigger controls

The Trigger controls set when the oscilloscope starts acquiring signal data to create a waveform record. See [Trigger concepts](#) on page 51. See [Trigger setup](#) on page 63.



The Trigger **Menu** button opens the side menu for trigger settings.

The **Trigger Level** knob adjusts the trigger level. Trigger level is shown with a horizontal line when using this control.

Push the **Trigger Level** knob to set the trigger level to 50% (the vertical midpoint of the waveform).

The **Force Trig** button forces an immediate trigger event.

The Vertical controls

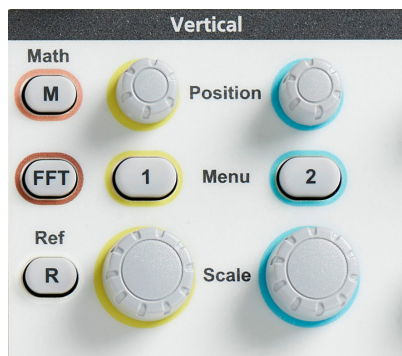

The Vertical controls set the vertical settings (position and scale) for each channel, and enable turning on or off individual waveforms.

- The **Vertical Position** knob adjusts the vertical position for each channel's waveform.

Push the **Position** knob to move the waveform so that the ground reference level is on the center graticule of the screen.



Note: You can choose the **Fine** knob sensitivity in the **Function** button (**Navigation** controls) to let you make smaller adjustments with the position knob.

- The Channel 1, or 2 Menu buttons open (signal coupling, bandwidth, probe attenuation and type) the side menu where you can set the vertical parameters for each channel (including signal coupling, bandwidth, probe attenuation, and probe type), or to display or remove that channel's waveform from the display. See [Setting channel input parameters](#) on page 56. See [Displaying and removing a waveform](#) on page 76.
- The Vertical **Scale** knob sets the vertical scale (volts or units per vertical graticule division) for each channel.
 -  **Note:** You can choose the **Fine** knob sensitivity in the **Function** button (**Navigation** controls) to let you make smaller adjustments with the position knob.
- The **Math** button opens the side menu where you can set the parameters to create and display a math waveform, or to display or remove the Math channel waveform from the display. See [Creating math waveforms](#) on page 92.
- The **Ref** button opens the side menu with controls to display or remove a reference waveform from the screen. See [Displaying reference waveforms](#) on page 100. See [Recalling waveform data](#) on page 108.
- The **FFT** button opens the FFT screen and shows side menu where you can set the **FFT** display parameters. See [Using FFT to see signal frequency information](#) on page 94.

Using the menu system

This topic introduces you to the TBS1000C menu system.

1. Push a front-panel menu button to display the menu that you want to use.



The oscilloscope opens the side menu list for that button on the right side of the screen.

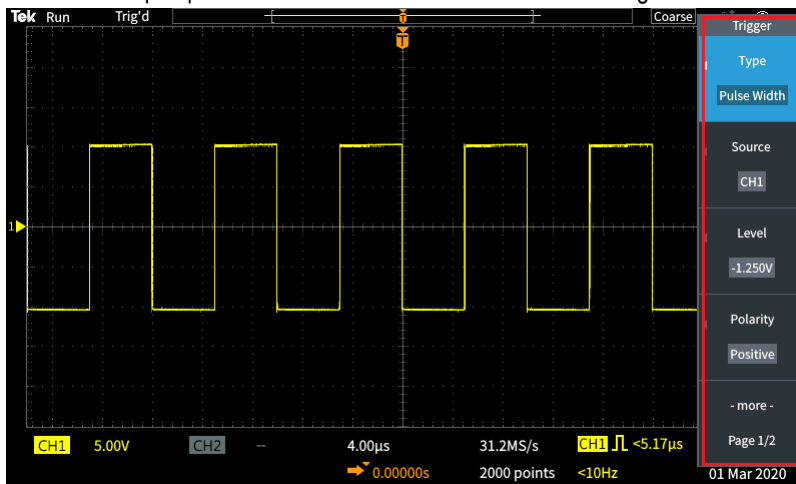

2. Push a side-menu button to select the on-screen menu item that is next to that button.

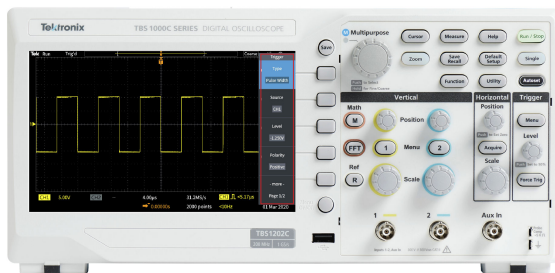

3. If the selected side menu item opens another menu, use the **Multipurpose** knob to highlight an item in the pop-out menu.
4. When the item is highlighted, click the **Multipurpose** knob to enter that item and set the oscilloscope.

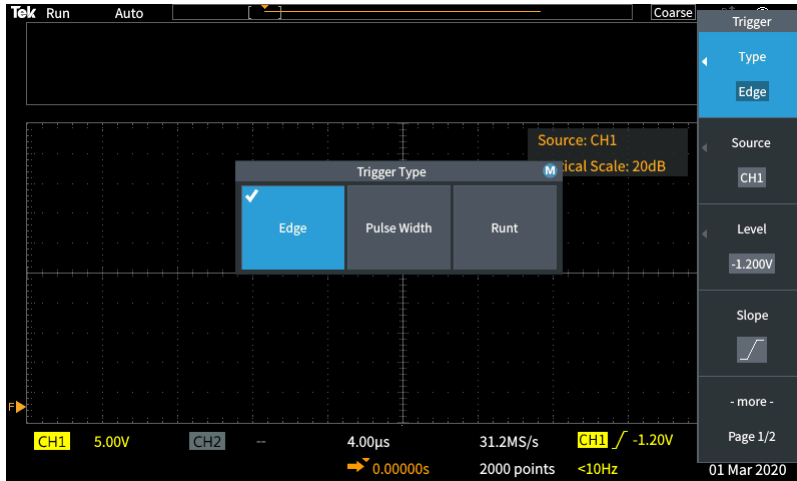

5. Push the **Menu On/Off** to close menus, messages, and other on-screen items.

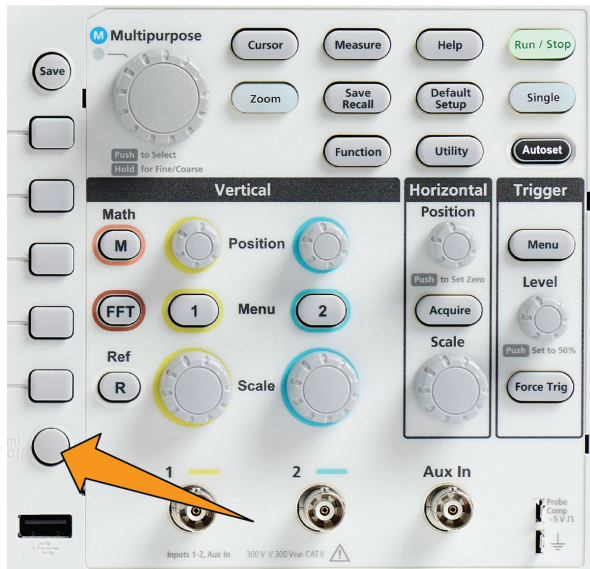

6. Certain menu choices require you to set a numeric value to complete the setup. Use the **Multipurpose** knob and side-menu buttons to highlight, select, and adjust those settings.
7. Push **Function** button to toggle off or on the ability to make smaller adjustments with the **Multipurpose** knob. **Fine** works with the **Multipurpose** knob, Horizontal and Vertical **Position** knobs, Vertical **Scale** knob, and the Trigger **Level** knob.

The following topics provide hands-on experience with using the menu system:

See

- [Changing the user interface language](#) on page 35.
- [Changing the date and time](#) on page 38.
- [Doing a functional check](#) on page 41.

Front-panel connectors

1. Channel 1, 2, **Aux In**. Channel inputs with BNC Probe Interface.

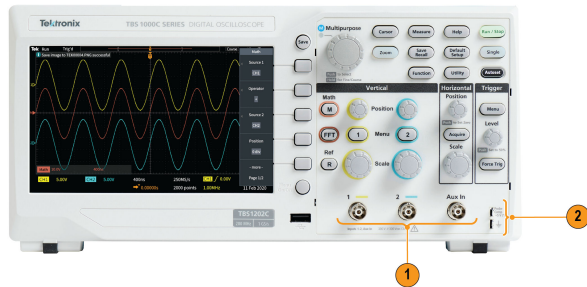

2. **PROBE COMP.** A square wave signal source and ground connection used to compensate probes.

Output voltage: ~ 5 V at ~1 kHz

Ground reference to which to connect the probe ground lead.

3. USB 2.0 Host port.



Rear-panel connectors

1. **USB 2.0 Device port.** Use the USB 2.0 Full Speed Device port to connect to a PC for remote control.

The graphical user interface elements

The figures displayed below appear on the screen. Not all of these figures are visible at any given time. Some readouts move outside the graticule area when menus are turned off.

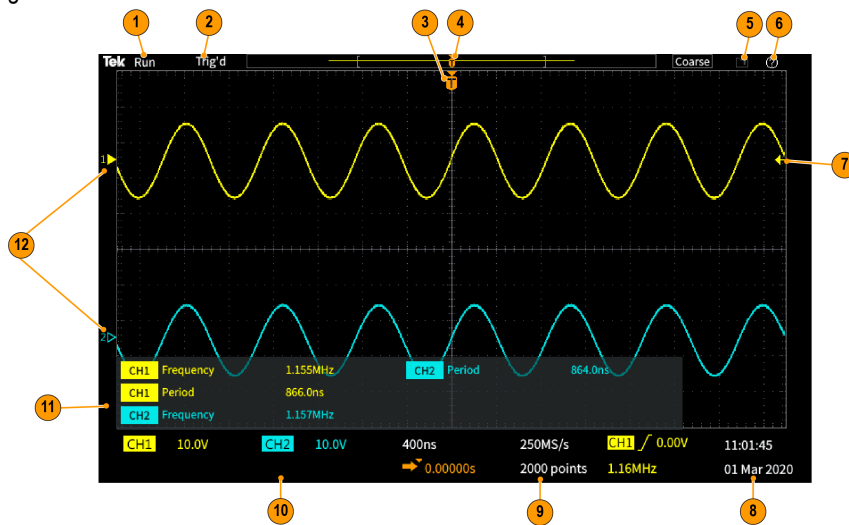

- The acquisition status shows when an acquisition is running, stopped, or when acquisition preview is in effect. The acquisition modes are:
 - Run:** The oscilloscope is acquiring and displaying waveforms.
 - Stop:** The oscilloscope has stopped acquiring data.
 - Roll:** It scrolls sequential waveform points across the display in a right-to-left rolling motion. Roll mode starts automatically when the timebase is set to ≥ 40 ms/div.

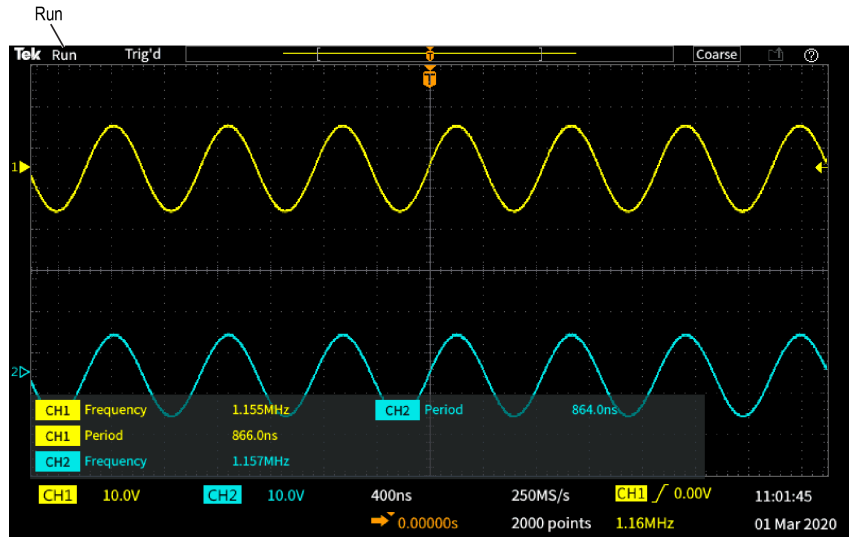

- PreVu: The oscilloscope is stopped and you have used the **Horizontal** or **Vertical Scale** or **Position** knobs to change setting(s). In PreVu mode the oscilloscope is showing a “preview” of what the next acquisition might look like with the changed position or scale settings, based on the last acquired waveform, and assuming that the same signal is acquired with the new settings. In other words, in PreVu mode the oscilloscope is reinterpreting the static waveform record of the last acquisition in memory, resulting in a displayed waveform that may not be accurate.

Do not use the **Horizontal** or **Vertical Scale** or **Position** knobs to examine a stopped or single-acquired waveform; instead, use the **Zoom** controls and **Multipurpose** knob.

The trigger status readout shows the trigger conditions:

- Trig'd:** Triggered
- Auto:** Acquiring untriggered data
- PrTrig:** Acquiring pretrigger data
- Trig?:** Waiting for trigger

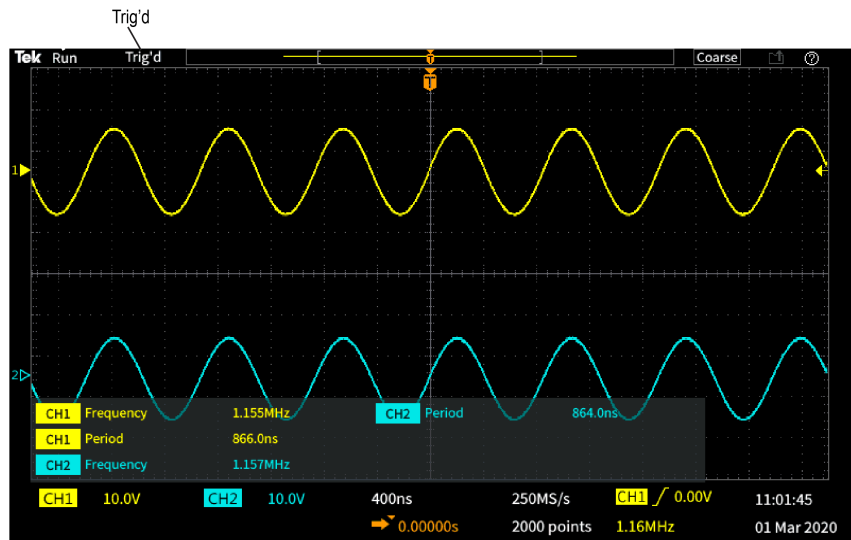

- The trigger position icon (T) shows where the trigger occurred in the waveform record.

The expansion point icon (the orange ▼ triangle at the top of the T) shows the center point around which the horizontal scale control expands or shrinks the waveform (the center expansion point).

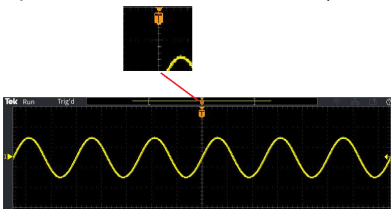

- The waveform record view shows the trigger location relative to the entire waveform record. The line color corresponds to the selected waveform color. The area in brackets is the part of the waveform record that is displayed on the screen.



- The **File Save** icon indicates when the oscilloscope send a file to the USB drive.



- The **HelpEverywhere™** icon indicates when the HelpEverywhere™ function is enabled to display information on oscilloscope settings when you open a menu.



- The trigger level icon shows the trigger level of the active (selected) waveform. Use the Trigger **Level** knob to adjust the trigger level. The trigger level value is shown in the horizontal and trigger readouts at the bottom of the screen.

The oscilloscope shows two trigger level icons when you are triggering on a runt waveform. The trigger level knob only controls the lower trigger threshold level when in runt trigger mode. Use the **Trigger Menu** to set both trigger levels.

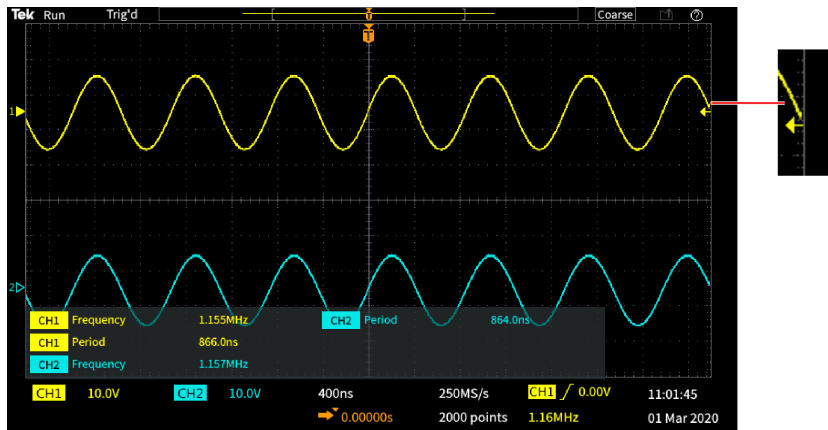

8. The Time and Date readout shows the oscilloscope clock setting. See [Changing the date and time](#) on page 38.

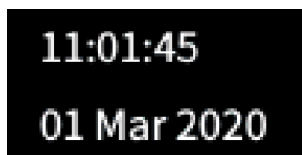

9. The Horizontal and Trigger readouts show Trigger, horizontal scale, sample rate, trigger delay time, and record length information.

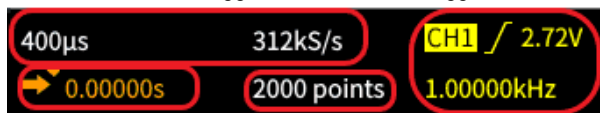

The **Trigger** readouts shows the trigger source, slope, and the trigger threshold level. The readout also shows the measured signal frequency. The trigger readouts for other trigger types show other values. The image shows the readouts for an **Edge** trigger.

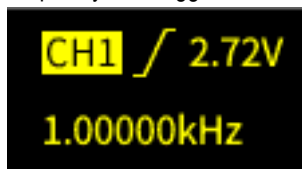

The **horizontal position/scale** readouts show the horizontal scale setting (time per major horizontal graticule division; adjust with the **Horizontal Scale** knob) and the sample rate (number of samples per second).

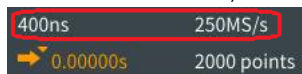

The trigger **Delay Mode** readout is the time from the T symbol to the expansion point icon (adjust with the **Horizontal Position** knob).

Use horizontal position to add delay between when the trigger occurs and when you actually capture the data. Insert a negative time to capture more waveform data before the trigger event.

When **Delay Mode** is off, this readout shows the time location of the trigger within the waveform record, as a percentage.

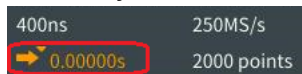

The **Record Length** readout shows how many samples are being stored for the current waveform records. See [Setting the record length](#) on page 73.





10. The **channel** readouts shows the channel scale factor (measurement units per major vertical graticule division), input signal coupling, signal invert status, and the oscilloscope bandwidth setting. Adjust these settings by using the **Vertical Scale** knob and the channel 1, or 2 menus.

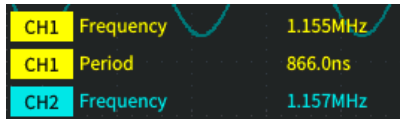

11. The **measurement** readouts show the selected measurements. You can select up to six measurements to display at one time. See [Taking automatic measurements](#) on page 80.

Push the **Menu On/Off** button to toggle on off the display of the measurement readouts on the screen.



A  symbol appears next to a measurement if a vertical clipping condition exists. Clipping is when part of the waveform is above or below the display. Clipping can cause the oscilloscope to take inaccurate measurements. To obtain an accurate measurement, use the **Vertical Scale** and **Position** knobs to show all of the vertical range of the waveform on the screen.

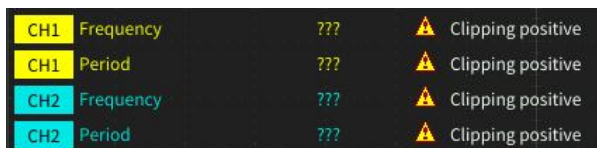

12. The waveform baseline indicator (left side of the screen) shows the zero-volt level of a waveform. The icon colors correspond to the waveform colors. Adjust waveform position with the **Vertical Position** knob.



Labeling channels

You can add a label to the channels shown on the display for easy identification. The label is placed on the waveform baseline indicator in the left side of the screen. The label can have up to 32 characters. Perform the following steps to label a channel:

1. Push the front panel button for an input channel to open the associated side menu.
2. In the side menu, push **Label** to open the Label side menu.

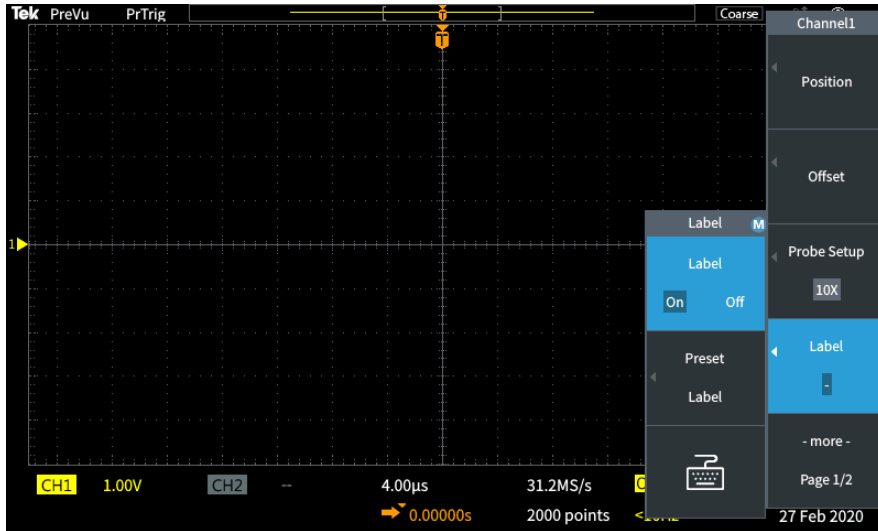

3. To turn the label text ON or OFF, use the **Multipurpose** knob to select **Label ON/OFF** and click the **Multipurpose** knob on the desired option.
4. Turn the **Multipurpose** knob to select **Preset Label**, and then click the knob to open the list of labels.

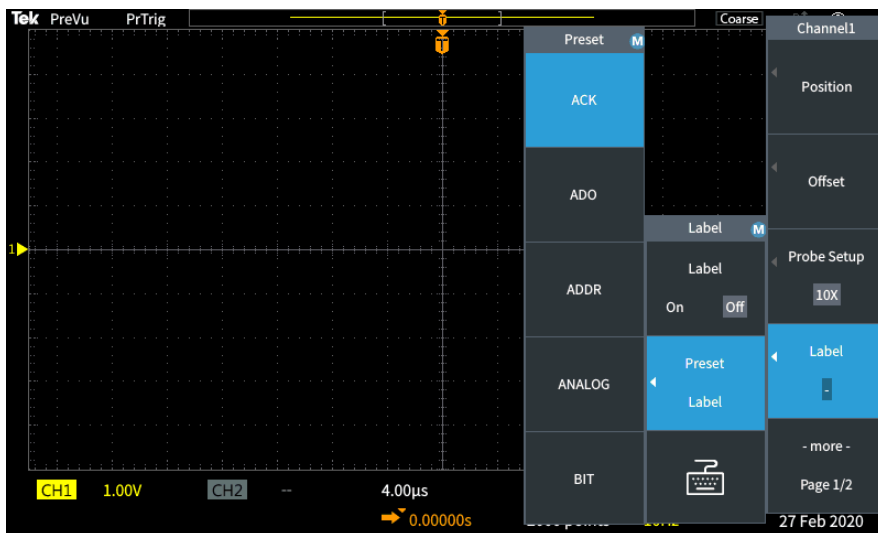

5. Turn the **Multipurpose** knob to scroll through the Preset list to find a suitable label. You can edit the label text after you insert it.
6. Push the **Multipurpose** knob to select the highlighted label. The selected label text will appear on the left side of the display. The example below shows the DTRCK label being selected and displayed.

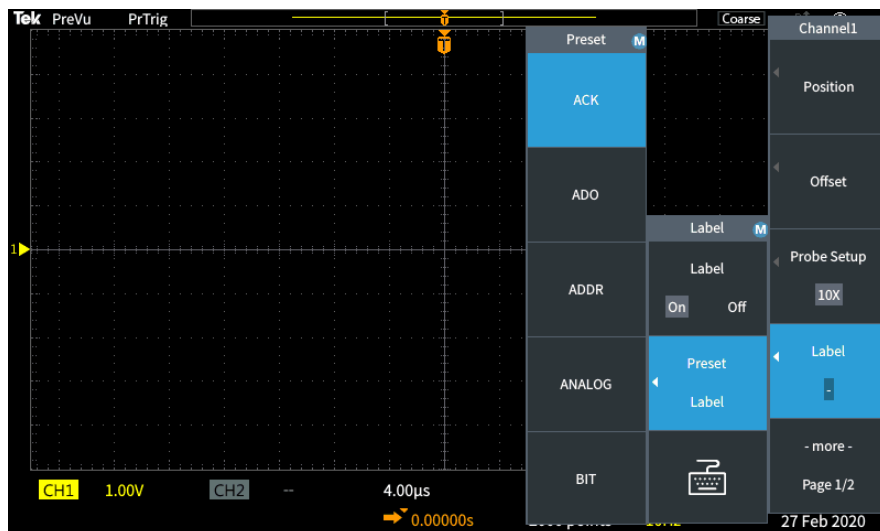

7. Push the **Menu On/Off** button to close the Preset list.
8. If desired, edit the label text:
 - a. Turn the **Multipurpose** knob to select the keyboard icon in the Label side menu, and then click the **Multipurpose** knob to open the Label editor.
 - b. Push the **Backspace** side menu button to delete the existing label characters.
 - c. Turn the **Multipurpose** knob to highlight the first character in the label, and then click the Multipurpose knob to select the character. You can push the **A/a** and the **!/?** side menu buttons to toggle between different character sets.
 - d. Repeat step c as necessary to complete the label.
 - e. When you are done editing the label, push the **OK** side menu button to accept the label.

Warranted specifications

See the *TBS1000C Specifications and Performance Verification Technical Reference Manual* (Tektronix part number 077-1538-xx), for the warranted specifications and performance verification procedure. This manual is English only, and can be downloaded from the Tektronix Web site (www.tek.com/downloads).

Cleaning

General care

Do not store or leave the oscilloscope where the LCD display will be exposed to direct sunlight for long periods of time.



CAUTION: To avoid damage to the oscilloscope or probes, do not expose them to sprays, liquids, or solvents.

Cleaning

Inspect the oscilloscope and probes as often as operating conditions require. To clean the exterior surface, perform the following steps:

1. Remove loose dust on the outside of the oscilloscope and probes with a lint-free cloth. Use care to avoid scratching the clear glass display filter.
2. Use a soft cloth dampened with water to clean the oscilloscope. Use an aqueous solution of 70% isopropyl alcohol for more efficient cleaning.



CAUTION: To avoid damage to the surface of the oscilloscope or probes, do not use any abrasive or chemical cleaning agents.

The default oscilloscope settings Default Setup

The following table lists the oscilloscope settings that are applied when you push the **Default Setup** button.



Note: When you push the **Default Setup** button, the oscilloscope displays the channel 1 waveform and removes all other waveforms.

Function	Setting and value
Acquire	Mode: Sample Record length: 2000 points
Cursors	Off Source: Ch1
Display	Persist: Auto Mode: YT Backlight: 100% Graticule: On
FFT	Source wfm: On Vertical Units: dBv RMS Window: Hanning
Horizontal	Scale (time per major horizontal division): 4.00 μ s/div Delay: On Trigger position: 0.00 s
Math waveform	Source 1: Ch1 Source 2: Ch2 Operation: + (add)
Measurements	Source: Ch1 Selected measurements: None

Table continued...

Function	Setting and value
Trigger	Type: Edge Source: Ch1 Coupling: DC Slope: Rising Level: 0.00 V Mode: Auto
USB Device Port	Connect to Computer
Vertical (all channels)	Coupling: DC Invert: Off Bandwidth: Full Voltage probe attenuation: 10X Baseline position: 0.00 V Scale (volts per major vertical division): 1.00 V

Oscilloscope settings that are not reset by Default Setup

The Default Setup button does not reset or change the following settings:

- Language option
- Date and time
- Saved setups in memory
- Saved reference waveforms in memory
- Calibration data
- Probe setup (type and attenuation factor)
- Current save folder on the USB flash drive

Physically securing the oscilloscope

Use a standard laptop security lock cable to attach your oscilloscope to your location.

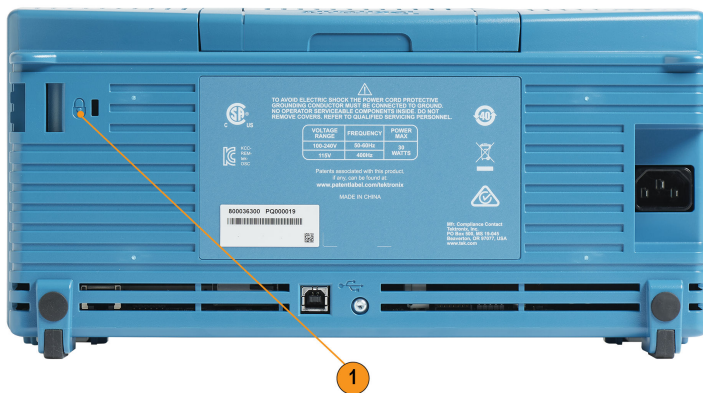

Environmental considerations

This section provides information about the environmental impact of the product.

Product end-of-life handling

Observe the following guidelines when recycling an instrument or component:

Equipment recycling

Production of this equipment required the extraction and use of natural resources. The equipment may contain substances that could be harmful to the environment or human health if improperly handled at the product's end of life. To avoid release of such substances into the environment and to reduce the use of natural resources, we encourage you to recycle this product in an appropriate system that will ensure that most of the materials are reused or recycled appropriately.



This symbol indicates that this product complies with the applicable European Union requirements according to Directives 2012/19/EU and 2006/66/EC on waste electrical and electronic equipment (WEEE) and batteries. For information about recycling options, check the Tektronix Web site (www.tek.com/productrecycling).

Index

Special Characters

- Over measurement [85](#)
- +Over measurement [85](#)

Numerics

- 10X probe attenuation [58](#)
- 1X probe attenuation [58](#)

A

- AC signal coupling [56](#)
- Acquire button [126](#)
- Acquisition
 - Average mode
 - definition [50](#)
 - Hi Res mode
 - intervals [50](#)
 - modes defined [50](#)
 - peak detect mode
 - sample mode
- Acquisition mode, setting [71](#)
- Adding waveform to screen [76](#)
- Adding waveforms (math) [92](#)
- Aliasing, FFT waveforms [100](#)
- Altitude requirements [27](#)
- Amplitude cursors [88](#)
- Amplitude measurement [85](#)
- Amplitude measurement descriptions [84](#)
- Area measurement [86](#)
- Area measurement descriptions [86](#)
- Attenuation (probe) [58](#)
- Auto trigger mode [54](#), [65](#)
- Automatic file names [114](#)
- Automatic measurements, selecting [80](#)
- Autoset
 - change the password [69](#)
 - tips [67](#)
 - waveform position [67](#)
- Autoset button [43](#)
- Autoset Enable button [68](#)
- Average acquisition mode [71](#)

B

- Backlight intensity, setting [79](#)
- Bandwidth, models [22](#)
- Bandwidth, setting [57](#)
- Blackman-Harris FFT window [100](#)
- BMP screen image format [104](#)

Burst Width measurement [83](#)

Buttons

- Acquire [126](#)
- Autoset [43](#)
- Channel Menu [128](#)
- Cursors [124](#)
- F (FFT) [128](#)
- Force Trig [127](#)
- M (Math) [128](#)
- R (Ref) [128](#)
- Trigger Menu [127](#)

C

- Calibration [47](#)
- Change file save location (USB) [111](#)
- Change Folder (file utility) [111](#)
- Change Folder rules [111](#)
- Change the date and time [38](#)
- Changing the UI language [35](#)
- Channel deskew, setting [61](#)
- Channel labeling [135](#)
- Channel Menu buttons [128](#)
- Cleaning [137](#)
- Clipping, signal [81](#)
- Compensate signal path (SPC) [47](#)
- Concepts
 - acquisition [50](#)
 - acquisition intervals [50](#)
 - acquisition modes [50](#)
 - Amplitude-related measurements [84](#)
 - Area-related measurements [86](#)
 - Auto trigger mode [54](#)
 - automatic file names [114](#)
 - bandwidth [57](#)
 - cursors [88](#)
 - DC coupling [53](#)
 - FFT waveform aliasing [100](#)
 - FFT windows [98](#)
 - file utility user interface [110](#)
 - Frequency-related measurements [82](#)
 - gating [86](#)
 - HF coupling [53](#)
 - Holdoff trigger mode [54](#)
 - LF coupling [53](#)
 - Noise reject coupling [53](#)
 - Normal trigger mode [54](#)
 - posttrigger [52](#)
 - pretrigger [52](#)
 - probe attenuation [58](#)
 - roll mode [74](#)

Concepts (continued)

- Time-related measurements [83](#)
- trigger coupling [53](#)
- trigger delay (acquisition mode) [55](#)
- trigger Holdoff mode [54](#)
- trigger level [52](#)
- trigger modes [54](#)
- trigger slope [52](#)
- trigger threshold [52](#)
- trigger types [53](#)
- waveform persistence [76](#)
- XY display [77](#)
- Zoom [101](#)

Confidential data, erasing [116](#)

Connectors

- probe compensation [130](#)

Controls

- Horizontal [126](#)
- Trigger [127](#)
- Vertical [127](#)

Coupling (edge trigger) [63](#)

Courseware

- create a report [124](#)
- file content info [122](#)
- load a course file [122](#)
- overview [121](#)
- running courseware labs [123](#)
- saving results (report) [124](#)

Create a new folder (USB drive) [112](#)

CSV format (waveform data) [107](#)

Cursors [88](#)

Cursors button [124](#)

Cycle Area measurement [86](#)

Cycle Mean measurement [85](#)

Cycle RMS measurement [86](#)

D

Data, waveform (saving) [105](#)

Date and time, changing [38](#)

DC coupling (trigger) [53](#)

DC signal coupling [56](#)

Decay, waveform [76](#)

Default oscilloscope settings [138](#)

Default Setup [75](#)

Delay (trigger, acquisition mode) [55](#)

Delay time (trigger) [55](#)

Delay time readout [134](#)

DelayFF measurement [83](#)

DelayFR measurement [83](#)

DelayRF measurement [83](#)

DelayRR measurement [83](#)

Deleting files or folders (USB drive) [112](#)

Deskew, setting [61](#)

Determining channel of saved ISF file [115](#)

Disable cursor button [91](#)

Disable USB Device port [117](#)

Display

- set backlight intensity [79](#)
- user interface elements [131](#)
- waveform aliasing, FFT [100](#)
- waveform decay (persistence) [76](#)
- waveform persistence [76](#)
- XY mode [77](#)

Dual waveform math [92](#)

E

Edge trigger, defined [53](#)

Edge trigger, selecting [63](#)

Electrostatic damage, preventing

Equipment recycling [140](#)

Erase setup and ref memory [116](#)

Ethernet [22](#)

Expansion point icon [133](#)

F

F (FFT) button [128](#)

Factory default settings [138](#)

Factory settings, loading [75](#)

Fall Time measurement [83](#)

Falling Edge Count measurement [82](#)

Feature Enable

- disable [68, 91](#)

FFT

- Blackman-Harris window [100](#)
- Hamming window [99](#)
- Hanning window [99](#)
- Rectangular window [99](#)
- set FFT center position [94](#)
- set FFT horizontal scale [94](#)
- set FFT source wfm [94](#)
- set FFT vertical units [94](#)
- set FFT window type [94](#)
- show FFT source wfm [94](#)
- tips [98](#)
- waveform aliasing [100](#)
- window concepts [98](#)

File formats, screen images [104](#)

File naming rules, auto-created [114](#)

File utility

- change file save location (USB) [111](#)
- Change Folder [111](#)
- controls [110](#)
- create new folder [112](#)
- deleting files or folders [112](#)
- file naming rules, auto-created [114](#)
- file save location rules [111](#)
- renaming files or folders [113](#)

File utility (*continued*)

- save file location rules [111](#)
- user interface [110](#)

Firmware upgrade [120](#)

For more information

- performance verification [137](#)
- specifications [137](#)
- supported probes [41](#)

Force Trig button [127](#)

Frequency [83](#)

Frequency cursors [88](#)

Frequency description [82](#)

Frequency measurements descriptions [82](#)

Front-panel language overlay

Front-panel language overlay options [26](#)

Functional check [41](#)

G

Gating (measurement) [86](#)

GPIO adapter

- ordering [25](#)

GPIO and USB [118](#)

Ground lead tip, probe [44](#)

Ground signal coupling [56](#)

Ground strap

Ground yourself to discharge static

H

Hamming FFT window [99](#)

Hanning FFT window [99](#)

HelpEverywhere™ feature [45](#)

HF coupling (trigger) [53](#)

Hi Res acquisition mode

High measurement [85](#)

Holdoff trigger mode [54](#), [65](#)

Horiz center position (FFT) [94](#)

Horizontal controls [126](#)

Horizontal position knob [126](#)

Horizontal scale (FFT) [94](#)

Horizontal scale knob [126](#)

How to

- add a waveform to the screen [76](#)
- Add waveforms (math) [92](#)
- Average acquisition mode [71](#)
- bring cursors on-screen [88](#)
- change a menu field value [38](#)
- change Autoset password [69](#)
- change the language [35](#)
- change the time and date [38](#)
- check that oscilloscope is working [41](#)
- close menus [35](#), [38](#)
- compensate internal signal paths (SPC) [47](#)
- create math waveforms [92](#)

How to (*continued*)

- create new folder (USB drive) [112](#)
- delete files or folders [112](#)
- disable Autoset button [68](#)
- disable cursor button [91](#)
- disable USB Device port [117](#)
- enable HelpEverywhere™ [45](#)
- erase oscilloscope memory [116](#)
- examine waveform details (zoom) [101](#)
- find information on supported probes [41](#)
- install language overlay
- install new firmware [120](#)
- invert the input signal [56](#)
- link cursors [88](#)
- load a courseware file [122](#)
- load factory settings [75](#)
- load oscilloscope setups [108](#)
- load waveform files [108](#)
- move a waveform (vertical) [60](#)
- move both cursors at same time [88](#)
- move cursors onto screen [88](#)
- Multiply waveforms (math) [92](#)
- open reference waveforms [100](#)
- perform a functional check [41](#)
- power off the oscilloscope [34](#)
- prevent electrostatic damage
- quickly set 1X, 10X attenuation [58](#)
- recall oscilloscope setups [108](#)
- recall waveform data [108](#)
- recall waveform files [108](#)
- remove a waveform from the screen [76](#)
- rename files or folders [113](#)
- restore default settings [75](#)
- restore factory settings [75](#)
- run courseware labs [123](#)
- Run SPC [47](#)
- save courseware lab results (report) [124](#)
- save oscilloscope setups [106](#)
- save screen to a USB drive [104](#)
- save waveform data [105](#)
- select a measurement, example [44](#)
- select automatic measurements [80](#)
- select cursors [88](#)
- select device for USB port [117](#)
- select slope (edge trigger) [65](#)
- set acquisition mode [71](#)
- set backlight intensity [79](#)
- set bandwidth [57](#)
- set channel deskew [61](#)
- set DC offset on a signal [59](#)
- set default save location (Change Folder) [111](#)
- set Edge trigger [63](#)
- set FFT center position [94](#)
- set FFT horizontal scale [94](#)
- set FFT source wfm [94](#)

How to *(continued)*

- set FFT vertical units [94](#)
- set FFT window type [94](#)
- set Hi Res acquisition mode [71](#)
- set input signal coupling [56](#)
- set measure current (for voltage probe) [59](#)
- set measurement gating [86](#)
- set Peak Detect acquisition mode [71](#)
- set probe attenuation [58](#)
- set probe type (voltage, current) [57](#)
- set pulse width trigger [64](#)
- set record length [73](#)
- set runt pulse trigger [64](#)
- set Sample acquisition mode [71](#)
- set Save File button [106](#)
- set signal DC offset [59](#)
- set slope (edge trigger) [63](#)
- set the date and time [38](#)
- set the language [35](#)
- set trigger coupling (edge trigger) [63](#)
- set trigger holdoff [65](#)
- set trigger modes [65](#)
- set trigger source [63](#), [64](#)
- set trigger when condition (pulse width) [64](#)
- set trigger when condition (runt pulse) [64](#)
- set vertical offset [59](#)
- set vertical position [60](#)
- set waveform decay time [76](#)
- set waveform persistence [76](#)
- show a snapshot of all measurements [81](#)
- show FFT source wfm [94](#)
- show help on menu items [45](#)
- show measurements [80](#)
- show reference waveforms [100](#)
- start acquiring a signal [70](#)
- stop acquiring a signal [70](#)
- Subtract waveforms (math) [92](#)
- take and save a screenshot [104](#)
- take automatic measurements [80](#)
- take measurement snapshot [81](#)
- take measurements with cursors [88](#)
- turn XY display on/off [77](#)
- undo an Autoset [67](#)
- undo default settings [75](#)
- upgrade the firmware [120](#)
- use Autoset [67](#)
- use cursors [88](#)
- use roll mode [74](#)
- use the menu system [35](#), [38](#), [128](#)
- use the Multipurpose knob [35](#), [38](#)
- use the side-menu buttons [35](#), [38](#)
- use Zoom [101](#)
- view oscilloscope theory and concepts [48](#)
- view USBTMC information [118](#)
- zoom on waveforms [101](#)

Humidity requirements [27](#)

I

Icon

- Expansion point [133](#)
- measurement clipping [135](#)
- Trigger level [133](#)
- Trigger position [133](#)

Image file formats [104](#)

Infinite persistence (waveform) [76](#)

Installing firmware [120](#)

Invert input signal [56](#)

ISF format (waveform data) [107](#)

J

JPG screen image format [104](#)

K

Knobs

- Horizontal position [126](#)
- Horizontal scale [126](#)
- Push for Trig Source [128](#)
- Push to Center [128](#)
- Push to Set 50% [127](#)
- Trigger Level [127](#)
- Vertical Position [128](#)
- Vertical Scale [128](#)

L

Labeling channels [135](#)

Language

- change the oscilloscope language [35](#)
- overlay

Level, trigger [52](#)

LF coupling (trigger) [53](#)

Link cursors [88](#)

Lissajou pattern (XY mode) [77](#)

Loading

- Courseware file [122](#)
- setup files [108](#)
- waveform files [108](#)

Low measurement [85](#)

M

M (Math) button [128](#)

Manual

- Programmer [24](#)
- Service [24](#)
- User [25](#)

Math waveforms [92](#)

- Max measurement [85](#)
- Mean measurement [85](#)
- Measure Current mode (voltage probes) [59](#)
- Measurement clipping icon [135](#)
- Measurement readouts [135](#)
- Measurements
 - Over (Neg overshoot) [85](#)
 - +Over (Pos overshoot) [85](#)
 - Amplitude [85](#)
 - Area [86](#)
 - Burst Width [83](#)
 - cursors [88](#)
 - Cycle Area [86](#)
 - Cycle Mean [85](#)
 - Cycle RMS [86](#)
 - defined [82](#)
 - DelayFF [83](#)
 - DelayFR [83](#)
 - DelayRF [83](#)
 - DelayRR [83](#)
 - descriptions [82](#)
 - Fall Time [83](#)
 - Falling Edge Count [82](#)
 - gating [86](#)
 - High [85](#)
 - Low [85](#)
 - Max [85](#)
 - Mean [85](#)
 - Min [85](#)
 - Negative Duty Cycle [83](#)
 - Negative Pulse Count [82](#)
 - Negative Pulse Width [83](#)
 - Period [83](#)
 - Phase [83](#)
 - Pk-Pk [85](#)
 - Positive Duty Cycle [83](#)
 - Positive Pulse Count [82](#)
 - Positive Pulse Width [83](#)
 - readout [80](#)
 - Rise Time [83](#)
 - Rising Edge Count [82](#)
 - RMS [85](#)
 - selecting [80](#)
 - signal clipping and measurements [81](#)
 - snapshot of all measurements [81](#)
 - turning off readout [80](#)
 - unselecting [80](#)
- Memory, erasure of [116](#)
- Menu system, using [128](#)
- Menu system, using (example) [35](#), [38](#), [41](#)
- Min measurement [85](#)
- Mode, roll [74](#)
- Modes, trigger (selecting) [65](#)
- Moving the waveform vertical position [60](#)
- MPK (Multipurpose) knob [35](#)

- Multiplying waveforms (math) [92](#)
- Multipurpose (MPK) knob [35](#)
- Multipurpose knob

N

- Negative Duty Cycle measurement [83](#)
- Negative Overshoot measurement [85](#)
- Negative Pulse Count measurement [82](#)
- Negative Pulse Width measurement [83](#)
- No course files found error message [123](#)
- Noise reject coupling (trigger) [53](#)
- Normal trigger mode [54](#), [65](#)

O

- Operating environment requirements [27](#)
- Options
 - Front-panel language overlays [26](#)
 - Power cord [26](#)
 - Probe [25](#)
 - Service [25](#)
- Oscilloscope settings, default [138](#)
- Overview of oscilloscope theory [48](#)

P

- Password, Autoset [69](#)
- Peak Detect acquisition mode [71](#)
- Performance verification [137](#)
- Period measurement [83](#)
- Persistence, waveform [76](#)
- Phase measurement [83](#)
- Pk-Pk measurement [85](#)
- PNG screen image for mat [104](#)
- Positive Duty Cycle measurement [83](#)
- Positive Overshoot measurement [85](#)
- Positive Pulse Count measurement [82](#)
- Positive Pulse Width measurement [83](#)
- Posttrigger, concept [52](#)
- Power
 - off [34](#)
 - removing [34](#)
- Power cord
 - options [26](#)
- Power requirements
 - consumption [27](#)
 - frequency [27](#)
 - voltage [27](#)
- Pretrigger, concept [52](#)
- Preventing electrostatic damage
- Probe Comp [42](#)
- PROBE COMP connector [130](#)
- Probe option [25](#)
- Probes

Probes (*continued*)
attenuation [58](#)
probe type (voltage, current) [57](#)
set measure current mode [59](#)
setting attenuation [58](#)
supported [41](#)
use shortest ground lead [44](#)
Probes, optional [24](#)
Product end-of-life handling (recycling) [140](#)
Programmer manual [24](#)
Pulse Width trigger, defined [53](#)
Pulse width trigger, selecting [64](#)
Push for Trig Source knob [128](#)
Push to Center knob [128](#)
Push to Set 50% knob [127](#)

R

R (Ref) button [128](#)
Rackmount kit [24](#)
Readouts
automatic measurements [80](#)
Cursors [88](#)
measurement clipping [135](#)
measurement snapshot [81](#)
measurements [135](#)
trigger delay time [134](#)
Recalling
oscilloscope setups [108](#)
setup files [108](#)
waveform data [108](#)
waveform files [108](#)
Record length
setting [73](#)
size limit for FFT waveforms [94](#)
size limit for reference memory [73](#)
Rectangular FFT window [99](#)
Recycling, oscilloscope [140](#)
Reference
automatic file naming [115](#)
Courseware file content info [122](#)
CSV files [107](#)
default oscilloscope settings [138](#)
determining channel of saved ISF file [115](#)
factory default settings [138](#)
file naming rules, auto-created [114](#)
image file formats [104](#)
ISF files [107](#)
No course files found error message [123](#)
save file rules (file utility) [111](#)
saved waveform files [107](#)
settings not changed by Default Setup [139](#)
Reference memory and record length limit [73](#)
Reference waveforms, showing [100](#)
Removing waveform from screen [76](#)

Renaming files or folders (USB drive) [113](#)
Rise Time measurement [83](#)
Rising Edge Count measurement [82](#)
RM2000B Rackmount Kit [24](#)
RMS measurement [85](#)
Roll mode conditions [74](#)
Run/Stop [70](#)
Runt pulse trigger, selecting [64](#)
Runt trigger, defined [53](#)

S

Safety
AC ground connection [27](#)
power requirements [27](#)
Sample acquisition mode [71](#)
Sample rates [22](#)
Save File button [106](#)
Saving
image file formats [104](#)
Save File button [106](#)
screen image to a USB drive [104](#)
set Save File button [106](#)
setups to a file or memory [106](#)
waveform data to file [105](#)
waveform to ref memory [105](#)
Scale, horizontal [126](#)
Scope Intro [48](#)
Screen cursors [88](#)
Screen image, saving to a file [104](#)
Screenshot, taking [104](#)
Securing memory [116](#)
Select device for USB port [117](#)
Service manual [24](#)
Service option [25](#)
Set the date and time [38](#)
Settings not changed by Default Setup [139](#)
Settings, saving to file or memory [106](#)
Setup info, saving to file or memory [106](#)
Setups, recalling [108](#)
Showing help on menu items [45](#)
Side-menu buttons, example [35](#)
Signal clipping [81](#)
Signal coupling, setting [56](#)
Signal DC offset, setting [59](#)
Signal path compensation (SPC) [47](#)
Signal source (FFT) [94](#)
Single acquisition [70](#)
Slope (edge trigger) [63](#)
Slope, trigger [52](#)
Snapshot of all measurements [81](#)
Soft case ordering [25](#)
SPC (signal path compensation) [47](#)
Specifications [137](#)
Start an acquisition [70](#)

Stop an acquisition [70](#)
Subtracting waveforms (math) [92](#)

T

TBS2KB.TEK file [120](#)
TEK-USB-488 adapter
 ordering [25](#)
TekSecure [116](#)
Temperature requirements [27](#)
Time cursors [88](#)
Time measurements descriptions [83](#)
Tips
 automatic file naming [115](#)
 Autoset [67](#)
 creating folders (USB drive) [112](#)
 determining channel of saved ISF file [115](#)
 FFT [98](#)
 math waveform [94](#)
 No course files found error message [123](#)
 reference waveforms [101](#)
 renaming folders (USB drive) [114](#)
 use shortest ground lead [44](#)
 XY display mode [79](#)
Transit case ordering [25](#)

Trigger

Auto modes [65](#)
Auto trigger mode [54](#)
coupling (edge only) [63](#)
DC coupling [53](#)
delay (acquisition mode) [55](#)
edge [63](#)
Edge, defined [53](#)
HF coupling [53](#)
Holdoff mode [54](#), [65](#)
level [52](#)
level (edge) [63](#)
LF coupling [53](#)
modes [65](#)
Noise reject coupling [53](#)
Normal mode [65](#)
Normal trigger mode [54](#)
polarity (pulse width) [64](#)
polarity (runt pulse) [64](#)
position icon [133](#)
posttrigger [52](#)
pretrigger [52](#)
pulse width [64](#)
Pulse Width, defined [53](#)
runt pulse [64](#)
Runt signal, defined [53](#)
set holdoff [65](#)
set holdoff to minimum [65](#)
slope [52](#)
slope (edge only) [63](#)

Trigger (continued)

source [63](#), [64](#)
threshold (pulse width) [64](#)
thresholds (runt pulse) [64](#)
trigger delay readout [134](#)
trigger level icon [133](#)
trigger mode concepts [54](#)
trigger types [53](#)
trigger when (pulse width) [64](#)
trigger when (runt pulse) [64](#)
type (edge) [63](#)
type (pulse width) [64](#)
Trigger controls [127](#)
Trigger Level knob [127](#)
Trigger Menu button [127](#)

U

Undo Autoset [67](#)
Undo Default Setup [75](#)
Upgrading firmware [120](#)
USB
 Device port [22](#)
 Host port [22](#)
User manual [25](#)
Using the menu system [128](#)

V

Variable persistence (waveform) [76](#)
Vertical
 position and autoset [67](#)
Vertical controls [127](#)
Vertical offset, setting [59](#)
Vertical Position knob [128](#)
Vertical position, setting [60](#)
Vertical Scale knob [128](#)
Vertical units (FFT) [94](#)
View USBTMC information [118](#)

W

Waveform

adding to screen [76](#)
data formats (CSV, ISF) [107](#)
decay time (persistence) [76](#)
display a waveform [76](#)
FFT waveforms [94](#)
file formats (CSV, ISF) [107](#)
loading from file or memory [108](#)
math waveforms [92](#)
persistence time [76](#)
recalling from file or memory [108](#)
remove a waveform [76](#)
removing from screen [76](#)

Waveform (*continued*)
 saving to file or ref [105](#)
Waveform aliasing, FFT [100](#)
Waveform DC offset [59](#)
Waveform vertical position [60](#)
Window type (FFT) [94](#)

Z

Zoom [101](#)