



**TBS2000B Series  
Digital Oscilloscopes  
Programmer Manual**



077-1149-03





**TBS2000B Series  
Digital Oscilloscopes  
Programmer Manual**

Copyright © Tektronix. All rights reserved. Licensed software products are owned by Tektronix or its subsidiaries or suppliers, and are protected by national copyright laws and international treaty provisions. Tektronix products are covered by U.S. and foreign patents, issued and pending. Information in this publication supersedes that in all previously published material. Specifications and price change privileges reserved.

TEKTRONIX and TEK are registered trademarks of Tektronix, Inc.

### **Contacting Tektronix**

Tektronix, Inc.  
14150 SW Karl Braun Drive  
P.O. Box 500  
Beaverton, OR 97077  
USA

For product information, sales, service, and technical support:

- In North America, call 1-800-833-9200.
- Worldwide, visit [www.tek.com](http://www.tek.com) to find contacts in your area.

---

# Table of Contents

TBS2000B Series Programmer Manual .....	0
---	---

## Getting Started

Setting Up Remote Communications Software .....	1
Using a Socket Server .....	1

## Command Syntax

Command Syntax .....	3
Command and Query Structure .....	4
Commands .....	5
Queries .....	5
Headers in Query Responses .....	6
Clearing the Output Queue .....	6
Command Entry .....	6
Abbreviating Commands .....	7
Concatenating Commands .....	7
Message Terminators .....	8
Constructed Mnemonics .....	9
Reference Waveform Mnemonics .....	9
Waveform Mnemonics .....	9
Cursor Position Mnemonic .....	10
Measurement Specifier Mnemonics .....	10
Argument Types .....	10
Numeric Arguments .....	10
Quoted String Arguments .....	11
Block Arguments .....	11

## Command groups

Alias command group .....	13
Acquisition command group .....	14
Calibration and Diagnostic command group .....	14
Cursor command group .....	15
Display command group .....	16
Ethernet command group .....	17
FFT command group .....	18

File system command group .....	18
Help everywhere command group .....	19
Horizontal command group .....	20
Mark command group .....	21
Math command group .....	22
Measurement command group .....	23
Miscellaneous command group .....	25
Save and Recall command group .....	27
Search command group .....	28
Status and Error command group .....	29
Trigger command group .....	30
Vertical command group .....	32
Waveform command group .....	34
Zoom command group .....	39

## A commands

ACQuire? .....	41
ACQuire:MAXSamplerate? .....	42
ACQuire:MODE .....	42
ACQuire:NUMAcq? .....	44
ACQuire:NUMAVg .....	45
ACQuire:STATE .....	45
ACQuire:STOPAfter .....	46
ALias .....	47
ALias:CATalog? .....	48
ALias:DEFine .....	49
ALias:DELEte .....	50
ALias:DELEte:ALL .....	50
ALias:DELEte[:NAME] .....	51
ALias[:STATE] .....	51
ALLEv? .....	52
AUTOSet .....	53
AUTOSet:ENABLE .....	53

## B commands

BUSY? .....	55
-------------	----

## C commands

*CAL?	57
CALibrate:INTERNAL	58
CALibrate:INTERNAL:START	58
CALibrate:INTERNAL:STATUS?	59
CALibrate:RESults?	60
CALibrate:RESults:SPC?	60
CH<x>?	61
CH<x>:AMPSVIAVOLTS:ENABLE	62
CH<x>:AMPSVIAVOLTS:Factor	63
CH<x>:BANdwidth	63
CH<x>:COUPling	64
CH<x>:DESKew	65
CH<x>:INVert	66
CH<x>:LABel	66
CH<x>:OFFSet	67
CH<x>:POSition	68
CH<x>:PRObe	69
CH<x>:PRObe:AUTOZero	70
CH<x>:PRObe:DEGAUss	70
CH<x>:PRObe:DEGAUss:STATE?	71
CH<x>:PRObe:FORCEDRange	72
CH<x>:PRObe:GAIN	73
CH<x>:PRObe:ID?	74
CH<x>:PRObe:ID:SERnumber?	74
CH<x>:PRObe:ID:TYPE?	75
CH<x>:PRObe:SIGnal	75
CH<x>:PRObe:UNIIts?	76
CH<x>:SCALE	76
CH<x>:VOLts	77
CH<x>:YUNit	78
CLEARMenu	79
*CLS	79
CURSor?	80
CURSor:ENABLE	81
CURSor:FUNcTION	82
CURSor:HBArs?	83
CURSor:HBArs:DELTA?	83
CURSor:HBArs:POSITION<x>	84
CURSor:HBArs:UNIIts	85

CURSor:HBArS:USE .....	85
CURSor:MODe .....	86
CURSor:VBArS? .....	87
CURSor:VBArS:ALTErNATE<x>? .....	87
CURSor:VBArS:DELTA? .....	88
CURSor:VBArS:HPOS<x>? .....	89
CURSor:VBArS:POSITIOn<x> .....	89
CURSor:VBArS:UNItS .....	90
CURSor:VBArS:VDELTA? .....	91
CURVe .....	92

## D commands

DATA .....	95
DATA:DEStInATIOn .....	96
DATA:SOUrce .....	97
DATA:STARt .....	98
DATA:STOP .....	99
DATA:WIDth .....	100
DATE .....	101
DESE .....	102
DIAg:FAN .....	103
DIAg:LOOP:OPTIOn .....	103
DIAg:LOOP:OPTIOn:NTIMes .....	104
DIAg:LOOP:STOP .....	104
DIAg:RESUlT:FLAg? .....	105
DIAg:RESUlT:LOG? .....	105
DIAg:SELEct .....	106
DIAg:SELEct:<function> .....	107
DIAg:STATE .....	107
DIAg:TEMPVAL .....	108
DISPlay:GRAticule .....	108
DISPlay:INTENSITy:BACKLIght .....	109
DISPlay:PERStence:STATe .....	110
DISPlay:PERStence:VALUe .....	110

## E commands

ERRLOG:FIRSt? .....	113
ERRLOG:NEXt? .....	113



*ESE .....	114
*ESR? .....	115
ETHERnet:DHCPbootp .....	116
ETHERnet:DNS:IPADdress .....	117
ETHERnet:DOMAINname .....	117
ETHERnet:ENET:ADdress? .....	118
ETHERnet:GATEWay:IPADdress .....	118
ETHERnet:HTTTPort .....	119
ETHERnet:IPADdress .....	120
ETHERnet:NAME .....	120
ETHERnet:PASSWord .....	121
ETHERnet:PING .....	121
ETHERnet:PING:STATUS? .....	122
ETHERnet:SUBNETMask .....	123
EVENT? .....	123
EVMsg? .....	124
EVQty? .....	125

## F commands

FACTory .....	127
FEAEN:PASSWORD .....	128
FFT? .....	129
FFT:HORizontal:POSition .....	129
FFT:HORizontal:SCALE .....	130
FFT:SOURce .....	130
FFT:SRCWFM .....	131
FFT:VERTical:POSition .....	132
FFT:VERTical:SCALE .....	132
FFT:VERTical:UNIts .....	133
FFT:VType .....	133
FFT:WINDow .....	134
FILESystem? .....	134
FILESystem:CWD .....	135
FILESystem:DELEte .....	136
FILESystem:DIR? .....	137
FILESystem:FORMat .....	138
FILESystem:FREESpace? .....	138
FILESystem:MKDir .....	139
FILESystem:READFile .....	140

FILESystem:REName .....	140
FILESystem:RMDir .....	141
FILESystem:WRITEFile .....	142
FPanel:PRESS .....	143
FPanel:TURN .....	145
FWUpdate:Update .....	146

## H commands

HDR .....	147
HEADer .....	147
HELPevery:ACQuire .....	148
HELPevery:ALL .....	149
HELPevery:CURSor .....	149
HELPevery:FFT .....	150
HELPevery:MATH .....	150
HELPevery:MEASUrement .....	151
HELPevery:REFeRence .....	152
HELPevery:SEARCh .....	152
HELPevery:TRIGger .....	153
HELPevery:UTILity .....	154
HELPevery:VERtical .....	154
HORizontal? .....	155
HORizontal:ACQLENGTH .....	156
HORizontal:DIVisions .....	156
HORizontal[:MAIn][:DELay]:POSition .....	157
HORizontal:MAIn:DELay:MODE .....	158
HORizontal:MAIn:DELay:STATE .....	159
HORizontal[:MAIn]:DELay:TIME .....	160
HORizontal[:MAIn]:SAMPLERate .....	160
HORizontal[:MAIn]:SCALE .....	161
HORizontal[:MAIn]:SECdiv .....	162
HORizontal:MAIn:UNIts[:STRing] .....	162
HORizontal:PREViewstate .....	163
HORizontal:RECOrdlength .....	163
HORizontal:RECOrdlength:Auto .....	164
HORizontal:RESOLution .....	165
HORizontal:ROLL .....	165
HORizontal:TRIGger:POSition .....	166

## I commands

ID? .....	167
*IDN? .....	168

## L commands

LANGuage .....	169
LOCK .....	170
*LRN? .....	170

## M commands

MARK .....	171
MARK:CREATE .....	172
MARK:DELEte .....	173
MARK:FREE? .....	174
MARK:SELEcted:END? .....	174
MARK:SELEcted:FOCUS? .....	174
MARK:SELEcted:MARKSINCOLumn? .....	175
MARK:SELEcted:OWNer? .....	175
MARK:SELEcted:SOURCE? .....	176
MARK:SELEcted:START? .....	176
MARK:SELEcted:STATe? .....	176
MARK:SELEcted:ZOOM:POSition? .....	177
MARK:TOTAL? .....	177
MATH? .....	177
MATH:DEFINE .....	178
MATH:HORIZontal:POSition .....	179
MATH:HORIZontal:SCALE .....	180
MATH:HORIZontal:UNIts .....	180
MATH:LABel .....	181
MATH:VERTical:POSition .....	182
MATH:VERTical:SCALE .....	182
MATH:VERTical:UNIts .....	183
MEASUrement? .....	184
MEASUrement:CLearSNapshot .....	185
MEASUrement:ENABLE .....	185
MEASUrement:GATing .....	186
MEASUrement:IMMed? .....	187

MEASUrement:IMMed:DELAy?	187
MEASUrement:IMMed:DELAy:EDGE<x>	188
MEASUrement:IMMed:SOUrce1	189
MEASUrement:IMMed:SOUrce2	190
MEASUrement:IMMed:TYPe	191
MEASUrement:IMMed:UNIts?	193
MEASUrement:IMMed:VALue?	194
MEASUrement:MEAS<x>?	195
MEASUrement:MEAS<x>:DELAy?	195
MEASUrement:MEAS<x>:DELAy:EDGE<x>	196
MEASUrement:MEAS<x>:SOUrce1	196
MEASUrement:MEAS<x>:SOUrce2	197
MEASUrement:MEAS<x>:STATE	198
MEASUrement:MEAS<x>:TYPe	199
MEASUrement:MEAS<x>:UNIts?	202
MEASUrement:MEAS<x>:VALue?	203
MEASUrement:REFLevel?	204
MEASUrement:REFLevel:ABSolute:LOW	204
MEASUrement:REFLevel:ABSolute:MID1	205
MEASUrement:REFLevel:ABSolute:MID2	206
MEASUrement:REFLevel:METhod	207
MEASUrement:REFLevel:PERCent:HIGH	208
MEASUrement:REFLevel:PERCent:LOW	209
MEASUrement:REFLevel:PERCent:MID1	210
MEASUrement:REFLevel:PERCent:MID2	211
MEASUrement:SNAPSHOT	212
MEASUrement:SOURCESNAPShot	212

## O commands

*OPC	213
------	-----

## P commands

*PSC	215
------	-----

## R commands

*RCL	217
RECALL:SETUp	218
RECALL:WAVEForm	219

REF<x>? .....	220
REF<x>:DATE? .....	220
REF<x>:TIME? .....	221
REF<x>:HORIZontal:DELay:TIME? .....	221
REF<x>:HORIZontal:SCALE? .....	222
REF<x>:POSition? .....	222
REF<x>:VERTical:POSition? .....	223
REF<x>:VERTical:SCALE? .....	223
*RST .....	224

## S commands

*SAV .....	225
SAVe:ASSIgn:TYPe .....	226
SAVe:IMAge .....	226
SAVe:IMAge:FILEFormat .....	227
SAVe:IMAge:LAYout .....	228
SAVe:SETUp .....	229
SAVe:WAVEform .....	230
SAVe:WAVEform:FILEFormat .....	231
SEARCH .....	232
SEARCH:SEARCH<x>:COpy .....	232
SEARCH:SEARCH<x>:STATE .....	233
SEARCH:SEARCH<x>:TOTAL .....	234
SEARCH:SEARCH<x>:TRIGger:A:LEVel .....	234
SEARCH:SEARCH<x>:TRIGger:A:LEVel:CH<x> .....	235
SEARCH:SEARCH<x>:TRIGger:A:LOWerthreshold:MATH .....	235
SEARCH:SEARCH<x>:TRIGger:A:LOWerthreshold:REF<x> .....	236
SEARCH:SEARCH<x>:TRIGger:A:TYPe .....	236
SEARCH:SEARCH<x>:TRIGger:A:EDGE:SLOpe .....	237
SEARCH:SEARCH<x>:TRIGger:A:EDGE:SOUrce .....	238
SEARCH:SEARCH<x>:TRIGger:A:LOWerthreshold:CH<x> .....	238
SEARCH:SEARCH<x>:TRIGger:A:PULSEWidth:POLarity .....	239
SEARCH:SEARCH<x>:TRIGger:A:PULSEWidth:SOUrce .....	239
SEARCH:SEARCH<x>:TRIGger:A:PULSEWidth:WHEn .....	240
SEARCH:SEARCH<x>:TRIGger:A:PULSEWidth:WIDth .....	240
SEARCH:SEARCH<x>:TRIGger:A:RUNT:POLarity .....	241
SEARCH:SEARCH<x>:TRIGger:A:RUNT:SOUrce .....	241
SEARCH:SEARCH<x>:TRIGger:A:RUNT:WHEn .....	242
SEARCH:SEARCH<x>:TRIGger:A:RUNT:WIDth .....	243

SEARCH:SEARCH<x>:TRIGger:A:UPPerthreshold:CH<x>	243
SElect:CH<x>	244
SElect:CONTROL	245
SElect:FFT	246
SElect:MATH	247
SElect:REF<x>	248
SET?	249
SETUP<x>:DATE?	250
SETUP<x>:TIME? (Query Only)	250
SOCKETServer:SOCKETCURRENTPort?	251
SOCKETServer:SOCKETPort	251
SOCKETServer:SOCKETPROtocol	252
SOCKETServer:SOCKETSTatus	254
SOCKETServer:SOCKETSTORE	255
*SRE	256
*STB?	257

## T commands

TEKSecure	259
TIME	259
TRIGger	260
TRIGger:A	261
TRIGger:A:EDGE?	262
TRIGger:A:EDGE:COUPling	262
TRIGger:A:EDGE:SLOpe	263
TRIGger:A:EDGE:SOUrce	264
TRIGger:A:HOLDOff?	265
TRIGger:A:HOLDOff:TIME	265
TRIGger:A:LEVel	266
TRIGger:A:LEVel:CH<x>	267
TRIGger:A:LOWerthreshold:CH<x>	267
TRIGger:A:MODE	268
TRIGger:A:PULse?	269
TRIGger:A:PULse:CLAss	270
TRIGger:A:PULSE:Width?	271
TRIGger:A:PULse:WIDth:POLarity	271
TRIGger:A:PULSEWidth:SOUrce	272
TRIGger:A:PULse:WIDth:WHEN	272
TRIGger:A:PULse:WIDth:WIDth	274

TRIGger:A:RUNT?	275
TRIGger:A:RUNT:POLarity	275
TRIGger:A:RUNT:SOUrce	276
TRIGger:A:RUNT:WHEn	277
TRIGger:A:RUNT:WIDth	278
TRIGger:A:TYPe	278
TRIGger:A:UPPerthreshold:CH<x>	279
TRIGger:FREQuency?	280
TRIGger:STATE?	280

## U commands

UNLock	283
--------	-----

## V commands

VERBose	285
---------	-----

## W commands

*WAI	287
WAVFrm?	288
WFMInpre?	288
WFMInpre:BIT_Nr	289
WFMInpre:BYT_Nr	290
WFMInpre:ENCdg	290
WFMInpre:NR_Pt?	291
WFMInpre:XINcr	292
WFMInpre:XUNit	292
WFMInpre:XZero	293
WFMInpre:YMUlt	294
WFMInpre:YOff	295
WFMInpre:YUNit	296
WFMInpre:YZero	297
WFMOutpre?	298
WFMOutpre:BIT_Nr	298
WFMOutpre:BN_Fmt	299
WFMOutpre:BYT_Nr	300
WFMOutpre:ENCdg	301
WFMOutpre:NR_Pt?	302
WFMOutpre:RECOrdlength?	302

WFMOutpre:WFId? .....	303
WFMOutpre:XINcr? .....	304
WFMOutpre:XUNit? .....	304
WFMOutpre:XZEro? .....	305
WFMOutpre:YMUlt? .....	306
WFMOutpre:YOFf? .....	306
WFMOutpre:YUNit? .....	307
WFMOutpre:YZEro? .....	308

## Z commands

ZOOM? .....	309
ZOOm{:MODE :STATE} .....	309
ZOOM:ZOOM1? .....	310
ZOOM:ZOOM1:FACTOR .....	311
ZOOM:ZOOM1:HORizontal:POSition .....	311
ZOOM:ZOOM1:HORizontal:SCAle .....	312
ZOOm:ZOOM1:POSition .....	313
ZOOM:ZOOM1:SCAle .....	313
ZOOM:ZOOM1:STATE .....	314

## Status and Events

Registers .....	315
Overview .....	315
Status Registers .....	315
Enable Registers .....	318
*PSC Command .....	319
Queues .....	319
Output Queue .....	319
Event Queue .....	320
Event Handling Sequence .....	320
Synchronization Methods .....	322
Overview .....	322
Using the *WAI Command .....	324
Using the BUSY Query .....	324
Using the *OPC Command .....	325
Using the *OPC? Query .....	327
Messages .....	328
No Event .....	328



Command Error .....	328
Execution Error .....	329
Device Error .....	332
System Event .....	332
Execution Warning .....	333
Internal Warning .....	333

## **Programming Examples**

## **ASCII Code Chart**

## **Factory setup**

TBS2000B Series Oscilloscopes .....	339
-------------------------------------	-----

## **Reserved words**

## **Glossary**

Glossary terms .....	343
----------------------	-----



---

# Getting Started

This manual contains information on how to remotely control and operate your instrument through communications protocol and commands.

Refer to the instrument user manual for information on how to configure and test your instrument remote connectivity (USB or Ethernet).

Download the latest version of the programmer manual from [www.tek.com/downloads](http://www.tek.com/downloads) for up-to-date command syntax information.

## Setting Up Remote Communications Software

### Using a Socket Server

A socket server provides two-way communication over an Internet Protocol-based computer network. You can use your oscilloscope's socket server feature to let your oscilloscope talk to a remote-terminal device or computer.

Follow the steps to set up and use a socket server between your oscilloscope and a remote terminal or computer:

1. Connect the oscilloscope to your computer network with an appropriate Ethernet cable.
2. Push **Utility**.
3. Select Config using Bezel button.
4. Turn multipurpose knob and select Socket Server.
5. Push the **Socket Server**.
6. On the resulting Socket Server side menu, push the top entry to highlight Enabled.
7. Choose whether the protocol should be None or Terminal.

A communication session run manually by using a keyboard typically uses a terminal protocol. An automated session might handle its own communications without using such a protocol.

8. If required, change the port number by pushing **Select Port** rotating multipurpose knob and pushing to set the value.
9. Press **Set Port** to set the new port number.
10. After setting up the socket server parameters, configure the computer to communicate to the oscilloscope. If you are using an MS Windows PC, you could run its default client with its command-like interface. One way to do this is by typing "Telnet" in the Run window.

The Telnet window will open on the PC.

---

**NOTE.** On MS Windows 7, you must first enable Telnet in order for it to work.

---

11. Start a terminal session between your computer and your oscilloscope by typing in an open command with the oscilloscope's LAN address and port #. You can obtain the LAN address by pushing the Ethernet configure from Config menu and the resulting LAN Settings menu item to view the resulting LAN Setting screen. You can obtain the port # by pushing the Socket Server menu item under Config menu and viewing the Current Port menu item.

For example, if the oscilloscope IP address was 123.45.67.89 and the port # was the default of 4000, you could open a session by writing into the MS Windows Telnet screen:

o 123.45.67.89 4000

12. You can now type in a standard query, as found in the programmer manual, such as \*idn?

The Telnet session window will respond by displaying a character string describing your instrument. You can type in more queries and view more results on this Telnet session window. You can find the syntax for relevant queries and related status codes in other sections of this manual.

---

**NOTE.** *Do not use the computer's backspace key during an MS Windows Telnet session with the oscilloscope.*

---

---

# Command Syntax

You can control the instrument through the Ethernet or USB interface using a large group of commands and queries.

This section describes the syntax these commands and queries use and the conventions the instrument uses to process them. The commands and queries themselves are listed in the *Command Descriptions* section.

## Command Syntax

**Table 1: Instrument communication protocol**

Model or option	GPIB	RS-232	USB
TBS2000B	Yes <sup>1</sup>	No	Yes

You transmit commands to the instrument using the enhanced American Standard Code for Information Interchange (ASCII) character encoding. *Appendix A* contains a chart of the ASCII character set.

The Backus Naur Form (BNF) notation is used in this manual to describe commands and queries.

**Table 2: BNF notation**

Symbol	Meaning
< >	Defined element
::=	Is defined as
	Exclusive OR
{ }	Group; one element is required
[ ]	Optional; can be omitted
...	Previous element(s) may be repeated
( )	Comment

---

<sup>1</sup> Function available with a TEK-USB-488 adapter.

## Command and Query Structure

Commands consist of set commands and query commands (usually simply called commands and queries). Commands change instrument settings or perform a specific action. Queries cause the instrument to return data and information about its status.

Most commands have both a set form and a query form. The query form of the command is the same as the set form except that it ends with a question mark. For example, the set command ACQUIRE:MODE has a query form ACQUIRE:MODE?. Not all commands have both a set and a query form; some commands are set only and some are query only.

A few commands do both a set and query action. For example, the \*CAL? command runs a self-calibration program on the instrument, then returns the result of the calibration.

A command message is a command or query name, followed by any information the instrument needs to execute the command or query. Command messages consist of five different element types.

**Table 3: Command message elements**

Symbol	Meaning
<Header>	The basic command name. If the header ends with a question mark, the command is a query. The header may begin with a colon (:) character; if the command is concatenated with other commands the beginning colon is required. The beginning colon can never be used with command headers beginning with a star (*).
<Mnemonic>	A header subfunction. Some command headers have only one mnemonic. If a command header has multiple mnemonics, they are always separated from each other by a colon (:) character.
<Argument>	A quantity, quality, restriction, or limit associated with the header. Not all commands have an argument, while other commands have multiple arguments. Arguments are separated from the header by a <Space>. Arguments are separated from each other by a <Comma>.
<Comma>	A single comma between arguments of multiple-argument commands. It may optionally have white space characters before and after the comma.
<Space>	A white space character between command header and argument. It may optionally consist of multiple white space characters.

The following figure shows the five command message elements.

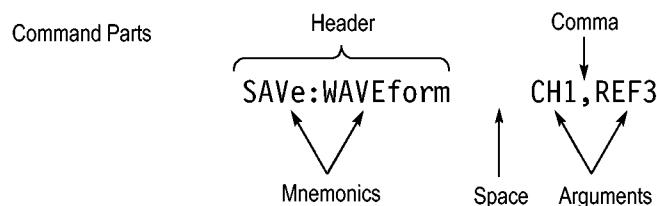

**Figure 1: Command message elements**

**Commands** Commands cause the instrument to perform a specific function or change one of its settings. Commands have the structure:

[:]<Header>[<Space><Argument>[<Comma><Argument>]...]

A command header is made up of one or more mnemonics arranged in a hierarchical or tree structure. The first mnemonic is the base or root of the tree and each subsequent mnemonic is a level or branch off of the previous one. Commands at a higher level in the tree may affect those at a lower level. The leading colon (:) always returns you to the base of the command tree.

**Queries** Queries cause the instrument to return information about its status or settings. Queries have the structure:

[:]<Header>

[:]<Header>[<Space><Argument>[<Comma><Argument>]...]

You can specify a query command at any level within the command tree unless otherwise noted. These branch queries return information about all the mnemonics below the specified branch or level.

For example, MEASUrement:MEAS<x>:UNIts? returns the measurement units, while MEASUrement:MEAS<x>:TYPe? returns the measurement type selected for the measurement, and MEASUrement:MEAS<x>? returns all the measurement parameters for the specified measurement.

### Headers in Query Responses

You can control whether the instrument returns headers as part of the query response. Use the `HEADer` command to control this feature. If header is on, the instrument returns command headers as part of the query and formats the query response as a valid set command. When header is off, the instrument sends back only the values in the response. This format can make it easier to parse and extract the information from the response.

**Table 4: Comparison of Header Off and Header On responses**

Query	Header Off response	Header On response
ACQuire:NUMAVg	64	ACQUIRE:NUMAVG 64
CHx1:COUPling	DC	CH1:COUPLING DC

### Clearing the Output Queue

To clear the output queue and reset the instrument to accept a new command or query, send a Device Clear (DCL) from a GPIB host.

From an RS-232 host, send a break signal. The RS-232 interface responds by returning the ASCII string "DCL."

From a USB host, send an `INITIATE_CLEAR` followed by a `CHECK_CLEAR_STATUS`. The USB interface responds to `CHECK_CLEAR_STATUS` with `STATUS_SUCCESS` when it is finished clearing the output queue.

## Command Entry

Follow these general rules when entering commands:

- Enter commands in upper or lower case.
- You can precede any command with white space characters. White space characters include any combination of the ASCII control characters 00 through 09 and 0B through 20 hexadecimal (0 through 9 and 11 through 32 decimal).
- The instrument ignores commands that consists of just a combination of white space characters and line feeds.



**Abbreviating Commands**

You can abbreviate many instrument commands. These abbreviations are shown in capital letters in the command listing in the *Command Groups* section and *Command Descriptions* section. For example, the command ACQUIRE:NUMAVg can be entered simply as ACQ:NUMA or acq:numa.

If you use the HEADER command to have command headers included as part of query responses, you can also control whether the returned headers are abbreviated or are full-length using the VERBOSE command.

**Concatenating Commands**

You can concatenate any combination of set commands and queries using a semicolon (;). The instrument executes concatenated commands in the order received. When concatenating commands and queries you must follow these rules:

- Completely different headers must be separated by both a semicolon and by the beginning colon on all commands but the first. For example, the commands TRIGGER:MODE NORMAL and ACQUIRE:NUMAVg 16 can be concatenated into a single command:

```
TRIGGER:MODE NORMAL;:ACQUIRE:NUMAVg 16
```

- If concatenated commands have headers that differ by only the last mnemonic, you can abbreviate the second command and eliminate the beginning colon. For example, the commands ACQUIRE:MODE AVERAGE and ACQUIRE:NUMAVg 16 could be concatenated into a single command:

```
ACQUIRE:MODE AVERAGE; NUMAVg 16
```

The longer version works equally well:

```
ACQUIRE:MODE AVERAGE;:ACQUIRE:NUMAVg 16
```

- Never precede a star (\*) command with a colon or semicolon:

```
ACQUIRE:MODE AVERAGE;*TRG
```

The instrument processes commands that follow the star command as if the star command was not there, so:

```
ACQUIRE:MODE AVERAGE;*TRG;NUMAVg 16
```

sets the acquisition mode to average and sets acquisition averaging to 16. The \*TRG command is ignored.

- When you concatenate queries, the responses to all queries are combined into a single response message. For example, if channel 1 coupling is set to DC and the bandwidth is set to 20 MHz, the concatenated query:

```
CH1:COUPLING;BANDWIDTH
```

returns CH1:COUPLING DC;:CH1:BANDWIDTH ON if header is on, or DC;ON if header is off.

- You can concatenate set commands and queries in the same message. For example:

```
ACQUIRE:MODE AVERAGE;NUMAVg;STATE
```

is a valid message that sets the acquisition mode to average, queries the number of acquisitions for averaging, and then queries the acquisition state. The instrument executes concatenated commands and queries in the order it receives them.

- Any query that returns arbitrary data, such as ID, must be the last query when part of a concatenated command. If the query is not last, the instrument generates event message 440.

Here are some INVALID concatenation examples:

- CH1:COUPling DC;ACQuire:NUMAVg 16 (missing colon before ACQuire)
- CH1:COUPling DC;:BANDwidth ON (invalid colon before BANDwidth)
- CH1:COUPling DC;:\*TRG (invalid colon before a star (\*) command)
- HORizontal:MAIn:POSition 0;MAIn:SCAlE 1E-13 (levels of mnemonics are different; either remove the second occurrence of MAIn:, or put HORizontal: in front of MAIN:SCAlE)

### Message Terminators

This manual uses the term <EOM> (End of message) to represent a message terminator.

**GPIB End of Message (EOM) Terminators.** GPIB EOM terminators can be the END message (EOI asserted concurrently with the last data byte), the ASCII code for line feed (LF) sent as the last data byte, or both. The instrument always terminates messages with LF and EOI. White space is allowed before the terminator; for example, CR LF is acceptable.

**USB End of Message (EOM) Terminators.** The EOM bit must be set in the USB header of the last transfer of a command message

See the USB Test and Measurement Class Specification (USBTMC) section 3.2.1 for details. The instrument terminates messages by setting the EOM bit in the USB header of the last transfer of a message to the host (USBTMC Specification section 3.3.1), and by terminating messages with a LF. White space is allowed before the terminator; for example, CR LF is acceptable.

## Constructed Mnemonics

Some header mnemonics specify one of a range of mnemonics. For example, a channel mnemonic could be CH2. You can use these mnemonics in the command just as you do any other mnemonic. For example, there is a CH1:VOLts command and there is also a CH2:VOLts command. In the command descriptions, this list of choices is abbreviated CH<x>.

**Channel mnemonics** Commands specify the channel to use as a mnemonic in the header.

Symbol	Meaning
CH<x>	2-channel models: A channel specifier; <x> is 1 or 2. 4-channel models: A channel specifier; <x> is 1, 2, 3, or 4.

**Reference Waveform Mnemonics** Commands can specify the reference waveform to use as a mnemonic in the header.

Symbol	Meaning
REF<x>	2-channel models: A reference waveform specifier; <x> is 1 or 2. 4-channel models: A reference waveform specifier; <x> is 1 or 2.

**Waveform Mnemonics** In some commands you can specify a waveform without regard to its type: channel waveform, math waveform, or reference waveform. The "y" is the same as "x" in Reference Waveform Mnemonics.

Symbol	Meaning
<wfm>	Can be CH<x>, MATH, or REF<y>

### Cursor Position Mnemonic

When the instrument displays cursors, commands may specify which cursor of the pair to use.

Symbol	Meaning
POSITION<x>	A cursor selector; <x> is 1 or 2.

### Measurement Specifier Mnemonics

Commands can specify which measurement to set or query as a mnemonic in the header. The instrument can display up to six automated measurements.

Symbol	Meaning
MEAS<x>	A measurement specifier; <x> is 1-6.

## Argument Types

A command argument can be in one of several forms. The individual descriptions of each command tell which argument types to use with that command.

### Numeric Arguments

Many instrument commands require numeric arguments.

**Table 5: Types of numeric arguments**

Symbol	Meaning
<NR1>	Signed integer value
<NR2>	Floating point value without an exponent
<NR3>	Floating point value with an exponent

The syntax shown is the data format that the instrument returns in response to a query. This format is also the preferred format when sending a command to the instrument.

When you enter an incorrect numeric argument, the instrument automatically forces the numeric argument to a correct value.

**Table 6: Instrument handling of incorrect numeric arguments**

Argument value	Instrument response
Numeric argument is less than lowest correct value for that command	Sets the specified command to the lowest correct value and executes the command
Numeric argument is greater than the highest correct value for that command	Sets the specified command to the highest correct value and executes the command
Numeric value is between two correct values	Rounds the entered value to the nearest correct value and executes the command

**Quoted String Arguments**

Some commands accept or return data in the form of a quoted string, which is simply a group of ASCII characters enclosed by single quotes (') or double quotes ("). For example:

"this is a quoted string"

Symbol	Meaning
<QString>	Quoted string of ASCII text

Follow these rules when you use quoted strings:

1. A quoted string can include any character defined in the 7-bit ASCII character set. *ASCII Code Chart* on page 337.
2. Use the same type of quote character to open and close the string:  
"this is a valid string"
3. You can mix quotation marks within a string if you follow the previous rule:  
"this is an 'acceptable' string"
4. You can include a quote character within a string simply by repeating the quote. For example,  
"here is a "" mark"
5. Strings can have upper or lower case characters.
6. If you use a GPIB network, you cannot terminate a quoted string with the END message before the closing delimiter.
7. A carriage return or line feed embedded in a quoted string does not terminate the string, but is treated as just another character in the string.
8. The maximum length of a quoted string returned from a query is 1000 characters.

Here are some examples of invalid strings:

"Invalid string argument' (quotes are not of the same type)

"test<EOI>" (termination character is embedded in the string)

**Block Arguments**

Several instrument commands use a block argument form.

**Table 7: Parts of a block argument**

Symbol	Meaning
<NZDig>	A nonzero digit character, in the range 1-9 Specifies the number of <Dig> elements that follow
<Dig>	A digit character, in the range 0-9
<DChar>	A character with the hex equivalent of 00 through FF hexadecimal (0 through 255 decimal)
<Block>	A block of data bytes, defined as: <Block> := { #<NZDig><Dig>[<Dig>...] [<DChar>...]   #0[<DChar>...]<terminator> }

The following figure shows an example of a block argument.

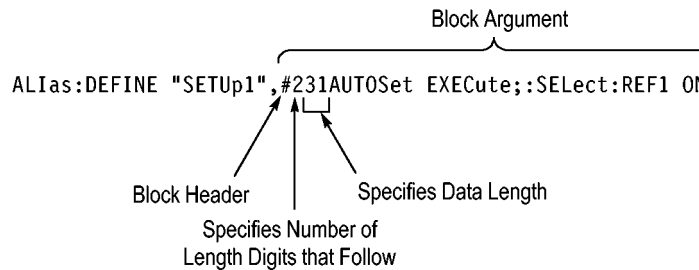

**Figure 2: Block argument example**

<NZDig> specifies the number of <Dig> elements that follow. Taken together, the <Dig> elements form a decimal integer that specifies how many <DChar> elements follow.

#0 means that the <Block> is an indefinite length block. The <terminator> ends the block. You should not use indefinite length blocks with RS-232, because there is no way to include a <terminator> character as a <DChar> character.

The first occurrence of a <terminator> character signals the end of the block and any subsequent <DChar> characters will be interpreted as a syntax error. With the GPIB, the EOI line signals the last byte. With the USB, the EOM bit signals the last byte.

# Command groups

This section lists the commands organized by functional group. The following sections lists all commands alphabetically.

The instrument GPIB and USB interfaces conform to Tektronix standard codes and formats except where noted. The GPIB interface also conforms to IEEE Std 488.2–1987 except where noted. The USB interface also conforms to USB Test and Measurement Class, Subclass USB488 Specification, except where noted.

## Alias command group

Use the Alias commands to define new commands as a sequence of standard commands. You may find this useful when repeatedly using the same commands to perform certain tasks like setting up measurements.

Aliases are similar to macros but do not include the capability to substitute parameters into alias bodies. The alias mechanism obeys the following rules:

- The alias name must consist of a valid IEEE488.2 message unit, which may not appear in a message preceded by a colon, comma, or a command or query program header.
- The alias name may not appear in a message followed by a colon, comma, or question mark.
- An alias name must be distinct from any keyword or keyword short form.
- An alias name cannot be redefined without first being deleted using one of the alias deletion functions.
- Alias names do not appear in response messages.

**Table 8: Alias commands**

Command	Command
<a href="#">ALias</a> on page 47	Sets or returns the alias state.
<a href="#">ALias:CATalog?</a> on page 48	Returns a list of the currently defined alias.
<a href="#">ALias:DEFine</a> on page 49	Assigns a sequence of program messages.
<a href="#">ALias:DELEte</a> on page 50	Removes a specified alias.
<a href="#">ALias:DELEte:ALL</a> on page 50	Deletes all existing aliases.
<a href="#">ALias:DELEte[:NAME]</a> on page 51	Removes a specified alias.
<a href="#">ALias[:STATE]</a> on page 51	Sets or returns the alias state.

## Acquisition command group

Acquisition commands affect the acquisition of waveforms. These commands control mode, averaging, and single-waveform acquisition.

**Table 9: Acquisition commands**

Command	Command
<a href="#">ACQUIRE?</a> on page 41	Returns current acquisition settings.
<a href="#">ACQUIRE:MAXSAMPLERATE?</a> on page 42	Returns the maximum real-time sample rate.
<a href="#">ACQUIRE:MODE</a> on page 42	Sets or queries the instrument acquisition mode.
<a href="#">ACQUIRE:NUMACQ?</a> on page 44	Indicates the number of acquisitions that have taken place since starting instrument acquisition.
<a href="#">ACQUIRE:NUMAVG</a> on page 45	Sets the number of instrument waveform acquisitions that make up an averaged waveform.
<a href="#">ACQUIRE:STATE</a> on page 45	Starts or stops instrument acquisitions.
<a href="#">ACQUIRE:STOPAFTER</a> on page 46	Tells the instrument when to stop taking acquisitions.

## Calibration and Diagnostic command group

Calibration and Diagnostic commands let you initiate the instrument self-calibration routines and examine the results of diagnostic tests.

**Table 10: Calibration and Diagnostic commands**

Command	Description
<a href="#">*CAL?</a> on page 57	Performs an internal self-calibration and returns its status.
<a href="#">CALIBRATE:INTERNAL</a> on page 58	Performs an internal self-calibration but does not return any status.
<a href="#">CALIBRATE:INTERNAL:START</a> on page 58	Starts the internal signal path calibration.
<a href="#">CALIBRATE:INTERNAL:STATUS?</a> on page 59	Returns the current status of the internal signal path calibration.
<a href="#">CALIBRATE:RESULTS?</a> on page 60	Returns the status of all calibration subsystems without performing an SPC operation.
<a href="#">CALIBRATE:RESULTS:SPC?</a> on page 60	Returns the results of the last SPC operation
<a href="#">DIAG:LOOP:OPTION</a> on page 103	Sets the self-test loop option
<a href="#">DIAG:LOOP:OPTION:NTIMES</a> on page 104	Sets the self-test loop option to run N times
<a href="#">DIAG:LOOP:STOP</a> on page 104	Stops the self-test at the end of the current loop
<a href="#">DIAG:RESULT:FLAG?</a> on page 105	Returns the Pass/Fail status from the last diagnostic test sequence execution (those run automatically at power on, or those requested through the Service Menu).



Command	Description
<a href="#">DIAG:RESUlt:LOG?</a> on page 105	Returns the internal results log from the last diagnostic test sequence execution (those run automatically at power on, or those requested through the Service Menu).
<a href="#">DIAG:SElect</a> on page 106	Sets the type of diagnostics grouping.
<a href="#">DIAG:SElect:&lt;function&gt;</a> on page 107	Runs self-tests on the specified system subsystem.
<a href="#">DIAG:STATE</a> on page 107	Starts or stops the instrument self-test.
<a href="#">DIAG:FAN</a> on page 103	Read out the currently set PWM fan value
<a href="#">DIAG:TEMPVAL</a> on page 108	Read out the currently FPGA chip and ambient temperature

## Cursor command group

Cursor commands provide control over the instrument cursor display and readout.

Use the commands in the cursor command subsystem to control the cursor display and readout. You can use these commands to control the setups for cursor 1 and cursor 2, such as cursor position. You can also use the commands to select one of the following cursor functions:

Off. Turns off the display of all cursors.

Waveform Cursors. Consists of two cursors. Waveform cursors enable you to conveniently measure waveform amplitude and time.

Screen Cursors. Consists of two pairs of independent horizontal and vertical cursors.

You can use these cursors to indicate an arbitrary position within the waveform display area.

**Table 11: Cursor commands**

Command	Description
<a href="#">CURSor?</a> on page 80	Returns current cursor settings.
<a href="#">CURSor:ENABLE</a> on page 81	Allows educators to disable or enable the Cursor functions. The function can be manually set from the Utility menu. To access the menu, refer to the product user manual.
<a href="#">CURSor:FUNction</a> on page 82	Selects and displays the instrument cursor type.
<a href="#">CURSor:HBArs?</a> on page 83	Returns the settings for the instrument horizontal bar cursors.
<a href="#">CURSor:HBArs:DELta?</a> on page 83	Returns the difference (in vertical units) between the two horizontal bar cursors in the instrument display.

Command	Description
<a href="#">CURSor:HBARs:POSITION&lt;x&gt;</a> on page 84	Positions a horizontal bar cursor.
<a href="#">CURSor:HBARs:UNIts</a> on page 85	Returns the vertical scale units for the selected cursor source waveform.
<a href="#">CURSor:HBARs:USE</a> on page 85	Sets the horizontal bar cursor measurement scale.
<a href="#">CURSor:MODE</a> on page 86	Sets or returns whether cursors move in unison or separately.
<a href="#">CURSor:VBARs?</a> on page 87	Returns the current vertical bar cursor horizontal position and units settings.
<a href="#">CURSor:VBARs:ALTERNATE&lt;x&gt;?</a> on page 87	Returns the alternate readout for the waveform (Vbar) cursors.
<a href="#">CURSor:VBARs:DELTA?</a> on page 88	Returns the time or frequency difference between the two vertical bar cursors.
<a href="#">CURSor:VBARs:HPOS&lt;x&gt;?</a> on page 89	Returns the horizontal value of the specified vertical bar ticks for cursor <x>
<a href="#">CURSor:VBARs:POSITION&lt;x&gt;</a> on page 89	Sets or returns the vbar cursor<x> horizontal position
<a href="#">CURSor:VBARs:UNIts</a> on page 90	Sets or queries the units for the vertical bar cursors.
<a href="#">CURSor:VBARs:VDELTA?</a> on page 91	Returns the vertical (amplitude) difference between the two vertical bar cursors.

## Display command group

These commands provide control of the Display feature.

**Table 12: Display commands**

Command	Description
<a href="#">DISplay:GRATICule</a> on page 108	Sets or queries the Graticule state.
<a href="#">DISplay:INTENSITy:BACKLight</a> on page 109	Sets or queries the display Backlight.
<a href="#">DISplay:PERsistence:STATe</a> on page 110	Sets or returns the display persistence to ON or OFF. The query form returns the persistence state. This affects the display only.
<a href="#">DISplay:PERsistence:VALUe</a> on page 110	Sets the value of persistence if the persistence state is set to on. This affects the display only.

## Ethernet command group

These commands provide control of the Ethernet feature.

**Table 13: Ethernet commands**

Command	Description
<a href="#">ETHERnet:DHCPbootp</a> on page 116	IP configuration method selection? DHCP or static ip?
<a href="#">ETHERnet:DNS:IPADdress</a> on page 117	DNS IP address set or query.
<a href="#">ETHERnet:DOMAINname</a> on page 117	Domain name set or query.
<a href="#">ETHERnet:ENET:ADdress?</a> on page 118	Mac query only.
<a href="#">ETHERnet:GATEWay:IPADdress</a> on page 118	Gateway ip set or query.
<a href="#">ETHERnet:HTTTPort</a> on page 119	Http port set or query.
<a href="#">ETHERnet:IPADdress</a> on page 120	Ip address set or query.
<a href="#">ETHERnet:NAME</a> on page 120	Name set or query.
<a href="#">ETHERnet:PASSWord</a> on page 121	Password set or query.
<a href="#">ETHERnet:PING</a> on page 121	Do ping operation.
<a href="#">ETHERnet:PING:STATUS?</a> on page 122	Return ping status: success, no response and others.
<a href="#">ETHERnet:SUBNETMask</a> on page 123	Netmask set or query.
<a href="#">SOCKETServer:SOCKETCURRENTPort?</a> on page 251	Queries the current TCPIP port of the socket server connection.
<a href="#">SOCKETServer:SOCKETPort</a> on page 251	Configures the TCPIP port for the socket server connection.
<a href="#">SOCKETServer:SOCKETPROtocol</a> on page 252	Sets the protocol for the socket server.
<a href="#">SOCKETServer:SOCKETSTatus</a> on page 254	Enables or disables the socket server which supports a Telnet or other TCP/IP socket connection to send commands and queries to the instrument.
<a href="#">SOCKETServer:SOCKETSTORE</a> on page 255	Sets the selected TCPIP port for the socket server connection by restarting the socket server on the selected port.

## FFT command group

These commands provide control over the instrument FFT feature.

**Table 14: FFT commands**

Command	Description
<a href="#">FFT?</a> on page 129	Returns all FFT parameters.
<a href="#">FFT:HORizontal:POSition</a> on page 129	Sets or queries the FFT horizontal display position.
<a href="#">FFT:HORizontal:SCAle</a> on page 130	Sets or queries the FFT zoom factor.
<a href="#">FFT:SOURce</a> on page 130	Sets or queries the FFT source.
<a href="#">FFT:SRCWFM</a> on page 131	Sets or queries the FFT source waveform display state.
<a href="#">FFT:VERTical:POSition</a> on page 132	Sets or queries the FFT vertical display position.
<a href="#">FFT:VERTical:SCAle</a> on page 132	Sets or queries the FFT vertical zoom factor.
<a href="#">FFT:VERTical:UNIts</a> on page 133	Sets or returns the FFT vertical measurement units label.
<a href="#">FFT:VType</a> on page 133	Sets or queries the FFT waveform vertical units.
<a href="#">FFT:WINDow</a> on page 134	Sets or queries the FFT window state.
<a href="#">SElect:FFT</a> on page 246	Sets or queries the FFT display state.

## File system command group

File system commands perform file management tasks.

**Table 15: File system commands**

Command	Description
<a href="#">FILESystem?</a> on page 134	Returns the directory listing of the current working directory and the number of bytes of free space available.
<a href="#">FILESystem:CWD</a> on page 135	Sets or queries returns the current working directory (CWD) for FILESystem commands.
<a href="#">FILESystem:DELEte</a> on page 136	Deletes the specified file name.
<a href="#">FILESystem:DIR?</a> on page 137	Returns a list of strings.
<a href="#">FILESystem:FORMat</a> on page 138	Formats a mass storage device.
<a href="#">FILESystem:FREESpace?</a> on page 138	Returns the number of bytes of free space on the current drive.
<a href="#">FILESystem:MKDir</a> on page 139	Creates a folder at the specified location.
<a href="#">FILESystem:READFile</a> on page 140	Writes the contents of the specified file to the specified interface
<a href="#">FILESystem:REName</a> on page 140	Assigns a new name to a file or folder.

Command	Description
<a href="#">FILESystem:RMDir</a> on page 141	Deletes a folder at the specified location.
<a href="#">FILESystem:WRITEFile</a> on page 142	Writes the specified block data to the instrument current working directory

## File System Conventions

Use the following conventions when specifying file paths and file names:

- File and folder names have a maximum of 11 characters; eight characters, followed by a period, followed by up to three characters. This format is referred to as 8.3 naming.
- Wild card characters (\*, %, ) are not valid characters in file or path names.
- Lists the Windows-generated short file and folder names for long file or folder names created on PC Windows operating systems.

## Help everywhere command group

Help everywhere commands provide helpful user information.

**Table 16: Help everywhere commands**

Command	Description
<a href="#">HELPevery:ACQuire</a> on page 148	Enables or disables the display of help everywhere information for the acquire module.
<a href="#">HELPevery:ALL</a> on page 149	Enables or disables the display of help everywhere.
<a href="#">HELPevery:FFT</a> on page 150	Enables or disables the display of help everywhere information for the fft module.
<a href="#">HELPevery:CURsor</a> on page 149	Enables or disables the display of help everywhere information for the cursor module.
<a href="#">HELPevery:MATH</a> on page 150	Enables or disables the display of help everywhere information for the math module.
<a href="#">HELPevery:MEASUrement</a> on page 151	Enables or disables the display of help everywhere information for the measurement module.
<a href="#">HELPevery:REFerence</a> on page 152	Enables or disables the display of help everywhere information for the reference module.
<a href="#">HELPevery:SEARCH</a> on page 152	Enables or disables the display of Help Everywhere information for the search module.
<a href="#">HELPevery:TRIGger</a> on page 153	Enables or disables the display of help everywhere information for the trigger module.

Command	Description
<a href="#">HELPevery:UTILITY</a> on page 154	Enables or disables the display of help everywhere information for the utility module.
<a href="#">HELPevery:VERTical</a> on page 154	Enables or disables the display of help everywhere information for the vertical module.

## Horizontal command group

Horizontal commands control the time bases of the instrument. You can set the position and time per division of both the main and window time bases. You can substitute SECdiv for SCALE in all appropriate horizontal commands. This provides program compatibility with previous Tektronix digitizing instruments.

**Table 17: Horizontal commands**

Command	Description
<a href="#">HORizontal?</a> on page 155	Returns all settings for the horizontal commands.
<a href="#">HORizontal[:MAIN]:SCALE</a> on page 161	Sets or queries the time base horizontal scale.
<a href="#">HORizontal[:MAIN]:SECdiv</a> on page 162	Specifies the horizontal time/div.
<a href="#">HORizontal:TRIGger:POSition</a> on page 166	Same as :HORizontal:POSition.
<a href="#">HORizontal:TRIGger:POSition</a> on page 166	Set or queries the trigger position.
<a href="#">HORizontal[:MAIN][:DELay]:POSition</a> on page 157	Sets or returns the horizontal position, as percent of record, that is used when HORizontal:DELay:MODE is set to OFF.
<a href="#">HORizontal:MAIN:DELay:MODE</a> on page 158	The boolean argument type sets delay mode to on or off.
<a href="#">HORizontal:MAIN:DELay:STATE</a> on page 159	Same as HORizontal:DELay:MODE.
<a href="#">HORizontal[:MAIN]:DELay:TIME</a> on page 160	Specifies the delay time in time units.
<a href="#">HORizontal:RESOLution</a> on page 165	Same as HORizontal:RECOrdlength.
<a href="#">HORizontal:RECOrdlength</a> on page 163	Sets or queries the horizontal record length.
<a href="#">HORizontal:RECOrdlength:Auto</a> on page 164	Sets or queries the record length mode.
<a href="#">HORizontal:ACQLENGTH</a> on page 156	Queries the record length.
<a href="#">HORizontal:PREViewstate</a> on page 163	Returns a boolean to indicate whether the acquisition system is in the preview state
<a href="#">HORizontal[:MAIN]:SAMPLERate</a> on page 160	Returns the sample rate
<a href="#">HORizontal:MAIN:UNIts[:STRing]</a> on page 162	Queries the horizontal units.
<a href="#">HORizontal:DIVisions</a> on page 156	Queries the number of horizontal divisions.
<a href="#">HORizontal:ROLL</a> on page 165	Query the state of roll mode.

## Mark command group

Use the commands in the Mark Command Group to identify areas of the acquired waveform that warrant further investigation.

**Table 18: Mark commands**

Command	Description
<a href="#">MARK</a> on page 171	Move to the next or previous mark on the waveform or returns all learnable settings from the mark commands.
<a href="#">MARK:CREATE</a> on page 172	Creates a mark on a particular waveform or all waveforms in a column.
<a href="#">MARK:DELEte</a> on page 173	Deletes a mark on a particular waveform, all waveforms in a column, or all marks.
<a href="#">MARK:FREE?</a> on page 174	Returns how many marks are free to be used.
<a href="#">MARK:SELEcted:END?</a> on page 174	Returns the end of the selected mark, in terms of 0 to 100% of the waveform.
<a href="#">MARK:SELEcted:FOCUS?</a> on page 174	Returns the focus of the selected mark, in terms of 0 to 100% of the waveform.
<a href="#">MARK:SELEcted:MARKSINCOLumn?</a> on page 175	Returns how many marks are in the current zoom pixel column.
<a href="#">MARK:SELEcted:OWNer?</a> on page 175	Returns the owner of the selected mark.
<a href="#">MARK:SELEcted:SOURCE?</a> on page 176	Returns the source waveform of the selected mark.
<a href="#">MARK:SELEcted:START?</a> on page 176	Returns the start of the selected mark, in terms of 0 to 100% of the waveform.
<a href="#">MARK:SELEcted:STATe?</a> on page 176	Returns the on or off state of the selected mark.
<a href="#">MARK:SELEcted:ZOOM:POSition?</a> on page 177	Returns the position of the selected mark, in terms of 0 to 100% of the upper window.
<a href="#">MARK:TOTal?</a> on page 177	Returns how many marks are used.

## Math command group

Math commands provide math function definition.

**Table 19: Math commands**

Command	Description
<a href="#">MATH?</a> on page 177	Returns the definition for the math waveform.
<a href="#">MATH:DEFINE</a> on page 178	Performs the specified mathematical operation on the input signal or signals.
<a href="#">MATH:HORizontal:POSition</a> on page 179	Sets or returns the horizontal position of the math waveform.
<a href="#">MATH:HORizontal:SCALE</a> on page 180	Sets or returns the horizontal scale of the math waveform.
<a href="#">MATH:HORizontal:UNIts</a> on page 180	Sets or returns the math horizontal measurement units label.
<a href="#">MATH:LABel</a> on page 181	Sets or queries the waveform label for the math waveform.
<a href="#">MATH:VERTical:POSition</a> on page 182	Sets or returns the math waveform display position.
<a href="#">MATH:VERTical:SCALE</a> on page 182	Sets or returns the math waveform display scale in units per division.
<a href="#">MATH:VERTical:UNIts</a> on page 183	Sets or returns the math vertical measurement units label.



## Measurement command group

Measurement commands control the automated measurement system. The instrument can display up to six automated measurements. In the commands, these measurement readouts are named MEAS<x>, where <x> can be 1, 2, 3, 4, 5, or 6.

The best method for taking measurements over the computer interface is to use the MEASUREMENT:IMMED commands and queries. The immediate measurement has no front-panel equivalent, and the instrument never displays immediate measurements.

Because they are computed only when they are requested, immediate measurements slow the waveform update rate less than displayed measurements.

Use the VALue? query to obtain measurement results of either displayed or immediate measurements.

Several measurement commands set and query measurement parameters. You can assign some parameters, such as waveform sources, differently for each measurement readout.

**Table 20: Measurement commands**

Command	Description
<a href="#">MEASUrement?</a> on page 184	Returns the current MEASUrement settings.
<a href="#">MEASUrement:CLEARSNapshot</a> on page 185	Clears the existing snapshot results and removes the snapshot window.
<a href="#">MEASUrement:GATing</a> on page 186	Sets or returns the measurement gating.
<a href="#">MEASUrement:IMMed?</a> on page 187	Returns all immediate measurement setup parameters.
<a href="#">MEASUrement:IMMed:DELAy?</a> on page 187	Returns information about the immediate delay measurement.
<a href="#">MEASUrement:IMMed:DELAy:EDGE&lt;x&gt;</a> on page 188	Sets or returns the slope of the edge used for immediate delay from and to waveform measurements
<a href="#">MEASUrement:IMMed:SOUrce1</a> on page 189	Sets or queries the source for all single source immediate measurements and specifies the source to measure from when taking an immediate delay or phase measurement.
<a href="#">MEASUrement:IMMed:SOUrce2</a> on page 190	Sets or queries the secondary source for dual-source immediate measurements.
<a href="#">MEASUrement:IMMed:TYPe</a> on page 191	Sets or queries the immediate measurement type.
<a href="#">MEASUrement:IMMed:UNIts?</a> on page 193	Returns the units for the immediate instrument measurement.
<a href="#">MEASUrement:IMMed:VALue?</a> on page 194	Executes the immediate instrument measurement specified by the MEASUrement:IMMed:TYPe command.

Command	Description
<a href="#">MEASUrement:MEAS&lt;x&gt;?</a> on page 195	Returns all measurement parameters for the displayed instrument periodic measurement specified by <x>.
<a href="#">MEASUrement:MEAS&lt;x&gt;:DELay?</a> on page 195	Returns the delay measurement parameters for the specified measurement.
<a href="#">MEASUrement:MEAS&lt;x&gt;:DELay:EDGE&lt;x&gt;</a> on page 196	Sets or returns the slope of the edge to use for delay “from” and “to” waveform measurements.
<a href="#">MEASUrement:MEAS&lt;x&gt;:SOUrce1</a> on page 196	Sets or queries the source for all single source measurements and specifies the source to measure from when taking a delay measurement or phase measurement.
<a href="#">MEASUrement:MEAS&lt;x&gt;:SOUrce2</a> on page 197	Sets or queries the reference source to measure to when taking a delay or phase measurement.
<a href="#">MEASUrement:MEAS&lt;x&gt;:STATE</a> on page 198	Sets or returns whether the specified measurement slot is computed and displayed.
<a href="#">MEASUrement:MEAS&lt;x&gt;:TYPe</a> on page 199	Sets or queries the on-screen periodic instrument measurement type for the measurement specified by <x>.
<a href="#">MEASUrement:MEAS&lt;x&gt;:UNIts?</a> on page 202	Returns the units for the instrument measurement specified by MEASUrement:MEAS<x>:TYPe.
<a href="#">MEASUrement:MEAS&lt;x&gt;:VALue?</a> on page 203	Returns the value that was calculated for the instrument on-screen periodic measurement specified by <x>.
<a href="#">MEASUrement:REFLevel?</a> on page 204	Returns the current reference level parameters. Query only.
<a href="#">MEASUrement:REFLevel:ABSolute:LOW</a> on page 204	Sets or returns the low reference level, and is the lower reference level when MEASUrement:REFLevel:METHod is set to Absolute.
<a href="#">MEASUrement:REFLevel:ABSolute:MID1</a> on page 205	Sets or returns the mid reference level, and is the 50% reference level when MEASUrement:REFLevel:METHod is set to Absolute.
<a href="#">MEASUrement:REFLevel:ABSolute:MID2</a> on page 206	Sets or returns the mid reference level for the “to” waveform when taking a delay measurement, and is the 50% reference level when MEASUrement:REFLevel:METHod is set to Absolute.
<a href="#">MEASUrement:REFLevel:METHod</a> on page 207	Specifies or returns the reference level units used for measurement calculations.
<a href="#">MEASUrement:REFLevel:PERCent:HIGH</a> on page 208	Sets or returns the percent (where 100% is equal to HIGH) used to calculate the high reference level when MEASUrement:REFLevel:METHod is set to Percent.

Command	Description
<a href="#">MEASUrement:REFLevel:PERCent:LOW</a> on page 209	Sets or returns the percent (where 100% is equal to HIGH) used to calculate the low reference level when MEASUrement:REFLevel:METHod is set to Percent.
<a href="#">MEASUrement:REFLevel:PERCent:MID1</a> on page 210	Sets or returns the percent (where 100% is equal to HIGH) that is used to calculate the mid reference level when MEASUrement:REFLevel:METHod is set to Percent.
<a href="#">MEASUrement:REFLevel:PERCent:MID2</a> on page 211	Sets or returns the percent (where 100% is equal to HIGH) that is used to calculate the mid reference level for the second waveform specified when MEASUrement:REFLevel:METHod is set to Percent.
<a href="#">MEASUrement:SNAPSHOT</a> on page 212	Sets the measurement snapshot feature.
<a href="#">MEASUrement:SOURCESNAPShot</a> on page 212	Sets or returns the snapshot source.

## Miscellaneous command group

Miscellaneous commands are a group of commands that do not fit into any other category.

Several commands and queries are common to all 488.2-1987 devices on the GPIB or USB bus. These commands and queries are defined by IEEE Std. 488.2-1987 and Tektronix Standard Codes and Formats 1989 and begin with an asterisk (\*) character.

**Table 21: Miscellaneous commands**

Command	Description
<a href="#">AUTOSet</a> on page 53	Causes the instrument to adjust its vertical, horizontal, and trigger controls to display a stable waveform.
<a href="#">AUTOSet:ENABLE</a> on page 53	Allows educators to disable or enable the Autorange and Autoset functions. The function can be manually set from the Utility menu. To access the menu, refer to the product user manual.
<a href="#">CLEARMenu</a> on page 79	Clears the current menu from the display
<a href="#">DATE</a> on page 101	Sets or queries the instrument date value.

Command	Description
<a href="#">FEAEN:PASSWORD</a> on page 128	Checks if the password entered is equal to the preset password for Feature Enable which allows the educators to enable or disable features such as Autoset, Cursors or Measurements. The same can be set manually from the Utility menu when we try to change the settings of Autoset Enable, Cursors Enable or Measurement Enable from Feature Enable.
<a href="#">FPAnel:PRESS</a> on page 143	Simulates the action of pressing a specified front-panel button.
<a href="#">FPAnel:TURN</a> on page 145	Simulates the action of turning a specified front-panel control knob.
<a href="#">FWUpdate:Update</a> on page 146	Update firmware from u-disk.
<a href="#">HDR</a> on page 147	This command is identical to the HEADer query and is included for compatibility with other Tektronix instruments.
<a href="#">HEADer</a> on page 147	Sets and queries the Response Header Enable State that causes the instrument to either include or omit headers on query responses.
<a href="#">ID?</a> on page 167	Returns identifying information about the instrument and its firmware in Tektronix Codes and Formats notation.
<a href="#">*IDN?</a> on page 168	Returns the instrument identification code in IEEE 488.
<a href="#">LANGuage</a> on page 169	Sets or queries the languages that the instrument uses to display information on the screen.
<a href="#">LOCK</a> on page 170	Enables and disables all front-panel buttons and knobs.
<a href="#">*LRN?</a> on page 170	This is identical to the query.
<a href="#">MEASUrement:ENABLE</a> on page 185	Allows educators to disable or enable the Measurement functions. The function can be manually set from the Utility menu. To access the menu, refer to the product user manual.
<a href="#">*RST</a> on page 224	(Reset) Returns the instrument to a known set of instrument settings, but does not purge any stored settings.
<a href="#">SET?</a> on page 249	Returns most instrument settings.
<a href="#">TEKSecure</a> on page 259	Equivalent to invoking Teksecure from the Utility->Config->TekSecure Erase Memory menu.
<a href="#">TIME</a> on page 259	Sets or queries the instrument time value.
<a href="#">UNLock</a> on page 283	Unlocks the front panel.
<a href="#">VERBose</a> on page 285	Sets and queries the Verbose state that controls the length of keywords on query responses.

## Save and Recall command group

Save and Recall commands allow you to store and retrieve internal waveforms and settings. When you "save a setting," you save most of the settings of the instrument. When you then "recall a setting," the instrument restores itself to the state it was in when you saved that setting.

To display a saved waveform, use the `SElect:<wfm>` command.

**Table 22: Save and Recall commands**

Command	Description
<a href="#">FACTory</a> on page 127	Resets the instrument to factory default settings.
<a href="#">*RCL</a> on page 217	Restores the instrument to factory default settings stored in internal nonvolatile memory.
<a href="#">RECAll:SETUp</a> on page 218	Restores the factory-default instrument settings, user-saved settings from internal nonvolatile memory, or user-saved settings from a file on a USB flash drive.
<a href="#">RECAll:WAVEForm</a> on page 219	Recalls a stored waveform from the USB flash drive into a reference location.
<a href="#">*SAV</a> on page 225	Saves the state of the instrument into a specified nonvolatile memory location.
<a href="#">SAVe:ASSIgn:TYPe</a> on page 226	Sets or queries the assignment of the data to be saved.
<a href="#">SAVe:IMAge</a> on page 226	Saves the screen image to a file on the USB flash drive.
<a href="#">SAVe:IMAge:FILEFormat</a> on page 227	Sets the screen image file format used by the <code>SAVe:IMAge</code> command and by the <code>SAVE &gt; Action &gt; Save Image</code> and <code>SAVE &gt; Action &gt; Save All</code> front-panel operations.
<a href="#">SAVe:IMAge:LAYout</a> on page 228	Sets or queries the layout to use for saved screen images.
<a href="#">SAVe:SETUp</a> on page 229	Saves the current state of the instrument into the specified nonvolatile memory location, or to a file on the USB flash drive.
<a href="#">SAVe:WAVEform</a> on page 230	Stores a waveform in one of the nonvolatile reference memory locations, or to a file on the USB flash drive.
<a href="#">SAVe:WAVEform:FILEFormat</a> on page 231	Sets or returns the format for saved waveforms.
<a href="#">SETUP&lt;x&gt;:DATE?</a> on page 250	Returns the date when the specified instrument setup was saved.
<a href="#">SETUP&lt;x&gt;:TIME? (Query Only)</a> on page 250	Returns the time when the specified instrument setup was saved

## Search command group

**Table 23: Search commands**

Command	Description
<a href="#">SEARCH</a> on page 232	Returns all search-related settings. Query only.
<a href="#">SEARCH:SEARCH&lt;x&gt;:COpy</a> on page 232	Copies the search criteria to the trigger, or the trigger criteria to the search. Set only.
<a href="#">SEARCH:SEARCH&lt;x&gt;:STATE</a> on page 233	Sets the search state to on or off. Set only.
<a href="#">SEARCH:SEARCH&lt;x&gt;:TOTAL</a> on page 234	Returns the total number of matches for search <x>. Query only.
<a href="#">SEARCH:SEARCH&lt;x&gt;:TRIGger:A:LEVel</a> on page 234	Sets or returns the level for an edge search.
<a href="#">SEARCH:SEARCH&lt;x&gt;:TRIGger:A:LEVel:CH&lt;x&gt;</a> on page 235	Sets or returns the level for an edge search of the specified channel.
<a href="#">SEARCH:SEARCH&lt;x&gt;:TRIGger:A:LOWerthreshol:d:MATH</a> on page 235	Sets or returns the math waveform lower threshold to determine where to place a mark. This setting is applied to all math searches that use a lower threshold. <x> is the search number.
<a href="#">SEARCH:SEARCH&lt;x&gt;:TRIGger:A:LOWerthreshol:d:REF&lt;x&gt;</a> on page 236	Sets or returns the lower waveform threshold level for all reference waveform searches.
<a href="#">SEARCH:SEARCH&lt;x&gt;:TRIGger:A:TYPe</a> on page 236	Sets or returns the trigger type setting for a search.
<a href="#">SEARCH:SEARCH&lt;x&gt;:TRIGger:A:EDGE:SLOpe</a> on page 237	Sets or returns the slope for an edge trigger search to determine where to place a mark. is the search number.
<a href="#">SEARCH:SEARCH&lt;x&gt;:TRIGger:A:EDGE:SOUrce</a> on page 238	Sets or returns the source waveform for an edge search.
<a href="#">SEARCH:SEARCH&lt;x&gt;:TRIGger:A:LOWerthreshol:d:CH&lt;x&gt;</a> on page 238	Sets or returns the lower waveform threshold level for all channel waveform searches.
<a href="#">SEARCH:SEARCH&lt;x&gt;:TRIGger:A:PULSEWidth:POLarity</a> on page 239	Sets or returns the polarity for a pulse search.
<a href="#">SEARCH:SEARCH&lt;x&gt;:TRIGger:A:PULSEWidth:SOUrce</a> on page 239	Sets or returns the source waveform for a pulse search.
<a href="#">SEARCH:SEARCH&lt;x&gt;:TRIGger:A:PULSEWidth:WHEn</a> on page 240	Sets or returns the condition for generating a pulse width search.
<a href="#">SEARCH:SEARCH&lt;x&gt;:TRIGger:A:PULSEWidth:WIDth</a> on page 240	Sets or returns the pulse width setting for a pulse width search.
<a href="#">SEARCH:SEARCH&lt;x&gt;:TRIGger:A:RUNT:POLarity</a> on page 241	Sets or returns the polarity setting for a runt search.
<a href="#">SEARCH:SEARCH&lt;x&gt;:TRIGger:A:RUNT:SOUrce</a> on page 241	Sets or returns the source setting for a runt search.
<a href="#">SEARCH:SEARCH&lt;x&gt;:TRIGger:A:RUNT:WHEn</a> on page 242	Sets or returns the condition setting for a runt search.

Command	Description
<a href="#">SEARCH:SEARCH&lt;x&gt;:TRIGger:A:RUNT:WIDTH</a> on page 243	Sets or returns the width setting for a runt search.
<a href="#">SEARCH:SEARCH&lt;x&gt;:TRIGger:A:UPPerthresh old:CH&lt;x&gt;</a> on page 243	Sets or returns the waveform upper threshold level for all channel waveform searches.

## Status and Error command group

Status and error commands let you determine the status of the instrument and control events.

Several commands and queries are common to all devices on the GPIB or USB bus. These commands and queries are defined by IEEE Std. 488.2-1987 and Tek Standard Codes and Formats 1989, and begin with an asterisk (\*) character.

**Table 24: Status and Error commands**

Command	Description
<a href="#">ALLEv?</a> on page 52	Causes the instrument to return all events and their messages, and removes the returned events from the Event Queue.
<a href="#">BUSY?</a> on page 55	Returns the status of the instrument.
<a href="#">*CLS</a> on page 79	Clears the Event Queue, Standard Event Status Register, and Status Byte Register (except the MAV bit)..
<a href="#">DESE</a> on page 102	Sets and queries the bits in the Device Event Status Enable Register (DESER).
<a href="#">*ESE</a> on page 114	Sets and queries the bits in the Event Status Enable Register (ESER).
<a href="#">*ESR?</a> on page 115	Returns the contents of the Standard Event Status Register (SESR).
<a href="#">EVENT?</a> on page 123	Returns from the Event Queue an event code that provides information about the results of the last *ESR? read.
<a href="#">EVMsg?</a> on page 124	Removes from the Event Queue a single event code associated with the results of the last *ESR? read, and returns the event code with an explanatory message.
<a href="#">EVQty?</a> on page 125	Return number of events in the event queue.
<a href="#">*OPC</a> on page 213	Generates the operation complete message in the Standard Event Status Register (SESR) when all pending commands that generate an OPC message are complete.
<a href="#">*PSC</a> on page 215	Sets and queries the power-on status flag that controls the automatic power-on handling of the DESER, SRER, and ESER registers.

Command	Description
<a href="#">*RST</a> on page 224	Resets the instrument to factory default settings.
<a href="#">*SRE</a> on page 256	(Service Request Enable) sets and queries the bits in the Service Request Enable Register (SRER).
<a href="#">*STB?</a> on page 257	(Read Status Byte) query returns the contents of the Status Byte Register (SBR) using the Master Summary Status (MSS) bit.
<a href="#">*WAI</a> on page 287	Prevents the instrument from executing further commands or queries until all pending commands that generate an OPC message are complete.

## Trigger command group

Trigger commands control all aspects of instrument triggering.

The three types of triggers are edge, pulse width, and video. Edge triggering is the default type. Edge triggering lets you acquire a waveform when the signal passes through a voltage level of your choosing. Pulse width triggering lets you trigger on normal or aberrant pulses. Video triggering adds the capability of triggering on video fields and lines.

**Table 25: Trigger commands**

Command	Description
<a href="#">TRIGger</a> on page 260	Forces a trigger event to occur.
<a href="#">TRIGger:A</a> on page 261	Sets the instrument trigger level to 50% of the minimum and maximum values of the signal.
<a href="#">TRIGger:A:EDGE?</a> on page 262	Returns the trigger coupling, source, and slope settings for the edge trigger.
<a href="#">TRIGger:A:EDGE:COUPling</a> on page 262	Sets or queries the type of coupling for the edge trigger.
<a href="#">TRIGger:A:EDGE:SLOpe</a> on page 263	Selects a rising or falling slope for the edge trigger.
<a href="#">TRIGger:A:EDGE:SOUrce</a> on page 264	Sets or queries the source for the edge trigger.
<a href="#">TRIGger:A:HOLDOff?</a> on page 265	Returns the A trigger holdoff settings.
<a href="#">TRIGger:A:HOLDOff:Time</a> on page 265	Sets or queries the instrument trigger holdoff time.
<a href="#">TRIGger:A:LEVel</a> on page 266	Sets or returns the trigger level for the A trigger.
<a href="#">TRIGger:A:LEVel:CH&lt;x&gt;</a> on page 267	Sets or returns the trigger level for the specified channel. Each channel can have an independent level.
<a href="#">TRIGger:A:LOWerthreshold:CH&lt;x&gt;</a> on page 267	Sets or returns the lower threshold for the channel selected.



Command	Description
<a href="#">TRIGger:A:MODE</a> on page 268	Sets or queries the trigger mode for the Edge (all models) and Pulse width trigger types.
<a href="#">TRIGger:A:PULse?</a> on page 269	Returns the current Pulse Trigger settings.
<a href="#">TRIGger:A:PULSE:Width?</a> on page 271	Returns the pulse trigger width settings.
<a href="#">TRIGger:A:PULse:WIDTH:POLarity</a> on page 271	Sets or queries the polarity for the pulse trigger.
<a href="#">TRIGger:A:PULSEWidth:SOURce</a> on page 272	Sets or queries the source for the pulse trigger.
<a href="#">TRIGger:A:PULse:WIDTH:WHEN</a> on page 272	Sets or queries the trigger conditions for the pulse trigger.
<a href="#">TRIGger:A:PULse:WIDTH:WIDTH</a> on page 274	Sets or queries the width for the pulse trigger.
<a href="#">TRIGger:A:RUNT?</a> on page 275	Returns the current A runt trigger parameters.
<a href="#">TRIGger:A:RUNT:POLarity</a> on page 275	Sets or returns the polarity for the runt trigger.
<a href="#">TRIGger:A:RUNT:SOURce</a> on page 276	Sets or returns the source for the A runt trigger.
<a href="#">TRIGger:A:RUNT:WHEn</a> on page 277	Sets or returns the type of pulse width the trigger checks for when it detects a runt.
<a href="#">TRIGger:A:RUNT:WIDTH</a> on page 278	Sets or returns the width for a runt trigger.
<a href="#">TRIGger:A:TYPe</a> on page 278	Sets or queries the type of instrument trigger.
<a href="#">TRIGger:A:UPPerthreshold:CH&lt;x&gt;</a> on page 279	Sets the upper threshold for channel <x>, where x is the channel number. Each channel can have an independent level. Used only for runt trigger type.
<a href="#">TRIGger:FREQuency?</a> on page 280	Returns the edge or pulse width trigger frequency.
<a href="#">TRIGger:STATE?</a> on page 280	Returns the current state of the triggering system.

## Vertical command group

Vertical commands control the attributes of the channels. The `SElect:<wfm>` command also displays a specified waveform or removes it from the display.

**Table 26: Vertical commands**

Command	Description
<a href="#">CH&lt;x&gt;?</a> on page 61	Returns vertical parameters for the specified channel.
<a href="#">CH&lt;x&gt;:BANdwidth</a> on page 63	Sets or queries the bandwidth setting of the specified instrument channel.
<a href="#">CH&lt;x&gt;:COUPling</a> on page 64	Sets or queries the input coupling setting of the specified instrument channel.
<a href="#">CH&lt;x&gt;:DESKew</a> on page 65	Sets or queries the deskew time for the specified channel.
<a href="#">CH&lt;x&gt;:INVert</a> on page 66	Sets or returns the invert function for the specified channel.
<a href="#">CH&lt;x&gt;:LABel</a> on page 66	This commands sets or queries the waveform label for the specified channel.
<a href="#">CH&lt;x&gt;:OFFSet</a> on page 67	Sets or queries the channel offset.
<a href="#">CH&lt;x&gt;:POSition</a> on page 68	Sets or queries the vertical position of the specified instrument channel.
<a href="#">CH&lt;x&gt;:PRObe</a> on page 69?	Returns the gain, resistance, units, and ID of the probe that is attached to the specified channel.
<a href="#">CH&lt;x&gt;:PRObe:AUTOZero</a> on page 70	Sets the TekVPI probe attached to the specified channel input to autozero.
<a href="#">CH&lt;x&gt;:PRObe:DEGAUss</a> on page 70	Starts a degauss/autozero cycle on a TekVPI current probe attached to the specified channel input.
<a href="#">CH&lt;x&gt;:PRObe:DEGAUss:STATE?</a> on page 71	Returns the state of the probe degauss.
<a href="#">CH&lt;x&gt;:PRObe:FORCEDRange</a> on page 72	Sets or queries the range on a TekVPI probe attached to the specified channel.
<a href="#">CH&lt;x&gt;:PRObe:GAIN</a> on page 73	Sets or queries the gain factor of the probe that is attached to the specified channel.
<a href="#">CH&lt;x&gt;:PRObe:ID?</a> on page 74	Returns the type and serial number of the probe that is attached to the specified channel.
<a href="#">CH&lt;x&gt;:PRObe:ID:SERnumber?</a> on page 74	Returns the serial number of the probe that is attached to the specified channel.
<a href="#">CH&lt;x&gt;:PRObe:ID:TYPE?</a> on page 75	Returns the type of probe that is attached to the specified channel.
<a href="#">CH&lt;x&gt;:PRObe:SIGnal</a> on page 75	Sets or queries the input bypass setting of the TekVPI probe attached to the specified channel.
<a href="#">CH&lt;x&gt;:PRObe:UNIts?</a> on page 76	Returns the units of measure of the probe that is attached to the specified channel.

Command	Description
<a href="#">CH&lt;x&gt;:SCALE</a> on page 76	Sets or queries the vertical scale of the specified instrument channel.
<a href="#">CH&lt;x&gt;:VOLts</a> on page 77	Sets or queries the vertical sensitivity of the specified channel.
<a href="#">CH&lt;x&gt;:YUNit</a> on page 78	Sets or queries the units of the specified channel.
<a href="#">REF&lt;x&gt;?</a> on page 220	Returns reference waveform data for the specified channel.
<a href="#">REF&lt;x&gt;:DATE?</a> on page 220	Returns the date that the reference waveform was stored.
<a href="#">REF&lt;x&gt;:TIME?</a> on page 221	Returns the time that the reference waveform was stored.
<a href="#">REF&lt;x&gt;:HORizontal:DELay:TIME?</a> on page 221	Returns the horizontal position of the specified reference waveform in percent of the waveform that is displayed to the right of the center vertical graticule.
<a href="#">REF&lt;x&gt;:HORizontal:SCALE?</a> on page 222	Returns the horizontal scale for the reference waveform.
<a href="#">REF&lt;x&gt;:POSition?</a> on page 222	Returns the vertical position for channel <x>, where x is the reference channel number. Query only.
<a href="#">REF&lt;x&gt;:VERTical:POSition?</a> on page 223	Returns the vertical position of the specified reference waveform.
<a href="#">REF&lt;x&gt;:VERTical:SCALE?</a> on page 223	Returns the reference waveform vertical scale in vertical units/div.
<a href="#">SElect:CH&lt;x&gt;</a> on page 244	Turns the display of the channel <x> waveform on or off.
<a href="#">SElect:CONTROl</a> on page 245	Sets or returns the waveform that is selected as the implied recipient of channel-related commands
<a href="#">SElect:FFT</a> on page 246	Turns on or off the FFT waveform or queries whether the FFT waveform is on or off.
<a href="#">SElect:MATH</a> on page 247	Turns on or off the math waveform or queries whether the math waveform is on or off.
<a href="#">SElect:REF&lt;x&gt;</a> on page 248	Turns on or off the specified reference waveform or queries whether the specified reference waveform is on or off.

## Waveform command group

Waveform commands let you transfer waveform data points to and from the instrument. Waveform data points are a collection of values that define a waveform. One data value usually represents one data point in the waveform record. When working with peak-detect waveforms, each data value is either the min or max of a min/max pair. Before you can transfer waveform data, you must specify the data format and waveform locations.

Refer to the text following this table for more information about waveform commands.

**Table 27: Waveform commands**

Command	Description
<a href="#">CURVe</a> on page 92	Transfers instrument waveform data to and from the instrument in binary or ASCII format.
<a href="#">DATa</a> on page 95	Sets or queries the format and location of the waveform data that is transferred with the CURVe command.
<a href="#">DATa:DESTination</a> on page 96	Sets or queries the reference memory location for storing instrument waveform data that is transferred into the instrument by the CURVe command.
<a href="#">DATa:SOURce</a> on page 97	Sets or queries which waveform will be transferred from the instrument by the CURVe, WFMPre, or WAVFrm? queries.
<a href="#">DATa:START</a> on page 98	Sets or queries the starting data point for waveform data transfers.
<a href="#">DATa:STOP</a> on page 99	Sets or queries the last data point in the waveform that will be transferred when executing the CURVe? command.
<a href="#">DATa:WIDTH</a> on page 100	Sets the number of bytes per waveform data point to be transferred when executing the CURVe command.
<a href="#">WAVFrm?</a> on page 288	Returns WFMPre? and CURVe? data for the waveform specified by the DATa:SOURce command.
<a href="#">WFMPre:BIT_Nr</a> on page 289	Sets or queries the number of bits per waveform point for the waveform to be transferred.
<a href="#">WFMPre:BYT_Nr</a> on page 290	Sets or queries the data width for the waveform to be transferred.
<a href="#">WFMPre:ENCdg</a> on page 290	Sets or queries the type of encoding for waveform data transferred with the CURVe command.
<a href="#">WFMPre:NR_Pt?</a> on page 291	Returns the number of points that are in the transmitted waveform record, as specified by DATa:SOURce.

Command	Description
<a href="#">WFMinpre:XINcr</a> on page 292	The set form of this command specifies the interval (seconds per point for nonFFT, Hertz per point for FFT) between samples of the reference waveform specified by the DATA:DESTINATION command.
<a href="#">WFMinpre:XUNit</a> on page 292	Sets the horizontal units ("s" for seconds and "Hz" for Hertz) for the reference waveform specified by the DATA:DESTINATION command.
<a href="#">WFMinpre:XZEro</a> on page 293	The set form of this command specifies the position, in XUNits, of the first sample of the reference waveform specified by the DATA:DESTINATION command, relative to the trigger.
<a href="#">WFMinpre:YMUlt</a> on page 294	Sets or queries the vertical scale factor of the incoming waveform, expressed in YUNits per waveform data point level.
<a href="#">WFMinpre:YOff</a> on page 295	Sets or queries the vertical position of the incoming waveform in digitizing levels.
<a href="#">WFMinpre:YUNit</a> on page 296	Sets the vertical units for the reference waveform specified by DATA:DESTINATION.
<a href="#">WFMinpre:YZEro</a> on page 297	Sets or returns the vertical offset of the incoming waveform in units specified by WFMinpre:YUNit.
<a href="#">WFMOutpre?</a> on page 298	Returns waveform transmission and formatting settings for the waveform specified by the DATA:SOURCE command.
<a href="#">WFMOutpre:BIT_Nr</a> on page 298	Sets and queries the number of bits per waveform point that outgoing waveforms contain, as specified by the DATA:SOURCE command.
<a href="#">WFMOutpre:BYT_Nr</a> on page 300	Sets or queries the data width for the outgoing waveform specified by the DATA:SOURCE command.
<a href="#">WFMOutpre:ENCdg</a> on page 301	Sets and queries the type of encoding for outgoing waveforms.
<a href="#">WFMOutpre:NR_Pt?</a> on page 302	Returns the number of points for the DATA:SOURCE waveform that will be transmitted in response to a CURVe? query.
<a href="#">WFMOutpre:RECOrdlength?</a> on page 302	Returns the record length for the source waveform as specified by the DATA:SOURCE command.
<a href="#">WFMOutpre:WFId?</a> on page 303	Returns a descriptive string from the waveform specified in the DATA:SOURCE command, if that waveform is active or displayed.
<a href="#">WFMOutpre:XINcr?</a> on page 304	Returns the horizontal point spacing in units of WFMOutpre:XUNit for the waveform specified by the DATA:SOURCE command.

Command	Description
<a href="#">WFMOutpre:XUNit?</a> on page 304	Returns the horizontal units for the waveform specified by the DATA:SOURce command.
<a href="#">WFMOutpre:XUNit?</a> on page 304	Returns the time coordinate of the first point in the outgoing waveform.
<a href="#">WFMOutpre:YMUit?</a> on page 306	Returns the vertical scale factor per digitizing level in units specified by WFMOutpre:YUNit for the waveform specified by the DATA:SOURce command.
<a href="#">WFMOutpre:YOFF?</a> on page 306	Returns the vertical position in digitizing levels for the waveform specified by the DATA:SOURce command.
<a href="#">WFMOutpre:YUNit?</a> on page 307	Returns the vertical units for the waveform specified by the DATA:SOURce command.
<a href="#">WFMOutpre:YZEro?</a> on page 308	Returns the vertical offset in units specified by WFMOutpre:YUNit? for the waveform specified by the DATA:SOURce command.

### Waveform data formats

Internally, the instrument uses one 8-bit data byte to represent each waveform data point, regardless of the acquisition mode.

The DATA:WIDth command lets you specify the number of bytes per data point when transferring data to and from an instrument. This provides compatibility with other digitizing instruments.

When DATA:WIDth is set to two:

- If sending data, the instrument multiplies each point by 256; the most significant byte then has meaningful data and the least significant byte is 0.
- If receiving data, the instrument truncates the data (divides by 256) and saves the most significant byte.

---

**NOTE.** *The instrument uses these methods to handle waveforms transmitted in ASCII or binary format.*

---

The instrument can transfer waveform data in either ASCII or binary format. Use the DATA:ENCdg command to specify one of the following formats:

- ASCII data is represented by signed integer values. The range of values depends on the byte width specified. One-byte-wide data ranges from -128 to 127. Two-byte-wide data ranges from -32768 to 32767.

Each data value requires two to seven characters. This includes one character for the minus sign if the value is negative, one to five ASCII characters for the waveform value, and a comma to separate data points.

An example of an ASCII waveform data string follows:

```
CURVE<space>-110,-109,-110,-110,-109,-107,-109,-107,
-106,-105,-103,-100,-97,-90,-84,-80
```

- Binary data can be represented by signed integer or positive integer values. The range of the values depends on the byte width specified.

**Table 28: Binary data ranges**

Byte width	Signed integer range	Positive integer range
1	-128 to 127	0 to 255
2	-32,768 to 32,767	0 to 65,535

The defined binary formats also specify the order in which the bytes are transferred giving a total of four binary formats: RIBinary, RPBinary, SRIBinary, and SRPbinary.

RIBinary is signed integer where the most significant byte is transferred first, and RPBinary is positive integer where the most significant byte is transferred first. SRIBinary and SRPbinary correspond to RIBinary and RPBinary respectively but use a swapped byte order where the least significant byte is transferred first. The byte order is ignored when DATA:WIDTH is set to 1.

### Waveform data record

You can transfer multiple points for each waveform record. You can transfer a part of the waveform or you can transfer the entire record. The DATA:START and DATA:STOP commands let you specify the first and last data points of the waveform record.

When transferring data into the instrument you must specify the location of the first data point within the waveform record. For example, when DATA:START is set to 1, data points will be stored starting with the first point in the record, and when DATA:START is set to 500, data will be stored starting at the 500th point in the record. The instrument ignores DATA:STOP when reading in data as the instrument will stop reading data when there is no more data to read or when it has reached 2500 data points.

You must specify the first and last data points in the waveform record when transferring data from the instrument to an external device. Setting DATA:START to 1 and DATA:STOP to 2500 always sends the entire waveform, regardless of the acquisition mode.

### Waveform data locations and memory allocation

The DATA:SOURCE command specifies the location of the data when transferring waveforms from the instrument. You can transfer one waveform into the instrument at a time. Each waveform is stored in one of two stored waveform locations for 2-channel models or one of four stored waveform locations for 4-channel models. You specify the stored waveform location with the DATA:DESTINATION command.

---

**NOTE.** The instrument stores waveforms that are  $\leq 2500$  data points long. The instrument truncates waveforms longer than 2500 data points.

---

<b>Waveform preamble</b>	Each waveform that is transferred has an associated waveform preamble that contains information such as the horizontal scale, vertical scale, and other settings in place when the waveform was created. Refer to the WFMPre? commands for more information about the waveform preamble.
<b>Scaling waveform data</b>	Once you transfer the waveform data to the controller, you can convert the data points into voltage values for analysis using information from the waveform preamble.
<b>Transferring waveform data</b>	<p>Data transfer times depend on data format, data width, and the speed of the controller. <i>Programming Examples</i> on page 335</p> <p>From the instrument. To transfer waveforms from the instrument to an external controller, follow these steps:</p> <ol style="list-style-type: none"><li>1. Use the DATA:SOURce command to select the waveform source.</li><li>2. Use the DATA:ENCdg command to specify the waveform data format.</li><li>3. Use the DATA:WIDTH command to specify the number of bytes per data point.</li><li>4. Use the DATA:START and DATA:STOP commands to specify the part of the waveform that you want to transfer.</li><li>5. Use the WFMPre? command to transfer waveform preamble information.</li><li>6. Use the CURVe command to transfer waveform data.</li></ol> <p>To the instrument. To transfer waveform data to an instrument waveform storage location, follow these steps:</p> <ol style="list-style-type: none"><li>1. Use the DATA:DESTination command to specify the stored waveform location.</li><li>2. Use the DATA:ENCdg command to specify the waveform data format.</li><li>3. Use the DATA:WIDTH command to specify the number of bytes per data point.</li><li>4. Use the DATA:START command to specify the first data point in the waveform record.</li><li>5. Use the WFMPre? command to transfer waveform preamble information.</li><li>6. Use the CURVe command to transfer waveform data.</li></ol>



## Zoom command group

These commands support the zoom feature.

**Table 29: Zoom commands**

Command	Description
<a href="#">ZOOM?</a> on page 309	Returns the current horizontal positioning and scaling of the display.
<a href="#">ZOOM{MODE}:STATE</a> on page 309	Sets or queries the zoom on/off state.
<a href="#">ZOOM:ZOOM1?</a> on page 310	Returns the current horizontal positioning and scaling of the display
<a href="#">ZOOM:ZOOM1:FACTOR</a> on page 311	Sets or queries the zoom factor of a particular zoom box.
<a href="#">ZOOM:ZOOM1:HORIZONTAL:POSITION</a> on page 311	Sets or queries the horizontal position of a particular zoom box.
<a href="#">ZOOM:ZOOM1:HORIZONTAL:SCALE</a> on page 312	Sets or queries the horizontal zoom scale of the specified waveform in the specified zoom.
<a href="#">ZOOM:ZOOM1:POSITION</a> on page 313	Sets or returns the horizontal zoom position for the specified waveform in the specified zoom
<a href="#">ZOOM:ZOOM1:SCALE</a> on page 313	Sets or returns the horizontal zoom scale of the specified waveform in the specified zoom
<a href="#">ZOOM:ZOOM1:STATE</a> on page 314	Specifies or returns a trace as zoomed, on or off.



---

# A commands

This section lists commands and queries that begin with the letter A.

## ACQUIRE?

Returns the current acquisition settings. Query only.

**Group** Acquisition

**Syntax** ACQUIRE?

**Related Commands** [ACQUIRE:MODE](#) on page 42, [ACQUIRE:NUMACQ?](#) on page 44, [ACQUIRE:NUMAVG](#) on page 45, [ACQUIRE:NUMAVG](#) on page 45

**Returns** Returns current acquisition settings: Stop after, Acquisition state, Mode, Number of averages.

**Examples** ACQUIRE? might return the following string for the current acquisition:  
ACQUIRE:STOPAFTER RUNSTOP;STATE 1; MODE SAMPLE;NUMAVG  
16

## ACQUIRE:MAXSAMPLERATE?

Returns the maximum real-time sample rate, which varies from model to model. Query only.

**Group** Acquisition

**Syntax** ACQUIRE:MAXSAMPLERATE?

**Examples** ACQUIRE:MAXSAMPLERATE? might return 2.0000E+9 indicating the maximum real-time sample rate is 2.0 GS/s.

## ACQUIRE:MODE

Sets or queries the acquisition mode of the instrument for all live waveforms.

Waveforms are the displayed data point values taken from acquisition intervals. Each acquisition interval represents a time duration set by the horizontal scale (time per division).

The instrument sampling system always samples at the maximum rate, so the acquisition interval may include more than one sample. The acquisition mode, which you set using this ACQUIRE:MODE command, determines how the final value of the acquisition interval is generated from the many data samples.

**Group** Acquisition

**Syntax** ACQUIRE:MODE {SAMPLE|PEAKdetect|HIRES|AVERAGE}  
ACQUIRE:MODE?

---

**Related commands**    *ACQUIRE:NUMAVg* on page 45, *CURVe* on page 92

**Arguments**

**SAMple** specifies that the displayed data point value is the first sampled value that was taken during the acquisition interval. The waveform data has 8 bits of precision in all acquisition modes. You can request 16 bit data with a *CURVe?* query, but the lower-order 8 bits of data will be zero. **SAMple** is the default mode.

**PEAKdetect** specifies the display of the high-low range of the samples taken from a single waveform acquisition. The instrument displays the high-low range as a vertical column that extends from the highest to the lowest value sampled during the acquisition interval. **PEAKdetect** mode can reveal the presence of aliasing or narrow spikes.

**HIRes** specifies Hi Res mode where the displayed data point value is the average of all the samples taken during the acquisition interval. This is a form of averaging, where the average comes from a single waveform acquisition. The number of samples taken during the acquisition interval determines the number of data values that compose the average.

**AVERage** specifies averaging mode, in which the resulting waveform shows an average of **SAMple** data points from several separate waveform acquisitions. The instrument processes the number of waveforms you specify into the acquired waveform, creating a running exponential average of the input signal. The number of waveform acquisitions that go into making up the average waveform is set or queried using the *ACQUIRE:NUMAVg* command.

**Examples**

*ACQUIRE:MODE AVERage* sets average acquisition mode so that the resulting waveform is the average of the specified number of waveform acquisitions.

*ACQUIRE:MODE?* might return *ACQUIRE:MODE AVERAGE* indicating that the displayed waveform is the average of the specified number of waveform acquisitions.

## ACQUIRE:NUMACq?

Indicates the number of acquisitions that have taken place since starting instrument acquisition. The acquisition number will continue to increase while acquisitions are running until there is a reset.

Starting and stopping acquisitions do not cause this number to reset. For example, if acquisitions are running, the acquisition count will increase (assuming the instrument is triggering). If you stop the acquisitions, the acquisition number will freeze at a given number (For example: 5000). If you start acquisitions again, it will continue from 5000. The number will reset to 0 only if you change the horizontal scale while acquisitions are running.

**Group** Acquisition

**Syntax** ACQUIRE:NUMACq?

**Related commands** [ACQUIRE:STATE](#) on page 45

**Returns** <NR1>

**Examples** ACQUIRE:NUMACq? might return ACQUIRE:NUMACQ 350 indicating that 350 acquisitions have occurred.

## ACQUIRE:NUMAVg

Sets or queries the number of waveform acquisitions that make up an averaged waveform. Use the ACQUIRE:MODE command to enable Average mode. Sending this command is equivalent to turning a multipurpose knob to enter the number of waveform acquisitions to average.

**Group** Acquisition

**Syntax** ACQUIRE:NUMAVg <NR1>  
ACQUIRE:NUMAVg?

**Arguments** <NR1> is the number of waveform acquisitions to average. The range of values is from 2 to 512 in powers of two.

**Examples** ACQUIRE:NUMAVg 16 specifies that 16 waveform averages are performed before exponential averaging starts.  
ACQUIRE:NUMAVg? might return ACQUIRE:NUMAVG 64 indicating that there are 64 acquisitions specified for averaging.

## ACQUIRE:STATE

Starts or stops acquisitions.

When State is set to ON or RUN, a new acquisition is started. If the last acquisition was a single acquisition sequence, a new single sequence acquisition is started. If the last acquisition was continuous, a new continuous acquisition is started.

If RUN is issued in the middle of completing a single sequence acquisition (for example, averaging or enveloping), the acquisition sequence is restarted, and any accumulated data is discarded. Also, the instrument resets the number of acquisitions. If the RUN argument is issued while in continuous mode, acquisition continues.

<b>Group</b>	Acquisition
<b>Syntax</b>	ACQuire:STATE {OFF ON RUN STOP <NR1>} ACQuire:STATE?
<b>Related Commands</b>	<i>*OPC</i> on page 213, <i>ACQuire:STOPAfter</i> on page 46
<b>Arguments</b>	OFF STOP <NR1> = 0 stops acquisitions; any other value starts acquisitions.. ON RUN <NR1> ≠ 0 starts acquisition and display of waveforms.
<b>Examples</b>	ACQuire:STATE RUN starts acquisition of waveform data and resets the number of acquisitions count (NUMACq) to zero. ACQuire:STATE? might return: ACQUIRE:STATE 0 indicating that the acquisition is stopped.

## ACQuire:STOPAfter

Sets or returns whether the instrument continually acquires acquisitions or acquires a single sequence.

<b>Group</b>	Acquisition
<b>Syntax</b>	ACQuire:STOPAfter {RUNSTop SEQuence} ACQuire:STOPAfter?



**Related commands** [ACquire:STATE](#) on page 45

**Arguments** RUNSTOP specifies that the instrument will continually acquire data, if ACquire:STATE is turned on.

SEQUence specifies that the next acquisition will be a single-sequence acquisition.

**Examples** ACquire:STOPAfter RUNSTOP sets the instrument to continually acquire data.

ACquire:STOPAfter? might return: ACQUIRE:STOPAFTER SEQUENCE indicating that the next acquisition the instrument makes will be of the single-sequence type.

## ALias

Sets or queries the state of alias functionality.

Use Alias commands to define new commands as a sequence of standard commands. You may find this useful when repeatedly using the same commands to perform certain tasks like setting up measurements. Aliases are similar to macros but do not include the capability to substitute parameters into alias bodies.

To use Alias commands, first define the alias, then turn on the alias state.

**Group** Alias

**Syntax** ALias {OFF|ON|<NR1>}  
ALias?

**Related commands**    *ALias:DEFine* on page 49, *ALias[:STATE]* on page 51

**Arguments**    OFF turns alias expansion off. If a defined alias is sent when ALias is off, a command error (110) will be generated.  
ON turns alias expansion on. When a defined alias is received, the specified command sequence is substituted for the alias and executed.  
<NR1> = 0 disables alias mode; any other value enables alias mode.

**Examples**    ALIAS ON turns the alias feature on. When a defined alias is received, the specified command sequence is substituted for the alias and executed.  
ALIAS? might return :ALIAS 1 indicating that the alias feature is on.

## ALias:CATalog?

Returns a list of the currently defined alias labels, separated by commas. If no aliases are defined, the query returns the string "". Query only.

**Group**    Alias

**Syntax**    ALias:CATalog?

**Examples**    ALIAS:CATALOG? might return the string :ALIAS:CATALOG "SETUP1","TESTMENU1","DEFAULT" showing that there are three aliases named SETUP1, TESTMENU1, and DEFAULT.

## ALias:DEFine

Assigns a sequence of program messages to an alias label. These messages are then substituted for the alias whenever it is received as a command or query, provided that ALias:STATE has been turned on. The query form of this command returns the definitions of a selected alias.

---

**NOTE.** Attempting to give two aliases the same name causes an error. To give a new alias the name of an existing alias, the existing alias must first be deleted.

---

**Group** Alias

**Syntax** ALias:DEFine <QString><,>{<QString>|<Block>}  
ALias:DEFine? <QString>

**Related commands** [ALias\[:STATE\]](#) on page 51

**Arguments** The first <QString> is the alias label. This label cannot be a command name. Labels must start with a letter and can contain only letters, numbers, and underscores; other characters are not allowed. The label must be less than or equal to 12 characters. The second <QString> or <Block> is a complete sequence of program messages. The messages can contain only valid commands that must be separated by semicolons and must follow all rules for concatenating commands. The sequence must be less than or equal to 256 characters.

**Examples** ALIAS:DEFINE "ST1",":RECALL:SETUP 5;:AUTOSET EXECUTE;:SELECT:CH1 ON" defines an alias named "ST1" that sets up the instrument.  
ALIAS:DEFINE? "ST1" returns :ALIAS:DEFINE "ST1",#246 :RECALL:SETUP 5;:AUTOSET EXECUTE;:SELECT:CH1 ON.

## ALias:DELEte

Removes a specified alias and is identical to ALIas:DELEte:NAME. An error message is generated if the named alias does not exist. (No query form.)

**Group** Alias

**Syntax** ALIas:DELEte <QString>

**Related commands** [\\*ESR?](#) on page 115, [ALIas:DELEte:ALL](#) on page 50

**Arguments** <QString> is the name of the alias to be removed. Using ALIas:DELEte without specifying an alias causes an execution error. <QString> must be a previously defined value.

**Examples** ALIAS:DELETE "SETUP1" deletes the alias named SETUP1.

## ALias:DELEte:ALL

Deletes all existing aliases. No query form.

**Group** Alias

**Syntax** ALIas:DELEte:ALL

**Related commands** [ALIas:DELEte](#) on page 50, [ALIas:DELEte\[:NAME\]](#) on page 51

**Examples** ALIAS:DELETE:ALL deletes all existing aliases.

## ALias:DELEte[:NAME]

Removes a specified alias. This command is identical to ALias:DELEte. No query form.

**Group** Alias

**Syntax** ALias:DELEte[:NAME] <QString>

**Arguments** <QString> is the name of the alias to remove. Using ALias:DELEte[:NAME] without specifying an alias causes an execution error. <QString> must be an existing alias.

**Examples** ALIAS:DELETE:NAME "STARTUP" deletes the alias named STARTUP.

## ALias[:STATE]

Turns aliases on or off. This command is identical to the ALias command.

**Group** Alias

**Syntax** ALias[:STATE] {<NR1>|OFF|ON}  
ALias[:STATE]?

**Arguments** OFF or  $\langle \text{NR1} \rangle = 0$  turns alias expansion off. If a defined alias is sent when ALIAS:STATE is OFF, a command error (102) is generated.

ON or  $\langle \text{NR1} \rangle \neq 0$  turns alias expansion on. When a defined alias is received, the specified command sequence is substituted for the alias and executed.

**Examples** ALIAS:STATE OFF turns the command alias feature off.

ALIAS[:STATE]? returns 0 when the alias feature is off.

## ALLEv?

Causes the instrument to return all events and their messages, and removes the returned events from the Event Queue. The messages are separated by commas. Use the \*ESR? query to enable the events to be returned. Refer to the Status and Events section for a complete description of how to use these registers. This command is similar to repeatedly sending \*EVMsg? queries to the instrument. Query only.

**Group** Status and Error

**Syntax** ALLEv?

**Related Commands** [\\*CLS](#) on page 79, [DESE](#) on page 102, [\\*ESE](#) on page 114, [\\*ESR?](#) on page 115, [EVENT?](#) on page 123, [EVMsg?](#) on page 124, [EVQty?](#) on page 125, [\\*SRE](#) on page 256, [\\*STB?](#) on page 257

**Returns** The event code and message in the following format:

$\langle \text{Event Code} \rangle \langle \text{Comma} \rangle \langle \text{QString} \rangle [ \langle \text{Comma} \rangle \langle \text{Event Code} \rangle \langle \text{Comma} \rangle \langle \text{QString} \rangle \dots ]$

$\langle \text{QString} \rangle ::= \langle \text{Message} \rangle ; [ \langle \text{Command} \rangle ]$

$\langle \text{Command} \rangle$  is the command that caused the error and may be returned when a command error is detected by the instrument. As much of the command is returned as possible without exceeding the 60 character limit of the  $\langle \text{Message} \rangle$  and  $\langle \text{Command} \rangle$  strings combined. The command string is right-justified.

**Examples** ALLEv? might return the following string: ALLEV 2225,"MEASUREMENT ERROR, NO WAVEFORM TO MEASURE; ",420,"QUERY UNTERMINATED; "

## AUTOSet

Causes the instrument to adjust its vertical, horizontal, and trigger controls to display a stable waveform. This command is equivalent to pushing the front-panel AUTOSET button. For a detailed description of the Autoset function, refer to the user manual for your instrument. Command only, no query form.

**Group** Miscellaneous

**Syntax** AUTOSet {EXECute | UNDo}

**Arguments** EXECute runs Autoset on the selected waveform.  
UNDo restores the oscilloscope settings to those prior to running Autoset.

## AUTOSet:ENABLE

Allows educators to disable or enable the Autorange and Autoset functions. The function can be manually set from the Utility menu. To access the menu, refer to the product user manual.

**Group** Miscellaneous

**Syntax** AUTOSet:ENABLE {ON | OFF}  
AUTOSet:ENABLE?

**Related commands**    *AUTOSet* on page 53  
                              *FEAEN:PASSWORD* on page 128

**Arguments**        ON enables the autoseat feature.  
                              OFF disables the autoseat feature.

**Examples**        AUTOSET:ENABLE OFF disables autoseat.  
                              AUTOSET:ENABLE? might return 1 indicating that autoseat is enabled.



---

## B commands

This section lists commands and queries that begin with the letter B.

### BUSY?

Returns the status of the instrument. This command allows you to synchronize the operation of the instrument with your application program. Query only.

Certain instrument operations can affect the BUSY? response. [Table 34: Instrument operations that can generate OPC](#) on page 322

**Group** Status and Error

**Syntax** BUSY?

**Related Commands** [\\*OPC](#) on page 213, [\\*WAI](#) on page 287

**Returns** <NR1> = 0 means the instrument is not busy processing a command whose execution time is extensive.  
<NR1> = 1 means the instrument is busy processing a command whose execution time is extensive. [Table 34: Instrument operations that can generate OPC](#) on page 322

**Examples** BUSY? might return :BUSY 1 indicating that the instrument is now busy. See [Using the BUSY Query](#) on page 324 for an example of how to use this query.



## C commands

This section lists commands and queries that begin with the letter C.

### \*CAL?

Performs an internal self-calibration and returns its status. This is equivalent to selecting the Do Self Cal option in the Utility menu. Although \*CAL? is a query command, it does perform an action. Query only.

---

**NOTE.** *The self-calibration can take several minutes to complete. During this time, the instrument does not execute any commands.*

*Disconnect all signals from the instrument before performing an internal self-calibration.*

---

**Group** Calibration and Diagnostic

**Syntax** \*CAL?

**Related Commands** [CALibrate:INTERNAL](#) on page 58

**Returns** 0 indicates that the self-calibration completed without any errors detected.  
Any value other than zero indicates that the self-calibration did not complete successfully or completed with errors.

**Examples** \*CAL? performs a self-calibration and might return 0 to indicate that it completed successfully.

## CALibrate:INTERNAL

This command starts a signal path compensation. Command only, no query form.

---

**NOTE.** *The self-calibration can take several minutes to complete. During this time, the instrument does not execute any commands.*

---

*Disconnect all signals from the instrument before performing an internal self-calibration.*

**Group** Calibration and Diagnostic

**Syntax** CALibrate:INTERNAL

**Examples** CALibrate:INTERNAL starts a signal path compensation cycle.

## CALibrate:INTERNAL:START

Starts the internal signal path calibration (SPC) of the instrument. You can use the CALibrate:INTERNAL:STATus? query to return the current status of the internal signal path calibration of the instrument. No query form.

**Group** Calibration and Diagnostic

**Syntax** CALibrate:INTERNAL:START

**Related commands** [CALibrate:RESults:SPC?](#) on page 60

**Examples** CALIBRATE:INTERNAL:START initiates the internal signal path compensation of the instrument.

## CALibrate:INTERNaL:STATus?

Returns the current status of the instrument internal signal path compensation for the last SPC operation. Query only.

**Group** Calibration and Diagnostic

**Syntax** CALibrate:INTERNaL:STATus?

**Related commands** [\\*CAL?](#) on page 57

**Returns** INIT indicates the instrument has not had internal signal path calibration run.  
PASS indicates the signal path calibration completed successfully.  
FAIL indicates the signal path calibration did not complete successfully.  
RUNNING indicates the signal path calibration is currently running.

**Examples** CALibrate:INTERNaL:STATus? might  
return :CALIBRATE:INTERNAL:STATUS INIT indicating that the current  
status of the internal signal path compensation is that it has not been run.

## CALibrate:RESults?

Returns the status of internal and factory calibrations, without performing any calibration operations. Query only.

The results returned do not include the calibration status of attached probes. The CALibrate:RESults? query is intended to support GO/NoGO testing of the instrument calibration readiness: all returned results should indicate PASS status if the instrument is fit for duty. It is quite common, however, to use uncalibrated probes (particularly when the instrument inputs are connected into a test system with coaxial cables).

**Group** Calibration and Diagnostic

**Syntax** CALibrate:RESults?

**Related commands** [\\*CAL?](#) on page 57

**Examples** CALibrate:RESults? might return :CALibrate:RESults INIT indicating the instrument has not be calibrated.

## CALibrate:RESults:SPC?

Returns the status of the SPC operation. This query does not initiate a SPC. Query only.

**Group** Calibration and Diagnostic

---

**Syntax** CALibrate:RESults:SPC?

**Related commands** [\\*CAL?](#) on page 57

**Returns** INIT indicates that SPC has never successfully completed.  
PASS indicates that the last SPC operation passed.  
FAIL indicates that the last SPC operation failed.  
RUNNING indicates that the SPC operation is running.

**Examples** CALibrate:RESults:SPC? might return :CALibrate:RESults:SPC INIT indicating SPC has not be run successfully.

## CH<x>?

Returns the vertical parameters for the specified channel. The value of <x> can vary from 1 through 4 depending on instrument model. Query only.

Because CH<x>:SCALE and CH<x>:VOLts are identical, only CH<x>:SCALE is returned.

**Group** Vertical

**Syntax** CH<x>?

**Related Commands** [SElect:REF<x>](#) on page 248

**Returns** instrument vertical settings for the specified channel.

**Examples** CH1? might return :CH1:SCALE 1.0E0;POSITION 0.0E0; COUPLING DC;BANDWIDTH FULL;PROBE 1.0E0.

## CH<x>:AMPSVIAVOLTS:ENABLE

Sets or queries measure current status as ON or Off. The value <x> can vary from 1 through 4 depending upon the channel.

**Group** Vertical

**Syntax** CH<x>:AMPSVIAVOLTS:ENABLE {ON|OFF|<NR>}  
CH<x>:AMPSVIAVOLTS:ENABLE?

**Arguments** OFF turns current status off.  
ON turns current status on.  
<NR1> = 0 turns current status off; any other value turns current status on.

**Examples** Ch1:AMPSVIAVOLTS:ENABLE ON will change the Ch1 measure current status as Yes.



## CH<x>:AMPSVIAVOLTS :Factor

Sets or queries current factor . The value <x> can vary from 1 through 4 depending upon the channel .

<b>Group</b>	Vertical
<b>Syntax</b>	CH<x>:AMPSVIAVOLTS:FACTOR <NR3> CH<x>:AMPSVIAVOLTS:FACTOR?
<b>Arguments</b>	<NR3> is the factor value.
<b>Examples</b>	CH<x>:AMPSVIAVOLTS:FACTOR 1 will set it as 1 A per volt measurement. Ch1:AMPSVIAVOLTS:ENABLE ON will change the Ch1 measure current status as Yes.

## CH<x>:BANdwidth

Sets or queries the selectable low-pass bandwidth limit filter setting of the specified instrument channel. The value of <x> can vary from 1 through 4 depending on instrument model.

This command is equivalent to setting the BW Limit option in the Vertical menu.

<b>Group</b>	Vertical
<b>Syntax</b>	CH<x>:BANdwidth {TWEnty FULI <NR3>} CH<x>:BANdwidth?

- Arguments** TWEnty sets the upper bandwidth limit of channel <x> to 20 MHz.  
FULI disables any optional bandwidth limiting. The specified channel operates at its maximum attainable bandwidth.  
<NR3> is a double-precision ASCII string. The instrument rounds this value to an available bandwidth using geometric rounding, and then uses this value to set the upper bandwidth limit.  
***NOTE.** Other values may be possible depending on the attached probes.*
- Examples** CH1:BANDWIDTH TWENTY sets the bandwidth of channel 1 to 20 MHz.  
CH1:BANDWIDTH? might return FULI. This indicates there is no bandwidth limiting on channel 1.

## CH<x>:COUPling

Sets or queries the input attenuator coupling setting of the specified instrument channel. The value of <x> can vary from 1 through 4 depending on the instrument model.

This command is equivalent to setting the Coupling option in the Vertical menu.

- Group** Vertical
- Syntax** CH<x>:COUPling {AC | DC}  
CH<x>:COUPling?
- Arguments** AC sets the specified instrument channel to AC coupling.  
DC sets the specified instrument channel to DC coupling.

**Examples** CH1:COUPLING AC establishes AC coupling on channel 1.  
 CH2:COUPLING? might return :CH2:COUPLing DC indicating that channel 2 is set to DC coupling.

## CH<x>:DESKew

Sets or queries the deskew time for channel <x>, where x is the channel number. You can adjust the deskew time to add an independent, channel-based delay time to the delay (set by the horizontal position control and common to all channels) from the common trigger point to first sample taken for each channel. This lets you compensate individual channels for different delays introduced by their individual input hook ups.

**Group** Vertical

**Syntax** CH<x>:DESKew <NR3>  
 CH<x>:DESKew?

**Arguments** <NR3> is the deskew time for channel <x>, ranging from -100 ns to +100 ns with a resolution of 1 ns.

**Examples** CH4 :DESKew 5.0E-9 sets the deskew time for channel 4 to 5 ns.  
 CH2:DESKew? might return :CH2:DESKEW 2.0000E-09 indicating that the deskew time for channel 2 is set to 2 ns.

## CH<x>:INVert

Sets or queries the inversion state of the specified instrument channel. The value of <x> can vary from 1 through 4 depending on the instrument model.

This command is equivalent to setting the Invert option in the Vertical channel menus.

**Group** Vertical

**Syntax** CH<x>:INVert {ON|OFF}  
CH<x>:INVert?

**Arguments** ON inverts the specified instrument channel.  
OFF sets the specified instrument channel to noninverted.

**Examples** CH1:INVERT ON inverts the signal on channel 1.  
CH2:INVERT? might return :CH2:INVERT 0, indicating that channel 2 is not inverted.

## CH<x>:LABel

This command sets or queries the waveform label for channel<x>, where x is the channel number (1- 4).

**Group** Vertical

---

<b>Syntax</b>	CH<x>:LABel <Qstring> CH<x>:LABel?
<b>Arguments</b>	<Qstring> is an alphanumeric string of text, enclosed in quotes, that contains the text level information for the channel<x>waveform. The text string is limited to 30 characters.
<b>Examples</b>	CH1:LABEL "ICCDATA" sets the label name of Channel 1 waveform output to ICCDATA. CH1:LABEL? might return "ICCDATA", if the channel label was already set, else would return "" if not set.

## CH<x>:OFFSet

Sets or queries the vertical offset for channel <x>, where x is the channel number.

This command offsets the vertical acquisition window (moves the level at the vertical center of the acquisition window) for the specified channel. Visualize offset as scrolling the acquisition window towards the top of a large signal for increased offset values, and scrolling towards the bottom for decreased offset values. The resolution of the vertical window sets the offset increment for this control.

Offset adjusts only the vertical center of the acquisition window for channel waveforms to help determine what data is acquired. The instrument always displays the input signal minus the offset value.

The channel offset range depends on the vertical scale factor. The valid ranges for the instrument are (when the probe and external attenuation factor is X1):

For V/Div settings from 2 mV/div to 200 mV/div, the offset range is +/- 0.8 V

For V/Div settings from 202 mV/div to 5 V/div, the offset range is +/- 20 V

**Group** Vertical

**Syntax** CH<x>:OFFSet <NR3>  
CH<x>:OFFSet?

**Related commands** [CH<x>:POSition](#) on page 68

**Arguments** <NR3> is the offset value for the specified channel <x>.

**Examples** CH3:OFFSet 2.0E-3 sets the offset for channel 3 to 2 mV.  
CH4:OFFSet? might return : CH4:OFFSET 1.0000E-03 indicating that the offset for channel 4 is set to 1 mV.

## CH<x>:POSITION

Sets or queries the vertical position of the specified instrument channel. The value of <x> can vary from 1 through 4 depending on the instrument model.

The position voltage value is applied to the signal before digitization. Increasing the position value of a waveform causes the waveform to move up. Decreasing the position value causes the waveform to move down. The position value determines the vertical graticule coordinate at which input signal values, minus the present offset setting for that channel, are displayed. For example, if the position for Channel 3 is set to 2.0 and the offset is set to 3.0, then input signals equal to 3.0 units are displayed 2.0 divisions above the center of the screen (at 1 V/div).

**Group** Vertical

**Syntax** CH<x>:POSition <NR3>  
CH<x>:POSition?

**Related commands** [CH<x>:OFFSet](#) on page 67 [REF<x>:VERTical:POSition?](#) on page 223 [MATH:VERTical:POSition](#) on page 182

**Arguments** <NR3> is the position in divisions from the center graticule for the specified channel. The range is 5 to -5 divisions.

**Examples** CH2:POSITION 1.3E0 positions the channel 2 input signal 1.3 divisions above the center of the display.  
CH1:POSITION? might return :CH1:POSITION -1.3000 indicating that the vertical position of Channel 1 is 1.3 divisions below the center graticule.

## CH<x>:PRObe

Returns all information concerning the probe attached to channel <x>, where x is the channel number. The value of <x> can vary from 1 through 4 depending on the instrument model.

**Group** Vertical

**Syntax** CH<x>:PRObe?

**Examples** CH1:PROBE? might return CH1:PROBE 10.

## CH<x>:PRObe:AUTOZero

Sets the TekVPI probe attached to channel <x> to zero, where x is the channel number. No Query Form.

**Group** Vertical

**Syntax** CH<x>:PRObe:AUTOZero EXECute

**Arguments** Execute auto zeros the probe.

**Examples** CH1:PRObe:AUTOZero EXECute sets the probe attached to channel 1 to zero.

## CH<x>:PRObe:DEGAUss

Starts a degauss auto-zero cycle on a TekVPI current probe attached to the input channel specified by <x>, where x is the channel number. No Query Form.

**Group** Vertical

**Syntax** CH<x>:PRObe:DEGAUss EXECute

**Arguments** EXECute initiates the degauss operation.

**Examples** CH1:PRObe:DEGAUss EXECute starts a degauss cycle on the probe attached to channel 1.



## CH<x>:PRObe:DEGAUss:STATE?

Returns the state of the probe degauss for the channel specified by <x>, where x is the channel number. Query Only.

---

**NOTE.** *This command will return PASSED for probes that do not support degauss operations.*

---

<b>Group</b>	Vertical
<b>Syntax</b>	CH<x>:PRObe:DEGAUss:STATE?
<b>Returns</b>	NEEDED indicates the probe should be degaussed before taking measurements. RECOMMENDED indicates the measurement accuracy might be improved by degaussing the probe. PASSED indicates the probe is degaussed. FAILED indicates the degauss operation failed. RUNNING indicates the probe degauss operation is currently in progress.
<b>Examples</b>	CH1:PRObe:DEGAUss:STATE? might return :CH1:PRObe:DEGAUss:STATE FAILED indicating the degauss operation failed.

## CH<x>:PRObe:FORCEDRange

Sets or returns the range of a TekVPI probe attached to the channel specified by <x>, where x is the channel number.

---

**NOTE.** *This command returns 0.0 for probes that do not forced range.*

---

**Group** Vertical

**Syntax** CH<x>:PRObe:FORCEDRange <NR3>  
CH<x>:PRObe:FORCEDRange?

**Arguments** <NR3> specifies the range, which is probe specific.

**Returns** This command returns 0.0 for probes that do no support forced range.

**Examples** CH1:PRObe:FORCEDRange 0.3 set the range of the probe on channel 1 to 0.3.  
CH1:PRObe:FORCEDRange? might return CH1:PRObe:FORCEDRange  
0.0 indicating that the probe attached to channel 1 does not support forced range.

## CH<x>:PRObe:GAIN

Sets or queries the gain factor for the probe attached to the channel specified by <x>, where x is the channel number. The gain of a probe is the output divided by the input transfer ratio. For example, a common 10x probe has a gain of 0.1.

**Group** Vertical

**Syntax** CH<x>:PRObe:GAIN <NR3>  
CH<x>:PRObe:GAIN?

**Related commands** [CH<x>:SCAle](#) on page 76

**Arguments** <NR3> is the probe gain. Allowed values depend on the specific probe.

**Examples** CH1:PRObe:GAIN 0.1 sets the channel 1 probe gain to 0.1.  
CH2:PROBE:GAIN? might return :CH2:PROBE:GAIN 0.1000E+00 indicating that the attached 10x probe delivers 1 V to the channel 2 BNC for every 10 V applied to the probe input.

## CH<x>:PRObe:ID?

Returns the type and serial number of the probe attached to channel <x>, where x is the channel number. Query only.

**Group** Vertical

**Syntax** CH<x>:PRObe:ID?

**Examples** CH2:PROBE:ID? might return :CH2:PROBE:ID:TYPE "10X";SERNUMBER "N/A" indicating that a passive 10x probe of unknown serial number is attached to channel 2.

## CH<x>:PRObe:ID:SERnumber?

Returns the serial number of the probe attached to channel <x>, where x is the channel number. Query Only.

---

**NOTE.** For Level 0 and 1 probes, the serial number will be "".

---

**Group** Vertical

**Syntax** CH<x>:PRObe:ID:SERnumber?

**Examples** CH1:PROBE:ID:SERNUMBER? might return :CH1:PROBE:ID:SERNUMBER "B010289" indicating that the serial number of the probe attached to channel 1 is B010289.

## CH<x>:PRObe:ID:TYPE?

Returns the type of probe attached to the channel specified by <x>, where x is the channel number. Level 2 (or higher) probes supply their exact product nomenclature; for Level 0 or 1 probes, a generic “No Probe Detected message is returned. Query Only.

**Group** Vertical

**Syntax** CH<x>:PRObe:ID:TYPE?

**Examples** CH1:PROBE:ID:TYPE? might return :CH1:PROBE:ID:TYPE "P6203" indicating that a P6203-type probe is attached to channel 1.

## CH<x>:PRObe:SIGnal

Sets or queries the input bypass setting of a TekVPI probe attached to channel <x>, where x is the channel number. The probe must support input bypass, for example TCP0001. This command is ignored if sent to an unsupported probe.

**Group** Vertical

**Syntax** CH<x>:PRObe:SIGnal {BYPass|PASS}  
CH<x>:PRObe:SIGnal?

**Arguments** BYPass sets the probe to Bypass mode.  
PASS sets the probe to Pass mode.

**Examples** CH1:PRObe:SIGnal PASS set the probe attached to channel 1 to Pass mode.  
CH1:PRObe:SIGnal? might return :CH1:PRObe:SIGnal PASS indicating that the probe attached to channel 1 is in Pass mode

## CH<x>:PRObe:UNIts?

Returns a string describing the units of measure for the probe attached to channel <x>, where x is the channel number. Query Only.

**Group** Vertical

**Syntax** CH<x>:PRObe:UNIts?

**Examples** CH4:PROBE:UNITS? might return :CH4:PROBE:UNITS "V" indicating that the units of measure for the probe attached to channel 4 are volts.

## CH<x>:SCALE

Sets or queries the vertical scale of the specified instrument channel. The value of <x> can vary from 1 through 4 depending on the instrument model.

Each waveform has a vertical scale parameter. For a signal with constant amplitude, increasing the Scale causes the waveform to be displayed smaller. Decreasing the scale causes the waveform to be displayed larger.

Scale affects all waveforms, but affects channel waveforms differently from other waveforms:

For channel waveforms, this setting controls the vertical size of the acquisition window as well as the display scale. The range and resolution of scale values depends on the probe attached and any other external factors you have specified.

For reference and math waveforms, this setting controls the display only, graphically scaling these waveforms and having no affect on the acquisition hardware.

This command is equivalent to adjusting the front-panel VOLTS/DIV knob.

<b>Group</b>	Vertical
<b>Syntax</b>	CH<x>:SCALE <NR3> CH<x>:SCALE?
<b>Related Commands</b>	<i>CH&lt;x&gt;:OFFSet</i> on page 67, <i>CH&lt;x&gt;:POSition</i> on page 68, <i>REF&lt;x&gt;:VERTical:SCALE?</i> on page 223, <i>MATH:VERTical:SCALE</i> on page 182
<b>Arguments</b>	<NR3> is the scale, in units-per-division. The value entered here is truncated to three significant digits.
<b>Examples</b>	CH1:SCALE 100E-3 sets the channel 1 gain to 100 mV/div. CH2:SCALE? might return :CH2:SCALE 1.0000, indicating that the current V/div setting of channel 2 is 1 V/div.

## CH<x>:VOLts

Sets or queries the vertical sensitivity of the specified channel. The value of <x> can vary from 1 through 4 depending on the instrument model.

This command is identical to the CH<x>:SCALE command and is included for compatibility purposes. Only CH<x>:SCALE is returned in response to a CH<x>? query.

<b>Group</b>	Vertical
<b>Syntax</b>	CH<x>:VOLts <NR3> CH<x>:VOLts?

**Arguments** <NR3> is the vertical sensitivity, in volts.

**Examples** CH1:VOLts 1.0 sets channel 1 to 1 Volt per division.  
 CH1:VOLts? Might return CH1:VOLts 1.0 indication that the ch1 volts per division is 1 Volt per division.

## CH<x>:YUNit

Sets or queries the units of the specified channel. The value of <x> can vary from 1 through 4 depending on instrument model number.

String arguments are case insensitive and any unsupported units will generate an error. Supported units are:

%, /Hz, A, A/A, A/V, A/W, A/dB, A/s, AA, AW, AdB, As, B, Hz, IRE, S/s, V, V/A, V/V, V/W, V/dB, V/s, VV, VW, VdB, Volts, Vs, W, W/A, W/V, W/W, W/dB, W/s,WA, WV,WW, WdB, Ws, dB, dB/A, dB/V, dB/W, dB/dB, dBA, dBV, dBW, dBdB, day, degrees, div, hr, min, ohms, percent, s.

**Group** Vertical

**Syntax** CH<x>:YUNit <QString>  
 CH<x>:YUNit?

**Arguments** <QString> is a string of text surrounded by quotes, specifying the supported units. This command is case insensitive.

**Examples** CH2:YUNit "V" sets the units for channel 2 to Volts.  
 CH2:YUNIT might return CH2:YUNIT "V", indicating that the channel 2 units are volts.



## CLEARMenu

Clears the current menu from the display. This command is equivalent to pressing the front panel Menu off. No query form.

**Group** Miscellaneous

**Syntax** CLEARMenu

**Examples** CLEARMenu clears the current menu from the display.

## \*CLS

Command only, no query form. The \*CLS command clears the following instrument status data structures:

- The Event Queue
- The Standard Event Status Register (SESR)
- The Status Byte Register (except the MAV bit)

If the \*CLS command immediately follows an <EOI>, the Output Queue and MAV bit (Status Byte Register bit 4) are also cleared. MAV indicates information is in the output queue. The device clear (DCL) GPIB control message and the USBTMC INITIATE\_CLEAR control message will clear the output queue and also MAV.

\*CLS does not clear the output queue or MAV. \*CLS can suppress a service request that is to be generated by an \*OPC command. This will happen if a hard copy output or single sequence acquisition operation is still being processed when the \*CLS command is executed. See [Registers](#) on page 315

**Group** Status and Error

**Syntax** \*CLS

**Related Commands** [DESE](#) on page 102, [\\*ESE](#) on page 114, [\\*ESR?](#) on page 115, [EVENT?](#) on page 123, [EVMsg?](#) on page 124, [\\*SRE](#) on page 256, [\\*STB?](#) on page 257

**Examples** \*CLS clears the instrument status data structures.

## CURSor?

Returns current cursor settings. Query only.

**Group** Cursor

**Syntax** CURSor?

**Returns** instrument cursor settings.

**Examples** CURSor? might return the following string as the current cursor settings: :CURSOR:FUNCTION SCREEN;HBARS:POSITION1 0.0000;POSITION2 0.0000;UNITS BASE;:CURSOR:MODE INDEPENDENT;VBARS:POSITION1 -19.0006E-6;POSITION2 -18.9994E-6;UNITS SECONDS.

## CURSor:ENABLE

Allows educators to disable or enable the Cursor functions. The function can be manually set from the Utility menu. To access the menu, refer to the product user manual.

**Group** Miscellaneous

**Syntax** CURSor:ENABLE {ON | OFF}  
CURSor:ENABLE?

**Related commands** [CURSor](#)  
[FEAEN:PASSWORD](#) on page 128

**Arguments** ON enables the cursor feature.  
OFF disables the cursor feature.

**Examples** CURSOR:ENABLE OFF disables cursor.  
CURSOR:ENABLE? might return 1 indicating that cursor is enabled.

## CURSor:FUNcTion

Sets or queries the instrument cursor type. Cursors are attached to the selected waveform in Waveform mode and are attached to the display area in Screen mode.

**Group** Cursor

**Syntax** CURSor:FUNcTion {OFF|SCREEN|WAVEform|VBArS|HBArS}  
CURSor:FUNcTion?

**Arguments** OFF removes the cursors from the display but does not change the cursor type.  
SCREEN specifies both horizontal and vertical bar cursors, which measure the selected waveform in horizontal and vertical units. Use these cursors to measure anywhere in the waveform display area.  
WAVEform specifies paired cursors in YT display format for measuring waveform amplitude and time. In XY and XYZ format, these cursors indicate the amplitude positions of an XY pair (Ch1 vs Ch2 voltage, where Ch1 is the X axis and Ch2 is the Y axis) relative to the trigger.  
VBArS specifies the vertical bar cursor to measure the selected waveform in vertical units.  
HBArS specifies the horizontal bar cursor to measure the selected waveform in horizontal units.

**Examples** CURSOR:FUNCTION WAVEFORM selects the paired cursors for measuring waveform amplitude and time.  
CURSOR:FUNCTION? might return :CURSor:FUNcTion SCREEN indicating that the screen cursors are currently selected.

## CURSor:HBArS?

Returns the settings for the instrument horizontal bar cursors. Query only.

**Group** Cursor

**Syntax** CURSor:HBArS?

**Returns** Current horizontal bar cursor settings.

**Examples** CURSor:HBArS? might return the horizontal bar setting as return the horizontal bar setting as CURSOR:HBARS:POSITION1 320.0000E-03;POSITION2-320.0000E-03;UNITS BASE.

## CURSor:HBArS:DELTA?

Returns the difference (in vertical units) between the two horizontal bar cursors in the instrument display. Query only.

**Group** Cursor

**Syntax** CURSor:HBArS:DELTA?

**Related commands** [CURSor:HBArS:UNITS](#) on page 85

**Returns** <NR3> is the difference between the horizontal bar cursors.

**Examples**    `CURSOR:HBARS:DELTA?` might return `:CURSOR:HBARS:DELTA 5.0800E+00` indicating that the difference between the two cursors is 5.08.

## **CURSor:HBARs:POSITION<x>**

Sets or returns the horizontal bar cursor position relative to ground, which is expressed in vertical units (usually volts). The cursor is specified by x, which can be 1 or 2.

**Group**    Cursor

**Syntax**    `CURSor:HBARs:POSITION<x> <NR3>`  
`CURSor:HBARs:POSITION<x>?`

**Related commands**    [CURSor:FUNctIon](#) on page 82

**Arguments**    `<NR3>` specifies the horizontal bar cursor position, relative to ground (in volts when the units are volts and amps when the units are amps), relative to the center of the screen (in divs when units are divisions), or relative to 1 V RMS (in decibels when the source is an FFT math waveform), for the waveform specified by the `CURSor:SElect:SOURce` command.

The cursor position is limited to the graticule whenever an attempt is made to move it outside the graticule.

---

**NOTE.** *The source determines the measurement units.*

---

**Examples**    `CURSOR:HBARS:POSITION1 25.0E-3` positions Cursor 1 of the horizontal cursors at 25 mV.  
`CURSOR:HBARS:POSITION2?` might return `:CURSOR:HBARS:POSITION2 -64.0000E-03` indicating that Cursor 2 of the horizontal bar cursors is at -64 mV.

## CURSor:HBArS:UNIts

Sets or queries the vertical scale units for the selected cursor source waveform.

**Group** Cursor

**Syntax** CURSor:HBArS:UNIts {BASe|PERcent}  
CURSor:HBArS:UNIts?

**Arguments** BASe selects the vertical units for the selected waveform.  
PERcent selects ratio cursors.

**Examples** CURSor:HBArS:UNIts? might return :CURSOR:HBARS:UNITS BASE indicating that the units for the horizontal bar cursors are base.

## CURSor:HBArS:USE

Sets the horizontal bar cursor measurement scale. This command is only applicable when ratio cursors are on. No query form.

**Group** Cursor

**Syntax** CURSor:HBArS:USE {CURrent | HALFGrat | FIVEdivs}

**Related commands** [CURSor:HBArS:UNIts](#) on page 85

<b>Arguments</b>	<p>CURrent sets the H Bar measurement scale so that 0% is the current position of the lowest H Bar cursor and 100% is the current position of the highest H Bar cursor.</p> <p>HALFgrat resets the H bar measurement scale to half the number of divisions (five for some models and four for others) so that 25% is the current position of the lowest H Bar cursor and 75% is the current position of the highest H Bar.</p> <p>FIVEDivs sets H Bar measurement scale so that five screen major divisions is 100%, where 0% is -2.5 divisions and 100% is +2.5 divisions from the center horizontal graticule.</p>
<b>Examples</b>	<p>CURSOR:HBARS:USE FIVEDIVS sets the H Bar measurement scale so that 5 screen major divisions equals 100%.</p>

## CURSor:MODE

Sets or returns whether the two cursors move linked together in unison or separately. This applies to the Waveform cursors display mode.

<b>Conditions</b>	This command is only applicable when waveform cursors are displayed.
<b>Group</b>	Cursor
<b>Syntax</b>	CURSor:MODE {TRACk INDEpendent} CURSor:MODE?
<b>Arguments</b>	<p>TRACk ties the navigational functionality of the two cursors together. For cursor 1 adjustments, this ties the movement of the two cursors together; however, cursor 2 continues to move independently of cursor 1.</p> <p>INDEpendent allows independent adjustment of the two cursors.</p>



**Examples**    `CURSOR:MODE TRACK` specifies that the cursor positions move in unison.  
`CURSOR:MODE?` might return `:CURSOR:MODE TRACK` indicating that the two cursors move in unison.

## **CURSor:VBArS?**

Returns the current vertical bar cursor horizontal position and units settings.  
 Query only.

**Group**    Cursor

**Syntax**    `CURSor:VBArS?`

**Examples**    `CURSor:VBArS?` might return `CURSOR:VBARS:UNITS SECONDS;`  
`POSITION1 1.00E-6;POSITION2 9.00E-6.`

## **CURSor:VBArS:ALTERNATE<x>?**

Returns the alternate readout for the waveform (Vbar) cursors specified by `<x>`.  
 This alternate readout is in effect for a bus waveform. Query only.

**Group**    Cursor

**Syntax**    `CURSor:VBArS:ALTERNATE<x>?`

**Arguments**    `X = 1` specifies vertical bar cursor 1.  
`X = 2` specifies vertical bar cursor 2.

**Examples** CURSor:VBArS:ALTERNATE1? might return 1.001 indicating the vertical bar cursor 1 readout is 1.001.

## CURSor:VBArS:DELTA?

Returns the time or frequency difference between the two vertical bar cursors. The units (seconds or Hertz) are specified by the CURSor:VBArS:UNIts command. If the cursor source is an FFT math waveform, CURSor:VBArS:DELTA is always in Hertz, regardless of the value set by CURSor:VBArS:UNIts. Query only.

---

**NOTE.** *If Trigger View is active, this query returns 9.9E37 and generates event 221 (Settings conflict).*

---

**Group** Cursor

**Syntax** CURSor:VBArS:DELTA?

**Returns** <NR3>

**Examples** CURSor:VBArS:DELTA? might return 8.92E-1, indicating that the time difference between the vertical bar cursors is 0.892 seconds.

## CURSor:VBArS:HPOS<x>?

Returns the horizontal value of the specified vertical bar ticks for cursor <x>. The units are specified by the CURSor:HBArS:UNIts query. <x> specifies the cursor. Valid values are 1 and 2. Query only.

**Group** Cursor

**Syntax** CURSor:VBArS:HPOS<x>?

**Related Commands** [CURSor:HBArS:UNIts](#) on page 85

**Returns** <x> indicates the cursor. Valid values are 1 and 2.

**Examples** CURSOR:VBARS:HPOS1? might return CURSOR:VBARS:HPOS2 100E-3, indicating the value of one vertical bar tick.

## CURSor:VBArS:POSITION<x>

Positions a vertical bar cursor. The unit is specified by the CURSor:VBArS:UNIts command, and can be in units of seconds or frequency (Hertz). If the cursor source is an FFT math waveform, CURSor:VBArS:POSITION is always in Hertz, regardless of the value set by CURSor:VBArS:UNIts.

---

**NOTE.** *If Trigger View is active, the query form returns 9.9E37 and generates event 221 (Settings conflict).*

---

<b>Group</b>	Cursor
<b>Syntax</b>	CURSor:VBArS:POSITION<x> CURSor:VBArS:POSITION<x>?
<b>Arguments</b>	<x> specifies which cursor to position. Correct values are 1 and 2. <NR3> specifies the cursor position in the units specified by the CURSor:VBArS:UNIts command. The position is relative to the trigger except when the cursor source is a math FFT waveform. The cursor position is limited to the graticule whenever an attempt is made to move it outside the graticule.
<b>Examples</b>	CURSOR:VBARS:POSITION2 9.00E-6 positions the second vertical bar cursor at 9ms. CURSOR:VBARS:POSITION1? might return 1.00E-6, indicating the first vertical bar cursor is at 1 $\mu$ s.

## CURSor:VBArS:UNIts

Sets or queries the units for the vertical bar cursors.

---

**NOTE.** When Trigger View is active, CURSor:VBArS:UNIts? generates event 221 (Settings conflict).

---

<b>Group</b>	Cursor
<b>Syntax</b>	CURSor:VBArS:UNIts CURSor:VBArS:UNIts?

---

<b>Arguments</b>	SECOnds specifies units of time. HERtz specifies units of frequency (reciprocal of time).
<b>Examples</b>	CURSor:VBArS:UNItSSECONDS sets the units for the vertical bar cursors to seconds. CURSor:VBArS:UNItS? returns HERTZ when the vertical bar cursor units are Hertz.

## CURSor:VBArS:VDELTA?

Returns the vertical (amplitude) difference between the two vertical bar cursors. The units are specified by the CURSor:HBArS:UNItS query. Query only.

<b>Group</b>	Cursor
<b>Syntax</b>	CURSor:VBArS:VDELTA?
<b>Related commands</b>	<a href="#">CURSor:HBArS:UNItS</a> on page 85
<b>Returns</b>	<NR3> indicates the vertical difference between the two vertical bar cursors.
<b>Examples</b>	CURSor:VBArS:VDELTA? might return :CURSOR:VBARS:VDELTA 1.064E+0, indicating that the vertical difference between the vertical bar cursors is 1.064 units.

## CURVe

Transfers instrument waveform data to and from the instrument in binary or ASCII format. Each waveform that is transferred has an associated waveform preamble that contains information such as data format, scale, and associated information.

For analog waveforms, the CURVe? query sends data from the instrument to an external device. The data source is specified by the DATA:SOURce command. The first and last data points that are transferred are specified by the DATA:STARt and DATA:STOP commands.

---

**NOTE.** *If the waveform specified by the DATA:SOURce command is not displayed, the CURVe? query returns nothing, and generates events 2244 (Waveform requested is not activated) and 420 (Query UNTERMINATED).*

---

The instrument returns data from the last acquisition if the source is a channel waveform that is being previewed. The data does not reflect the acquisition preview parameters. You should always follow acquisition parameter changes with a single sequence OPC command prior to CURVe? to ensure the return data reflects the new acquisition parameters.

The CURVe command transfers waveform data from an external device to the instrument. The data is stored in the waveform location specified by DATA:DESTination, starting with the data point specified by DATA:STARt. Only one waveform can be transferred at a time. The waveform will only be displayed if the reference waveform is displayed.

Refer to *Waveform Commands* for a description of the waveform transfer process. [Waveform command group](#) on page 34

<b>Group</b>	Waveform
<b>Syntax</b>	CURVe {<Block> <asc curve>} CURVe?

**Related Commands** *DATA* on page 95, *DATA:START* on page 98, *DATA:STOP* on page 99, *WFMinpre?* on page 288, *WFMinpre:BYT\_Nr* on page 290, *WFMOupre?* on page 298, *HEADer* on page 147

**Arguments** <Block> is the waveform data in binary format. The waveform is formatted as: #<x><yyy><data><newline>, where:

- <x> is the number of y bytes. For example, if <yyy>=500, then <x>=3.
- <yyy> is the number of bytes to transfer if samples are one or two bytes wide. Use the *WFMinpre:BYT\_Nr* command to set the width for waveforms transferred into the instrument. Use *WFMOupre:BYT\_Nr* to set the width for waveforms transferred out from the instrument.
- <data> is the curve data.
- <newline> is a single byte new line character at the end of the data.
- <asc curve> is the waveform data in ASCII format. The format for ASCII data is <NR1>[,<NR1>...] where each <NR1> represents a data point.

**Examples** *CURVe?* with ASCII encoding, start and stop of 1 and 10 respectively, and a width set to 1 might return the following ASCII data:  
:CURVE 61,62,61,60,60,-59,-59,-58,-58,-59.





---

## D commands

This section lists commands and queries that begin with the letter D.

### DATA

Sets or queries the format and location of the waveform data that is transferred with the CURVe command.

**Group**    Waveform

**Syntax**    DATA {INIT|SNAp}  
DATA?

**Related Commands**    [CURVe](#) on page 92, [DATA:START](#) on page 98, [DATA:STOP](#) on page 99, [WFMinpre:NR\\_Pt?](#) on page 291, [WFMOupre:NR\\_Pt?](#) on page 302

**Arguments**    INIT reinitializes the waveform data settings to their factory defaults except for DATA:STOP, which is set to the current acquisition record length.  
SNAp sets DATA:START and DATA:STOP to match the current waveform cursor positions.

**Examples**    DATAINIT initializes the waveform data settings to their factory defaults.  
DATA? might return :DATA:DESTINATION REF1:ENCDG RIBINARY;SOURCE CH1;START 1;STOP 500;WIDTH 1.

## DATA:DESTination

Sets or queries the reference memory location for storing waveform data that is transferred into the instrument by the CURVe command.

**Group** Waveform

**Syntax** DATA:DESTination REF<x>  
DATA:DESTination?

**Related Commands** [CURVe](#) on page 92

**Arguments** REF<x> is the reference memory location where the waveform will be stored.

**Examples** DATA:DESTination REF1 stores incoming waveform data into reference memory 1.  
DATA:DESTination? might return :DATA:DESTINATION REF2 indicating that reference 2 is the currently selected reference memory location for incoming waveform data.

## DATA:SOURce

Sets or queries which waveform will be transferred from the instrument by the CURVe? query. You can transfer only one waveform at a time.

**Group**    Waveform

**Syntax**    DATA:SOURce{CH1|CH2|CH3|CH4| MATH|REF1|REF2}  
DATA:SOURce?

**Related Commands**    [CURVe](#) on page 92

**Arguments**    CH1–CH4 specifies which analog channel data will be transferred from the instrument to the controller, channels 1 through 4.

MATH specifies that the math waveform data will be transferred from the instrument to the controller.

REF1–REF2 specifies which reference waveform data will be transferred from the instrument to the controller, waveforms, 1 or 2.

**Examples**    DATA:SOURCE CH1 specifies that the channel 1 waveform will be transferred in the next CURVe? query.

DATA:SOURceREF1 specifies that reference waveform REF1 will be transferred in the next CURVe? query.

DATA:SOURce? might return :DATA:SOURCE REF2 indicating that the source for the waveform data which is transferred using a CURVe? query is reference 2.

## DATA:START

Sets or queries the starting data point for incoming or outgoing waveform transfer. This command lets you transfer partial waveforms to and from the instrument.

**Group** Waveform

**Syntax** DATA:START <NR1>  
DATA:START?

**Related Commands** [CURVE](#) on page 92, [DATA](#) on page 95, [DATA:STOP](#) on page 99, [WFMinpre:NR\\_Pt?](#) on page 291, [WFMOutpre:NR\\_Pt?](#) on page 302

**Arguments** <NR1> is the first data point that will be transferred, which ranges from 1 to the record length. Data will be transferred from <NR1> to DATA:STOP or the record length, whichever is less. If <NR1> is greater than the record length, the last data point in the record is transferred. DATA:START and DATA:STOP are order independent. When DATA:STOP is greater than DATA:START, the values will be swapped internally for the CURVE? query.

**Examples** DATA:START10 specifies that the waveform transfer will begin with data point 10.

DATA:START? might return :DATA:START 214 indicating that data point 214 is the first waveform data point that will be transferred.

## DATA:STOP

Sets or queries the last data point in the waveform that will be transferred when using the CURVe? query. This lets you transfer partial waveforms from the instrument

Changes to the record length value are not automatically reflected in the DATA:STOP value. As record length is varied, the DATA:STOP value must be explicitly changed to ensure the entire record is transmitted. In other words, curve results will not automatically and correctly reflect increases in record length if the distance from DATA:START to DATA:STOP stays smaller than the increased record length.

When using the CURVe command, the instrument stops reading data when there is no more data to read.

**Group**      Waveform

**Syntax**     DATA:STOP <NR1>  
DATA:STOP?

**Related Commands**    [CURVe](#) on page 92, [DATA](#) on page 95, [DATA:STOP](#) on page 99, [WFMinpre:NR\\_Pt?](#) on page 291, [WFMOupre:NR\\_Pt?](#) on page 302

**Arguments**        <NR1> is the last data point that will be transferred, which ranges from 1 to the record length. If <NR1> is greater than the record length, then data will be transferred up to the record length. If both DATA:START and DATA:STOP are greater than the record length, the last data point in the record is returned.

DATA:START and DATA:STOP are order independent. When DATA:STOP is less than DATA:START, the values will be swapped internally for the CURVe? query.

If you always want to transfer complete waveforms, set DATA:START to 1 and DATA:STOP to the maximum record length, or larger.

- Examples**     DATA:STOP15000 specifies that the waveform transfer will stop at data point 15000.
- DATA:STOP? might return :DATA:STOP 14900 indicating that 14900 is the last waveform data point that will be transferred.

## DATA:WIDTH

Sets or queries the number of bytes per data point in the waveform transferred using the CURVe command.

Changes to the record length value are not automatically reflected in the DATA:STOP value. As record length is varied, the DATA:STOP value must be explicitly changed to ensure the entire record is transmitted. In other words, curve results will not automatically and correctly reflect increases in record length if the distance from DATA:START to DATA:STOP stays smaller than the increased record length.

**Group**     Waveform

**Syntax**     DATA:WIDTH <NR1>  
DATA:WIDTH?

**Related Commands**     [CURVe](#) on page 92

**Arguments**     <NR1> = 1 sets the number of bytes per waveform data point to 1 byte (8 bits).  
<NR1> = 2 sets the number of bytes per waveform data point to 2 bytes (16 bits).  
If DATA:WIDTH is set to 2, the least significant byte is always zero. This format is useful for AVErage waveforms.

**Examples**    DATA:WIDTH1 sets the data width to 1 byte per data point for CURVe data.

## DATE

Sets or queries the instrument date value. The instrument uses these values to time stamp files saved to the USB flash drive, as well as show the time and date on the instrument display.

**Group**    Miscellaneous

**Syntax**    DATE  
              DATE?

**Related Commands**    [TIMe](#) on page 259

**Arguments**    <QString> is a date in the form "yyyy-mm-dd".

**Examples**    DATE"2010-05-06" sets the date to May 6th, 2010.  
DATE? might return :DATE 2015-10-29 indicating that the current date is set to Oct. 29, 2015.

## DESE

Sets or queries the bits in the Device Event Status Enable Register (DESER). The DESER is the mask that determines whether events are reported to the Standard Event Status Register (SESR), and entered into the Event Queue. For a detailed discussion of the use of these registers, see Registers.

**Group** Status and Error

**Syntax** DESE <NR1>  
DESE?

**Related Commands** [\\*CLS](#) on page 79, [\\*ESE](#) on page 114, [\\*ESR?](#) on page 115, [EVENT?](#) on page 123, [EVMsg?](#) on page 124, [\\*SRE](#) on page 256, [\\*STB?](#) on page 257

**Arguments** <NR1> is an integer value in the range from 0 to 255. The binary bits of DESER are set according to this value. For example, DESE 209 sets the DESER to the binary value 11010001 (that is, the most significant bit in the register is set to 1, the next most significant bit to 1, the next bit to 0, and so on).

The power-on default for DESER is all bits set to 1 if \*PSC is 1. If \*PSC is 0, the DESER maintains its value through a power cycle.

---

**NOTE.** Setting *DESER* and *ESER* to the same value allows only those codes to be entered into the Event Queue and summarized on the ESB bit (bit 5) of the Status Byte Register. Use the *\*ESE* command to set *ESER*. For more information on event handling, refer to the Status and Events section.

---

**Examples** DESE209 sets the DESER to binary 11010001, which enables the PON, URQ, EXE, and OPC bits.

DESE? might return the following string :DESE 186 , showing that DESER contains the binary value 10111010.



## DIAg:FAN

Returns the currently set PWM fan value. Only query.

**Group** Calibration and diagnostic

**Syntax** DIAg:FAN?

**Examples** DIAg:FAN? might return PWM=10, VOL=7.4V.

## DIAg:LOOP:OPTion

Sets the self-test loop option.

**Group** Calibration and diagnostic

**Syntax** DIAg:LOOP:OPTion {ALWAYS|FAIL|ONFAIL|ONCE|NTIMES}

**Arguments**

- ALWAYS continues looping until the self tests (diagnostics) are stopped via the front panel or by an instrument command.
- FAIL causes looping until the first self test (diagnostic) failure or until self tests (diagnostics) are stopped.
- ONFAIL causes looping on a specific test group as long as a FAIL status is returned from the test.
- ONCE executes self test (diagnostics test) sequence once.
- NTIMES runs “n” number of loops.

**Examples**    `DIAG:LOOP:OPTion ONCE` sets diagnostics to run one loop of self tests.

## **DIAG:LOOP:OPTion:NTIMes**

Sets the self-test loop option to run N times.

**Group**    Calibration and diagnostic

**Syntax**    `DIAG:LOOP:OPTion:NTIMes <NR1>`  
`DIAG:LOOP:OPTion:NTIMes?`

**Arguments**    <NR1> is the number of self-test loops.

**Examples**    `DIAG:LOOP:OPTion:NTIMES 3` sets the self-test loop to run three times.  
`DIAG:LOOP:OPTion:NTIMES?` might  
return `:DIAG:LOOP:OPTion:NTIMES 5`, indicating that the self-test loop is set  
to run five times.

## **DIAG:LOOP:STOP**

Stops the self-test at the end of the current loop. No query form.

**Group**    Calibration and diagnostic

**Syntax**    `DIAG:LOOP:STOP`

---

**Examples**    `DIAG:LOOP:STOP` stops the self test at the end of the current loop.

## **DIAG:RESULT:FLAG?**

Returns the Pass/Fail status from the last diagnostic test sequence execution (those run automatically at power on, or those requested through the Service Menu). Use the `DIAG:RESULT:LOG?` query to determine which test(s) has failed. Query only.

**Group**    Calibration and Diagnostic

**Syntax**    `DIAG:RESULT:FLAG?`

**Returns**    `PASS` means that the instrument passes all selected diagnostic tests.  
`FAIL` means that the instrument has failed at least one of the diagnostic tests.

**Examples**    `DIAG:RESULT:FLAG`  
Returns either `PASS` or `FAIL`.

## **DIAG:RESULT:LOG?**

Returns the internal results log from the last diagnostic test sequence execution (those run automatically at power on, or those requested through the Service Menu). The list contains all modules and module interfaces that were tested with the pass or fail status of each. Query only.

**Group**    Calibration and Diagnostic

**Syntax**    `DIAG:RESULT:LOG?`

**Returns**    `<QString>` in the following format:  
`<Status>,<Module name>[,<Status>,<Module name>...]`

**Examples**    `DIAG:RESULT:LOG?` might return `:DIAG:RESULT:LOG "NOT RUN--CPU,NOT RUN--DISPLAY,NOT RUN--FPANEL,NOT RUN--IO,NOT RUN--ACQ,NOT RUN--ROM,NOT RUN--APPKEY"` for power-up diagnostics.

## DIAG:SElect

Sets the type of diagnostics grouping. No query form.

**Group**        Calibration and diagnostic

**Syntax**        `DIAG:SElect {ALL|APPKey|CPU|DISplay|FPAnel|IO|ROM|ACQ}`

**Argument**     ALL runs all diagnostic groups.  
CPU runs just the CPU diagnostic group.  
DISplay runs just the display circuit diagnostic group.  
FPAnel runs just the front panel diagnostic group.  
IO runs just the IO board diagnostic group.  
ROM runs just the IO board diagnostic group.  
ACQ runs just the acquisition system diagnostic group.

**Examples**    DIAg:SElect ALL runs all diagnostic groups.

## DIAg:SElect:<function>

Runs self-tests on the specified system subsystem. No query form.

**Group**    Calibration and diagnostic

**Syntax**    DIAg:SElect:<function>

**Arguments**    <function> specifies a single instrument subsystem on which to run self tests (diagnostics). Valid values are:

- ACQ tests the acquisition system.
- CPU tests the CPU.
- DISplay tests the display.
- FPAnel tests the front panel controls.
- IO tests the IO ports.
- ROM tests the system read only memory.

**Examples**    DIAg:SElect:ACQ specifies to run self tests on the acquisition system.

## DIAg:STATE

This command starts or stops the instrument self-test. Depending on the argument, self-test capabilities are either turned on or off. No query form.

**Group**    Calibration and diagnostic

**Syntax**    `DIAG:STATE {EXECute|ABORt}`

**Arguments**    `EXECute` starts diagnostics.  
                  `ABORt` stops diagnostics at the end of the current loop.

**Examples**    `DIAG:STATE EXECute` starts diagnostics.

## DIAG:TEMPVAL

Read out the currently FPGA chip and ambient temperature. Only query.

**Group**        Calibration and diagnostic

**Syntax**       `DIAG:TEMPVAL?`

**Examples**    `DIAG:TEMPVAL?` might return: VDC Temp=-256, Ambient Temp=32

## DISplay:GRAticule

Sets and returns the display graticule intensity settings.

**Group**        Miscellaneous

**Syntax**       `DISplay:GRAticule {<NR1>|ON|OFF}`  
                  `DISplay:GRAticule?`

**Arguments** ON or <NR1> ≠ 0 turns on the graticule in the screen display.  
OFF or <NR1> = 0 turns off the graticule in the screen display.

**Examples** DISPLAY:GRATICULE 0 sets NO graticule to display.  
DISPLAY:GRATICULE? might return :DISPLAY:GRATICULE 1 indicating that the graticule is on.

## DISplay:INTENSITY:BACKLight

Sets and returns the waveform backlight intensity settings.

**Group** Miscellaneous

**Syntax** DISplay:INTENSITY:BACKLight <NR1>  
DISplay:INTENSITY:BACKLight ? <NR1>

**Arguments** <NR1> specifies the range from 1 to 100.

**Examples** DISplay:INTENSITY:BACKLight <NR1>  
DISPLAY:INTENSITY:BACKLIGHT? might  
return :DISPLAY:INTENSITY:BACKLIGHT 60

## DISplay:PERsistence:STATe

Sets or returns the display persistence to ON or OFF. The query form returns the persistence state. This affects the display only.

**Group** Display

**Syntax** DISplay:PERsistence:STATe {ON | OFF | <NR1>}  
DISplay:PERsistence:STATe?

**Arguments** ON turns on the persistence on for the display.  
OFF turns the persistence off for the display.  
<NR1>=0 turns off the persistence for the display; any other value turns on the persistence for the display.

**Examples** DISplay:PERsistence:STATe ON turns on the persistence on the display for all waveforms.  
DISplay:PERsistence:STATe? might return 1 indicating that the persistence is ON for the display.

## DISplay:PERsistence:VALUe

Sets the value of persistence if the persistence state is set to on. This affects the display only.

**Group** Display



**Syntax**    DISplay:PERStence:VALUe {<NR3> | AUTO | INFInite}  
              DISplay:PERStence:VALUe?

**Arguments**    <NR3> specifies the time of the persistence.

INFInite displays waveform points until a control change resets the acquisition system. When persistence is set to infinite, it does not mean that the brightness of any pixel should never decrease. The brightness of a pixel is proportionally dependent on the ratio between the intensity, which does NOT decrease at infinite persistence, and the maximum value of intensity of any pixel on the screen. Thus, if a particular pixel gets hit less often than others, its brightness will decrease over time. It will become less bright relative to the pixels that get hit often. AUTO specifies that the oscilloscope automatically determines the best waveform persistence based on the value of waveform intensity (DISPLAY:INTENSITY:WAVEFORM)

**Examples**    DISplay:PERStence:VALUe 3 specifies that the waveform points are displayed fading for 3 seconds before they completely disappear.



---

## E commands

This section lists commands and queries that begin with the letter E.

### ERRLOG:FIRST?

Returns the first entry in the error log, or an empty string if the error log is empty. Use this command with ERRLOG:NEXT? to retrieve error log messages. Query only.

**Group** Calibration and Diagnostic

**Syntax** ERRLOG:FIRST?

**Returns** Refer to the service manual for your instrument for information about error log message format.

### ERRLOG:NEXT?

Returns the next entry in the error log, or an empty string if the error log is empty or you have reached the end of the log. To start at the top of the error log, run the ERRLOG:FIRST? query to return the first error log message. Then use the ERRLOG:NEXT? query to step through the error log. Query only.

**Group** Calibration and Diagnostic

**Syntax** ERRLOG:NEXT?

**Returns** Refer to the service manual for your instrument for information about error log message format.

## \*ESE

Sets and queries the bits in the Event Status Enable Register (ESER). The ESER prevents events from being reported to the Status Byte Register (STB). For a detailed discussion on how to use registers, see Registers. Command only, no query form.

**Group** Status and Error

**Syntax** \*ESE <NR1>  
\*ESE?

**Related Commands** [\\*CLS](#) on page 79, [DESE](#) on page 102, [\\*ESR?](#) on page 115, [EVENT?](#) on page 123, [EVMsg?](#) on page 124, [\\*SRE](#) on page 256, [\\*STB?](#) on page 257

**Arguments** <NR1> is a value in the range from 0 through 255. The binary bits of the ESER are set according to this value.

The power-on default for ESER is 0 if \*PSC is 1. If \*PSC is 0, the ESER maintains its value through a power cycle.

---

**NOTE.** Setting the *DESER* and the *ESER* to the same value allows only those codes to be entered into the Event Queue and summarized on the *ESB* bit (bit 5) of the Status Byte Register. Use the *DESE* command to set the *DESER*. See [Event Handling Sequence](#) on page 320.

---

**Examples** \*ESE209 sets the ESER to binary 11010001, which enables the PON, URQ, EXE, and OPC bits.

\*ESE? might return the string \*ESE 186, showing that the ESER contains the binary value 10111010.

## \*ESR?

Returns the contents of the Standard Event Status Register (SESR). \*ESR? also clears the SESR (since reading the SESR clears it). For a detailed discussion on how to use registers, see Registers. Query only.

**Group** Status and Error

**Syntax** \*ESR?

**Related Commands** [ALLEv?](#) on page 52, [\\*CLS](#) on page 79, [DESE](#) on page 102, [\\*ESE](#) on page 114, [EVENT?](#) on page 123, [EVMsg?](#) on page 124, [\\*OPC](#) on page 213, [\\*SRE](#) on page 256, [\\*STB?](#) on page 257

**Returns** Contents of the Standard Event Status Register.

**Examples** \*ESR? might return the value 213, showing that the SESR contains binary 11010101.

## ETHERnet:DHCPbootp

Sets or queries the network initialization search for a DHCP/BOOTP server.

**Group** Ethernet

**Syntax** ETHERnet:DHCPbootp {<NR1>|ON|OFF}  
ETHERnet:DHCPbootp?

**Arguments** ON enables the instrument to search the network for a DHCP or BOOTP server in order to automatically assign a dynamic IP address to the instrument.

---

**NOTE.** *Do not use DHCP/BOOTP searching if your instrument has been assigned a static address on a network. If you set this command to ON, the DHCP/BOOTP search will delete or change your static IP address information.*

---

OFF disables the instrument to search the network for a DHCP or BOOTP

<NR1> = 0 disables the instrument to search the network for a DHCP or BOOTP; any other value enables the search.

**Examples** ETHERnet:DHCPbootp ON sets the instrument to search for a DHCP or BOOTP server and assigns a dynamic IP address to the instrument

ETHERnet:DHCPbootp? might return 1 indicating the instrument will search for a DHCP or BOOTP.

## ETHERnet:DNS:IPADDRESS

Sets or returns the network Domain Name Server (Dns) IP address.

**Group** Ethernet

**Syntax** ETHERnet:DNS:IPADDRESS <QString>  
ETHERnet:DNS:IPADDRESS?

**Arguments** <QString> is a standard IP address value, enclosed in quotes.

**Examples** ETHERNET:DNS:IPADDRESS "134.64.216.239" sets the Dns IP address that the instrument uses to communicate with the network.  
ETHERNET:DNS:IPADDRESS? might return :ETHERNET:DNS:IPADDRESS "134.64.216.239".

## ETHERnet:DOMAINname

Sets or returns the network domain name.

**Group** Ethernet

**Syntax** ETHERnet:DOMAINname <Qstring>  
ETHERnet:DOMAINname?

**Arguments** <QString> is the network domain name, enclosed in quotes.

**Examples** ETHERNET:DOMAINNAME “EngrLab” sets the domain name that the instrument uses to communicate with the network  
ETHERNET:DOMAINNAME? might return :ETHERNET:DOMAINNAME “EngrLab”.

## ETHERnet:ENET:ADDRESS?

Returns the Ethernet address value assigned to the instrument. This is assigned at the factory and can not be changed. Query only.

**Group** Ethernet

**Syntax** ETHERnet:ENET:ADDRESS?

**Examples** ETHERNET:ENET:ADDRESS? returns an Ethernet address such as d0:ff:50:09:0a:99.

## ETHERnet:GATEWay:IPADDRESS

Sets or queries the remote interface gateway IP address.

**Group** Ethernet

**Syntax** ETHERnet:GATEWay:IPADDRESS <QString>  
ETHERnet:GATEWay:IPADDRESS?



**Arguments** <QString> is a standard IP address value, enclosed in quotes.

**Examples** ETHERNET:GATEWAY:IPADDRESS "134.64.223.1" sets the gateway IP address.

ETHERNET: GATEWAY:IPADDRESS? might return :ETHERNET:GATEWAY:IPADDRESS "134.64.223.1".

## ETHERnet:HTTPPort

Sets or queries the remote interface HTTP port value.

**Group** Ethernet

**Syntax** ETHERnet:HTTPPort <QString>  
ETHERnet:HTTPPort?

**Arguments** <QString> is an integer port number, enclosed in quotes.

---

**NOTE.** Consider the following if you are using the e\*Scope™ control software. If you don't enter a port address in the URL, then the ETHERnet:HTTPPort value must be set to "80", which is the default port for HTTP protocol. If you use a URL with a port address (for example: <http://DPO2004-04WKL4:1234>), the port number is specified by the number after the colon. Set the ETHERnet:HTTPPort value to this same number.

---

**Examples** ETHERNET:HTTPPORT "80" sets the HTTP port value to 80.

ETHERNET:HTTPPORT? might return :ETHERNET: HTTPPORT "80"

## ETHERnet:IPADdress

Sets or queries the IP address assigned to the instrument.

**Group** Ethernet

**Syntax** ETHERnet:IPADdress <QString>  
ETHERnet:IPADdress?

**Arguments** <QString> is a standard IP address value, enclosed in quotes.

**Examples** ETHERNET:IPADDRESS "134.64.223.47" sets the instrument IP address.  
ETHERNET: IPADDRESS? might return :ETHERNET:IPADDRESS  
"134.64.223.47".

## ETHERnet:NAME

Sets or queries the network name assigned to the instrument.

**Group** Ethernet

**Syntax** ETHERnet:NAME <QString>  
ETHERnet:NAME?

**Arguments** <QString> is the network name assigned to the instrument, enclosed in quotes.

**Examples**   ETHERNET:NAME "TBS2102-Bench12" sets the instrument network name.  
ETHERNET:NAME? might return :ETHERNET: NAME "TBS2102-Bench12".

## ETHERnet:PASSWord

Sets or queries the HTTP Ethernet access password. If a password is set, you must enter the password before the Web browser can access the instrument.

**Group**   Ethernet

**Syntax**   ETHERnet:PASSWord <new>  
ETHERnet:PASSWord?

**Arguments**   <new> is a new password, enclosed in quotes.

**Examples**   ETHERNET:PASSWORD "123456" replaces the current Ethernet password with the new password 123456.  
ETHERNET:PASSWORD? might return :ETHERNET:PASSWORD "123456".

## ETHERnet:PING

Causes the instrument to ping the gateway IP address. No query form.

**Group**   Ethernet

**Syntax** ETHERnet:PING EXECute

**Arguments** EXECUTE causes the instrument to ping the gateway IP address.

**Examples** ETHERNET:PING EXECUTE causes the instrument to ping the gateway IP address.

## ETHERnet:PING:STATUS?

Returns the results from sending the ETHERnet:PING command to ping the gateway IP address. Query only.

**Group** Ethernet

**Syntax** ETHERnet:PING:STATUS?

**Returns** OK is returned if the computer at the gateway IP address answers.  
NORESPONsE is returned if the computer at the gateway IP address does not answer.  
INPROGRESS is returned if the ping operation is still executing.

**Examples** ETHERnet:PING:STATUS? might return OK if the computer at the gateway IP address answers.

## ETHERnet:SUBNETMask

Sets or queries the remote interface subnet mask value.

**Group** Ethernet

**Syntax** ETHERnet:SUBNETMask <QString>  
ETHERnet:SUBNETMask?

**Arguments** <QString> is the subnet mask value, enclosed in quotes.

**Examples** ETHERNET:SUBNETMASK "255.255.255.0" sets the subnet mask value using standard IP address notation format.  
ETHERnet:SUBNETMask? might return "" indicating there is no subnet mask.

## EVENT?

Returns from the Event Queue an event code that provides information about the results of the last \*ESR? read. EVENT? also removes the returned value from the Event Queue. Query only.

**Group** Status and Error

**Syntax** EVENT?

**Related Commands** [ALLEv?](#) on page 52, [\\*CLS](#) on page 79, [DESE](#) on page 102, [\\*ESE](#) on page 114, [\\*ESR?](#) on page 115, [EVMsg?](#) on page 124, [\\*SRE](#) on page 256, [\\*STB?](#) on page 257

**Returns** <NR1> the last \*ESR.

**Examples** EVENT? might return EVENT 110, indicating there was an error in a command header.

## EVMsg?

Removes from the Event Queue a single event code associated with the results of the last \*ESR? read, and returns the event code with an explanatory message. Query only.

**Group** Status and Error

**Syntax** EVMsg?

**Related Commands** [ALLEv?](#) on page 52, [\\*CLS](#) on page 79, [DESE](#) on page 102, [\\*ESE](#) on page 114, [\\*ESR?](#) on page 115, [EVENT?](#) on page 123, [\\*SRE](#) on page 256, [\\*STB?](#) on page 257

**Returns** The event code and message in the following format:  
<Event Code><Comma><QString>[<Event Code><Comma> <QString>...]  
<QString> ::= <Message>:[<Command>]

where <Command> is the command that caused the error and may be returned when a command error is detected by the instrument. As much of the command as possible is returned without exceeding the 60 character limit of the <Message> and <Command> strings combined. The command string is right-justified.

**Examples** EVMsg? might return the message EVMSG 110, "Command header error"

## EVQty?

Returns the number of event codes that are in the Event Queue. This is useful when using ALLEv? since it lets you know exactly how many events will be returned. Query only.

**Group** Status and Error

**Syntax** EVQty?

**Related Commands** [ALLEv?](#) on page 52, [EVENT?](#) on page 123, [EVMsg?](#) on page 124

**Returns** <NR1> is the number of event codes in the Event Queue.

**Examples** EVQty? might return :EVQTY 3 indicating the number of event codes in the Event Queue is 3.





---

# F commands

This section lists commands and queries that begin with the letter F.

## FACTory

Resets the instrument to its factory default settings. Refer to Appendix B: Factory Setup for a list of the factory default settings. No query.

This command does the following:

- Clears the Event Status Enable Register
- Clears the Service Request Enable Register
- Sets the Device Event Status Enable Register to 255
- Purges all defined aliases
- Enables all Command Headers
- Sets the macro defined by \*DDT to a "zero-length field
- Clears the pending operation flag and associated operations

This command does not reset the following:

- Communication settings
- State of the VXI-11 (Ethernet IEEE Std 488.2) interface
- Calibration data that affects device specifications
- Protected user data
- Stored settings
- Power On Status Clear Flag
- instrument password

**Group** Save and Recall

**Syntax** FACTory

**Related Commands**    *\*PSC* on page 215, *\*RCL* on page 217, *RECALL:SETUp* on page 218, *\*RST* on page 224, *\*SAV* on page 225, *SAVe:SETUp* on page 229, *SAVe:IMAge:FILEFormat* on page 227

**Examples**    *FACTORY* resets the instrument to its factory default settings. Refer to *Factory Setup*.

## FEAEN:PASSWORD

Checks if the password entered is equal to the preset password for Feature Enable which allows the educators to enable or disable features such as Autoset, Cursors or Measurements. The same can be set manually from the Utility menu when we try to change the settings of Autoset Enable, Cursors Enable or Measurement Enable from Feature Enable. No query form. To access the menu, refer product user manual.

**Group**    Miscellaneous

**Syntax**    FEAEN:PASSWORD <password>

**Related Commands**    *AUTOSet:ENABLE* on page 53  
*CURSOr:ENABLE* on page 81  
*MEASUrement:ENABLE*

**Arguments**    <password> is the feature enable password, enclosed in quotes.

**Examples**    FEAEN:PASSWORD "111111" allows the user to change the settings of Feature Enable if the feature enable password matches the string "111111".

## FFT?

Returns all FFT parameters. Query only.

**Group** FFT

**Syntax** FFT?

**Related commands** [FFT:VERTical:SCale](#) on page 132, [FFT:VERTical:POSition](#) on page 132, [FFT:VERTical:UNIts](#) on page 133, [FFT:HORizontal:SCale](#) on page 130, [FFT:HORizontal:POSition](#) on page 129, [FFT:SOURce](#) on page 130, [FFT:SRCWFM](#) on page 131, [FFT:WINDow](#) on page 134, [SElect:FFT](#) on page 246

**Examples** FFT? might return ON; CH1; 20; 0.000; "dB"; 250.000E+3; 750.000E+3; "Hz"; ON, "HANNING"

## FFT:HORizontal:POSition

Sets or queries the FFT horizontal display position.

**Group** FFT

**Syntax** FFT:HORizontal:POSition <NR3>  
FFT:HORizontal:POSition?

**Arguments** <NR3> is the FFT horizontal display position.

**Examples**    FFT:HORizontal:POSition 750.0E+3 sets the FFT horizontal position to 750.0E+3.  
                  FFT:HORizontal:POSition? might return 750.000E+3.

## FFT:HORizontal:SCAle

Sets or queries the horizontal scale of the FFT waveform.

**Group**    FFT

**Syntax**    FFT:HORizontal:SCAle <NR3>  
                  FFT:HORizontal:SCAle?

**Arguments**    <NR3> is the FFT horizontal scale.

**Examples**    FFT:HORizontal:SCAle 500.00E+6 sets the FFT horizontal scale to 500 MHz.  
                  FFT:HORizontal:SCAle? might return 500.00E+6 indicating the FFT horizontal scale is set to 500 MHz.

## FFT:SOURce

Sets or queries the source of the FFT waveform.

**Group**    FFT

<b>Syntax</b>	FFT:SOURce {CH1 CH2 CH3 CH4} FFT:SOURce?
<b>Arguments</b>	{CH1 CH2 CH3 CH4} the FFT source channel.
<b>Examples</b>	FFT:SOURce ch2 sets the FFT source waveform to CH2. FFT:SOURce? might return "CH2" if CH2 is the FFT source waveform.

## FFT:SRCWFM

Sets or queries the FFT source waveform display state.

<b>Group</b>	FFT
<b>Syntax</b>	FFT:SRCWFM <ON OFF NR1> FFT:SRCWFM?
<b>Arguments</b>	<NR1> = 0 does not display the FFT source waveform, any other value displays the FFT source waveform.
<b>Examples</b>	FFT:SRCWFM 0 turns off the display of the FFT source waveform. FFT:SRCWFM? might return 1 indicating the FFT source waveform is displayed.

## FFT:VERTical:POStion

Sets or queries the FFT vertical display position.

**Group** FFT

**Syntax** FFT:VERTical:POStion <NR2>  
FFT:VERTical:POStion?

**Arguments** <NR2> is the FFT vertical position.

**Examples** FFT:VERTical:POStion 2 sets the FFT vertical position to 2 divisions above center screen.  
FFT:VERTical:POStion? might return 2.000.

## FFT:VERTical:SCAlE

Sets or queries the FFT vertical zoom factor.

**Group** FFT

**Syntax** FFT:VERTical:SCAlE <NR2>  
FFT:VERTical:SCAlE?

**Arguments** <NR2> is the FFT vertical scale.

**Examples**    FFT:VERTical:SCAle 20 sets the FFT waveform vertical scale to 20.  
FFT:VERTical:SCAle? might return 20.00 indicating the FFT waveform vertical scale is 20 dB.

## FFT:VERTical:UNIts

Queries the FFT vertical measurement units label.

**Group**    FFT

**Syntax**    FFT:VERTical:UNIts?

**Examples**    FFT:VERTical:UNIts? might return dB indicating the FFT vertical units are set to dB.

## FFT:VType

Sets or queries the FFT waveform vertical units.

**Group**    FFT

**Syntax**    FFT:VType {DB|LINEAr}  
FFT:VType?

**Examples**    FFT:VType DB sets the FFT waveform vertical units to dB.  
FFT:VType? might return DB.

## FFT:WINDow

Sets or queries the FFT window type.

**Group** FFT

**Syntax** FFT:WINDow {HAMming|HANning|RECTangular|BLAckmanharris}  
FFT:WINDow?

**Arguments** RECTangular window function is equivalent to multiplying all gate data by one.  
HAMming window function is based on a cosine series.  
HANning window function is based on a cosine series.  
BLAckmanharris window function is based on a cosine series.

**Examples** FFT:WINDow HAMMING sets the FFT window to Hamming.  
FFT:WINDow? might return HAMMING.

## FILESystem?

Returns the current working directory and amount of free space. This query is the same as the FILESystem:DIR? query and the FILESystem:FREESpace? query.  
Query only.

.

**Group** File system



**Syntax** FILESystem  
FILESystem?

**Related commands** *FILESystem:CWD* on page 135, *FILESystem:DELEte* on page 136, *FILESystem:DIR?* on page 137, *FILESystem:REName* on page 140

**Examples** FILESYSTEM? might return :FILESYSTEM:DIR  
"TEK00000.BMP", "GLITCH1.PNG", "TEMP.TMP",  
"FILE1.WFM", "FILE2.WFM", "MATH1.WFM", "REF1.WFM", "REF2.WFM".

## FILESystem:CWD

Sets or queries the current working directory (CWD) for FILESystem commands.

The default working directory is USB0. Anytime you use this command to change the directory, the directory that you specify is retained as the current working directory until you either change the directory or you delete the directory. If you delete the current working directory, the instrument resets current working directory to the default directory (USB0) the next time the instrument is powered on or the next time you execute a file system command.

This command supports the permutations of file and directory names supported by Microsoft Windows:

Relative path names; for example, "./temp"

Absolute path names; for example, "USB0/Wfms"

Implied relative path names; for example "NEWFILE.TXT" becomes "USB0/TEKSCOPE/NEWFILE.TXT" if the current working directory is "USB0/TEKSCOPE"

**Group** File system

**Syntax** FILESystem:CWD {<new working directory path>}  
FILESystem:CWD?

**Arguments** <new working directory path> is a quoted string that defines the current working; a directory name can have up to 8 characters with an extension of up to 3 characters.

**Examples** FILESYSTEM:CWD " USB0/TEKSCOPE/IMAGES" sets the current working directory to images.  
FILESYSTEM:CWD? might return :FILESYSTEM:CWD " USB0/TEKSCOPE/WAVEFORMS" indicating that the current working directory is set to waveforms.

## FILESystem:DELEte

This command deletes a named file. If you specify a directory name, it will delete the directory and all of its contents, the same as the RMDir command. You can also specify the filename as \*.\* to delete all of the files in the current or specified directory. Command only, no query form.

**Group** File system

**Syntax** FILESystem:DELEte <file path>

**Related commands** [FILESystem:CWD](#) on page 135, [FILESystem:RMDir](#) on page 141

**Arguments** <file path> is a quoted string that defines the folder path and file name of the file to delete. If the file path is within the current working directory, you need only specify the file name. The argument \*.\* will delete all files and subdirectories within the current working directory.

**Examples** FILESYSTEM:DELETE "NOT\_MINE.SET" deletes the file named NOT\_MINE.SET from the current working directory.

## FILESystem:DIR?

Returns a list of quoted strings. Each string contains the name of a file or directory in the current working directory. Query only.

**Group** File system

**Syntax** FILESystem:DIR?

**Related commands** [FILESystem:CWD](#) on page 135, [FILESystem:RMDir](#) on page 141

**Returns** FILESystem:DIR? returns a list of files and directories in the current working directory.

**Examples** FILESystem:DIR? might return :FILESYSTEM:DIR  
"TEK00000.PNG", "CANSETUP.SET", "WFM1.ISF", "MYIMAGES".

## FILESystem:FORMat

Formats a mass storage device. This command should be used with extreme caution as it causes all data on the specified mass storage device to be lost. Drive letters (such as USB0) are case sensitive and must be upper case. For all other FILESYSTEM commands, drives letters are not case sensitive. Example: FILESystem:FORMat " USB0/" Formats the USB flash drive installed in the instrument's front panel USB port. Command only, no query form.

**Group** File system

**Syntax** FILESystem:FORMat <drive>

**Arguments** <drive> is a quoted string that sets the drive to format.

**Examples** FILESystem:FORMat"/usb0/" formats the USB flash drive installed in the instrument front panel USB port.

## FILESystem:FREESpace?

Returns a numeric value, in bytes, of the memory space available on the current drive. Query only.

**Group** File system

**Syntax** FILESystem:FREESpace?

**Related commands**    [FILESystem:CWD](#) on page 135

**Examples**    FILESystem:FREEspace? might return 6242501.

## FILESystem:MKDir

Creates a folder at the specified location. Command only, no query form.

**Group**    File system

**Syntax**    FILESystem:MKDir <directory path>

**Related commands**    [FILESystem:CWD](#) on page 135, [FILESystem:DIR?](#) on page 137

**Arguments**    <directory path> is a quoted string that defines the location and name of the directory to create. If you do not specify a path to the directory, the instrument creates the directory in the current working directory. The current directory refers to the name of a directory as returned by the FILESystem:CWD query.

Directory names must follow the same rules as file names. [File System Conventions](#) on page 19

**Examples**    FILESYSTEM:MKDIR " USB0/NewDirectory" creates the directory named NEWDIRECTORY at the root of the E drive.

The following two commands create the directory MYNEWSUBDIRECTORY within the existing directory mydirectory at the root of the USB0 drive:  
FILESYSTEM:CWD " USB0/MyDirectory";FILESYSTEM:MKDIR "MyNewSubDirectory" This assumes that USB0/MYDIRECTORY already existed and was not a read-only directory.

## FILESystem:READFile

Writes the contents of the specified file to the specified interface. If the file does not exist or is not readable, an appropriate error event is posted. No query form.

**Group** File System

**Syntax** FILESystem:READFile <QString>

**Related commands** [FILESystem:CWD](#) on page 135

**Arguments** <QString> is a quoted string that defines the file name and path. If the file path is within the current working directory, specify only the file name.

**Examples** FILESYSTEM:READFILE "USB0/TEST\_DATA/TEK00016CH1.CSV" reads the content of the specified file, if the file exists and is readable, and sends the content of the file to the current interface.

## FILESystem:REName

Assigns a new name to an existing file or folder. You can also move a file or folder by specifying the new name in a different folder. Command only, no query form.

For file and folder name rules, see *File System Conventions*. [File System Conventions](#) on page 19

**Group** File system

---

**Syntax** FILESystem:REName <old file path>,<new file path>

**Related commands** *FILESystem:CWD* on page 135

**Arguments** <old filepath> is a quoted string that defines the path and name of the file to rename. If you do not specify a path to the file, the instrument looks for the file in the current working folder. The current directory refers to the name of a folder as returned by the FILESystem:CWD query.

<new filepath> is a quoted string that defines the path and new name of the file. If you do not specify a path to a folder, the instrument places the renamed file into the current working folder. *File System Conventions* on page 19

**Examples** FILESYSTEM:RENAME " USB0/TEK00000.SET","D:/MYSETTING.SET" gives the file named TEK00000.SET the new name of MYSETTING.SET. The file remains in the root directory on the D drive.

## FILESystem:RMDir

Deletes a named directory. This command deletes the specified directory and all of its contents. The directory must not be a read-only directory. Command only, no query form.

**Group** File system

**Syntax** FILESystem:RMDir <directory path>

**Arguments** <directory path> is a quoted string that defines the location and name of the directory to delete. If you do not specify a path to the folder, the instrument deletes the specified folder in the current working folder. The current folder refers to the name of a folder as returned by the FILESystem:CWD query.

---

**NOTE.** *A folder must be empty before you can delete it.*

---

**Examples** FILESYSTEM:RMDIR " USB0/OldDirectory" removes the directory named olddirectory from the root of the E drive.

## FILESystem:WRITEFile

Writes the specified block data to a file in the instrument current working directory. If the specified file does not exist or is not readable, an appropriate error event is posted. The maximum length of the block data is 262144 bytes. No query form.

**Group** File System

**Syntax** FILESystem:WRITEFile <file path>, <data>

**Related commands** [FILESystem:CWD](#) on page 135

**Arguments** <file path> is the quoted string that defines the file name and path. If the path is within the current working directory, specify the file name only.

<data> can be either DEFINITE LENGTH encoding or INDEFINITE LENGTH ARBITRARY BLOCK PROGRAM DATA encoding as described in IEEE488.2.



## FPAnel:PRESS

Simulates the action of pressing a specified front-panel button. No query form.

When the front panel is locked, the front-panel buttons and multipurpose knob operations are suspended. The FPAnel:PRESS and the FPAnel:TURN commands will also not work. You can work around this by using the appropriate programmatic interface commands, instead of the front-panel commands.

**Group** Miscellaneous

**Syntax** FPAnel:PRESS <button>

**Arguments** <button> is the name of a front-panel button. Most of the argument names associate directly with their front panel buttons. For example, AUTOSet is for the Autoset button. The <button> enumeration arguments and their associations with the front panel buttons are listed below.

Argument	Button
ACQuire	Acquire button
SAVE Recall	Save/Recall Menu button
MEASurement	Measure button
UTILity	Utility button
MATH	M button
REF	R button
FFT	F button
TRIGger	Trigger Menu button
FORCetrig	Force Trig button
CH1	Channel1 select button
CH2	Channel2 select button
CH3	Channel3 select button
CH4	Channel4 select button
DEFaultsetup	Default Setup button
COURse	Course button
FUNCTION	Function button
ZOOM	Zoom button
FINe	Fine button
CURsor	Cursors button
RUnstop	Run/Stop button
SINGleseq	Single button
AUTOset	Autoset button

Argument	Button
SETTO50	Trigger level knob can be pressed to Set Trigger to 50%
HARDcopy	Hardcopy button
SEARCH	To open the Search menu
NEXT	To move to the Next available MARK
PREV	To move to the Previous available MARK
MARK	To Set/Clear a MARK
RMENU1	Screen top-most side menu button
RMENU2	Screen side menu button
RMENU3	Screen side menu button
RMENU4	Screen side menu button
RMENU5	Screen side menu button
RMENU6	Screen side menu button
RMENU7	Screen bottom-most side menu button
MENUOff	Menu On/Off button
GPKNOB	Multipurpose knob can be pressed for selection.
HORZPos	Horizontal Position knob can be pressed to set horizontal position to center.
VERTPOS<n>	Vertical Position knob can be pressed to set vertical position to center.
VERTSCALE<n>	Vertical Scale knob can be pressed to set trigger source

**Examples**    FPANEL:PRESS AUTOSET executes the instrument Autoset function.

## FPAnel:TURN

Simulates the action of turning a specified front-panel control knob. No query form.

When the front panel is locked, the front-panel button and multipurpose knob operations are suspended. The FPAnel:PRESS and FPAnel:TURN commands will also not work, and they will not generate an error. You can work around this by using the appropriate programmatic interface commands, instead of the front-panel commands. For example, to set the trigger level to 50%, you could use TRIGger:A SETLevel. To force a trigger, you could use TRIGger FORCE.

**Group** Miscellaneous

**Syntax** FPAnel:TURN <knob>,[<n>]

**Arguments** <knob> is the name of a rotating control. A comma (,) separates the control knob argument from the numeric optional rotation value argument. In the absence of the numeric rotation value argument, the default is 1 (clockwise). You do not need a white space between the arguments and the comma. <n> represents the rotation direction and magnitude of rotation. Negative values represent a counterclockwise knob rotation, and positive values represent a clockwise rotation. The magnitude of <n> specifies the amount of the turn, where <n> = 1 represents turning the knob one unit, <n> = 2 represents turning the knob two units, <n> = 4 represents turning the knob four units, and so on. The range of units depends on which front panel knob is specified.

**Table 30: FPAnel:TURN arguments**

Argument	Knob
GPKNOB	Multipurpose knob
HORZPos	Horizontal Position knob
HORZScale	Horizontal Scale knob
TRIGLevel	Trigger Level knob
VERTPOS<n>	Vertical Position knob
VERTSCALE<n>	Vertical Scale knob

**Examples**    FPANEL:TURN TRIGLEVEL,10 duplicates turning the front panel Trigger Level knob clockwise by 10 units.

## FWUpdate:Update

Updates the oscilloscope firmware from a file on a USB flash drive. Before executing this command, make sure the USB flash drive is plugged into the instrument, and contains the firmware update file **TBS2000B.TEK** at the root (top) directory. If the update file is not in the root directory, the oscilloscope shows a warning message and the firmware is not updated.

**Group**        Miscellaneous

**Syntax**      FWUpdate:Update

---

## H commands

This section lists commands and queries that begin with the letter H.

### HDR

This command is identical to the HEADer query and is included for compatibility with other Tektronix scopes.

**Group** Miscellaneous

**Syntax** HDR  
HDR?

### HEADer

Sets and queries the Response Header Enable State that causes the to either include or omit headers on query responses. This command does not affect IEEE Std 488.2-1987 Common Commands (those starting with an asterisk); they never return headers.

**Group** Miscellaneous

**Syntax** HEADer  
HEADer?

**Arguments** ON or <NR1> ≠ 0 sets the Response Header Enable State to true. This causes the instrument to include header on applicable query responses. You can then use the query response as a command.

OFF or <NR1> = 0 sets the Response Header Enable State to false. This causes the instrument to omit headers on query responses so that only the argument is returned.

**Examples** HEADer OFF causes the instrument to omit headers from query responses.

HEADer? might return 1, showing that the Response Header Enable State is true. Query only.

## HELPevery:ACQuire

Enables or disables the display of Help Everywhere information for the acquire measurements.

**Group** Help everywhere

**Syntax** HELPevery:ACQuire {ON|OFF}  
HELPevery:ACQuire?

**Arguments** ON enables displaying Help Everywhere for the acquire measurements.  
OFF disables displaying Help Everywhere for the acquire measurements.

**Examples** HELPevery:ACQuire ON enables Help Everywhere for the acquire settings.

## HELPevery:ALL

Enables or disables the display of Help Everywhere information for all measurement settings (acquire, trigger, vertical, math, fft ,cursor, reference, measurement, and utility modules).

**Group** Help everywhere

**Syntax** HELPevery:ALL {ON|OFF}

**Arguments** ON enables Help Everywhere.  
OFF disables Help Everywhere.

**Examples** HELPevery:ALL ON enables Help Everywhere.

## HELPevery:CURsor

Enables or disables the display of Help Everywhere information for the cursor module.

**Group** Help everywhere

**Syntax** HELPevery:CURsor {ON|OFF}  
HELPevery:CURsor?

**Arguments** ON enables Help Everywhere for the cursor settings.  
OFF disables Help Everywhere for the cursor settings.

**Examples**    HELPevery:CURSor ON enables Help Everywhere for the cursor settings.

## HELPevery:FFT

Enables or disables the display of Help Everywhere information for the fft settings.

**Group**    Help everywhere

**Syntax**    HELPevery:FFT {ON|OFF}  
HELPevery:FFT?

**Arguments**    ON enables Help Everywhere for the FFT module.  
OFF disables Help Everywhere for the FFT module.

**Examples**    HELPevery:FFT ON enables Help Everywhere for the FFT module.

## HELPevery:MATH

Enables or disables the display of Help Everywhere information for the math module.

**Group**    Help everywhere

**Syntax**    HELPevery:MATH {ON|OFF}  
HELPevery:MATH?



**Arguments** ON enables Help Everywhere for the math module.  
OFF disables Help Everywhere for the math module..

**Examples** HELPevery:MATH ON enables Help Everywhere for the math module.

## HELPevery:MEASUrement

Enables or disables the display of Help Everywhere information for the measurement module.

**Group** Help everywhere

**Syntax** HELPevery:MEASUrement {ON|OFF}  
HELPevery:MEASUrement?

**Arguments** ON enables Help Everywhere for the measurement module.  
OFF disables Help Everywhere for the measurement module..

**Examples** HELPevery:MEASUrement ON enables Help Everywhere for the measurement module.

## HELPevery:REFeRence

Enables or disables the display of Help Everywhere information for the reference module.

**Group** Help everywhere

**Syntax** HELPevery:REFeRence {ON|OFF}  
HELPevery:REFeRence?

**Arguments** ON enables Help Everywhere for the reference module.  
OFF disables Help Everywhere for the reference module.

**Examples** HELPevery:REFeRence ON enables Help Everywhere for the reference module.

## HELPevery:SEARCh

Enables or disables the display of Help Everywhere information for the search module.

**Group** Help everywhere

**Syntax** HELPevery:SEARCh {ON | OFF}  
HELPevery:SEARCh?

**Arguments** ON enables displaying Help Everywhere for the search settings.  
OFF disables displaying Help Everywhere for the search settings.

**Examples** HELPevery:SEARCH ON enables Help Everywhere for the search settings.

## HELPevery:TRIGger

Enables or disables the display of Help Everywhere information for the trigger module.

**Group** Help everywhere

**Syntax** HELPevery:TRIGger {ON | OFF}  
HELPevery:TRIGger?

**Arguments** ON enables Help Everywhere for the trigger module.  
OFF disables Help Everywhere for the trigger module.

**Examples** HELPevery:TRIGger ON enables Help Everywhere for the trigger module.

## HELPevery:UTILITY

Enables or disables the display of Help Everywhere information for the utility module.

**Group** Help everywhere

**Syntax** HELPevery:UTILITY {ON|OFF}  
HELPevery:UTILITY?

**Arguments** ON enables Help Everywhere for the utility module.  
OFF disables Help Everywhere for the utility module.

**Examples** HELPevery:UTILITY ON enables Help Everywhere for the utility module.

## HELPevery:VERTical

Enables or disables the display of Help Everywhere information for the vertical module.

**Group** Help everywhere

**Syntax** HELPevery:VERTical {ON|OFF}  
HELPevery:VERTical?

**Arguments** ON enables Help Everywhere for the vertical module.  
OFF disables Help Everywhere for the vertical module.

**Examples** HELPevery:VERTical ON enables Help Everywhere for the vertical module.

## HORizontal?

Returns all settings for the horizontal commands. Query only.

The commands HORizontal:MAIn:SCAle, HORizontal:MAIn:SECdiv, HORizontal:SCAle, and HORizontal:SECdiv are equivalent, so HORizontal:MAIn:SCAle is the value that is returned. The commands HORizontal:MAIn:POSition and HORizontal:POSition are equivalent, so HORizontal:MAIn:POSition is the value that is returned.

**Group** Horizontal

**Syntax** HORizontal?

**Returns** Returns all horizontal settings.

**Examples** HORIZONTAL? might return the following horizontal settings :HORIZONTAL:POSITION 50.0000; SAMPLERATE 500.0000E+6; SCALE 200.0000E-9; RECORDLENGTH 2000; RECORDLENGTH : AUTO 0; DELAY:MODE 1; TIME 0.0E+0.

## HORizontal:ACQLENGTH

Queries the record length. Query only.

**Group** Horizontal

**Syntax** HORizontal:ACQLENGTH?

**Related commands** [HORizontal:RECOrdlength](#) on page 163

**Examples** HORIZONTAL:ACQLENGTH? might return 2.0000E+6 indicating that the record length is 2 million points.

## HORizontal:DIVisions

Returns the current horizontal divisions: 15.0000. Query only.

**Group** Horizontal

**Syntax** HORizontal:DIVisions?

**Examples** HORizontal:DIVisions? might return 15.

## HORizontal[:MAIn][:DELay]:POSition

Sets or queries the horizontal position. If Horizontal Delay Mode is turned off, this command is equivalent to adjusting the HORIZONTAL POSITION knob on the front panel. When Horizontal Delay Mode is on, this command stores a new horizontal position that is used when Horizontal Delay Mode is turned off.

**Group** Horizontal

**Syntax** HORizontal:MAIn:DELay:POSition <NR1>  
HORizontal:MAIn:DELay:POSition?  
HORizontal:MAIn:POSition <NR1>  
HORizontal:MAIn:POSition?  
HORizontal:DELay:POSition <NR1>  
HORizontal:DELay:POSition?  
HORizontal:POSition <NR1>  
HORizontal:POSition?

**Arguments** <NR1> is the horizontal position expressed as the percentage of the waveform displayed left of the center of the graticule.

**Examples** HORIZONTAL:DELay:POSITION 50 sets the horizontal position to 50%.  
HORIZONTAL:MAIn:DELay:POSITION? might return 100 indicating that the horizontal position is set to 100%.

## HORizontal:MAIn:DELAy:MODE

Sets or returns the horizontal delay mode.

**Group** Horizontal

**Syntax** HORizontal:MAIn:DELAy:MODE {OFF|ON|<NR1>}  
HORizontal:MAIn:DELAy:MODE?  
HORizontal:DELAy:MODE {OFF|ON|<NR1>}  
HORizontal:DELAy:MODE?

**Related Commands** [HORizontal\[:MAIn\]\[:DELAy\]:POSition](#) on page 157

**Arguments** OFF sets the Horizontal Delay Mode to off. This causes the HORizontal:POSition command to horizontally position the waveform.  
ON sets the Horizontal Delay Mode to on. This causes the HORizontal:DELAy:TIME command to horizontally position the waveform.  
<NR1> = 0 sets the Horizontal Delay Mode to off; any other value sets this mode to on.

**Examples** HORIZONTAL:DELAY:MODE OFF sets the Horizontal Delay Mode to off, allowing the HORizontal:POSition command to horizontally position the waveform.  
HORIZONTAL:MAIn:DELAy:MODE? might return OFF indicating that the HORizontal:POSition command horizontally positions the waveform.



## HORizontal:MAIn:DELAy:STATe

Sets or returns the horizontal delay state . The same as HORizontal[:MAIn]:DELAy:MODE.

**Group** Horizontal

**Syntax** HORizontal:MAIn:DELAy:STATe {OFF|ON|<NR1>}  
 HORizontal:MAIn:DELAy:STATe?  
 HORizontal:DELAy:STATe {OFF|ON|<NR1>}  
 HORizontal:DELAy:STATe?

**Related Commands** [HORizontal\[:MAIn\]\[:DELAy\]:POSition](#) on page 157

**Arguments** OFF sets the Horizontal Delay State to off. This causes the HORizontal:POSition command to horizontally position the waveform.  
 ON sets the Horizontal Delay State to on. This causes the command to horizontally position the waveform.  
 <NR1> = 0 sets the Horizontal Delay State to off; any other value sets this mode to on.

**Examples** HORIZONTAL:DELAY:STATE OFF sets the Horizontal Delay State to off, allowing the HORizontal:POSition command to horizontally position the waveform.  
 HORIZONTAL:MAIN:DELAY:STATE? might return OFF indicating that the HORizontal:POSition command horizontally positions the waveform.

## HORizontal[:MAIn]:DELay:TIME

Sets or queries the horizontal delay time. The amount of time the acquisition is delayed depends on sample rate and record length.

**Group** Horizontal

**Syntax** HORizontal:MAIn:DELay:TIME <NR3>  
HORizontal:MAIn:DELay:TIME?  
HORizontal:DELay:TIME <NR3>  
HORizontal:DELay:TIME?

**Arguments** <NR3> is the delay in seconds.

**Examples** HORizontal:DELay:TIME 0.3 sets the delay of acquisition data so that the resulting waveform is centered 300 ms after the trigger occurs.

## HORizontal[:MAIn]:SAMPLERate

Returns the current horizontal sample rate. Query only.

**Group** Horizontal

**Syntax** HORizontal:SAMPLERate?  
HORizontal [:MAIn] :SAMPLERate?

---

**Examples**    HORizontal:SAMPLERate? might return 2.0000E+9.

## HORizontal[:MAIn]:SCAlE

Sets or queries the time base horizontal scale. Query only.

**Group**    Horizontal

**Syntax**    HORizontal:SCAlE <NR3>  
HORizontal:SCAlE?  
HORizontal:MAIn:SCAlE <NR3>  
HORizontal:MAIn:SCAlE?

**Arguments**    <NR3> specifies the range from 1 (or 2) ns to 100 s, depending on the model.

**Returns**    All settings for the time base

**Examples**    HORizontal:MAIn:SCAlE 2E-6 sets the main scale to 2  $\mu$ s per division.  
HORizontal:MAIn:SCAlE? might return 2.0000E-06, indicating that the main scale is currently set to 2  $\mu$ s per division.

## HORizontal[:MAIn]:SECdiv

Sets the time per division for the main time base. This command is identical to the HORizontal:MAIn:SCALE command. It is provided to maintain program compatibility with some older models of Tektronix scopes.

**Group** Horizontal

**Syntax** HORizontal: SECdiv <NR3>  
HORizontal: SECdiv ?  
HORizontal:MAIn:SECdiv <NR3>  
HORizontal:MAIn:SECdiv?

**Arguments** <NR3> specifies the range from 1 (or 2) ns to 100 s, depending on the model.

**Examples** HORizontal:MAIn:SECdiv 2E-6 sets the main scale to 2  $\mu$ s per division.  
HORizontal:MAIn:SECdiv? might return 2.0000E-06 indicating that the main scale is currently set to 2  $\mu$ s per division.

## HORizontal:MAIn:UNIts[:STRing]

Returns the current horizontal unit "s". Query only.

**Group** Horizontal

**Syntax** HORizontal:MAIn:UNIts?  
HORizontal:MAIn:UNIts:STRing?

**Examples**    HORizontal:MAIn:UNIts? might return SECONDS.

## HORizontal:PREViewstate

Returns a boolean value to indicate whether the acquisition system is in the preview state. Query only.

**Group**    Horizontal

**Syntax**    HORizontal:PREViewstate?

**Returns**    <NR1> = 1 if the acquisition system is in the preview state.  
<NR1> = 0 if the acquisition system is not in the preview state.

**Examples**    HORizontal:PREViewstate? might return 1 indicating the acquisition system is in the preview state.

## HORizontal:RECOrdlength

Sets the horizontal record length of acquired waveforms. The query form of this command returns the current horizontal record length.

**Group**    Horizontal

**Syntax**    HORizontal:RECOrdlength <NR1>  
HORizontal:RECOrdlength?

**Arguments** <NR1> represents the supported values for horizontal record lengths, which are: 1000, 2000, 20000, 200000, 2000000, and 5000000.

**Examples** HORIZONTAL:RECORDLENGTH 2000 specifies that 2000 data points will be acquired for each record.

HORIZONTAL:RECORDLENGTH? might return 2000 indicating that the horizontal record length is equal to 2000 data points.

## HORizontal:RECOrdlength:Auto

Sets or queries the horizontal record length mode.

**Group** Horizontal

**Syntax** HORizontal:RECOrdlength:Auto <NR1>  
HORizontal:RECOrdlength:Auto?

**Arguments** <NR1> sets the record length mode. 1 enables auto record length mode, 0 disables auto record length mode.

**Examples** HORizontal:RECOrdlength:Auto 1 enables auto record length mode of the analog channels.

HORizontal:RECOrdlength:Auto? might return 0 indicating that auto record length mode of the analog channels is off.

## HORizontal:RESOLution

Sets or returns the horizontal record length of acquired waveforms. The sample rate is automatically adjusted at the same time to maintain a constant time per division. The query form of this command returns the current horizontal record length.

**Group** Horizontal

**Syntax** HORizontal:RESOLution <NR1>  
HORizontal:RESOLution?

**Arguments** <NR1> represents the supported values for horizontal record lengths.

**Examples** HORizontal:RESOLution 200000 set the record length to 200000 points.

## HORizontal:ROLL

Returns the current horizontal roll mode state: on/off. Query only.

**Group** Horizontal

**Syntax** HORizontal:ROLL?

**Examples** HORizontal:ROLL? might return HORizontal:ROLL ON indicating that roll mode is on.

## HORizontal:TRIGger:POSition

Sets or queries the horizontal position when delay mode is OFF. It is similar to HORizontal:POSition.

Sets the

**Group** Horizontal

**Syntax** HORizontal:TRIGger:POSition <NR3>  
HORizontal:TRIGger:POSition?

**Arguments** <NR3> is the horizontal position expressed as the percentage of the waveform displayed left of the center of the graticule.

**Examples** HORizontal:MAIn:POSition50 sets the horizontal position to 50%.  
HORizontal:MAIn:POSition? might return 100, indicating that the horizontal position is set to 100%.



# I commands

This section lists commands and queries that begin with the letter I.

## ID?

Returns identifying information about the instrument and its firmware in Tektronix Codes and Formats notation. Query only.

---

**NOTE.** *ID?* must be the last command when part of a concatenated statement. Otherwise the instrument generates event message 440.

---

The ID? and \*IDN? responses are slightly different.

**Group** Miscellaneous

**Syntax** ID?

**Returns** Returns the instrument identification in the following format for TBS2000B instruments:

ID TEK/<model number>,CF:91.1CT FV:v<instrument firmware version number>

**Examples** ID? might return the following response ID TEK/TBS2104,CF:91.1CT,FV:v2015-12-10\_01-00-59rootfs; FPGA:v1.21;

## \*IDN?

Returns the instrument identification code in IEEE 488.2 notation. Query only.

---

**NOTE.** *\*IDN? must be the last command when part of a concatenated statement. Otherwise the instrument generates event message 440.*

---

The \*IDN? and ID? responses are slightly different.

**Group**    Miscellaneous

**Syntax**    \*IDN?

**Returns**    Returns the instrument identification in the following format for TBS2000B instruments:  
TEKTRONIX,<model number>,CF:91.1CT FV:v<instrument firmware version number> TBS2XXXV:v<module firmware version number>

**Examples**    \*IDN? might return the following response for a TBS2104 instrument with the serial number CU10100: TEKTRONIX,TBS2104,CU10100,CF:91.1CT FV:v2015-12-10\_01-00-59rootfs; FPGA:v1.21;

---

## L commands

This section lists commands and queries that begin with the letter L.

### LANGuage

Sets or queries the languages that the instrument uses to display information on the screen. This is equivalent to setting the Language option in the Utility menu.

**Group** Miscellaneous

**Syntax** LANGuage  
LANGuage?

**Arguments** Specifies the language used to display instrument information on the screen.

**Examples** LANGuageFRENch specifies that the instrument displays information in French.  
LANGuage? might return SPANISH.

## LOCK

Enables and disables all front-panel buttons and knobs. There is no front-panel equivalent.

When the front panel is locked, neither the FPanel:PRESS nor the FPanel:TURN commands work. They will not generate an error event either. You can work around this by using the appropriate programmatic interface commands, instead of the front-panel commands. For example, to set the trigger level to 50%, you could use TRIGGER:A SETLevel. To force a trigger, you could use TRIGGER FORCE.

**Group** Miscellaneous

**Syntax** LOCK {ALL|NONE}  
LOCK?

**Related commands** [UNLOCK](#) on page 283

**Arguments** ALL disables all front-panel controls.  
NONE enables all front-panel controls. This is equivalent to the UNLOCK ALL command.

**Examples** LOCK ALL locks the front-panel controls.  
LOCK? might return :LOCK NONE indicating the front-panel controls are enabled by this command.

## \*LRN?

This is identical to the query. Query only.

Miscellaneous

**Group** Miscellaneous

**Syntax** \*LRN?

---

## M commands

This section lists commands and queries that begin with the letter M.

### MARK

Moves to the next or previous reference mark on the waveform. Returns the current mark position.

<b>Group</b>	Mark
<b>Syntax</b>	MARK {NEXT PREVIOUS} MARK?
<b>Arguments</b>	NEXT moves to the next reference mark on the right. PREVIOUS moves to the next reference mark on the left.
<b>Returns</b>	NEXT PREVIOUS
<b>Examples</b>	MARK NEXT sets the next reference mark on the right. MARK? might return PREVIOUS indicates that the next reference mark on the left.

## MARK:CREATE

Creates a mark on a specified waveform or all waveforms in a column. No query form.

**Group** Mark

**Syntax** MARK:CREATE {CH<x> | MATH | REF<x> | COLUMN }

**Arguments** CH<x> creates the mark on a channel waveform, where <x> is the channel number.  
MATH creates the mark on the math waveform.  
REF<x> creates the mark on a reference waveform, where <x> is the reference waveform number.  
COLUMN creates marks on all waveforms in the current zoom pixel column.

**Returns** NA

**Examples** MARK:CREATE CH1 creates the mark on a channel 1 waveform.

## MARK:DELEte

Deletes a mark on a particular waveform, all waveforms in a column, the selected mark, or all marks. No query form.

**Group** Mark

**Syntax** MARK:DELEte {CH<x> | MATH | REF<x> | COLUMN}

**Arguments** CH<x> deletes the mark on a channel waveform, where <x> is the channel number.  
MATH deletes the mark on the math waveform.  
REF<x> deletes the mark on a reference waveform, where <x> is the reference waveform number.  
COLUMN deletes marks on all waveforms in the current zoom pixel column.

**Returns** NA

**Examples** MARK:DELEte CH1 deletes the channel 1 mark waveform.

## MARK:FREE?

Returns how many marks are available for use. Query only.

**Group** Mark

**Syntax** MARK:FREE?

## MARK:SELEcted:END?

Returns the end of the selected mark, 0 to 100% of the waveform. Query only

**Group** Mark

**Syntax** MARK:SELEcted:END?

## MARK:SELEcted:FOCUS?

Returns the focus of the selected mark, 0 to 100% of the waveform. Query only.

**Group** Mark

**Syntax** MARK:SELEcted:FOCUS?



## MARK:SElected:MARKSINCOlumn?

Returns the number of marks in the current zoom pixel column. Query only.

**Group** Mark

**Syntax** MARK:SElected:MARKSINCOlumn?

## MARK:SElected:OWNer?

Returns the owner of the selected mark. Query only.

**Group** Mark

**Syntax** MARK:SElected:OWNer?

**Arguments** NA

**Returns** USER/SEARCH1

**Examples** MARK:SELECTED:OWNER? might return: USER, SEARCH1

## MARK:SElected:SOURCE?

Returns the source waveform for the selected mark. Query only.

**Group** Mark

**Syntax** MARK:SElected:SOURCE?

## MARK:SElected:START?

Returns the starting point of the selected mark, 0 to 100% of the waveform. Query only.

**Group** Mark

**Syntax** MARK:SElected:START?

## MARK:SElected:STATE?

Returns the on or off state of the selected mark. The selected mark is at or near the center of the screen. If you press the front-panel Set/Clear button, this mark will disappear. Query only.

**Group** Mark

**Syntax** MARK:SElected:STATE?

## MARK:SElected:ZOOM:POSition?

Returns the position of the selected mark, 0 to 100% of the zoom overview window. Query only.

**Group** Mark

**Syntax** MARK:SElected:ZOOM:POSition?

## MARK:TOTal?

Returns how many marks are currently in use. Query only.

**Group** Mark

**Syntax** MARK:TOTal?

## MATH?

Returns the current math parameters. Query only.

**Group** Math

**Syntax** MATH?

**Related commands** [MATH:DEFINE](#) on page 178, [MATH:VERTical:SCAle](#) on page 182, [MATH:VERTical:POSition](#) on page 182, [MATH:VERTical:UNIts](#) on page 183, [MATH:HORizontal:SCAle](#) on page 180, [MATH:HORizontal:POSition](#) on page 179, [MATH:HORizontal:UNIts](#) on page 180

**Returns** Returns the current math parameters:

- The definition of the math waveform:
- Source1 operation source2
- Vertical scale
- Vertical position
- Vertical units
- Horizontal scale
- Horizontal position
- Horizontal units

**Examples** MATH? might return “CH1+CH2”;2.000;0.0E+0”V”,20.0000E-6;0.0E0;”s”.

## MATH:DEFINE

Sets or returns the math waveform definition for the active math operation.

---

**NOTE.** Remember that <QString> must be enclosed in quotes. You can use white space characters between words.

---

**Group** Math

**Syntax** MATH:DEFINE <QString>  
MATH:DEFINE?

<b>Arguments</b>	<QString> specifies a math waveform, and can be one of the following, where CH3 and CH4 are only available on 4 channel instruments: CH1+CH2, CH1-CH2, CH2-CH1, CH3+CH4, CH3-CH4, CH4-CH3, CH1*CH2 CH3*CH4
<b>Examples</b>	MATH:DEFINE"CH1-CH2" sets the math waveform so that it displays the difference of channel 1 and channel 2. MATH:DEFine? Might return "CH1-CH2".

## MATH:HORizontal:POSition

Sets or queries the math horizontal display position for math waveforms. The horizontal position of a dual math waveform with a channel waveform source is set through the commands described in the horizontal section.

<b>Group</b>	Math
<b>Syntax</b>	MATH:HORizontal:POSition <NR2> MATH:HORizontal:POSition?
<b>Arguments</b>	<NR2> is the math horizontal position in percent of record.
<b>Examples</b>	MATH:HORizontal:POSition 20 sets the math horizontal position to 20% of the record. MATH:HORizontal:POSition? might return 20.000 indicating that the math horizontal position is at 20% of the record.

## MATH:HORizontal:SCALE

Sets or queries the math horizontal display scale for dual math waveforms that only have source waveforms. The horizontal scale of a dual math waveform with a channel source waveform is set through the HORizontal:SCALE command.

**Group** Math

**Syntax** MATH:HORizontal:SCALE <NR3>  
MATH:HORizontal:SCALE?

**Arguments** <NR3> is the math display scale.

**Examples** MATH:HORizontal:SCALE 20.000E-6 sets the math horizontal display scale to 20  $\mu$ s per division.  
MATH:HORizontal:SCALE? might return 20.000E-6 indicating the math horizontal display scale is 20  $\mu$ s per division.

## MATH:HORizontal:UNIts

Queries the math horizontal measurement units label.

**Group** Math

**Syntax** MATH:HORizontal:UNIts?

**Arguments** <Qstring> is a quoted string representing the math horizontal units.

**Examples** MATH:HORizontal:UNIts? might return "us" indicating the math horizontal units are  $\mu$ s.

## MATH:LABel

This command sets or queries the waveform label for the math waveform.

**Group** Math

**Syntax** MATH:LABel <Qstring>  
MATH:LABel?

**Arguments** <Qstring> is the quoted string used as the label for the math waveform.

**Examples** MATH:LABEL Output sets the label for the math waveform to "Output."  
MATH:LABEL? might return MATH:LABEL "Sum of channel 1 and channel 2" indicating the current label for the math waveform.

## MATH:VERTical:POSition

Sets or queries the math waveform display position.

**Group** Math

**Syntax** MATH:VERTical:POSition <NR3>  
MATH:VERTical:POSition?

**Arguments** <NR3> specifies the math vertical position in divisions from center screen.

**Examples** MATH:VERTical:POSition 4 sets the math vertical position to 4 divisions above center screen.  
MATH:VERTical:POSition? might return -3.000, indicating that the math waveform is 3 divisions below center screen.

## MATH:VERTical:SCALE

Sets or queries the vertical display scale, which should not be confused with the math waveform vertical scale returned in the math waveform pre-ambler (MATH?). The display scale is the same as that adjusted through the instrument vertical scale knob that controls waveform zoom factors. The math waveform scale is not affected by this control, rather the math calculation software automatically determines the optimum vertical scale through examination of input waveform data.

---

**NOTE.** *The vertical display scale is reset to the waveform pre-ambler scale whenever a vertical scale change to a math source waveform results in a new math autoscale operation. The vertical display scale should be changed only after math source waveform adjustments are complete.*

---



<b>Group</b>	Math
<b>Syntax</b>	MATH:VERTical:SCAle <NR3> MATH:VERTical:SCAle?
<b>Arguments</b>	<NR3> specifies the math vertical scale in units per division.
<b>Examples</b>	MATH:VERTical:SCAle5.0E0 sets the math vertical scale to five math waveform units per division. MATH:VERTical:SCAle? might return 5.000.

## MATH:VERTical:UNIts

Queries the math vertical measurement units.

<b>Group</b>	Math
<b>Syntax</b>	MATH:VERTical:UNIts?
<b>Examples</b>	MATH:VERTical:UNIts? might return "V".

## MEASUrement?

Returns the current MEASUrement settings. Query only.

**Group** Measurement

**Syntax** MEASUrement?

**Returns** Instrument measurement settings.

**Examples** MEASUrement? might return the following:

```
:MEASUREMENT:IMMED:DELAY:DIRECTION FORWARDS;EDGE1
RISE;EDGE2 RISE;:MEASUREMENT:IMMED:TYPE PERIOD;UNITS
"s";SOURCE1 CH1;SOURCE2
CH2;:MEASUREMENT:MEAS1:DELAY:DIRECTION FORWARDS;EDGE1
RISE;EDGE2 RISE;:MEASUREMENT:MEAS1:STATE 1;TYPE
FREQUENCY;UNITS "Hz";SOURCE1 CH1;SOURCE2 CH2;COUNT
0;MAXIMUM 0.0000;MEAN 0.0000;MINIMUM 0.0 000;STDDEV
0.0000;:MEASUREMENT:MEAS2:DELAY:DIRECTION
FORWARDS;EDGE1 RISE;EDGE2 RISE;:MEASUREMENT:MEAS2:STATE
1;TYPE PERIOD;UNITS "s";SOURCE1 CH1;SOURCE2 CH2;COUNT
0;MAXIMUM 0.0000;MEAN 0.0000;MINIMUM 0.0000;STDDEV
0.0000;:MEASUREMENT:MEAS3: DELAY:DIRECTION
FORWARDS;EDGE1 RISE;EDGE2 RISE;:MEASUREMENT:MEAS3:STATE
1;TYPE PK2PK;UNITS "V";SOURCE1 CH1;SOURCE2 CH2;COUNT
0;MAXIMUM 0.0000;MEAN 0.0000;MINIMUM 0.0000;STDDEV
0.0000;:MEASUREMENT:MEAS4:DELAY:DIRECTION
FORWARDS;EDGE1 RISE;EDGE2 RISE;:MEASUREMENT:MEAS4:STATE
0;TYPE PERIOD;UNITS "s";SOURCE1 CH1;SOURCE2 CH2;COUNT
0;MAXIMUM 0.0000;MEAN 0.0000;MINIMUM 0.0000;STDDEV
0.0000;:MEASUREMENT:METHOD AUTO;REFLEVEL:METHOD
PERCENT;ABSOLUTE:HIGH 0.0000;LOW 0.0000;MID1 0.0000;MID2
0.0000;:MEASUREMENT:REFLEVEL:PERCENT:HIGH 90.0000;LOW
10.0000;MID1 50.0000;MID2
50.0000;:MEASUREMENT:INDICATORS:STATE OFF;NUMHORZ
0;NUMVERT 0;HORZ1 99.0000E +36;HORZ2 99.0000E+36;HORZ3 99.0000E
+36;HORZ4 99.0000E+36;VERT1 99.0000E+36;VERT2 99.0000E+36;VERT3
99.0000E+36;VERT4 99.0000E+36;:MEASUREMENT:STATISTICS:MODE
OFF;WEIGHTING 32;:MEASUREMENT:GATING SCREEN.
```

## MEASUrement:CLEARSNapshot

Clears the existing measurement snapshot results and removes the snapshot window. Command only, no query form.

**Group** Measurement

**Syntax** MEASUrement:CLEARSNapshot

**Examples** MEASUrement:CLEARSNapshot clears the existing snapshot results and removes the snapshot window.

## MEASUrement:ENABLE

Allows educators to disable or enable the Measurement functions. The function can be manually set from the Utility menu. To access the menu, refer to the product user manual.

**Group** Miscellaneous

**Syntax** MEASUrement:ENABLE {ON|OFF}  
MEASUrement:ENABLE?

**Related Commands** [MEASUrement?](#) on page 184  
[FEAEN:PASSWORD](#) on page 128

**Arguments** ON enables the measurement feature.  
OFF disables the measurement feature.

**Examples** MEASUREMENT:ENABLE OFF disable measurement.  
MEASUREMENT:ENABLE? might return 1 indicating that measurements is enabled.

## MEASUREMENT:GATING

Sets or queries the measurement gating setting.

**Group** Measurement

**Syntax** MEASUREMENT:GATING {OFF|SCREEN|CURSOR}  
MEASUREMENT:GATING?

**Arguments** OFF turns off measurement gating (full record).  
SCREEN turns on gating, using the left and right edges of the screen.  
CURSOR limits measurements to the portion of the waveform between the vertical bar cursors, even if they are off screen.

**Examples** MEASUREMENT:GATING CURSOR turns on measurement gating using the cursors as limits.  
MEASUREMENT:GATING? might return :MEASUREMENT:GATING CURSOR indicating that measurements are limited to the portion of the waveform between the vertical bar cursors.

## MEASUrement:IMMed?

Returns all immediate measurement setup parameters. Immediate queries and commands are the preferred methods for programming. An immediate measurement selection is not visible or accessible through the display screen or front panel. Query only.

**Group** Measurement

**Syntax** MEASUrement:IMMed?

**Returns** Immediate measurement setup parameters

**Examples** MEASUrement:IMMed? might  
return :MEASUREMENT:IMMED:DELAY:DIRECTION  
FORWARDS;EDGE1 RISE;EDGE2 RISE;;MEASUREMENT:IMMED:TYPE  
PERIOD;UNITS "s";SOURCE1 CH1;SOURCE2 CH2.

## MEASUrement:IMMed:DELay?

Returns information about the immediate delay measurement. This command is equivalent to viewing the delay measurement settings on the measurement readout. Query only.

**Group** Measurement

**Syntax** MEASUrement:IMMed:DELay?

**Examples** MEASUREMENT:IMMED:DELAY? might  
return :MEASUREMENT:IMMED:DELAY:DIRECTION FORWARDS;  
EDGE1 RISE; EDGE2 RISE.

## MEASUREMENT:IMMED:DELAY:EDGE<x>

Sets or queries the slope of the edge the instrument uses for the delay from or to waveform when taking an immediate delay measurement.

**Group** Measurement

**Syntax** MEASUREMENT:IMMED:DELAY:EDGE<x> {FALL|RISe}  
MEASUREMENT:IMMED:DELAY:EDGE<x>?

**Arguments** <x> specifies which waveform to use, where <x> = 1 is the from waveform, and <x> = 2 is the to waveform.

FALL specifies the falling edge.

RISe specifies the rising edge.

**Examples** MEASUREMENT:IMMED:DELAY:EDGE1 RISE specifies that the from waveform rising edge be used for the immediate delay measurement.  
MEASUREMENT:IMMED:DELAY:EDGE1? returns either RISE or FALL.

## MEASUREMENT:IMMED:SOURCE1

Sets or queries the source for all single source immediate measurements and specifies the source to measure from when taking an immediate delay or phase measurement.

---

**NOTE.** *If you do not specify a numerical suffix, the source is assumed to be SOURCE 1.*

---

**Group** Measurement

**Syntax** MEASUREMENT:IMMED:SOURCE1 {CH<x> | MATH}  
MEASUREMENT:IMMED:SOURCE1?

**Related commands** [MEASUREMENT:IMMED:SOURCE2](#) on page 190

**Arguments** CH<x> specifies the measurement source channel as one of the input channels. The value of <x> can vary from 1 through 4 depending on instrument model.  
MATH specifies the measurement source channel as the math waveform.

**Examples** MEASUREMENT:IMMED:SOURCE1 CH1 specifies channel 1 as the immediate measurement source.  
MEASUREMENT:IMMED:SOURCE1? might return CH3 indicating that channel 3 is the immediate measurement source.

## MEASUrement:IMMed:SOUrce2

Sets or queries the secondary source for dual-source immediate measurements.

---

**NOTE.** *Source2 measurements only apply to phase and delay measurement types, which require both a target (Source1) and reference (Source2) source.*

---

**Group** Measurement

**Syntax** MEASUrement:IMMed:SOUrce2 {CH<x> | MATH}  
MEASUrement:IMMed:SOUrce2?

**Related commands** [MEASUrement:IMMed:SOUrce1](#) on page 189

**Arguments** CH<x> specifies the measurement source channel as one of the input channels. The value of <x> can vary from 1 through 4 depending on instrument model.  
MATH specifies the measurement source channel as the math waveform.

**Examples** MEASUrement:IMMed:SOUrce2 CH2 sets the immediate measurement source 2 to channel 2.  
MEASUrement:IMMed:SOUrce2? might return MATH indicating that Math is the immediate measurement source.



## MEASUREMENT:IMMED:TYPE

Sets or queries the immediate measurement type.

<b>Group</b>	Measurement
<b>Syntax</b>	<p>MEASUREMENT:IMMED:TYPE {AMPLITUDE AREa BURst CAREa CMEan CRMs DELay FALL FREQUENCY  HIGH LOW MAXimum MEAN MINimum NDUty NEDGECount NOVershoot  NPULSECount NWidth PEDGECount PDUty  PERIod PHAsE PK2Pk POVershoot PPULSECount PWidth RISe RMS}</p> <p>MEASUREMENT:IMMED:TYPE?</p>
<b>Arguments</b>	<p><b>AMPLitude</b> measures the amplitude of the selected waveform. It measures the high value less the low value measured over the entire waveform or gated region. Amplitude = High – Low</p> <p><b>AREa</b> measures the voltage over time. The area is over the entire waveform or gated region and is measured in volt-seconds. The area measured above the ground is positive, while the area below ground is negative.</p> <p><b>BURst</b> measures the duration of a burst. The measurement is made over the entire waveform or gated region.</p> <p><b>CAREa</b> (cycle area) measures the voltage over time. It measures, in volt-seconds, the area over the first cycle in the waveform or the first cycle in the gated region. The area measured above the common reference point is positive, while the area below the common reference point is negative.</p> <p><b>CMEan</b> (cycle mean) measures the arithmetic mean over the first cycle in the waveform or the first cycle in the gated region.</p> <p><b>CRMs</b> (cycle rms) measures the true Root Mean Square voltage over the first cycle in the waveform or the first cycle in the gated region.</p> <p><b>DELay</b> measures the time between the middle reference (default = 50%) amplitude point of the source waveform and the destination waveform.</p> <p><b>FALL</b> measures the time taken for the falling edge of the first pulse in the waveform or gated region to fall from a high reference value (default is 90%) to a low reference value (default is 10%).</p> <p><b>FREQUENCY</b> measures the first cycle in the waveform or gated region. Frequency is the reciprocal of the period and is measured in hertz (Hz), where 1 Hz = 1 cycle per second.</p> <p><b>HIGH</b> measures the High reference (100% level, sometimes called Topline) of a waveform.</p> <p><b>LOW</b> measures the Low reference (0% level, sometimes called Baseline) of a waveform.</p> <p><b>MAXimum</b> finds the maximum amplitude. This value is the most positive peak voltage found. It is measured over the entire waveform or gated region.</p>

MEAN amplitude measurement finds the arithmetic mean over the entire waveform or gated region.

MINimum finds the minimum amplitude. This value is typically the most negative peak voltage. It is measured over the entire waveform or gated region.

NDUty (negative duty cycle) is the ratio of the negative pulse width to the signal period, expressed as a percentage. The duty cycle is measured on the first cycle in the waveform or gated region.  $\text{Negative Duty Cycle} = ((\text{Negative Width}) / \text{Period}) \times 100\%$

NEDGECount is the count of falling edges.

NOVershoot (negative overshoot) finds the negative overshoot value over the entire waveform or gated region.  $\text{Negative Overshoot} = ((\text{Low} - \text{Minimum}) / \text{Amplitude}) \times 100\%$

NPULSECount is the count of negative pulses.

NWidth (negative width) measurement is the distance (time) between the middle reference (default = 50%) amplitude points of a negative pulse.

PDUty (positive duty cycle) is the ratio of the positive pulse width to the signal period, expressed as a percentage. It is measured on the first cycle in the waveform or gated region.  $\text{Positive Duty Cycle} = ((\text{Positive Width} / \text{Period}) \times 100\%$

PEDGECount is the count of rising edges.

PERIOD is the time required to complete the first cycle in a waveform or gated region. Period is the reciprocal of frequency and is measured in seconds.

PHase measures the phase difference (amount of time a waveform leads or lags the reference waveform) between two waveforms. The measurement is made between the middle reference points of the two waveforms and is expressed in degrees, where  $360^\circ$  represents one waveform cycle.

PK2Pk (peak-to-peak) finds the absolute difference between the maximum and minimum amplitude in the entire waveform or gated region.

POVershoot is the positive overshoot value over the entire waveform or gated region.  $\text{Positive Overshoot} = ((\text{Maximum} - \text{High}) / \text{Amplitude}) \times 100\%$

PPULSECount is the count of positive pulses.

PWidth (positive width) is the distance (time) between the middle reference (default = 50%) amplitude points of a positive pulse. The measurement is made on the first pulse in the waveform or gated region.

RISe timing measurement finds the rise time of the waveform. The rise time is the time it takes for the leading edge of the first pulse encountered to rise from a low reference value (default is 10%) to a high reference value (default is 90%).

RMS amplitude measurement finds the true Root Mean Square voltage in the entire waveform.

- Examples** MEASUrement:IMMed:TYPe FREQUENCY defines the immediate measurement to be a frequency measurement.
- MEASUREMENT:IMMED:TYPE? might return RMS indicating that the immediate measurement is the true Root Mean Square voltage.

## MEASUrement:IMMed:UNIts?

Returns the units for the immediate instrument measurement. Query only.

- Group** Measurement
- Syntax** MEASUrement:IMMed:UNIts?
- Returns** <QString> where the string is one of the following: VOLTS, VOLTS SQUARED, SEC, HERTZ, PERCENT, DIVS, SAMPLES, OHMS, AMPS, WATTS, MINUTES, DEGREES, UNKNOWN, AMPS SQUARED, HOURS, DAYS, DB, BYTES, INVERSE HERTZ, IRE, V OVER V, V OVER A, VOLTS WATTS, V OVER W, VOLTS DB, V OVER DB, A OVER V, A OVER A, AMPS WATTS, A OVER W, AMPS DB, A OVER DB, WATTS VOLTS, W OVER V, WATTS AMPS, W OVER A, WATTS SQUARED, W OVER W, WATTS DB, W OVER DB, DB VOLTS, DB OVER V, DB AMPS, DB OVER A, DB WATTS, DB OVER W, DB SQUARED, DB OVER DB, VOLTS SEC, AMPS SEC, WATTS SEC, V OVER S, A OVER S, W OVER S.
- Examples** MEASUrement:IMMed:UNIts? might return :MEASUREMENT:IMMED:UNIts "s", indicating that the unit for the immediate measurement is seconds.

## MEASUrement:IMMed:VALue?

Returns the value of the measurement specified by the MEASUrement:IMMed:TYPe command. The measurement is immediately taken on the source(s) specified by a MEASUrement:IMMed:SOURce1 command. Query only.

---

**NOTE.** *A change to HORizontal:MAIn:SCALe or CH<x>:SCALe will not necessarily have taken affect if immediately followed by this command.*

---

**Group** Measurement

**Syntax** MEASUrement:IMMed:VALue?

**Related Commands** [MEASUrement:IMMed:TYPe](#) on page 191,  
[\\*ESR?](#) on page 115, [EVENT?](#) on page 123

**Returns** <NR3>

**Examples** MEASUrement:IMMed:VALue? might return 28.75E6 if you are measuring the frequency of a 28.75 MHz signal.

MEASUrement:IMMed:VALue? might return 9.9000E+37. If the measurement has an error or warning associated with it, then an item is added to the error queue. The error can be checked for with the \*ESR? and ALLEv? commands..

## MEASUrement:MEAS<x>?

Returns all measurement parameters for the displayed instrument periodic measurement specified by <x>. Where <x> identifies the measurement, 1 through 6 depending on instrument model. Query only.

**Group** Measurement

**Syntax** MEASUrement:MEAS<x>?

**Returns** Settings for the specified measurement source.

**Examples** MEASUREMENT:MEAS3? might return PERIOD;"s";CH1

## MEASUrement:MEAS<x>:DELay?

Returns the delay measurement parameters for the measurement specified by <x>, which ranges from 1 through 6. Query only.

**Group** Measurement

**Syntax** MEASUrement:MEAS<x>:DELay?

**Examples** MEASUrement:MEAS1:DELay? might return :MEASUREMENT:MEAS1:DELAY:DIRECTION FORWARDS;EDGE1 RISE;EDGE2 RISE.

## MEASUrement:MEAS<x>:DELay:EDGE<x>

Sets or queries the slope of the edge used for the delay from or to waveform when taking an immediate delay measurement. The waveform is specified by MEASUrement:MEAS<x>:SOURCE[1].

**Group** Measurement

**Syntax** MEASUrement:MEAS<x>:DELay:EDGE<x> {FALL|RISe}  
MEASUrement:MEAS<x>:DELay:EDGE<x>?

**Arguments** <x> specifies which waveform to use, where <x> = 1 is the "from" waveform, and <x> = 2 is the "to" waveform.  
FALL specifies the falling edge.  
RISe specifies the rising edge.

**Examples** MEASUREMENT:MEAS1:DELAY:EDGE1 RISE specifies that the "from" waveform rising edge be used for the immediate delay measurement.  
MEASUREMENT:MEAS1:DELAY:EDGE1? returns either RISE or FALL

## MEASUrement:MEAS<x>:SOURce1

Sets or queries the source for all single source measurements and specifies the source to measure from when taking a delay measurement or phase measurement.

Where <x> identifies the measurement, 1 through 6. This is equivalent to selecting the measurement source in the MEASURE menu.

<b>Group</b>	Measurement
<b>Syntax</b>	MEASUrement:MEAS<x>:SOUrce1 {CH<x> MATH} MEASUrement:MEAS<x>:SOUrce1?
<b>Arguments</b>	CH<x> specifies the input channel source for the measurement. MATH specifies the measurement source channel as the math waveform.
<b>Examples</b>	MEASUREMENT:MEAS2:SOURC1 CH1 sets source1 for Measurement 2 to channel 1. MEASUrement:MEAS1:SOUrce1? might return MATH indicating the source for measurement 1 is the math waveform.

## MEASUrement:MEAS<x>:SOUrce2

For SOURc1: Sets or queries the source for all single channel measurements.  
For delay or phase measurements, sets or queries the waveform to measure from.  
For SOURc2: Sets or queries the waveform to measure to when taking a delay measurement or phase measurement (two-source waveforms measurements).

<b>Group</b>	Measurement
<b>Syntax</b>	MEASUrement:MEAS<x>:SOUrce2 {CH<x> MATH} MEASUrement:MEAS<x>:SOUrce2?

**Related commands**    [MEASUrement:MEAS<x>:TYPE](#) on page 199

**Arguments**    CH<x> specifies the input channel source for the measurement, where x is the channel number.

MATH specifies the measurement source channel as the math waveform.

**Examples**    MEASUrement:MEAS1:SOUrce2 CH1 sets source2 for Measurement 2 to channel 1.

MEASUrement:MEAS1:SOUrce2? might return MATH indicating the to source for measurement 1 is the math waveform.

## MEASUrement:MEAS<x>:STATE

Sets or queries whether the specified measurement slot is computed and displayed. The measurement slot is specified by <x>, which ranges from 1 through 6. For a measurement to display, you must have selected a source waveform and defined the measurement you want to take and display. You select the measurement using the MEASUrement:MEAS<x>:SOURCE[1] command. You define the measurement type using the MEASUrement:MEAS<x>:TYPE command.

**Group**    Measurement

**Syntax**    MEASUrement:MEAS<x>:STATE {OFF|ON|<NR1>}  
MEASUrement:MEAS<x>:STATE?

**Related commands**    [MEASUrement:MEAS<x>:TYPE](#) on page 199

[MEASUrement:MEAS<x>:SOUrce1](#) on page 196



<b>Arguments</b>	<p>OFF disables calculation and display of the specified measurement slot.</p> <p>ON enables calculation and display of the specified measurement slot.</p> <p>&lt;NR1&gt; = 0 disables calculation and display of the specified measurement slot; any other value enables calculation and display of the specified measurement slot.</p>
<b>Examples</b>	<p>MEASUrement:MEAS2:STATE ON computes and displays the measurement defined as measurement 2.</p> <p>MEASUrement:MEAS1:STATE? might return :MEASUREMENT:MEAS1:STATE 0 indicating that measurement defined for measurement slot 1 is disabled.</p>

## MEASUrement:MEAS<x>:TYPE

Sets or queries the on-screen periodic instrument measurement type for the measurement specified by <x>. Where <x> identifies the measurement, 1 through 6 depending on instrument model.

This is equivalent to selecting the measurement type in the MEASURE menu. Setting the type to anything other than NONE displays the MEASURE menu on the screen.

---

**NOTE.** You should use the MEASUrement:IMMed command with programming to take measurements, as this is preferred to the MEASUrement:MEAS<x> command.

---

<b>Group</b>	Measurement
<b>Syntax</b>	<p>MEASUrement:MEAS&lt;x&gt;:TYPE {AMPLitude   AREa   BURst   CAREa   CMean   CRM s   DELay   FALL   FREQuency   HIGH   LOW   MAXimum   MEAN   MINImum   NDUty   NEDGECount   NOVershoot   NPULSECount NWIdth   PDUty   PEDGECCount   PERIod   PHAse   PK2Pk   POVershoot   PPULSECount   PWIdth   RISE   RMS}</p> <p>MEASUrement:MEAS&lt;x&gt;:TYPE?</p>

**Arguments**

AMplitude is the high value less the low value measured over the entire waveform or gated region.

Amplitude = High – Low.

AREA is a voltage over time measurement. It returns the area over the entire waveform or gated region in volt-seconds. Area measured above ground is positive. Area measured below ground is negative.

BURst measures the duration of a burst. The measurement is made over the entire waveform or gated region.

CAREA (cycle area) is a voltage over time measurement. The measurement is the area over the first cycle in the waveform or the first cycle in the gated region expressed in volt-seconds. The area above the common reference point is positive. The area below the common reference point is negative.

CMEAN (cycle mean) is the arithmetic mean over the first cycle in the waveform or the first cycle in the gated region.

CRMs is the true Root Mean Square voltage of the first complete cycle in the waveform.

DELay measures the time between the middle reference (default = 50%) amplitude point of the source waveform and the destination waveform.

FALL is the fall time between 90% and 10% (defaults) of the first falling edge of the waveform or gated region. Falling edge must be displayed to measure. The instrument automatically calculates the 10% and 90% measurement points.

FREQuency measures the first cycle in the waveform or gated region. Frequency is the reciprocal of the period and is measured in hertz (Hz), where 1 Hz = 1 cycle per second.

HIGH is the value used as 100% whenever high reference, mid reference, or low reference values are needed, such as in fall time or rise time measurements. Calculate using either the min-max or histogram method. The min-max method uses the maximum value found. The histogram method uses the most common value found above the midpoint. This value is measured over the entire waveform or gated region.

LOW is the value used as 0% whenever high reference, mid reference, or low reference values are needed, such as in fall time or rise time measurements. Calculate using either the min-max or histogram method. The min-max method uses the minimum value found. The histogram method uses the most common value found below the midpoint. This value is measured over the entire waveform or gated region.

MAXImum finds the maximum amplitude. This value is the most positive peak voltage found. It is measured over the entire waveform or gated region.

MEAN is the arithmetic mean over the entire waveform or gated region.

MINImum finds the minimum amplitude. This value is typically the most negative peak voltage. It is measured over the entire waveform or gated region.

NDUty is the ratio of the negative pulse width to the signal period expressed as a percentage. The duty cycle is measured on the first cycle in the waveform or gated region.

Negative Duty Cycle = ((Negative Width) / Period) × 100%

NEDGECount is the number of negative transitions from the high reference value to the low reference value in the waveform or gated region.

NOVERshoot is measured over the entire waveform or gated region and is expressed as:

$$\text{Negative Overshoot} = (\text{Low} - \text{Minimum}) / \text{Amplitude} * 100\%$$

NPULSECount is the number of negative pulses that fall below the mid reference crossing in the waveform or gated region.

NWidth (negative width) measurement is the distance (time) between the middle reference (default = 50%) amplitude points of a negative pulse.

PDuty (positive duty cycle) is the ratio of the pulse width to the signal period, expressed as a percentage. It is measured on the first cycle in the waveform or gated region.

$$\text{Positive Duty Cycle} = ((\text{Positive Width}) / \text{Period}) \times 100\%$$

PEDGECount is the number of positive transitions from the low reference value to the high reference value in the waveform or gated region.

PERiod is the duration, in seconds, of the first complete cycle in the waveform or gated region. Period is the reciprocal of frequency and is measured in seconds.

PHase measures the phase difference (amount of time a waveform leads or lags the reference waveform) between two waveforms. The measurement is made between the middle reference points of the two waveforms and is expressed in degrees, where 360° represents one waveform cycle.

PK2pk (peak-to-peak) finds the absolute difference between the maximum and minimum amplitude in the entire waveform or gated region.

POVERshoot is the positive overshoot value over the entire waveform or gated region. The measurement is expressed as:

$$\text{Positive Overshoot} = (\text{Maximum} - \text{High}) / \text{Amplitude} * 100\%$$

PPULSECount is the number of positive pulses that rise above the mid reference crossing in the waveform or gated region.

PWidth (positive width) is the distance (time) between the first rising edge and the next falling edge at the waveform 50% level (default). Rising and falling edges must be displayed to measure. The measurement is made on the first pulse in the waveform or gated region. The instrument automatically calculates the 50% measurement point.

RISe is the rise time between 10% and 90% of the first rising edge of the waveform or gated region. Rising edge must be displayed to measure. The instrument automatically calculates the 10% and 90% measurement points.

RMS amplitude measurement finds the true Root Mean Square voltage in the entire waveform or gated region.

**Examples** MEASUREMENT:MEAS2:TYPE FREQUENCY specifies MEAS2 to measure the frequency of a waveform.  
MEASUREMENT:MEAS2:TYPE? might return :MEASUREMENT:MEAS1:TYPE RMS indicating that measurement 1 is defined to measure the RMS value of a waveform.

## MEASUrement:MEAS<x>:UNIts?

Returns the units for the instrument measurement specified by MEASUrement:MEAS<x>:TYPe. Where <x> identifies the measurement, 1 through 6. Query only.

**Group** Measurement

**Syntax** MEASUrement:MEAS<x>:UNIts?

**Related commands** [MEASUrement:MEAS<x>:TYPe](#) on page 199,  
[MEASUrement:IMMed:UNIts?](#) on page 193

**Returns** <QString> returns the units for the measurement.

**Examples** MEASUREMENT:MEAS3:UNITS? might return :MEASUREMENT:MEAS1:UNIts % indicating units for measurement 1 are set to percent.

## MEASUrement:MEAS<x>:VALue?

Returns the value that was calculated for the instrument on-screen periodic measurement specified by <x>. Where <x> identifies the measurement, 1 through 6. Query only.

This is the same value as displayed on-screen. If measurement statistics are enabled, a new value is calculated with every waveform. In addition, this value is updated approximately every 1/3 second. If you are acquiring a long acquisition record, the instrument may take longer to update.

**Group** Measurement

**Syntax** MEASUrement:MEAS<x>:VALue?

**Related commands** [MEASUrement:MEAS<x>:UNIts?](#) on page 202  
[\\*ESR?](#) on page 115  
[ALLEv?](#) on page 52

**Returns** <NR3> is the measurement value.

**Examples** MEASUREMENT:MEAS3:VALUE? might return 28.75E6 if measurement number three is frequency. If the measurement has an error or warning associated with it, then an item is added to the error queue. The error can be checked for with the \*ESR? and ALLEv? commands.

## MEASUrement:REFLevel?

Returns the current reference level parameters. Query only.

---

**NOTE.** *This command affects the associated reference level parameter for all MEASurements:IMMed and the four periodic measurements.*

---

**Group** Measurement

**Syntax** MEASUrement:REFLevel?

**Example** MEASUREMENT:REFLEVEL? might return these reference level settings  
PERCENT;ABSOLUTE:HIGH 0.0000;LOW 0.0000;MID1 0.0000;MID2  
0.0000;:MEASUREMENT:REFLEVEL:PERCENT:HIGH 90.0000;LOW  
10.0000;MID1 50.0000; MID2 50.0000

## MEASUrement:REFLevel:ABSolute:LOW

Sets or returns the low reference level, and is the lower reference level when MEASUrement:REFLevel:METHOD is set to Absolute.

---

**NOTE.** *This command affects the associated reference level parameter for all MEASurements:IMMed and the four periodic measurements.*

---

**Group** Measurement

**Syntax** MEASUrement:REFLevel:ABSolute:LOW <NR3>  
MEASUrement:REFLevel:ABSolute:LOW?

**Related commands** [MEASUrement:REFLevel:METHOD](#) on page 207  
[MEASUrement:IMMed:TYPE](#) on page 191  
[MEASUrement:MEAS<x>:TYPE](#) on page 199

**Arguments** <NR3> is the low reference level, in volts. The default is 0.0 V.

**Example** MEASUREMENT:REFLEVEL? might return these reference level settings:  
 MEASUREMENT:REFLEVEL:METHOD  
 PERCENT;ABSOLUTE:HIGH 0.0000;LOW 0.0000;MID1 0.0000;MID2 0.0000;  
 MEASUREMENT:REFLEVEL:PERCENT:HIGH 90.0000;LOW 10.0000;MID1 50.0000; MID2 50.0000

## MEASUrement:REFLevel:ABSolute:MID1

Sets or returns the mid reference level, and is the 50% reference level when MEASUrement:REFLevel:METHOD is set to Absolute. This command affects the results of period, frequency, delay, and all cyclic measurements.

---

**NOTE.** *This command affects the associated reference level parameter for all MEASurements:IMMed and the four periodic measurements.*

---

**Group** Measurement

**Syntax** MEASUrement:REFLevel:ABSolute:MID[1] <NR3>  
 MEASUrement:REFLevel:ABSolute:MID[1]?

**Related commands** [MEASUrement:REFLevel:METHOD](#) on page 207

**Arguments** <NR3> is the mid reference level, in volts. The default is 0.0 V.

**Example** MEASUREMENT:REFLEVEL:ABSOLUTE:MID 1.71 sets the mid reference level to 0.71 V.

MEASUREMENT:REFLEVEL:ABSOLUTE:MID? might return 0.7100E+00 indicating that the absolute mid1 reference level is set to 0.71 V.

## MEASUREMENT:REFLEVEL:ABSOLUTE:MID2

Sets or returns the mid reference level for the ""to"" waveform when taking a delay measurement, and is the 50% reference level when MEASUREMENT:REFLEVEL:METHOD is set to Absolute. This command affects the results of delay measurements.

---

**NOTE.** *This command affects the associated reference level parameter for all MEASUREMENTS:IMMED and the four periodic measurements.*

---

**Group** Measurement

**Syntax** MEASUREMENT:REFLEVEL:ABSOLUTE:MID2 <NR3>  
MEASUREMENT:REFLEVEL:ABSOLUTE:MID2?

**Related commands** [MEASUREMENT:REFLEVEL:METHOD](#) on page 207

**Arguments** <NR3> is the mid reference level, in volts. The default is 0.0 V.

**Example** MEASUREMENT:REFLEVEL:ABSOLUTE:MID2 0.5 sets the mid reference level for the delay waveform to 0.5 V.

MEASUREMENT:REFLEVEL:ABSOLUTE:MID2? might return 0.5000E+00 indicating that the absolute mid2 reference level is set to 0.5 V.



## MEASUrement:REFLevel:METHOD

Sets or returns the reference level units used for measurement calculations.

---

**NOTE.** *This command affects the associated reference level parameter for all MEASurements:IMMed and the eight periodic measurements. To change the parameter for individual measurements, use the MEASUrement:MEAS<x>:REFLevel commands.*

---

<b>Group</b>	Measurement
<b>Syntax</b>	MEASUrement:REFLevel:METHOD {ABSolute   PERCent} MEASUrement:REFLevel:METHOD?
<b>Arguments</b>	<p>ABSolute specifies that the reference levels are set explicitly using this commands. This method is useful when precise values are required (for example, when designing to published interface specifications, such as RS-232-C).</p> <p>PERCent specifies that the reference levels are calculated as a percent relative to HIGH and LOW. The percentages are defined using this commands.</p>
<b>Example</b>	<p>MEASUREMENT:REFLEVEL:METHOD ABSOLUTE specifies that explicit user-defined values are used for the reference levels.</p> <p>MEASUREMENT:REFLEVEL:METHOD? might return PERCENT indicating that the reference level units used are calculated as a percent relative to HIGH and LOW.</p>

## MEASUrement:REFLevel:PERCent:HIGH

Sets or returns the percent (where 100% is equal to HIGH) used to calculate the high reference level when MEASUrement:REFLevel:METhod is set to Percent. This command affects the results of rise and fall measurements.

---

**NOTE.** *This command affects the associated reference level parameter for all MEASUrements:IMMed and the four periodic measurements.*

---

**Group** Measurement

**Syntax** MEASUrement:REFLevel:PERCent:HIGH <NR3>  
MEASUrement:REFLevel:PERCent:HIGH?

**Related commands** [MEASUrement:REFLevel:METhod](#) on page 207  
[MEASUrement:IMMed:TYPe](#) on page 191  
[MEASUrement:MEAS<x>:TYPe](#) on page 199

**Arguments** <NR3> is the high reference level, ranging from 0 to 100%. The default high reference level is 90%.

**Example** MEASUrement:REFLevel:PERCent:HIGH 95 sets the high reference level to 95% of HIGH.  
MEASUrement:REFLevel:PERCent:HIGH? might return 90 indicating that the percentage high reference level is set to 90% of HIGH.

## MEASUrement:REFLevel:PERCent:LOW

Sets or returns the percent (where 100% is equal to HIGH) used to calculate the low reference level when MEASUrement:REFLevel:METHOD is set to Percent. This command affects the results of rise and fall measurements.

---

**NOTE.** *This command affects the associated reference level parameter for all MEASurements:IMMed and the four periodic measurements.*

---

**Group** Measurement

**Syntax** MEASUrement:REFLevel:PERCent:LOW <NR3>  
MEASUrement:REFLevel:PERCent:LOW?

**Related commands** [MEASUrement:REFLevel:METHOD](#) on page 207  
[MEASUrement:IMMed:TYPE](#) on page 191  
[MEASUrement:MEAS<x>:TYPE](#) on page 199

**Arguments** <NR3> is the low reference level, ranging from 0 to 100%. The default low reference level is 10%.

**Example** MEASUrement:REFLevel:PERCent:LOW 15 sets the high reference level to 15% of HIGH.  
MEASUrement:REFLevel:PERCent:LOW? might return 10 indicating that the percentage high reference level is set to 10% of HIGH.

## MEASUrement:REFLevel:PERCent:MID1

Sets or returns the percent (where 100% is equal to HIGH) that is used to calculate the mid reference level when MEASUrement:REFLevel:METHOD is set to Percent. This command affects the results of period, frequency, delay, and all cyclic measurements.

---

**NOTE.** *This command affects the associated reference level parameter for all MEASurements:IMMed and the four periodic measurements.*

---

**Group** Measurement

**Syntax** MEASUrement:REFLevel:PERCent:MID[1] <NR3>  
MEASUrement:REFLevel:PERCent:MID[1]?

**Related commands** [MEASUrement:REFLevel:METHOD](#) on page 207

**Arguments** <NR3> is the mid reference level, ranging from 0 to 100%. The default mid reference level is 50%.

**Example** MEASUrement:REFLevel:PERCent:MID[1] 60 sets the mid reference level to 60% of HIGH.  
MEASUrement:REFLevel:PERCent:MID[1]? might return 65 indicating that the percentage mid reference level is set to 65% of HIGH.

## MEASUrement:REFLevel:PERCent:MID2

Sets or returns the percent (where 100% is equal to HIGH) that is used to calculate the mid reference level for the second waveform specified when MEASUrement:REFLevel:METHOD is set to Percent. This command affects the results of delay measurements.

---

**NOTE.** *This command affects the associated reference level parameter for all MEASurements:IMMed and the four periodic measurements.*

---

**Group** Measurement

**Syntax** MEASUrement:REFLevel:PERCent:MID2 <NR3>  
MEASUrement:REFLevel:PERCent:MID2?

**Related commands** [MEASUrement:REFLevel:METHOD](#) on page 207

**Arguments** <NR3> is the mid reference level, ranging from 0 to 100%. The default mid reference level is 50%.

**Example** MEASUrement:REFLevel:PERCent:MID2 40 sets the mid reference level to 40% of HIGH.  
MEASUrement:REFLevel:PERCent:MID2? might return 45 indicating that the percentage mid reference level is set to 45% of HIGH.

## MEASUrement:SNAPSHOT

Displays the measurement snapshot list on the instrument screen. Command only, no query form.

**Group** Measurement

**Syntax** MEASUrement:SNAPSHOT

## MEASUrement:SOURCESNAPShot

Sets or returns the snapshot source.

**Group** Measurement

**Syntax** MEASUrement:SOURCESNAPShot {CH1|CH2|CH3|CH4|MATH}  
MEASUrement:SOURCESNAPShot?

**Examples** MEASUrement:SOURCESNAPShot CH1 sets the snapshot source to channel 1.  
MEASUrement:SOURCESNAPShot? might return CH1 indicating the snapshot source is channel 1.

---

## O commands

This section lists commands and queries that begin with the letter O.

### \*OPC

Generates the operation complete message in the Standard Event Status Register (SESR) when all pending commands that generate an OPC message are complete. The \*OPC? query places the ASCII character "1" into the output queue when all such OPC commands are complete. The \*OPC? response is not available to read until all pending operations finish.

The \*OPC command allows you to synchronize the operation of the instrument with your application program. See [Synchronization Methods](#) on page 322.

Certain instrument operations can affect the \*OPC response. See [Table 34: Instrument operations that can generate OPC](#) on page 322.

**Group** Status and Error

**Syntax** \*OPC  
\*OPC?

**Related Commands** [BUSY?](#) on page 55, [\\*WAI](#) on page 287

**Examples** \*OPC generates the operation complete message in the SESR at the completion of all pending OPC operations.  
\*OPC? might return 1 to indicate that all pending OPC operations are finished.





---

# P commands

This section lists commands and queries that begin with the letter P.

## \*PSC

Sets or queries the power-on status flag that controls the automatic power-on handling of the DESER, SRER, and ESER registers. When \*PSC is true, the DESER register is set to 255 and the SRER and ESER registers are set to 0 at power on. When \*PSC is false, the current values in the DESER, SRER, and ESER registers are preserved in nonvolatile memory when power is shut off and are restored at power on. Refer to the Status and Events section for more information. Command only, no query form.

**Group** Status and Error

**Syntax** \*PSC {OFF|ON|NR1>}

**Related Commands** [DESE](#) on page 102, [\\*ESE](#) on page 114, [FACTory](#) on page 127, [\\*RST](#) on page 224, [\\*SRE](#) on page 256

**Arguments** OFF sets the power-on status clear flag to false.  
ON sets the power-on status clear flag to true.  
<NR1> = 0 sets the power-on status clear flag to false, disables the power on clear, and allows the instrument to possibly assert SRQ after power on.  
<NR1> ≠ 0 sets the power-on status clear flag true. Sending \*PSC 1, therefore, enables the power-on status clear and prevents any SRQ assertion after power on.

**Examples** \*PSC0 sets the power-on status clear flag to false.  
\*PSC? might return the value 1, showing that the power-on status clear flag is set to true.



---

# R commands

This section lists commands and queries that begin with the letter R.

## \*RCL

Restores the state of the instrument from a copy of its settings stored in memory. (The settings are stored using the \*SAV command.) This command is equivalent to RECALL:SETUp, and performs the same function as the Recall Saved Setup item in the front-panel Save/Recall Setup menu. Command only, no query form.

**Group** Save and Recall

**Syntax** \*RCL <NR1>

**Related Commands** [FACTory](#) on page 127, [\\*LRN?](#) on page 170, [RECALL:SETUp](#) on page 218, [\\*RST](#) on page 224, [\\*SAV](#) on page 225, [SAVe:SETUp](#) on page 229

**Arguments** <NR1> is an integer value in the range from 1 to 10, and specifies a setup storage location.

**Examples** \*RCL3 restores the instrument from a copy of the settings stored in memory location 3.

## RECALL:SETUp

Restores the factory-default instrument settings, user-saved settings from internal nonvolatile memory, or user-saved settings from a file on a USB flash drive. Using the FACTORY argument is equivalent to pushing the DEFAULT SETUP front-panel button. Command only, no query form.

**Group** Save and Recall

**Syntax** RECALL:SETUp {FACTory|<NR1>|<file path>}

**Related Commands** *FACTory* on page 127, *\*RCL* on page 217, *\*RST* on page 224, *\*SAV* on page 225, *SAVe:SETUp* on page 229, *FILESystem:CWD* on page 135

**Arguments** FACTory selects the factory setup.

<NR1> is a value in the range from 1 to 10, and specifies a setup memory storage location.

<file path> is a quoted string that defines the path and name of the .SET setup file to recall from a USB drive. Input the file path using the form <drive>:/<dir>/<filename>.<extension> and one or more <dir>s are optional. If you do not specify them, the instrument will read the file from the default directory (see FILESystem:CWD). <filename> stands for a filename; the use of wildcard characters in filenames is not supported. Filename extensions are not required, but highly recommended.

**Examples** RECALL:SETUp FACTORY recalls the instrument setup to its factory defaults.

RECALL:SETUP 2 recalls the instrument setup from setup storage location 2.

RECALL:SETUP "TEK00000.SET" recalls the setup from the file TEK00000.SET in the current directory (such as "usb0").

## RECALL:WAVEForm

Recalls a saved waveform file to a reference location. Command only, no query form.

**Group** Save and Recall

**Syntax** RECALL:WAVEForm <file path>,REF<x>

**Related Commands** [SAVE:WAVEform](#) on page 230, [FILESystem:CWD](#) on page 135, [FILESystem?](#) on page 134

**Arguments** <file path> specifies a location of the instrument setup file. <file path> is a quoted string that defines the file name and path. Input the file path using the form <drive>:/<dir>/<filename>.<extension> and one or more <dir>s are optional. If you do not specify them, the instrument will read the file from the default directory (see FILESystem:CWD). <filename> stands for a filename; the use of wildcard characters in filenames is not supported. Filename extensions are not required, but highly recommended.

REF<x> is the instrument reference memory location in which to load the waveform. You must load a saved waveform into a reference memory location before displaying the waveform. Reference memory location values are 1 or 2.

**Examples** RECALL:WAVEFORM "tek00000.isf",REF1 recalls the waveform stored in the file named tek00000.isf from the current directory for waveforms to the reference location 1.

## REF<x>?

Returns reference waveform data for the channel specified by <x>, where x is the reference channel number. Query only.

**Group** Vertical

**Syntax** REF<x>?

**Examples** REF1? might return the reference waveform data for reference channel 1.

## REF<x>:DATE?

Returns the date that reference waveform data for channel <x> was copied into the internal reference memory, where x is the reference channel number. Query only.

**Group** Vertical

**Syntax** REF<x>:DATE?

**Examples** REF1:DATE? might return the date the reference waveform data for reference channel 1 was created.

## REF<x>:TIME?

Returns the time that reference waveform data was copied into the internal reference memory for reference channel <x>, where x is the reference channel number. Query only.

**Group** Vertical

**Syntax** REF<x>:TIME?

**Examples** REF2:TIME? might return "16:54:05".

## REF<x>:HORizontal:DELay:TIME?

Returns the horizontal delay time for reference waveform <x>, where x is the reference channel number. Query only.

**Group** Vertical

**Syntax** REF<x>:HORizontal:DELay:TIME?

**Examples** REF1:HORizontal:DELay:TIME? might return the horizontal delay time for reference waveform 1.

## REF<x>:HORizontal:SCAlE?

Returns the horizontal scale for reference waveform <x>, where x is the reference channel number. Query only.

**Group** Vertical

**Syntax** REF<x>:HORizontal:SCAlE?

**Examples** REF<x>:HORizontal:SCAlE? might return :REF1:HORIZONTAL:SCALE  
4.0E-4.

## REF<x>:POSition?

Returns the vertical position for channel <x>, where x is the reference channel number. Query only.

**Group** Vertical

**Syntax** REF<x>:POSition?

**Examples** REF2:POSition? might return the vertical position for reference 2.



## REF<x>:VERTical:POSition?

Returns the vertical position of the reference waveform specified by <x>, where x is the reference channel number. Query only.

**Group** Vertical

**Syntax** REF<x>:VERTical:POSition?

**Examples** REF1:VERTical:POSition? might return :REF1:VERTICAL:POSITION -1.3000E+00 indicating that the current position of Reference 1 is 1.3 divisions below the center graticule.

## REF<x>:VERTical:SCALE?

Returns the vertical scale for the reference waveform specified by <x>, where x is the reference channel number. Query only.

**Group** Vertical

**Syntax** REF<x>:VERTical:SCALE?

**Examples** REF2:VERTICAL:SCALE? might return :REF2:VERTICAL:SCALE 1.0000e+00 indicating that the current vertical scale setting for reference 2 is 1 V per division.

## \*RST

(Reset) Returns the instrument to a known set of instrument settings, but does not purge any stored settings. This command executes a subset of the *FACTory* command.

The \*RST command does not change the following items:

- Calibration data that affects device specifications
- Output queue
- Service Request Enable Register settings
- Power-On Status Clear flag setting
- Alias definitions
- Stored settings or waveforms
- The \*PUD? response
- Any of the values associated with the *DATA* command
- Instrument password

**Group** Status and Error

**Syntax** \*RST

**Related Commands** *FACTory* on page 127, *\*PSC* on page 215, *\*RCL* on page 217, *RECALL:SETUp* on page 218, *\*SAV* on page 225, *SAVe:SETUp* on page 229

**Arguments** None

**Examples** \*RST resets the instrument settings to factory defaults.

---

## S commands

This section lists commands and queries that begin with the letter S.

### \*SAV

Saves the state of the instrument into a specified nonvolatile memory location. You can later use the \*RCL command to restore the instrument to this saved state. This is equivalent to selecting the Save Setup option in the Save/Recall Setup menu. Command only, no query form.

**Group** Save and Recall

**Syntax** \*SAV <NR1>

**Related Commands** [FACTory](#) on page 127, [\\*RCL](#) on page 217, [RECALL:SETUp](#) on page 218

**Arguments** <NR1> is an integer value in the range from 1 to 10 and specifies a memory location. Any settings that have been stored previously at this location are overwritten.

**Examples** \*SAV2 saves the current instrument settings in memory location 2.

## SAVe:ASSIgn:TYPe

Sets or queries the assignment of the data to be saved when the front-panel Save button is pressed.

**Group** Save and Recall

**Syntax** SAvE:ASSIgn:TYPe {IMAGe|WAVEform|SETUp|PRINTer}  
SAVe:ASSIgn:TYPe?

**Arguments** IMAGe assigns the Save button to save screen images.  
WAVEform assigns the Save button to save waveforms.  
SETUp assigns the Save button to save setups.  
PRINTer assigns the Save button to printer.

**Examples** SAvE:ASSIgn:TYPe WAVEform sets the data to be saved to waveform.  
SAVe:ASSIgn:TYPe? might return :SAVe:ASSIgn:TYPe WAVEform indicating that a waveform will be saved when the Save button is pressed.

## SAVe:IMAge

Saves the screen image to a file. Command only, no query form.

Supported image formats are png, windows bitmap, and jpg. The format to use is determined by the value obtained from the :SAVe:IMAge:FILEFormat? query.

**Group** Save and Recall

---

<b>Syntax</b>	SAVe:IMAge <file path>
<b>Arguments</b>	<file path> is a quoted string that defines the path and name of the screen image file to save. Use file name extensions that are appropriate for image format. If you do not specify a path to a folder, the instrument saves the screen image file in the current working folder, using the current save image file format. The current folder refers to the name of a folder as returned by the FILESystem:CWD query.  Use the SAvE:IMAge:FILEFormat command to set the screen image graphical file format.
<b>Examples</b>	SAVe:IMAge" usb0\PROD-TST\VID-EVAL.BMP" saves the screen image to the file VID-EVAL.BMP in the folder usb0\PROD-TST .

## SAVe:IMAge:FILEFormat

Sets or queries the file format to use for saving screen images when the file type cannot be determined from the given file name or when screen images are captured by using the front panel.

<b>Group</b>	Save and Recall
<b>Syntax</b>	SAVe:IMAge:FILEFormat {PNG BMP JPG} SAVe:IMAge:FILEFormat?
<b>Arguments</b>	BMP sets the screen image file format to Microsoft Windows Bitmap format. PNG saves the file in Portable Network Graphics format. JPG saves the file in Joint Picture Group format.

**Examples**    `SAVe:IMAGe:FILEFormatPNG` sets the screen image graphical file format to PNG.

## **SAVe:IMAGe:LAYout**

Sets or returns the layout to use for saved screen images.

**Group**        Save and Recall

**Syntax**        `SAVe:IMAGe:LAYout {LANdscape|PORTRait}`  
`SAVe:IMAGe:LAYout?`

**Arguments**    `LANdscape` specifies that screen images are saved in landscape format.  
`PORTRait` specifies that screen images are saved in portrait format.

**Examples**        `SAVe:IMAGe:LAYout LANdscape` specifies that images are saved in landscape format.  
`SAVe:IMAGe:LAYout?` might return `:SAVe:IMAGe:LAYout LANdscape` indicating that images are saved in landscape format.

## SAVe:SETUp

Saves the current state of the instrument into the specified memory location. This is equivalent to selecting the Save Setup option in the Save/Recall Setup menu. You can later use the \*RCL command to restore the instrument to this saved state. Command only, no query form.

**Group** Save and Recall

**Syntax** SAvE:SETUp {<file path>|<NR1>}

**Related Commands** [RECALL:SETUp](#) on page 218, [\\*RCL](#) on page 217, [\\*SAV](#) on page 225

**Arguments** <NR1> specifies a location for saving the current front-panel setup. The front-panel setup value ranges from 1 to 10. Using an out-of-range value causes an execution error. Any settings that have been stored previously at this location will be overwritten.

<file path> is the target location for storing the setup file. <file path> is a quoted string that defines the file name and path. Input the file path using the form <drive>:<dir>/<filename>. <extension> and one or more <dir>s are optional. If you do not specify them, the instrument will store the file in the current working directory. <filename> stands for a filename. (Use of wildcard characters in filenames is not supported.) Filename extensions are not required but are highly recommended. For setups, use the extension .SET.

**Examples** SAvE:SETUp5 saves the current front-panel setup to memory location 5.

SAVE:SETUP "TEK00000.SET" saves the current instrument setup in the file TEK00000.SET in the current working directory.

## SAVe:WAVEform

Stores a waveform in one of the nonvolatile reference memory locations. This command is equivalent to selecting the Save Waveform option in the Save/Recall Waveform menu. Only individual analog waveforms (CH<x>, MATH, FFT ) can be saved to reference memory locations. Command only, no query form.

You can save a specified waveform or waveforms to a single CSV file when the SAVE:WAVEFORM:FILEFORMAT is set to SPREADSHEET.

You can save a specified waveform or waveforms to consecutive ISF (internal save format) files when the SAVE:WAVEFORM:FILEFORMAT is set to INTERNAL.

**Group** Save and Recall

**Syntax** SAvE:WAVEform[<wfm>,{REF<x>}] | [REF<x>, <QString>]

**Related commands** [RECALL:WAVEForm](#) on page 219, [SAVe:WAVEform:FILEFormat](#) on page 231

**Arguments** <wfm>, <REF<x> saves the specified waveform to the specified reference memory location. <wfm> can be any live analog channel (where <x> is the channel number), the MATH waveform, or FFT waveform. <wfm>, <QString> saves the specified waveform to the file specified in the quoted string argument. Any live channel (such as CH1), the MATH waveform, the FFT waveform, or any reference waveform can be saved to a file.

REF<x> is one of the allowable reference waveform storage locations.

<file path> is a quoted string that defines the path and name of the waveform file to save. Use the extension .CSV for saved waveform files. Waveform data is saved as self-documented comma-separated ASCII values.



**Examples** SAVE:WAVEFORM CH1,REF1 saves the CH1 waveform in reference memory location 1.

:SAVE:WAVEFORM:FILEFORMAT SPREADSHEET; :SAVE:WAVEFORM Ch1, "usb0/test1\_ch1.csv" saves channel 1 waveforms to usb0/test1\_ch1.csv.

:SAVe:WAVEform:FILEFormat INTERNal; :SAVe:WAVEform Ch1, "usb0/test1\_ch1.isf" saves channel 1 waveforms usb0/test1\_ch1.isf

## SAVe:WAVEform:FILEFormat

Specifies or queries the file format for saved waveforms. Waveform header and timing information is included in the resulting file of non-internal formats.

**Group** Save and Recall

**Syntax** SAVe:WAVEform:FILEFormat {INTERNal|SPREADSheet}  
SAVe:WAVEform:FILEFormat?

**Related commands** [CURVe](#) on page 92, [DATa](#) on page 95, [DATa:STARt](#) on page 98, [DATa:STOP](#) on page 99, [SAVe:WAVEform](#) on page 230, [WFMinpre:NR\\_Pt?](#) on page 291, [WFMinpre:NR\\_Pt?](#) on page 291

**Arguments** INTERNal specifies that waveforms are saved in an internal format, using aisf filename extension. These files can be recalled as reference waveforms.

SPREADSheet specifies that waveform data is saved in a format that contains comma delimited values. These waveform data files are named using the csv filename extension. Saving waveforms in CSV format enables spreadsheet programs to import the data.

**Examples** SAVE:WAVEFORM:FILEFORMAT INTERNAL specifies that the internal file format is the format used for saving waveforms.  
SAVE:WAVEFORM:FILEFORMAT? might return :SAVE:WAVEFORM:FILEFORMAT INTERNAL indicating that waveforms are saved using the internal format.

## SEARCH

Returns all search-related settings. Query only.

**Group** Search

**Syntax** SEARCH?

**Arguments** NA

## SEARCH:SEARCH<x>:COpy

Copies the search criteria to the trigger, or the trigger criteria to the search. Set only.

**Group** Search

**Syntax** SEARCH:SEARCH<x>:COpy {SEARCHtotrigger|TRIGgertosearch}

**Arguments** SEARCHtotrigger copies the search criteria to the trigger.  
TRIGgertosearch copies the trigger criteria to the search.

**Returns** SEARCHtrigger copies the search criteria to the trigger.  
TRIGgertosearch copies the trigger criteria to the search.

**Examples** SEARCH:SEARCH<SEARCHtrigger>:COPy sets the search criteria to the trigger.

## SEARCH:SEARCH<x>:STATE

Sets the search state to on or off. Set only.

**Group** Search

**Syntax** SEARCH:SEARCH<x>:STATE {<NR1>|OFF|ON}  
SEARCH:SEARCH<x>:STATE?

**Arguments** OFF or <NR1> = 0 sets the search state to off.  
ON or <NR1>  $\neq$  0 sets the search state to on.

**Returns** {<NR1>|OFF|ON}

**Examples** SEARCH:SEARCH<ON>:STATE sets the search state to ON.

## SEARCH:SEARCH<x>:TOTAL

Returns the total number of matches for search <x>. Query only.

**Group** Search

**Syntax** SEARCH:SEARCH<x>:TOTAL?

**Arguments** NA

## SEARCH:SEARCH<x>:TRIGger:A:LEVel

Sets or returns the level for an edge search.

**Group** Search

**Syntax** SEARCH:SEARCH<x>:TRIGger:A:LEVel {<NR3> | TTL | ECL}  
SEARCH:SEARCH<x>:TRIGger:A:LEVel?

**Arguments** <NR3>  
TTL  
ECL

**SEARCH:SEARCH<x>:TRIGger:A:LEVel:CH<x>**

Sets or returns the level for an edge search of the specified channel.

**Group** Search

**Syntax** SEARCH:SEARCH<x>:TRIGger:A:LEVel:CH<x> {<NR3>|TTL|ECL}  
SEARCH:SEARCH<x>:TRIGger:A:LEVel:CH<x>?

**Returns** <NR3>  
TTL  
ECL

**SEARCH:SEARCH<x>:TRIGger:A:LOWerthreshold:MATH**

Sets or returns the math waveform lower threshold to determine where to place a mark. This setting is applied to all math searches that use a lower threshold. <x> is the search number.

**Group** Search

**Syntax** SEARCH:SEARCH<x>:TRIGger:A:LOWerthreshold:MATH {TTL|ECL|<NR3>}  
SEARCH:SEARCH<x>:TRIGger:A:LOWerthreshold:MATH?

**Returns** TTL specifies a preset TTL level of 1.4 V  
ECL specifies a preset ECL level of -1.3 V.  
<NR3> specifies the threshold voltage level.

**SEARCH:SEARCH<x>:TRIGger:A:LOWerthreshold:REF<x>**

Sets or returns the lower waveform threshold level for all reference waveform searches.

**Group** Search

**Syntax** SEARCH:SEARCH<x>:TRIGger:A:LOWerthreshold:REF<x> {TTL|ECL|<NR3>}

SEARCH:SEARCH<x>:TRIGger:A:LOWerthreshold:REF<x>?

**Returns** TTL specifies a preset TTL level of 1.4 V  
ECL specifies a preset ECL level of -1.3 V.  
<NR3> specifies the threshold voltage level.

**SEARCH:SEARCH<x>:TRIGger:A:TYPE**

Sets or returns the trigger type setting for a search.

**Group** Search

**Syntax** SEARCH:SEARCH<x>:TRIGger:A:TYPE {EDGE | SETHold | PULSEWidth | RUNt} with the appropriate application module installed.

SEARCH:SEARCH<x>:TRIGger:A:TYPE?

**Returns** EDGE  
SETHold  
PULSEWidth  
RUNt

## SEARCH:SEARCH<x>:TRIGger:A:EDGE:SLOpe

Sets or returns the slope for an edge trigger search to determine where to place a mark. is the search number.

**Group** Search

**Syntax** SEARCH:SEARCH<x>:TRIGger:A:EDGE:SLOpe {RISe | FALL}  
SEARCH:SEARCH<x>:TRIGger:A:EDGE:SLOpe?

**Arguments** RISe specifies a rising edge.  
FALL specifies a falling edge.

**Returns** RISe|FALL  
RISe specifies a rising edge.  
FALL specifies a falling edge.

**Examples** SEARCH:SEARCH<x>:TRIGger:A:EDGE:SLOpe RISe sets the slope at rising edge for the edge trigger search.  
SEARCH:SEARCH<x>:TRIGger:A:EDGE:SLOpe? might return FALL indicates the slope is at falling edge for the edge trigger search.

**SEARCH:SEARCH<x>:TRIGger:A:EDGE:SOUrce**

Sets or returns the source waveform for an edge search.

**Group** Search

**Syntax** SEARCH:SEARCH<x>:TRIGger:A:EDGE:SOUrce {CH1 | CH2 | CH3 | CH4 |  
MATH}

SEARCH:SEARCH<x>:TRIGger:A:EDGE:SOUrce?

**Returns** {CH1 | CH2 | CH3 | CH4 | MATH}

**SEARCH:SEARCH<x>:TRIGger:A:LOWerthreshold:CH<x>**

Sets or returns the lower waveform threshold level for all channel waveform searches.

**Group** Search

**Syntax** SEARCH:SEARCH<x>:TRIGger:A:LOWerthreshold:CH<x> {TTL|ECL|  
<NR3>}

SEARCH:SEARCH<x>:TRIGger:A:LOWerthreshold:CH<x>?

**Returns** {TTL | ECL | <NR3>}



## SEARCH:SEARCH<x>:TRIGger:A:PULSEWidth:POLarity

Sets or returns the polarity for a pulse search.

**Group** Search

**Syntax** SEARCH:SEARCH<x>:TRIGger:A:PULSEWidth:POLarity {NEGative|  
POSitive}

SEARCH:SEARCH<x>:TRIGger:A:PULSEWidth:POLarity?

**Returns** {NEGative | POSitive}

## SEARCH:SEARCH<x>:TRIGger:A:PULSEWidth:SOUrce

Sets or returns the source waveform for a pulse search.

**Group** Search

**Syntax** SEARCH:SEARCH<x>:TRIGger:A:PULSEWidth:SOUrce {CH1|CH2|CH3|  
CH4|MATH|REF}

SEARCH:SEARCH<x>:TRIGger:A:PULSEWidth:SOUrce?

**Returns** {CH1|CH2|CH3|CH4|MATH|REF}

## SEARCH:SEARCH<x>:TRIGger:A:PULSEWidth:WHEn

Sets or returns the condition for generating a pulse width search.

**Group** Search

**Syntax** SEARCH:SEARCH<x>:TRIGger:A:PULSEWidth:WHEn {LESSthan|  
MOREthan|EQUAL|UNEQUAL}  
SEARCH:SEARCH<x>:TRIGger:A:PULSEWidth:WHEn?

**Returns** {LESSthan|MOREthan|EQUAL|UNEQUAL}

## SEARCH:SEARCH<x>:TRIGger:A:PULSEWidth:WIDth

Sets or returns the pulse width setting for a pulse width search.

**Group** Search

**Syntax** SEARCH:SEARCH<x>:TRIGger:A:PULSEWidth:WIDth  
SEARCH:SEARCH<x>:TRIGger:A:PULSEWidth:WIDth?

## SEARCH:SEARCH<x>:TRIGger:A:RUNT:POLarity

Sets or returns the polarity setting for a runt search.

**Group** Search

**Syntax** SEARCH:SEARCH<x>:TRIGger:A:RUNT:POLarity {EITher|NEGative|POSitive}  
SEARCH:SEARCH<x>:TRIGger:A:RUNT:POLarity?

**Returns** {EITher|NEGative|POSitive}

## SEARCH:SEARCH<x>:TRIGger:A:RUNT:SOUrce

Sets or returns the source setting for a runt search.

**Group** Search

**Syntax** SEARCH:SEARCH<x>:TRIGger:A:RUNT:SOUrce {CH1|CH2|CH3|CH4|MATH|REF}  
SEARCH:SEARCH<x>:TRIGger:A:RUNT:SOUrce?

**Arguments** CH1–CH4 specifies an input channel as the edge source.  
MATH specifies the math waveform as the search source.  
REF specifies the reference waveform as the search source.

**Returns** CH1|CH2|CH3|CH4|MATH|REF  
CH1–CH4 specifies an input channel as the edge source.  
MATH specifies the math waveform as the search source.  
REF specifies the reference waveform as the search source.

**Examples** SEARCH:SEARCH<x>:TRIGger:A:RUNT:SOURce? might return MATH indicating that the math waveform is set to runt search.  
SEARCH:SEARCH<x>:TRIGger:A:RUNT:SOURce CH2 specifies the input channel2 as the edge source setting for a runt search.

## SEARCH:SEARCH<x>:TRIGger:A:RUNT:WHEn

Sets or returns the condition setting for a runt search.

**Group** Search

**Syntax** SEARCH:SEARCH<x>:TRIGger:A:RUNT:WHEn {LESSthan|MOREthan|EQUAL|UNEQUAL|OCCURS}  
SEARCH:SEARCH<x>:TRIGger:A:RUNT:WHEn?

**Returns** {LESSthan | MOREthan | EQUAL | UNEQUAL | OCCURS}

## SEARCH:SEARCH<x>:TRIGger:A:RUNT:WIDth

Sets or returns the width setting for a runt search.

**Group** Search

**Syntax** SEARCH:SEARCH<x>:TRIGger:A:RUNT:WIDth <NR3>  
SEARCH:SEARCH<x>:TRIGger:A:RUNT:WIDth?

**Arguments** <NR3> specifies the minimum width, in seconds.

## SEARCH:SEARCH<x>:TRIGger:A:UPPerthreshold:CH<x>

Sets or returns the waveform upper threshold level for all channel waveform searches.

**Group** Search

**Syntax** SEARCH:SEARCH<x>:TRIGger:A:UPPerthreshold:CH<x> {TTL|ECL}  
SEARCH:SEARCH<x>:TRIGger:A:UPPerthreshold:CH<x>?

**Arguments** TTL specifies a preset TTL high level of 1.4 V.  
ECL specifies a preset ECL high level of -1.3 V.

**Returns** TTL specifies a preset TTL high level of 1.4 V.  
ECL specifies a preset ECL high level of -1.3 V.

**SElect:CH<x>**

Turns the display of the channel <x> waveform on or off, where <x > is the channel number. This command also resets the acquisition. The query returns whether the channel is on or off but does not indicate whether it is the selected waveform.

**Group** Vertical

**Syntax** SElect:CH<x> {ON | OFF | <NR1>}  
SElect:CH<x>?

**Arguments** ON turns on the display of the specified waveform. This waveform also becomes the selected waveform.  
OFF turns off the display of the specified waveform.  
<NR1> = 0 turns off the display of the specified waveform; any other value turns on the display of the specified waveform.

**Examples** SElect:CH2 ON turns the channel 2 waveform display on, and selects channel 2.  
SElect:CH1? might return :SElect:CH1 1 indicating that channel 1 is being displayed.

## SElect:CONTROL

Sets or queries the waveform that is the recipient (focus) of future channel-related commands, for example, the cursor commands. The command form also performs the equivalent of a SElect:CH<x> ON command, as well as the Math, FFT and Reference of that command.

<b>Group</b>	Vertical
<b>Syntax</b>	SElect:CONTROL {CH<x>   MATH   FFT   REF<x>} SElect:CONTROL?
<b>Arguments</b>	<p>CH&lt;x&gt; specifies a channel waveform as the waveform affected by the front-panel controls. &lt;x&gt; is the channel number.</p> <p>MATH specifies the math waveform as the waveform that is affected by the front-panel controls.</p> <p>FFT specifies the FFT waveform as the waveform that is affected by the front-panel controls.</p> <p>REF&lt;x&gt; specifies a reference waveform as the waveform affected by the front-panel controls. &lt;x&gt; specifies the reference waveform number (1 or 2).</p>
<b>Returns</b>	NONE if all the channels are turned off. NONE is ignored on input.
<b>Examples</b>	<p>SElect:CONTROL CH1 sets channel 1 as the recipient of future channel related commands.</p> <p>SElect:CONTROL? might return :SElect:CONTROL CH1 indicating that channel 1 is the recipient of future channel related commands.</p>

## SElect:FFT

Turns on and off the display of the FFT waveform. The query returns whether the FFT waveform is on or off, but does not indicate whether it is the selected waveform.

**Group** Vertical

**Syntax** SElect:FFT {ON|OFF|<NR1>}  
SElect:FFT?

**Arguments** ON turns on the display of the specified waveform. This waveform also becomes the selected waveform.  
OFF turns off the display of the specified waveform.  
<NR1> = 0 turns off the display of the specified waveform; any other value turns on the display of the specified waveform.

**Examples** SELECT:FFT ON turns the math waveform display on, and selects it.  
SELECT:FFT? might return :SELECT:FFT 1 indicating that the math waveform is being displayed.



## SElect:MATH

Turns on and off the display of the math waveform. The query returns whether the math waveform is on or off but does not indicate whether it is the selected waveform.

**Group** Vertical

**Syntax** SElect:MATH {ON|OFF|<NR1>}  
SElect:MATH?

**Arguments** ON turns on the display of the specified waveform. This waveform also becomes the selected waveform.  
OFF turns off the display of the specified waveform.  
<NR1> = 0 turns off the display of the specified waveform; any other value turns on the display of the specified waveform.

**Examples** SELECT:MATH ON turns the math waveform display on, and selects it.  
SELECT:MATH? might return :SELECT:MATH 1 indicating that the math waveform is being displayed.

**SElect:REF<x>**

Turns on and off the display of reference waveform <x>. The <x > variable represents the reference channel number. The query returns whether the channel is on or off.

**Group** Vertical

**Syntax** SElect:REF<x> {ON|OFF|<NR1>}  
SElect:REF<x>?

**Arguments** ON turns on the display of the specified waveform. This waveform also becomes the selected waveform.  
OFF turns off the display of the specified waveform.  
<NR1> = 0 turns off the display of the specified waveform; any other value turns on the display of the specified waveform.

**Examples** SELECT:REF2 ON displays reference 2 and makes reference 2 the selected waveform.  
SELECT:REF2? might return :SELECT:REF2 1 indicating that reference waveform 2 is being displayed.

## SET?

Returns most instrument settings. You can send these responses back to the instrument to return the instrument to the state it was in when you sent SET. This query is identical to the \*LRN? query. Query only.

---

**NOTE.** *The SET? query always returns command headers, regardless of the setting of the HEADER command. This is because the returned data is intended to be able to be sent back to the instrument as concatenated commands. The VERbose command can still be used to specify whether the returned headers should be abbreviated or full length.*

---

**Group** Miscellaneous

**Syntax** SET?

**Related Commands** [HEADER](#) on page 147, [\\*LRN?](#) on page 170

**Returns** Most instrument settings. See *Appendix B: Factory Setup*.

**Examples** SET? might return a partial string like the following: ACQUIRE:STOPAFTER RUNSTOP;STATE 1;MODE SAMPLE; NUMAVG 16;;HEADER 1;;VERBOSE 1;;DISPLAY:FORMAT YT;STYLE VECTORS;PERSISTENCE 500.0E-3;CONTRAST 50;;LOCK NONE;;HARDCOPY:FORMAT EPSON;PORT RS232;LAYOUT PORTRAIT;

## SETUP<x>:DATE?

Returns the date when the instrument setup was saved for the specified setup<x>. Query only.

**Group** Save and Recall

**Syntax** SETUP<x>:DATE?

**Examples** SETUP4:DATE? might return :SETUP4:DATE: 04-18-06 which is the setup date for channel 4.

## SETUP<x>:TIME? (Query Only)

Returns the time when the instrument setup was saved for the specified setup<x>.

**Group** Save and Recall

**Syntax** SETUP<x>:TIME?

**Examples** SETUP2:TIME? might return :SETUP2:TIME: 15:24:07 which is the setup time for channel 2. The default port is 4000.

## SOCKETServer:SOCKETCURRENTPort?

Returns the current TCPIP port of the socket server connection. Query only.

**Group** Miscellaneous

**Syntax** SOCKETServer:SOCKETCURRENTPort?

**Related Commands** [SOCKETServer:SOCKETPort](#) on page 251  
[SOCKETServer:SOCKETStatus](#) on page 254  
[SOCKETServer:SOCKETPROtocol](#) on page 252  
[SOCKETServer:SOCKETSTORE](#) on page 255

**Returns** <NR1> is an integer that specifies the port for the socket server connection.

**Examples** SOCKETServer:SOCKETCURRENTPort? might return 4000, indicating that port 4000 is currently the TCPIP port used for the socket server connection.

## SOCKETServer:SOCKETPort

This command configures the TCPIP port for the socket server connection. The TCPIP port value varies from 1024 to 65535. If the argument is outside this range, an error is displayed on the oscilloscope as "Socket Server Select Port Setting Failed" and the previous selected port value remains unchanged.

Use "Set port" from the setting or use the PI commands: SOCKETServer:SOCKETSTORE to restart socket server on the newly selected port" and SOCKETServer:SOCKETPort? can be used to query the selected port. The default configuration is 4000.

<b>Group</b>	Miscellaneous
<b>Syntax</b>	SOCKETServer:SOCKETPort <NR1> SOCKETServer:SOCKETPort?
<b>Related Commands</b>	<a href="#">SOCKETServer:SOCKETCURRENTPort?</a> on page 251 <a href="#">SOCKETServer:SOCKETPROtocol</a> on page 252 <a href="#">SOCKETServer:SOCKETSTAtus</a> on page 254 <a href="#">SOCKETServer:SOCKETSTORE</a> on page 255
<b>Arguments</b>	<NR1> is an integer that specifies the port for the socket server connection.
<b>Returns</b>	The query form of this command returns the configured TCPIP port for the socket server connection.
<b>Examples</b>	SOCKETServer:SOCKETPort 1080 sets the socket server port to 1080. SOCKETServer:SOCKETPort? might return 4000, indicating that port 4000 is configured TCPIP port for the socket server connection.

## SOCKETServer:SOCKETPROtocol

This command sets the protocol for the socket server. When set to Terminal, a session startup message is sent to the socket, and a command prompt is provided. When set to None, these features are disabled, allowing the server to be used for raw socket transactions, such as with a VISA socket connection. The default setting is None. If the setting fails, an error message is displayed on oscilloscope as “Socket Server Protocol Setting Failed” and the current value remains unchanged.

The Terminal protocol supports the Tektronix Instrument Control Terminal Session Control commands listed in the following table.

**Table 31: Terminal session control commands**

Command	Description
!t <timeout>	Sets the response timeout in milliseconds
!d	Sends device clear to the instrument
!r	Reads response from instrument
!h	Prints this usage information
?	Treats as a query and the response is read automatically

---

**NOTE.** *The Backspace key and delete key are not recognized when sent to the oscilloscope. It is recommended to use a terminal that supports command line editing before sending the line to the oscilloscope.*

---

**Group** Miscellaneous

**Syntax** SOCKETServer:SOCKETPROtocol {TERMINAL | NOne}  
SOCKETServer:SOCKETPROtocol?

**Related Commands** [SOCKETServer:SOCKETCURRENTPort?](#) on page 251  
[SOCKETServer:SOCKETPort](#) on page 251  
[SOCKETServer:SOCKETSTAtus](#) on page 254  
[SOCKETServer:SOCKETSTORE](#) on page 255

**Arguments** TERMINAL specifies that a session startup message is sent to the socket, and a command prompt is provided.  
NOne disables these features, allowing the server to be used for raw socket transactions.

**Returns** The query form of this command returns `TERMINAL` or `None` indicating current protocol type.

**Examples** `SOCKETServer:SOCKETPROtocol TERMINAL` sets the protocol to terminal, so that a session startup message is sent to the socket, and a command prompt is provided.

`SOCKETServer:SOCKETPROtocol?` might return `NONE`, indicating that the protocol is set to support raw socket connection.

## SOCKETServer:SOCKETSTatus

This command enables or disables the socket server which supports a Telnet or other TCP/IP socket connection to send commands and queries to the instrument. The default state is `Enable`.

---

**NOTE.** *If the socket server state is "Disable" and this command is sent to enable the socket server when the port is in use by another service, then an error message is displayed on oscilloscope as "Socket Server Status Setting Failed" and the socket server remains disabled. In this case, select a different port number and attempt to enable the socket server again.*

---

**Group** Miscellaneous

**Syntax** `SOCKETServer:SOCKETSTatus {ENABLE | DISABLE}`  
`SOCKETServer:SOCKETSTatus?`

**Related Commands** [SOCKETServer:SOCKETCURRENTPort?](#) on page 251  
[SOCKETServer:SOCKETPort](#) on page 251  
[SOCKETServer:SOCKETPROtocol](#) on page 252  
[SOCKETServer:SOCKETSTORE](#) on page 255



- Arguments**    ENABle enables the socket server.  
                  DISABle disables the socket server.
- Returns**        The query form of this command returns status of the socket server.
- Examples**        SOCKETServer:SOCKETSTatus ENABle enables the socket server.  
                  SOCKETServer:SOCKETSTatus? might return ENABle, indicating that the  
                  socket server is enabled (the default).

## SOCKETServer:SOCKETSTORE

This command sets the selected TCPIP port for the socket server connection by restarting the socket server on the selected port. If the setting fails, an error message is displayed on oscilloscope as “Socket Server Set Port Setting Failed” and the socket server remains stopped. In this case, select a different port number and attempt to start the socket server again using “set port” from the “Socket Server” settings or use PI command "SOCKETServer:SOCKETSTORE" to start socket server on newly selected port.

**Group**            Miscellaneous

**Syntax**           SOCKETServer:SOCKETSTORE

**Related Commands**    [SOCKETServer:SOCKETCURRENTPort?](#) on page 251  
                          [SOCKETServer:SOCKETPort](#) on page 251  
                          [SOCKETServer:SOCKETPROtocol](#) on page 252  
                          [SOCKETServer:SOCKETSTatus](#) on page 254

**Examples** SOCKETServer:SOCKETSTORE restarts the socket server on selected port.

## \*SRE

(Service Request Enable) sets or queries the bits in the Service Request Enable Register (SRER). Refer to the Status and Events section for more information.

**Group** Status and Error

**Syntax** \*SRE <NR1>  
\*SRE?

**Related Commands** [\\*CLS](#) on page 79, [DESE](#) on page 102, [\\*ESE](#) on page 114, [\\*ESR?](#) on page 115, [EVENT?](#) on page 123, [EVMsg?](#) on page 124, [FACTory](#) on page 127, [\\*PSC](#) on page 215

**Arguments** <NR1> is an integer value in the range from 0 to 255. The binary bits of the SRER are set according to this value. Using an out-of-range value causes an execution error. The power-on default for SRER is 0 if \*PSC is 1. If \*PSC is 0, the SRER maintains its value through a power cycle.

**Examples** \*SRE48 sets the bits in the SRER to 00110000 binary.  
\*SRE? might return a value of 32, showing that the bits in the SRER have the binary value 00100000.

## \*STB?

(Read Status Byte) query returns the contents of the Status Byte Register (SBR) using the Master Summary Status (MSS) bit. Refer to the Status and Events section for more information. Query only.

**Group** Status and Error

**Syntax** \*STB?

**Related Commands** [\\*CLS](#) on page 79, [DESE](#) on page 102, [\\*ESE](#) on page 114, [\\*ESR?](#) on page 115, [EVENT?](#) on page 123, [EVMsg?](#) on page 124, [FACTory](#) on page 127, [\\*SRE](#) on page 256

**Returns** <NR1> is the contents of the Status Byte Register (SBR)

**Examples** \*STB? might return the value 96, showing that the SBR contains the binary value 01100000.



---

## T commands

This section lists commands and queries that begin with the letter T.

### TEKSecure

Sets the Teksecure Erase Memory option to erase user data, which may be settings or confidential data files. This is equivalent to invoking Teksecure from the Utility->Config->TekSecure Erase Memory menu. This is a time-consuming operation (3 to 5 minutes) and the instrument is inoperable until the TekSecure operation is complete.

**Group** Miscellaneous

**Syntax** TEKSecure

### TIME

Sets or queries the time the instrument displays. The instrument uses the time and date values to time stamp files and show the time and date on the instrument display.

#### Conditions

**Group** Miscellaneous

**Syntax** TIME <QString>  
TIME?

**Related commands** [DATE](#) on page 101

**Arguments** <QString> is a time in the form "hh:mm:ss" where hh refers to a two-digit hour number, mm refers to a two-digit minute number from 00 to 59, and ss refers to a two-digit second number from 00 to 59.

**Examples** TIME "14:00:00" sets the time to exactly 2:00 p.m.  
TIME? might return :TIME "11:25:03" indicating that the current time is set to 11:25 a.m. and 03 seconds.

## TRIGger

Forces a trigger event to occur. No query form.

**Group** Trigger

**Syntax** TRIGger FORCE

**Arguments** FORCE creates a trigger event. If TRIGger:STATE is READY, the acquisition will complete; otherwise this command is ignored.

**Examples** TRIGgerFORCE forces a trigger event to occur.

## TRIGger:A

Sets the instrument trigger level to 50% of the minimum and maximum values of the signal. Returns the current A trigger settings when used as a query.

The trigger level is the voltage threshold through which the trigger source signal must pass to generate a trigger event. This command works for the following cases: Edge Trigger (when source is not Line), Logic Trigger (when Clock Source is not Off or Logic Pattern is Don't Care), and Pulse Width Trigger.

**Group** Trigger

**Syntax** TRIGger:A SETLevel  
TRIGger:A?

**Related commands** [TRIGger:A:EDGE?](#) on page 262, [TRIGger:A:PULse?](#) on page 269

**Arguments** SETLevel sets the A trigger level to 50% of the minimum and maximum values of the trigger source input signal. This is equivalent to pressing the front-panel PUSH to SET to 50% button.

**Examples** TRIGger:ASETLEVEL sets the A trigger level to 50% of the range of the minimum and maximum values of the trigger input signal.

TRIGGER:A? might return a long response with A trigger parameters, some of which could be as follows: :TRIGGER:A:MODE AUTO;TYPE EDGE;LEVEL 20.0000E-3;LEVEL:CH1 20.0000E-3;CH2 0.0000; CH3 0.0000;CH4 0.0000;:TRIGGER:A:UPPERTHRESHOLD:CH1 1.4000;CH2 800.0000E-3;CH3 8 00.0000E-3;CH4 800.0000E-3;:TRIGGER:A:LOWERTHRESHOLD:CH1 20.0000E-3;CH2 0.0000;CH3 0.0000;CH4 0.0000;:TRIGGER:A:HOLDOFF:TIME 20.0000E-9;:TRIGGER:A:EDGE:SOURCE CH1;COUPLING DC;SLOPE RISE;:TRIGGER:A:LOGIC:CLASS SETHOLD;FUNCTION AND;THRESHOLD: CH1 20.0000E-3;CH2 0.0000; CH3 0.0000;CH4 0.0000; :TRIGGER:A:LOGIC:INPUT:CH1 X;CH2 X; CH3 X;CH4 X; CLOCK:SOURCE NONE;EDGE.

## TRIGger:A:EDGE?

Returns the trigger coupling, source, and slope settings for the A edge trigger. Query only.

**Group** Trigger

**Syntax** TRIGger:A:EDGE?

**Related commands** [TRIGger:A:PULse?](#) on page 269

**Returns** Trigger coupling, source, and slope settings for the A edge trigger.

**Examples** TRIGger:A:EDGE? might return :TRIGGER:A:EDGE:SOURCE CH1;COUPLING DC; SLOPE RISE indicating the trigger source, coupling, and slope for the A edge trigger.

## TRIGger:A:EDGE:COUPling

Sets or queries the type of coupling for the A edge trigger. This is equivalent to setting the Coupling option in the Trigger menu.

**Group** Trigger

**Syntax** TRIGger:A:EDGE:COUPling {DC|HFRej|LFRej|NOISErej}  
TRIGger:A:EDGE:COUPling?



---

<b>Related commands</b>	<a href="#">TRIGger:A:EDGE:SOUrce</a> on page 264, <a href="#">TRIGger:A:EDGE:SLOpe</a> on page 263
<b>Arguments</b>	<p>DC selects DC coupling, which passes all input signals to the trigger circuitry.</p> <p>HFRej coupling attenuates the high-frequency components, above 50 kHz, of the trigger signal.</p> <p>LFRej coupling removes the low-frequency components, below 50 kHz, of the trigger signal.</p> <p>NOISErej selects DC low sensitivity, which provides stable triggering by increasing the trigger hysteresis. Increased hysteresis reduces the trigger sensitivity to noise but may require greater trigger signal amplitude.</p>
<b>Examples</b>	<p>TRIGger:A:EDGE:COUPLingDC sets the A edge trigger coupling to DC.</p> <p>TRIGGER:A:EDGE:COUPLING? might return :TRIGGER:A:EDGE:COUPLING DC indicating that the A edge trigger coupling is set to DC.</p>

## TRIGger:A:EDGE:SLOpe

Sets or queries the slope for the A edge trigger. This is equivalent to setting the Slope option in the Trigger menu.

<b>Group</b>	Trigger
<b>Syntax</b>	<p>TRIGger:A:EDGE:SLOpe{RISe FALL}</p> <p>TRIGger:A:EDGE:SLOpe?</p>
<b>Related commands</b>	<a href="#">TRIGger:A:EDGE:SOUrce</a> on page 264, <a href="#">TRIGger:A:EDGE:COUPLing</a> on page 262

- Arguments** FALL specifies to trigger on the falling or negative edge of a signal.  
RISe specifies to trigger on the rising or positive edge of a signal.
- Examples** TRIGger:A:EDGE:SLOpeRISE sets the A edge trigger to occur on the rising edge of the signal.  
TRIGGER:A:EDGE:SLOPE? might return :TRIGGER:A:EDGE:SLOPE FALL indicating that the A edge trigger slope is negative.

## TRIGger:A:EDGE:SOUrce

Sets or queries the source for the edge trigger. This is equivalent to setting the Source option in the Trigger menu.

- Group** Trigger
- Syntax** TRIGger:A:EDGE:SOUrce {{CH1 | CH2 | CH3 | CH4 | LINE}}  
TRIGger:A:EDGE:SOUrce?
- Related commands** [TRIGger:A:EDGE:SLOpe](#) on page 263, [TRIGger:A:EDGE:COUPling](#) on page 262
- Arguments** CH<x> specifies one of the analog input channels. The value of <x> can vary from 1 through 4 for 4-channel instruments or 1 through 2 for 2-channel instruments.  
AC LINE specifies the AC line as a trigger source.
- Examples** TRIGger:A:EDGE:SOUrceCH1 specifies channel 1 as the A edge trigger source.  
TRIGGER:A:EDGE:SOUrce? might return :TRIGGER:A:EDGE:SOURCE CH1 indicating that channel 1 is the A edge trigger source.

## TRIGger:A:HOLDOff?

Returns the A trigger holdoff parameters. These parameters specify the time period during which the trigger circuitry is not looking to generate a trigger event. Query only.

**Group** Trigger

**Syntax** TRIGger:A:HOLDOff?

**Related commands** [TRIGger:A:HOLDOff:TIME](#) on page 265

**Returns** A trigger holdoff value.

**Examples** TRIGger:A:HOLDOff? might return :TRIGGER:A:HOLDOFF:TIME 900.0000E-09, indicating that the A edge trigger holdoff time (by default) is 900 ns.

## TRIGger:A:HOLDOff:TIME

Sets or queries the A trigger holdoff time.

**Group** Trigger

**Syntax** TRIGger:A:HOLDOff:TIME <NR3>  
TRIGger:A:HOLDOff:TIME?

**Arguments** <NR3> is the A trigger holdoff time. The range is 20 ns to 8.0 s.

**Examples** TRIGger:A:HOLDOff:TIME10 sets the holdoff time to 10 s.  
TRIGGER:A:HOLDOFF:TIME? might return :TRIGGER:A:HOLDOFF:TIME 1.2000E-06 indicating that the A trigger holdoff time is set to 1.2  $\mu$ s.

## TRIGger:A:LEVel

Sets or queries the trigger level for the A trigger. This command is equivalent to adjusting the front-panel TRIGGER LEVEL knob.

---

**NOTE.** *When the edge trigger source is set to AC LINE, the instrument ignores the set form of the command.*

*When the edge trigger source is set to AC LINE, the query form of the command returns zero.*

---

**Group** Trigger

**Syntax** TRIGger:A:LEVel{ECL|TTL|<NR3>}  
TRIGger:A:LEVel?

**Arguments** <NR3> specifies the trigger level in user units (usually volts).  
ECL specifies a preset ECL high level of -1.3V.  
TTL specifies a preset TTL high level of 1.4V.

**Examples** TRIGGER:A:LEVEL TTL sets the A edge trigger to TTL high level, which is 1.4 V.  
TRIGger:A:LEVel? might return :TRIGGER:A:LEVel 1.3000E+00 indicating that the A edge trigger is set to 1.3 V.

## TRIGger:A:LEVel:CH<x>

Sets or queries the trigger level for the specified channel. Each channel can have an independent level.

<b>Group</b>	Trigger
<b>Syntax</b>	TRIGger:A:LEVel:CH<x> {<NR3> TTL ECL} TRIGger:A:LEVel:CH<x>?
<b>Arguments</b>	ECL specifies a preset ECL high level of -1.3V. TTL specifies a preset TTL high level of 1.4V. <NR3> specifies the trigger level in user units (usually volts).
<b>Examples</b>	TRIGGER:A:LEVEL:CH3 TTL sets the A edge trigger to TTL high level for channel 3. TRIGGER:A:LEVEL:CH2? might return :TRIGGER:A:LEVEL:CH2 1.3000E+00 indicating that the A edge trigger is set to 1.3 V for channel 2.

## TRIGger:A:LOWerthreshold:CH<x>

Sets or queries the lower threshold for the channel selected. Each channel can have an independent level. Used in Runt trigger as the lower threshold. Used for all other trigger types as the single level/threshold.

**Group** Trigger

**Syntax** TRIGger:A:LOWerthreshold:CH<x> {ECL|TTL|<NR3>}  
 TRIGger:A:LOWerthreshold:CH<x>?

**Related commands** [TRIGger:A:LEVel:CH<x>](#) on page 267

**Arguments** ECL specifies a preset ECL high level of -1.3 V.  
 TTL specifies a preset TTL high level of 1.4 V.  
 <NR3> is the clock level, in volts.

**Examples** TRIGGER:A:LOWERTHRESHOLD:CH2 50E-3 sets the lower limit threshold for CH2 of the pulse runt trigger to 50 mV.  
 TRIGGER:A:LOWERTHRESHOLD:CH2? might return :TRIGGER:A:LOWERTHRESHOLD:CH2 1.2000E-01 indicating that the lower limit threshold for CH2 of the pulse runt trigger is set to 120 mV.

## TRIGger:A:MODE

Sets or queries the trigger mode.

**Group** Trigger

**Syntax** TRIGger:A:MODE {AUTO|NORMal}  
 TRIGger:A:MODE?

**Related Commands** [TRIGger:A:LEVel](#) on page 266

- Arguments** AUTO generates a trigger if a trigger is not detected within a specific time period.  
NORMAL waits for a valid trigger event.
- Examples** TRIGger:A:MODENORMAL specifies that a valid trigger event must occur before a trigger is generated.  
TRIGGER:A:MODE ? might return :TRIGGER:A:MODE NORMAL indicating that a valid trigger event must occur before a trigger is generated.

## TRIGger:A:PULse?

Returns the current Pulse Trigger settings. Query only.

**Group** Trigger

**Syntax** TRIGger:A:PULse?

**Related commands** [TRIGger:A:EDGE?](#) on page 262

**Examples** TRIGger:A:PULse? might return :TRIGGER:A:PULSE:CLASS TRANSITION.

## TRIGger:A:PULse:CLAss

Sets or queries the type of pulse on which to trigger.

**Group** Trigger

**Syntax** TRIGger:A:PULse:CLAss {RUNt|WIDth}  
TRIGger:A:PULse:CLAss?

**Related commands** [TRIGger:A:RUNT?](#) on page 275, [TRIGger:A:PULSE:Width?](#) on page 271, [TRIGger:A:TYPE](#) on page 278

**Arguments** RUNt triggers when a pulse crosses the first preset voltage threshold but does not cross the second preset threshold before recrossing the first.  
WIDth triggers when a pulse is found that has the specified polarity and is either inside or outside the specified time limits.

**Examples** TRIGGER:A:PULSE:CLASS WIDTH specifies a width pulse for the A trigger.  
TRIGGER:A:PULSE:CLASS? might return :TRIGGER:A:PULSE:CLASS WIDTH indicating that a pulse was found that is of the specified polarity and width.



## TRIGger:A:PULSE:Width?

Queries the width for the pulse-width trigger. Query only.

<b>Group</b>	Trigger
<b>Syntax</b>	TRIGger:A:PULSEWidth?
<b>Examples</b>	TRIGger:A:PULSEWidth? might return :TRIGGER:A:PULSEWIDTH:POLARITY POSITIVE;WHEN LESSTHAN;WIDTH 8.0E-9

## TRIGger:A:PULse:WIDth:POLarity

Sets or queries the polarity for the pulse width trigger. This is equivalent to setting the Polarity option in the Pulse Trigger menu.

<b>Group</b>	Trigger
<b>Syntax</b>	TRIGger:A:PULse:WIDth:POLarity {NEGative POSitive} TRIGger:A:PULse:WIDth:POLarity?
<b>Arguments</b>	POSITIVE polarity specifies pulses with a rising leading edge. NEGATIVE polarity specifies pulses with a falling leading edge.
<b>Examples</b>	TRIGGER:A:PULSEWIDTH:POLARITY NEGATIVE sets the pulse polarity to negative. TRIGGER:A:PULSEWIDTH:POLARITY? might return :TRIGGER:A:WIDTH:POLARITY POSITIVE indicating a positive pulse.

## TRIGger:A:PULSEWidth:SOUrce

Sets or queries the source for the pulse width trigger. This is equivalent to setting the Source option in the Trigger menu.

**Group** Trigger

**Syntax** TRIGger:A:PULse:SOUrce {CH1|CH2|CH3|CH4| LINE}  
TRIGger:A:PULse:SOUrce?

**Arguments** CH<x> specifies one of the analog input channels. The value of <x> can be 1 through 4 on four channel instruments, or 1 or 2 on two channel instruments.  
LINE specifies AC line voltage.

**Examples** TRIGGER:A:PULSEWIDTH:SOURCE CH1 sets channel 1 as the pulse width source.  
TRIGGER:A:PULSEWIDTH:SOURCE? might  
return :TRIGGER:A:PULSEWIDTH:SOURCE CH1 indicating that channel 1 is the pulse width source.

## TRIGger:A:PULse:WIDth:WHEN

Sets or queries whether to trigger on a pulse that meets, falls outside, or within the specified range of limits. This is equivalent to setting the When option in the Pulse Trigger menu.

**Group** Trigger

---

**Syntax** TRIGger:A:PULse:WIDth:WHEN {LESSthan|MOREthan|EQUAL|UNEQUAL}  
TRIGger:A:PULse:WIDth:WHEN?

**Related commands** [TRIGger:A:PULse:WIDth:WIDth](#) on page 274

**Arguments** LESSthan sets the instrument to trigger if a pulse is detected with width less than the time set by the TRIGger:A:PULSEWidth:WIDth command.

MOREthan sets the instrument to trigger if a pulse is detected with width more than the time set by the TRIGger:A:PULSEWidth:WIDth command.

EQUAL sets the instrument to trigger if a pulse is detected with width equal to the time period specified in TRIGger:A:PULSEWidth:WIDth within a  $\pm 5\%$  tolerance.

UNEQUAL sets the instrument to trigger if a pulse is detected with width greater than or less than (but not equal) the time period specified in TRIGger:A:PULSEWidth:WIDth within a  $\pm 5\%$  tolerance.

**Examples** TRIGGER:A:PULSEWIDTH:WHEN LESSTHAN specifies that the duration of the A pulse will fall within defined high and low limits.

TRIGGER:A:PULSEWIDTH:WHEN? might return :TRIGGER:A:PULSEWIDTH:WHEN LESSTHAN indicating that the conditions for generating a width trigger.

## TRIGger:A:PULse:WIDth:WIDth

Sets or queries the width setting for the pulse width trigger. This is equivalent to setting the Width option by using the Pulse Trigger menu and the TRIGGER knob.

**Group** Trigger

**Syntax** TRIGger:A:PULse:WIDth:WIDth <NR3>  
TRIGger:A:PULse:WIDth:WIDth?

**Related commands** [TRIGger:A:PULse:WIDth:WHEN](#) on page 272

**Arguments** <NR3> specifies the pulse width, in seconds.

**Examples** TRIGGER:A:PULSEWIDTH:WIDTH 5.0E-6 sets the pulse width to 5  $\mu$ s.  
TRIGGER:A:PULSEWIDTH:WIDTH? might  
return :TRIGGER:A:PULSEWIDTH:WIDTH 2.0000E-9 indicating that the  
pulse width is set to 2 ns.

## TRIGger:A:RUNT?

Returns the current A runt trigger parameters. Query only.

**Group** Trigger

**Syntax** TRIGger:A:RUNT?

**Examples** TRIGGER:A:RUNT? might return :TRIGGER:A:RUNT:SOURCE  
CH1;POLARITY POSITIVE;WHEN OCCURS;WIDTH 4.0000E-9.

## TRIGger:A:RUNT:POLarity

Sets or queries the polarity for the runt trigger.

**Group** Trigger

**Syntax** TRIGger:A:RUNT:POLarity {NEGative|POSitive}  
TRIGger:A:RUNT:POLarity?

**Arguments** POSitive indicates that the rising edge crosses the low threshold and the falling edge recrosses the low threshold without either edge ever crossing the high threshold.

NEGative indicates that the falling edge crosses the high threshold and the rising edge recrosses the high threshold without either edge ever crossing the low threshold.

**Examples** TRIGGER:A:RUNT:POLARITY NEGATIVE specifies that the polarity of the A pulse runt trigger is negative.  
TRIGGER:A:RUNT:POLARITY? might return :TRIGGER:A:RUNT:POLARITY POSITIVE indicating that the polarity of the A pulse runt trigger is positive.

## TRIGger:A:RUNT:SOUrce

Sets or queries the source for the A runt trigger.

**Group** Trigger

**Syntax** TRIGger:A:RUNT:SOUrce {CH1|CH2|CH3|CH4}

**Arguments** CH1-CH4 specifies an analog input channel as the trigger source.

**Examples** TRIGGER:A:RUNT:SOURCE CH4 sets channel 4 as the source for the A pulse trigger.  
TRIGGER:A:RUNT:SOURCE? might return :TRIGGER:A:RUNT:SOURCE CH2 indicating that channel 2 is the source for the A pulse trigger.

## TRIGger:A:RUNT:WHEn

Sets or queries the type of pulse width the trigger checks for when it detects a runt.

**Group** Trigger

**Syntax** TRIGger:A:RUNT:WHEn {LESSthan|MOREthan|EQUAL|UNEQUAL|OCCURS}  
TRIGger:A:RUNT:WHEn?

**Related commands** [TRIGger:A:RUNT:WIDth](#) on page 278

**Arguments** OCCURS specifies a trigger event if a runt of any detectable width occurs.

LESSthan sets the instrument to trigger if a runt pulse is detected with a width less than the time set by the TRIGger:A:RUNT:WIDth command.

MOREthan sets the instrument to trigger if a runt pulse is detected with a width more than the time set by the TRIGger:A:RUNT:WIDth command.

EQUAL sets the instrument to trigger if a runt pulse is detected with a width equal to the time period specified in TRIGger:A:RUNT:WIDth within a  $\pm 5\%$  tolerance.

UNEQUAL sets the instrument to trigger if a runt pulse is detected with a width greater than or less than (but not equal to) the time period specified in TRIGger:A:RUNT:WIDth within a  $\pm 5\%$  tolerance.

**Examples** TRIGGER:A:RUNT:WHEn THAN sets the runt trigger to occur when the instrument detects a runt in a pulse wider than the specified width.

TRIGGER:A:RUNT:WHEn? might return :TRIGGER:A:PULSE:RUNT:WHEn OCCURS indicating that a runt trigger will occur if the instrument detects a runt of any detectable width.

## TRIGger:A:RUNT:WIDth

Sets or queries the width for a runt trigger.

**Group** Trigger

**Syntax** TRIGger:A:RUNT:WIDth <NR3>  
TRIGger:A:RUNT:WIDth?

**Related commands** [TRIGger:A:RUNT:WHEn](#) on page 277

**Arguments** <NR3> specifies the minimum width, in seconds.

**Examples** TRIGGER:A:RUNT:WIDTH 15E-6 sets the minimum pulse width of the runt trigger to 15  $\mu$ s.

TRIGGER:A:RUNT:WIDTH? might  
return :TRIGGER:A:PULSE:RUNT:WIDTH 2.0000E-09 indicating that the  
minimum pulse width of a runt trigger is 2 ns.

## TRIGger:A:TYPE

Sets or queries the type of A trigger. This is equivalent to setting the Type option in the Trigger menu.

**Group** Trigger



**Syntax** TRIGger:A:TYPe{EDGE|PULSe}  
TRIGger:A:TYPe?

**Related commands** [TRIGger:A:EDGE?](#) on page 262, [TRIGger:A:PULse:CLass](#) on page 270

**Arguments** EDGE is a normal trigger. A trigger event occurs when a signal passes through a specified voltage level in the specified direction and is controlled by the TRIGger:A:EDGE commands.

PULse specifies that a trigger occurs when the specified signal meets the pulse width criteria that is controlled by the TRIGger: A:PULse commands.

**Examples** TRIGGER:A:TYPE EDGE sets the A trigger type to EDGE.  
TRIGGER:A:TYPE? might return :TRIGGER:A:TYPE PULSE indicating that the A trigger type is a pulse trigger.

## TRIGger:A:UPPerthreshold:CH<x>

Sets or queries the upper threshold for channel <x>, where x is the channel number. Each channel can have an independent level. Used only for runt trigger type.

**Group** Trigger

**Syntax** TRIGger:A:UPPerthreshold:CH<x> {<NR3>|ECL|TTL}  
TRIGger:A:UPPerthreshold:CH<x>?

**Arguments** <NR3> is the threshold level in volts.  
ECL specifies a preset ECL high level of -1.3 V.  
TTL specifies a preset TTL high level of 1.4 V.

**Examples** TRIGGER:A:UPPERTHRESHOLD:CH2 50E-3 sets the upper limit of the pulse runt trigger to 50 mV for channel 2.  
TRIGGER:A:UPPERTHRESHOLD:CH2? might return :TRIGGER:A:UPPERTHRESHOLD:CH2 1.2000E-01 indicating that the upper limit of the pulse runt trigger is set to 120 mV.

## TRIGger:FREQuency?

Returns the edge or pulse width trigger frequency. This is the same as the readout in the lower right corner of the screen. Query only.

**Group** Trigger

**Syntax** TRIGger:FREQuency?

**Returns** Edge or pulse width trigger frequency.

**Examples** TRIGger:FREQuency? might return TRIGGER:FREQUENCY 1.0E3.

## TRIGger:STATE?

Returns the current state of the triggering system. Query only.

**Group** Trigger

**Syntax** TRIGger:STATE?

**Related commands**    *TRIGger:A:MODE* on page 268

**Returns**    ARMED indicates that the instrument is acquiring pretrigger information. All triggers are ignored when TRIGger:STATE is ARMed.

      AUTO indicates that the instrument is in the automatic mode and acquires data even in the absence of a trigger.

      READY indicates that all pretrigger information has been acquired and that the instrument is ready to accept a trigger.

      SAVE indicates that the instrument is in save mode and is not acquiring data.

      TRIGGER indicates that the instrument triggered and is acquiring the post trigger information.

**Examples**    TRIGGER:STATE? might return :TRIGGER:STATE ARMED indicating that the pretrigger data is being acquired.



---

## U commands

This section lists commands and queries that begin with the letter U.

### UNLock

Unlocks the front panel. This command is equivalent to LOCK NONE. Command only, no query form.

**Group** Miscellaneous

**Syntax** UNLock ALL

**Related commands** [LOCK](#) on page 170

**Arguments** ALL specifies all front-panel buttons.

**Examples** UNLock ALL unlocks all front-panel buttons and knobs so they can be used.



---

# V commands

This section lists commands and queries that begin with the letter V.

## VERBose

Sets and queries the Verbose state that controls the length of keywords on query responses. Keywords can be both headers and arguments. This command does not affect IEEE Std 488.2-1987 Common Commands (those starting with an asterisk).

**Group** Miscellaneous

**Syntax** VERBose  
VERBose?

**Related Commands** [HEADer](#) on page 147, [\\*LRN?](#) on page 170

**Arguments** ON or <NR1> ≠ 0 sets the Verbose state true, which returns full-length keywords for applicable setting queries.  
OFF or <NR1> = 0 sets the Verbose state false, which returns minimum-length keywords for applicable setting queries.

**Examples** VERBoseON sets the Verbose state true.  
VERBose? might return the value 1, showing that the Verbose state is true.





---

## W commands

This section lists commands and queries that begin with the letter W.

### \*WAI

Prevents the instrument from executing further commands or queries until all pending commands that generate an OPC message are complete. This command allows you to synchronize the operation of the instrument with your application program. Command only, no query form.

The \*WAI command will stop execution until certain instrument operations are complete. See [Table 34: Instrument operations that can generate OPC](#) on page 322.

**Group** Status and Error

**Syntax** \*WAI

**Related Commands** [BUSY?](#) on page 55, [\\*OPC](#) on page 213

**Examples** \*WAI prevents the instrument from executing any further commands or queries until all pending commands that generate an OPC message are complete.

## WAVFrm?

Returns WFMOutpre? and CURVe? data for the waveform as specified by the DATA:SOURce command. This command is equivalent to sending both WFMOutpre? and CURVe?, with the additional provision that the response to WAVFrm? is guaranteed to provide a synchronized preamble and curve. The source waveform, as specified by :DATA:SOURCE, must be active or the query will not return any data and will generate an error indicator. Query only.

**Group**      Waveform

**Syntax**     WAVFrm?

**Related Commands**    [CURVe](#) on page 92, [DATA:SOURce](#) on page 97, [WFMOutpre?](#) on page 298

**Returns**       See WFMPre? and CURVe? commands.

## WFMinpre?

Returns the waveform formatting and scaling specifications to be applied to the next incoming CURVe command data. Query only.

**Group**       Waveform

**Syntax**     WFMinpre?

**Related commands**    [CURVe](#) on page 92, [DATA:SOURce](#) on page 97, [WFMOutpre?](#) on page 298

**Returns** Returns the response in the following format:  
 WFMPre:<wfm>;WFID <Qstring>;PT\_FMT { ENV | Y }; XINcr  
 <NR3>;PT\_Off <NR1>;XZZero <NR3>;XUNit <QString>; YMULT  
 <NR3>;YZZero <NR3>;YOFF <NR3>;YUNit <QString>; NR\_Pt <NR1>

**Examples** WFMINPRE? might return the waveform formatting  
 as :WFMINPRE:BIT\_NR8;BN\_FMT RI;BYT\_NR 1; BYT\_OR MSB;ENCDG  
 BIN;NR\_PT 500;PT\_FMTY; PT\_OFF 0;XINCR 2.0000E-6;XZERO 1.7536E-6;  
 XUNIT "s";YMULT 1.0000E-3;YOFF 0.0000; YZERO 0.0000;YUNIT "V".

## WFMInpre:BIT\_Nr

Sets or returns the number of bits per binary waveform point for the incoming waveform. Changing the value of WFMInpre:BIT\_Nr also changes the value of WFMInpre:BYT\_Nr.

**Group** Waveform

**Syntax** WFMInpre:BIT\_Nr  
 WFMInpre:BIT\_Nr?

**Arguments** <NR1> is either 8 or 16.

**Examples** WFMINPRE:BIT\_NR 16 sets the number of bits per waveform point to 16, for incoming data.

WFMINPRE:BIT\_NR? might return :WFMINPRE:BIT\_NR 8 indicating that incoming waveform data uses 8 bits per waveform point.

## WFMinpre:BYT\_Nr

Sets or queries the data width for the incoming waveform. Changing the value of WFMinpre:BYT\_Nr also changes the value of WFMinpre:BIT\_Nr.

**Group** Waveform

**Syntax** WFMinpre:BYT\_Nr  
WFMinpre:BYT\_Nr?

**Arguments** <NR1> is an integer in the range of 1 to 2 that sets the number of bytes per point.

**Examples** WFMINPRE:BYT\_NR 1 sets the number of bytes per incoming waveform data point to 1, which is the default setting.  
WFMINPRE:BYT\_NR? might return :WFMINPRE:BYT\_NR 2 indicating that there are 2 bytes per incoming waveform data point.

## WFMinpre:ENCdg

Sets or queries the type of encoding for waveform data transferred with the CURVe command.

**Group** Waveform

**Syntax** WFMinpre:ENCdg {ASCIi|BINary}  
WFMinpre:ENCdg?

- Arguments**    *ASCIi* specifies ASCII curve data.  
*BINary* specifies that the incoming data is in a binary format whose further interpretation requires knowledge of *BYT\_NR*, *BIT\_NR*, *BN\_FMT*, and *BYT\_OR*.
- Examples**    *WFMINPre:ENCdgASC* specifies that the waveform data is in ASCII format.  
*WFMINPre:ENCdg?* might return *:WFMINPRE:ENCDG BIN*, indicating that the waveform data is in binary format.

## WFMINpre:NR\_Pt?

Returns the number of points that are in the incoming waveform record.

**Group**    *Waveform*

**Syntax**    *WFMINpre:NR\_Pt <NR1>*  
*WFMINpre:NR\_Pt?*

**Related Commands**    *CURVe* on page 92, *DATA* on page 95, *DATA:START* on page 98, *DATA:STOP* on page 99, *SAVE:WAVEform* on page 230, *SAVE:WAVEform:FILEFormat* on page 231, *WFMINpre:NR\_Pt?* on page 291

**Arguments**    *<NR1>* is the number of data points if *WFMINpre:PT\_Fmt* is set to *Y*. It is the number of min-max pairs if *WFMINpre:PT\_Fmt* is set to *ENV*.

**Examples**    *WFMINPRE:NR\_PT 10000* specifies that 10000 data points will be expected.  
*WFMINPRE:NR\_PT ?* might return *:WFMINPRE:NR\_PT 10000* indicating that there are 10000 data points in the expected incoming waveform record.

## WFMinpre:XINcr

Sets or queries the horizontal interval between incoming waveform points in units specified by WFMinpre:XUNit.

**Group** Waveform

**Syntax** WFMinpre:XINcr <NR3>  
WFMinpre:XINcr?

**Arguments** <NR3> is the interval between points in the waveform record, in the units specified by WFMinpre:XUNit.

**Examples** WFMINPRE:XINCR 3E-3 sets the interval between incoming waveform points to 3 ms.

WFMINPRE:XINCR ? might return :WFMINPRE:XINCR 1.0000E-3 indicating that if WFMinpre:XUNit is set to "s", there is a 1 ms interval between incoming waveform points.

## WFMinpre:XUNit

Sets or queries the horizontal units of the incoming waveform.

**Group** Waveform

**Syntax** WFMinpre:XUNit <Qstring>  
WFMinpre:XUNit?

**Related commands** [WFMOutpre:XUNit?](#) on page 304

**Arguments** <Qstring> contains a maximum of three alpha characters that represent the horizontal unit of measure for the incoming waveform.

**Examples** WFMINPRE:XUNIT "HZ" specifies that the horizontal units for the incoming waveform are hertz.

WFMINPRE:XUNIT? might return :WFMINPRE:XUNIT "s" indicating that the horizontal units for the incoming waveform are seconds.

## WFMINpre:XZEro

Sets or queries the position value, in XUNits, of the first sample of the incoming waveform, relative to the trigger.

The instrument sets WFMPre:XZEro to zero when:

- The display mode is set to XY.
- The DATA:SOURce is set to MATH FFT when the waveform is acquired.

---

**NOTE.** *The instrument uses XZEro when calculating cursor readouts.*

---

**Group** Waveform

**Syntax** WFMINpre:XZEro <NR3>  
WFMINpre:XZEro?

**Related commands** [WFMINpre:XINcr](#) on page 292, [WFMINpre:BYT\\_Nr](#) on page 290, [WFMOutpre:XZEro?](#) on page 305

**Arguments** <NR3> argument is the floating point value of the position, in XUNits, of the first sample in the incoming waveform. If XUNits is "s", <NR3> is the time of the first sample in the incoming waveform.

**Examples** WFMINPRE:XZERO 5.7E-6 indicates the trigger occurred 5.7  $\mu$ s before the first sample in the waveform.

WFMINPRE:XZERO? might return :WFMINPRE:XZerO -7.5000E-6 indicating that the trigger occurs 7.5  $\mu$ s after the first sample in the waveform.

## WFMinpre:YMUlt

Sets or queries the vertical scale factor of the incoming waveform, expressed in YUNits per waveform data point level. For one byte waveform data, there are 256 data point levels. For two byte waveform data there are 65,536 data point levels. YMUlt, YOFF, and YZerO are used to convert waveform record values to YUNit values using the following formula (where dl is the data level; curve\_in\_dl is a data point in CURVe): value\_in\_units = ((curve\_in\_dl - YOFF\_in\_dl) \* YMUlt) + YZerO\_in\_units.

**Group** Waveform

**Syntax** WFMinpre:YMUlt <NR3>  
WFMinpre:YMUlt?

**Related commands** [DATA:DESTination](#) on page 96, [WFMinpre:BYT\\_Nr](#) on page 290, [WFMinpre:YUNit](#) on page 296

**Arguments** <NR3> is the vertical scale factor per digitizing level of the incoming waveform points.



**Examples** WFMINPRE:YMULT? might return :WFMINPRE:YMULT 40.0000E-3, which (if YUNIT is "V") indicates that the vertical scale is 40 mV/digitizing level (1V/div for 8-bit data).

## WFMInpre:YOFF

Sets or queries the vertical position of the incoming waveform in digitizing levels. Variations in this number are analogous to changing the vertical position of the waveform.

**Group** Waveform

**Syntax** WFMInpre:YOFF <NR3>  
WFMInpre:YOFF?

**Arguments** <NR3> is a value expressed in digitizing levels.

**Examples** WFMINPRE:YOFF 50 specifies that the zero reference point for the incoming waveform is 50 digitizing levels (2 divisions, for 8-bit data) above the center of the data range.  
WFMINPRE:YOFF? might return :WFMINPRE:YOFF 25 indicating the vertical position of the incoming waveform in digitizing levels.

## WFMinpre:YUNit

Sets or returns the vertical units of the incoming waveform.

**Group** Waveform

**Syntax** WFMinpre:YUNit <Qstring>  
WFMinpre:YUNit?

**Arguments** <Qstring> contains a maximum of three alpha characters that represent the vertical unit of measure for the incoming waveform.

**Returns** The query may return the following:

- Volts for volts
- U for unknown units (divisions)
- dB for decibels
- ? for unknown mask waveforms units
- A for amperes
- VA for volt × amperes
- AA for amperes × amperes
- VV for volts × volts

**Examples** WFMINPRE:YUNIT "A" specifies that the vertical units for the incoming waveform are Amperes.

WFMINPRE:YUNIT? might return :WFMINPRE:YUNIT "V" indicating that the vertical units for the incoming waveform are volts.

## WFMInpre:YZEro

Sets or returns the vertical offset of the incoming waveform in units specified by WFMInpre:YUNit. Variations in this number are analogous to changing the vertical offset of the waveform.

**Group** Waveform

**Syntax** WFMInpre:YZEro <NR3>  
WFMInpre:YZEro?

**Related commands** [WFMInpre:YUNit](#) on page 296, [WFMOutpre:YZEro?](#) on page 308

**Arguments** <NR3> is offset, expressed in YUNits.

**Examples** WFMINPRE:YZERO 1.5E+0 specifies that the zero reference point for the incoming waveform is 1.5 V below the center of the data range (given that WFMInpre:YUNit is set to V).  
WFMINPRE:YZERO? might return :WFMINPRE:YZEro 7.5000E-6 indicating that the zero reference for the incoming waveform is 7.5  $\mu$ V below the center of the data range (given that WFMInpre:YUNit is set to V).

## WFMOutpre?

Returns waveform transmission and formatting settings for the waveform specified by the DATA:SOURCE command. Query only.

If the waveform specified by the DATA:SOURCE command is not displayed, the instrument returns only the waveform transmission parameters (BYT\_Nr, BIT\_Nr, ENCDg, BN\_Fmt, BYT\_Or).

**Group** Waveform

**Syntax** WFMOutpre?

**Examples** WFMOUTPRE? might return the waveform formatting data as:

```
:WFMOUTPRE:BYT_NR 2;BIT_NR 16;ENCDG ASCII;BN_FMT  
RI;BYT_ORMSB;WFID "Ch1, DC coupling, 100.0mV/div, 4.000us/div,  
10000 points, Sample mode";NR_PT 10000;PT_FMT Y;XUNIT "s";XINCR  
4.0000E-9;XZERO - 20.0000E-6;PT_OFF 0;YUNIT "V";YMULT  
15.6250E-6;YOFF : "6.4000E+3;YZERO 0.0000.
```

## WFMOutpre:BIT\_Nr

Sets and queries the number of bits per waveform point that outgoing waveforms contain, as specified by the DATA:SOURCE command. Changing the value of WFMOutpre:BIT\_Nr also changes the values of WFMInpre:FILTERFreq and DATA:WIDTH.

**Group** Waveform

**Syntax** WFMOutpre:BIT\_Nr <NR1>  
WFMOutpre:BIT\_Nr?

**Related commands** *DATA:SOURce* on page 97, *DATA:WIDth* on page 100

**Arguments** <NR1> is the number of bits per data point and can be 8 or 16.

**Examples** WFMOUTPRE:BIT\_NR 16 sets the number of bits per waveform point to 16 for outgoing waveforms.  
WFMOUTPRE:BIT\_NR? might return :WFMOUTPRE:BIT\_NR 8 indicating that outgoing waveforms use 8 bits per waveform point.

## WFMOutpre:BN\_Fmt

Sets or returns the format of binary data for outgoing waveforms specified by the DATA:SOURce command. Changing the value of WFMOutpre:BN\_Fmt also changes the value of DATA:ENCdg.

**Group** Waveform

**Syntax** WFMOutpre:BN\_Fmt {RI|RP}  
WFMOutpre:BN\_Fmt?

**Arguments** RI specifies signed integer data point representation.  
RP specifies positive integer data point representation.

- Examples** WFMOUTPRE:BN\_FMT RP specifies that outgoing waveform data will be in positive integer format.
- WFMOUTPRE:BN\_FMT? might return :WFMOUTPRE:BN\_FMT RI indicating that the outgoing waveform data is currently in signed integer format.

## WFMOutpre:BYT\_Nr

Sets or queries the data width for the outgoing waveform specified by the DATA:SOURce command. Changing WFMOutpre:BYT\_Nr also changes WFMOutpre:BIT\_Nr and DATA:WIDth.

**Group** Waveform

**Syntax** WFMOutpre:BYT\_Nr <NR1>  
WFMOutpre:BYT\_Nr?

**Related commands** [DATA:SOURce](#) on page 97, [DATA:WIDth](#) on page 100, [WFMOutpre:BIT\\_Nr](#) on page 298

**Arguments** <NR1> is the number of bytes per data point and can be 1 or 2.

- Examples** WFMOUTPRE:BYT\_NR 1 sets the number of bytes per outgoing waveform data point to 1, which is the default setting.
- WFMOUTPRE:BYT\_NR? might return :WFMOUTPRE:BYT\_NR 2 indicating that there are 2 bytes per outgoing waveform data point.

## WFMOutpre:ENCdg

Sets and queries the type of encoding for outgoing waveforms.

**Group** Waveform

**Syntax** WFMOutpre:ENCdg {ASCIi|BINary}  
WFMOutpre:ENCdg?

**Related commands** [WFMOutpre:BYT\\_Nr](#) on page 300, [WFMOutpre:BIT\\_Nr](#) on page 298

**Arguments** ASCIi specifies that the outgoing data is to be in ASCII format. Waveforms will be sent as <NR1> numbers.

BINary specifies that outgoing data is to be in a binary format whose further specification is determined by WFMOutpre:BYT\_Nr, WFMOutpre:BIT\_Nr, WFMOutpre:BN\_Fmt and WFMinpre:FILTERFreq.

**Examples** WFMOutpre:ENCdg ASCIi sets the encoding to ASCII.  
WFMOutpre:ENCdg? might return WFMOutpre:ENCdg BINARY indicating the encoding is set to binary.

## WFMOutpre:NR\_Pt?

Returns the number of points for the DATA:SOURce waveform that will be transmitted in response to a CURVe? query. The query command will timeout and an error will be generated if the waveform specified by DATA:SOURce is not turned on. Query only.

**Group** Waveform

**Syntax** WFMOutpre:NR\_Pt?

**Related commands** [CURVe](#) on page 92, [DATA](#) on page 95, [DATA:START](#) on page 98, [DATA:STOP](#) on page 99, [SAVE:WAVEform](#) on page 230, [SAVE:WAVEform:FILEFormat](#) on page 231, [WFMinpre:NR\\_Pt?](#) on page 291

**Examples** WFMOUTPRE:NR\_PT? might return :WFMOUTPRE:NR\_PT 10000 indicating that there are 10000 data points to be sent.

## WFMOutpre:RECOrdlength?

Returns the record length for the source waveform as specified by the DATA:SOURce command. Query only.

**Group** Waveform

**Syntax** WFMOutpre:RECOrdlength?



**Examples** WFMOUTPRE:RECORDLENGTH? might return :WFMOUTPRE:RECORDLENGTH 2000 indicating that 2000 is the source waveform record length.

## WFMOutpre:WFId?

Returns a string describing several aspects of the acquisition parameters for the waveform specified by the DATA:SOURce command. The query command will time out and an error will be generated if the waveform specified by DATA:SOURce is not turned on. Query only.

**Group** Waveform

**Syntax** WFMOutpre:WFId?

**Related commands** [DATA:SOURce](#) on page 97

**Returns** <QString> comprises the following comma-separated fields:

Source The source identification string as it appears in the front-panel scale factor readouts.

Coupling A string describing the vertical coupling of the waveform.

Vert Scale A string containing the vertical scale factor of the unzoomed waveform. The numeric portion will always be four digits. The examples cover all known internal units.

Horiz Scale A string containing the horizontal scale factor of the unzoomed waveform. The numeric portion will always be four digits. The examples cover all known internal units.

Record Length A string containing the number of waveform points available in the entire record. The numeric portion is given as an integer.

Acquisition Mode A string describing the mode used to acquire the waveform.

**Examples** WFMOUTPRE:WFID? might return :WFMOUTPRE:WFID "Ch1, DC coupling, 100.0mVolts/div,500.0µs/div, 1000 points, Sample mode".

## WFMOutpre:XINcr?

Returns the horizontal point spacing in units of WFMOutpre:XUNit for the waveform specified by the DATA:SOURce command. This value corresponds to the sampling interval. The query command will time out and an error will be generated if the waveform specified by DATA:SOURce is not turned on. Query only.

**Group** Waveform

**Syntax** WFMOutpre:XINcr?

**Related commands** [DATA:SOURce](#) on page 97, [WFMOutpre:XUNit?](#) on page 304

**Examples** WFMOUTPRE:XINCR? might return :WFMOUTPRE:XINCR 10.0000E-6 indicating that the horizontal sampling interval is 10 µs/point.

## WFMOutpre:XUNit?

Returns the horizontal units for the waveform specified by the DATA:SOURce command. The query command will time out and an error will be generated if the waveform specified by DATA:SOURce is not turned on. Query only.

**Group** Waveform

**Syntax** WFMOutpre:XUNit?

**Related commands** [DATA:SOURce](#) on page 97

**Examples** WFMOUTPRE:XUNIT? might return :WFMOUTPRE:XUNIT "HZ" indicating that the horizontal units for the waveform are in Hertz.

## WFMOutpre:XZEro?

Returns the time coordinate of the first point in the outgoing waveform. This value is in units of WFMOutpre:XUNit?. The query command will time out and an error will be generated if the waveform specified by DATA:SOURce is not turned on. Query only.

**Group** Waveform

**Syntax** WFMOutpre:XZEro?

**Related commands** [DATA:SOURce](#) on page 97, [WFMOutpre:XUNit?](#) on page 304

**Examples** WFMOUTPRE:XZERO? might return :WFMOUTPRE:XZERO 5.6300E-9 indicating that the trigger occurred 5.63 ns before the first sample in the waveform record.

## WFMOutpre:YMUIt?

Returns the vertical scale factor per digitizing level in units specified by WFMOutpre:YUNit for the waveform specified by the Returns the vertical scale factor per digitizing level in units specified by WFMOutpre:YUNit for the waveform specified by the DATA:SOURce command. The query command will time out and an error is generated if the waveform specified by DATA:SOURce is not turned on. command. The query command will time out and an error is generated if the waveform specified by DATA:SOURce is not turned on. (Query Only)

**Group** Waveform

**Syntax** WFMOutpre:YMUIt?

**Related commands** [DATA:SOURce](#) on page 97, [WFMIInpre:YMUIt](#) on page 294

**Examples** WFMOUTPRE:YMULT? might return :WFMOUTPRE:YMULT 4.0000E-3 indicating that the vertical scale for the corresponding waveform is 100 mV/div (for 8-bit waveform data).

## WFMOutpre:YOFf?

Returns the vertical position in digitizing levels for the waveform specified by the DATA:SOURce command. The query command will time out and an error will be generated if the waveform specified by DATA:SOURce is not turned on. Query only.

**Group** Waveform

---

**Syntax** WFMOutpre:YOFF?

**Related commands** [DATA:SOURce](#) on page 97, [WFMOutpre:BYT\\_Nr](#) on page 300

**Examples** WFMOUTPRE:YOFF? might return :WFMOUTPRE:YOFF -50.0000E+0 indicating that the position indicator for the waveform was 50 digitizing levels (2 divisions) below center screen (for 8-bit waveform data).

## WFMOutpre:YUNit?

Returns the vertical units for the waveform specified by the DATA:SOURce command. The query command will time out and an error will be generated if the waveform specified by DATA:SOURce is not turned on. Query only.

**Group** Waveform

**Syntax** WFMOutpre:YUNit?

**Related commands** [DATA:SOURce](#) on page 97

**Examples** WFMOUTPRE:YUNIT? might return :WFMOUTPRE:YUNIT "dB" indicating that the vertical units for the waveform are measured in decibels.

## WFMOutpre:YZEro?

Returns the vertical offset in units specified by WFMOutpre:YUNit? for the waveform specified by the DATA:SOURce command. The query command will time out and an error will be generated if the waveform specified by DATA:SOURce is not turned on. Query only.

**Group** Waveform

**Syntax** WFMOutpre:YZEro?

**Related commands** [DATA:SOURce](#) on page 97, [WFMOutpre:YUNit?](#) on page 307

**Examples** WFMOUTPRE:YZERO? might return :WFMOUTPRE:YZERO -100.0000E-3 indicating that vertical offset is set to -100 mV.

---

## Z commands

This section lists commands and queries that begin with the letter Z.

### ZOOM?

Returns the current vertical and horizontal positioning and scaling of the display. Query only.

**Group** Zoom

**Syntax** ZOOM?

**Examples** ZOOM? might return :ZOOM:MODE 1; :ZOOM:ZOOM1:STATE 1;SCALE 20.0000E-9;POSITION 50.0000; FACTOR 10.0000; HORIZONTAL:POSITION 50.0000;SCALE 20.0000E-9.

### ZOOM{:MODE|:STATE}

Turns Zoom mode on or off. The Zoom mode query returns the current state of Zoom mode.

This command is equivalent to pressing the zoom button located on the front panel.

**Group** Zoom

**Syntax** ZOOM{:MODE|:STATE} {ON|OFF|<NR1>}  
ZOOM{:MODE|:STATE}?

**Arguments** ON turns on Zoom mode.  
OFF turns off Zoom mode.  
<NR1> = 0 turns off Zoom mode; any other value turns on Zoom mode.

**Examples** ZOOM:MODE OFF turns off Zoom mode.  
ZOOM:MODE? might return :ZOOM:MODE 1 indicating that Zoom mode is currently turned on.

## ZOOM:ZOOM1?

Returns the current horizontal positioning and scaling of the display. Query only.

**Group** Zoom

**Syntax** ZOOM:ZOOM1?

**Examples** ZOOM:ZOOM1? might return :ZOOM:ZOOM1:STATE 1;SCALE  
20.0000E-9;POSITION 50.0000;FACTOR 10.0000;HORIZONTAL:POSITION  
50.0000;SCALE 20.0000E-9.



## ZOOM:ZOOM1:FACtor

Queries the zoom factor of a particular zoom box. Query only.

**Group** Zoom

**Syntax** ZOOM:ZOOM1:FACtor?

**Returns** <NR1> is the zoom factor of a zoom box.

**Examples** ZOOM:ZOOM1:FACtor? might return :ZOOM:ZOOM1:FACtor X5 indicating that the specified zoom factor is X5 of the acquired waveform.

## ZOOM:ZOOM1:HORizontal:POSition

Sets or queries the horizontal position of a specified zoom box.

**Group** Zoom

**Syntax** ZOOM:ZOOM1:HORizontal:POSition <NR1>  
ZOOM:ZOOM1:HORizontal:POSition?

**Arguments** <NR1> is 1 to 100.00 and is the percent of the upper window that is to the left of the screen center, when the zoom factor is 1× or greater.

**Examples** ZOOM:ZOOM1:HORizontal:POSition 50.00 sets the zoom reference pointer at 50% of the acquired waveform.  
ZOOM:ZOOM1:HORIZONTAL:POSITION? might return :ZOOM1:HORIZONTAL:POSITION 50.00, indicating the reference pointer is at 50% of the acquired waveform.

## ZOOM:ZOOM1:HORizontal:SCALE

Sets or queries the zoom horizontal scale for the specified zoom.

**Group** Zoom

**Syntax** ZOOMm:ZOOM1:HORizontal:SCALE <NR3>  
ZOOMm:ZOOM1:HORizontal:SCALE?

**Arguments** <NR3> is the amount of expansion in the horizontal direction and ranges from 1.0E-9 to 100.0.

**Examples** ZOOM:ZOOM1:HORIZONTAL:SCALE 5 sets the horizontal scale to 5 seconds per division.  
ZOOM:ZOOM2:HORIZONTAL:SCALE? might return :ZOOM2:HORIZONTAL:SCALE 1, indicating that the horizontal scale is 1 second per division.

## ZOOm:ZOOM1:POSition

Sets or queries the horizontal position for the specified zoom.

**Group** Zoom

**Syntax** ZOOm:ZOOM1:POSition <NR3>  
ZOOm:ZOOM1:POSition?

**Arguments** <NR3> is a value from 0 to 100.00 and is the percent of the upper window that is to the left of screen center, when the zoom factor is 1× or greater

**Examples** ZOOm:ZOOM1:POSition 20 sets the percent of the upper window that is to the left of screen center to 20%.  
ZOOm:ZOOM1:POSition? might return :ZOOm:ZOOM1:POSition 25 indicating the percent of the upper window that is to the left of the screen center is 25%.

## ZOOm:ZOOM1:SCAle

Sets or queries the zoom horizontal scale for the specified zoom.

**Group** Zoom

**Syntax** ZOOm:ZOOM1:SCAle <NR3>  
ZOOm:ZOOM1:SCAle?

**Arguments** <NR3> is the amount of expansion in the horizontal direction and ranges from 1.0E-9 to 100.0.

**Examples** ZOOM:ZOOM1:SCALE 5.0 sets the horizontal expansion of the specified Zoom to 5.  
ZOOM:ZOOM1:SCALE? might return ZOOM:ZOOM1:SCALE 5.0 indicating the zoom1 horizontal expansion is set to 5.

## ZOOM:ZOOM1:STATE

Sets or queries the specified zoom on or off, where x is the integer representing the specified zoom window.

**Group** Zoom

**Syntax** ZOOM:ZOOM1:STATE {ON|OFF|<NR1>}  
ZOOM:ZOOM1:STATE?

**Arguments** ON turns the specified Zoom on.  
OFF turns the specified Zoom off.  
<NR1> = 0 disables the specified zoom; any other value enables the specified zoom

**Examples** ZOOM:ZOOM1:STATE ON turns Zoom1 on.  
ZOOM:ZOOM1:STATE? might return :ZOOM:ZOOM1:STATE 1 indicating that Zoom1 is on.

---

# Status and Events

The instrument provides a status and event reporting system for the GPIB, RS-232, and USB interfaces. This system informs you of certain significant events that occur within the instrument.

The instrument status reporting system consists of five 8-bit registers and two queues. This section describes these registers and components, and explains how the event handling system operates.

## Registers

- Overview** The registers in the event handling system fall into two functional groups:
- Status Registers contain information about the status of the instrument. They include the Standard Event Status Register (SESR).
  - Enable Registers determine whether selected types of events are reported to the Status Registers and the Event Queue. They include the Device Event Status Enable Register (DESER), the Event Status Enable Register (ESER), and the Service Request Enable Register (SRER).

**Status Registers** The Standard Event Status Register (SESR) and the Status Byte Register (SBR) record certain types of events that may occur while the instrument is in use. IEEE Std 488.2-1987 defines these registers.

Each bit in a Status Register records a particular type of event, such as an execution error or message available. When an event of a given type occurs, the instrument sets the bit that represents that type of event to a value of one. (You can disable bits so that they ignore events and remain at zero. See Enable Registers). Reading the status registers tells you what types of events have occurred.

**The Standard Event Status Register (SESR).** The SESR records eight types of events that can occur within the instrument. Use the \*ESR? query to read the SESR register. Reading the register clears the bits of the register so that the register can accumulate information about new events.

7	6	5	4	3	2	1	0
PON	URQ	CME	EXE	DDE	QYE	RQC	OPC

**Figure 3: The Standard Event Status Register (SESR)**

**Table 32: SESR bit functions**

Bit	Function	
7 (MSB)	PON	Power On. Shows that the instrument was powered on. On completion, the diagnostic self tests also set this bit.
6	URQ	User Request. Indicates that an application event has occurred. *See note.
5	CME	Command Error. Shows that an error occurred while the instrument was parsing a command or query.
4	EXE	Execution Error. Shows that an error executing a command or query.
3	DDE	Device Error. Shows that a device error occurred.
2	QYE	Query Error. Either an attempt was made to read the Output Queue when no data was present or pending, or that data in the Output Queue was lost.
1	RQC	Request Control. This is not used.
0 (LSB)	OPC	Operation Complete. Shows that the operation is complete. This bit is set when all pending operations complete following an *OPC command.

**The Status Byte Register (SBR).** Records whether output is available in the Output Queue, whether the instrument requests service, and whether the SESR has recorded any events.

Use a Serial Poll or the \*STB? query to read the contents of the SBR. The bits in the SBR are set and cleared depending on the contents of the SESR, the Event Status Enable Register (ESER), and the Output Queue. When you use a Serial Poll to obtain the SBR, bit 6 is the RQS bit. When you use the \*STB? query to obtain the SBR, bit 6 is the MSS bit. Reading the SBR does not clear the bits.

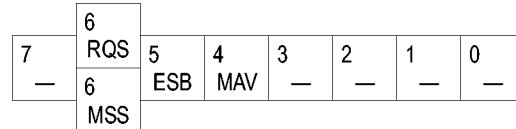

**Figure 4: The Status Byte Register (SBR)**

**Table 33: SBR bit functions**

Bit	Function	
7 (MSB)	-----	Not used.
6	RQS	Request Service. Obtained from a serial poll. Shows that the instrument requests service from the GPIB controller.
6	MSS	Master Status Summary. Obtained from *STB? query. Summarizes the ESB and MAV bits in the SBR.
5	ESB	Event Status Bit. Shows that status is enabled and present in the SESR.
4	MAV	Message Available. Shows that output is available in the Output Queue.
3	-----	Not used.
2	-----	Not used.
1-0	-----	Not used.

### Enable Registers

DESER, ESER, and SRER allow you to select which events are reported to the Status Registers and the Event Queue. Each Enable Register acts as a filter to a Status Register (the DESER also acts as a filter to the Event Queue) and can prevent information from being recorded in the register or queue.

Each bit in an Enable Register corresponds to a bit in the Status Register it controls. In order for an event to be reported to a bit in the Status Register, the corresponding bit in the Enable Register must be set to one. If the bit in the Enable Register is set to zero, the event is not recorded.

Various commands set the bits in the Enable Registers. The Enable Registers and the commands used to set them are described below.

**The Device Event Status Enable Register (DESER).** This register controls which types of events are reported to the SESR and the Event Queue. The bits in the DESER correspond to those in the SESR.

Use the DESE command to enable and disable the bits in the DESER. Use the DESE? query to read the DESER.

7	6	5	4	3	2	1	0
PON	URQ	CME	EXE	DDE	QYE	RQC	OPC

Figure 5: The Device Event Status Enable Register (DESER)

**The Event Status Enable Register (ESER).** This register controls which types of events are summarized by the Event Status Bit (ESB) in the SBR. Use the \*ESE command to set the bits in the ESER. Use the \*ESE? query to read it.

7	6	5	4	3	2	1	0
PON	URQ	CME	EXE	DDE	QYE	RQC	OPC

Figure 6: The Event Status Enable Register (ESER)

**The Service Request Enable Register (SRER).** This register controls which bits in the SBR generate a Service Request and are summarized by the Master Status Summary (MSS) bit.

Use the \*SRE command to set the SRER. Use the \*SRE? query to read the register. The RQS bit remains set to one until either the Status Byte Register is read with a Serial Poll or the MSS bit changes back to a zero.

7	6	5	4	3	2	1	0
—	—	ESB	MAV	—	—	—	—

Figure 7: The Service Request Enable Register (SRER)



**\*PSC Command** The \*PSC command controls the Enable Registers contents at power-on. Sending \*PSC 1 sets the Enable Registers at power on as follows:

- DESER 255 (equivalent to a DESe 255 command)
- ESER 0 (equivalent to an \*ESE 0 command)
- SRER 0 (equivalent to an \*SRE 0 command)

Sending \*PSC 0 lets the Enable Registers maintain their values in nonvolatile memory through a power cycle.

---

**NOTE.** *To enable the PON (Power On) event to generate a Service Request, send \*PSC 0, use the DESe and \*ESE commands to enable PON in the DESER and ESER, and use the \*SRE command to enable bit 5 in the SRER. Subsequent power-on cycles will generate a Service Request.*

---

## Queues

The \*PSC command controls the Enable Registers contents at power-on. Sending \*PSC 1 sets the Enable Registers at power on as follows:

**Output Queue** The instrument stores query responses in the Output Queue and empties this queue each time it receives a new command or query message after an <EOM>. The controller must read a query response before it sends the next command (or query) or it will lose responses to earlier queries.



---

**CAUTION.** *When a controller sends a query, an <EOM>, and a second query, the instrument normally clears the first response and outputs the second while reporting a Query Error (QYE bit in the ESER) to indicate the lost response. A fast controller, however, may receive a part or all of the first response as well. To avoid this situation, the controller should always read the response immediately after sending any terminated query message or send a DCL (Device Clear) before sending the second query.*

---

**Event Queue** The Event Queue stores detailed information on up to 20 events. If than 20 events stack up in the Event Queue, the 20th event is replaced by event code 350, "Queue Overflow."

Read the Event Queue with the `EVENT?` query (which returns only the event number), with the `EVMSG?` query (which returns the event number and a text description of the event), or with the `ALLEV?` query (which returns all the event numbers with a description of the event). Reading an event removes it from the queue.

Before reading an event from the Event Queue, you must use the `*ESR?` query to read the summary of the event from the `SESR`. This makes the events summarized by the `*ESR?` read available to the `EVENT?` and `EVMSG?` queries, and empties the `SESR`.

Reading the `SESR` erases any events that were summarized by previous `*ESR?` reads but not read from the Event Queue. Events that follow an `*ESR?` read are put in the Event Queue but are not available until `*ESR?` is used again.

## Event Handling Sequence

The following figure shows how to use the status and event handling system. In the explanation that follows, numbers in parentheses refer to numbers in the figure.

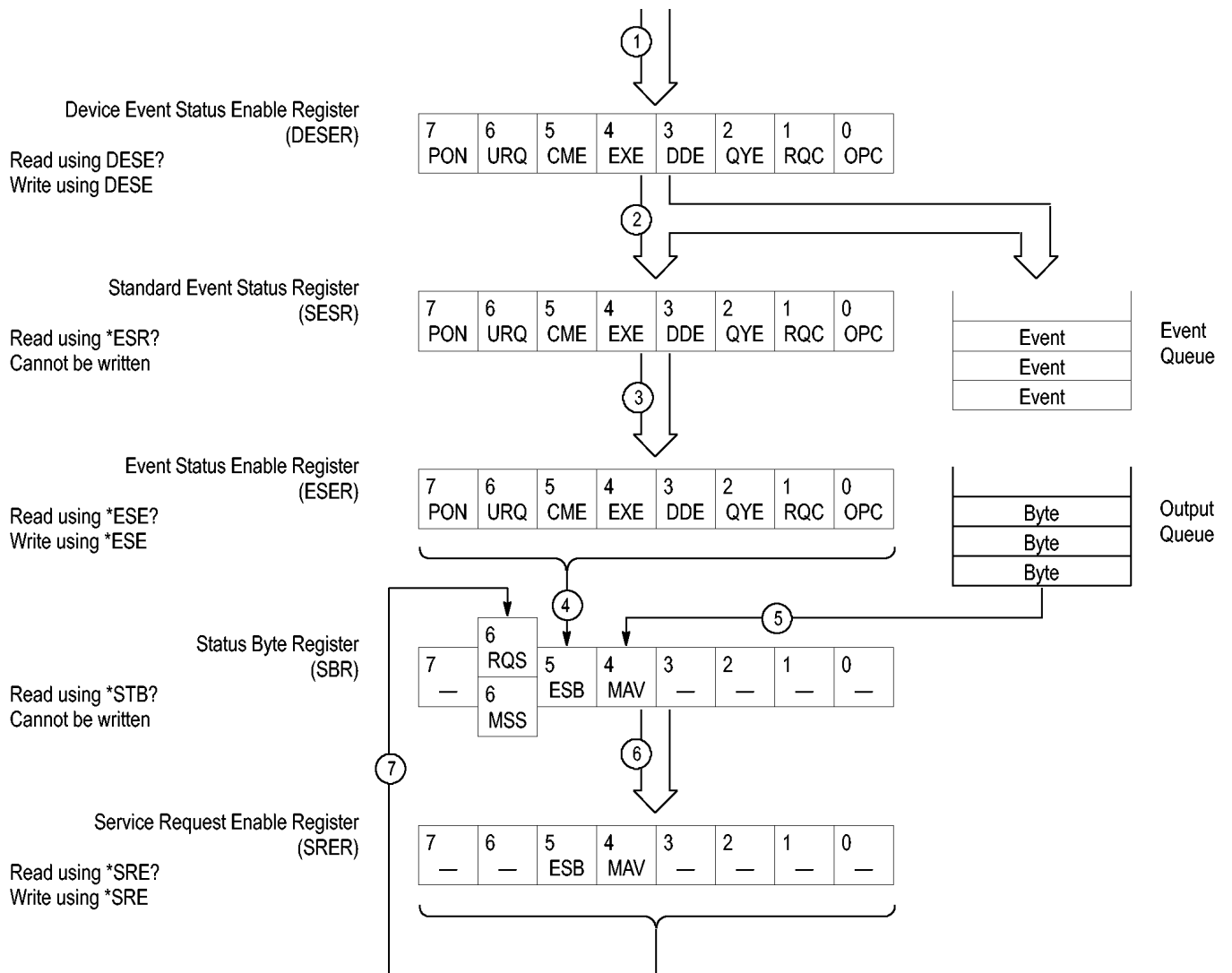

**Figure 8: Status and Event Handling Process**

When an event occurs, a signal is sent to the DESER (1). If that type of event is enabled in the DESER (that is, if the bit for that event type is set to 1), the appropriate bit in the SESR is set to one, and the event is recorded in the Event Queue (2). If the corresponding bit in the ESER is also enabled (3), then the ESB bit in the SBR is set to one (4).

When output is sent to the Output Queue, the MAV bit in the SBR is set to one (5).

When a bit in the SBR is set to one and the corresponding bit in the SRER is enabled (6), the MSS bit in the SBR is set to one and a service request is generated (7).

## Synchronization Methods

**Overview** Although most commands are completed almost immediately after being received by the instrument, some commands start a process that requires time. For example, once a single sequence acquisition command is executed, depending upon the applied signals and trigger settings, it may take an extended period of time before the acquisition is complete. Rather than remain idle while the operation is in process, the instrument will continue processing other commands. This means that some operations will not be completed in the order that they were sent.

Sometimes the result of an operation depends on the result of an earlier operation. A first operation must complete before the next one is processed. The instrument status and event reporting system is designed to accommodate this process.

The Operation Complete (OPC) bit of the Standard Event Status Register (SESR) can be programmed to indicate when certain instrument operations have completed and, by setting the Event Status Enable Register (ESER) to report OPC in the Event Status Bit (ESB) of the Status Byte Register (SBR) and setting the Service Request Enable Register (SRER) to generate service request upon a positive transition of the ESB, a service request (SRQ) interrupt can be generated when certain operations complete as described in this section.

The following instrument operations can generate an OPC:

**Table 34: Instrument operations that can generate OPC**

Command	Conditions
ACQuire:STATE ON or ACQuire:STATE RUN	Only when ACQuire:STOPAfter is set to SEQuence
*CAL?	
CALibrate:CONTINUE	
CALibrate:FACTory	
CALibrate:INTERNAL	
FACTory	
HARDCopy START	
RECALL:SETUp <file as quoted string>	
RECALL:WAVEform <file as quoted string>	
*RST	
SAVE:IMAGe <file as quoted string>	
SAVE:SETUp <file as quoted string>	
SAVE:WAVEform <file as quoted string>	

For example, a typical application might involve acquiring a single-sequence waveform and then taking a measurement on the acquired waveform. You could use the following command sequence to do this:

```

/** Set up conditional acquisition */
ACQUIRE:STATE OFF
SELECT:CH1 ON
HORIZONTAL:RECORDLENGTH 1000
ACQUIRE:MODE SAMPLE
ACQUIRE:STOPAFTER SEQUENCE
/** Acquire waveform data */
ACQUIRE:STATE ON
/** Set up the measurement parameters */
MEASUREMENT:IMMED:TYPE AMPLITUDE
MEASUREMENT:IMMED:SOURCE CH 1
/** Take amplitude measurement */
MEASUREMENT:MEAS1:VALUE?

```

The acquisition of the waveform requires extended processing time. It may not finish before the instrument takes an amplitude measurement (see the following figure). This can result in an incorrect amplitude value.

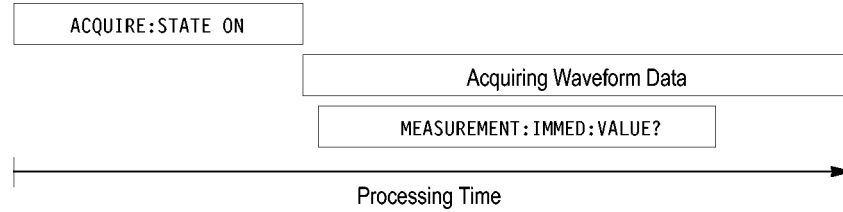

**Figure 9: Command processing without using synchronization**

To be sure the instrument completes waveform acquisition before taking the measurement on the acquired data, you can synchronize the program.

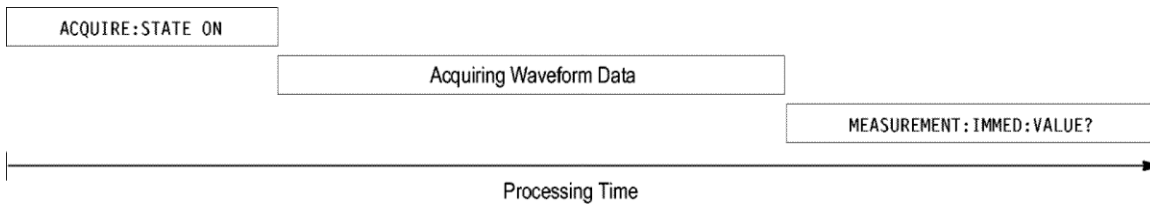

**Figure 10: Processing sequence with synchronization**

You can use four commands to synchronize the operation of the instrument with your application program: \*WAI, BUSY, \*OPC, and \*OPC?

### Using the \*WAI Command

The \*WAI command forces completion of previous commands that generate an OPC message. No commands after the \*WAI are processed before the OPC message(s) are generated

The same command sequence using the \*WAI command for synchronization looks like this:

```
/* Set up conditional acquisition */
ACQUIRE:STATE OFF
SELECT:CH1 ON
ACQUIRE:MODE SAMPLE
ACQUIRE:STOPAFTER SEQUENCE
/* Acquire waveform data */
ACQUIRE:STATE ON
/* Set up the measurement parameters */
MEASUREMENT:IMMED:TYPE AMPLITUDE
MEASUREMENT:IMMED:SOURCE CH1
/* Wait until the acquisition is complete before taking the measurement*/
*/
*WAI
/* Take amplitude measurement */
MEASUREMENT:IMMED:VALUE?
```

The controller can continue to write commands to the input buffer of the instrument, but the commands will not be processed by the instrument until all in-process OPC operations are complete. If the input buffer becomes full, the controller will be unable to write commands to the buffer. This can cause a time-out.

### Using the BUSY Query

The BUSY? query allows you to find out whether the instrument is busy processing a command that has an extended processing time such as single-sequence acquisition.

The same command sequence, using the BUSY? query for synchronization, looks like this:

```
/* Set up conditional acquisition */
ACQUIRE:STATE OFF
SELECT:CH1 ON
ACQUIRE:MODE SAMPLE
ACQUIRE:STOPAFTER SEQUENCE
```

```

/* Acquire waveform data */
ACQUIRE:STATE ON

/* Set up the measurement parameters */
MEASUREMENT:IMMED:TYPE AMPLITUDE
MEASUREMENT:IMMED:SOURCE CH1

/* Wait until the acquisition is complete before taking the measurement */
While BUSY? keep looping

/* Take amplitude measurement */
MEASUREMENT:IMMED:VALUE?

```

This sequence lets you create your own wait loop rather than using the \*WAI command. The BUSY? query helps you avoid time-outs caused by writing too many commands to the input buffer. The controller is still tied up though, and the repeated BUSY? query will result in bus traffic.

### Using the \*OPC Command

If the corresponding status registers are enabled, the \*OPC command sets the OPC bit in the Standard Event Status Register (SESR) when an operation is complete. You achieve synchronization by using this command with either a serial poll or service request handler.

**Serial Poll Method:** Enable the OPC bit in the Device Event Status Enable Register (DESER) and the Event Status Enable Register (ESER) using the DESE and \*ESE commands.

When the operation is complete, the OPC bit in the Standard Event Status Register (SESR) will be enabled and the Event Status Bit (ESB) in the Status Byte Register will be enabled.

The same command sequence using the \*OPC command for synchronization with serial polling looks like this:

```

/* Set up conditional acquisition */
ACQUIRE:STATE OFF
SELECT:CH1 ON
ACQUIRE:MODE SAMPLE
ACQUIRE:STOPAFTER SEQUENCE

/* Enable the status registers */
DESE 1
*ESE 1
*SRE 0

/* Acquire waveform data */

```

ACQUIRE:STATE ON

/\* Set up the measurement parameters \*/

MEASUREMENT:IMMED:TYPE AMPLITUDE

MEASUREMENT:IMMED:SOURCE CH1

/\* Wait until the acquisition is complete before taking the measurement.\*/

\*OPC

While serial poll = 0, keep looping

/\* Take amplitude measurement \*/

MEASUREMENT:IMMED:VALUE?

This technique requires less bus traffic than did looping on BUSY.

**Service Request Method:** Enable the OPC bit in the Device Event Status Enable Register (DESER) and the Event Status Enable Register (ESER) using the DESE and \*ESE commands.

You can also enable service requests by setting the ESB bit in the Service Request Enable Register (SRER) using the \*SRE command. When the operation is complete, the instrument will generate a Service Request.

The same command sequence using the \*OPC command for synchronization looks like this

/\* Set up conditional acquisition \*/

ACQUIRE:STATE OFF

SELECT:CH1 ON

ACQUIRE:MODE SAMPLE

ACQUIRE:STOPAFTER SEQUENCE

/\* Enable the status registers \*/

DESE 1

\*ESE 1

\*SRE 32

/\* Acquire waveform data \*/

ACQUIRE:STATE ON

/\* Set up the measurement parameters \*/

MEASUREMENT:IMMED:TYPE AMPLITUDE

MEASUREMENT:IMMED:SOURCE CH1

/\* Wait until the acquisition is complete before taking the measurement\*/

\*OPC



The program can now do different tasks such as talk to other devices. The SRQ, when it comes, interrupts those tasks and returns control to this task.

```
/* Take amplitude measurement */
MEASUREMENT:IMMED:VALUE?
```

### Using the \*OPC? Query

The \*OPC? query places a 1 in the Output Queue once an operation that generates an OPC message is complete. The \*OPC? query does not return until all pending OPC operations have completed. Therefore, your time-out must be set to a time at least if the longest expected time for the operations to complete.

The same command sequence using the \*OPC? query for synchronization looks like this:

```
/* Set up single sequence acquisition */
ACQUIRE:STATE OFF
SELECT:CH1 ON
ACQUIRE:MODE SAMPLE
ACQUIRE:STOPAFTER SEQUENCE
/* Acquire waveform data */
ACQUIRE:STATE ON
/* Set up the measurement parameters */
MEASUREMENT:IMMED:TYPE AMPLITUDE
MEASUREMENT:IMMED:SOURCE CH1
/* Wait until the acquisition is complete before taking the measurement*/
*OPC?
Wait for read from Output Queue.
/* Take amplitude measurement */
MEASUREMENT:IMMED:VALUE?
```

This is the simplest approach. It requires no status handling or loops. However, you must set the controller time-out for longer than the acquisition operation.

**Messages** The information contained in the topic tabs above covers all the programming interface messages the instrument generates in response to commands and queries.

For most messages, a secondary message from the instrument gives detail about the cause of the error or the meaning of the message. This message is part of the message string and is separated from the main message by a semicolon.

Each message is the result of an event. Each type of event sets a specific bit in the SESR and is controlled by the equivalent bit in the DESER. Thus, each message is associated with a specific SESR bit. In the message tables, the associated SESR bit is specified in the table title, with exceptions noted with the error message text.

**No Event** The following table shows the messages when the system has no events or status to report. These have no associated SESR bit.

**Table 35: No Event messages**

Code	Message
0	No events to report; queue empty
1	No events to report; new events pending *ESR?

**Command Error** The following table shows the command error messages generated by improper syntax. Check that the command is properly formed and that it follows the rules in the section on command Syntax.

**Table 36: Command error messages (CME bit 5)**

Code	Message
100	Command error
101	Invalid character
102	Syntax error
103	Invalid separator
104	Data type error
105	GET not allowed
108	Parameter not allowed
109	Missing parameter
110	Command header error
112	Program mnemonic too long
113	Undefined header
120	Numeric data error
121	Invalid character in numeric
123	Exponent too large

Code	Message
124	Too many digits
130	Suffix error
131	Invalid suffix
134	Suffix too long
140	Character data error
141	Invalid character data
144	Character data too long
150	String data error
151	Invalid string data
152	String data too long
160	Block data error
161	Invalid block data
170	Command expression error
171	Invalid expression

### Execution Error

The following table lists the execution errors that are detected during execution of a command.

**Table 37: Execution error messages (EXE bit 4)**

Code	Message
200	Execution error
221	Settings conflict
222	Data out of range
224	Illegal parameter value
241	Hardware missing
250	Mass storage error
251	Missing mass storage
252	Missing media
253	Corrupt media
254	Media full
255	Directory full
256	File name not found
257	File name error
258	Media protected
259	File name too long
270	Hardcopy error
271	Hardcopy device not responding
272	Hardcopy is busy

<b>Code</b>	<b>Message</b>
273	Hardcopy aborted
274	Hardcopy configuration error
280	Program error
282	Insufficient network printer information
283	Network printer not responding
284	Network printer server not responding
286	Program run time error
287	Print server not found
2200	Measurement error, Measurement system error
2201	Measurement error, Zero period
2202	Measurement error, No period, second waveform
2203	Measurement error, No period, second waveform
2204	Measurement error, Low amplitude, second waveform
2205	Measurement error, Low amplitude, second waveform
2206	Measurement error, Invalid gate
2207	Measurement error, Measurement overflow
2208	Measurement error, No backward Mid Ref crossing
2209	Measurement error, No second Mid Ref crossing
2210	Measurement error, No Mid Ref crossing, second waveform
2211	Measurement error, No backward Mid Ref crossing
2212	Measurement error, No negative crossing
2213	Measurement error, No positive crossing
2214	Measurement error, No crossing, target waveform
2215	Measurement error, No crossing, second waveform
2216	Measurement error, No crossing, target waveform
2217	Measurement error, Constant waveform
2219	Measurement error, No valid edge - No arm sample
2220	Measurement error, No valid edge - No arm cross
2221	Measurement error, No valid edge - No trigger cross

Code	Message
2222	Measurement error, No valid edge - No second cross
2223	Measurement error, Waveform mismatch
2224	Measurement error, WAIT calculating
2225	Measurement error, No waveform to measure
2226	Measurement error, Null Waveform
2227	Measurement error, Positive and Negative Clipping
2228	Measurement error, Positive Clipping
2229	Measurement error, Negative Clipping
2230	Measurement error, High Ref < Low Ref
2231	Measurement error, No statistics available
2233	Requested waveform is temporarily unavailable
2235	Math error, invalid math description
2240	Invalid password
2241	Waveform requested is invalid
2244	Source waveform is not active
2245	Saverref error, selected channel is turned off
2250	Reference error, the reference waveform file is invalid
2253	Reference error, too many points received
2254	Reference error, too few points received
2259	File too big
2260	Calibration error
2270	Alias error
2271	Alias syntax error
2273	Illegal alias label
2276	Alias expansion error
2277	Alias redefinition not allowed
2278	Alias header not found
2285	TekSecure(R) Pass
2286	TekSecure(R) Fail
2301	Cursor error, Off screen
2302	Cursor error, Cursors are off
2303	Cursor error, Cursor source waveform is off
2500	Setup error, file does not look like a setup file
2501	Setup warning, could not recall all values from external setup
2620	Mask error, too few points received

Code	Message
2760	Mark limit reached
2761	No mark present
2762	Search copy failed

**Device Error** The following table lists the device errors that can occur during instrument operation. These errors may indicate that the instrument needs repair.

**Table 38: Device error messages (DDE bit 3)**

Code	Message
310	System error
311	Memory error
312	PUD memory lost
314	Save/recall memory lost

**System Event** The following table lists the system event messages. These messages are generated whenever certain system conditions occur.

**Table 39: System event messages**

Code	Message
400	Query event
401	Power on (PON bit 7 set)
402	Operation complete (OPC bit 0 set)
403	User request (URQ bit 6 set)
404	Power fail (DDE bit 3 set)
405	Request control
410	Query INTERRUPTED (QYE bit 2 set)
420	Query UNTERMINATED (QYE bit 2 set)
430	Query DEADLOCKED (QYE bit 2 set)
440	Query UNTERMINATED after indefinite response (QYE bit 2 set)
468	Knob/Keypad value changed
472	Application variable changed

**Execution Warning** The following table lists warning messages that do not interrupt the flow of command execution. They also notify you of a possible unexpected results.

**Table 40: Execution warning messages (EXE bit 4)**

Code	Message
528	Parameter out of range
532	Curve data too long, Curve truncated
533	Curve error, Preamble values are inconsistent
540	Measurement warning, Uncertain edge
541	Measurement warning, Low signal amplitude
542	Measurement warning, Unstable histogram
543	Measurement warning, Low resolution
544	Measurement warning, Uncertain edge
545	Measurement warning, Invalid in minmax
546	Measurement warning, Need 3 edges
547	Measurement warning, Clipping positive/negative
548	Measurement warning, Clipping positive
549	Measurement warning, Clipping negative

**Table 41: Execution warning messages (EXE bit 4)**

Code	Message
540	Measurement warning
541	Measurement warning, Low signal amplitude
542	Measurement warning, Unstable histogram
543	Measurement warning, Low resolution
544	Measurement warning, Uncertain edge
545	Measurement warning, Invalid min max
546	Measurement warning, Need 3 edges
547	Measurement warning, Clipping positive/negative
548	Measurement warning, Clipping positive
549	Measurement warning, Clipping negative

**Internal Warning** The following table shows internal errors that indicate an internal fault in the instrument.

**Table 42: Internal warning messages**

Code	Message
600	Internal warning





---

# Programming Examples

The following series of commands and queries illustrate many of the most common commands and techniques.

To use these commands and queries over USB, you must use a program or routines that interface to the USBTMC driver on your PC. You can also use the PC Communications software that came on the CD with your instrument to get the same data without having to write programs. For operating information, you can launch the PC Communications software and refer to the online help.

To use these commands and queries over GPIB, you must use a program or routines that interface to the GPIB hardware in your computer. The software is usually supplied by the GPIB hardware manufacturer.

In these examples, data sent from the controller computer to the instrument is prefaced with the > symbol. Replies from the instrument have no preface.

```
> REM "Check for any messages, and clear them from the queue."  
> *ESR?  
128  
> ALLEV ?  
:ALLEV 401,"Power on; "  
> REM "Set the instrument to the default state."  
> FACTORY  
> REM "Set the instrument parameters that differ from the defaults."  
> CH1:VOLTS 2.0  
> HOR:MAIN:SCALE 100e-6  
> TRIG:MAIN:LEVEL 2.4  
> REM "Start a single sequence acquisition."  
> ACQUIRE:STOPAFTER SEQUENCE  
> ACQUIRE:STATE ON  
> REM "Wait for the acquisition to complete."  
> REM "Note: your controller program time-out must be set long enough to  
handle the wait."  
> *OPC?  
1  
> REM "Use the instrument built-in measurements to measure the waveform you  
acquired."  
> MEASU:IMMED:TYPE MEAN
```

```
> MEASU:IMMED:VALUE?
:MEASUREMENT:IMMED:VALUE 2.4631931782E0
> REM "Be sure to use the *esr? query to check for measurement errors."
> MEASU:IMMED:TYPE FREQ
> MEASU:IMMED:VALUE?
:MEASUREMENT:IMMED:VALUE 9.9E37
> *ESR?
16
> ALLEV?
:ALLEV 2202,"Measurement error, No period found; "
> REM "Query out the waveform points, for later analysis on your controller
computer." > data:encdg ascii
> CURVE?
:CURVE 7,6,5,5,5,6,6,8 [...]
> REM "Query out the parameters used for calculating the times and voltages of
the waveform points."
> WFMPRE?
:WFMPRE:BYT_NR 1;BIT_NR 8;ENCDG ASC;BN_FMT RP;BYT_OR
MSB;NR_PT 2500; [...]
```

# ASCII Code Chart

B7 B6 B5 BITS B4 B3 B2 B1	0 0 0	0 0 1	0 1 0	0 1 1	1 0 0	1 0 1	1 1 0	1 1 1
	CONTROL		NUMBERS SYMBOLS		UPPER CASE		LOWER CASE	
0 0 0 0	0 NUL 0	20 DLE 16	40 SP 32	60 0 48	100 @ 64	120 P 80	140 ' 96	160 p 112
0 0 0 1	1 SOH 1	21 DC1 17	41 ! 33	61 1 49	101 A 65	121 Q 81	141 a 97	161 q 113
0 0 1 0	2 STX 2	22 DC2 18	42 " 34	62 2 50	102 B 66	122 R 82	142 b 98	162 r 114
0 0 1 1	3 ETX 3	23 DC3 19	43 # 35	63 3 51	103 C 67	123 S 83	143 c 99	163 s 115
0 1 0 0	4 SDC EOT 4	24 DCL DC4 20	44 \$ 36	64 4 52	104 D 68	124 T 84	144 d 100	164 t 116
0 1 0 1	5 PPC ENQ 5	25 PPU NAK 21	45 % 37	65 5 53	105 E 69	125 U 85	145 e 101	165 u 117
0 1 1 0	6 ACK 6	26 SYN 22	46 & 38	66 6 54	106 F 70	126 V 86	146 f 102	166 v 118
0 1 1 1	7 BEL 7	27 ETB 23	47 ' 39	67 7 55	107 G 71	127 W 87	147 g 103	167 w 119
1 0 0 0	10 GET BS 8	30 SPE CAN 24	50 ( 40	70 8 56	110 H 72	130 X 88	150 h 104	170 x 120
1 0 0 1	11 TCT HT 9	31 SPD EM 25	51 ) 41	71 9 57	111 I 73	131 Y 89	151 i 105	171 y 121
1 0 1 0	12 LF A 10	32 SUB 1A 26	52 * 42	72 : 58	112 J 74	132 Z 90	152 j 106	172 z 122
1 0 1 1	13 VT B 11	33 ESC 1B 27	53 + 43	73 ; 59	113 K 75	133 [ 91	153 k 107	173 { 123
1 1 0 0	14 FF C 12	34 FS 1C 28	54 , 44	74 < 60	114 L 76	134 \ 92	154 l 108	174 ; 124
1 1 0 1	15 CR D 13	35 GS 1D 29	55 - 45	75 = 61	115 M 77	135 ] 93	155 m 109	175 } 125
1 1 1 0	16 SO E 14	36 RS 1E 30	56 . 46	76 > 62	116 N 78	136 ^ 94	156 n 110	176 ~ 126
1 1 1 1	17 SI F 15	37 US 1F 31	57 / 47	77 ? 63	117 O 79	137 - 95	157 o 111	177 RUBOUT (DEL) 7F 127
	ADDRESSED COMMANDS	UNIVERSAL COMMANDS	LISTEN ADDRESSES	TALK ADDRESSES	SECONDARY ADDRESSES OR COMMANDS			

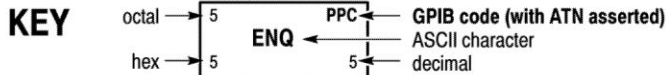

**Tektronix**  
REF: ANSI STD X3.4-1977  
IEEE STD 488.1-1987  
ISO STD 646-2973



---

# Factory setup

The following listing is the instrument response to the concatenated command FACTory;SET. This response describes the factory default setup in detail. (Carriage returns have been inserted for clarity.)

Items enclosed in ( ) parentheses are returned by the SET? query response, but are not changed by the FACTory command.

## TBS2000B Series Oscilloscopes

Responses for channel 3 and 4 apply only to 4-channel models.

```
:HEADER 1;( :VERBOSE 1;)  
:DATA:ENCDG RIBINARY;DESTINATION REFA;SOURCE CH1;START  
1;STOP 2500;WIDTH 1;  
( :LOCK NONE;)  
:DISPLAY:FORMAT YT;STYLE VECTORS;PERSISTENCE 0;(CONTRAST  
50);(INVERT OFF);  
:ACQUIRE:MODE SAMPLE;NUMAVG 16;STATE 1;STOPAFTER  
RUNSTOP;  
:CH1:PROBE 10;SCALE 1.0E0;POSITION 0.0E0;COUPLING  
DC;BANDWIDTH OFF;INVERT OFF;  
:CH2:PROBE 10;SCALE 1.0E0;POSITION 0.0E0;COUPLING  
DC;BANDWIDTH OFF;INVERT OFF;  
:CH3:PROBE 10;SCALE 1.0E0;POSITION 0.0E0;COUPLING  
DC;BANDWIDTH OFF;INVERT OFF;  
:CH4:PROBE 10;SCALE 1.0E0;POSITION 0.0E0;COUPLING  
DC;BANDWIDTH OFF;INVERT OFF;  
:HORIZONTAL:VIEW MAIN;MAIN:SCALE 5.0E-4;POSITION 0.0E0;  
:HORIZONTAL:DELAY:SCALE 5.0E-5;POSITION 0.0E0;  
:TRIGGER:MAIN:MODE AUTO;TYPE EDGE;HOLDOFF:VALUE 5.0E-7;  
:TRIGGER:MAIN:EDGE:SOURCE CH1;COUPLING DC;SLOPE RISE;  
:TRIGGER:MAIN:VIDEO:SOURCE CH1;SYNC LINE;POLARITY  
NORMAL;LINE 1;STANDARD NTSC;  
:TRIGGER:MAIN:PULSE:SOURCE CH1;WIDTH:POLARITY  
POSITIVE;WHEN EQUAL;WIDTH 1.0E-3;  
:TRIGGER:MAIN:LEVEL 0.0E0;  
:SELECT:CH1 1;CH2 0;CH3 0;CH4 0;MATH 0;REFA 0;REFB 0;REFC  
0;REFD 0;
```

```
:CURSOR:FUNCTION OFF;SELECT:SOURCE CH1;
:CURSOR:VBARS:UNITS SECONDS;POSITION1 -2.0E-3;POSITION2
2.0E-3;
:CURSOR:HBARS:POSITION1 -3.2E0;POSITION2 3.2E0;
:MEASUREMENT:MEAS1:TYPE NONE;SOURCE CH1;
:MEASUREMENT:MEAS2:TYPE NONE;SOURCE CH1;
:MEASUREMENT:MEAS3:TYPE NONE;SOURCE CH1;
:MEASUREMENT:MEAS4:TYPE NONE;SOURCE CH1;
:MEASUREMENT:MEAS5:TYPE NONE;SOURCE CH1;
:MEASUREMENT:IMMED:TYPE PERIOD;SOURCE CH1;
:MATH:DEFINE "CH1 - CH2";FFT:HORIZONTAL:POSITION 5.0E1;SCALE
1.0E0;
:MATH:FFT:VERTICAL:POSITION 0.0E0;SCALE 1.0E0;
(:HARDCOPY:<BUTTON PRINTS;>FORMAT EPSON;PORT
CENTRONICS;LAYOUT PORTRAIT;INKSAVER ON;)
(<SAVE:IMAGE:FILEFORMAT BMP;>)
(:LANGUAGE ENGLISH)
```

---

## Reserved words

The following words are reserved for the instrument.

\*CAL, \*CLS, \*DDT, \*ESE, \*ESR, \*IDN, \*LRN, \*OPC, \*PSC, \*RCL, \*RST, \*SAV, \*SRE, \*STB, \*TRG, \*TST, \*WAI, A0, A1, A2, A3, A4, A5, A6, A7, A8, A9, ABOrt, AC, ACLINE, ACQuire, ALL, ALLEv, ASC, ASCi, AUTO, AUTOMATIC, AUTORange, AUTOSet, AVERage, B0, B1, B2, B3, B4, B5, B6, B7, B8, B9, BANDwidth, BATTERIES, BAUD, BIN, BIT\_Nr, BMP, BN\_Fmt, BOTH, BRIGHTness, BUBBLEJet, BUSY, BUTTON, BUTTONLIGHT, BYT\_Nr, BYT\_Or, Block, CALibrate, CARD, CENtronicS, CH1, CH1CH2, CH2, CH3, CH3CH4, CH4, CM10BY15, CM13BY18, CM15BY21, CM18BY24, CM6BY8, CM7BY10, CM9BY13, COMpare, CONDUCTION, CONTINUE, CONTINUOUS, CONTRast, COUpling, CR, CRLf, CRMS, CURRENTPRObe, CURSor, CURSORRms, CURVe, CWD, DATALOGging, DATE, DATEPRINT, DATA, DC, DCLIne, DEF, DEFINE, DEFLT, DEFault, DELay, DELEte, DELTa, DELay, DESE, DESKJet, DESTination, DIAg, DIR, DISplay, DOTs, DPU3445, DPU411, DPU412, DRAFT, DURAtion, E, EDGE, ENAbLe, ENCdg, ENGLish, ENV, EPSC60, EPSC80, EPSIMAGE, EPSON, EQual, ERRLOG, EVEN, EVENT, EVMsg, EVQty, EXECute, EXT, EXT10, EXT5, FACtory, FALL, FALLINGedge, FASTPHOTO, FFT, FIELD, FILEFormat, FILESystem, FINE, FIRST, FLAg, FORCe, FORMat, FREESpace, FRENch, FREQuency, FREquency, FUNcTion, GASgauge, GERMan, GND, GPIb, HAGAKIPC, HAGAKIPCARD, HARDCopy, HARDFlagging, HARmonics, HBARS, HDELta, HDR, HEADer, HERTz, HFRej, HOLDOff, HORizontal, HRMS, ID, IDPRINT, IMAGESIZE, IMAge, IMMEd, IN11BY17, IN2P5BY3P25, IN4BY6, IN8BY10, INDEX, INF, INIT, INKSaver, INTERLEAF, INTERNAL, INVERT, INVert, INside, ITALian, JAPANese, JOULES, JPEG, JPG, KOREan, L, L2, L4, LANGUage, LANdScape, LASERJet, LAYout, LETTER, LEVELS, LEVEl, LF, LFCr, LFRej, LIMit, LINE, LINENum, LOCK, LOG, LSB, MAIn, MANUAL, MATH, MAXImum, MEAN, MEASUrement, MINImum, MKDir, MM100BY150, MM54BY86, MODE, MSB, MULTICYcle, N, NEGAtive, NEXT, NOISerej, NONE, NONe, NORMAl, NOTEqual, NRMAL, NR\_Pt, NTSc, NUMACq, NUMAVg, NWIdth, ODD, OFF, ON, OUTside, PAL, PAPERSIZE, PAPERTYPE, PARity, PCX, PEAKdetect, PERCent, PERIod, PERSistence, PFPHASE, PHAse, PHOTO, PICTBridge, PK2pk, PLAIN, POLarity, PORT, PORTrait, PORTUGuese, POSITIVe, POSition, POWERFACTOR, POWer, POWerANALYSIS, PRESENT, PRINTQUAL, PRINTS, PRObe, PT\_Fmt, PT\_Off, PULse, PWidth, RECAIl, RECOrdlength, REFx, REM, REName, RESUlt, RI, RIBinary, RISINGedge, RISe, RLE, RMDir, RMS, ROLL100MM, ROLL127MM, ROLL210MM, ROLL89MM, RP, RPBinary, RS232, RUN, RUNSTop, SAMple, SAVESAll, SAVESImage, SAVE, SAVEIMAge, SAVEWFM, SCALe, SECOnds, SECdiv, SELEct, SEQuence, SET, SETLevel, SETTings, SETUp, SHOW, SIGNAL, SIMPLifiedchinese, SINGLECYcle, SLOPe, SOFTFlagging, SOURCE, SOURCE1, SOURCE2, SOURce, SOURces, SPANish, SRIBinary, SRPBinary, STANDard, START, STATE, STATUS, STOP, STOPAfter, STYle, SWLoss, SYNC, TARget, TEMPLate, TERMinator, THDF, THDR, THINKjet, TIFF, TIME, TIME, TOFFEND, TOFFSTART, TOLerance, TONEND,

TONSTART, TOTAL, TRADitionalchinese, TRANsmit, TRIGger,  
TRUEPOWER, TURNOFF, TURNON, TYPe, UNIts, UNLock, USB, VALue,  
VAR, VBArS, VDELTA, VECtors, VERBoSe, VERTical, VIDEo, VIEW,  
VIOLation, VOLts, VSAT, WATTS, WAVEform, WAVEFORMANALYSIS,  
WAVEform, WAVFrm, WFCREST, WFCYCRMS, WFFREQ, WFId, WFMPre,  
WHEN, WIDth, WINDOW, XINcr, XUNit, XY, XZEro, Y, YMUlt, YOff, YT,  
YUNit, YZEro, ZONE,



---

# Glossary

## Glossary terms

<b>ASCII</b>	Acronym for the American Standard Code for Information Interchange. Controllers transmit commands to the digitizing instrument using ASCII character encoding.
<b>Address</b>	A 7-bit code that identifies an instrument on the communication bus. The digitizing instrument must have a unique address for the controller to recognize and transmit commands to it.
<b>Backus-Naur Form (BNF)</b>	A standard notation system for command syntax. The syntax in this manual use BNF notation.
<b>Controller</b>	A computer or other device that sends commands to and accepts responses from the digitizing instrument.
<b>EOM</b>	A generic acronym referring to the end-of-message terminator. For GPIB, the end-of-message terminator is either an EOI or the ASCII code for line feed (LF). For USB, the end-of-message terminator is the EOM bit in a USBTMC message.
<b>IEEE</b>	Acronym for the Institute of Electrical and Electronics Engineers.
<b>USB</b>	An acronym for Universal Serial Bus.
<b>USBTMC</b>	An acronym for USB Test and Measurement Class.
<b>USB488</b>	The USBTMC subclass specification that implements an IEEE488-like interface over USB.



# Index

\*CAL?, 57  
\*CLS, 79  
\*ESE, 114  
\*ESR?, 115  
\*IDN?, 168  
\*LRN?, 170  
\*OPC, 213  
\*PSC, 215  
\*RCL, 217  
\*RST, 224  
\*SAV, 225  
\*SRE, 256  
\*STB?, 257  
\*WAI, 287

## A

ACquire?, 41  
ACquire:MAXSamplerate, 42  
ACquire:MODE, 42  
ACquire:NUMAcq?, 44  
ACquire:NUMAVg, 45  
ACquire:STATE, 45  
ACquire:STOPAfter, 46  
ALias, 47, 51  
ALias:CATalog?, 48  
ALias:DEFine, 49  
ALias:DELEte, 50, 51  
ALias:DELEte:ALL, 50  
ALLEv?, 52  
Arguments, 10  
ASCII, 3  
AUTOSet, 53  
AUTOSet:ENABLE, 53

## B

BNF (Backus Naur form), 3  
BUSY?, 55

## C

CALibrate:INTERNAL, 58

CALibrate:INTERNAL:START, 58  
CALibrate:INTERNAL:STATus?, 59  
CALibrate:RESults?, 60  
CALibrate:RESults:SPC?, 60  
CH<x>?, 61  
CH<x>:AMPSVIAVOLTs :Factor, 63  
CH<x>:AMPSVIAVOLTs:ENABLE, 62  
CH<x>:BANdwidth, 63  
CH<x>:COUPling, 64  
CH<x>:DESKew, 65  
CH<x>:INVert, 66  
CH<x>:LABel, 66  
CH<x>:OFFSet, 67  
CH<x>:POSition, 68  
CH<x>:PRObe, 69  
CH<x>:PRObe:AUTOZero, 70  
CH<x>:PRObe:DEGAUss, 70  
CH<x>:PRObe:DEGAUss:STATE?, 71  
CH<x>:PRObe:FORCEDRange, 72  
CH<x>:PRObe:GAIN, 73  
CH<x>:PRObe:ID?, 74  
CH<x>:PRObe:ID:SERnumber?, 74  
CH<x>:PRObe:ID:TYPE?, 75  
CH<x>:PRObe:SIGnal, 75  
CH<x>:PRObe:UNIts?, 76  
CH<x>:SCALE, 76  
CH<x>:VOLts, 77  
CH<x>:YUNit, 78  
CLEARMenu, 79  
Command  
    syntax:BNF (Backus Naur form), 3  
Command and Query Structure, 4  
Command syntax  
    BNF (Backus Naur form), 3  
CURSor?, 80  
CURSor:ENABLE, 81  
CURSor:FUNCTion, 82  
CURSor:HBArs?, 83  
CURSor:HBArs:DELTA?, 83  
CURSor:HBArs:POSITION<x>, 84  
CURSor:HBArs:UNIts, 85

CURSor:VBArS?, 87  
CURSor:VBArS:DELTA?, 88  
CURSor:VBArS:HPOS<x>?, 89  
CURSor:VBArS:POSITION<x>, 89  
CURSor:VBArS:UNIts, 90  
CURSor:VBArS:VDELTA?, 91  
CURVe, 92

## D

DATA, 95  
DATA:DESTination, 96  
DATA:SOURce, 97  
DATA:START, 98  
DATA:STOP, 99  
DATA:WIDTH, 100  
DATE, 101  
DESE, 102  
DIAG:FAN, 103  
DIAG:LOOP:OPTion, 103  
DIAG:RESUlt:FLAg?, 105  
DIAG:RESUlt:LOG?, 105  
DIAG:SElect, 106  
DIAG:SElect:<function>, 107  
DIAG:STATE, 107  
DIAG:TEMPVAL, 108  
DISplay:GRaticule, 108  
DISplay:INTENSITy:BACKLight, 109  
DISplay:PERsistence:STATe, 110  
DISplay:PERsistence:VALUe, 110

## E

ERRLOG:FIRST?, 113  
ERRLOG:NEXT?, 113  
Ethernet command group, 16, 17  
ETHERnet:DHCPbootp, 116  
ETHERnet:DNS:IPADDrESS, 117  
ETHERnet:DOMAINname, 117  
ETHERNET:ENET:ADDrESS?, 118  
ETHERnet:GATEWay:IPADDrESS, 118  
ETHERnet:HTTTPort, 119  
ETHERnet:IPADDrESS, 120  
ETHERnet:NAME, 120

ETHERnet:PASSWOrd, 121  
ETHERnet:PING, 121  
ETHERnet:PING:STATUS?, 122  
ETHERnet:SUBNETMask, 123  
Event handling, 315  
EVENT?, 123  
EVMsg?, 124  
EVQty?, 125  
Example programming, 336  
Examples  
    Programming, 336

## F

FACtory, 127  
Factory setup  
    detailed description, 339  
FEAEN:PASSWOrd, 128  
FFT?, 129  
FFT:HORizontal:POSition, 129  
FFT:HORizontal:SCAle, 130  
FFT:SOURce, 130  
FFT:SRCWFM, 131  
FFT:VERTical:POSition, 132  
FFT:VERTical:SCAle, 132  
FFT:VERTical:UNIts, 133  
FFT:VType, 133  
FFT:WINDow, 134  
FILESystem?, 134  
FILESystem:CWD, 135  
FILESystem:DELEte, 136  
FILESystem:DIR?, 137  
FILESystem:FORMat, 138  
FILESystem:FREESpace?, 138  
FILESystem:MKDir, 139  
FILESystem:READFile, 140  
FILESystem:REName, 140  
FILESystem:RMDir, 141  
FILESystem:WRITEFile, 142  
FPAnel:PRESS, 143  
FPAnel:TURN, 145

**H**

HDR, 147  
 HEADer, 147  
 HELPevery:ACQuire, 148  
 HELPevery:ALL, 149  
 HELPevery:CURSor, 149  
 HELPevery:FFT, 150  
 HELPevery:MATH, 150  
 HELPevery:MEASUrement, 151  
 HELPevery:REFeRence, 152  
 HELPevery:SEARCh, 152  
 HELPevery:TRIGger, 153  
 HELPevery:UTIlity, 154  
 HELPevery:VERTical, 154  
 HORizontal?, 155  
 HORizontal:ACQLENGTH, 156  
 HORizontal:DELay:POSition, 157  
 HORizontal:DIVisions, 156  
 HORizontal:MAIn:DELay:MODE, 158  
 HORizontal:MAIn:DELay:STATe, 159  
 HORizontal:MAIn:DELay:TIME, 160  
 HORizontal:MAIn:SAMPLERate, 160  
 HORizontal:MAIn:SECdiv, 162  
 HORizontal:MAIn:UNIts:STRing, 162  
 HORizontal:PREViewstate, 163  
 HORizontal:RECOrdlength, 163  
 HORizontal:RECOrdlength:Auto, 164  
 HORizontal:RESOLution, 165  
 HORizontal:ROLL, 165  
 HORizontal:SCALE, 161  
 HORizontal:TRIGger:POSition, 166

**I**

ID?, 167  
 IEEE Std. 488.2-1987, 3

**L**

LANGuage, 169  
 LOCK, 170

**M**

MARK, 171

MARK:CREATE, 172  
 MARK:DELEte, 173  
 MARK:FREE?, 174  
 MARK:SELEcted:END?, 174  
 MARK:SELEcted:FOCUS?, 174  
 MARK:SELEcted:MARKSINCOLumn?, 175  
 MARK:SELEcted:OWNer?, 175  
 MARK:SELEcted:SOURCE?, 176  
 MARK:SELEcted:STARt?, 176  
 MARK:SELEcted:STATe?, 176  
 MARK:SELEcted:ZOOm:POSition?, 177  
 MARK:TOTal?, 177  
 MATH?, 177  
 MATH:DEFINE, 178  
 MATH:HORizontal:POSition, 179  
 MATH:HORizontal:SCALE, 180  
 MATH:HORizontal:UNIts, 180  
 MATH:LABel, 181  
 MATH:VERTical:POSition, 182  
 MATH:VERTical:SCALE, 182  
 MATH:VERTical:UNIts, 183  
 MEASUrement?, 184  
 MEASUrement:CLEARSNAPSHOT, 185  
 MEASUrement:ENABLE, 185  
 MEASUrement:GATing, 186  
 MEASUrement:IMMed?, 187  
 MEASUrement:IMMed:DELay?, 187  
 MEASUrement:IMMed:DELay:EDGE<x>, 188  
 MEASUrement:IMMed:SOUrce1, 189  
 MEASUrement:IMMed:SOUrce2, 190  
 MEASUrement:IMMed:TYPE, 191  
 MEASUrement:IMMed:UNIts?, 193  
 MEASUrement:IMMed:VALue?, 194  
 MEASUrement:MEAS<x>?, 195  
 MEASUrement:MEAS<x>:DELay?, 195  
 MEASUrement:MEAS<x>:DELay:EDGE<x>, 196  
 MEASUrement:MEAS<x>:SOUrce1, 197  
 MEASUrement:MEAS<x>:SOUrce2, 197  
 MEASUrement:MEAS<x>:STATE, 198  
 MEASUrement:MEAS<x>:TYPE, 199  
 MEASUrement:MEAS<x>:UNIts?, 202  
 MEASUrement:MEAS<x>:VALue?, 203  
 MEASUrement:REFLevel?, 204

MEASUREMENT:REFLEVEL:ABSOLUTE:LOW, 204  
 MEASUREMENT:REFLEVEL:ABSOLUTE:MID1, 205  
 MEASUREMENT:REFLEVEL:ABSOLUTE:MID2, 206  
 MEASUREMENT:REFLEVEL:METHOD, 207  
 MEASUREMENT:REFLEVEL:PERCENT:HIGH, 208  
 MEASUREMENT:REFLEVEL:PERCENT:LOW, 209  
 MEASUREMENT:REFLEVEL:PERCENT:MID1, 210  
 MEASUREMENT:REFLEVEL:PERCENT:MID2, 211  
 MEASUREMENT:SNAPSHOT, 212  
 MEASUREMENT:SOURCESNAPSHOT, 212  
 Message  
   handling, 315  
 Mnemonics, 9

## P

Programming  
   examples, 336  
 Programming examples, 336

## R

RECALL:SETUP, 218  
 RECALL:WAVEFORM, 219  
 REF<x>?, 220  
 REF<x>:DATE, 220  
 REF<x>:HORIZONTAL:DELAY:TIME?, 221  
 REF<x>:HORIZONTAL:SCALE?, 222  
 REF<x>:POSITION?, 222  
 REF<x>:TIME?, 221  
 REF<x>:VERTICAL:POSITION?, 223  
 REF<x>:VERTICAL:SCALE?, 223

## S

SAVE:IMAGE, 226  
 SAVE:IMAGE:FILEFORMAT, 227  
 SAVE:IMAGE:LAYOUT, 228  
 SAVE:SETUP, 229  
 SAVE:WAVEFORM, 230  
 SAVE:WAVEFORM:FILEFORMAT, 231  
 SEARCH, 232  
 SEARCH:SEARCH<x>:COPY, 232  
 SEARCH:SEARCH<x>:STATE, 233  
 SEARCH:SEARCH<x>:TOTAL, 234

SEARCH:SEARCH<x>:TRIGGER:A:EDGE:SLOPE, 237  
 SEARCH:SEARCH<x>:TRIGGER:A:EDGE:SOURCE, 238  
 SEARCH:SEARCH<x>:TRIGGER:A:LEVEL, 234  
 SEARCH:SEARCH<x>:TRIGGER:A:LEVEL:CH<x>, 235  
 SEARCH:SEARCH<x>:TRIGGER:A:LOWERTHRESHOLD:CH<x>, 238  
 SEARCH:SEARCH<x>:TRIGGER:A:LOWERTHRESHOLD:MATH, 235  
 SEARCH:SEARCH<x>:TRIGGER:A:LOWERTHRESHOLD:REF<x>, 236  
 SEARCH:SEARCH<x>:TRIGGER:A:PULSEWIDTH:POLARITY, 239  
 SEARCH:SEARCH<x>:TRIGGER:A:PULSEWIDTH:SOURCE, 239  
 SEARCH:SEARCH<x>:TRIGGER:A:PULSEWIDTH:WHEN, 240  
 SEARCH:SEARCH<x>:TRIGGER:A:PULSEWIDTH:WIDTH, 240  
 SEARCH:SEARCH<x>:TRIGGER:A:RUNT:POLARITY, 241  
 SEARCH:SEARCH<x>:TRIGGER:A:RUNT:SOURCE, 241  
 SEARCH:SEARCH<x>:TRIGGER:A:RUNT:WHEN, 242  
 SEARCH:SEARCH<x>:TRIGGER:A:RUNT:WIDTH, 243  
 SEARCH:SEARCH<x>:TRIGGER:A:TYPE, 236  
 SEARCH:SEARCH<x>:TRIGGER:A:UPPERTHRESHOLD:CH<x>, 243  
 SELECT:CH<x>, 244  
 SELECT:CONTROL, 245  
 SELECT:FFT, 246  
 SELECT:MATH, 247  
 SELECT:REF<x>, 248  
 SET?, 249  
 SETUP<x>:DATE?, 250  
 SETUP<x>:TIME?, 250  
 Setups  
   factory:TBS2000, 340  
 SOCKETSERVER:SOCKETCURRENTPORT, 251  
 SOCKETSERVER:SOCKETPORT, 251  
 SOCKETSERVER:SOCKETPROTOCOL, 252

SOCKETServer:SOCKETSTATUS, 254  
 SOCKETServer:SOCKETSTORE, 255  
 Status, 315

Syntax  
   BNF (Backus Naur form), 3

## T

TEKSecure, 259  
 TIME, 259  
 TRIGGER, 260  
 TRIGGER:A, 261  
 TRIGGER:A:EDGE?, 262  
 TRIGGER:A:EDGE:COUPLing, 262  
 TRIGGER:A:EDGE:SLOPe, 263  
 TRIGGER:A:EDGE:SOURce, 264  
 TRIGGER:A:HOLDOff?, 265  
 TRIGGER:A:HOLDOff:TIME, 265  
 TRIGGER:A:LEVel, 266  
 TRIGGER:A:LEVel:CH<x>, 267  
 TRIGGER:A:LOWerthreshold:CH<x>, 267  
 TRIGGER:A:MODE, 268  
 TRIGGER:A:PULse?, 269  
 TRIGGER:A:PULse:CLAss, 270  
 TRIGGER:A:PULse:SOURce, 272  
 TRIGGER:A:PULse:WIDth?, 271  
 TRIGGER:A:PULse:WIDth:POLarity, 271  
 TRIGGER:A:PULse:WIDth:WHEN, 272  
 TRIGGER:A:PULse:WIDth:WIDth, 274  
 TRIGGER:A:RUNT, 275  
 TRIGGER:A:RUNT:POLarity, 275  
 TRIGGER:A:RUNT:SOURce, 276  
 TRIGGER:A:RUNT:WHEn, 277  
 TRIGGER:A:RUNT:WIDth, 278  
 TRIGGER:A:TYPe, 278  
 TRIGGER:A:UPPPerthreshold:CH<x>, 279  
 TRIGGER:FREQuency?, 280  
 TRIGGER:STATE?, 280

## U

UNLock, 283

## V

VERBoSe, 285

## W

WAVFrm?, 288  
 WFMInpre?, 288  
 WFMInpre:BIT\_Nr, 289  
 WFMInpre:BYT\_Nr, 290  
 WFMInpre:ENCdg, 290  
 WFMInpre:NR\_Pt?, 291  
 WFMInpre:XINcr, 292  
 WFMInpre:XUNit, 292  
 WFMInpre:XZEro, 293  
 WFMInpre:YMUlt, 294  
 WFMInpre:YOFF, 295  
 WFMInpre:YUNit, 296  
 WFMInpre:YZEro, 297  
 WFMOutpre?, 298  
 WFMOutpre:BIT\_Nr, 298  
 WFMOutpre:BN\_Fmt, 299  
 WFMOutpre:BYT\_Nr, 300  
 WFMOutpre:ENCdg, 301  
 WFMOutpre:NR\_Pt?, 302  
 WFMOutpre:RECOrdlength?, 302  
 WFMOutpre:WFId?, 303  
 WFMOutpre:XINcr?, 304  
 WFMOutpre:XUNit?, 304  
 WFMOutpre:XZEro?, 305  
 WFMOutpre:YMUlt?, 306  
 WFMOutpre:YOFF?, 306  
 WFMOutpre:YUNit?, 307  
 WFMOutpre:YZEro?, 308

## Z

ZOOM?, 309  
 ZOOM{;MODE|:STATE}, 309  
 ZOOM:ZOOM1, 310  
 ZOOM:ZOOM1:FACtor, 311  
 ZOOM:ZOOM1:HORIZontal:POSition, 311  
 ZOOM:ZOOM1:HORIZontal:SCAle, 312  
 ZOOM:ZOOM1:POSition, 313  
 ZOOM:ZOOM1:SCAle, 313  
 ZOOM:ZOOM1:STATE, 314

