

Thermal Imaging Riflescopes

**THERMION 2**

**Reticle  
Catalogue**

## Non-scalable reticles

The values of the non-scalable reticles are correct in the following cases:

- when the magnification of the scope is set to minimum
- when "picture in picture" is activated

**D50i**

**C50i**

**X54i**

**H50i**

**X50i**

**T54i**

**M58i**

## Scalable reticles

Reticle parameters apply to all magnifications

**X51Fi-300**

**M56Fi (Mil-Dot)**

**M57Fi (Mil-Dot)**



# D50i

Reticle parameters (for minimum magnification)

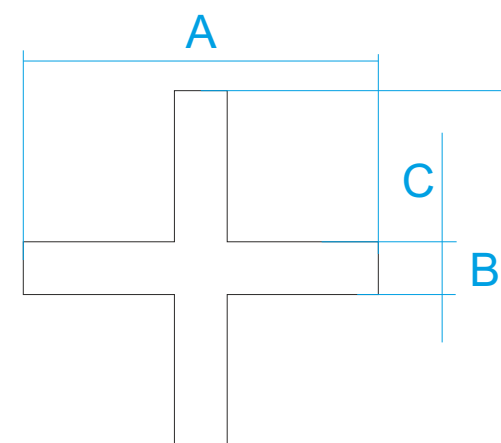

Model	MOA			cm @ 100 m		
	XQ38	XQ50	XP50	XQ38	XQ50	XP50
<b>Section A</b>	4.0	3.1	5.1	11.7	8.9	14.9
<b>Section B</b>	4.0	3.1	5.1	11.7	8.9	14.9
<b>Section C</b>	0.6	0.4	0.7	1.7	1.3	2.1

Thermal Imaging Riflescopes  
**THERMION 2**

# C50i

Reticle parameters (for minimum magnification)

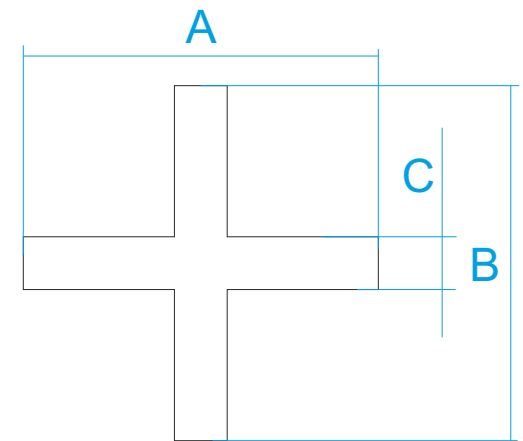
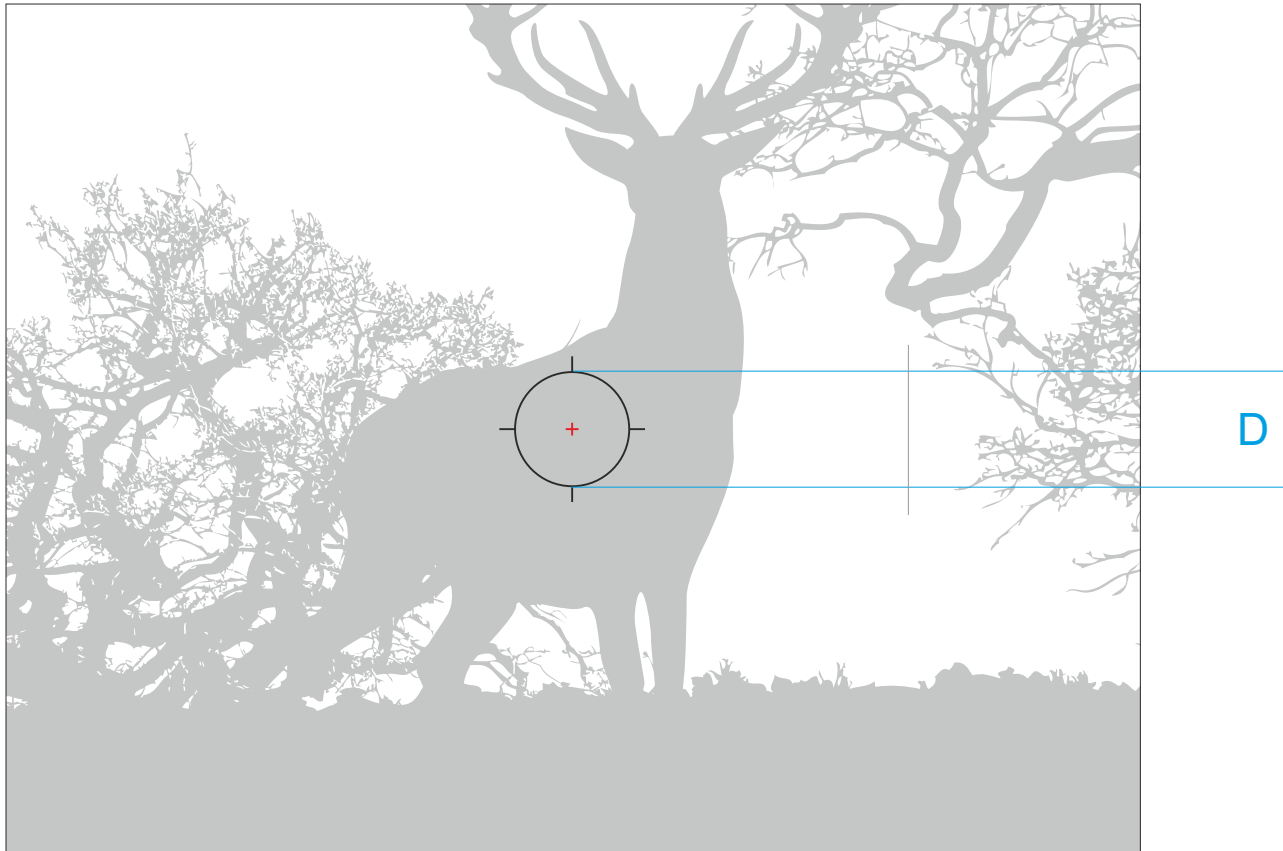

Model	MOA			cm @ 100 m		
	XQ38	XQ50	XP50	XQ38	XQ50	XP50
<b>Section A</b>	4.0	3.1	5.1	11.7	8.9	14.9
<b>Section B</b>	4.0	3.1	5.1	11.7	8.9	14.9
<b>Section C</b>	0.6	0.4	0.7	1.7	1.3	2.1
<b>Section D</b>	34.4	34.4	68.8	100	100	200

# X54i

Reticle parameters (for minimum magnification)

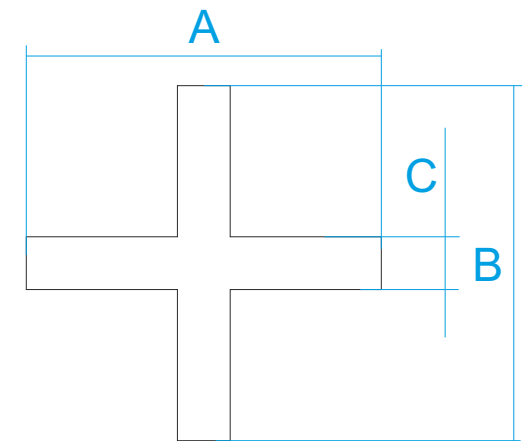
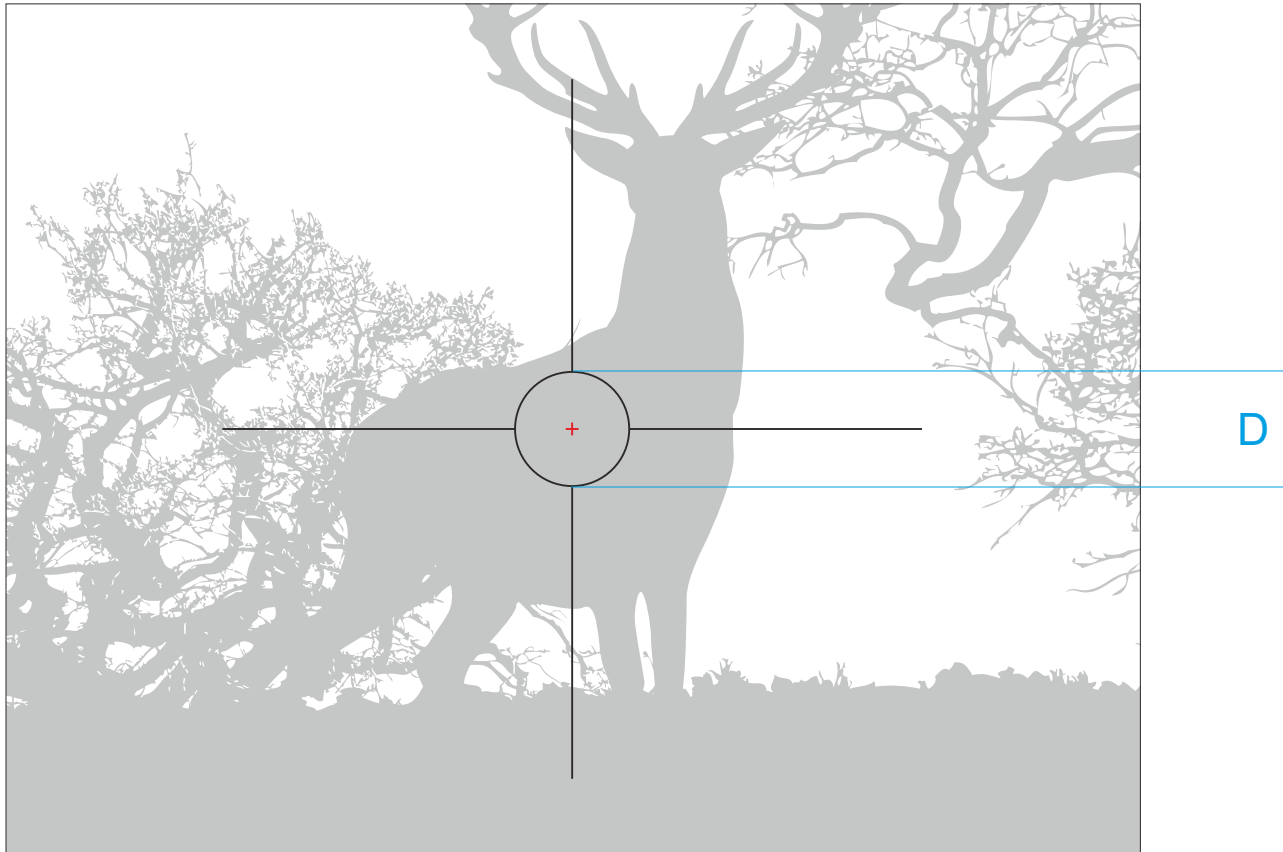

Model	MOA			cm @ 100 m		
	XQ38	XQ50	XP50	XQ38	XQ50	XP50
<b>Section A</b>	4.0	3.1	5.1	11.7	8.9	14.9
<b>Section B</b>	4.0	3.1	5.1	11.7	8.9	14.9
<b>Section C</b>	0.6	0.4	0.7	1.7	1.3	2.1
<b>Section D</b>	34.4	34.4	68.8	100	100	200

Thermal Imaging Riflescopes  
**THERMION 2**

# H50i

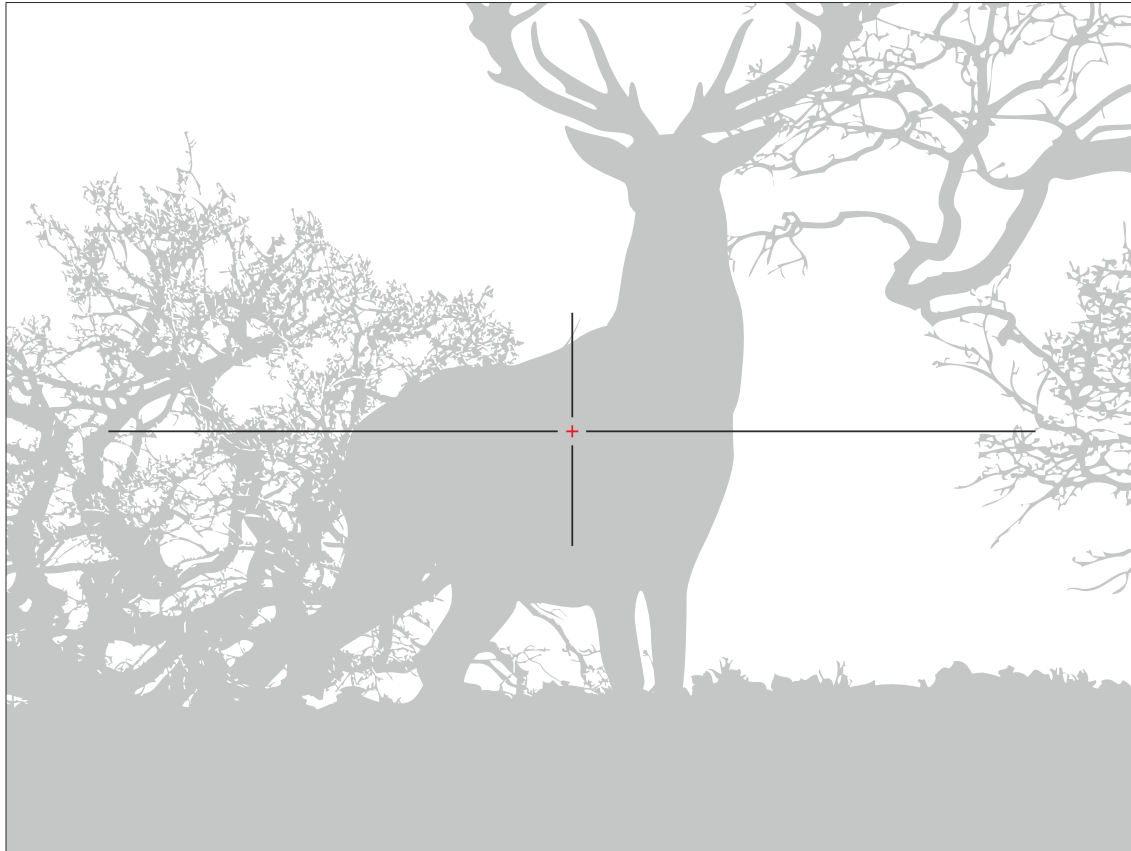

Reticle parameters (for minimum magnification)

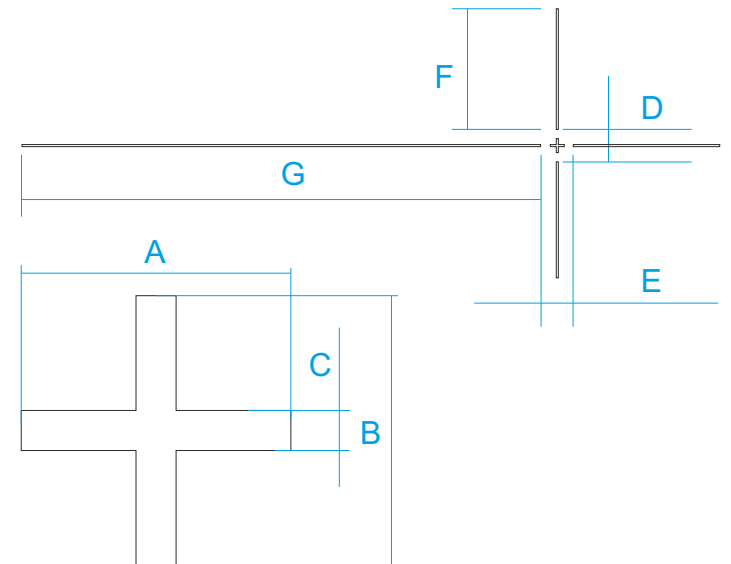

Thermal Imaging Riflescopes  
**THERMION 2**

Model	MOA			cm @ 100 m		
	XQ38	XQ50	XP50	XQ38	XQ50	XP50
<b>Section A</b>	4.0	3.1	5.1	11.7	8.9	14.9
<b>Section B</b>	4.0	3.1	5.1	11.7	8.9	14.9
<b>Section C</b>	0.6	0.4	0.7	1.7	1.3	2.1
<b>Section D</b>	10	10	20	29	29	58
<b>Section E</b>	10	10	20	29	29	58
<b>Section F</b>	53	39.1	63.5	154	114	185
<b>Section G</b>	176.4	132.9	219.8	513	387	640

# X50i

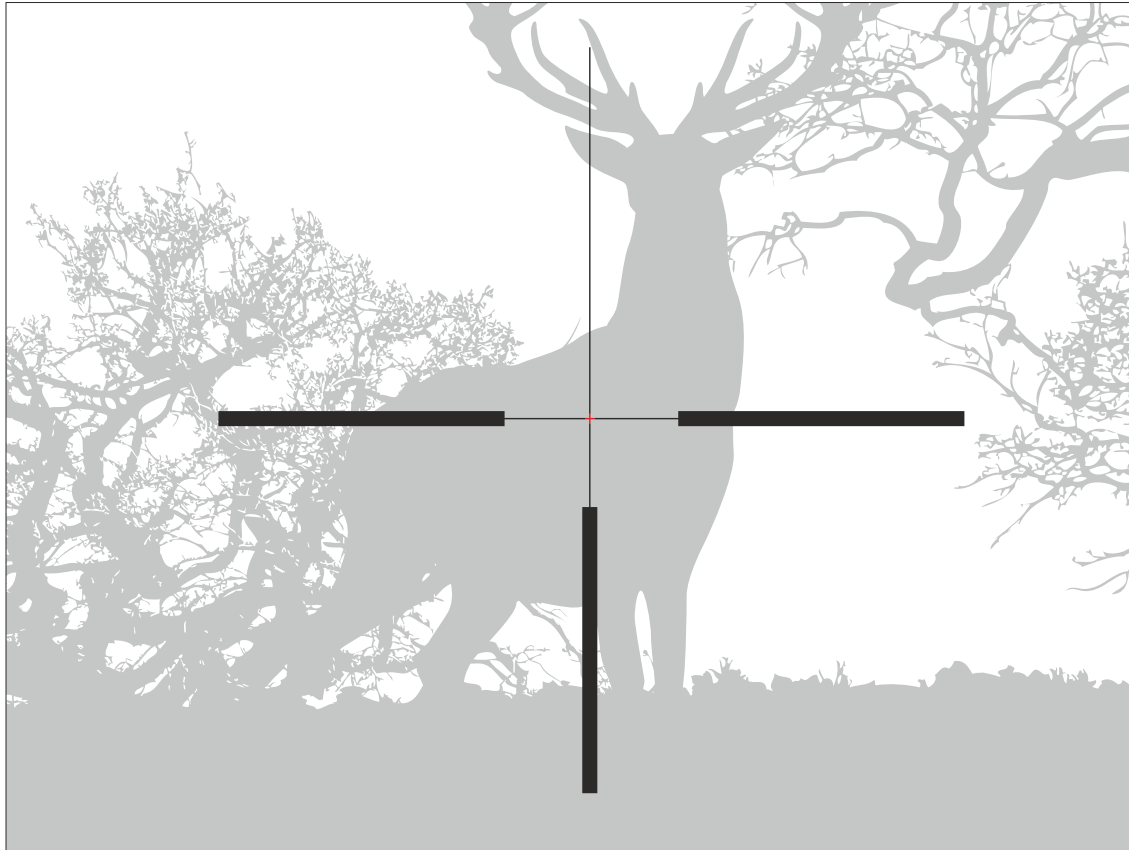

Reticle parameters (for minimum magnification)

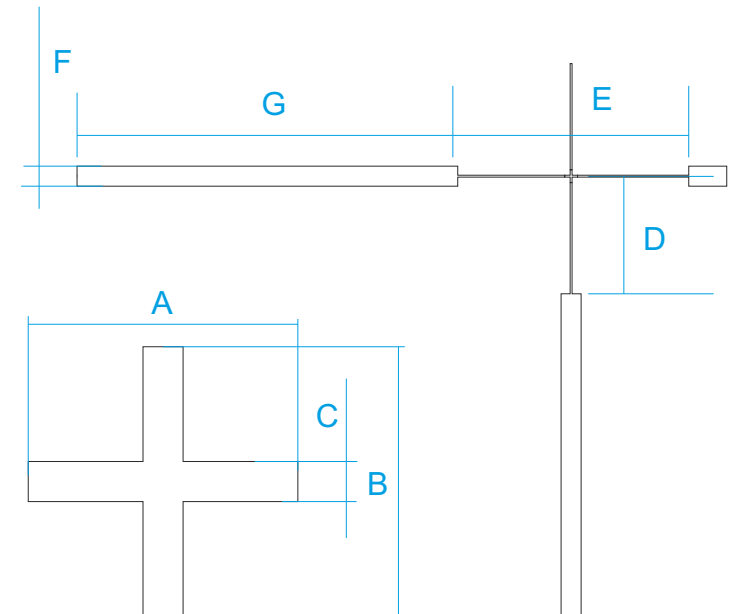

Thermal Imaging Riflescopes  
**THERMION 2**

Model	MOA			cm @ 100 m		
	XQ38	XQ50	XP50	XQ38	XQ50	XP50
Section A	4.0	3.1	5.1	11.7	8.9	14.9
Section B	4.0	3.1	5.1	11.7	8.9	14.9
Section C	0.6	0.4	0.7	1.7	1.3	2.1
Section D	34.4	34.4	34.4	100	100	100
Section E	68.8	68.8	68.8	200	200	200
Section F	1.8	1.2	2.1	5.1	3.5	6.1
Section G	164	121	195	478	351	568

# T54i

Reticle parameters (for minimum magnification)

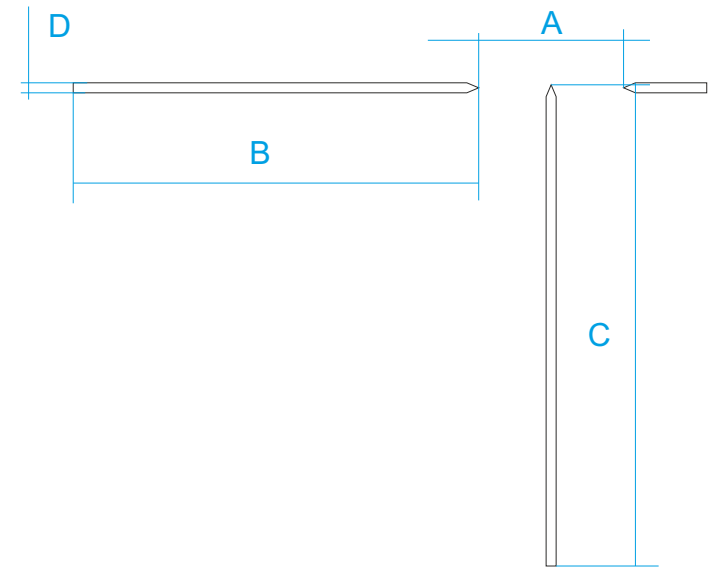

Thermal Imaging Riflescopes  
**THERMION 2**

Model	MOA			cm @ 100 m		
	XQ38	XQ50	XP50	XQ38	XQ50	XP50
<b>Section A</b>	34.4	34.4	68.8	100	100	200
<b>Section B</b>	164	121	195	478	351	567
<b>Section C</b>	183	139	232	534	406	676
<b>Section D</b>	4.0	3.1	5.1	11.7	8.9	15



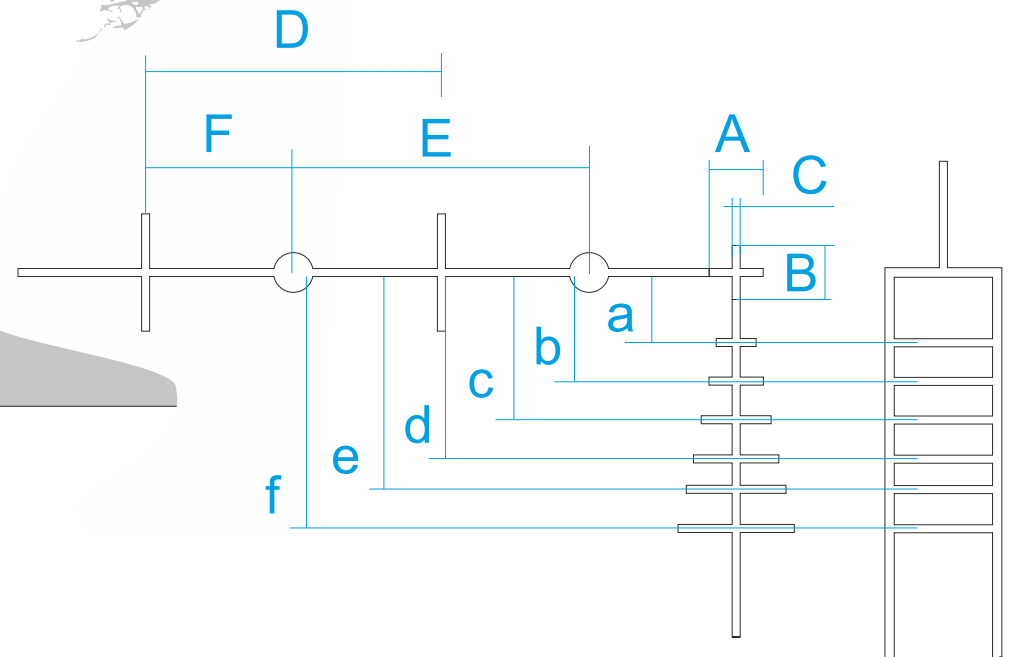
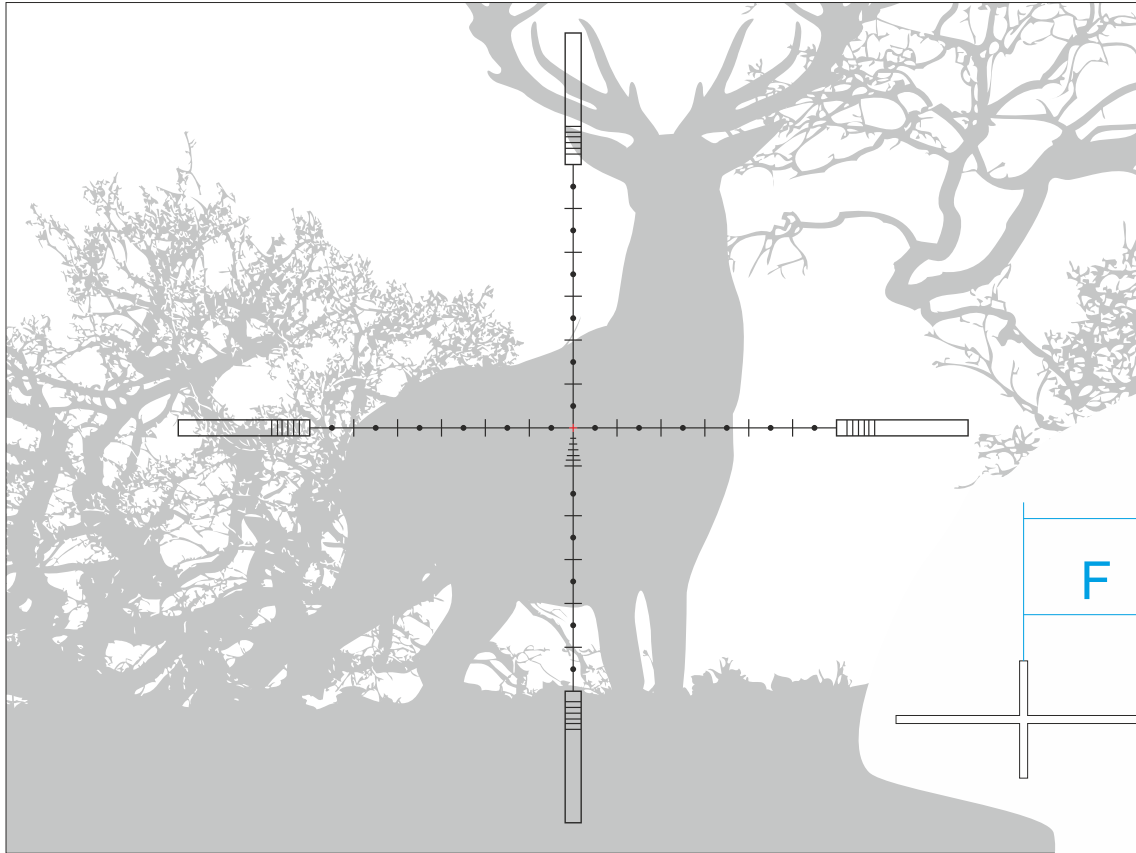

## THERMION 2 XP50

	MOA	cm @ 100 m
<b>Section A</b>	5.1	14.9 On minimal magnification
<b>Section B</b>	5.1	14.9 On minimal magnification
<b>Section C</b>	0.7	2 On minimal magnification
<b>Section D</b>	3.5	10 (1 mil) On 16x magnification
<b>Section E</b>	3.5	10 (1 mil) On 16x magnification
<b>Section F</b>	3.5	10 (1 mil) On 8x magnification

<b>Section a</b>	1 mil (10 cm @ 100 m) on 2x magnification	
<b>Section b</b>	1 mil (10 cm @ 100 m) on 4x magnification	
<b>Section c</b>	1 mil (10 cm @ 100 m) on 8x magnification	
<b>Section d</b>	1 mil (10 cm @ 100 m) on 12x magnification	
<b>Section e</b>	1 mil (10 cm @ 100 m) on 16x magnification	

## THERMION 2 XQ50

	MOA	cm @ 100 m
<b>Section A</b>	3.1	8.9 On minimal magnification
<b>Section B</b>	3.1	8.9 On minimal magnification
<b>Section C</b>	0.4	1.3 On minimal magnification
<b>Section D</b>	3.5	10 (1 mil) On 14x magnification
<b>Section E</b>	3.5	10 (1 mil) On 14x magnification
<b>Section F</b>	3.5	10 (1 mil) On 7x magnification

<b>Section a</b>	1 mil (10 cm @ 100 m) on 3.5x magnification	
<b>Section b</b>	1 mil (10 cm @ 100 m) on 5x magnification	
<b>Section c</b>	1 mil (10 cm @ 100 m) on 7x magnification	
<b>Section d</b>	1 mil (10 cm @ 100 m) on 10x magnification	
<b>Section e</b>	1 mil (10 cm @ 100 m) on 14x magnification	

## THERMION 2 XQ38

	MOA	cm @ 100 m
<b>Section A</b>	4	11.8 On minimal magnification
<b>Section B</b>	4	11.8 On minimal magnification
<b>Section C</b>	0.6	1.7 On minimal magnification
<b>Section D</b>	3.5	10 (1 mil) On 10x magnification
<b>Section E</b>	3.5	10 (1 mil) On 10x magnification
<b>Section F</b>	3.5	10 (1 mil) On 5x magnification

<b>Section a</b>	1 mil (10 cm @ 100 m) on 2.5x magnification	
<b>Section b</b>	1 mil (10 cm @ 100 m) on 4x magnification	
<b>Section c</b>	1 mil (10 cm @ 100 m) on 5x magnification	
<b>Section d</b>	1 mil (10 cm @ 100 m) on 7.5x magnification	
<b>Section e</b>	1 mil (10 cm @ 100 m) on 10x magnification	

# Reticle parameters

**SCALABLE**

# M56Fi

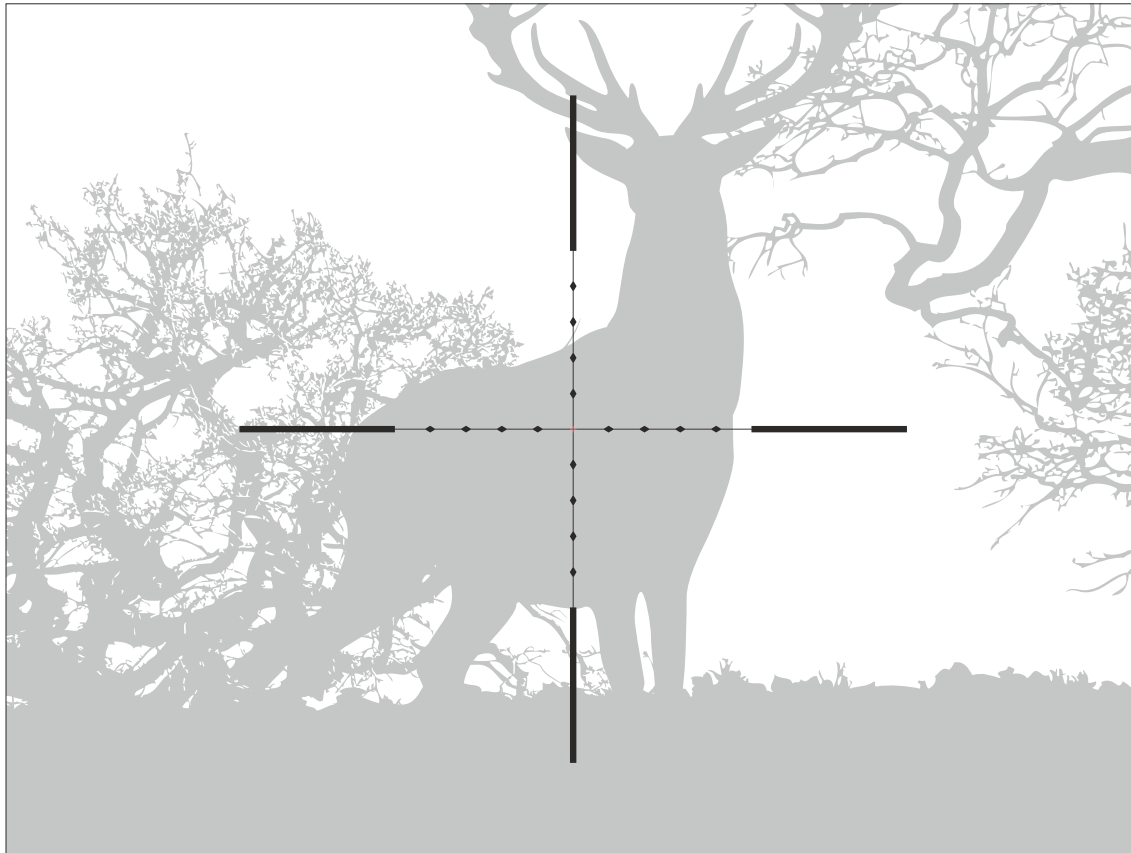

Reticle parameters (apply to all magnifications)

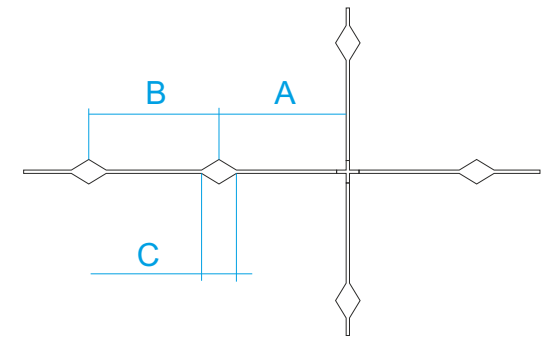

	MOA	cm @ 100 m
<b>Section A</b>	3.5	10 (1 mil)
<b>Section B</b>	3.5	10 (1 mil)
<b>Section C</b>	0.86	2.5 (0.25 mil)

Thermal Imaging Riflescopes  
**THERMION 2**

**SCALABLE**

# X51Fi-300

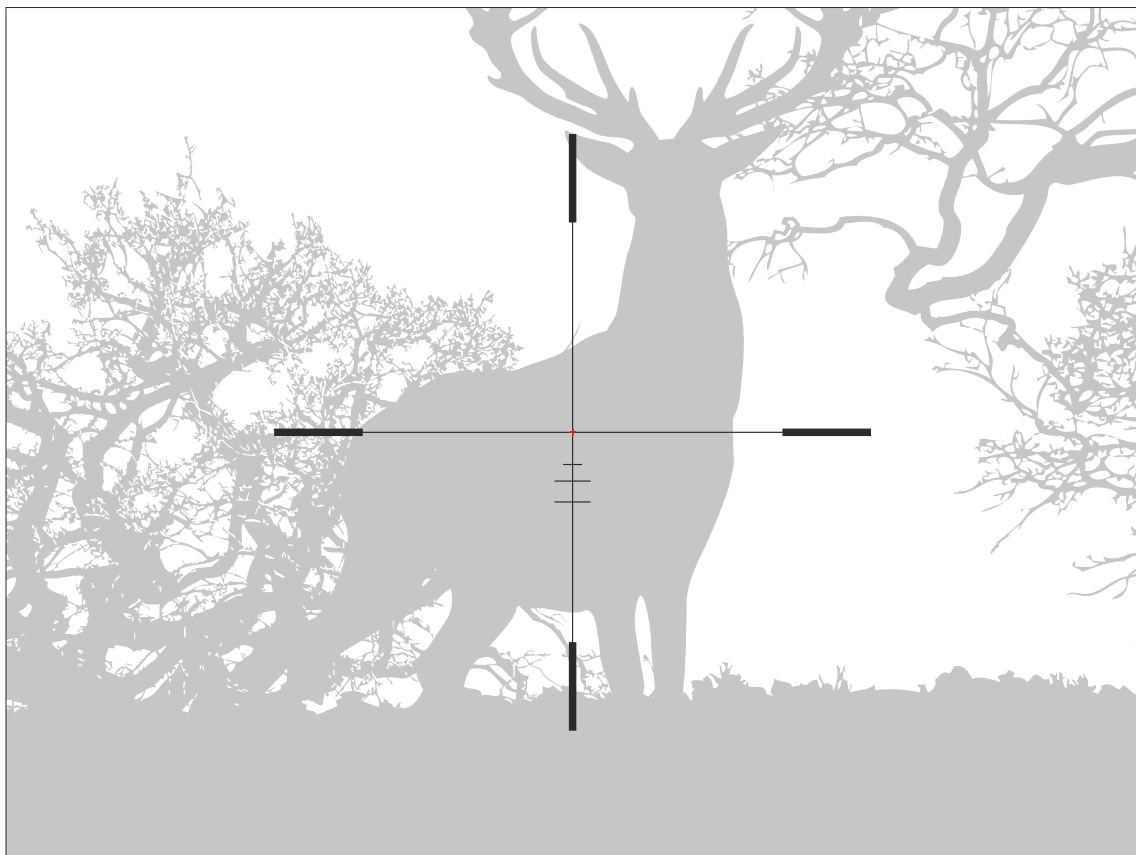

Reticle parameters (apply to all magnifications)

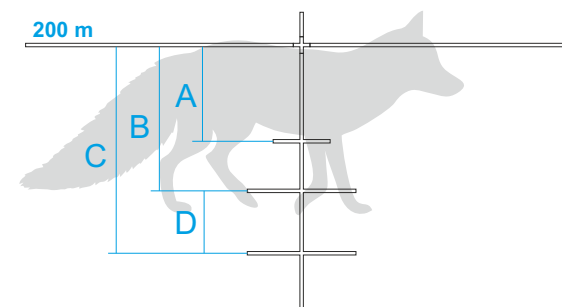

	200 m	300 m
<b>Section A</b>	15 cm (fox body)	23 cm (roe deer body)
<b>Section B</b>	23 cm (roe deer body)	35 cm (wild boar body)
<b>Section C</b>	35 cm (wild boar body)	50 cm (deer body)
<b>Section D</b>	—	15 cm (fox body)

Thermal Imaging Riflescopes  
**THERMION 2**

**SCALABLE**

# M57Fi

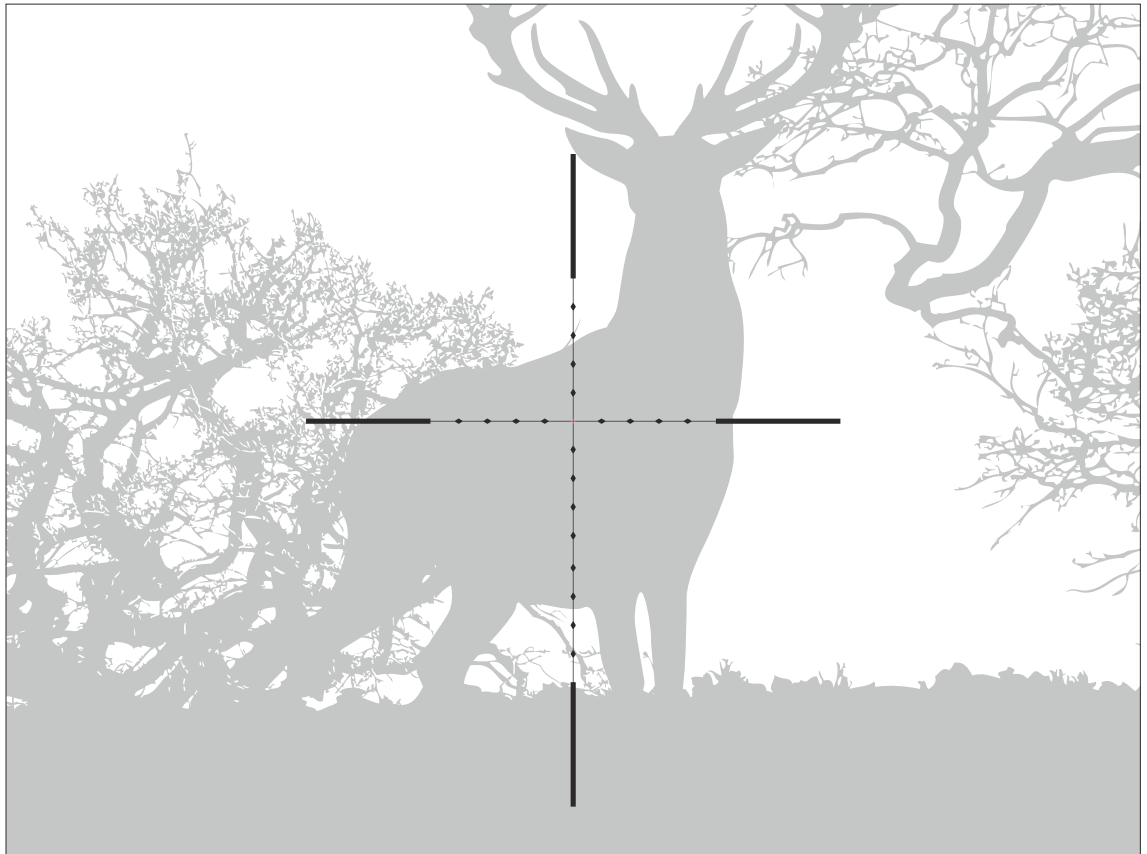

Reticle parameters (apply to all magnifications)

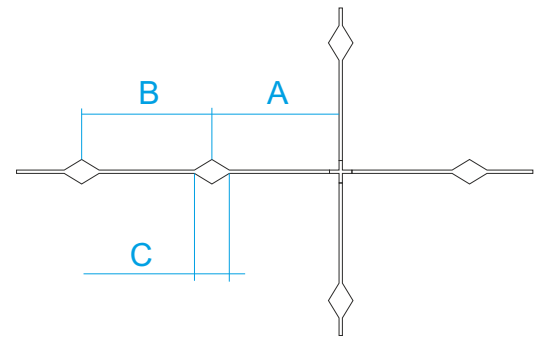

	MOA	cm @ 100 m
<b>Section A</b>	3.5	10 (1 mil)
<b>Section B</b>	3.5	10 (1 mil)
<b>Section C</b>	0.86	2.5 (0.25 mil)



 [www.pulsar-vision.com](http://www.pulsar-vision.com)

 @PulsarVision

 @pulsar.vision

 Pulsar Vision