

TiS20+/TiS20+ MAX

Thermal Imager

Users Manual



November 2019 Rev. 1, 5/20

© 2019-2020 Fluke Corporation. All rights reserved. Specifications are subject to change without notice.

All product names are trademarks of their respective companies.

LIMITED WARRANTY AND LIMITATION OF LIABILITY

Each Fluke product is warranted to be free from defects in material and workmanship under normal use and service. The warranty period is two years and begins on the date of shipment. Parts, product repairs, and services are warranted for 90 days. This warranty extends only to the original buyer or end-user customer of a Fluke authorized reseller, and does not apply to fuses, disposable batteries, or to any product which, in Fluke's opinion, has been misused, altered, neglected, contaminated, or damaged by accident or abnormal conditions of operation or handling. Fluke warrants that software will operate substantially in accordance with its functional specifications for 90 days and that it has been properly recorded on non-defective media. Fluke does not warrant that software will be error free or operate without interruption.

Fluke authorized resellers shall extend this warranty on new and unused products to end-user customers only but have no authority to extend a greater or different warranty on behalf of Fluke. Warranty support is available only if product is purchased through a Fluke authorized sales outlet or Buyer has paid the applicable international price. Fluke reserves the right to invoice Buyer for importation costs of repair/replacement parts when product purchased in one country is submitted for repair in another country.

Fluke's warranty obligation is limited, at Fluke's option, to refund of the purchase price, free of charge repair, or replacement of a defective product which is returned to a Fluke authorized service center within the warranty period.

To obtain warranty service, contact your nearest Fluke authorized service center to obtain return authorization information, then send the product to that service center, with a description of the difficulty, postage and insurance prepaid (FOB Destination). Fluke assumes no risk for damage in transit. Following warranty repair, the product will be returned to Buyer, transportation prepaid (FOB Destination). If Fluke determines that failure was caused by neglect, misuse, contamination, alteration, accident, or abnormal condition of operation or handling, including overvoltage failures caused by use outside the product's specified rating, or normal wear and tear of mechanical components, Fluke will provide an estimate of repair costs and obtain authorization before commencing the work. Following repair, the product will be returned to the Buyer transportation prepaid and the Buyer will be billed for the repair and return transportation charges (FOB Shipping Point).

THIS WARRANTY IS BUYER'S SOLE AND EXCLUSIVE REMEDY AND IS IN LIEU OF ALL OTHER WARRANTIES, EXPRESS OR IMPLIED, INCLUDING BUT NOT LIMITED TO ANY IMPLIED WARRANTY OF MERCHANTABILITY OR FITNESS FOR A PARTICULAR PURPOSE. FLUKE SHALL NOT BE LIABLE FOR ANY SPECIAL, INDIRECT, INCIDENTAL OR CONSEQUENTIAL DAMAGES OR LOSSES, INCLUDING LOSS OF DATA, ARISING FROM ANY CAUSE OR THEORY.

Since some countries or states do not allow limitation of the term of an implied warranty, or exclusion or limitation of incidental or consequential damages, the limitations and exclusions of this warranty may not apply to every buyer. If any provision of this Warranty is held invalid or unenforceable by a court or other decision-maker of competent jurisdiction, such holding will not affect the validity or enforceability of any other provision.

Fluke Corporation
P.O. Box 9090
Everett, WA 98206-9090
U.S.A.

Table of Contents

Title	Page
Introduction	1
How to Contact Fluke.....	1
Safety Information.....	2
Product Familiarization	2
Front	2
Touch Screen (Display)	4
Control Panel.....	5
Primary and Secondary Triggers	6
Basic Operation	6
Turn On and Off the Product	6
Capture Image.....	6
Save Images to PC.....	7
Menu Controls.....	7
Main Menu	9
Measurement Menu.....	10
Level/Span.....	10
Emissivity Adjustment.....	12
Transmissivity.....	13
Image Menu.....	13
Palette Menu	14
Display Menu	14
Marker	15
Spot Box.....	15
Device Settings Menu.....	16
Fluke Connect Menu.....	18
Asset Identification (Asset ID).....	18
Assign Asset ID Tag with a QR Code or Barcode	18
Assign Asset ID Tag Manually.....	19
Exit an Asset ID Tag.....	19
Assign a Different Asset ID Tag	19
Connection Icons	20
Save Images to Fluke Connect Cloud	21
Sign in to Fluke Connect WiFi Network	21
Sign out of Fluke Connect WiFi Network.....	22
Sign in to Fluke Connect Cloud	22
Sign out of Fluke Connect Cloud.....	22
Fluke Connect Wireless System.....	23
Pair Hotspot to Fluke Connect.....	23
Pair to Mobile App	24

Save Images to Shared Folder	24
Sign in to Shared Folder WiFi Network	25
Sign out of Shared Folder WiFi Network.....	25
Sign in to Shared Folder	26
Sign out of Shared Folder	27
Memory Menu (Memory Gallery).....	27
View Image	28
Notes	28
Notes with Single Image	28
Add a Note to Multiple Images	29
Delete Images	29
Delete an Image.....	29
Delete Multiple Images	29
Delete All Images.....	30
Flag an Image	30
Asset ID.....	30
Fluke Connect Desktop Software.....	31
Download Fluke Connect Software	31
Update Firmware.....	31
Accessories	32
Maintenance	32
Clean the Case	32
Lens Care.....	32
Battery Care	33
Charge Batteries	33
Two-Bay Battery Charger Base	33
AC Power Socket on Imager.....	34
Optional 12 V Vehicle Charger	34
Radio Frequency Data	34
Specifications	34

Introduction

The Fluke TiS20+/TiS20+ MAX Thermal Imager (the Product or Imager) is a handheld, infrared imaging camera for use in many applications. These applications include equipment troubleshooting, preventive and predictive maintenance, building diagnostics, and research and development.

The Product shows thermal images on a high-visibility, industrial-quality LCD touch screen. The Product saves images to internal memory or SD card that can be transferred to a PC through a direct USB connection to the PC or by wireless transfer to a PC or mobile device.

The Product includes Fluke Connect™ desktop software. Fluke Connect is a high-performance, professional software suite for quality analysis and reporting.

How to Contact Fluke

To contact Fluke, call one of the following telephone numbers:

- Technical Support USA: 1-800-44-FLUKE (1-800-443-5853)
- Calibration/Repair USA: 1-888-99-FLUKE (1-888-993-5853)
- Canada: 1-800-36-FLUKE (1-800-363-5853)
- Europe: +31 402-675-200
- Japan: +81-3-6714-3114
- Singapore: +65-6799-5566
- China: +86-400-921-0835
- Brazil: +55-11-3530-8901
- Anywhere in the world: +1-425-446-5500

Or, visit Fluke's website at www.fluke.com.

To register your product, visit <http://register.fluke.com>.

To view, print, or download the latest manual or manual supplement, visit <http://us.fluke.com/usen/support/manuals>.

To request a printed manual, visit www.fluke.com/productinfo.

Safety Information

General Safety Information is in the printed Safety Information document that ships with the Product and at www.fluke.com. More specific safety information is listed where applicable.

A **Warning** identifies hazardous conditions and procedures that are dangerous to the user. A **Caution** identifies conditions and procedures that can cause damage to the Product or the equipment under test.

Product Familiarization

The manual explains the features of the Product.

Front

Table 1 shows the front of the Product.

Table 1. Front

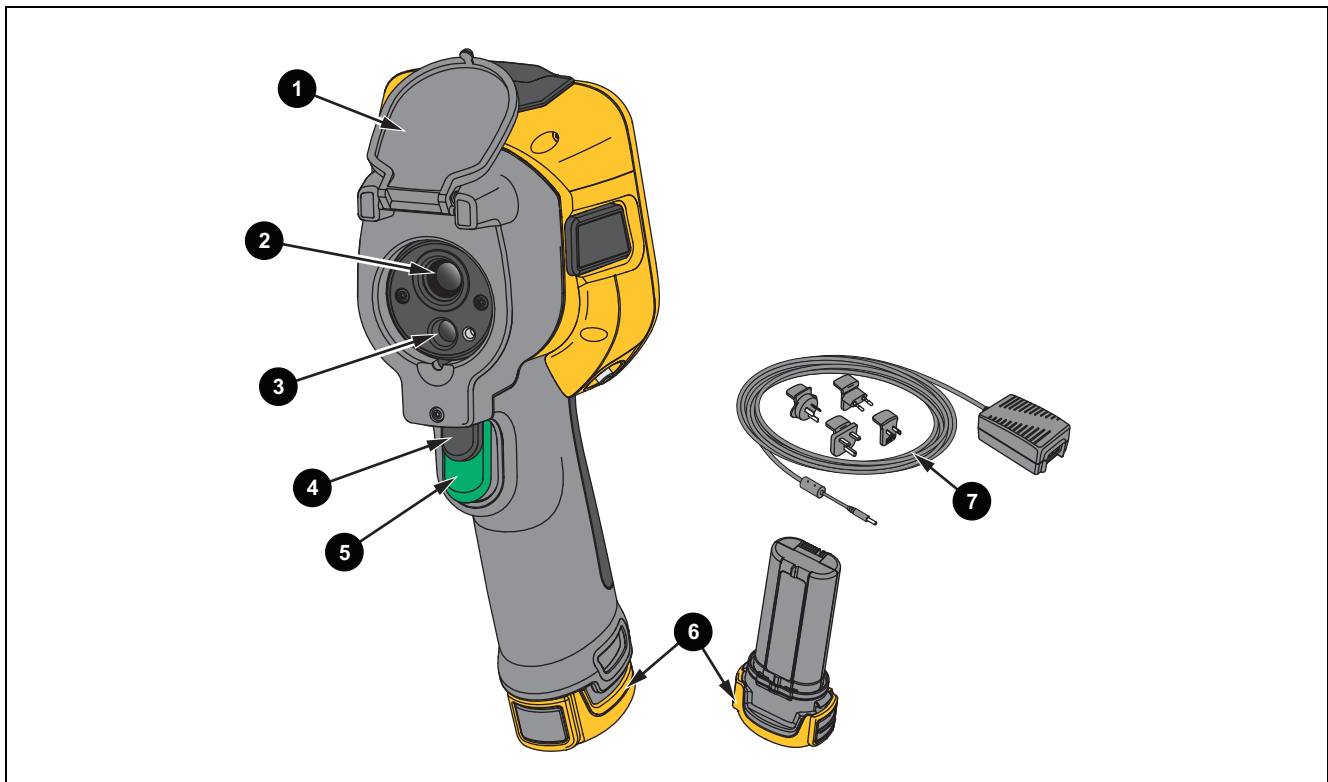

Item	Description	Item	Description
1	Retractable lens cover	5	Primary trigger
2	Infrared camera lens	6	Lithium-ion smart battery
3	Visual light camera lens	7	AC power supply with universal adapters
4	Secondary trigger	8	2-bay battery charging base

Table 2 shows the back of the Product.

Table 2. Back

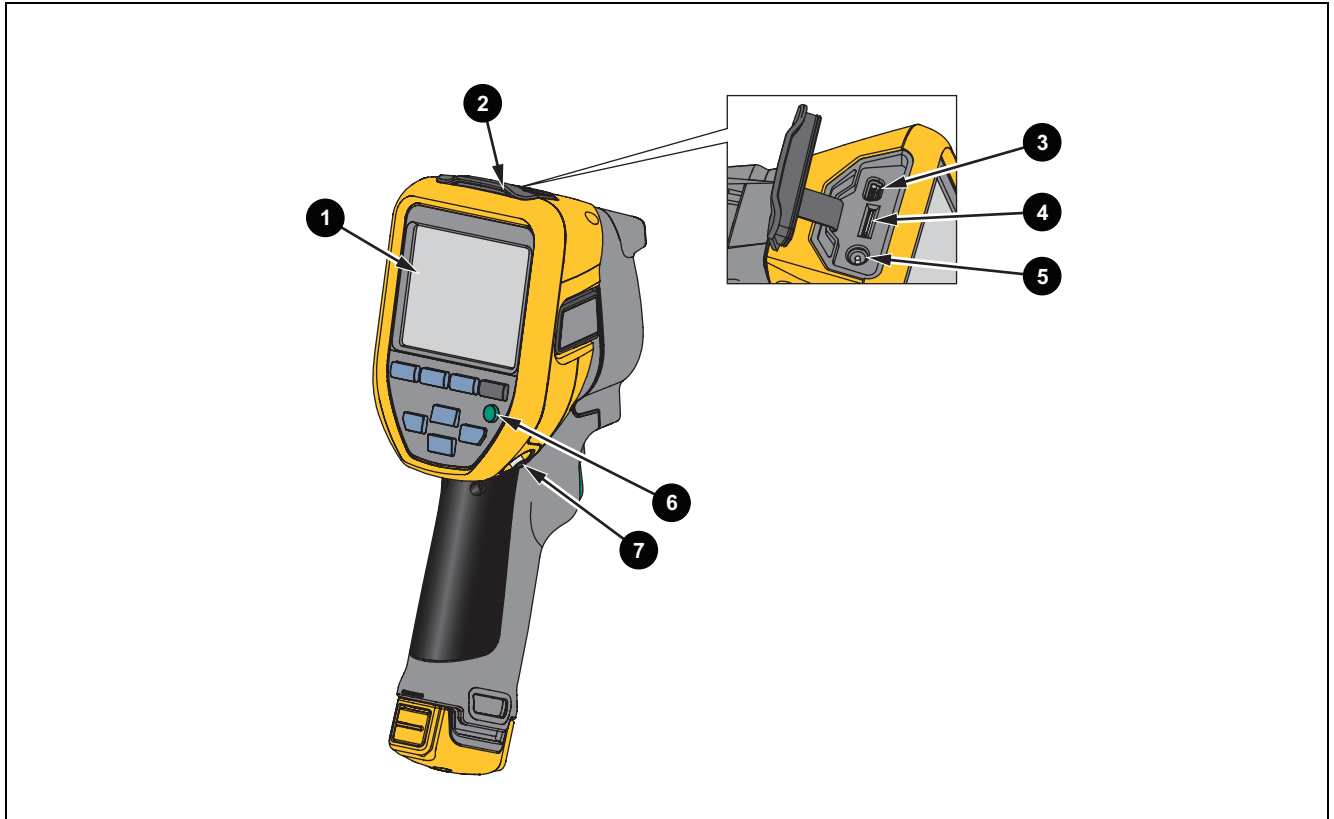

Item	Description	Item	Description
1	LCD touch screen (display)	5	AC Adapter/Charger Input Terminal
2	Connector cover	6	Control panel
3	USB port	7	Hand strap anchor
4	SD memory card slot		

Touch Screen (Display)

The touch screen is the user interface of the Product. The touch screen has a backlight for work in dimly lit spaces.

Table 3 shows the default information on the screen of the Product.

Table 3. Display

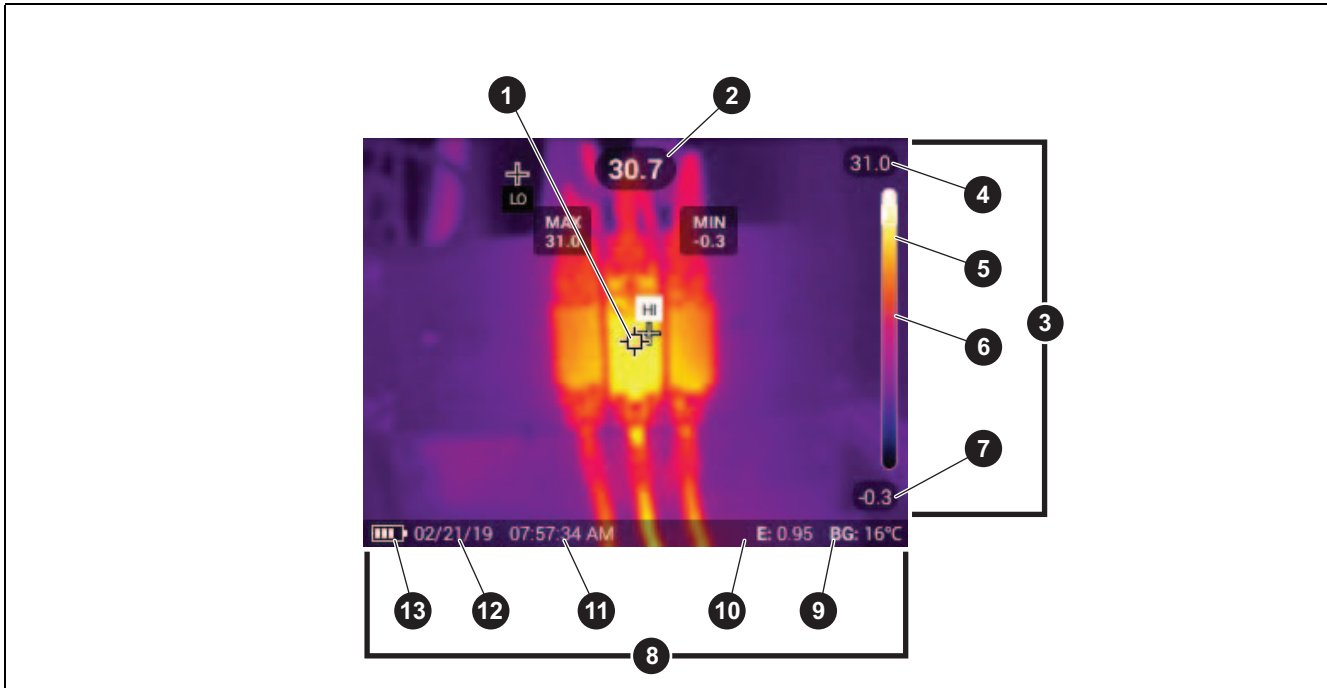







Item	Description	Item	Description
1	Center point marker	8	Status bar
2	Center point temperature	9	Background temperature
3	Scale	10	Emissivity value
4	Temperature range upper value	11	Time
5	Range bar The range of colors in the palette mapped to a certain range of temperatures	12	Date
6	Center point color in relation to the palette	13	Battery status
7	Temperature range lower value		

Control Panel

The control panel is used to change parameters or select functions and options. Table lists the functions of the buttons on the Control Panel.

Table 4. Control Panel

Button	Description
	Push to turn on or off the Product.
	Push to open the main menu. Within a submenu: Push to either save the change and go back to the previous menu. Or Push to perform the function listed on the submenu key.
	Push to open the main menu. Within a submenu: Push to either cancel the change and go back to the previous menu. Push to perform the function listed on the submenu key. Or Push and hold for 2 seconds to exit out of all menus.
	Push and hold for 2 seconds to toggle between Manual/Auto Level and Span. With Level/Span set to Manual , push to rescale the temperature values on the display at that time. See Level/Span .
	Push to review, edit, and delete captured images. See Memory Menu (Memory Gallery) .
	Push to move the cursor and highlight an option. With Level/Span set to Manual , push to adjust the Level and Span. See Level/Span . With Level/Span set to Auto , push to adjust the IR-Fusion level. In the Spot Box menu, push to adjust the size or position of the spot box. See Spot Box . In the Marker menu, push to move the marker. See Marker .

Primary and Secondary Triggers



The two-part trigger is located in the standard trigger position for a pistol-grip device. The larger, green trigger is the primary trigger. The smaller, black trigger is the secondary trigger.

Use the primary trigger to capture an image to save or edit. Use the secondary trigger to open the Asset Identification mode to scan a QR code or barcode to attach an asset to an image.

Basic Operation

Turn On and Off the Product

Before you use the Product for the first time, charge the battery. See [Charge Batteries](#).

To turn on the Product, push and hold  for 1 second. To turn off the Product, push and hold  for 2 seconds.

With the Product on, push and release  to NUC (calibrate) the camera sensor.

Note

All thermal imagers need sufficient warm-up time for accurate temperature measurements and best image quality. Warm-up time can vary by model and environmental conditions. Although most imagers are fully warmed up in 3 minutes to 5 minutes, wait a minimum of 10 minutes if the most accurate temperature measurement is important to your application. When you move an imager between environments with large differences in ambient temperature, allow for additional adjustment time.

Capture Image

To capture an image:

1. Focus on a target.
2. Push and release the **Primary Trigger** button or double tap on the display to capture and freeze the image.

The image is in the memory buffer for you to save, add or remove an asset ID, or edit.

Note

Asset ID tags, flags, and notes can be saved with images captured in .is2 file format only. To select .is2 file format, see [Device Settings Menu](#).

3. To assign an asset ID tag to the image, tap **Scan Asset ID**, or tap **Remove Asset ID** to remove an asset ID tag from the image. See [Asset Identification \(Asset ID\)](#).
4. To add a flag to the image, tap **Edit > Flag Image**, or tap **Edit > Unflag Image** to remove the flag from the image. See [Flag an Image](#). Tap **Edit** again to return to the image preview screen.
5. To add a note to the image, tap **Edit > Add Note**. See [Notes](#). Tap **Edit** again to return to the image preview screen.
6. Tap **Save**.

Save Images to PC

To save images to a PC with the USB cord:

1. Turn on the Product.
2. Connect one end of the USB cord into the USB port on the Product and the other end into a USB port on a PC.

The PC recognizes the Product as an external memory storage device.

3. On the PC:
 - a. Browse to the directory on the Product.
 - b. Copy and paste or drag the images to a directory on the PC.
4. Remove the USB cord from the PC and the Product.

Menu Controls















To use the menus to change and view settings:

1. Tap the display to open the main menu.
2. Tap an icon on the main menu to open a submenu. See [Table 6](#).

The background of the selected icon changes to yellow.
3. Tap a menu control to set and change options. See [Table 5](#).
4. To close a submenu and return to live camera mode, tap the submenu icon again.

Table 5 lists the menu controls.

Table 5. Menu Controls





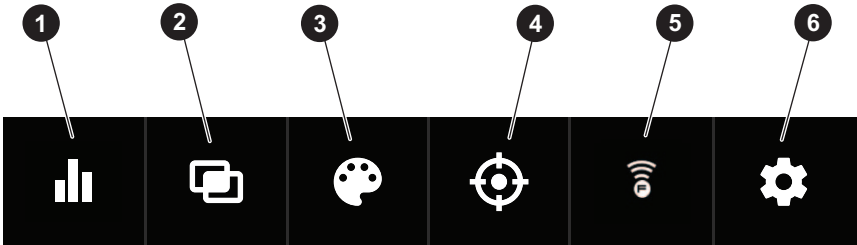

Item	Control	Function
Slider bar		Adjusts a value. Touch and slide the bar to the left to decrease the value or to the right to increase the value.
Toggle switch		Turns on or off a feature. Feature on.
Radio button		Selects one item from a list. Option selected.
More menu options button		Opens a menu to show other menu options.
Option menu button		Opens an option menu to adjust a setting.
Numerical value adjuster buttons		Decreases a numerical value.
		Increases a numerical value.
Back arrow		Returns to the previous menu.
Exit button		Closes menu and returns to camera mode. Or, Exits out of an Asset ID. See Asset ID .
Delete button		Delete an image. See Delete Images .
Note button		View, add, or edit a note. See Notes .
Add a note button		With at least one note attached to an image, add another note to the image. See Notes .
Asset ID button		Add or remove an asset ID tag. See Asset ID .
Flag toggle switch		Toggle to add or remove a flag. See Flag an Image .

Main Menu

Table 6 lists the secondary menus available in the Main Menu.

Table 6. Main Menu



Item	Secondary Menu	Option	Function
1	 Measurement	<options>	Set the infrared settings. See Measurement Menu .
2	 Image	IR-Fusion	Set the IR-Fusion level. See Image Menu .
3	 Palette	<options>	Set the palette to use on the image. See Palette Menu .
4	 Display	<options>	Set the features to show on the display. See Display Menu .
5	 Fluke Connect	<options>	Save images over a WiFi connection. See Fluke Connect Menu . <i>Note</i> <i>The Fluke Connect system is not available in all countries.</i>
6	 Device Settings	<options>	Set user preferences and view information about the Product. See Device Settings Menu .

Measurement Menu

Table 7 lists the options available in the Measurement menu.

Table 7. Measurement Menu

Option Menu	Option	Description
Level/Span	Auto	Sets the Level/Span to adjust automatically or manually.
	Manual	
	Set Level/Span	With Level/Span set to Manual , changes the Level/Span. See Level/Span .
Emissivity	Custom Value	Sets a custom emissivity value when a value from the standard emissivity table is not appropriate for the measurement. See Emissivity Adjustment .
	<options>	Select an emissivity value from a list of common materials. Use the scroll bar to see all of the options. See Emissivity Adjustment .
Background	<options>	Changes the background temperature to compensate for reflected background temperature. Very hot objects or very cold objects can affect the apparent temperature and measurement accuracy of the target, especially when surface emissivity is low. Adjust the reflected background temperature to improve the accuracy of the measurement.
Transmissivity	<options>	Changes the values used to calculate the temperature based on the transmission percentage of the infrared-transparent window (IR window). See Transmissivity .

Level/Span

Level and Span are values within the total range of temperature. Level is the temperature level to view within the total range of temperatures. Span is the span of temperatures to view within the total range of temperatures. See Table 8.

Table 8. Level and Span Settings

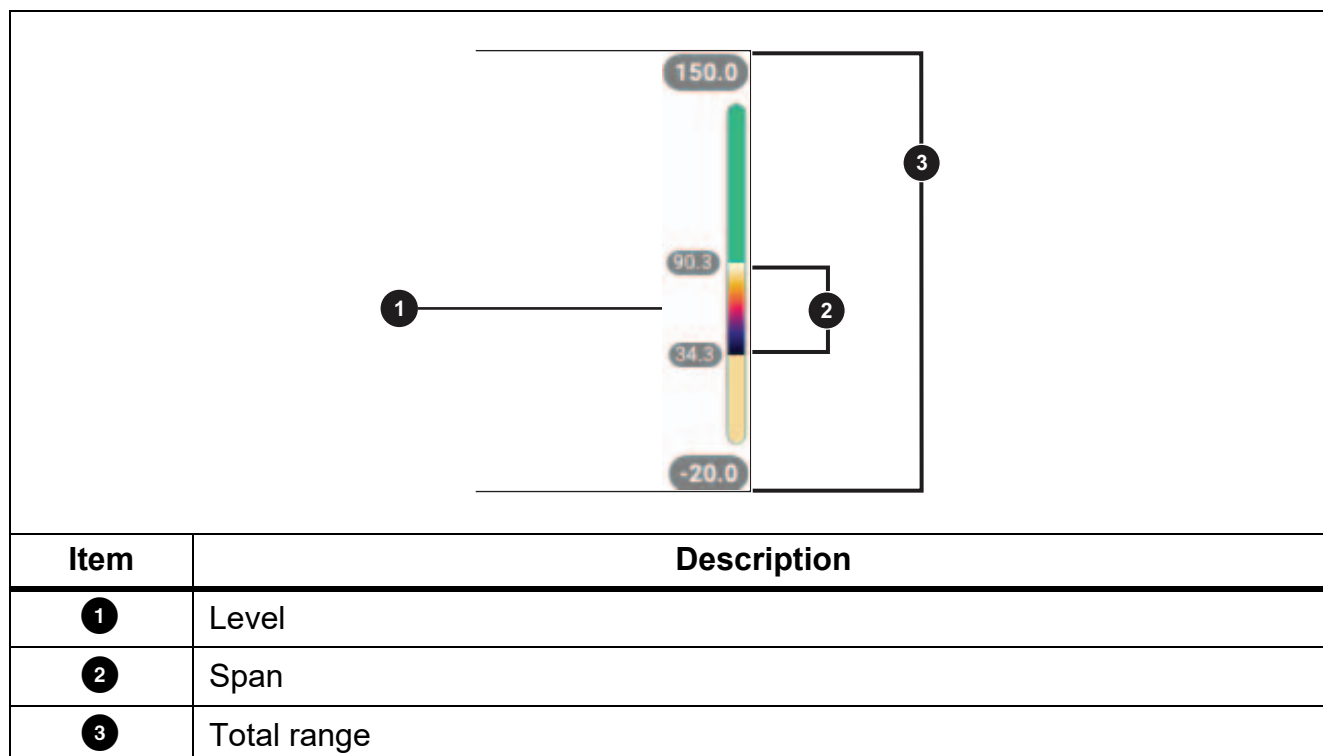

With Level/Span set to **Auto**, the Imager sets **Level/Span** based on the total temperature range.

With **Level/Span** set to **Manual**, the level setting moves the thermal span up or down within the total temperature range.

To change Level/Span:

1. Select > **Level/Span** > **Manual**, or push for 2 seconds.
2. Select **Set Level/Span**.
3. Push:
 - to decrease the temperature span.
 - to increase the temperature span.
 - to move the span to a higher temperature level.
 - to move the span to a lower temperature level.

The scale along the right side of the display shows the thermal span increasing or decreasing in size and shows the span as it moves to different levels within the total range. See Table 8.

To use the temperature range high and low values on the display for future measurements:

1. Set Level/Span to **Manual**.
2. Push  to rescale the display and save the temperature values on the display at that time.

To use a different temperature range, use the arrow keys to change the Level/Span, or push  twice to rescale.

Note

The Imager always powers up in the same Level/Span mode, Auto or Manual, as when the Imager was powered down.

Emissivity Adjustment

All objects radiate infrared energy. The actual surface temperature and emissivity of the target affects the quantity of energy radiated. The Imager senses the infrared energy from the surface of the target and uses the data to calculate an estimated temperature value. Many common materials such as wood, water, skin, cloth, and painted surfaces, including metal, radiate energy well and have a high emissivity factor of $\geq 90\%$ (or 0.90). The Imager measures temperatures accurately on targets with a high emissivity.

Shiny surfaces or unpainted metals do not radiate energy well and have a low emissivity factor of < 0.60 . For the Imager to calculate a more accurate estimate of the actual temperature of targets with a low emissivity, adjust the emissivity setting.

Warning

To prevent personal injury, see emissivity information for actual temperatures. Reflective objects result in lower than actual temperature measurements. These objects pose a burn hazard.

Set emissivity as a direct value or from a list of emissivity values for some common materials. If the emissivity value is < 0.60 , a caution shows on the display.

Note

Surfaces with an emissivity of < 0.60 make it difficult to determine reliable and consistent actual temperatures. The lower the emissivity is the greater the potential of error is when the Imager calculates the temperature measurement because more of the energy reaching the camera is specified as background temperature. This is also true even when adjustments to the emissivity and reflected background adjustments are performed properly.

Transmissivity

When you do infrared inspections through IR windows, not all of the infrared energy emitted from the target is transmitted through the optical material in the window. If you know the transmission percentage of the window, adjust the transmission percentage in the Imager or in Fluke Connect desktop software to improve the accuracy of the measurement.

When you do not do infrared inspections through an IR window, set Transmissivity to 100 % to disable the correction percentage.

Image Menu

The IR-Fusion slider bar sets the Product to take images from full visible light mode to full IR-Fusion mode. Use a blend between visible light mode and IR-Fusion to view an object with some temperature overlays.

To adjust the IR-Fusion level:

1. Tap .
2. Use the slider bar to set the IR-Fusion level.

Alternatively, you can adjust the IR-Fusion level in camera mode:

With Level/Span set to **Auto**, push  or  to change the IR-Fusion level.

Or,

Touch the display and slide left to right to increase the level of IR-Fusion. Slide from right to left to decrease the IR-Fusion level. See Figure 1.

Figure 1. IR-Fusion Level

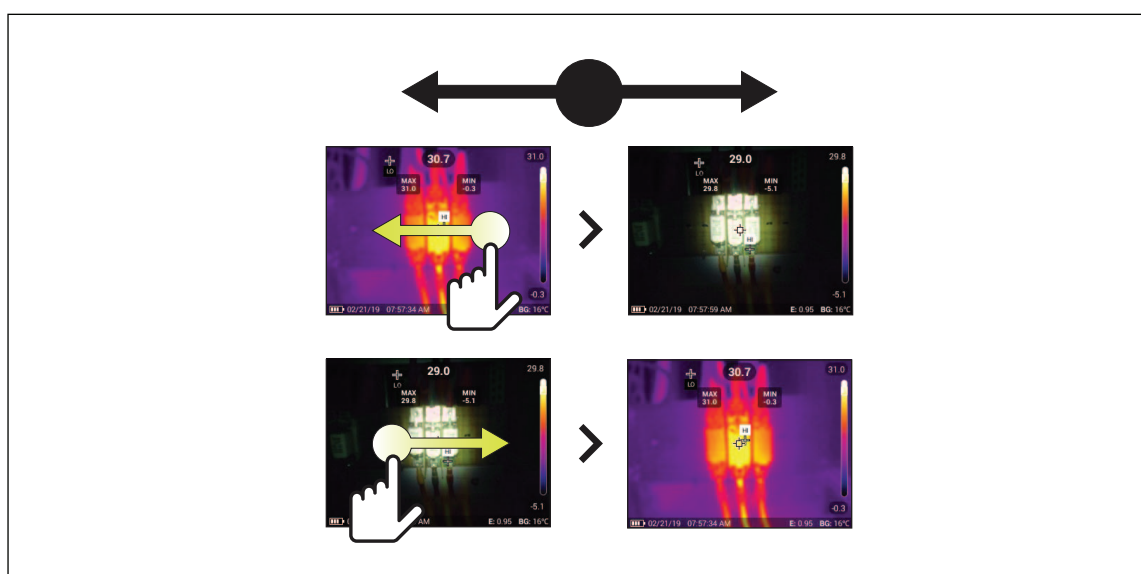

Palette Menu

The standard palettes offer an equal, linear presentation of colors that allow for best presentation of detail. The palettes are Grayscale, Ironbow, High Contrast, Amber, Hot Iron, and Blue-Red.

To change the palette of an image:

1. Tap .
2. Tap on a palette thumbnail.

A check mark shows on the selected palette. The color and temperature range bar on the display changes according to the selected palette. See Figure 2.

Figure 2. Palette and Range Bar Selection



Display Menu

Use the Display menu to set which features to show on the display. To show the Fluke logo on the display, see [Device Settings Menu](#). Table 9 lists the options in the Display menu.

Table 9. Display

Option	Description
Spot Temp (Min/Max)	Turn on or off the maximum and minimum temperature indicators on the display. The Spot Temperatures are floating HI and LO temperature indicators that move on the display as the temperature measurements of the image fluctuate.
Marker	Turns on or off a fixed-temperature spot marker. See Marker .
Spot Box	Turns on or off a temperature measurement zone (box) that centers on a target. See Spot Box .
Center Point	Turn on or off the Center point marker and Center point temperature.
Scale	Turn on or off the Scale.
Status Bar	Turn on or off the Status bar.

Marker

Use a fixed-temperature spot marker to show the temperature at the point before you save an image.

To set a marker, select  > **Markers** > **On**. The marker (+) shows on the display.

To change the position of the marker:

1. Drag the marker or push  /  /  /  to move the marker on the image.
2. Push **SELECT** to set the change and exit the menu.

Spot Box

Use the Spot Box feature to set a temperature measurement zone (box) to center on the target and to adjust the sizes or position of the box. The box expands or contracts to different levels within the infrared image. The box shows an approximate maximum (MAX), average (AVG), and minimum (MIN) temperature measurement in that area.

Note

*When you use **Spot Box**, the level and span of the Imager adjusts to the thermal scene within the spot box.*

To set a spot box, select  > **Spot Box** > **On**.

A white box shows on the display.  toggles between **Size** and **Position**.

To change the size and position of a box:





1. If necessary, push  to select **Size**.

 shows on the display.

2. Drag  to increase or decrease the size of the Spot Box.

Or,

Push:

-  to decrease the vertical size.
-  to increase the vertical size.
-  to decrease the horizontal size.
-  to increase the horizontal size.

3. Push  to select **Position**.

 shows on the display.

4. To move the box, drag the center of the box or push  /  /  / .

5. Push  to set the change and exit the menu.

Device Settings Menu

Table 10 lists the options in the Device Settings menu.

Table 10. Device Settings Menu

Option Menu	Option	Description
Backlight	NA	Use the slider bar to set the brightness level of the display.
File Format	IS2	Saves images as an .is2 file. Choose the .is2 file format when image modification and maximum resolution is needed. The .is2 file format consolidates the infrared image, radiometric temperature data, visible image, notes, and tags into a single file. To customize or separate the visible and infrared images, use Fluke Connect desktop software. Use to assign an asset ID tag or to flag an asset image.
	JPEG	Saves images as a .jpg file. Choose the .jpg file format for images with the smallest file size, where modification is not needed, and image quality and resolution are not as important.
Units	<options>	Sets the temperature units. This option is not available in all countries.
Distance	<options>	Sets the distance to use to adjust the parallax correction between the IR camera lens and visual light camera lens.
	Units	Sets the units to use to measure distance. This option is not available in all countries.
Change Filename	Filename Prefix	Changes the default filename that starts with IR_ to a different 4-character prefix.
	Reset Filename Numbers	Resets the file number to 00001.

Table 10. Device Settings Menu (cont.)

Option Menu	Option	Description
Auto Off	LCD Time Out	Sets the time before the display automatically turns off.
	Power Off	Sets the time before the Product automatically turns off.
Date	<options>	Sets the date format and the date.
Time	<options>	Sets the time format and the time.
Fluke Logo	NA	Shows or hides the Fluke logo on the display.
Image Storage	<options>	Sets the location to save images: internal memory or SD memory card.
Language	<options>	Sets the language to use on the display.
Decimal Separator	<options>	Sets the decimal separator to comma or decimal point.
Reset to Factory Defaults	NA	Erases user-set preferences and restores the factory default settings.
Certificates	NA	Shows information about the wireless certificates of the Product.
Licenses	NA	Shows information about the Open Source Software Licenses used to develop the Product.
Version	NA	Shows information about the version of the Product.

Fluke Connect Menu

Table 11 lists the options in the Fluke Connect menu.

Table 11. Fluke Connect Menu

Option Menu	Option	Description
Scan Asset ID Scan QR Code or Barcode	NA	Assign images to an asset. Scan a QR code or barcode attached to an asset or manually enter an asset identification. See Asset Identification (Asset ID) .
Save Images to Fluke Connect Cloud	WiFi	Turns on or off WiFi.
	WiFi Network	With WiFi enabled, connects the Product to a WiFi network so you can sign in to your Fluke Connect account
	Sign in to	
Pair Hotspot to Fluke Connect	WiFi Hotspot	Uses the Product to create a wireless Hotspot when no WiFi network exists. See Fluke Connect Wireless System .
	WiFi Hotspot Settings	
Save Images to Shared Folder	WiFi	Turns on or off WiFi.
	WiFi Network	With WiFi enabled, connects the Product to a WiFi network so you can sign in to a shared folder on a network.
	Shared Folder	

Asset Identification (Asset ID)

Use Asset ID to save and organize images by asset like a motor or electrical panel. Use a barcode, QR code, or other unique identification as a tag to attach to images. When in camera mode, the asset ID shows on the display and looks like . Make Asset IDs unique to each asset.

Assign Asset ID Tag with a QR Code or Barcode

To save images to an asset with a QR code or barcode:

1. Select  > **Scan Asset ID**.
2. Focus a QR code or barcode in the white box on the display.
3. When the Product detects a barcode has been scanned, tap **Use Barcode** or **Use QR Code**. If the Product cannot detect a barcode or QR code, manually enter a unique asset ID. See [Assign Asset ID Tag Manually](#).

The display returns to camera mode, and the barcode or QR code number shows on the display.

4. Capture an image.

Assign Asset ID Tag Manually

To manually enter a unique asset ID:

1. Select  > **Scan Asset ID**.

2. Tap **Manual Entry**.

A keyboard opens on the display.

3. Enter a unique asset identification.

4. Tap **Save**.

The display returns to camera mode, and the asset ID shows on the display.

Exit an Asset ID Tag

To exit out of an asset ID and save images without an asset ID:

1. Tap the asset ID that looks like  on the display.

2. Tap  **Exit Asset ID xxxxx** (where xxxxx is the name of the asset ID).

The display returns to camera mode, and the asset ID does not show on the display.

Assign a Different Asset ID Tag

To exit out of an asset ID and save images with a different asset ID:

1. Tap the asset ID that looks like  on the display.











2. Tap  **Scan New Asset ID**.

3. Assign a new asset ID. See [Asset Identification \(Asset ID\)](#).

Connection Icons

Icons show the status of the Product connection. Table 12 explains the icons.

Table 12. Connection Icons

Icon	Description
No icon	WiFi is not on.
	In a menu, the Product is attempting to connect to a WiFi network.
	The Product is connected to a WiFi network.
	WiFi is on, but the Product is not connected to a WiFi network.
	In a menu, shows beside the network name that the Product is connected to.
	WiFi is on, and the Product is attempting to connect to a Fluke Connect account. Or, Images are saving to a Fluke Connect account.
	WiFi is on, and the Product is connected to a Fluke Connect account.
	The Product is not connected to a Fluke Connect account.
	WiFi is on, and the Product is attempting to connect to a shared folder on a network server. Or, Images are saving to a shared folder.
	WiFi is on, and the Product is connected to a shared folder on a network server.
	The Product is not connected to a shared folder on a network server.

Save Images to Fluke Connect Cloud

When the Product is connected to a WiFi network, you can sign into your Fluke Connect account on the Product and use Fluke Connect Instant Upload. When you use Fluke Connect Instant Upload, the images you take with the Product automatically upload to your Fluke Connect account in the Fluke Cloud. You can view the images saved in the Fluke Cloud on the Fluke Connect website without the mobile device and Product connected to each other.

Note

The Instant Upload feature may not work on all networks or with all devices due to the security profiles on different networks.

Sign in to Fluke Connect WiFi Network

Use the WiFi Network setting to connect the Product to a WiFi network and to sign into a Fluke Connect account on the Product.

To turn on the WiFi Network feature:



1. Select  > **Save Images to Fluke Connect Cloud** > **WiFi** > **On**.
2. Push **WiFi Network** to scan for available networks within range of the Product.
3. Tap on a network to connect to it.
4. If you are prompted to enter a user name and password:
 - a. Use the keyboard to enter a new user name, or tap ▼ to see a list of recently used user names.
 - b. Tap **Next**.
 - c. Use the keyboard to enter a password.
 - d. Tap **Sign In**.
 - e. Tap **OK**.

The display returns to the Save to Fluke Connect menu.

5. Sign in to Fluke Connect. See [Sign in to Fluke Connect Cloud](#).

Sign out of Fluke Connect WiFi Network

To sign out of a WiFi network:



1. Select  > **Save Images to Fluke Connect Cloud > WiFi Network.**
2. Tap the name of the connected network.
3. Tap **Forget Network.**
4. Tap  to return to camera mode.

Sign in to Fluke Connect Cloud

To sign in to your Fluke Connect account:



1. Turn WiFi on and connect to a WiFi network. See [Sign in to Fluke Connect WiFi Network](#).
2. Tap **Sign in to Fluke Connect.**
3. Use the keyboard to enter an email address, or tap ▼ to see a list of recently used email addresses.
4. Tap **Next.**
5. Use the keyboard to enter a password.
6. Tap **Sign In.**
7. Tap **OK** to return to camera mode to capture images.

Note

Keep the Product on and stay in the range of the WiFi network until images are uploaded. If the connection is lost before all the images are saved to Fluke Connect Cloud,  shows on the title bar of the Memory menu. Sign in to Fluke Connect Cloud again and tap  to upload the images.

Sign out of Fluke Connect Cloud

To sign out:

1. Select  > **Save Images to Fluke Connect Cloud > Sign in to Fluke Connect.**
2. Tap **Sign Out.**
The display returns to the Save to Fluke Connect menu.
3. Tap .

Fluke Connect Wireless System

The Product supports the Fluke Connect Wireless System. The Fluke Connect system wirelessly connects your Fluke test tools with an app on a mobile device. It shows images from the Product on your mobile device.

Note

The Fluke Connect system is not available in all countries.

Pair Hotspot to Fluke Connect

Use the Product to create a wireless Hotspot when no WiFi network exists. You can use the Hotspot to download saved pictures or stream live images from the Product to a mobile device with the Fluke Connect app.

Note

WiFi is for indoor use only in Kuwait, Chile, and United Arab Emirates.

To create a Hotspot, pair the Product to the Fluke Connect app. See [Pair to Mobile App](#).

To change the hotspot settings:

1. Select  > **Pair Hotspot to Fluke Connect** > **WiFi Hotspot Settings**.
2. Select an option:
 - **Name (SSID)** to change the SSID
 - **Password** to turn on or off the password or to change the password
 - **Channel** to change the channel
3. Use the keyboard to enter the information for the option.
4. Tap **Save** to use the Product.

Pair to Mobile App

The Fluke Connect app works with Apple and Android products. The app is available for download from the Apple App Store and Google Play.

The Fluke Connect app will be available after initial release. When the app becomes available, you can download the app from the Apple App Store and Google Play.

To use the Fluke Connect app with the Product:

1. On the Product, select  > **Pair Hotspot to Fluke Connect** > **WiFi Hotspot** > **On**.
2. On the mobile device:
 - a. Go to **Settings** > **Wi-Fi**.
 - b. Select the Wi-Fi network that begins with **Fluke...**
3. On the Fluke Connect app, select **Thermal Imager** from the list.

The pictures you take with the Product are saved on your mobile device and on the Product.

Note

To save images to the Fluke Connect app, set the file format to .is2 (see [Device Settings Menu](#)).

4. On the Product:
 - a. Capture an image.

The image is now in the buffer.
 - b. Tap **Save** to save the image and view the image on the phone app.

Go to www.flukeconnect.com for more information about how to use the app.

Save Images to Shared Folder

When the Product is connected to a WiFi network, you can select a folder on a server. The images you take with the Product save to the Product and automatically upload to the selected folder on the server. Anyone with access to the folder on the server can view the images immediately.

Note

The Shared Folder feature may not work on all networks or with all devices due to the security profiles on different networks.

Sign in to Shared Folder WiFi Network

Use the WiFi Network setting to connect the Product to a WiFi network and to sign into a Fluke Connect account on the Product.

To turn on the WiFi Network feature:



1. Select  > **Save Images to Shared Folder** > **WiFi** > **On**.
2. Tap **WiFi Network** to scan for available networks within range of the Product.
3. Tap on a network to connect to it.
4. If you are prompted to enter a user name and password:
 - a. Use the keyboard to enter a new user name, or tap ▼ to see a list of recently used user names.
 - b. Tap **Next**.
 - c. Use the keyboard to enter a password.
 - d. Tap **Sign In**.
 - e. Tap **OK**.

The display returns to the Save to Fluke Connect menu.

5. Sign in to a shared folder. See [Sign in to Shared Folder](#).

Sign out of Shared Folder WiFi Network

To sign out:

1. Select  > **Save Images to Shared Folder** > **WiFi Network**.
2. Tap the name of the connected network.
3. Tap **Forget Network**.
4. Tap  to return to camera mode.

Sign in to Shared Folder

Note

To learn how to create or access a shared folder on a network, contact your IT department.

To use the Product to sign in to a shared folder on a network:

1. Turn WiFi on and connect to a WiFi network. See [Sign out of Shared Folder WiFi Network](#).
2. Tap **Shared Folder > File Path**.
3. Use the keyboard to enter a file path, or tap ▼ to see a list of recently used file paths. After you enter a file path for the first time, the field automatically shows the last used file path.
4. Tap **Save**.

Depending on your security environment, enter a username and password:

- a. Tap **Username and Password**.
 - b. Use the keyboard to enter a new user name, or tap ▼ to see a list of recently used user names.
 - c. Tap **Next**.
 - d. Use the keyboard to enter a password.
 - e. Tap **Next**.
 - f. Tap **Sign In**.
5. Tap **Connect**.
 6. Tap **OK**.



If images in the Product memory have not been saved to a shared folder, a message prompts you to save the images.

- Tap **Save Images** to save images to the shared folder.
- Or,
- Tap **Not Now** to save the images to the shared folder another time.

The display returns to the Save to Shared Folder menu.

7. Tap  to return to camera mode to capture images.

Note

Keep the Product on and stay in the range of the WiFi network until images are uploaded. If the connection is lost before all the images are saved to the shared folder,  shows on the title bar of the Memory menu. Sign in to the shared folder again and tap  to upload the images.

Sign out of Shared Folder

To sign out:

1. Select  > **Save Images to Shared Folder** > **Shared Folder** > **Disconnect**.

The display returns to the Save to Shared Folder menu.

2. Tap  to return to camera mode.

Memory Menu (Memory Gallery)





Note

When the memory is 90 % full, a yellow message bar shows at the top of the display. When the memory is full, the message bar changes to red. To capture more images when the internal memory is full, save the images to an external memory device and delete the images from the Product.

Images are saved to the internal memory storage. Use the Memory menu to view, edit, or delete images. Images are organized by the date they were captured with the newest images at the top.

When additional information has been saved with an .is2 file, an icon shows with the preview file. Table 13 shows the icons.

Table 13. Image Icons

Icon	Description
	Asset ID
	Note
	Asset flag
	Image is saving to a shared folder
	Image saved to a shared folder

View Image

To open an image in fullscreen mode:

1. Push .
2. If needed, touch the display and slide up or down to view all the images.
3. Tap on a thumbnail or preview image to view the image fullscreen.

A toolbar briefly opens on the top of the display. Tap on the image to open or close the toolbar.

Notes

Notes are stored with the image so you do not need to collate multiple files later. To add, edit, and delete notes, use the keyboard that opens on the display.

Notes with Single Image

To add, edit, or delete a note:

1. Open an image in fullscreen mode.

2. Tap . If needed, tap  first.

If no notes are saved with the image, a keyboard opens on the display.

3. Use the keyboard to enter a message.

4. Tap **Save**.

If a note is saved with the image, a list of notes opens on the display.

5. To add another note to the image, tap , use the keyboard to add the new note, and tap **Save**.

6. To edit a note, tap on a note, use the keyboard to edit it, and tap **Save**. If needed, scroll down to see all the notes.

7. To delete a note, tap on a note, tap **Delete**, and tap **Delete** again.

Add a Note to Multiple Images

To add a note to multiple images at the same time:

1. Select **MEMORY** > **...** > **Add a Note to Multiple Images**.

The display returns to the memory gallery.

2. Tap an image to select it. Tap an image again to clear the selection.

The border and filename text color change to yellow.

3. Repeat for each additional image.

4. Tap **Add Note**.

A keyboard opens on the display.

5. Use the keyboard to enter a message.

6. Tap **Save**.

Delete Images

To delete images, do the corresponding procedure below.

Delete an Image

To delete only one image:

1. Open an image in fullscreen mode.

2. Tap . If needed, tap **...** first.

3. Tap **Delete**.

Delete Multiple Images

To delete multiple images at the same time:

1. Select **MEMORY** > **...** > **Delete Multiple Images**.

The display returns to the memory gallery.

2. Tap an image to select it. Tap an image again to clear the selection.

The border and filename text color change to yellow.

3. Repeat for each additional image.

4. Tap **Delete Images**.

5. Tap **Delete**.



Delete All Images

To delete all of the images at the same time:

1. Select **MEMORY** > **...** > **Delete All Images**.
2. Tap **Delete**.

Flag an Image

Flag an image to review later. The flag feature is a toggle switch.

To flag an image, open an image in fullscreen mode, and tap . The flag icon changes to . Tap again to remove the flag.

Asset ID

Use the memory gallery toolbar to add or remove an asset ID from an image that is saved in memory. See [Asset Identification \(Asset ID\)](#).

To add an asset ID to an image:

1. Open an image in fullscreen mode.
2. Tap .
3. Assign an asset ID. See [Asset Identification \(Asset ID\)](#).

To remove an asset ID from an image:

1. Open an image in fullscreen mode.
2. Tap the asset ID that looks like  on the display.
3. Tap **Remove**.

The display returns to the image in fullscreen mode, and the asset ID does not show on the display.

Fluke Connect Desktop Software

Fluke Connect desktop software for a PC is available to use with the Product and contains features to analyze images, organize data and information, and make professional reports.

Use Fluke Connect software to:

- Review notes, asset IDs, and flags.
- Export IR and visible images.
- Edit .is2 image files.
- Update the firmware with new features.

Download Fluke Connect Software

To download Fluke Connect desktop software:

1. Go to <https://www.fluke.com/en-us/support/software-downloads/software-for-fluke-infrared-cameras>.
2. On the website, follow the instructions to download the software to the PC.
3. On the PC, follow the instructions to install Fluke Connect software. (Administrator privileges are required for the installation.)
4. Restart the PC when installation is complete.

Update Firmware

To update the firmware:

1. On the PC, open Fluke Connect software.
2. Connect one end of the USB cord into your PC and the other end of the USB cord into the Product.

Fluke Connect software recognizes the connection with the Product. Windows automatically installs the device driver for use with the Product.

3. On the PC:
 - a. Select **Yes** if prompted to download a firmware update file onto the PC.
 - b. Select the Product from the list on the left.
 - c. Select **Yes** if prompted to download a firmware update to the Product.
4. On the Product, Tap **Ok**.

To complete the firmware update, the Product turns off.

5. To use the new firmware, turn on the Product.

Accessories

Table 14 is a list of the accessories available for the Product.

Table 14. Accessories

Model	Description	PN
FLK-TI-SBP3	Smart Battery Pack	3440365
FLK-TI-SBC3B	Charging Base/Power Supply with Adapters	4354922
TI-CAR CHARGER	12 V Vehicle Charger Adapter	3039779
FLUKE-TI-TRIPOD3	Tripod Mounting Accessory	4335389
BOOK-ITP	Introduction to Thermography Principles	3413459

Maintenance

The Product requires minimum maintenance.

Clean the Case

Clean the case with a damp cloth and a weak soap solution. Do not use abrasives, isopropyl alcohol, or solvents to clean the case.

Lens Care

⚠ Caution

To prevent damage to the infrared lens:

- **Carefully clean the infrared lens. The lens has a delicate anti-reflective coating.**
- **Do not clean the lens too vigorously because this can damage the anti-reflective coating.**

To clean the lens:

1. Use a pressurized can of air or a dry nitrogen-ion gun, if available, to blow off the particulates from the lens surface.
2. Soak a lint-free cloth in a commercial lens cleaning liquid that contains alcohol, ethyl alcohol, or isopropyl alcohol.
3. Squeeze the cloth to remove excess liquid.
4. Wipe the lens surface in one circular motion and discard the cloth.
5. If needed, repeat with a new lint-free cloth.

Battery Care

To get the best performance from the lithium-ion battery:

- Do not charge the Product for more than 24 hours as reduced battery life may result.
- Charge the Product for at least 2.5 hours every six-months for maximum battery life. Without use, the battery will self-discharge in approximately six months.

Charge Batteries

Caution

To prevent damage to the Imager:

- **Do not store the batteries in extreme cold environments.**
- **Do not attempt to charge the batteries in extreme cold environments.**

Caution

Do not incinerate the Product and/or battery.

Before you use the Imager for the first time, charge the battery for at least 2.5 hours. The battery status shows on the five-segment charge indicator.

Note

New batteries are not fully charged. Two to ten charge/discharge cycles are necessary before the battery charges to its maximum capacity.

To charge the battery, use one of the options that follow.

Two-Bay Battery Charger Base

To charge the battery in the charger base:

1. Connect the ac power supply to the ac wall outlet and connect the dc output to the charger base.
2. Put one or two smart batteries into bays of charger base.
3. Charge batteries until charge LEDs on charger base are a solid green.
4. Remove smart batteries and disconnect the power supply when batteries are fully charged.

AC Power Socket on Imager

Note

Make sure that the Imager is near room temperature before you connect it to the charger. See the charging temperature specification. Do not charge in hot or cold areas. When you charge in extreme temperatures, battery capacity may be decreased. When you charge in extreme temperatures, the battery may not charge.

To charge the battery with the ac power socket on the Imager:

1. Connect the ac power adapter into an ac wall outlet and connect the other end to the ac power socket on the Imager.  flashes on the display while the battery charges.
2. Charge until the charge indicator on the display does not flash.

If you remove the Imager from the charger before a full charge shows, it can have a reduced run-time.

3. Disconnect the ac power adapter when the smart battery is fully charged.

Optional 12 V Vehicle Charger

Caution

To prevent damage to the Imager, remove it from the dc car charger before you start or jump start the vehicle.

To use the 12 V vehicle charger to charge the battery:

1. Connect the 12 V adapter into the 12 V accessory socket of the vehicle.
2. Connect the other end to the ac power socket of the Imager.

 flashes on the display while the battery charges.

3. Charge until the charge indicator on the display does not flash.
4. Disconnect the 12 V adapter and Imager when battery is fully charged.

Radio Frequency Data

See Table 10 for instructions on how to access digital copies of the Certificate IDs on the Product.

To view the Radio Frequency Data Class B Instruction Sheet, visit <http://us.fluke.com/usen/support/manuals>.

Specifications

Complete specifications are at www.fluke.com. See the *TiS20+/TiS20+ MAX Product Specifications*.