

# Flue Gas Analyzer

## 716 / 716N



### Test Products International, Inc.

9615 SW Allen Blvd., Ste. 104  
Beaverton, OR 97005

Tel: 503-520-9197 Fax: 503-520-1225

[www.tpi-thevalueleader.com](http://www.tpi-thevalueleader.com)

### Test Products International, Ltd.

342 Bronte Road South, Unit #9  
Milton Ontario Canada L9T5B7

Tel: 905-693-8558 Fax: 905-693-0888



**The Value Leader™**

[www.tpi-thevalueleader.com](http://www.tpi-thevalueleader.com)

## Contents

Introduction.....	1
General Overview.....	1, 2
Instrument Overview.....	3 ~ 7
Front View.....	3
Keypad.....	4
Back View.....	5
Side Views.....	6
Top View.....	7
Basic Analyzer Functions.....	8 ~ 10
Charging The Analyzer.....	8
Turning The Analyzer On .....	9
Turning The Analyzer Off.....	10
Display Backlight.....	10
Combustion Analysis Overview.....	11
Measurements.....	12 ~ 28
Flue Gas.....	12 ~ 21
Typical Test Results.....	22
Temperature & Pressure.....	23 ~ 24
Tightness Test.....	25 ~ 26
CO Room Test.....	27
Combustible Gas Leak Detection.....	28
Menu Navigation.....	29 ~ 32
Memory.....	29
Fuel Type.....	30
Analyzer Setup.....	31
Units of Measure, Sensor Info, Instrument Info.	32
Specifications.....	33 ~ 34
Calibration & Service.....	35
Warranty.....	35
Appendix A	General Maintenance & Function Tests.....36 ~ 38
Appendix B	A773 Sulfur Filter Installation & Maintenance....39 ~ 40
Appendix C	Error Codes and Troubleshooting.....41~ 42
Appendix D	Testing for Carbon Monoxide in Ambient Air.....43
Appendix E	Carbon Monoxide Limits in Ambient Air Chart....44
Appendix F	Carbon Monoxide Facts.....45
Appendix G	Battery Replacement.....46

## Notes:

## Notes:

## Introduction

Thank you for purchasing TPI brand products. The TPI 716 Flue Gas Analyzer is a state of the art, easy to use analyzer designed not only to display and calculate the required readings from a flue but also to cover most of the other measurements associated with combustion. The instrument is ruggedly constructed and comes with a 3 Year unit and 2 Year sensor Guarantee.

## General Overview

The TPI 716 combustion analyzer uses state of the art electrochemical sensors. This sensor technology provides the longest lasting, most accurate and reliable means for performing combustion tests. The sensors in your analyzer will need to be replaced periodically and calibration is recommended once every year.

Electrochemical sensors by nature are always active. Therefore the time the analyzer is off and not being used must be taken into account when determining sensor life. The sensors in your analyzer are warranted for two years. This warranty does not cover sensors damaged through misuse of the analyzer.

You should keep the battery of your 716 charged so power is constantly being supplied to your sensors.

The following guidelines will help prevent damage to your sensors:

- Always use the mini pump filter when testing flue gases.
- Always periodically check and replace the mini pump filter as needed.
- Always make sure the in-line filter / water trap is installed properly.
- Always periodically check and replace the in-line filter as needed.
- Always remove water or condensation from the inside of the in-line filter / water trap assembly prior to performing tests.
- Always use the optional oil filter (p/n A773) when performing tests on oil burning equipment ***unless you are using the 716N. Do not use the A773 with the 716N because the A773 will filter out Nitric Oxide (NO).***

## General Overview (Continued)

## Notes:

Never over saturate your sensors by performing tests on equipment with gas levels beyond the capability of your analyzer.

Always keep the A795 water trap / filter assembly clean and replace the filter as necessary. Replacement filter part number is A794F.

This manual will guide you through the functions of the TPI 716 which will give you many years of reliable service.

Your TPI 716 Flue Gas Analyzer comes complete with the following standard accessories:

( ) Denotes part number

- TPI 716 Analyzer
- Combustible Gas Leak Probe (A806)
- Rubber Boot (A765) 1 each installed on analyzer
- Soft Carrying Case (A768) - 1 each
- Flue Sampling Probe (A770) - 1 each
- In-Line Filter / Water Trap installed on Flue probe (A795) - 1 each
- Disc water filter installed in water trap (A794W) - 1 each
- Spare In-Line Filter - 1 each (A794F is a package of 5 filters)
- Temperature Probe (GK11M) - 1 each
- Battery Charger (A766) - 1 each
- Mini Pump Protection Filter Assembly (A763) - 1 each
- Exhaust Spigot Removable (A764) - 1 each
- Pressure Tubing (A774) - 1 each 6' piece
- Static Pressure Tips (A776) - 2 each
- 1/4" barbed to 1/8" NPT fitting (A603) - 2 each
- Gas Valve Adapter (A611) - 1 each
- Adapter Tubing (A791) - 1 each 4" piece
- Instruction Manual

Your TPI 716 Flue Gas Analyzer has the following options available:

- A807 PC Software and cable for communication to a PC.
- A740 infrared printer (**Included with 716A740**)

## Appendix G: Battery Replacement

When the battery in your analyzer will no longer charge, no longer hold a charge, or if beeping is heard while charging this is usually an indication the battery pack requires replacement.

For best results use a TPI replacement battery part number A007. The battery in your analyzer is 3.6V NiMH 1600mAh rated. Never replace the battery with any other type of battery or damage to the charge circuit will result.

The battery pack is replaced as follows:

1. Turn the analyzer over and locate the phillips head battery cover screw. See picture below.



2. Loosen the screw. Pull out on the screw to remove the battery cover.

3. Remove the old battery pack from the battery compartment. Pull the battery wire out of the connector.

4. Install the new battery pack by inserting the connector from the battery pack into the connector on the analyzer. Install the battery pack into the battery compartment.

4. Re-install the battery cover by fitting the bottom part in first.

5. Tighten the battery cover screw.

## Instrument Overview



### Front View

<b>Rubber Boot</b>	Protects the instrument from accidental damage
<b>Display</b>	Large graphical backlit LCD Display
<b>Keypad</b>	Selects all available functions

**NOTE:** When selecting oil as fuel be sure to use the optional oil filter (A773) or readings could become erratic. See Appendix E for installation instructions.

**Do NOT use the A773 with the 716N analyzer.**

## Keypad

**Blue Soft Keys** - The function of these keys is shown in the lower part of the display and changes depending on what menu the analyzer is in.

In the picture center soft key controls the start function and the left and right soft keys are disabled.

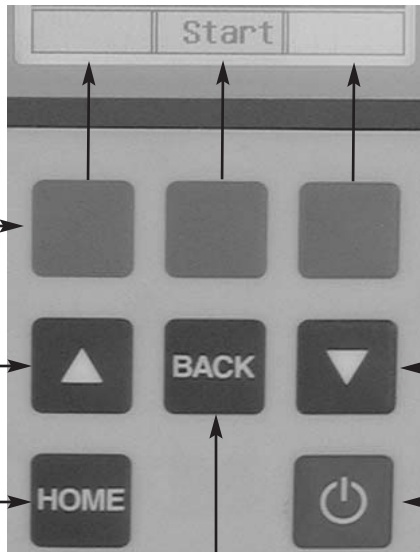

**Up Arrow Key** - This key is used to scroll up in menus.

**Down Arrow Key** - This key is used to scroll down in menus.

**Home Key** - This key is used to return to the Main Menu from any other menu.

**Back Key** - This key is used to go back one menu level.

**On/Off Key** - This key is used to turn the analyzer on and off.

## Appendix F: CARBON MONOXIDE FACTS

Carbon Monoxide (CO) is invisible, odorless, and tasteless. It is the byproduct of combustion and levels are elevated when there is incomplete combustion.

Sources of CO include:

- Unvented kerosene and gas space heaters
- Leaking chimneys & furnaces
- Gas water heaters
- Back drafting from furnaces
- Wood stoves & fireplaces
- Gas Stoves
- Automobile exhaust
- Tobacco smoke

Carbon Monoxide is picked up quickly in the body by red blood cells. At high levels of CO the body replaces oxygen with carbon monoxide.

The most common symptoms of CO poisoning are headache, dizziness, weakness, nausea, vomiting, chest pain, and confusion. High levels of CO inhalation can cause loss of consciousness and death. Unless suspected, CO poisoning can be difficult to diagnose because the symptoms mimic other illnesses.

People who are sleeping or intoxicated can die from CO poisoning before ever experiencing symptoms.

Please see the next page for a list of exposure times and symptoms.

## Appendix E: Carbon Monoxide in Ambient Air Chart

This chart contains maximum exposure levels and times for carbon monoxide. This is a general guideline only. It is recommended you check with your local government for guidelines in your area.

### **72pi** CARBON MONOXIDE the SILENT KILLER!

<i>Concentration of CO in air</i>	<i>Exposure times and toxic symptoms</i>
<b>9ppm</b>	The maximum allowable concentration for short term exposure in a living area according to ASHRAE
<b>35ppm</b>	The maximum allowable concentration for continuous exposure in any 8 hour period, according to federal law. (US federal law)
<b>200ppm*</b>	Maximum concentration allowable any time according to OSHA. Slight headaches, fatigue, dizziness, nausea after 2-3 hours.
<b>400ppm*</b>	Frontal headaches within 1-2 hours, life threatening after 3 hours. Maximum allowable limit in flue gas according to EPA and AGA.
<b>800ppm*</b>	Headache, dizziness, nausea, and convulsions with 45 minutes. Unconsciousness within 2 hours. Death within 2-3 minutes.
<b>1600ppm*</b>	Headache, dizziness, and nausea within 20 minutes. Death within 1 hour.
<b>3200ppm*</b>	Headache, dizziness, and nausea within 5-10 minutes. Death within 30 minutes.
<b>6400ppm*</b>	Headache, dizziness, and nausea within 1-2 minutes. Death within 10-15 minutes.
<b>12800ppm*</b>	Death within 1-3 minutes.

## Back View

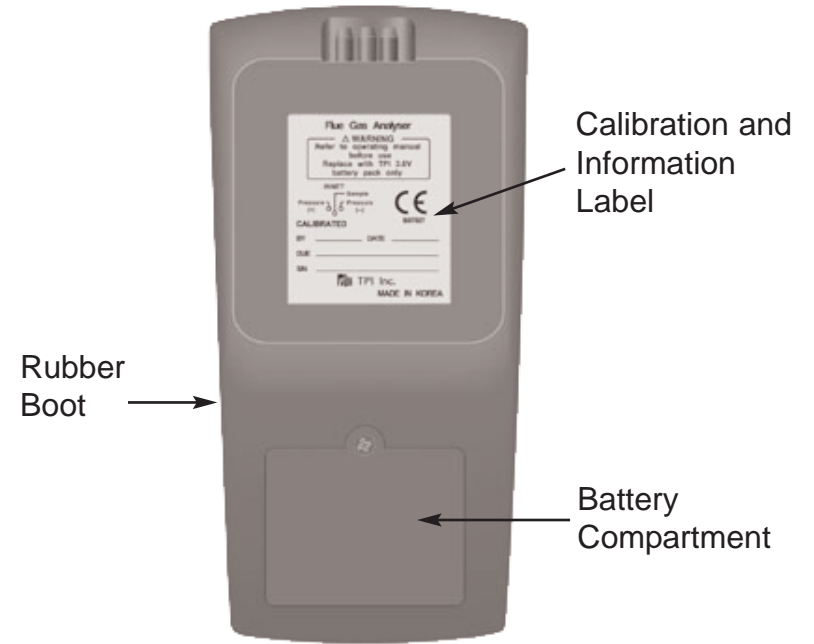

**Calibration and Information Label:** Displays calibration information and serial number

**Battery Compartment:** Holds rechargeable battery

**Rubber Boot** Protects the instrument

## Side Views

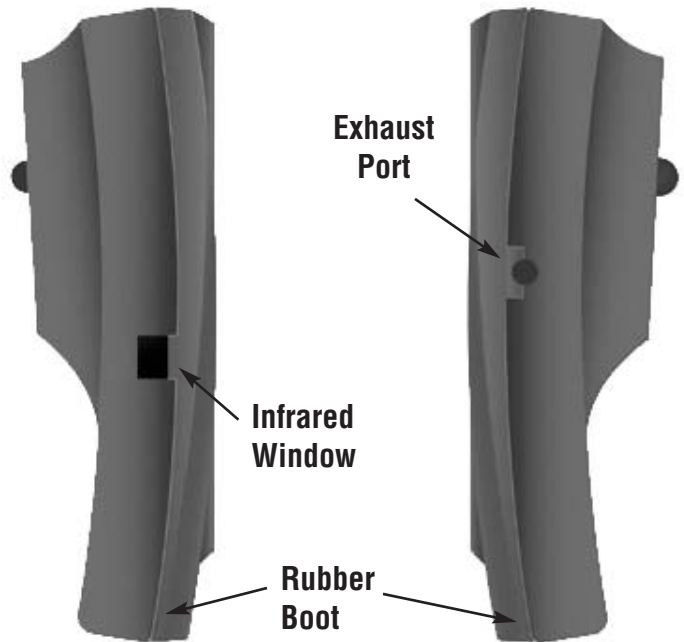

### Exhaust Port

Port for connection of Exhaust Adapter

### Infrared Window

Window for sending stored data to IR Printer

### Rubber Boot

Protects the instrument from accidental damage

## Appendix D: Testing for Carbon Monoxide in Ambient Air

The 716 can be used to test for carbon monoxide in ambient air. For example tests can be performed in work spaces and living areas like offices and houses to ensure safety.

1. Following the steps outlined on page 8, turn the analyzer on in a clean air environment away from the area to be tested,
2. Select "Measurement" from the Main Menu. Select "Flue gas" from the Measurements Menu. After a purge cycle the display below will be seen.

▲▲	
▲ Flue gas	
17.03.2012 02:44	
Natural gas	
CO	85 ppm
CO2(c)	10.2%
Ratio	0.003
Effi(g)	82.3%
O2	4.3%
XAir	10%
NO	0 ppm
NOx	0 ppm
Send	Save

Ambient CO levels will be seen in the top line of the display. (CO in ppm)

3. Connect the Pump Protection filter to the analyzer.
4. Begin testing for carbon monoxide. Move from space to space to detect any CO that may be present. The CO reading will be seen in the top part of the display.
5. If necessary, the flue probe can be attached to test in ducts and plenums.
6. Refer to the chart on page 50 for a list of exposure times and levels of carbon monoxide in ambient test applications and page 51 for carbon monoxide facts.
7. When testing is complete, turn the analyzer off as outlined on page 8.



## Appendix C: ERROR CODES & TROUBLESHOOTING (Continued)

Problem	Possible Cause	Corrective Action
Efficiency reading incorrect	NET efficiency selected.  Ambient temperature probe not plugged in to T2.  Incorrect fuel selected.	Select GROSS efficiency. See page 13.  Plug ambient probe into T2. See page 14.  Select the proper fuel for the equipment being tested. See page 13.
Readings are erratic when working on oil fired equipment.	Oil filter not installed or installed incorrectly (716 only).	Make sure the optional sulfur filter (A773) is installed. See Appendix B.
One or all of the following parameters; Ratio, CO air free, excess air, and efficiency read and print dashes.	Measured values are such that the calculated values of these parameters are out of range.	Redo combustion test. Since these are calculated values, the measure values must be within certain levels for these to display. If the measured oxygen level is above 19.9% these parameters won't read.  These parameters might not display or be applicable in some tests.
Pressure prints as "N/A" on my combustion analysis print out.	During combustion analysis if a pressure measurement is not being made this parameter will print as not being used.	Perform the combustion test and also connect the manometer and monitor pressure.
Battery will not charge or hold a charge.	Defective charger or battery.	Replace the charger or battery.  Send to TPI for service.
Beeping noise heard during charging.	Defect in charging circuit or shorted battery.	Disconnect from the charger and contact TPI at 800-368-5719.
Analyzer won't turn off	Oxygen and/or carbon monoxide levels outside limits.	Allow the analyzer to purge longer.
Pressure sensor will not zero.	Pressure sensor needs to be reset.	Send to TPI for calibration.

## Top View

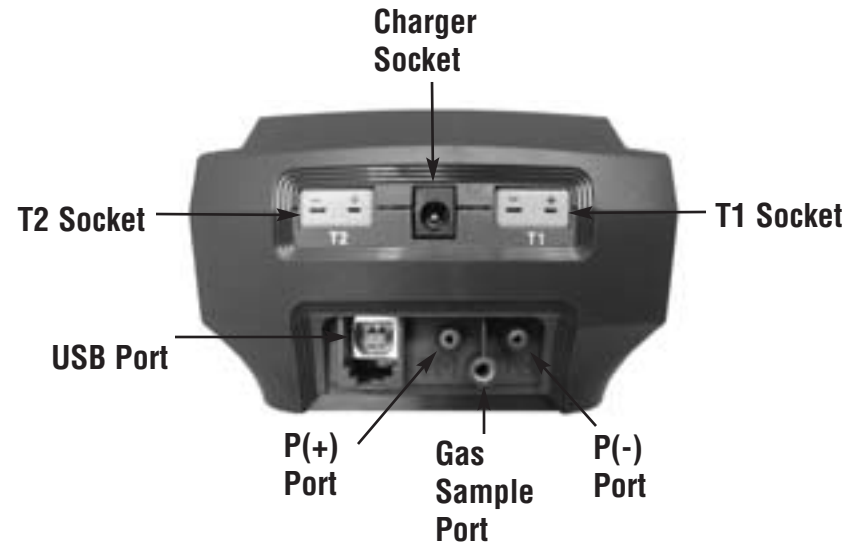

<b>Charger Socket</b>	Connection for 220V/115V charger
<b>T1 Socket</b>	Connection for thermocouple plug on flue probe Connection for any 'K' type thermocouple probe
<b>T2 Socket</b>	Connection for ambient 'K' type thermocouple probe Connection for any 'K' type thermocouple probe
<b>Gas Sample Port</b>	Connection for Mini Pump Protection Filter and Flue Probe
<b>P (+) Port</b> <b>P (-) Port</b>	Connections for Pressure Tubing
<b>USB Port</b>	Connection for optional A807 cable for communication to a PC or connection for A806 combustible gas leak detection probe.

## BASIC ANALYZER FUNCTIONS

### Charging The Analyzer

Plug the charger into the charger socket on the instrument (see page 7). When the charger is plugged in the battery level display will turn on. This display indicates the analyzer is being charged and the status of the charge.

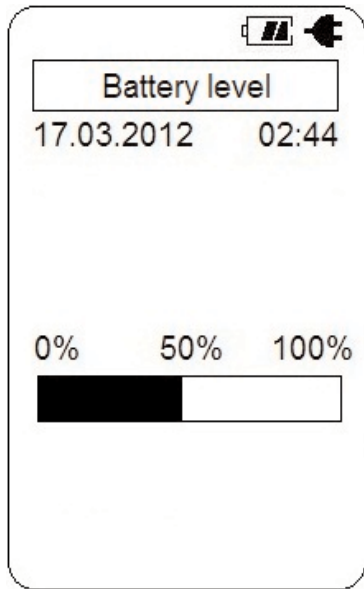

← The plug symbol confirms the analyzer is connected to the charger. The battery symbol shows the charge level when the analyzer is on too.

← The charge level is represented in graph form as well. The charge is displayed in percentage. (0 to 100%)

During operation the analyzer will display charge status and battery condition in the top right corner of the display.



Battery is at full capacity.



Battery is at 2/3 capacity.



Battery is at 1/3 capacity. The charger should be connected soon.



Battery is very low and needs to be recharged immediately



Indicates the analyzer is connected to the charger.

If a beeping noise is heard during charging disconnect the charger. This is an indication the battery pack needs to be replaced. Please see Appendix G for battery replacement instructions.

## Appendix C: ERROR CODES & TROUBLESHOOTING

Code Displayed	Code Definition	Possible Causes	Corrective Action
<b>Flow Error</b>	Pump not drawing sample at correct flow rate.	Blockage / kink in flue probe hose. Dirty or blocked filter(s). Worn pump.	Check and rectify. See Appendix A. Replace filter(s). See Appendix A. Return to TPI for service.
<b>Init O2 Err</b>	Oxygen sensor failed to initialize	Flue probe connected to 716 prior to power up. 716 did not purge completely from last sample. Worn or defective oxygen sensor.	Disconnect probe and restart. Purge for 20 minutes and restart. Return to TPI for sensor replacement.
<b>Init CO Err</b>	Carbon monoxide sensor failed to initialize.	Flue probe connected to 716 prior to power up. 716 did not purge completely from last sample. Worn or defective carbon monoxide sensor.	Disconnect probe and restart. Purge for 20 minutes and restart. Return to TPI for sensor replacement.
<b>Lo bat</b>	Low battery.	Battery needs to be charged.	Charge battery. If the battery won't hold a charge, replace the battery.
<b>oFL</b>	Overflow indication. The pressure being measured is outside the maximum measurement capability.	Pressure being measured is too high or low. Pressure sensor damaged or defective.	Remove pressure source. Return to TPI for service.
<b>oFL</b>	Overflow indication. The temperature being measured is outside the maximum measurement capability.	Temperature being measured is too high or low.	Remove pressure source.
<b>oPEn</b>	Unable to read thermocouple (temperature).	Temperature probe not connected to input. Worn temperature sensor.	Connect temperature probe to analyzer. Replace temperature probe or flue probe.

## Appendix B: A773 SULFUR FILTER INSTALLATION & MAINTENANCE

- Beginning on the “Flue Probe” side of the A773 sulfur filter, pull the yellow thermocouple cord out of the channel of the flue probe tube. Pull out approximately the length of the water trap that was removed.
- Being careful not to cut the yellow cord, cut out a section of the flue probe tubing the length of the water trap on the “Flue Probe” side of the A773 sulfur filter. (See picture below)

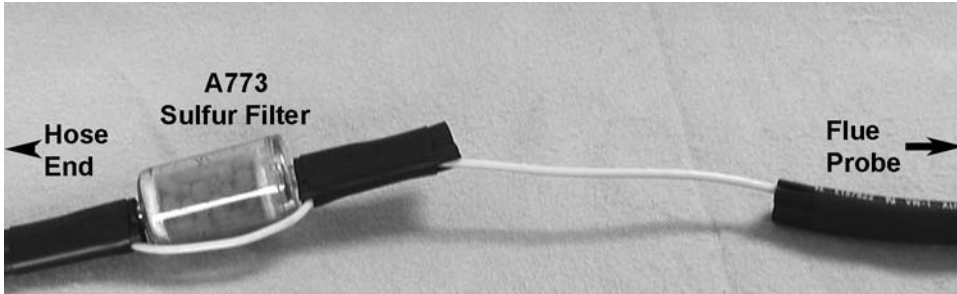

- Install the water trap in the flue probe hose where the piece was cut out. Make sure the water trap is positioned correctly. The water trap lid should face the “Hose End” side of the hose. (See picture below)

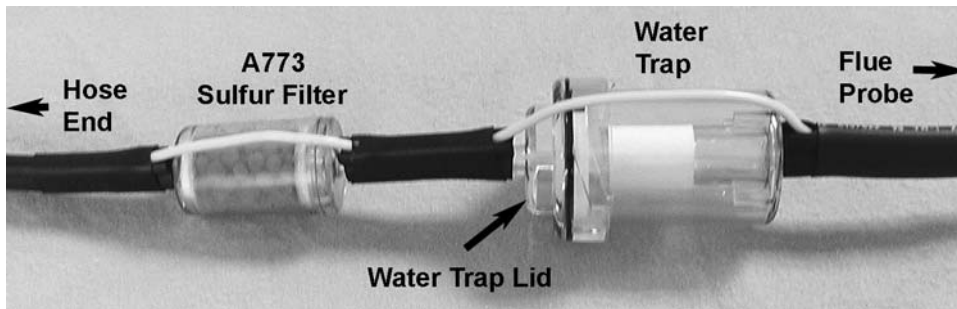

### A773 SULFUR FILTER MAINTENANCE:

The A773 should be replaced when most of the pellets become discolored, usually white or black.

If the A773 begins to trap condensate and fill with water but the pellets are not discolored to the point replacement is required, it should be removed and allowed to dry. Once it is dry it can be reused.

## Turning The Analyzer On

**Always: - Before turning on please ensure nothing is connected to the Gas Sample Port (see page 7)**

Press and hold the ON/OFF key down for approximately 3 seconds. The 716 will beep and the initial start up screen will be displayed.



The initial start up screen displays the following information:

Model number of the analyzer

Firmware version

Firmware date

Serial number of the analyzer

Last calibration date of the sensors

Note: The NO sensor calibration date will only display for 716N models.

After the initial start up screen displays for approximately 5 seconds the Main menu will be displayed.

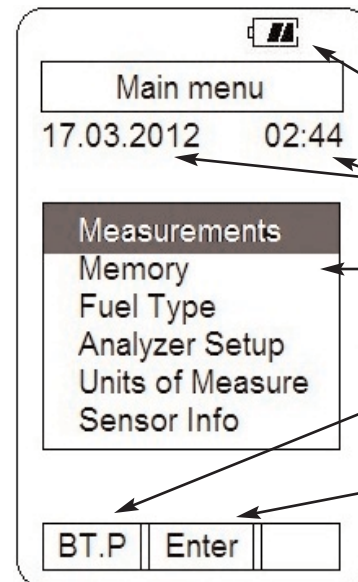

The main menu displays the following information:

Battery status

Date (dd.mm.yyyy format) and time (24hr clock)

Menu Selections

Left blue soft key activates Bluetooth (Only models equipped with this option.)

Center blue soft key confirms selection

## Turning The Analyzer Off

Always: - Before turning off return the instrument to a clean air environment and allow the Carbon Monoxide level to return below 15ppm and the Oxygen level to return to 20.9% ( $\pm 0.3\%$ ) Press the Power Key to turn the instrument off:- NOTE The Instrument will not allow itself to be switched off if the CO is above 15ppm

When the 716 is turning off the following screen is seen:

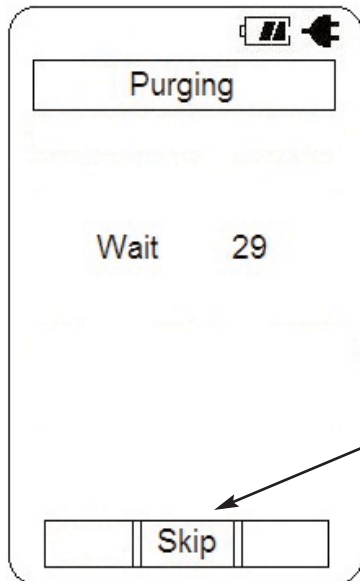

The instrument has an auto shut off factory set for 10 minutes should no keys have been pressed for this period and the CO level is below 15ppm. The auto power off can be set to a different time or disabled. Please refer to Menu Navigation - Analyzer Setup on page 31.

If the CO level is close enough to 0ppm and the O2 level is close enough to 20.9% the analyzer will display "Skip". This allows you to skip the purge by pressing the middle soft key.

## Display Backlight

The display backlight is factory set to Auto. A sensor located on the side of the analyzer detects the amount of ambient light and automatically adjusts the backlight intensity.

The backlight can be manually adjusted to a desired level by the user. Please refer to Menu Navigation - Analyzer Setup on page 31.

## Appendix B: A773 SULFUR FILTER INSTALLATION & MAINTENANCE

**USE THE A773 ONLY WITH THE 716. DO NOT USE WITH THE 716N.**

When using a 716 and performing combustion tests on oil fired equipment it is important to use the optional A773 sulfur filter. Failure to do so can result in incorrect and readings. This filter also protects the sensors from the affects of sulfur. The A773 does not have to be removed when working with other types of fuels.

### PROCEDURE

1. Begin with the water trap section of the flue probe oriented as shown in the picture below.

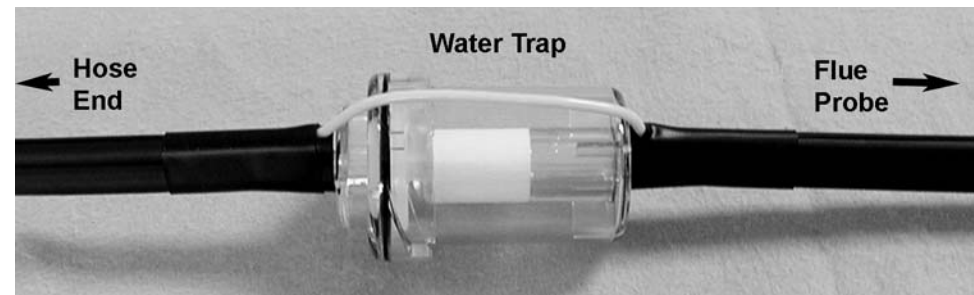

2. Remove the water trap from the flue probe hose. (See picture below)

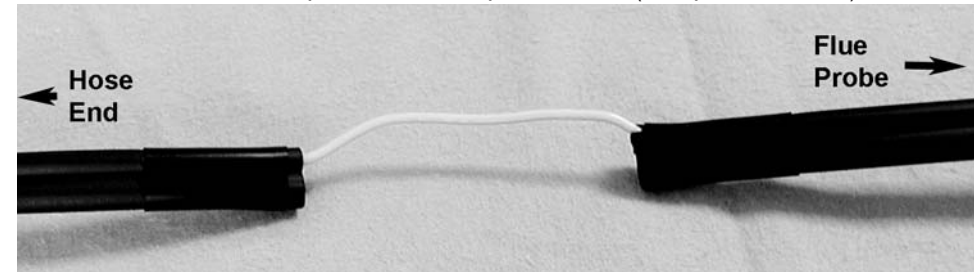

3. Insert the A773 sulfur filter flue probe tube where the water trap was removed. (See picture below)



## Appendix A: General Maintenance (continued)

### Flue Probe Integrity Check

NOTE: Perform this check after performing the Pump Operation Check outlined on the previous page.

1. Turn the analyzer on as outlined on page 8. Do not connect anything to the inlet. Wait until the analyzer has completed the initial purge and sensor check and is operating normally prior to proceeding to step 2.
2. Connect the A763 mini pump protection filter and flue probe assembly to the inlet of the analyzer and the yellow thermocouple connector to input T1.
3. Repeatedly press the Scroll/Enter key until temperature is displayed. If the displayed temperature is approximately the ambient temperature the thermocouple is operating properly and you may proceed to the next step to continue the test. If the displayed temperature is “OL” the thermocouple is open and the probe is in need of factory service.
4. Cover the end of the flue probe with a small piece of tube and pinch the end close. After a short period of time the analyzer should display “Flow Error” and a rapid beeping should be heard. If this happens the flue probe is operating properly and the integrity test is complete. If the analyzer does not display “Flow Error” this is an indication of a possible leak somewhere in the flue probe and you may proceed to the next step for further tests.
5. Pinch the hose below the handle of the flue probe. If the analyzer displays “Flow Error” there is a leak in the handle assembly and the probe needs to be factory serviced. If the analyzer does not display “Flow Error” proceed to the next step for further tests.
6. Pinch the hose between the analyzer and the water trap. If “Flow Error” still does not display there may be an internal leak, pump problem, or other issue and the analyzer needs to be factory serviced. If “Flow Error” is displayed there is a leak in the water trap assembly and the water trap assembly should be checked as outlined on page 36 & 37.

## COMBUSTION ANALYSIS OVERVIEW

Performing combustion analysis is very important to the overall safety and efficiency of heating equipment. The following guidelines and descriptions are generic and meant to provide you with a basic understanding of combustion testing. TPI always recommends you contact the manufacturer of the device under test, obtain information specific to the device, and follow the procedures and safety guidelines for performing tests and affecting repairs.

In general, for most applications, flue gas samples should be taken prior to the draft diverter or any other opening that allows room air to enter the system. This prevents room air from mixing with gases in the flue and diluting the test sample. To ensure accurate and consistent combustion tests, it is important gas and temperature samples be taken at the same location. This is easy with the TPI flue probe because the temperature sensor is an integral part of the probe.

Prior to taking a sample, the device under test should be on and operating. Putting the flue probe in the sample area prior to starting the device may cause saturation of the sensors due to the higher initial concentration of carbon monoxide that may be encountered upon start up. If this happens, allow your analyzer to purge in fresh air until the carbon monoxide level returns to 0 ppm and the oxygen level returns to 20.9%. This may take more than an hour depending on how saturated the sensors are.

The figures on pages 16 through 18 show locations for performing tests on commonly encountered equipment. Remember to consult with the manufacturer of the device under test for specific test information.

Pressing the Func Key enables access to the different functions available on the 716. The default function is Combustion Analyzer. Other available functions are: Thermometer, Manometer/Tightness Test, Combustible Gas Leak Detector, and Date / Time display.

## MEASUREMENTS - Flue Gas

*Note: It is recommended you perform routine general maintenance on your analyzer to ensure proper function. Please refer to Appendix A for general maintenance schedule and function tests.*

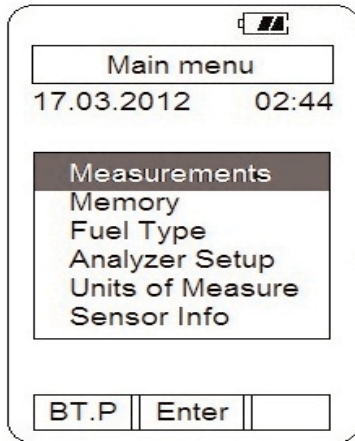

Turn the 716 on as outlined on page 8. After the initial start up screen the Main Menu will be displayed.

Using the Arrow keys select Measurements by highlighting it.

Press the Enter key (center soft key) to confirm the selection.

The Measurements menu will be displayed.

Using the Arrow keys select Flue gas by highlighting it.

Make sure the analyzer is in a clean air environment with only the pump protection filter connected to the input.

Press the Enter key (center soft key) to confirm the selection.

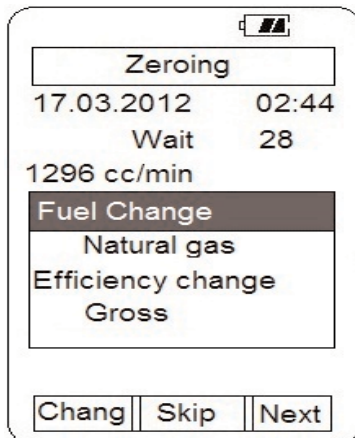

The pump will start and the Zeroing screen will display. The analyzer is initializing and self testing the sensors during this 30 second cycle.

The selected fuel type will be displayed and can be changed as necessary (see pg 13).

The selected unit of efficiency is displayed and can be changed as necessary (see pg 13).

If the analyzer is ready for use, "Skip" will appear above the center soft key. Pressing this will bypass the 30 second countdown.

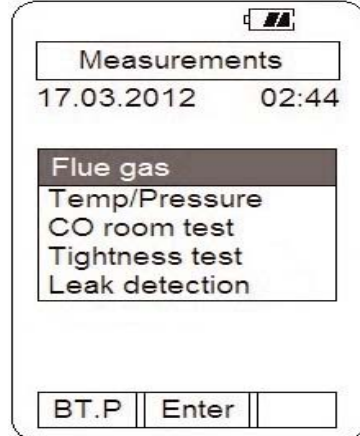

## Appendix A: General Maintenance (continued)

### Filter Check Continued

The other two filters are located in the water trap. The main filter is the A794F particle filter. This filter stops debris and dust from traveling down to the analyzer. The secondary filter is the A794W water block filter. This filter stops flow in the event the water trap fills with condensate. Refer to the picture below.

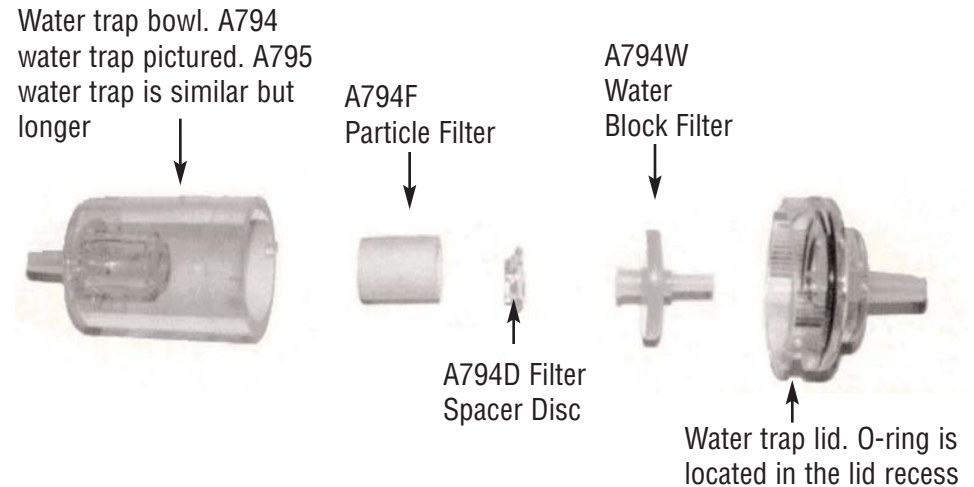

Open the water trap and look at the A794F particle filter. The filter will typically get dirty from the inside first. If the filter is dark on the inside a replacement filter should be installed.

If the A794F is clean but saturated with water a replacement should be installed to ensure proper flow. The saturated filter can be left to dry and reused later.

### Pump Operation Check

1. Turn the analyzer on as outlined on page 8. Do not connect anything to the inlet. Wait until the analyzer has completed the initial purge and sensor check and is operating normally prior to proceeding to step 2.
2. Cover the analyzer inlet with your finger. The analyzer should display "FLO ERR" and a rapid beeping should be heard.

If the analyzer does not beep and display "FLO ERR" this may be an indication the flow sensor requires calibration, the pump is faulty, or there is an internal leak. The analyzer should be returned for factory service.

## Appendix A: General Maintenance

All combustion analyzers use consumable items such filters and probes. These items are user serviceable and can be taken care of by the operator.

The consumable items that will require operator attention are the water trap / filter assembly, flue probe, pump protection filter, and ambient temperature probe.

The recommended maintenance schedule for your analyzer is as follows:

<b>Maintenance Performed</b>	<b>Frequency</b>
Water trap Check	Once per week (Once per day for analyzers that see heavy use or are used in oil fired applications)
Filter Check	
Pump Operation Check	Once per month (More often for analyzers that see heavy use or are used in oil fired applications)
Flue Probe Integrity Check	
Thermocouple Probe Check	

### Water Trap Check

Visually check the water trap for:

1. Cracks in the bowl.
2. Broken ears on the bowl where the lid locks on.
3. Broken ears on the lid.
4. Worn out o-ring on the lid.
5. Loose connection to the flue probe tubing.

### Filter Check

Signs of dirty or water saturated filters are a slow pump, flow error displayed when the flue probe is connected, and measurements that take longer than normal.

TPI analyzers use three filters to protect the pump and sensors. The first filter to check is the A763 mini pump protection filter. (see picture below)

Inspection Window

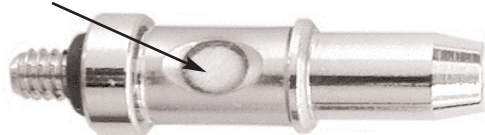

Pump Protection Filter

Look in the inspection window to check the filter. When the filter material becomes dark, pull the black nose cone out of the tubing and replace the ball filter inside.

## MEASUREMENTS - Flue Gas (continued)

As necessary, the fuel type can be changed to match the fuel type of the equipment under test. The fuel type is used in the efficiency calculation and therefore it is important the fuel type is correct in order for the calculation to be accurate.

To change the fuel type use the Arrow keys to highlight "Fuel change".

Press the Chang key (left soft key) and the fuel menu will display.

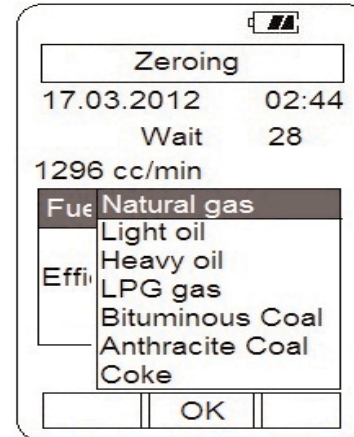

The Arrow keys are used to scroll through the available fuel types.

The available fuels are Natural gas, Light oil, Heavy oil, LPG, Bituminous coal, Anthracite coal, Coke, Butane, Wood (dry), and Bagasse.

Once the desired fuel type is highlighted press the center soft key (OK) to confirm the selection.

The analyzer will return to the Zeroing display and the countdown will continue.

The unit of efficiency can be changed as needed between Nett and Gross. Nett efficiency doesn't take into account wet losses while Gross efficiency does. In the USA Gross efficiency is used. If Nett is selected the efficiency will be displayed as much higher than it is.

Press the right soft key (Next) to highlight "Efficiency" in the display.

Press the Chang key (left soft key) and the efficiency menu will display.

Use the Arrow keys to select the desired efficiency unit and press the center soft key (OK) to confirm the selection.

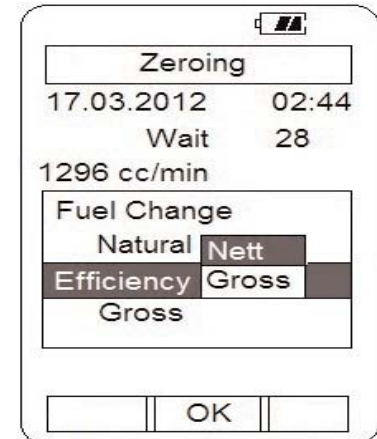
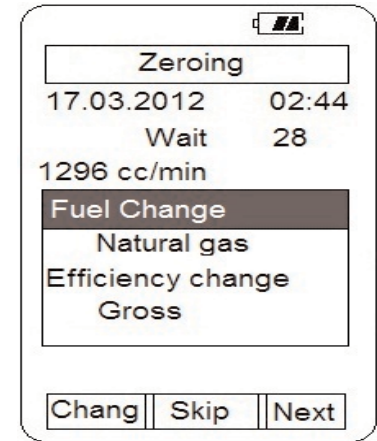

## MEASUREMENTS - Flue Gas (continued)

After the initial purge cycle is complete or skip is pressed the Flue gas measurement screen will display.

This screen displays all combustion parameters including temperature and pressure.

Flue gas	
17.03.2012	02:44
Natural gas	
CO	85 ppm
CO2(c)	10.2%
Ratio	0.003
Effi(g)	82.3%
O2	4.3%
XAir	10%
NO	0 ppm
NOx	0 ppm
Send	Save

Connect the Pump Protection Filter assembly and Flue Probe Tubing complete with In-Line Filter to the Gas Sample Port and the 'K' Type Thermocouple Plug from the Flue Probe into Thermocouple (T1) Socket. The GK11M ambient air temperature probe is connected to the (T2) socket. (See below & page 7)

**WARNING:** - Ensure the 'K' type thermocouple probes are inserted into the sockets correctly (see page 7). The plugs are polarity marked and forcing the plug into the socket the wrong way may result in damage to the instrument.

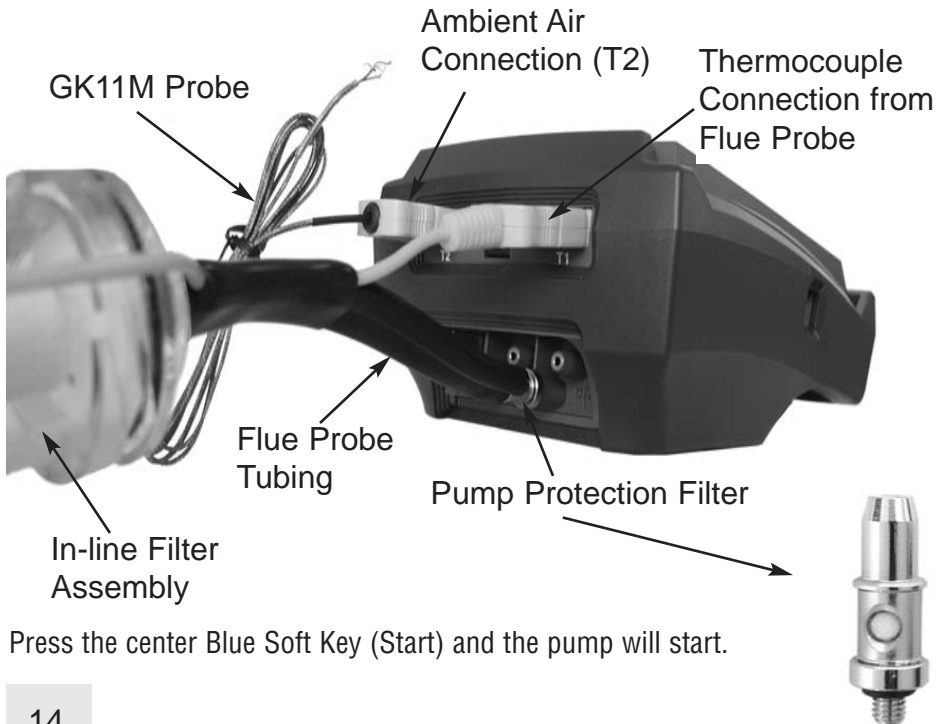

Press the center Blue Soft Key (Start) and the pump will start.

## CALIBRATION & SERVICE

It is recommended that your analyzer be calibrated every 12 months. Please consult Test Products International for further details or send your analyzer to the address below for service.

TPI / Attn. Repair  
9615 SW Allen Blvd. Suite 104  
Beaverton, OR 97005

Please include your name, contact information, return address, and a brief description of the service required.

The following are consumable parts for the instrument:

In-Line Filter Element (pkg of 5)	User Replaceable	A794F
Disc water filter	User Replaceable	A794W
Mini Pump Protection Filter Assem.	User Replaceable	A763
**Oxygen Sensor	User / Factory Replaceable	A761
**Carbon Monoxide Sensor	User / Factory Replaceable	A760
**Nitric Oxide Sensor	User / Factory Replaceable	A793
<i>**Sensor replacement requires calibration gas.</i>		

**These items require periodic replacement as the analyzer is used. Please see Appendix A on page 37 for general maintenance information.**

## WARRANTY

Your TPI 716 Flue Gas Analyzer is guaranteed free from defects in materials and workmanship for 3 Years from the date of purchase. The sensors carry a 2 Year warranty. This guarantee does not affect your statutory rights. For additional information please refer to the included warranty card or contact TPI at 800-368-5719.

To obtain warranty performance or maintenance on your analyzer: - Include with the product your name, address, phone number, written description of the problem and proof of purchase date. Carefully package and return to:

TPI / Attn. Repair  
9615 SW Allen Blvd. Suite 104  
Beaverton, OR 97005



## SPECIFICATIONS (Continued)

Gases	Range	Resolution	Accuracy
Oxygen	0-25%	0.1%	+/- 0.3%
Carbon Monoxide	0-10,000 ppm	1 ppm	+/- 5 ppm or 5% Whichever is greater
Nitric Oxide *	0-5000ppm	1ppm	+/- 5ppm (<100ppm) +/- 5% (<1000ppm) +/- 10% (>1000ppm)
Carbon Dioxide	0-25%	0.1%	Calculated
CO/CO2 Ratio	0-0.999	0.001	Calculated
Combustion Efficiency	0-100%	0.1%	Calculated
Gas Leak Sensor	100-10,000 ppm (calibrated to methane)		

\*716N Model Only

### Pressure Measurement

Selectable Ranges	mbar, psi, inH <sub>2</sub> O, mH <sub>2</sub> O, kPa, hPa, inHg, mmHg
Range	- 150 mbar to + 150 mbar -15 kPa to + 15 kPa -60 inH <sub>2</sub> O to 60 inH <sub>2</sub> O
Resolution	0.01 mbar, 0.001 kPa, 0.001 inH <sub>2</sub> O
Accuracy	+/- 0.5% fsd

### Temperature Measurement

Input Type	K-Type thermocouple
Range	-58°F to 1832°F (-50°C to 1000°C)*
Resolution	1°F (1°C)
Accuracy	+/- (0.3% of rdg + 2°F) or +/- (0.3% of rdg + 1°C)

\* The thermocouple supplied (GK11M) has the ability to measure temperatures in the -50°F to 950°F range.

## MEASUREMENTS - Flue Gas (continued)

**IMPORTANT:** Prior to taking a sample, the device under test should be on and at operating temperature. **Putting the flue probe in the sample area prior to starting the device may cause saturation of the sensors due to the higher initial concentration of carbon monoxide that may be encountered upon start up.** If this happens, allow your analyzer to purge in fresh air until the carbon monoxide level returns to 0 ppm and the oxygen level returns to 20.9%. This may take more than an hour depending on how saturated the sensors are.

Drill a 1/4 inch hole into the flue of the device under test. For most applications, flue gas samples should be taken prior to the draft diverter or any other opening that allows room air to enter the system. This prevents room air from mixing with gases in the flue and diluting the test sample.

***It is important to use manufacturers recommended test locations whenever possible.***

Refer to the figure below for calculating the sample hole location. The figures on the following pages show typical test locations on commonly encountered equipment.

Flue pipe diameter x 1.5 = proper hole location

**Example for a 4 inch flue:**

4 inches x 1.5 = 6 inches

The hole should be drilled 6 inches above the furnace exhaust.

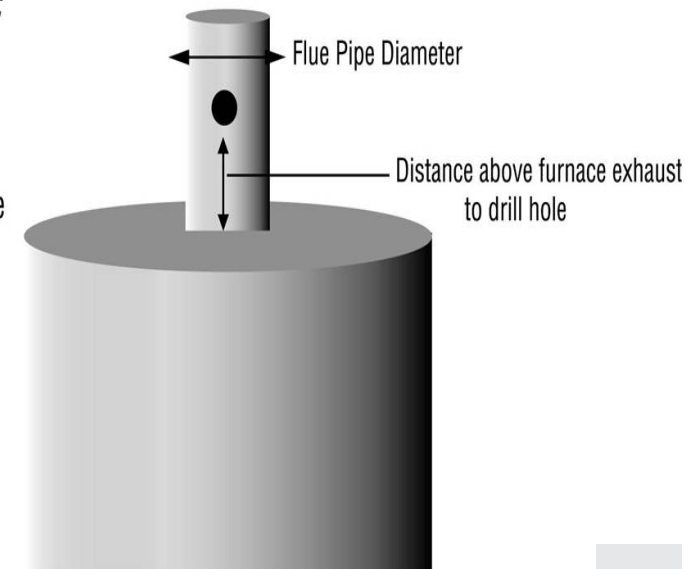

## TYPICAL TEST LOCATIONS

### Atmospheric Gas Fired Fan Assist Boiler / Furnace

#### Typical Test Locations

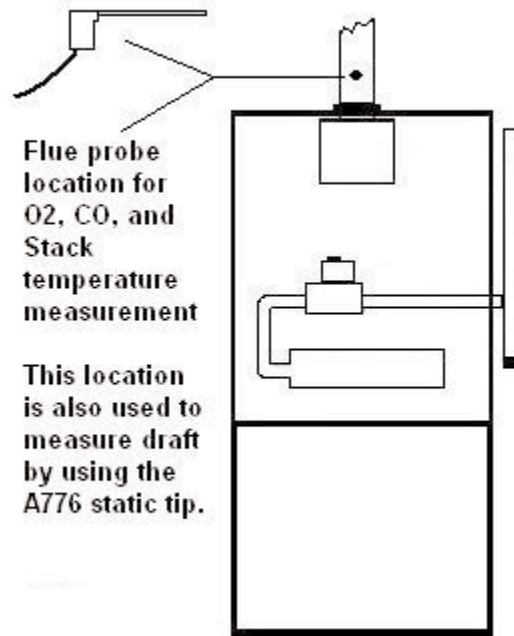

Figure 1

*It is important to use manufacturers recommended test locations whenever possible.*

## SPECIFICATIONS

### Instrument

Operating Temperature Range	14°F to +122°F (-10°C to +50°C)
Battery / Battery Life	Rechargeable Ni-MH / > 6 Hours
Charger Input Voltage	115V or 230V : 50/60 Hz AC
Fuels	Natural Gas, LPG, Light Oil, Heavy Oil, Bituminous Coal, Anthracite Coal, Coke, Butane, Wood, Bagasse
Pressure Ranges	mbar, psi, inH <sub>2</sub> O, mH <sub>2</sub> O, kPa, hPa, inHg, mmHg
Display	Backlit Graphic LCD
Data Storage	100 sets of readings, multiple pages
Single Logging	150 sets of time stamped readings
Time & Date	24 Hour Real Time Clock
Dimensions	7.8" (200mm) x 3.5" 90mm x 2.4" (60mm)
Weight	1.1lbs (500g)
Conforms to	BS7927 (and the draft BS7967)

### Flue Temperature Probe

Construction	Pistol Grip with Stainless Steel Shaft
Hose Length	8.2' (2500mm)
Insertion Length	7.9" (200mm)
'K' Type Thermocouple Accuracy	+/- 0.3% of fullscale, +/- 2°F (1°C)
Maximum Temperature	1472°F (800°C)

## Menu Navigation - Units of Measure

1. From the main menu use the Arrow keys to select “Units of Measure” and press the “Enter” key (center blue soft key).
2. The Units of Measure menu will display. The following parameters are accessible in this menu. Use the Arrow keys and center blue soft key to select the appropriate parameter.

**Temperature** - Select between °C and °F for temperature measurements.

**Pressure** - Select between mbar, psi, inH<sub>2</sub>O, mmH<sub>2</sub>O, kPa, hPa, inHg, and mmHg units of measure for pressure readings..

**Efficiency** - Select between Nett and Gross efficiency. Gross efficiency is used in the USA and factors in wet losses. Using Nett efficiency in the USA will result in abnormally high efficiencies.

## Menu Navigation - Sensor Info

Allows the user to see the last and next calibration date of the sensors that are installed in the 716.

## Menu Navigation - Instrument Info

Provides the serial number, firmware version, and firmware date for reference. Also shows the last calibration date of the unit and batter voltage / condition.

## Menu Navigation - Calibration Mode

This is for factory use only.

## MEASUREMENTS - Flue Gas (continued)

### TYPICAL TEST LOCATIONS

#### Condensing Boiler / Furnace

#### Typical Test Locations

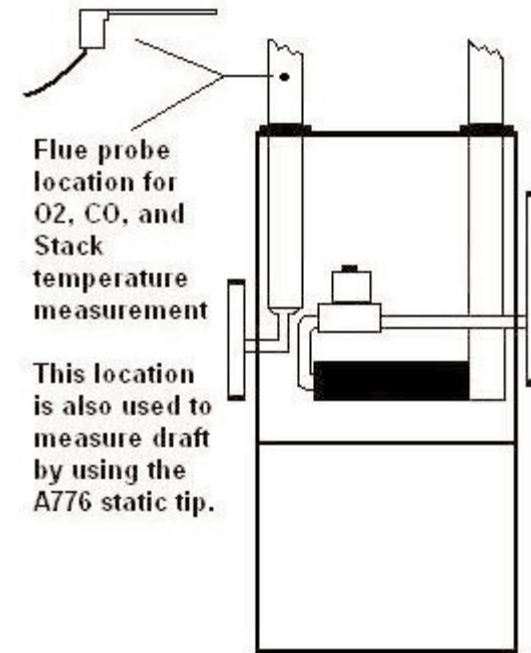

Figure 2

*It is important to use manufacturers recommended test locations whenever possible.*

## TYPICAL TEST LOCATIONS

### Atmospheric Forced Air Furnace

#### Typical Test Locations

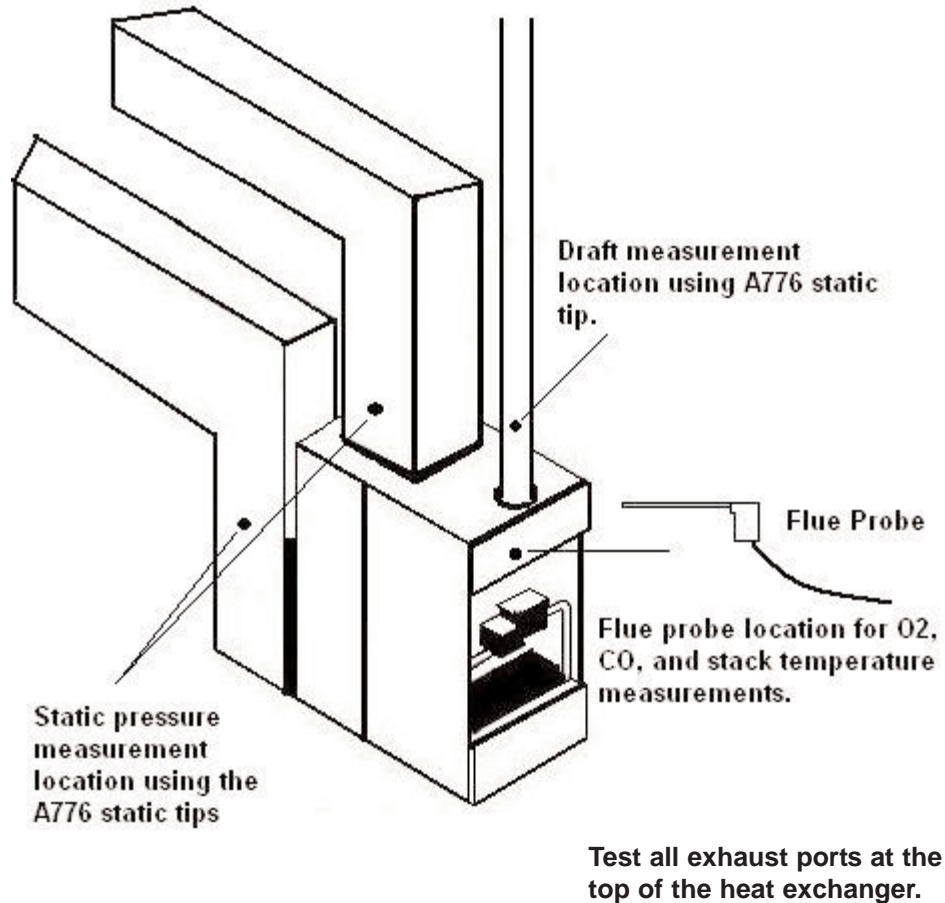

Figure 3

*It is important to use manufacturers recommended test locations whenever possible.*

## Menu Navigation - Analyzer Setup

1. From the main menu use the Arrow keys to select “Analyzer Setup” and press the “Enter” key (center blue soft key).

2. The Analyzer Setup menu will display. The following parameters are accessible in this menu. Use the Arrow keys and center blue soft key to select the appropriate parameter.

**Display type** - Allows the display to be switched between 8 line and 4 line.

**Date / Time** - Used to set the current date and time. The date is in dd:mm:yyyy format and the time is a 24 hour clock.

**Contrast** - Lighten or darken the display contrast.

**Backlight** - Adjust the backlight level from off to full brightness or set it to auto and the 716's internal sensor will control the backlight brightness depending on ambient light.

**Alarm limits** - Set the level at which the CO alarm sounds. The level is adjustable from 10ppm to 3000ppm and can be turned off. Default level is 2000ppm.

**Print Header** - Enables the two line header on printouts to the infrared printer to be set with your companies information. After pressing “Enter” you will be asked for a password. Enter “7160” and press “OK”. Select Header Line 1 and then use the Arrow keys to enter line one of the header. Press “Enter” then repeat the process for line 2 of the header.

**Auto Power** - Enables the auto power off time to be set. The timer can be disabled or set to one of the following times; 5, 10, 20, 30, or 60 minutes. If a key has not been pressed during the time set, the analyzer will automatically begin to turn off.

**Memory** - Enables memory maintenance as outlined on page 29.

## Menu Navigation - Fuel Type

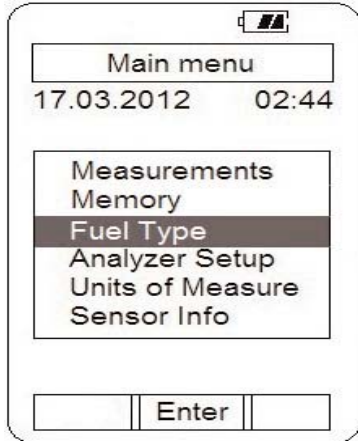

1. From the main menu use the Arrow keys to select “Fuel Type” and press the “Enter” key (center blue soft key).

2. Use the Arrow keys to select the fuel type. Scrolling down displays the rest of the available fuel types.

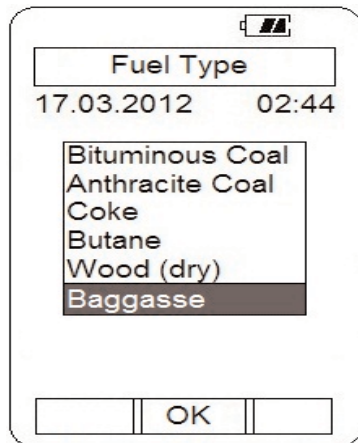
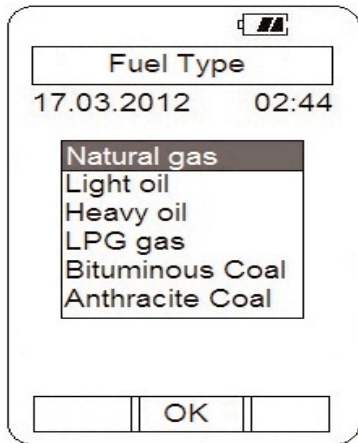

3. press the “OK” key (center blue soft key) to confirm the selection.

Fuel type can also be changed from the flue gas zeroing screen as outlined earlier in this instruction manual.

## MEASUREMENTS - Flue Gas (continued)

Insert the flue probe into the sample hole of the device under test. The probe tip should be in the middle of the flue pipe or exhaust stream.

Ensure the In-Line Filter / Water Trap hangs below the analyzer in the proper vertical position when readings are being taken. Failure to comply reduces the effectiveness of the water trap and may result in damage to the instrument. Refer to the pictures below for correct and incorrect use.



**WARNING:** - Should the CO reading rise above 2,000ppm a continuous series of Alarm Beeps will be heard. The Probe should immediately be disconnected from the instrument and the instrument returned to a clean air environment. This Alarm alerts the user that there is a high concentration of CO, and this procedure will protect the sensors within the instrument. The alarm level can be changed. Please see Appendix D

Make sure to check the water trap periodically during testing to ensure it does not fill with condensate and empty it as necessary. If the filter begins to fill during a test, open the lid and empty out the condensate. After closing the lid, allow readings to stabilize again.

**IMPORTANT:** The water trap is fitted with a water block filter (p/n A794W) in the lid to prevent water from flowing down into the pump. If the water trap fills the water block filter will stop the flow to the analyzer and FLO ERR will display. The water trap should be emptied immediately if this happens. The water block filter may need to be dried out or replaced before testing can resume.

## MEASUREMENTS - Flue Gas (continued)

Allow the readings to stabilize. Multiple parameters can be seen in the display.

Flue gas	
17.03.2012	02:44
Natural gas	
CO	85 ppm
CO2(c)	10.2%
Ratio	0.003
Effi(g)	82.3%
O2	4.3%
XAir	10%
NO	0 ppm
NOx	0 ppm
Send	Save

- Carbon Monoxide (CO) reading in parts per million (ppm)
- Carbon Dioxide (CO2) figure in percentage (%) (calculated)
- CO/CO2 (Ratio) figure. The 716 calculates this number by first converting the CO2 measurement from percentage to ppm. The formula for this conversion is:  $CO2ppm=(CO2\%*10,000)$ . This ratio is not used in any other calculations.  $10,000ppm = 1\%$
- Oxygen (O2) reading in percentage (%)
- Excess Air (X Air) in percentage
- Calculated Efficiency (Eff.) figure in percentage (**Note: Gross Efficiency is used in the USA**)
- Nitric Oxide (NO) (measured) and Nitrogen Oxide (NOx) (calculated). **716N Model Only.**

Pressing the Up / Down Arrow keys enables the rest of the screen to be displayed.

Flue gas	
17.03.2012	02:44
Natural gas	
CO	85 ppm
COAF	85
NO	0 ppm
T1-ST	420 °F
T2-AT	68 °F
ΔT	352 °F
Prsu	0.000 inH2O
Pump	1150 cc/min
Send	Save

- Carbon Monoxide (CO) reading in parts per million (ppm)
- Carbon Monoxide Air Free (COAF) in parts per million (ppm) (calculated). CO air free takes into account excess air (make up air) and factors this out of the displayed reading. Some systems inject extra air to ensure complete combustion. This can dilute the CO sample resulting in a low CO reading when the standard CO display is being read.
- Nitric Oxide (NO) (measured). **716N Model Only.**
- Temperature T1-ST (stack temperature) T2-AT (ambient temperature).
- Temperature T1 - T2 (ΔT)
- Pressure (Prsu)
- Pump draw rate in cc/min.

**NOTE: COAF should only be used if the manufacturer specifications are stated as CO air free. If used on a system that is not specified in CO air free the reading may appear abnormally high as compared to the specification.**

## Menu Navigation - Memory

From the Main menu there are several sub menus that allow analyzer set up, memory maintenance and other parameters to be accessed. Here is a list of each and what function they perform.

Main menu	
17.03.2012	02:44
Measurements	
Memory	
Fuel Type	
Analyzer Setup	
Units of Measure	
Sensor Info	
Enter	

1. Memory can be accessed from the main menu to enable maintenance to be performed. Use the Arrow keys to select "Memory" and press the "Enter" key (center blue soft key).

Memory	
17.03.2012	02:44
Flue gas store	
Temp/Prsu store	
CO room logger	
Tightness store	
Enter	

2. Use the Arrow keys to select the memory type to be accessed. Press the "Enter" key (center blue soft key) to confirm the selection.
3. Depending on the memory type selected all or some of the options shown below will be available.

Memory IR Print - Allows information printed in specific addresses to be printed to the optional infrared printer (p/n A740)

Memory All Clear - Clears information out of all memory locations.

Memory PC Out - Sends all information stored in memory to a PC. Requires optional USB cable and software.

Memory Recall - Enables information from memory locations to be recalled and displayed for viewing.

4. Use the Arrow keys and blue soft keys to access these functions.

## Measurements - Leak Detection

The Leak Detection function enables the 716 to test for combustible gas leaks in gas valves and fittings using the included gooseneck probe.

1. Connect the combustible gas probe to the USB connector located on the top of the 716. See picture below.

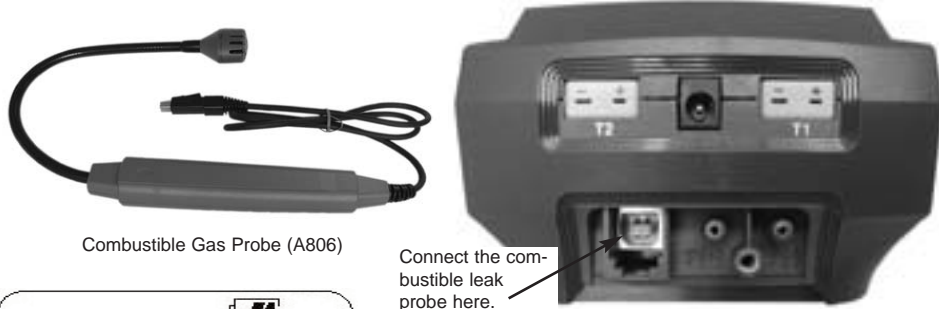

Combustible Gas Probe (A806)

Connect the combustible leak probe here.

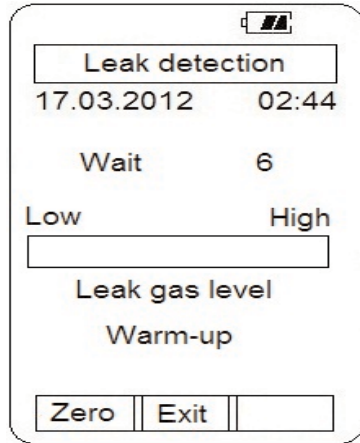

2. From the main menu select "Measurement" as outlined on page 12. From the "Measurements" menu select "Leak detection" and the following screen will display.

3. The 716 will begin to countdown from 30. During this time the combustible sensor is being warmed up and prepared for use. A light in the sensor cage will illuminate and can be used to aid in seeing fittings in dark areas.

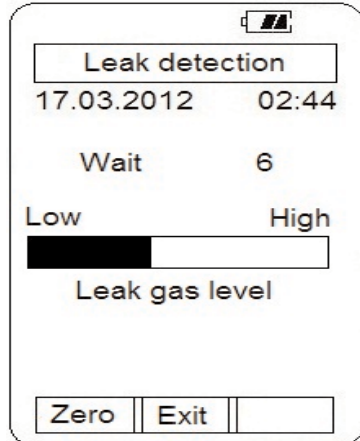

4. After the warm-up period is complete the Leak detection screen will display and a constant tick will be heard. Use the combustible gas probe to begin looking for leaks.

5. When a leak is encountered the tick rate will increase and the Low to High bar graph will visually indicate a leak. Press the "Zero" key (left blue soft key) to reset (nullify) the tick and continue looking for the leak. Repeat this process until the probe is directly over the source of the leak.

6. Press the "Exit" key (center blue soft key) to return the 716 to the "Measurements" menu.

## MEASUREMENTS - Flue Gas (continued)

Flue gas	
17.03.2012	02:44
Natural gas	
CO	85 ppm
CO2(c)	10.2%
Ratio	0.003
Effi(g)	82.3%
O2	4.3%
XAir	10%
NO	Real Data Save
NOx	Address: 2
	OK Save

Test data can be saved to a memory location if required.

1. Press the Save key (right blue soft key) and "Real Data Save" and "Address:" will be displayed.
2. Using the Up and Down Arrow keys select the memory location to save the data.
3. Press the OK key (center blue soft key) to save the data.

Flue gas	
17.03.2012	02:44
Natural gas	
CO	85 ppm
CO2(c)	10.2%
Ratio	0.003
Effi(g)	82.3%
O2	4.3%
XAir	10%
	Real Data Print
	Real Data PC Out
	Send OK

Test data can be sent to an optional infrared printer (p/n A740) or to a PC using optional cable and software.

1. Press the Send key (left blue soft key) and "Real Data Print" and "Real Data PC Out" will be displayed.
2. Using the Up and Down arrow keys select the type of output you require. If printing data to the printer, align the window of the analyzer with the window on the printer about 6 to 8 inches apart. If sending data to a PC, connect the USB cable to the analyzer and computer and run the 716 PC software.
3. Press the OK key (center blue soft key) to print or send data to a PC.

## Typical Test Results

**Actual test results vary depending on the equipment under test. TPI recommends you check with the manufacturer of the equipment being tested to determine specific acceptable results.**

### Power Burners (Gas Fired)

<b>Oxygen</b>	3% to 6%
<b>Carbon Monoxide</b>	Less than 100ppm (air free)
<b>Stack Temperature</b>	300°F to 500°F
<b>Draft</b>	-0.15 inH2O

### Power Burners (Oil Fired)

<b>Oxygen</b>	4% to 7%
<b>Carbon Monoxide</b>	Less than 100ppm (air free)
<b>Stack Temperature</b>	325°F to 625°F
<b>Draft</b>	-0.15 inH2O

### Gas Fired Burners (Atmospheric / Fan Assist)

<b>Oxygen</b>	7% to 9%
<b>Carbon Monoxide</b>	Less than 100ppm (air free)
<b>Stack Temperature</b>	325°F to 500°F
<b>Draft</b>	-0.15 inH2O to -0.4 inH2O

## Measurements - CO Room Test

The CO room test function enables the 716 to monitor and log ambient CO levels in a room or office space at 1 minute intervals. This data can be retrieved later via the optional infrared printer or serial cable and software.

1. Begin with the 716 in a fresh air environment outside of the test area. From the main menu select "Measurement" as outlined on page ##. From the "Measurements" menu select "CO room test" and the zeroing screen will display.

2. If "Skip" is displayed the analyzer sensor is zeroed and ready for use. Press the center blue soft key to move to the next screen. If "Skip" is not displayed, wait for the zero process to finish and the next screen will be displayed automatically.

3. After the zero process the CO room test display will appear. At this time the page address where the data will be stored can be changed as necessary. Press the "Chang" key (left blue soft key) and use the Arrow keys to change the address location.

4. Press the "Start" key (center blue soft key) to begin CO monitoring. The pump will start and the 716 will begin storing readings every minute. The number of readings stored can be seen at the bottom of the screen. The real, minimum, maximum, and average CO measured will be displayed too.

5. When the desired number of readings have been taken press the "Stop" key (center blue soft key).

6. Stored readings can be sent to a PC or printer by pressing the "Send" key (left blue soft key) and selecting "Print Out" or "PC Out".



## Measurements - Temperature & Pressure (continued)

### Tightness Test -

The tightness test function enables the 716 to check for pressure leaks in valves, fittings, and pressure switches with an elapsed time reference.

1. From the main menu select “Measurement” as outlined on page 12. From the “Measurements” menu select “Tightness test” and the following screen will out-down may be repeated several times until the sensor initiates.

2. If necessary, press the “Chang” key (right blue soft key) and then use the “Arrow” keys to change the address location where the test data will be stored.

3. Connect pressure sampling tube to the (+) pressure port and make sure there are no restrictions in the tubing. Press the “Zero” key (left blue soft key) to zero the manometer.

4. Connect the tubing to the device under test. Pressurize the device to the required level.

5. Press the “Save1” key (center blue soft key). This saves the initial pressure (Start P1) and activates the elapsed time clock.

6. When the elapsed time has reached the level outlined by the manufacturer of the device under test press the “Save2” key (center blue soft key). The start pressure, finish pressure, and pressure difference along with the elapsed time of the test will be displayed. This data is stored in the address location selected earlier.

7. Press the “End” key (center blue soft key) to end the test or press the “Send” key (left blue soft key) activates a sub-menu that allows you to print to the optional A740 printer (Print Out) or send the test data to a PC using the optional cable and software (PC Out). Use the “Arrow” keys to select the desired output method and press the “OK” key (left blue soft key) to confirm the selection.

## Measurements - Temperature & Pressure

From the Main menu screen using the Up / Down Arrow keys select “Measurements” in the menu.

Press “Enter” (center blue soft key) to confirm the selection.

From the Measurements menu use the Up / Down Arrow keys to select “Temp/Pressure” in the menu.

Press “Enter” (center soft blue key) to confirm the selection.

The Temperature / Pressure screen will display.

This screen displays both T1 and T2 channels of temperature as well as the difference between T1 and T2 ( $\Delta T$ ).

If no probe is connected to the input “-----” will be displayed indicating an open connection.

Pressure (Prsu) is also displayed in this screen.

## Measurements - Temperature & Pressure (continued)

Measuring Temperature -

1. Ensure you have a 'K' type probe connected to one or both of the thermocouple sockets T1 / T2 (refer to figure below)



**WARNING:** - There is ONLY one correct way to connect the 'K' type thermocouple plug into the socket (see page 7). Forcing the plug into the socket the wrong way may result in damage to the instrument.

2. Touch the temperature probe to the item under test and read the displayed temperature.

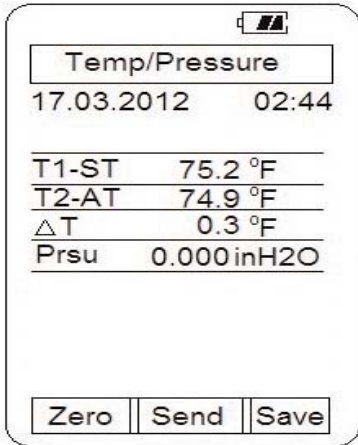

Other Features:

- Pressing “Send” (center blue soft key) activates a sub-menu and allows information to be sent to the optional A740 infrared printer or to a PC using the optional USB interface cable and software.
- Pressing “Save” (right blue soft key) activates a sub-menu that allows the screen data to be saved in a memory location (0 to 99) for later retrieval.
- Pressing “Zero” (left blue soft key) zeros the manometer. This is used prior to measuring pressure.

**NOTE:** Analyzer shown in picture above with optional second GK11M probe. Analyzer ships with one GK11M as standard.

## Measurements - Temperature & Pressure (continued)

Measuring Pressure -

1. Ensure you have Pressure Sampling Tube connected to one or both of the Pressure Ports and there are no restrictions in the tubing (see figure below)



2. Zero the display by pressing the “Zero” Key (left blue soft key).
3. Connect the tube(s) to the device under test and read the pressure on the

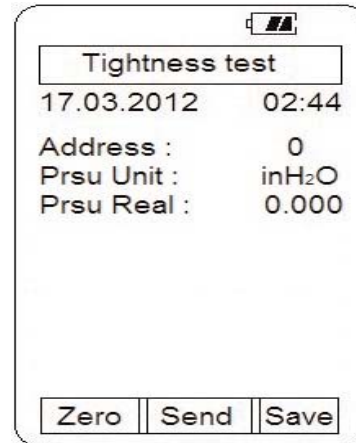

display.

Other Features:

- Pressing “Send” (center blue soft key) activates a sub-menu and allows information to be sent to the optional A740 infrared printer or to a PC using the optional USB interface cable and software.
- Pressing “Save” (right blue soft key) activates a sub-menu that allows the screen data to be saved in a memory location (0 to 99) for later retrieval.
- Pressing “Zero” (left blue soft key) zeros the manometer. This is used prior to measuring pressure.

The 716 incorporates a differential manometer. Pressure applied to the (-) port is subtracted from the pressure applied to the (+) port. Examples of pressures being measured:

- (+) port = 10”H<sub>2</sub>O, (-) port = Not Connected, Displayed reading = 10”H<sub>2</sub>O
- (+) port = 10”H<sub>2</sub>O, (-) port = 5”H<sub>2</sub>O, Displayed reading = 5”H<sub>2</sub>O