

Combustion Efficiency Analyzer

717



The Value Leader™
www.tpi-thevalueleader.com



Call Us 1.877.571.7901

Contents

Introduction.....	1
General Overview.....	1, 2
Instrument Overview.....	3 ~ 7
Front View.....	3
Keypad.....	4
Back View.....	5
Side Views.....	6
Top View.....	7
Basic Analyzer Functions.....	8, 9
Analyzer Batteries.....	8
Turning The Analyzer On & Fuel Selection..	8, 9
Turning The Analyzer Off.....	9
Activating The Backlight.....	9
Combustion Analysis Overview.....	10
Combustion Analyzer Mode.....	11 ~ 19
Combustion Test Procedure.....	11 ~ 19
Typical Test Locations.....	13 ~ 15
Combustion Analysis Displays.....	17 ~ 18
Typical Test Results.....	19
Thermometer Mode.....	20
Manometer Mode.....	21
Let By Pressure Test Mode.....	22, 23
Setting Date & Time.....	24
Storing Data.....	25
Recalling Data.....	26
Printing Data.....	27, 28
Specifications.....	29, 30
Calibration & Service.....	31
Warranty.....	31
Appendix A	General Maintenance & Function Tests..... 32~ 34
Appendix B	A773 Sulfur Filter Installation & Maintenance. 35, 36
Appendix C	Error Codes and Troubleshooting..... 37, 38
Appendix D	Field Sensor Replacement..... 39 ~ 42
Appendix E	Technical Notes..... 43
Appendix F	Testing for Carbon Monoxide in Ambient Air.... 44
Appendix G	Carbon Monoxide Limits in Ambient Air Chart.. 45
Appendix H	Carbon Monoxide Facts..... 46
Appendix I	Battery Replacement..... 47

Introduction

Thank you for purchasing TPI brand products. The TPI 717 combustion analyzer is a state of the art, easy to use analyzer designed not only to display and calculate the required readings from a flue but also to cover most of the other measurements associated with combustion. The instrument is ruggedly constructed and comes with a 3 Year unit and 2 Year sensor Guarantee.

General Overview

The TPI 717 combustion analyzer uses field replaceable state of the art electrochemical sensors. This sensor technology provides the longest lasting, most accurate and reliable means for performing combustion tests. The sensors in your analyzer will need to be replaced periodically and calibration is recommended once every year.

Electrochemical sensors by nature are always active. Therefore the time the analyzer is off and not being used must be taken into account when determining sensor life. The sensors in your analyzer are warranted for two years. This warranty does not cover sensors damaged through misuse of the analyzer.

You should keep the batteries of your 717 fresh so power is constantly being supplied to your sensors.

The following guidelines will help prevent damage to your sensors:

Always use the mini pump filter when testing flue gases.

Always periodically check and replace the mini pump filter as needed.

Always make sure the in-line filter / water trap is installed properly.

Always periodically check and replace the in-line filter as needed.

Always remove water or condensation from the inside of the in-line filter / water trap assembly prior to performing tests.

Always use the optional oil filter (p/n A773) when performing tests on oil burning equipment.

General Overview (Continued)

Never over saturate your sensors by performing tests on equipment with gas levels beyond the capability of your analyzer.

Always keep the A796 water trap / filter assembly clean and replace the filter as necessary. Replacement filter part number is A762F.

This manual will guide you through the functions of the TPI 717 which will give you many years of reliable service.

Your TPI 717 Flue Gas Analyzer comes complete with the following standard accessories:

- TPI 717 Instrument
- Rubber Boot (A765)
- Soft Carrying Case (A768)
- Flue Sampling Probe (A770)
- In-Line Filter assembly installed on Flue probe (A796)
- Temperature Probe (GK11M)
- Mini Pump Protection Filter Assembly and spare filters (A763)
- Exhaust Spigot (removable) (A764)
- Instruction Manual

() Denotes part number

Your TPI 717 Flue Gas Analyzer has the following options available:

- Infrared printer (A740)
- Spare In-Line Filter (A762F is a package of 5 filters)
- Field replaceable smart CO sensor (A760S)
- Field replaceable smart O2 sensor (A761S)

Instrument Overview

Front View

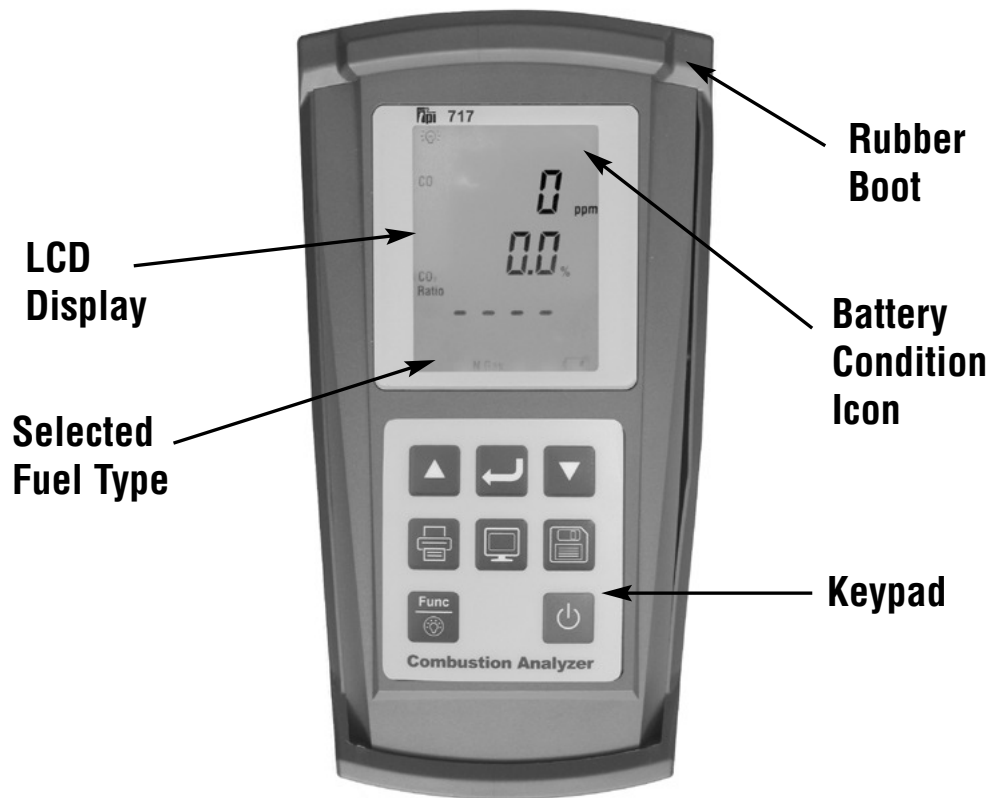

Rubber Boot	Protects the instrument from accidental damage
Display	Large 3 Parameter Backlit LCD Display
Battery Condition Icon	Shows condition of batteries.
Keypad	Selects all available functions
Selected Fuel Type	N GAS, LPG, LIGHT OIL, HEAVY OIL, OPT 1 (Bituminous Coal), OPT 2 (Anthracite Coal), OPT 3 (Coke), OPT 4 (Butane), OPT 5 (Wood), OPT 6 (Bagasse)

NOTE: When selecting oil as fuel be sure to use the optional oil filter (A773) or readings could become erratic. See Appendix E for installation instructions.

Keypad



Scrolls through selectable fuels (see page 8)
Switches between °C and °F (see pages 18 & 21)
Scrolls through selectable pressure units
Moves up through the Stored Data Addresses



Zeroes pressure reading (See page 21)
Moves down through the Stored Data Addresses



Scrolls through Combustion Analysis Displays (See 17& 18)
Turns ch2 temperature ON/OFF (see page 20)
Allows you to choose a Stored Data Address



Sends stored data to a separate infrared printer (see pg 25)



Allows you to view stored data on the display (see pg 24)



Stores readings to memory (see pg 23)



Scrolls through and selects analyzer functions (see 20~22)
Turns Backlight ON and OFF (see 9)



Turns the instrument ON and OFF (see pages 8 & 9)

Back View

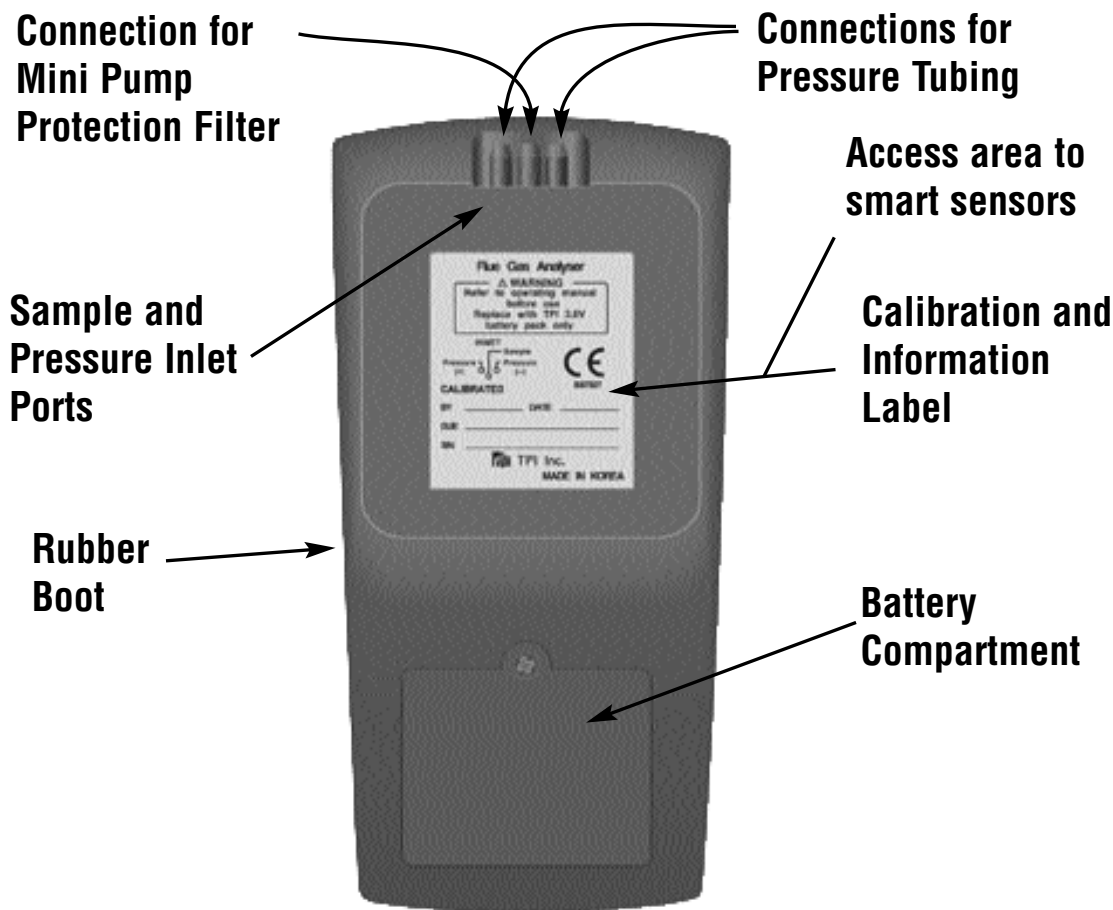

Sample and Pressure Inlet Ports: Connection for Flue Probe
(see pages 7 & 11)

Connection for Mini Pump Protection
Filter (see pages 7 & 11)

Connection for pressure tubing
(see pages 7 & 21)

Calibration and Information Label: Displays calibration information and
serial number

Battery Compartment: Holds 3 AA Alkaline Batteries

Rubber Boot: Protects the instrument

Smart Sensor Access: For field replaceable sensors
(See appendix L)

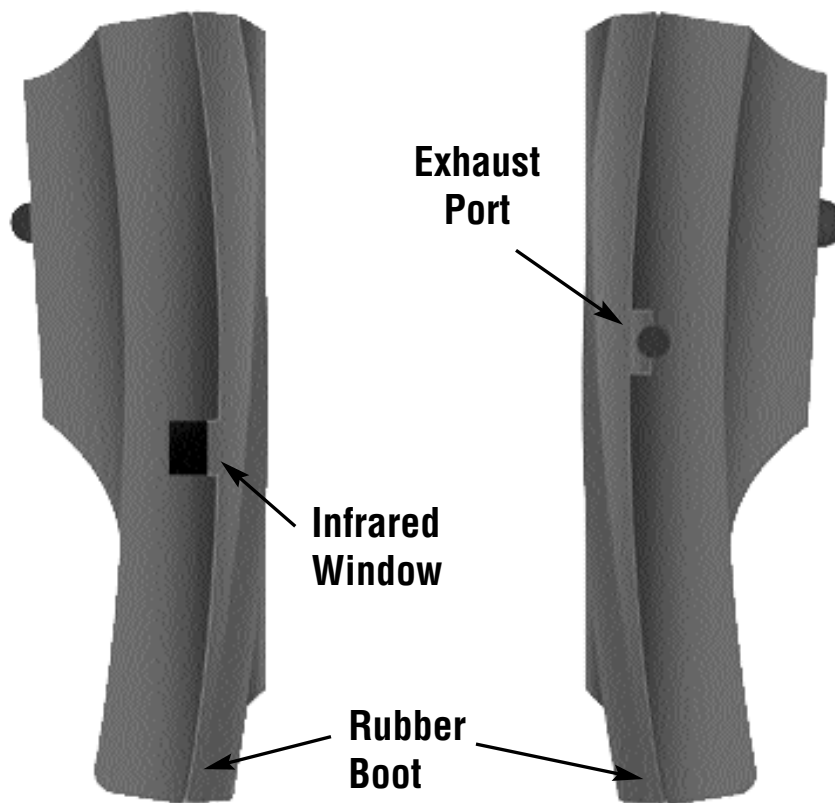

Side Views

Exhaust Port

Port for connection of Exhaust Adapter

Infrared Window

Window for sending stored data to IR Printer
(see page 25)

Rubber Boot

Protects the instrument from accidental damage

Top View

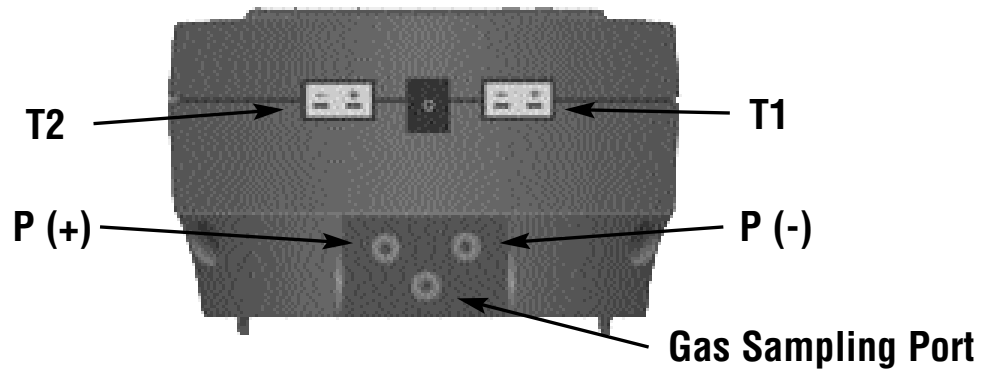





- T1 Socket** Connection for thermocouple plug on flue probe (see page 11)
Connection for any 'K' type thermocouple probe (see page 20)
- T2 Socket** Connection for ambient 'K' type thermocouple probe (see page 11)
Connection for any 'K' type thermocouple probe (see page 20)
- Gas Sample Port** Connection for Mini Pump Protection Filter and Flue Probe (see pages 7 & 11)
- P (+) Port**
P (-) Port Connections for Pressure Tubing (see page 21)

BASIC ANALYZER FUNCTIONS

Analyzer Batteries

Your combustion analyzer is fitted with three AA size 1.5V alkaline batteries. It is important to keep battery power to the sensors in your analyzer even when it is not in use.

Your analyzer has a battery status indicator in the lower right corner of the display. Battery status is determined as follows:

-  Indicates batteries are at full capacity.
-  Indicates batteries are at 2/3 capacity.
-  Indicates batteries are at 1/3 capacity. Replacement of batteries should be considered soon.
-  Indicates batteries are very low and in need of replacement immediately. See Appendix J for battery replacement instructions.

Turning The Analyzer On & Fuel Type Selection

Always: - Before turning on please ensure that the Mini Pump Protection Filter assembly and the Temperature Sampling Probe complete with In-Line Filter or the Tubing & In-Line Filter are not connected to the Gas Sample Port (see page 7)

The instrument MUST be turned on in a clean air environment as the initial purge will set the Carbon Monoxide level to Zero and the Oxygen to 20.9%. Press and hold down the Power Key and the TPI 717 will start its 30 second countdown 'Purging...' will be displayed.

After the 717 has completed purging the fuel type can be selected by pressing the Up Arrow key. The selected fuel type is displayed in the lower left corner of the display. Selectable fuels are Natural Gas, LIGHT OIL, HEAVY OIL, LPG, Bituminous Coal, Anthracite Coal, Coke, Butane, Wood (Dry), Bagasse, and Wood Pellet.

After start up, several tests can be performed to ensure proper function of the analyzer and flue probe. Please refer to Appendix A.

****NOTE: When selecting oil as fuel be sure to use the optional oil filter (A773) or readings could become erratic. See Appendix E for installation instructions.***

After the 30 second countdown the instrument is ready to take Flue, Temperature, and Pressure readings and the default combustion display will be displayed.

The 717 will auto power off if no keys have been pressed for 10 minutes and the CO level is below 15ppm. Auto off can be disabled (see Appendix D). The auto power off feature is always enabled upon power up.

The Scroll/Enter Key allows you to scroll through the combustion displays as outlined on pages 17&18. The Func Key is used to select the 717 function mode and allows you to set it to be a combustion analyzer, manometer, or thermometer. In addition, the Func Key is used to access the date and time display. See pages 20 through 24 for more information on the Func Key.

Turning The Analyzer Off

Always: - Before turning off return the instrument to a clean air environment and allow the Carbon Monoxide level to return to below 15ppm and the Oxygen level to return to 20.9% ($\pm 0.3\%$) Press the Power Key to turn the instrument off:- NOTE Should you attempt to turn the instrument Off and the CO reading is above 15ppm then the instrument will remain On and a short Beep will be heard. The Instrument can only be switched off if the CO is below 15ppm

The instrument has an auto shut off after 10 minutes should no keys have been pressed for this period and as mentioned above that the CO is below 15ppm. Should the CO be above 15ppm then the 10 minute auto shut off countdown will not begin till the CO has gone below 15ppm. The auto power off feature can be disabled. Please see Appendix D. The auto power off feature is always enabled upon power up.

Activating the Backlight

The display backlight can be activated at any time by pressing and holding down the Func Key for approximately 2 seconds. The backlight will automatically shut off after approximately 20 seconds to preserve battery life.

COMBUSTION ANALYSIS OVERVIEW

Performing combustion analysis is very important to the overall safety and efficiency of heating equipment. The following guidelines and descriptions are generic and meant to provide you with a basic understanding of combustion testing. TPI always recommends you contact the manufacturer of the device under test, obtain information specific to the device, and follow the procedures and safety guidelines for performing tests and affecting repairs.

In general, for most applications, flue gas samples should be taken prior to the draft diverter or any other opening that allows room air to enter the system. This prevents room air from mixing with gases in the flue and diluting the test sample. To ensure accurate and consistent combustion tests, it is important gas and temperature samples be taken at the same location. This is easy with the TPI flue probe because the temperature sensor is an integral part of the probe.

Prior to taking a sample, the device under test should be on and operating. Putting the flue probe in the sample area prior to starting the device may cause saturation of the sensors due to the higher initial concentration of carbon monoxide that may be encountered upon start up. If this happens, allow your analyzer to purge in fresh air until the carbon monoxide level returns to 0 ppm and the oxygen level returns to 20.9%. This may take more than an hour depending on how saturated the sensors are.

The figures on pages 13 through 15 show locations for performing tests on commonly encountered equipment. Remember to consult with the manufacturer of the device under test for specific test information.

Pressing the Func Key enables access to the different functions available on the 717. The default function is Combustion Analyzer. Other available functions are: Thermometer, Manometer/Tightness Test, and Date / Time display.

Refer to the Appendix G “Technical Notes” for additional information.

Combustion Analyzer (Default Start Up Mode)

COMBUSTION TEST PROCEDURE

Note: It is recommended you perform routine general maintenance on your analyzer to ensure proper function. Please refer to Appendix A for general maintenance schedule and function tests.

1. Turn the 717 on in fresh air as outlined on page 8. After the initial purge cycle the 717 will default to combustion analyzer mode and combustion display 1 will be seen.

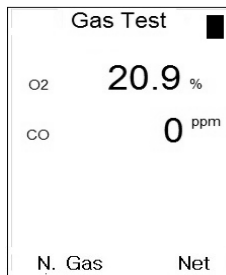

- **Combustion Display 1 (Default Start Up Display)**

- Displays Oxygen (O₂) reading in percent (%)
- Displays Carbon Monoxide (CO) in parts per million (ppm)

2. Connect the Mini Pump Protection Filter assembly and Flue Probe Tubing complete with In-Line Filter to the Gas Sample Port and the 'K' Type Thermocouple Plug from the Flue Probe into Thermocouple (T1) Socket. The GK11M ambient air temperature probe is connected to the (T2) socket. (See below & page 7)

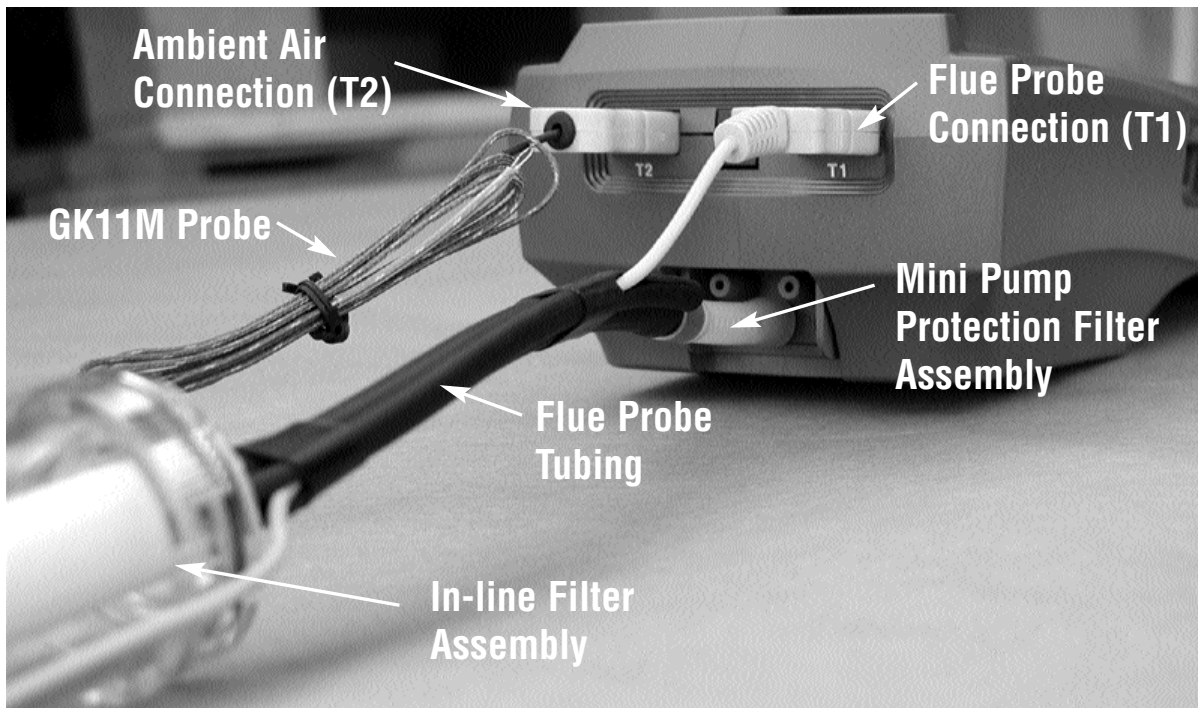

WARNING: - Ensure the 'K' type thermocouple probes are inserted into the sockets correctly (see page 7). The plugs are polarity marked and forcing the plug into the socket the wrong way may result in damage to the instrument.

IMPORTANT: Prior to taking a sample, the device under test should be on and at operating temperature. **Putting the flue probe in the sample area prior to starting the device may cause saturation of the sensors due to the higher initial concentration of carbon monoxide that may be encountered upon start up.** If this happens, allow your analyzer to purge in fresh air until the carbon monoxide level returns to 0 ppm and the oxygen level returns to 20.9%. This may take more than an hour depending on how saturated the sensors are.

3. Drill a 1/4 inch hole into the flue of the device under test. For most applications, flue gas samples should be taken prior to the draft diverter or any other opening that allows room air to enter the system. This prevents room air from mixing with gases in the flue and diluting the test sample.

It is important to use manufacturers recommended test locations whenever possible.

Refer to the figure below for calculating the sample hole location.

Flue pipe diameter x 1.5 = proper hole location

Example for a 4 inch flue:

4 inches x 1.5 = 6 inches

The hole should be drilled 6 inches above the furnace exhaust.

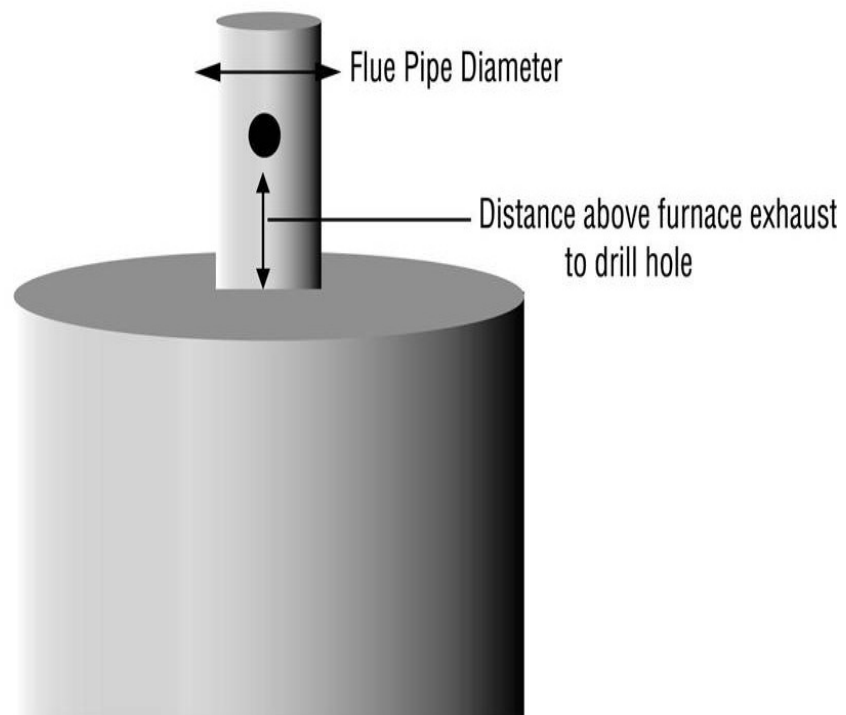

The figures on the following pages show typical test locations on commonly encountered equipment.

TYPICAL TEST LOCATIONS

Atmospheric Gas Fired Fan Assist Boiler / Furnace

Typical Test Locations

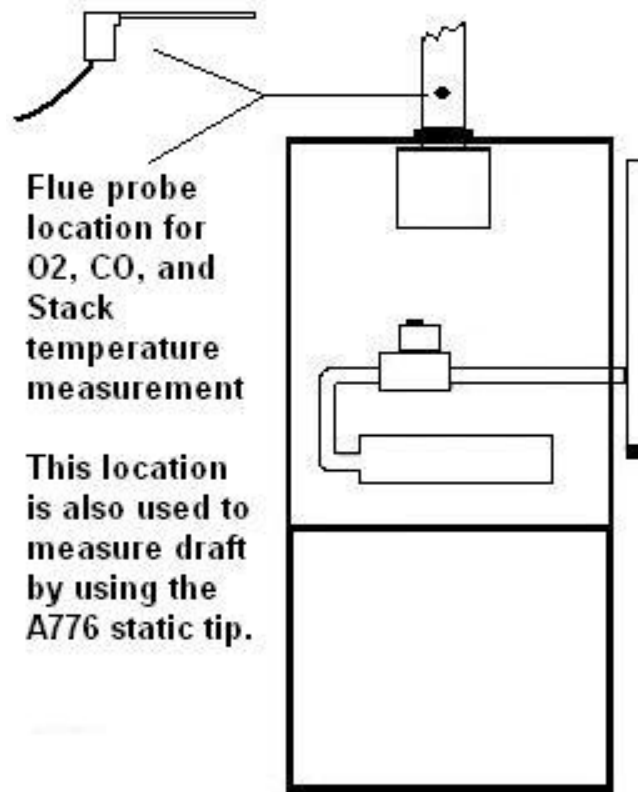

Figure 1

It is important to use manufacturers recommended test locations whenever possible.

TYPICAL TEST LOCATIONS

Condensing Boiler / Furnace

Typical Test Locations

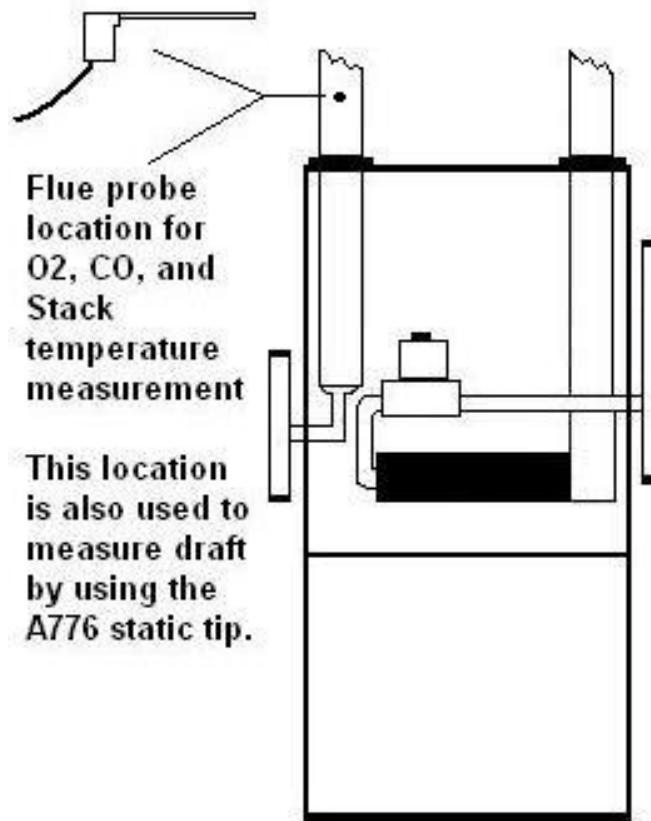

Figure 2

It is important to use manufacturers recommended test locations whenever possible.

TYPICAL TEST LOCATIONS

Atmospheric Forced Air Furnace

Typical Test Locations

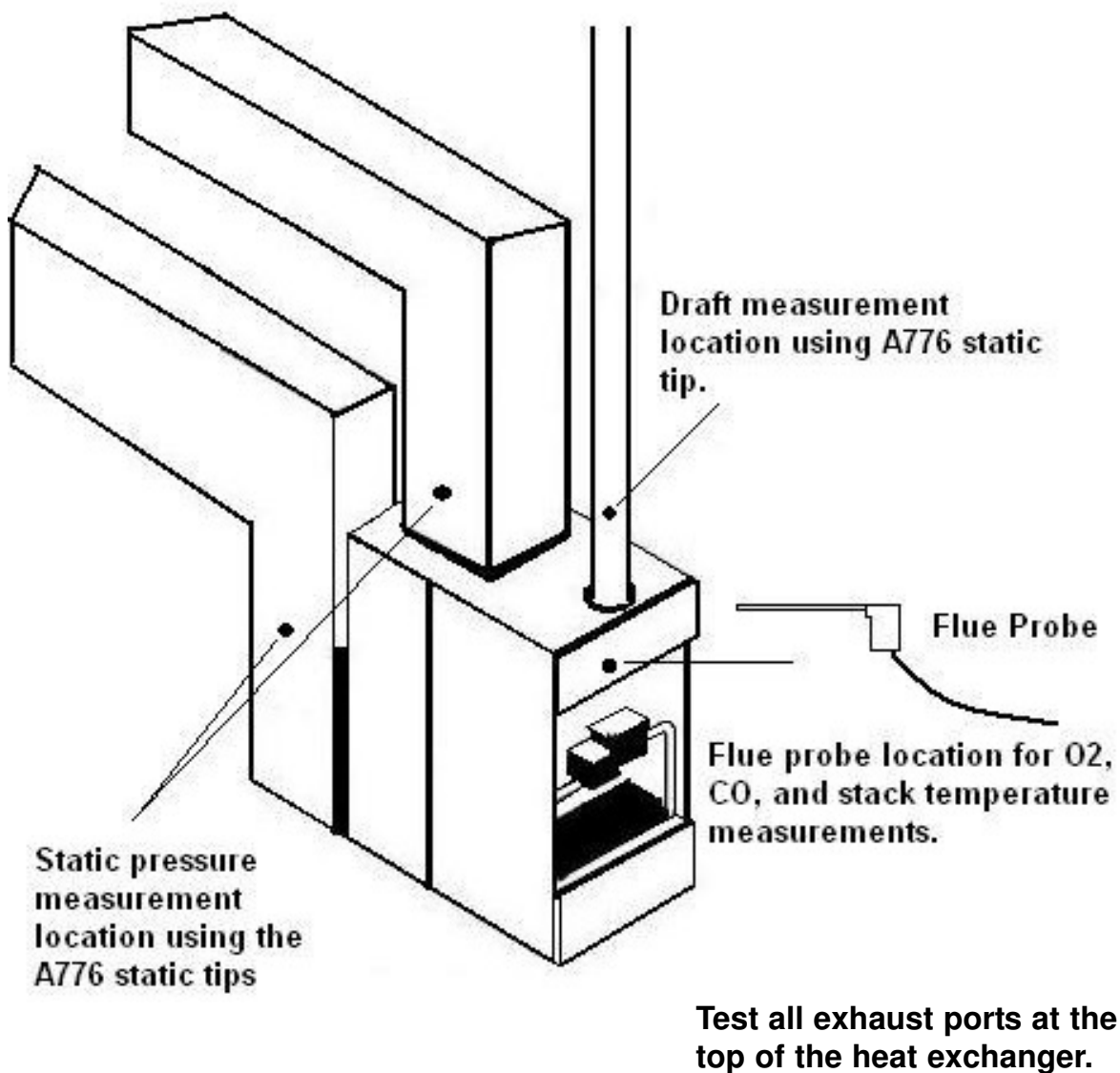
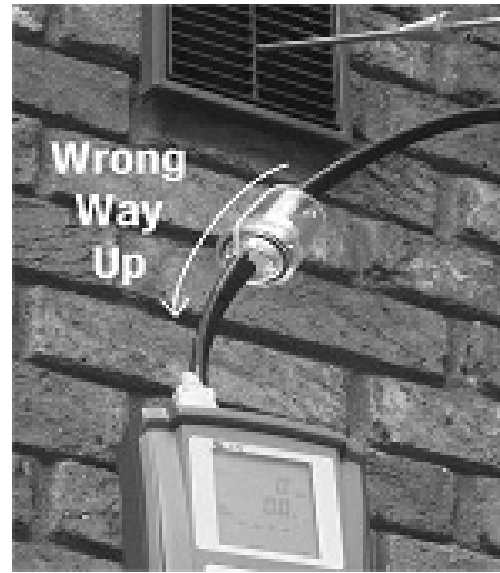
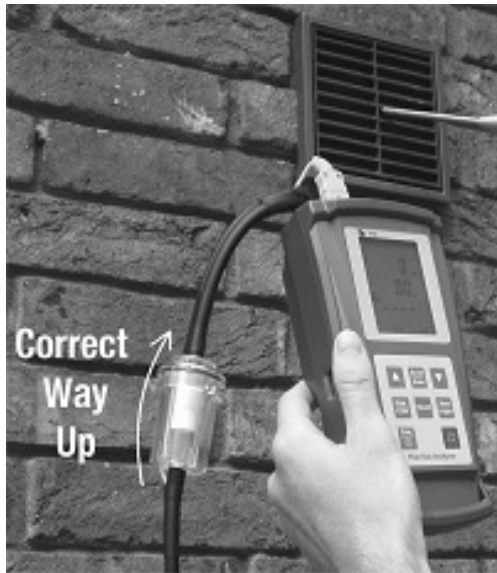

Figure 3

It is important to use manufacturers recommended test locations whenever possible.

4. Insert the flue probe into the sample hole of the device under test. The probe tip should be in the middle of the flue pipe or exhaust stream.

Ensure the In-Line Filter / Water Trap hangs below the analyzer in the proper vertical position when readings are being taken. Failure to comply reduces the effectiveness of the water trap and may result in damage to the instrument. Refer to the pictures below for correct and incorrect use.



WARNING: - Should the CO reading rise above 2,000ppm a continuous series of Alarm Beeps will be heard. The Probe should immediately be disconnected from the instrument and the instrument returned to a clean air environment. This Alarm alerts the user that there is a high concentration of CO, and this procedure will protect the sensors within the instrument. The alarm level can be changed. Please see Appendix D

Make sure to check the water trap periodically during testing to ensure it does not fill with condensate and empty it as necessary. If the filter begins to fill during a test, open the lid and empty out the condensate. After closing the lid, allow readings to stabilize again.

IMPORTANT: The water trap is fitted with a water block filter (p/n A794W) in the lid to prevent water from flowing down into the pump. If the water trap fills the water block filter will stop the flow to the analyzer and FLO ERR will display. The water trap should be emptied immediately if this happens. The water block filter may need to be dried out or replaced before testing can resume.

5. Allow the readings to stabilize. Multiple combustion analysis displays are available to provide the various test results. Use the Scroll/Enter Key to move through the various combustion displays.

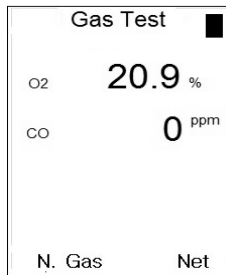

• **Combustion Display 1 (Default Start Up Display)**

- Displays Oxygen (O2) reading in percent (%)
- Displays Carbon Monoxide (CO) reading in parts per million (ppm)
- Pressing the Down Arrow Key will toggle between Gross & Net Efficiency (**Note: Gross Efficiency is used in the USA. Refer to Appendix G, Note 4 for additional information**)
- Pressing the UP Arrow Key will toggle between available fuels (see page 8)

Pressing the Scroll Enter key changes the display:

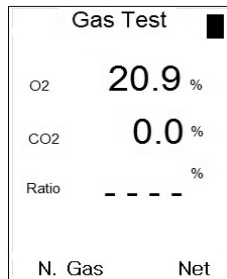

• **Combustion Display 2**

- Displays Oxygen (O2) reading in percentage (%)
- Displays Carbon Dioxide (CO2) calculation in percentage (%)
- Displays calculated CO/CO2 (Ratio) figure. The 717 calculates this number by first converting the CO2 measurement from percentage to ppm. The formula for this conversion is: $CO2ppm = (CO2\% * 10,000)$. This ratio is not used in any other calculations. $10,000ppm = 1\%$

Pressing the Scroll Enter key changes the display:

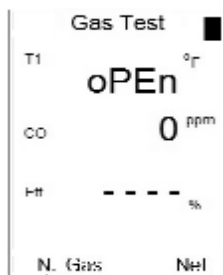

• **Combustion Display 3**

- Displays Temperature reading on input T1
- Displays Carbon Monoxide (CO) reading in parts per million (ppm)
- Displays Combustion Efficiency (Eff.) in percentage (%)
- Pressing the Down Arrow Key will toggle between Gross & Net Efficiency (**Note: Gross Efficiency is used in the USA. Refer to Appendix G, Note 4 for additional information**)

Pressing the Scroll Enter key changes the display: (Next Page)

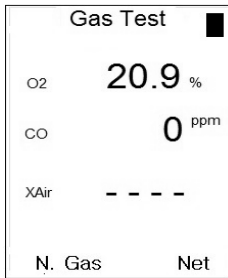

• **Combustion Display 4**

- Displays Oxygen (O₂) reading in percent (%)
- Displays Carbon Monoxide (CO) reading in parts per million (ppm)
- Displays Excess Air (XAir) in percentage (%)

The formula for CO air free is: $CO_{airfree} = (20.9/20.9 - O_2 \text{ meas.}) \times CO \text{ meas.}$

Pressing the Scroll Enter key changes the display:

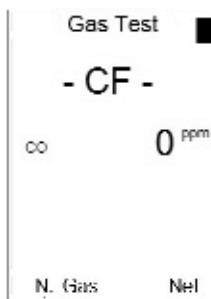

• **Combustion Display 5**

- Displays CO air free (-CF-)

CO air free takes into account excess air (make up air) and factors this out of the displayed reading. Some systems inject extra air to ensure complete combustion. This can dilute the CO sample resulting in a low CO reading when the standard

CO display is being read.

This display should be used if the manufacturer specifications are stated as CO air free. If it is used on a system that is not specified in CO air free the displayed reading may appear abnormally high as compared to the manufacturer specification.

Pressing the Scroll Enter key again will make the display return to combustion display 1 (Default display)

6. During a combustion test you can save, print, and send data to a computer. See pages 25 through 31. Allow readings to stabilize before saving or printing the data. Refer to page 19 for typical test results.

7. Pressure measurements can be made during a combustion test if required. Refer to page 21.

8. After the test is complete, remove the flue probe from the test location and allow the analyzer to purge in a fresh air environment with the probe attached. Make sure the analyzer purges to below 15ppm. Never remove the battery to turn the analyzer off before the purge is complete. Refer to page 9 for complete instructions.

Typical Test Results

Actual test results vary depending on the equipment under test. TPI recommends you check with the manufacturer of the equipment being tested to determine specific acceptable results.

Power Burners (Gas Fired)

Oxygen	3% to 6%
Carbon Monoxide	Less than 100ppm (air free)
Stack Temperature	300°F to 500°F
Draft	-0.15 inH ₂ O

Power Burners (Oil Fired)

Oxygen	4% to 7%
Carbon Monoxide	Less than 100ppm (air free)
Stack Temperature	325°F to 625°F
Draft	-0.15 inH ₂ O

Gas Fired Burners (Atmospheric / Fan Assist)

Oxygen	7% to 9%
Carbon Monoxide	Less than 100ppm (air free)
Stack Temperature	325°F to 500°F
Draft	-0.15 inH ₂ O to -0.4 inH ₂ O

Thermometer Mode

With the analyzer running, press the Func Key to access the thermometer function. In this mode the 717 functions like a K-Type thermocouple thermometer. The pump will stop running when in this function.

The thermometer function allows you to perform temperature tests.

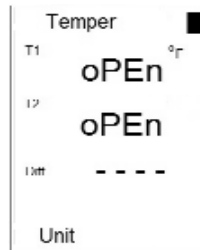

Function Display 1 (Temperature)

T1 Temperature

T2 Temperature

Differential Temperature

1. Ensure you have a 'K' type probe connected to one or both of the thermocouple sockets T1 or T2 (refer to figure below)



WARNING: - There is ONLY one correct way to connect the 'K' type thermocouple plug into the socket (see page 7). Forcing the plug into the socket the wrong way may result in damage to the instrument.

2. Touch the temperature probe to the item under test and read the displayed temperature.

Other Features:

- Pressing the Up Arrow Key will toggle between °C and °F
- 'oPEn' will be displayed if no 'K' type probe is connected to the thermocouple socket

NOTE: Analyzer shown in picture above with optional second GK11M probe. Analyzer ships with one GK11M as standard.

Manometer Mode

With the analyzer running, press the Func Key repeatedly to access the manometer function. In this mode the 717 functions like a differential manometer. The pump will stop running when in this function.

The pressure function allows you to perform draft and pressure tests.

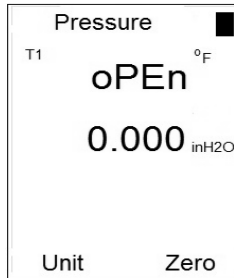

Function 2 Display (Pressure)

Temperature reading (T1)
Pressure reading

1. Ensure you have Pressure Sampling Tube connected to one or both of the Pressure Ports and there are no restriction in the tubing (see figure below)



2. Zero the display by pressing the Down Arrow Key.

3. Connect the tube(s) to the device under test and read the pressure on the display.

Other Features:

- Pressing the Up Arrow Key will scroll through mbar, kPa and inH2O
- Pressing the Down Arrow Key will Zero the Pressure reading

The 717 incorporates a differential manometer. This means when a single hose is connected to the (+) port and pressure is applied, the 717 will read positive pressure. If a single hose is connected to the (-) port and pressure is applied, the 717 will read a negative pressure. If both ports are connected to a pressure, the 717 will read the difference (P1 - P2) between the two.

Let By Pressure Test Mode

With the analyzer running, press the Func Key repeatedly to access the Let By pressure test function (Tightness test). In this mode the 717 can perform a standing pressure test. (This feature is used predominately in the U.K.)



“Let By” will be shown at the top of the display and the pump will stop running when in this function.

1. Ensure you have Pressure Sampling Tube connected to the (+) Pressure Port and there are no restriction in the tubing.
2. Zero the display by pressing the Down Arrow Key.
3. Connect the tube to the device under test and press Go (Enter Key).

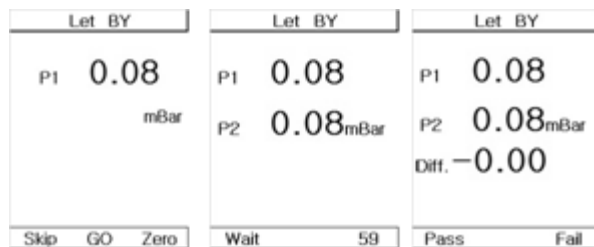

4. Once “GO” is pressed the analyzer will begin a 60 second countdown and Wait will display in the lower left corner of the display.
5. After the countdown is displayed “Pass” and “Fail” will be displayed. If the pressure bled down out of specification for the device under test then “Fail” should be pressed (Down Arrow Key) and the test is over. The results can be printed by pressing the print key or stored by pressing the save key.
6. If the device did not leak down then “Pass” is pressed (Up Arrow Key) and the screen changes to “Stabilize”. Press Go (Enter Key).

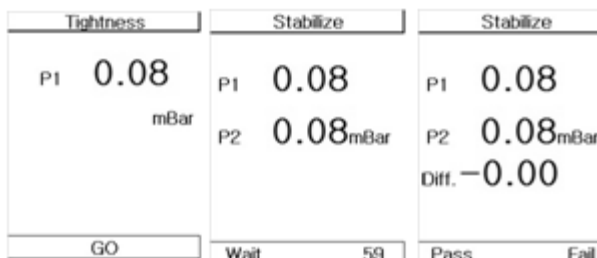

7. Once “GO” is pressed the analyzer will begin a 60 second countdown and Wait will display in the lower left corner of the display.

Let By Pressure Test Mode (continued)

8. After the countdown is displayed “Pass” and “Fail” will be displayed. If the pressure bled down out of specification for the device under test then “Fail” should be pressed (Down Arrow Key) and the test is over. The results can be printed by pressing the print key or stored by pressing the save key.

9. If the device did not leak down then “Pass” is pressed (Up Arrow Key) and the screen changes to “Tightness”. Press Go (Enter Key).

Tightness		Tightness		Tightness	
P1	0.08	P1	0.08	P1	0.08
P2	0.08 _{mBar}	P2	0.08 _{mBar}	P2	0.08 _{mBar}
		Diff.	-0.00	Diff.	-0.00
Wait	120	Pass	Fail	Finish..	

10. Once “GO” is pressed the analyzer will begin a 120 second countdown and Wait will display in the lower left corner of the display.

11. After the countdown is displayed “Pass” and “Fail” will be displayed. If the pressure bled down out of specification for the device under test then “Fail” should be pressed (Down Arrow Key) and the test is over. The results can be printed by pressing the print key or stored by pressing the save key.

12. If the device did not leak down then “Pass” is pressed (Up Arrow Key) and the screen changes to “Finish...”. The test results can be printed by pressing the print key or stored by pressing the save key.

CO Room Test

In this mode the 717 will log a Carbon Monoxide reading once per minute. This can be used to monitor CO levels in a room over a period of time.

1. With the analyzer running, press the Func Key repeatedly to access the CO room test function.

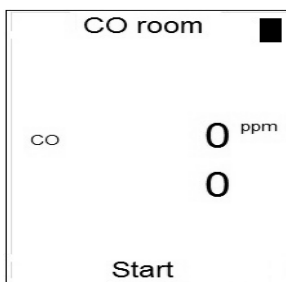

2. Press Start (Enter Key).

3. The 717 will begin saving CO readings once per minute for up to 50 readings.

4. Press Stop (Enter Key) or wait until 50 readings have been saved.

5. Test results can be saved by pressing the Save Key or printed by pressing the Print Key.

SETTING DATE AND TIME

With the analyzer running, press the Func Key repeatedly to access the date/time screen. From this function Time, Date and Year can be changed.

If the Date and Time do not need to be changed, press the Func Key to bypass this function and return the 712 to combustion analyzer mode (Function 1).

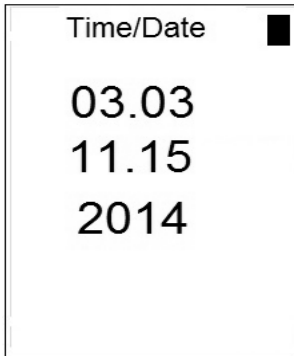

The 717 uses a 24 hour clock.

The first line is the time in HH.MM format.

The second line is the date in MM.DD format.

The third line is the year.

1. Once the Time, Date, and Year screen is displayed, press and hold the Print and Down Arrow Keys until "Clock Set" is displayed.
2. Use the Print Key and Recall Key to change the cursor location.
3. Use the Up Arrow and Down Arrow Keys to change the value.
4. Once the time and date has been entered press the Enter Key to store the time and date.

STORING DATA

During testing data can be stored for later retrieval.

When data is saved, all data previously in the address will be overwritten. When saving pressure/draft readings, select an address different from the one used to save combustion readings.

1. Press the Store Key.
2. “Addr” and an address location from 0 to 99 will flash on the display. Use the Up/Down Arrow Keys to select the desired location to store the data and press the Scroll/Enter Key. *To cancel storing information press the Function Key.*
3. The data is stored and the analyzer returns to normal operation.

You have just successfully stored a set of readings which can be reviewed on screen (see pg 26) or sent to the IR printer (see pg 27)

RECALLING DATA

The recall feature allows you to display stored data or retrieve the last date of calibration.

Recalling Saved Data or Calibration Date

Recalling Flue gas, Temperature, or Pressure data -

1. Press the Recall button once.
2. The display will show “FluE”. Use the Arrow Keys to select the desired data to recall. (“FLue” for flue gas test data, “tE P” for temperature data, “PrSu” for pressure data, “CAL” for last calibration date.function. *To cancel recalling information press the Function Key.*
3. Press the Enter Key.
4. “Addr” will be displayed and a number from 0 to 99 will flash. *Note: If CAL was selected the calibration date will be displayed. Proceed to step 6.*
3. Using the up and down arrows, select the memory location of the readings you want to display.
4. Press the Scroll/Enter key once. The 717 will display a page of the data that was stored and RECALL will be displayed.
5. Use the Enter Key to scroll through the data that was saved.
6. Press the Function Key to return to normal operation.

PRINTING DATA

WARNING: - To operate correctly there must be a clear line of sight between the Infrared Window on the instrument (see 3.3) and the Infrared Window on the IR Printer (see Printer instructions). Place the printer so it is no closer than approximately 6 inches from the analyzer.

1. Press the Print Key once 'rEAL', "Stor", and "Cal" will be displayed and 'rEAL' will be flashing. *To cancel printing press the Function Key.*

Selecting 'rEAL' will cause the 717 to print the test data currently on the display (real time data). Selecting 'Stor' will cause the 717 to print data stored in memory. Selecting "Cal" will cause the 717 to print the last date of calibration. Use the Up and Down Arrow Keys to select the desired print mode and press the Scroll/Enter Key.

REAL Print Mode - If rEAL print mode is selected, the analyzer will display 'Wait' 'out' and bars will change position on the LCD until printing is complete.

STOR Print Mode - If Stor mode is selected, 'Addr' will be displayed on the top line along with 'SA ' and a location number from 0 to 49 will be flashing on the screen. Select the required address location that you wish to print data from by pressing the Up and Down Arrow Keys and press the 'Scroll/Enter' Key. The analyzer will display 'Wait', 'out' and bars will change position on the LCD until printing is complete.

CAL Print Mode - If Cal print mode is selected, the analyzer will display 'Wait' 'out' and bars will change position on the LCD until printing is complete.

After printing is complete, 'End' will be displayed and 'YES' (or 'no') will blink. Selecting 'YES' will return the 717 to normal operation, selecting 'no' will return the 717 to the print selection screen so you can print again. Use the Up and Down Arrow Keys to make the selection and press the Scroll/Enter Key.

Combustion and pressure/draft printouts must be performed separately. Perform a combustion test and save the data. Perform a pressure/draft test and save the data in a different address. Print each address separately.

PRINTING DATA (Continued)

Printout Interpretation

Date : 07/07/06
Time : 14:22

Fuel : Natural Gas

----- Report -----
CO (ppm) 30
O2 (%) 3.9
CO2 (%) 9.7
Ratio(CO/CO2) .0001
CO Air Free (ppm) 37
Excess Air (%) 22.9
Gross Effi (%) 78.9
Temp_CH1 (F) 350
Temp_CH2 (F) 74

Smoke : 1 2 3 4 5

Customer:

Address:

Reading Accepted by:

14:22, 07/07/06

Date and time of combustion test.

Fuel type selected during test.

Data from combustion test is printed here.

Smoke Test Result. For use on oil fired equipment. (Circle one to indicate the result of a smoke test performed using the optional A788 smoke test pump.)

Customer information and signed confirmation of test. (Fill in this data and have the customer sign for confirmation.)

SPECIFICATIONS

Instrument

Operating Temperature Range	32°F to +122°F (-10°C to +50°C)
Battery	1.5V AA size (3)
Battery Life	> 6 Hours
Fuels	Natural Gas, LPG, Light Oil, Heavy Oil OPT 1 (Bituminous Coal), OPT 2 (Anthracite Coal), OPT 3 (Coke), OPT 4 (Butane), OPT 5 (Wood), OPT 6 (Bagasse)
Display	Backlit LCD
Data Storage	50 sets of readings
Time & Date	24 Hour Real Time Clock
Dimensions	200mm x 90mm x 60mm
Weight	500g
Casing	Rubber Boot as Standard
Switch Off	Failsafe
Exhaust	Safety Spigot
Conforms to	BS7927 (and the draft BS7967)

Flue Temperature Probe

Construction	Pistol Grip with Stainless Steel Shaft
Hose Length	2500mm
Insertion Length	200mm
'K' Type Thermocouple Accuracy	+/- 0.3%, +/- 1°C
Maximum Temperature	1472°F (800°C)

Gases

	Range	Resolution	Accuracy
Oxygen	0-25%	0.1%	+/- 0.3%
Carbon Monoxide	0-10,000 ppm	1 ppm	+/- 5 ppm or 5% Whichever is greater
Carbon Dioxide	0-25%	0.1%	Calculated
CO/CO2 Ratio	0-0.999	0.001	Calculated
Combustion Efficiency	0-100%	0.1%	Calculated

SPECIFICATIONS (Continued)

Pressure Measurement

Selectable Ranges	mbar, kPa and inH ₂ O
Range	- 150 mbar to + 150 mbar -15 kPa to + 15 kPa -60 inH ₂ O to 60 inH ₂ O
Resolution	0.01 mbar, 0.001 kPa, 0.001 inH ₂ O
Accuracy	+/- 0.5% fsd

Temperature Measurement

Input Type	K-Type thermocouple
Range	-58°F to 1832°F (-50°C to 1000°C)*
Resolution	1°F (1°C)
Accuracy	+/- (0.3% of rdg + 2°F) or +/- (0.3% of rdg + 1°C)

* The thermocouple supplied (GK11M) has the ability to measure temperatures in the -50°F to 950°F range. The 712 accepts industry standard K-type thermocouple probes with sub-mini connectors.

CALIBRATION & SERVICE

It is recommended that your analyzer be calibrated every 12 months. Please consult Test Products International for further details or send your analyzer to the address below for service.

TPI / Attn. Repair
9615 SW Allen Blvd. Suite 104
Beaverton, OR 97005

The following are consumable parts for the instrument:

In-Line Filter Element (pkg of 5)	User Replaceable	A762F
Water Block Filter	User Replaceable	A794W
Mini Pump Protection Filter Assem.	User Replaceable	A763
**Oxygen Sensor	User / Factory Replaceable	A761
**Carbon Monoxide Sensor	User / Factory Replaceable	A760
<i>**Sensor replacement requires calibration gas.</i>		

Sensors for the 717 can be replaced in the field. Please see appendix # for the replacement procedure.

WARRANTY

Your TPI 717 Flue Gas Analyzer is guaranteed free from defects in materials and workmanship for 3 Years from the date of purchase. This guarantee does not affect your statutory rights. For additional information please refer to the included warranty card or contact TPI at 800-368-5719.

To obtain warranty performance or maintenance on your analyzer: - Include with the product your name, address, phone number, written description of the problem and proof of purchase date. Carefully package and return to:

TPI / Attn. Repair
9615 SW Allen Blvd. Suite 104
Beaverton, OR 97005

Appendix A: General Maintenance

All combustion analyzers use consumable items such filters and probes. These items are user serviceable and can be taken care of by the operator.

The consumable items that will require operator attention are the water trap / filter assembly, flue probe, pump protection filter, and ambient temperature probe.

The recommended maintenance schedule for your analyzer is as follows:

<u>Maintenance Performed</u>	<u>Frequency</u>
Water trap Check	Once per week (Once per day for analyzers that see heavy use or are used in oil fired applications)
Filter Check	
Pump Operation Check	Once per month (More often for analyzers that see heavy use or are used in oil fired applications)
Flue Probe Integrity Check	
Thermocouple Probe Check	

Water Trap Check

Visually check the water trap for:

1. Cracks in the bowl.
2. Broken ears on the bowl where the lid locks on.
3. Broken ears on the lid.
4. Worn out o-ring on the lid.
5. Loose connection to the flue probe tubing.

Filter Check

Signs of dirty or water saturated filters are a slow pump, flow error displayed when the flue probe is connected, and measurements that take longer than normal.

TPI analyzers use three filters to protect the pump and sensors. The first filter to check is the A763 mini pump protection filter. (see picture below)



A763 Pump Protection Filter

Look in the inspection window to check the filter. When the filter material becomes dark, pull the black nose cone out of the tubing and replace the ball filter inside.

Appendix A: General Maintenance (continued)

Filter Check Continued

The other two filters are located in the water trap (p/n A796). The main filter is the A762F particle filter. This filter stops debris and dust from traveling down to the analyzer. The secondary filter is the A794W water block filter. This filter stops flow in the event the water trap fills with condensate. Refer to the picture below.

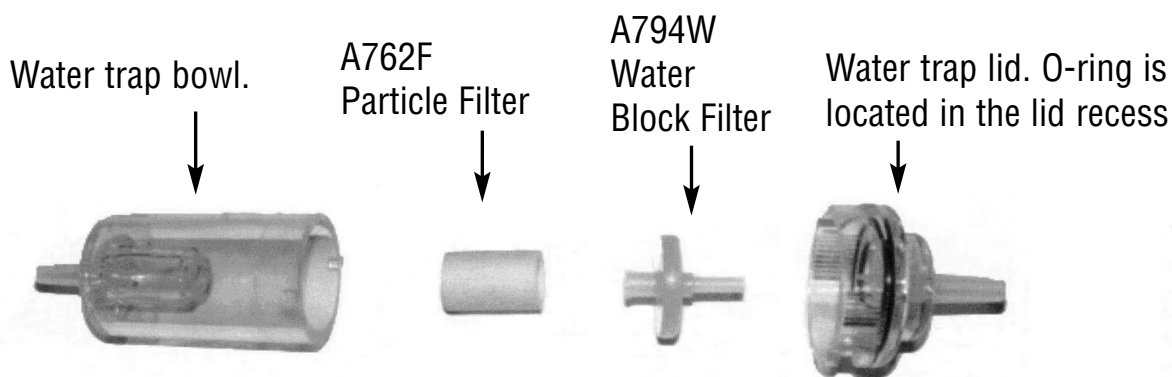

Exploded View of A796 Water Trap

Visually inspect the A762F particle filter. If the filter is discolored on the inside or outside a replacement filter should be installed.

If the A762F is clean but saturated with water a replacement should be installed to ensure proper flow. The saturated filter can be left to dry and reused later.

Pump Operation Check

1. Turn the analyzer on as outlined on page 8. Do not connect anything to the inlet. Wait until the analyzer has completed the initial purge and sensor check and is operating normally prior to proceeding to step 2.
2. Cover the analyzer inlet with your finger. The analyzer should display “FLO ERR” and a rapid beeping should be heard.

If the analyzer does not beep and display “FLO ERR” this may be an indication the flow sensor requires calibration, the pump is faulty, or there is an internal leak. The analyzer should be returned for factory service.

Appendix A: General Maintenance (continued)

Flue Probe Integrity Check

NOTE: Perform this check after performing the Pump Operation Check outlined on the previous page.

1. Turn the analyzer on as outlined on page 8. Do not connect anything to the inlet. Wait until the analyzer has completed the initial purge and sensor check and is operating normally prior to proceeding to step 2.
2. Connect the A763 mini pump protection filter and flue probe assembly to the inlet of the analyzer and the yellow thermocouple connector to input T1.
3. Repeatedly press the Scroll/Enter key until temperature is displayed. If the displayed temperature is approximately the ambient temperature the thermocouple is operating properly and you may proceed to the next step to continue the test. If the displayed temperature is “OL” the thermocouple is open and the probe is in need of factory service.
4. Cover the end of the flue probe with a small piece of tube and pinch the end close. After a short period of time the analyzer should display “FLO ERR” and a rapid beeping should be heard. If this happens the flue probe is operating properly and the integrity test is complete. If the analyzer does not display “FLO ERR” this is an indication of a possible leak somewhere in the flue probe and you may proceed to the next step for further tests.
5. Pinch the hose below the handle of the flue probe. If the analyzer displays “FLO ERR” there is a leak in the handle assembly and the probe needs to be factory serviced. If the analyzer does not display “FLO ERR” proceed to the next step for further tests.
6. Pinch the hose between the analyzer and the water trap. If “FLO ERR” still does not display there may be an internal leak, pump problem, or other issue and the analyzer needs to be factory serviced. If “FLO ERR” is displayed there is a leak in the water trap assembly and the water trap assembly should be checked as outlined on page 39 & 40.

Appendix B: A773 SULFUR FILTER INSTALLATION & MAINTENANCE

When performing combustion tests on oil fired equipment it is important to use the optional A773 sulfur filter. Failure to do so can result in incorrect and readings. This filter also protects the sensors from the affects of sulfur. The A773 does not have to be removed when working with other types of fuels.

PROCEDURE

1. Begin with the water trap section of the flue probe oriented as shown in the picture below.

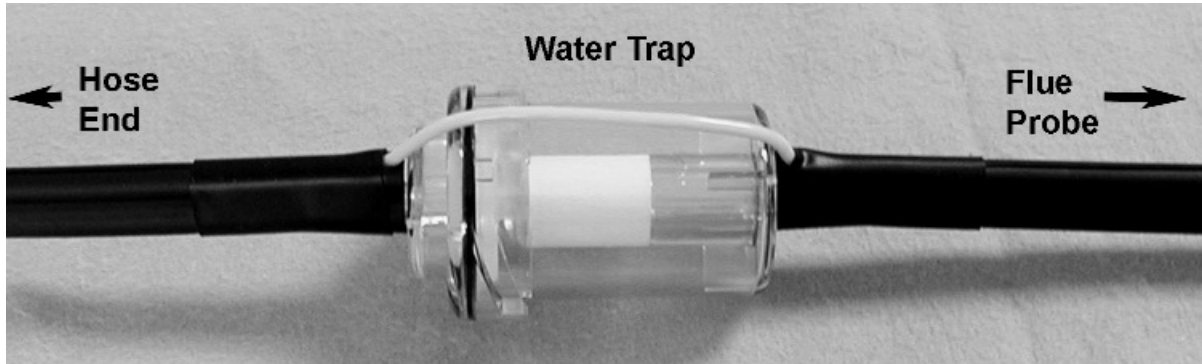

2. Remove the water trap from the flue probe hose. (See picture below)

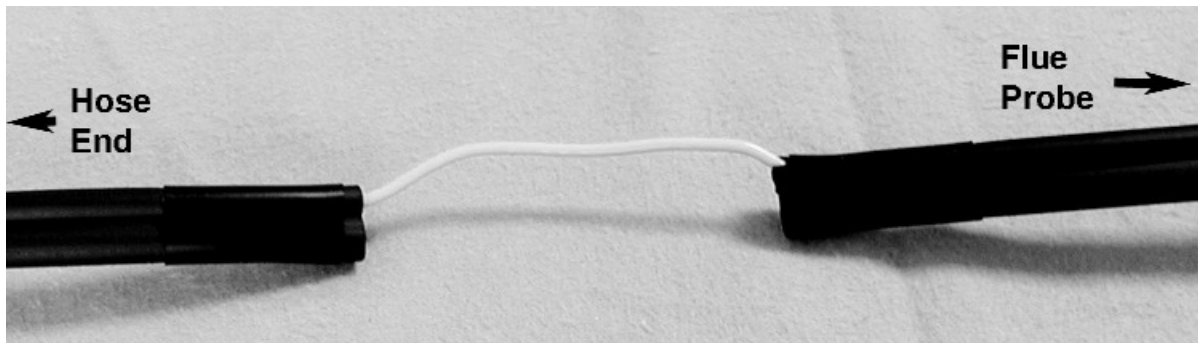

3. Insert the A773 sulfur filter flue probe tube where the water trap was removed..

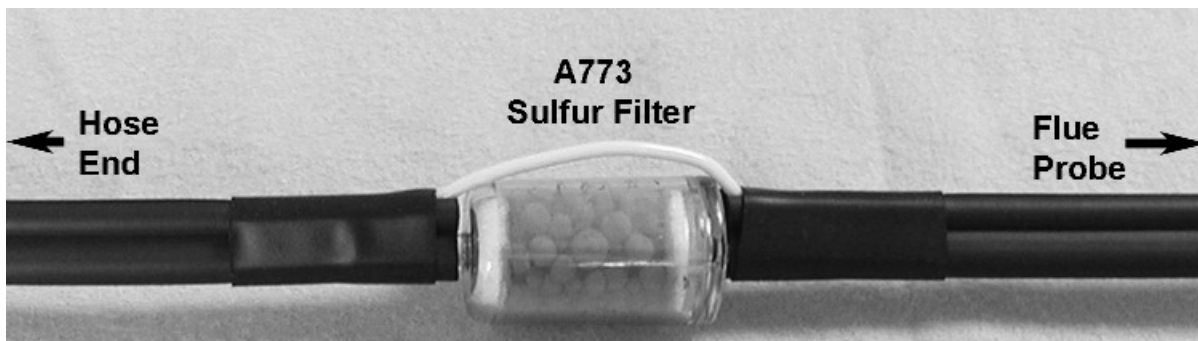

Appendix B: A773 SULFUR FILTER INSTALLATION & MAINTENANCE

4. Beginning on the “Flue Probe” side of the A773 sulfur filter, pull the yellow thermocouple cord out of the channel of the flue probe tube. Pull out approximately the length of the water trap that was removed.
5. Being careful not to cut the yellow cord, cut out a section of the flue probe tubing the length of the water trap on the “Flue Probe” side of the A773 sulfur filter. (See picture below)

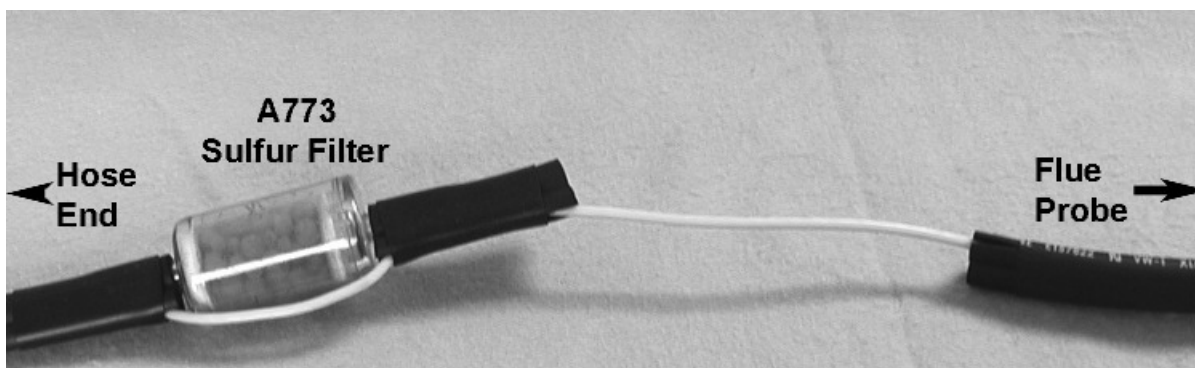

6. Install the water trap in the flue probe hose where the piece was cut out. Make sure the water trap is positioned correctly. The water trap lid should face the “Hose End” side of the hose.

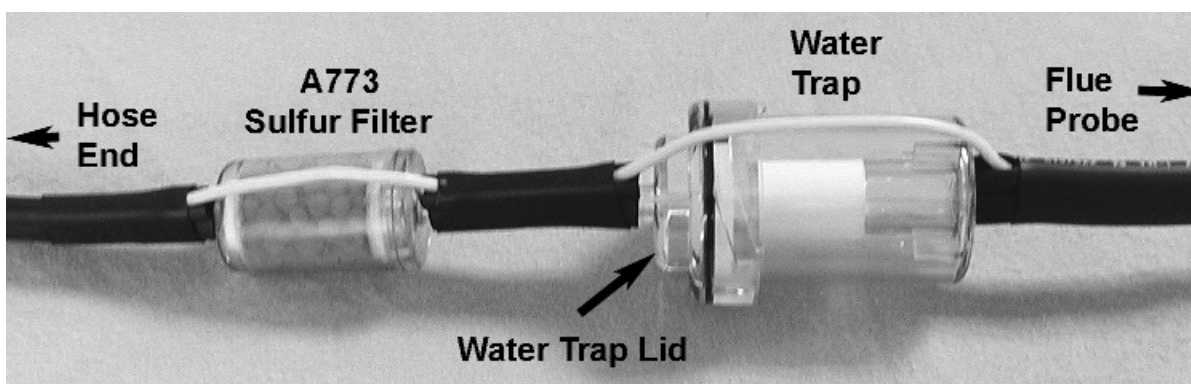

A773 SULFUR FILTER MAINTENANCE:

The A773 should be replaced when most of the pellets become discolored, usually white or black.

If the A773 begins to trap condensate and fill with water but the pellets are not discolored to the point replacement is required, it should be removed and allowed to dry. Once it is dry it can be reused.

Appendix C: ERROR CODES & TROUBLESHOOTING

The 717 analyzer will display certain codes to let you know of a malfunction.

Code Displayed	Code Definition	Possible Causes	Corrective Action
E01	Sensor not responding properly.	Something wrong in sensor circuit.	Return to TPI for service.
E02	Sensor is faulty.	Sensor is at the end of its life.	Replace sensors (see Appendix D for field replacing the sensors or return instrument to TPI for sensor replacement.
Flo Err	Pump not drawing sample at correct rate.	Water trap full. Blockage in flue probe or hose is kinked. Water trap particle filter saturated.. Low battery.	Empty water trap. Check for kinks and blockage in flue probe hose. Replace particle filter in water trap. Replace batteries.
Purg Err	There is 15ppm or more carbon monoxide remaining in the internal manifold.	When switching between functions the pump will shut off. This can trap CO in the internal manifold. When returning to analyzer mode this error will display if the trapped CO is 15ppm or more.	Allow the analyzer to run until the error is cleared.
Lo bat	Low battery.	Batteries needs to be changed.	Charge batteries. (See Appendix J.
oFL	Overflow indication. The pressure being measured is outside the maximum measurement capability.	Pressure being measured is too high or low. Pressure sensor damaged or defective.	Remove pressure source. Return to TPI for service.
oFL	Overflow indication. The temperature being measured is outside the maximum measurement capability.	Temperature being measured is too high or low.	Remove pressure source.
oPEn	Unable to read thermocouple (temperature).	Temperature probe not connected to input. Worn temperature sensor.	Connect temperature probe to analyzer. Replace temperature probe or flue probe.

*Sensor replacement requires calibration gas.

Appendix C: ERROR CODES & TROUBLESHOOTING (Continued)

Problem	Possible Cause	Corrective Action
Efficiency reading incorrect	<p>NET efficiency selected.</p> <p>Ambient temperature probe not plugged in to T2.</p> <p>Incorrect fuel selected.</p>	<p>Select GROSS efficiency. See page 17.</p> <p>Plug ambient probe into T2. See page 11.</p> <p>Select the proper fuel for the equipment being tested. See page 8.</p>
Readings are erratic when working on oil fired equipment.	A773 oil filter not installed or installed incorrectly.	Make sure the optional oil filter (A773) is installed. See Appendix B.
One or all of the following parameters; Ratio, CO air free, excess air, and efficiency read and print dashes.	Measured values are such that the calculated values of these parameters are out of range.	<p>Redo combustion test. Since these are calculated values, the measure values must be within certain levels for these to display. If the measured oxygen level is above 19.9% these parameters won't read.</p> <p>These parameters might not display or be applicable in some tests.</p>
Analyzer won't turn off	Oxygen and/or carbon monoxide levels outside limits.	Allow the analyzer to purge longer.

Appendix D: Field Sensor Replacement

The 717 uses field replaceable smart sensors. When you receive a sensor it will come pre-calibrated. Factory calibration once per year is still important to ensure your analyzer is functioning properly on all functions and ranges.

Contact your TPI distributor to purchase replacement sensors.

Note: You must wait 24 hours after sensor replacement before using your analyzer.

Follow these steps to replace the sensors:

1. Remove the protective rubber boot by using your hands to pry the boot from the bottom of the analyzer first. Once the bottom is free the boot can be removed.
2. Locate the screw that secures the sensor access panel to the back of the analyzer. The screw is located just above the battery access screw. (see picture below)



3. Loosen the screw and remove the access panel by lifting the end by the screw up first.

Appendix D: Field Sensor Replacement (continued)

- Once the access panel is removed you will have full access to the CO and O2 sensors. (see picture below)

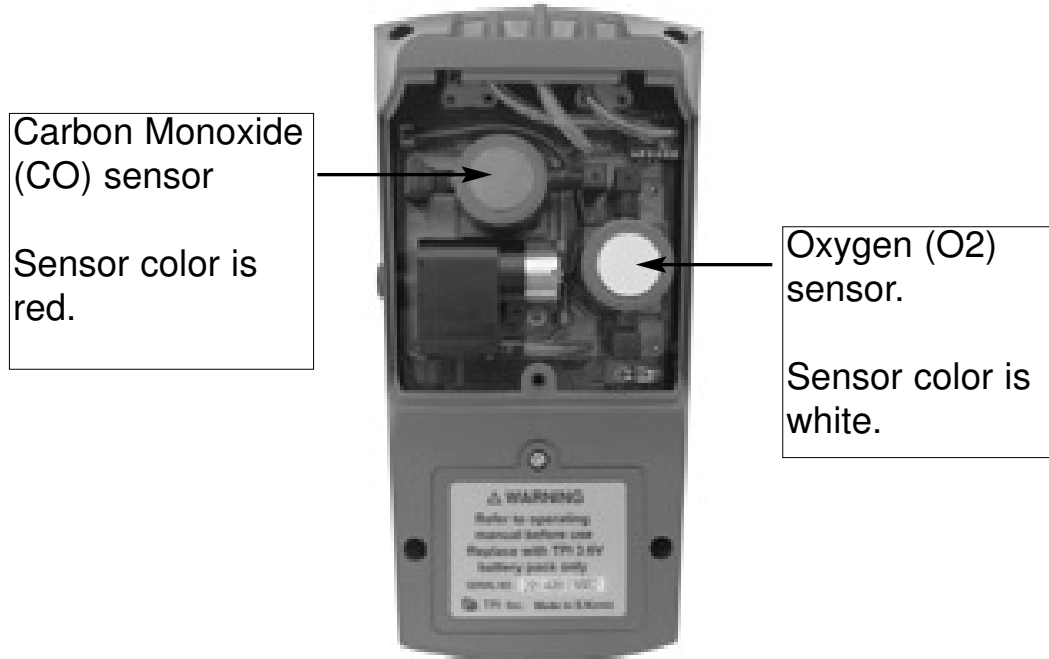

- To remove a sensor, pull the rubber hose off each side of the sensor. (see below)

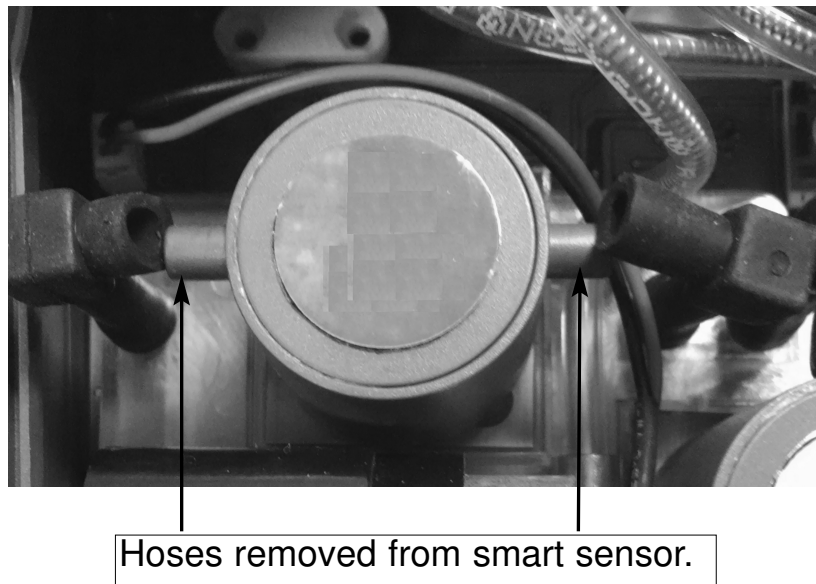

Appendix D: Field Sensor Replacement (continued)

6. Once the hoses are off the sensor, pull the sensor straight out of the holder (see below).

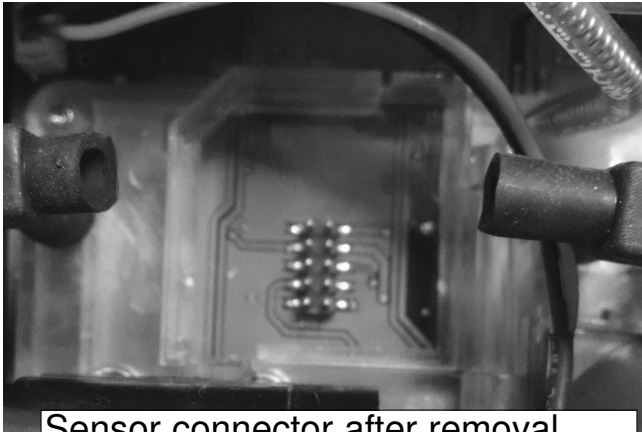

Sensor connector after removal



Smart Sensor

7. Install the new sensor into the holder by orienting the flat corner of the sensor with the flat corner of the sensor holder. Align the socket of the sensor with the pins on the main board and press the sensor down onto the pins and into the holder.

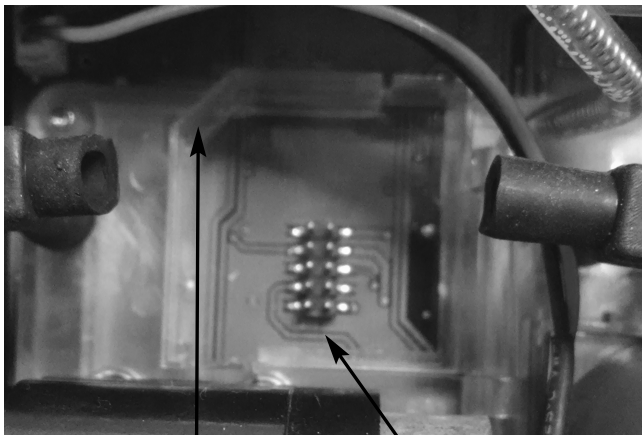

Flat corner of the sensor holder.

Pins on main board.

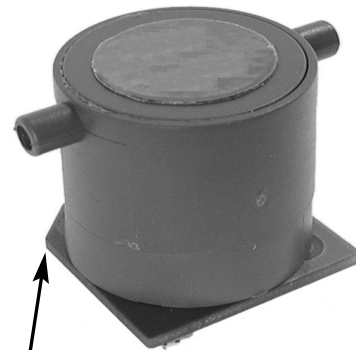

Flat corner on sensor.

Appendix D: Field Sensor Replacement (continued)

8. Connect the hoses to the sensor. (see picture below)

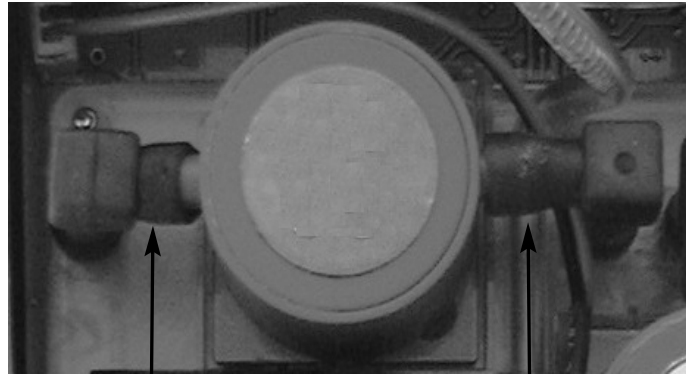

Hoses connected to smart sensor.

9. Repeat steps 5 through 8 for the remaining sensor.

10. Install the sensor back panel and re-install the analyzer into the boot.

10. Wait 24 hours prior to starting the analyzer. Make sure batteries are installed so the sensors are under power. During this time the 717 sensor calibration data will be transferred and the sensor will have power applied to enable it to acclimate.

NOTE: YOU MUST WAIT 24 HOURS AFTER SENSOR INSTALLATION BEFORE TURNING YOUR ANALYZER ON AND USING IT FOR THE FIRST TIME. FAILURE TO DO SO WILL RESULT IN AN ERROR CODE DISPLAYED AND THE ANALYZER WILL NOT FUNCTION PROPERLY.

NOTE: FACTORY CALIBRATION ONCE PER YEAR IS STILL RECOMMENDED TO ENSURE PROPER OPERATION AND ACCURACY OF ALL FUNCTIONS AND RANGES.

Appendix E: Technical Notes

Note 1: When performing a pressure or draft test during a combustion test, the pump can be turned on to provide a continuous sample to the sensors. This enables pressure adjustments to be made and the affect to the combustion process can be seen by returning to combustion analyzer mode. Use the FUNC Key to activate manometer mode. Press and hold the Up Arrow Key until the pump reactivates. Perform a pressure test and then use the FUNC key to activate combustion analyzer mode. Repeat this process until pressure adjustments are complete.

Note 2: Several factors affect combustion efficiency. Dirty or clogged air filters reduce the amount of air available for combustion therefore reducing efficiency. Obstructions in the flue block exhaust gases and alter the air mixture in the combustion chamber which reduces efficiency. Air leaks in the combustion chamber also alter the mixture causing decreased efficiency.

Note 3: The primary way to affect change in combustion efficiency when working with modern gas fired equipment is through gas manifold pressure adjustment. Confirm manifold pressures are within manufacturers specifications prior to performing a combustion test. Once manifold pressures are within limits a combustion test can be performed to provide information regarding any adjustments that may be needed.

Note 4: Gross efficiency calculation takes into account wet losses (latent heat) and is the unit of measure used in the USA. Net efficiency only takes into account dry losses (latent heat is not figured in) and is used in Europe.

Appendix F: Testing for Carbon Monoxide in Ambient Air

The 717 can be used to test for carbon monoxide in ambient air. For example tests can be performed in work spaces and living areas like offices and houses to ensure safety.

1. Following the steps outlined on page 8, turn the analyzer on in a clean air environment away from the area to be tested,
2. After the purge cycle is complete combustion display 1 will be seen. This is the default start up display and is the display to use when performing this test. Please see below.

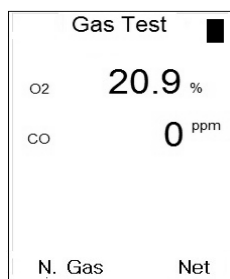

The middle display shows the carbon monoxide level.

For this test, ignore the top display (oxygen).

3. Connect the Mini Pump Protection filter to the analyzer. See picture below.



4. Begin testing for carbon monoxide. Move from space to space to detect any CO that may be present. The CO reading will be seen in the top part of the display.
5. If necessary, the flue probe can be attached to test in ducts and plenums.
6. Refer to the chart on page 45 for a list of exposure times and levels of carbon monoxide in ambient test applications
7. When testing is complete, turn the analyzer off as outlined on page 8.

Appendix G: Carbon Monoxide in Ambient Air Chart

This chart contains maximum exposure levels and times for carbon monoxide. This is a general guideline only. It is recommended you check with your local government for guidelines in your area.

Concentration of CO in the air	Toxic Symptoms
9ppm	The maximum allowable concentration for short time exposure in a living area according to ASHRAE.
35ppm	The maximum allowable concentration for continuous exposure in an 8 hour period according to OSHA.
200ppm	Maximum allowable concentration at any time according to OSHA. Slight headache, fatigue, dizziness and nausea after 2 to 3 hours exposure.
400ppm	Frontal headaches and other symptoms intensify after 1 to 2 hours exposure. Life threatening after 3 hours. Maximum allowable limit in flue gas according to EPA and AGA.
800ppm	Headache, dizziness, nausea, and convulsions within 45 minutes of exposure. Unconscious within 2 hours. Death within 2 to 3 hours.
1,600ppm	Headache, dizziness, and nausea within 20 minutes of exposure. Death within 1 hour.
3,200ppm	Headache, dizziness, and nausea within 5 to 10 minutes of exposure. Death within 30 minutes to 1 hour.
6,400ppm	Headache, dizziness, and nausea within 1 to 2 minutes of exposure. Death within 10 to 30 minutes.
12,800ppm	Death within 1 to 3 minutes.

Appendix H: CARBON MONOXIDE FACTS

Carbon Monoxide (CO) is invisible, odorless, and tasteless. It is the byproduct of combustion and levels are elevated when there is incomplete combustion.

Sources of CO include:

- Unvented kerosene and gas space heaters
- Leaking chimneys & furnaces
- Gas water heaters
- Back drafting from furnaces
- Wood stoves & fireplaces
- Gas Stoves
- Automobile exhaust
- Tobacco smoke

Carbon Monoxide is picked up quickly in the body by red blood cells. At high levels of CO the body replaces oxygen with carbon monoxide.

The most common symptoms of CO poisoning are headache, dizziness, weakness, nausea, vomiting, chest pain, and confusion. High levels of CO inhalation can cause loss of consciousness and death. Unless suspected, CO poisoning can be difficult to diagnose because the symptoms mimic other illnesses.

People who are sleeping or intoxicated can die from CO poisoning before ever experiencing symptoms.

Please see the next page for a list of exposure times and symptoms.

Appendix I: Battery Replacement

When the battery status indicator is empty the batteries should be changed immediately. For optimum performance replace the batteries with 3 AA size alkaline batteries. The procedure for replacing batteries is as follows:

1. Turn the analyzer over and locate the phillips head battery cover screw. See picture below.

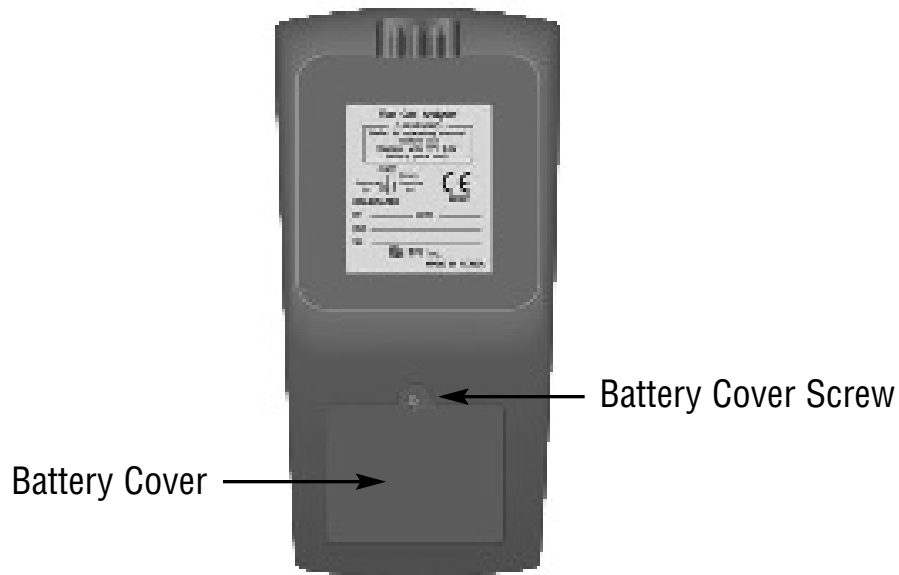

2. Loosen the screw. Pull out on the screw to remove the battery cover.
3. Remove the old batteries and observing the polarity markings in the battery compartment, install the new batteries.
4. Re-install the battery cover by fitting the bottom part in first.
5. Tighten the battery cover screw.

Notes:

Notes:



Call Us 1.877.571.7901

Test Products International, Inc.

9615 SW Allen Blvd., Ste. 104
Beaverton, OR 97005
Tel: 503-520-9197 Fax: 503-520-1225
www.tpi-thevalueleader.com

Test Products International, Ltd.

342 Bronte Road South, Unit #9
Milton Ontario Canada L9T5B7
Tel: 905-693-8558 Fax: 905-693-0888