



IMA-120 Matrix™

CLASSROOM AUDIO SYSTEM

INSTALLER AND OPERATIONS MANUAL



Amplifier
Audio Mixer
Infrared Microphone Receiver

notes

Date of Purchase: _____

Model Number: _____

Serial Number: _____

Notes:

THANK YOU



Congratulations on the purchase of your new TeachLogic system. You can be assured that this fulfills all specifications and was produced to very high quality control standards. TeachLogic incorporates the latest state of the art technology, employs the most advanced manufacturing methodology and uses only premium quality components to assure many years of reliable performance. We appreciate your confidence by your selection of our product. It is TeachLogic's intent to uphold that confidence by providing factory assistance and dealer support.

We hope you will take the time to review this manual to familiarize yourself with the product operation and features. This manual will help you learn to use and gain the maximum benefit of the system.

TeachLogic LLC
Longmont, Colorado, USA
teachlogic.com

contact

If you should encounter some unresolved issue, please contact TeachLogic customer service department for further assistance.

 1-760-631-7800
 support@teachlogic.com
 www.teachlogic.com

safety instructions



CAUTION



**RISK OF ELECTRIC SHOCK:
DO NOT OPEN**

Caution: To reduce the risk of electric shock DO NOT remove cover or back. No user serviceable parts inside. Refer servicing to qualified personnel.

certifications



TeachLogic systems are manufactured using lead-free processes and are free of materials harmful to the environment. They conform to the most stringent new European guidelines for consumer products (RoHS).

caution

Recycle—Do not dispose rechargeable batteries in trash. Actually it is unlawful to do so in CA, NY & ME.

Contact: Earth911.com
1-800-CLEANUP

Save our resources and don't contaminate.

Go Green

Read Instructions

All safety and operation instructions should be read before operating this TeachLogic product.

Retain Instructions

Safety and operating instructions should be kept for future reference.

Water & Moisture

This product should not be operated near water.

Heat Environment

Do not subject this product to excessive heat conditions.

Power Source

This product must be connected to an AC power source per the voltage input specified and marked on the power supply.

Power Cord Caution

Power cable should be routed clear of foot traffic and supported clear of kinking or abrasion.

Object Protection

Locate the operating unit so it will not be subjected to falling objects or water entry.

Internal Service

User should not attempt to service this product. All internal service must be accomplished by a qualified technician.

Electric Shock

Do not adapt or modify the AC power plug thus lifting the earth ground connection.

table of contents

About Infrared	6
System Overview	7
Wiring Diagram	8
Infrared Microphones	9-10
Components: Drop-in Charger BRC-60/Ceiling Sensor ICS-55	11
Installation of Ceiling Sensor	12
Installation of Ceiling Speakers	13-14
Installation of Wall Mount Speakers	15
Final Connection of Speakers	16
Page Mute/Pass Through	17
CPS-120/CPR-125 Remote Control Panel	18-19
RS-232 Features / RS-232 Codes	20
Bluetooth	21
Security Alert Feature	22
System Operation	23
Troubleshooting	24
Five Year Limited Warranty	25

a brief word about infrared

Infrared is a light ray that is below the visible spectrum, just like sound extends beyond your hearing ability. An example of infrared transmission is the remote control for your TV set. When a button is pressed, a beam of infrared light is emitted by a Light Emitting Diode (LED) from the remote control. It is detected by a receiving diode in your TV set.

When you press a certain command on your control, the internal electronics cause the infrared light to flicker in a programmed sequential pattern (called modulating the light beam). The modulated infrared beam is detected by the receiving diode and is electronically decoded. The decoded signal activates the circuitry to perform the command function on your TV set.

So how does this apply to the infrared communication system you are about to start using? The microphone/transmitter has several Light Emitting Diodes (LED) that emit infrared light beams to the sensor located in the corner of the room.

When you talk into the microphone, the microphone element modulates the light beam, causing it to flicker in sync with your speech. The sensor detects the sequential signal and the electronic circuitry in the amplifier converts that sequential signal into a line level analog audio signal. Now that audio signal can be fed into an amplifier. The amplifier magnifies the electronic signal and sends it to the speakers. This causes the speaker cone to move in sync with your voice. The speaker replicates your voice and disperses your voice evenly throughout the room.

IR transmission

The IR transmitter transmits directly to the sensor. However; due to the strength of the IR transmitter, the infrared signal will bounce off the walls, ceiling and floor for reception thus providing continuous connectivity throughout the room. Benefit: total freedom of movement within the room with no restriction of orientation.

“What’s said in the room, stays in the room”.

Infrared will not penetrate a solid surface thus preventing any transmission from going out of the room.

system overview

The Matrix is an amplifier, audio mixer, and infrared wireless microphone receiver in one. It is the hub of the classroom audio system as various media inputs can be connected to it, so that all classroom audio can be amplified and distributed clearly through the speakers. The addition of microphones provides voice reinforcement for the teacher and students alike.

The Matrix system is comprised of a microphone / transmitter, either the Sapphire (IRT-60), or Handheld (IRH-35) for voice transmission to a ceiling sensor (ICS-55) that sends the signal to the receiver / amplifier (IMA-120). The receiver/amplifier processes the signal and produces an analog signal of your voice for output to the sound field speaker system.

- | | |
|--------------------------------------|----------------------------|
| 1. Power on/off Indicator | 6. Line 1 Volume Control |
| 2. Page sensitivity control | 7. Line 2 Volume Control |
| 3. Bass/Treble equalizer ± 12 dB | 8. Line Out Volume Control |
| 4. CH 1 Mic Volume Control | 9. Line 1 Input (3.5mm) |
| 5. CH 2 Mic Volume Control | 10. Line 2 Input (3.5mm) |
| | 11. Line Output (3.5mm) |

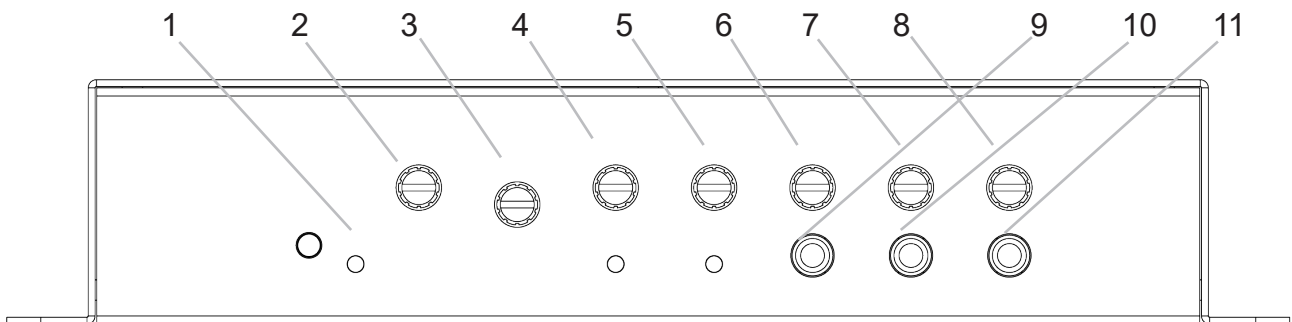

- | | |
|------------------------------|---|
| 12. Power Input: 19 VDC 3.4A | 17. Security Alert - Com N.O. N.C. |
| 13. RJ-45 Control Panel Jack | 18. Impedence selector 25V, 70V, 100V |
| 14. RS-232 Switch (Off/On) | 19. Page Mute Input - 2-pin Phoenix |
| 15. UPGRADE input Micro USB | 20. Speaker Output - Two Channel, 4-pin Phoenix connector |
| 16. Two Sensor Inputs (RCA) | |

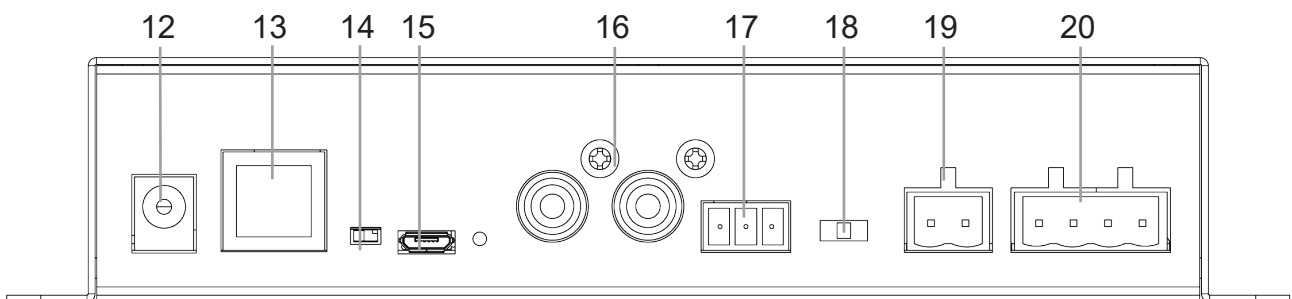

wiring diagram

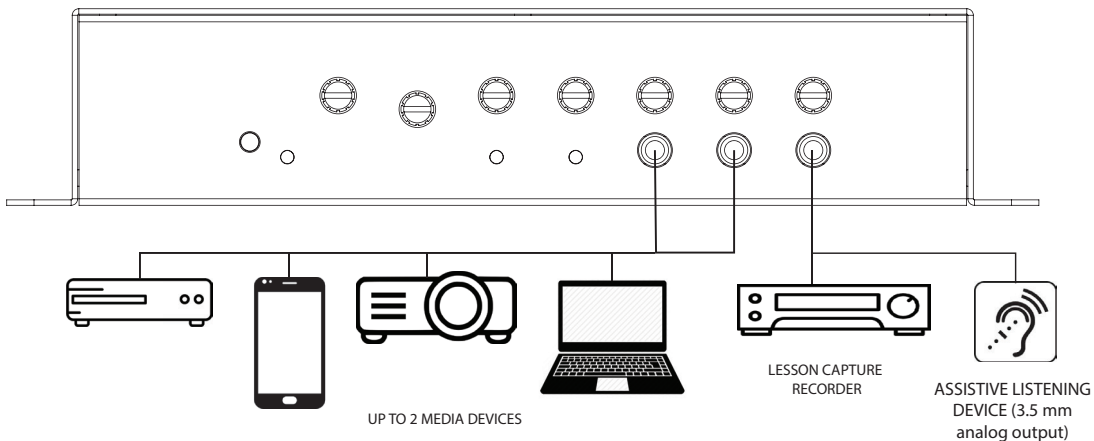
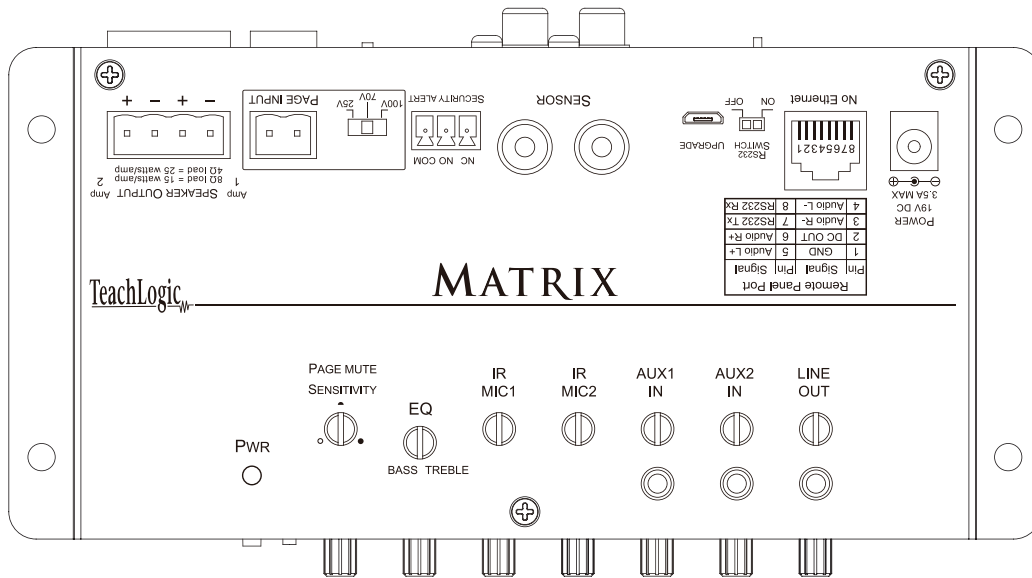
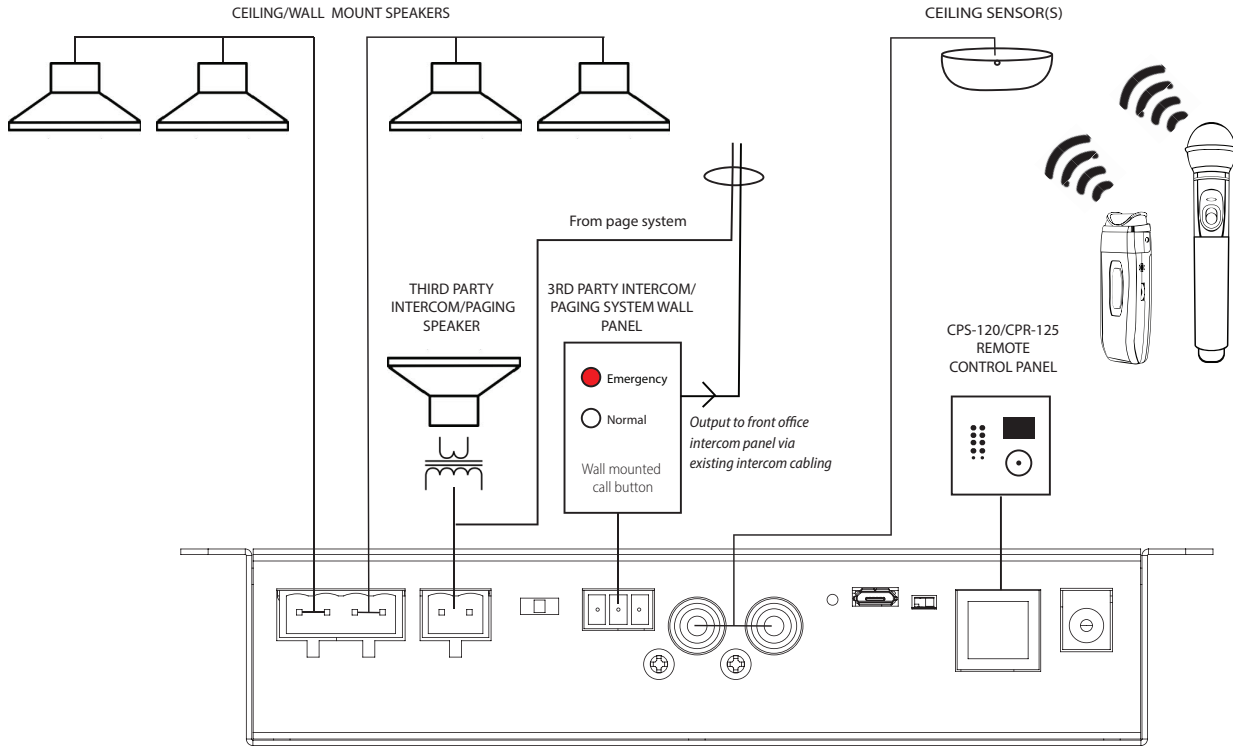

infrared microphones

The infrared microphone/transmitter is comprised of a microphone input, signal processing circuits and several emitting diodes that transmit the vocal signal to the sensor.

The microphone/transmitter can be the Sapphire or Handheld. The rechargeable batteries will provide 6–8 hours of service per charge. Place the microphone/transmitter in the charger for overnight charge and it will be ready for another day's use.

The drop-in battery chargers are specifically designed to recharge lithium & NiMH batteries at an optimum rate for Matrixum operating capacity and extended service life. Charger will automatically start charging the batteries upon insertion and will shift to a maintenance charge when batteries are fully charged.

features

- Elegant design
- Only 1.4 oz. including battery
- Long life Lithium Ion battery
- Rechargeable via USB cable
- Battery level indicator – Back light under power switch
- Momentary mute button, backlight blinks in mute mode
- Push “on/off” power
- Channel “A” or “B” selectable
- Three level microphone volume switch
- 3 voice sensitivity settings (Normal, -3dB, -6dB)
- Auxiliary input (3.5mm) for headset or music device
- Wear with a lanyard or slide directly on neckline collar



(IRT-60) sapphire transmitter

The Sapphire's vocal clarity is unsurpassed. Its high level output is achieved by the unidirectional (Cardioid) microphone and a unique free air suspension system. With a built-in breath filter, the Sapphire can function as a pass around hand mic.

The strategic alignment of the emitting diodes assures reliable connectivity throughout the room without static or drop out.

With a tap on the power button, the microphone is muted for private conversation—tap again to restore to normal operation. The auxiliary input allows wireless playback of your personal music device through the Sapphire. A three position slide switch provides selection of normal, medium (-3 dB), or low (-6 dB) microphone sensitivity.



infrared microphones



IRT-60 remote control features

1. Moving the priority switch Up/Down will control the volume of the line inputs.
2. A momentary tap of the priority switch will duck down the line inputs 15dB. The receiver front panel power switch changes to a blinking PURPLE. A second tap will restore line input back to normal.
3. Hold in priority switch for 4 seconds closes the contact closure on the Security Alert output. The receivers front panel power switch changes to blinking GREEN. Holding the button down for another 4 sec. returns the contact to normal.

features

- Condenser microphone element
- Power “on/off” switch
- Battery level indicator—LED
- Channel “A” or “B” selectable
- 10 high-power emitting diodes
- Diodes at top and bottom of handle for increased Coverage (2 Top aimed out, 6 Bottom 360°, 2 Bottom aimed down)
- 360° IR radiation for assured connectivity
- Two “AA”, Duracell, rechargeable NiMH batteries



IRH-35 handheld transmitter

The Handheld Microphone Transmitter (IRH-35) is most applicable for student use or direct presentation. It has an “on/off” switch and a battery level indicator LED; Green=useable charge, Red=low battery. The transmitter has 10 emitting diodes: 8 around the bottom of the handle, and 2 toward the top of the handle. The metal housing provides low handling noise and insures durable longevity.

components

BRC-60 drop-in battery charger

This stylish desktop drop-in charging station makes it convenient and easy to recharge both Sapphire Pendant and Handheld Microphones. Charge one IRH-35 handheld transmitter and up to two IRT-60 Sapphire transmitters simultaneously. Charging indicator lights illuminate Red when charging, and Green when fully charged. The power LED illuminates Blue when plugged in.



ICS-55 ceiling sensor

The ceiling sensor is the preferred infrared sensor for optimum performance. This is the unit that needs to be installed on the ceiling. It comes with a mounting/support bracket and 50 feet of plenum rated cable with RCA connector on each end. The ideal location for the dome sensor would be in the center of the ceiling. This will provide a clear signal path for the IR transmission from the transmitter to the dome sensor without obstruction. In addition, you will have 360° coverage and will minimize the transmission distance for more reliable performance. It collects the infrared transmission signal via 6 large detecting diodes.

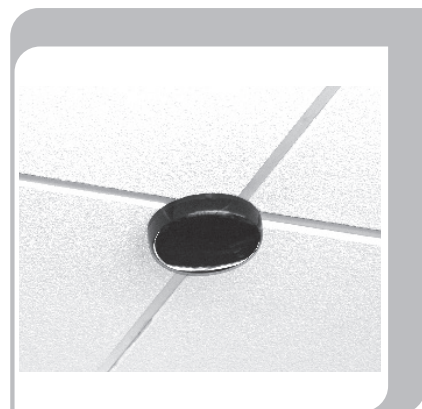

power "on" LED

Green light indicates that the sensor is receiving power from the receiver.

sensor cable

A cable connects the sensor to the receiver. The cable is dual-shielded with a male RCA connector on each end and is plenum rated.



ceiling sensor installation

The ideal location for the ceiling sensor is in the center of the ceiling. This will provide a clear signal path for the IR transmission from the transmitter to the dome sensor without obstruction. In addition, you will have 360° coverage and will minimize the transmission distance for more reliable performance.

Installation 1 - Attach to T-bar Rail

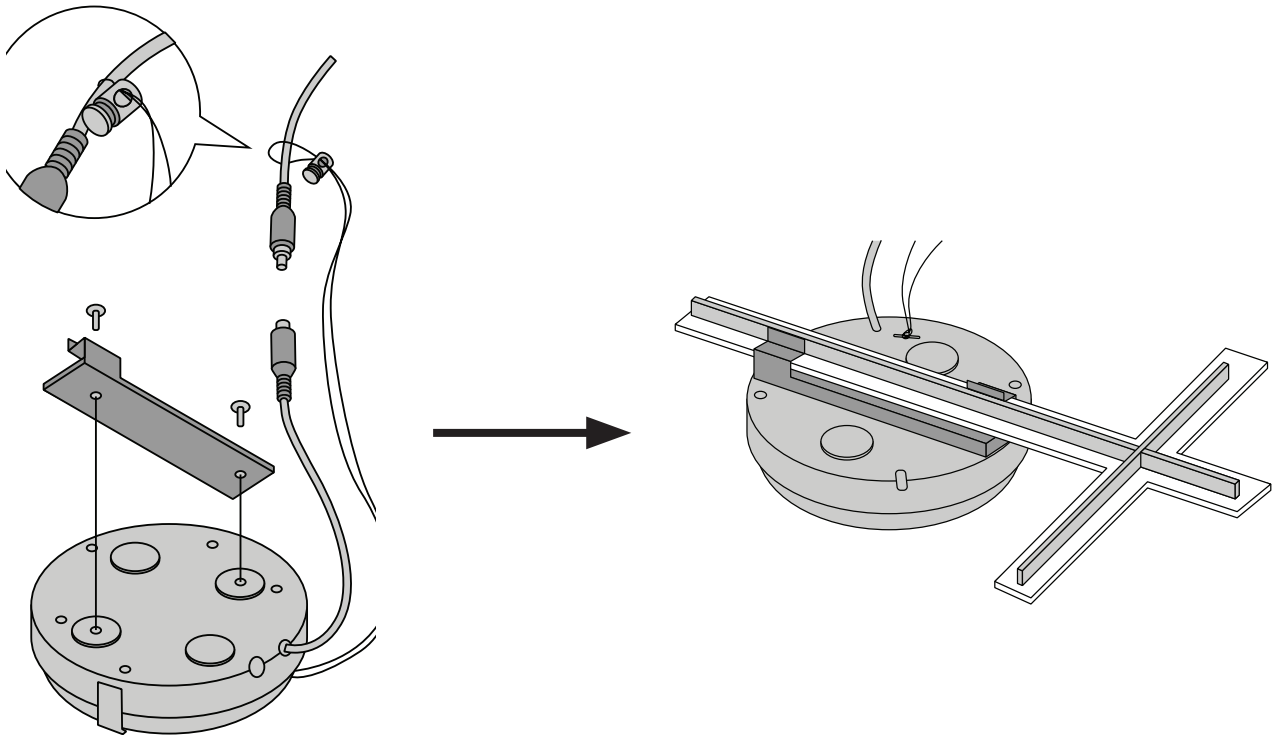

Installation 2 - Attach to wood surface

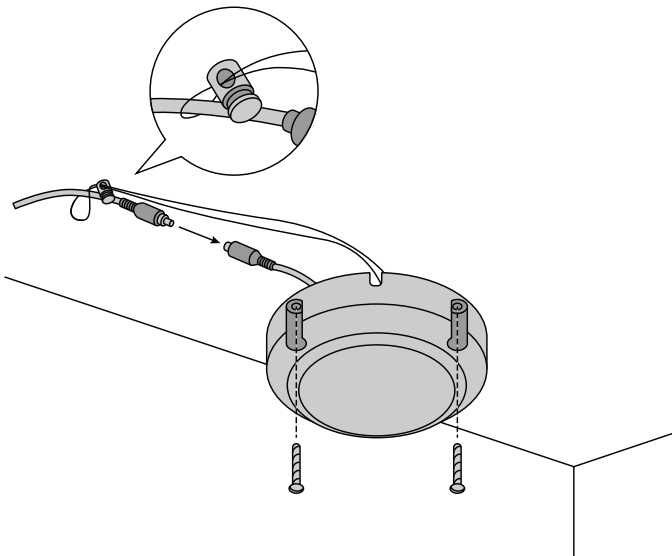

Installation 3 - Attach to drywall or concrete surface

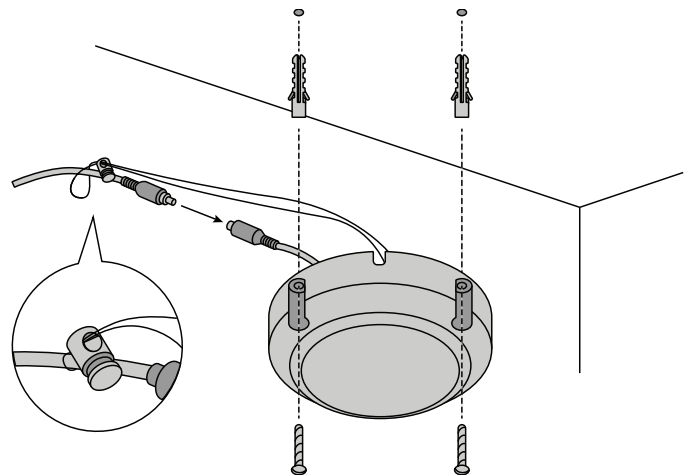

speaker installation

installing planning

- **Amplifier/Receiver:** Choose location based on accessibility requirements and wiring constraints for power, speakers, and audio devices.
- **Ceiling Sensor:** Locate in the center of the ceiling; maintain line of sight; keep away from direct light and electrical interference.
- **Speakers:** Mark location for wall mount vs. ceiling mount, and confirm wiring run to the amplifier. Ensure speakers evenly cover the listening area.
- **Integrations/Connections:** Confirm location of other systems you plan to connect to the amplifier such as audio devices, intercom connections, fire alarm, noting how the wiring needs to run.
- **Microphones/Charger:** Confirm microphone charging location for daily use/charging.

The IMA-120 has two channels of amplified audio, rated for a minimum 4-ohm speaker load (two 8-ohm speakers each). There is one blue phoenix style speaker connector on the back panel, providing one pair of speaker terminals. When using 4 speakers they must be wired in parallel.

ceiling speaker installation

1. Determine the listening area based on where students are seated.
2. Divide listening area into quadrants.
3. Locate and identify the center most tile in each quadrant to ensure even distribution of sound.

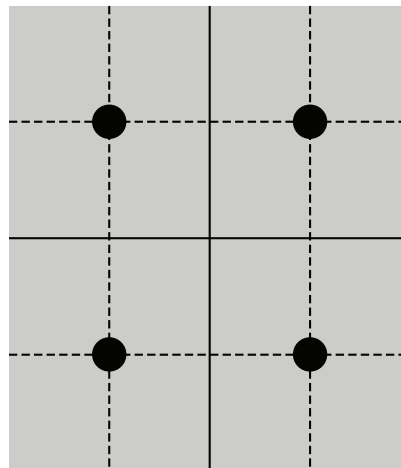
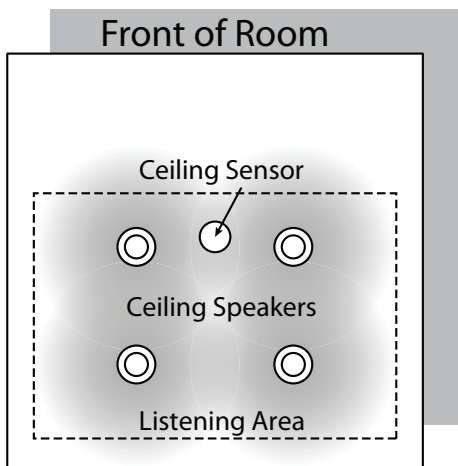

SP-628

4. Lay ceiling tile face down on clean flat surface.
5. Lay tile bridge on ceiling tile and center it.
6. Trace and cut the large hole using a keyhole or drywall saw.

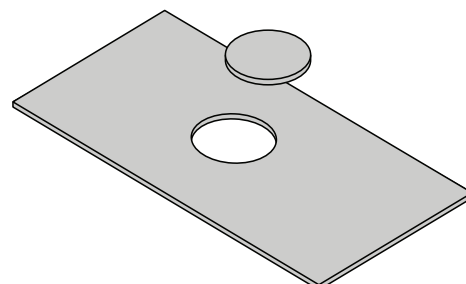
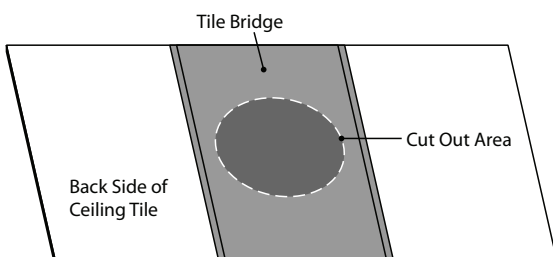

speaker installation

7. Strip the speaker cable ends, approx. ½".
8. Route speaker wire from speaker opening to amplifier.
9. Reinstall ceiling tile with tile bridge in place above the hole.
10. Pull speaker cable back down through speaker hole.
11. With a pointed tool or paper clip, lift up and remove speaker grill and set aside to avoid damage
12. Set speaker on top of ladder and connect speaker wire.
13. Observe speaker polarity, connect Red wire to (+) terminal and black wire to the (C) terminal.
14. For locations where earthquake or a safety restraint is required, make the attachment to the speaker and ensure it's secure.
15. With the mounting clamps folded back, position speaker into speaker hole.
16. With a #2 Phillips screwdriver, tighten the quick clamps.

Mounting Screws

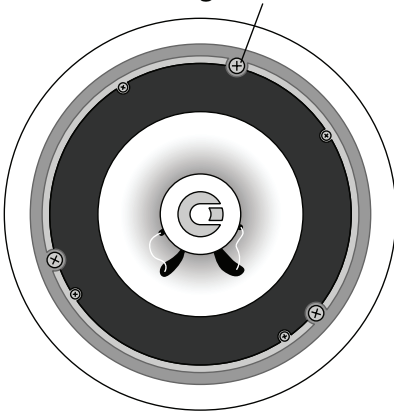

16. Reinstall speaker grille and remove any soil or fingerprints.
17. Repeat steps 7-16 for other speakers.
18. See "final connection" section to finish installation.

SP-628L

1. Lay ceiling tile face down on clean flat surface.
2. Lay the SP-628L on the tile with flat end (the opposite end of the integrated T-bar) flush with the end of the tile.
3. Mark opposite end where you will make the cut. Mark the two opposite ends of the tile.
4. Take care to mark where the SP-628L integrated T-bar connects to the assembly.
5. Connect the marks with a level or flat object to ensure you draw a straight line across the tile.
6. Cut the tile using a drywall saw.
7. Set speaker on top of ladder and connect speaker wire.
8. Place speaker in the ceiling ensuring it's secure.
9. For locations where earthquake or a safety restraint is required, make the attachment to the speaker and ensure it's secure.
10. Replace ceiling tile.
11. See "final connection" section to finish installation.

speaker installation

installing SP-2000 wall mount speakers

1. First observe the shape of the room: ceiling height, door locations, windows, mounting surface, and seating area.
2. Ordinary installation would be to locate the speakers on each side wall approximately even with the front row of listeners.
3. It is recommended to mount the speakers a minimum of 6 feet above the floor.
Note: In a room with 10' ceilings, a mounting height of 9.5' is ideal.

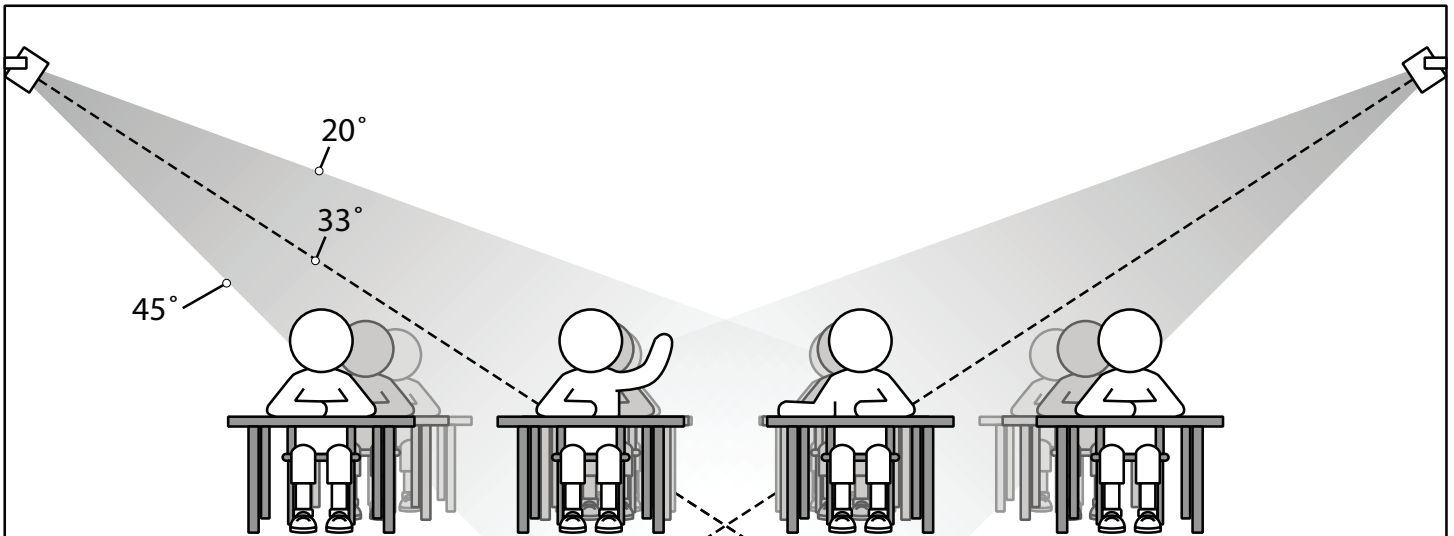

4. Install the mounting brackets on wall in the vertical (up/down) orientation.
5. Mount brackets using the appropriate hardware
6. Insert speaker with the tweeter in upper position.
7. Secure speaker in bracket with the hand fasteners.
8. Orient each speaker toward the center of that half of the listening area and tighten fasteners.

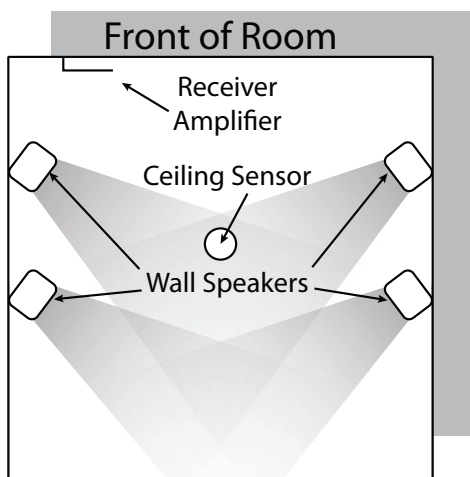

9. Strip speaker cable ends $\frac{1}{2}$ " and connect to speaker.
10. Observe speaker polarity: Connect (+) wire (with printed writing) to (+) terminal and (-) wire (unprinted & textured) to the (-) terminal.
11. Route speaker cable to the receiver/amplifier in a safe, least visible, tidy manner.
12. See "final connection" section to finish installation.

speaker installation

final connection of the system

With receiver/amplifier located, speaker and sensor cables neatly routed, we are ready to complete the installation.

1. Cut the speaker wire to the appropriate length
2. Strip about $\frac{3}{8}$ " off the end of each speaker wire.
3. Twist the wire and if you have a soldering iron, tin the wire ends
4. Unplug the phoenix connector from amplifier. Reference amplifier insert diagram on amplifier (Figure H) (+) wire (with printed writing) into either outside (+) terminal.
5. Plug the other (-) wire into center (-).

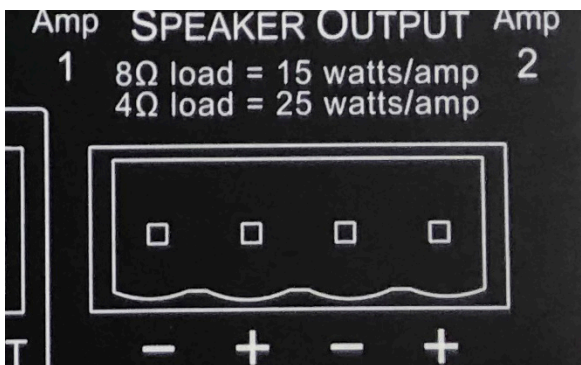

Figure H
Speaker Output Phoenix Connector

5. Tighten set screws.
6. Repeat for other pair and insert plug firmly into speaker output receptacle.
7. Plug amplifier power supply into AC outlet.
8. Connect audio sources and set output to desired levels.

page mute/pass through

The Page Mute feature allows you to connect the TeachLogic amplifier to the school paging/intercom system for muting purposes. A simple connection between the in-classroom paging speaker (typically 25v, 70v or 100v) and the TeachLogic page input will mute all the inputs and pass the page to the speakers connected to the TeachLogic amplifier. System resumes audio (slowly ramping up volume) 6 seconds after no additional page signal is detected.

KEY SPECS (based on 25 V paging systems)

- Page signal required to activate mute function: 6.0 V
- The impedance of the IMA-120 is 160 Kohms in the 25V switch position, and 180 Kohms in the 75 and 100V switch positions.
- Power draw = 0.004 Watts or less (power = voltage*voltage/impedance, or $25*25/160,000$).

CONNECTION

1. Tap/Splice page speaker's wire and connect to our amp via 2-pin Phoenix connector.
2. Determine the signal level of the paging system (25v, 70v, or 100v) and set the slide switch to the appropriate speaker level setting.

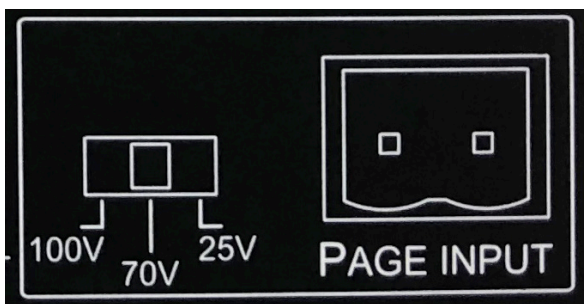

Figure I: impedance selector / page input Phoenix Connector

3. With the TeachLogic amplifier turned ON, send a page signal through the page input.
4. Adjust the page input SENSITIVITY control, located on front panel, so that an incoming page/intercom signal will override any audio (mics, line, etc) plugged into the TeachLogic amplifier.

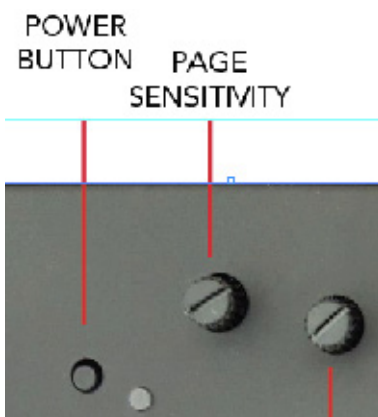

Figure J: page sensitivity control

PASS-THRU FUNCTION

The amplifier will pass the paging audio through the classroom audio speaker(s) connected to it. Note that you may use the classroom audio system speakers in addition to or in lieu of dedicated paging speaker.*

* IMA-120 Matrix only passes page audio through speakers when the amplifier is powered.

remote control of audio inputs

CPS-120/CPR-125 controller

Audio levels very often need to be adjusted when switching from computer audio to DVD players and other audio sources.

Such operations as level UP, DOWN and MUTE are easily accomplished via the eight button controller and touch rotary dial, as shown here. This allows the receiver/amplifier to be placed in an area or compartment that is not easily assessed by the user.

No set up is required for these touch panels to operate. They are preprogrammed right out of the box.



CPR-125

The CPR-125 has an additional RJ-45 connection to connect to an intercom system. This collocates the audio controls with the wall-mounted paging buttons into one convenient panel.



IMPORTANT

When any remote panel is connected, RS-232 switch must be in "ON" position.

When panel is not connected, RS-232 switch must be in "OFF" position for amplifier controls to function.

remote control of audio inputs

CPS-120/CPR-125 panel operation

1. Connect cable between amplifier RJ-45 and remote touch panel RJ-45. Please note that the the CAT5 cable between Matrix and controller should be no more than 50 ft (15 m).
2. Place RS-232 switch in the "ON" position to activate touch panel.
3. When wall plate power is on, the LCD screen will illuminate the **TeachLogic** logo.
4. The LCD screen will illuminate in two brightness levels, DIM (power save mode) and ON (full brightness).
5. To activate the screen press any button to turn the screen ON.
6. When the LCD screen light is ON, you can press any of the eight available input source buttons to adjust the volume.

volume control

EXAMPLE:

Aux input volume adjust:

****Please note that you can only adjust the volumes when the screen light is ON****

1. Depress AUX button on touch control panel. The AUX and level indicator will appear in the LCD window.



2. Touch the rotary control in a clock wise direction to increase volume.

Volume Up



3. Touch the rotary control in a counter clock wise direction to decrease volume.

Volume Down

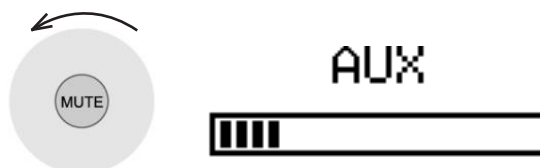

4. MUTE control: Press the "MUTE" button - The screen indicates "AUX MUTE" and starts to blink. Press the "MUTE" button again to return to the present volume.

remote control of audio inputs: RS-232

RS-232

The IMA-120 Matrix can accommodate 3rd party remote control panels that connect via RJ-45. Follow the pin out diagram and Hex code chart to ensure your control panel is wired and programmed properly.

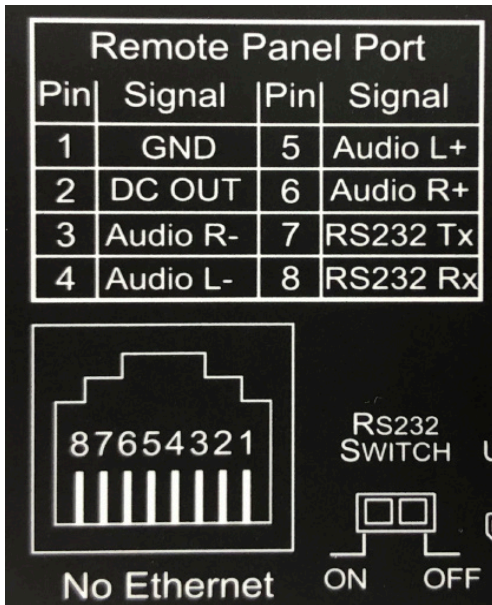

IMPORTANT

When any remote panel is connected, RS-232 switch must be in "ON" position.

When panel is not connected, RS-232 switch must be in "OFF" position for amplifier controls to function.

RS-232 codes

Visit this page for latest RS-232 information:
<http://teachlogic.com/rs232/>

Pairing a Bluetooth mobile device to CPS-120 or CPR-125 Touch Panel

This display means the Bluetooth device is not powered.

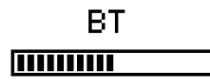

1. Press and hold "BT" source button for 3 seconds to power the Bluetooth on.



This display means the touch panel is ready to pair with your Bluetooth device.



2. Search Bluetooth setting on your mobile device for "TeachLogic".

Each Touch Panel has a unique Serial Number on the panel display.

Look for SN:TeachLogic-00000XXX and pair that number with your device.

This display indicates that your mobile device and Touch Panel are in the pairing process.



This display indicated your device and the Touch Panel are paired.



****Please note that your device will also control the volume.****

Bluetooth will automatically power off if no signal is received after about 10 min.

To connect a different Bluetooth device, hold "BT" source button for 3 seconds and all "BT" action will be stopped.



After completing this step, another mobile Bluetooth device can be connected to the TeachLogic CPS-120 or CPR-125 touch panel.

security alert

security alert features



SYSTEM BEHAVIOR

When the Saphire's "Priority" button is pushed/held for 5 seconds, it sends a signal to the ceiling sensor which passes through the amp to the security alert interface (an electric relay). The relay contacts opens or close (depending on the normal status) to pass the signal through the paging system as if the paging system's wall-mounted button was being pressed. The amplifier functions normally during the alert, e.g. there is no change to audio input/output volume change nor does the system produce any sound

KEY SPECS

- Contact closure, normally open or closed.
- Field programable for 1-pulse and 4-pulse systems
- Amplifier power LED blinks green when the alert is received
- Functions on primary teacher microphone (Channel A) in each room.

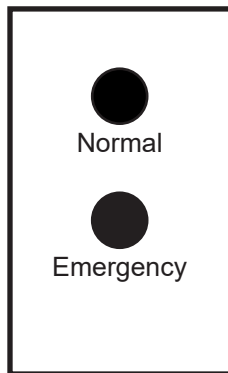

CONNECTION

Uses wire from paging manufacturer's wall-mounted call button panel to connect to amplifier via 3-pin Phoenix connector: COM | NORMALLY OPEN | NORMALLY CLOSED.

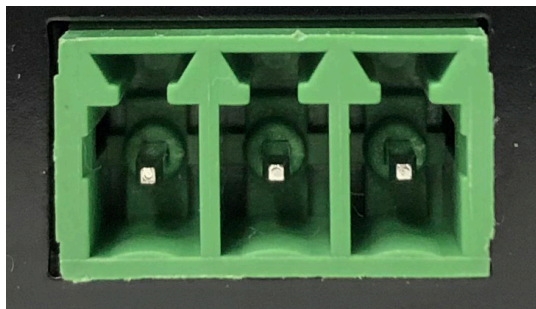

system operation

Now that the system is installed and connected, we are ready to plug it in and test its performance. The testing will be done using an IR transmitter (Sapphire or Handheld) to confirm good connectivity and quality audio.

system operation

It is best to have a second person help you set the gain levels for the audio sources as the teacher does not need to hear his/her own voice or audio for it to be working properly.

1. Plug in the Matrix. Note that the power is always on.
2. Confirm power to sensor by verifying the Green LED on edge of sensor is illuminated.
3. Set volume of Ch A volume control to mid scale (12 o'clock).
4. Set volume control on side of Sapphire transmitter to "Normal" level.
5. Switch on by pressing and holding "TL" button until it lights up.
6. Observe that the "TL" LED is solid blue, which indicates it is transmitting.
7. Have another person sit/stand under or in front of a speaker.
8. Slowly adjust "Ch A" volume on Matrix while talking into microphone.
9. Adjust to desired listening level.

CAUTION: Beware of feedback. If feedback occurs, dial down gain control until it goes away.

10. Walk around the room while talking into microphone to confirm good connectivity.
11. Test the mute function by briefly pressing the Sapphire "TL" power button once (flashing blue).
12. Briefly press power button again. The light should return to solid blue.
13. Upon completion of performance test, the installation is complete.

CHANGING MICROPHONE CHANNELS

If you're using 2 Sapphire microphones in a single room, you'll need to change one to channel "B" (All Sapphire mics are shipped in channel A). Handheld microphones are always shipped in channel "B" setting.

Sapphire: There is an "A-B" switch in the battery compartment. Remove battery cover on back, lift up battery and locate the switch. Make the change.

Handheld: Unscrew barrel and remove. Note "A-B" switch on side of battery holder. Make the change.

SAPPHIRE "TL" POWER BUTTON LED LIGHT STATUS

- Solid Red: OFF
- Solid Blue: ON
- Solid Purple: External devices quieted
- Solid Red: Battery is low
- Solid Green: Occurs when charging. Indicates battery is charged.
- Flashing Blue: Microphone muted

basic troubleshooting

Problem	Solution
Amplifier controls not functioning	Turn RS-232 switch to "off" position. Reference RS-232 part of manual
System is turned "on" but there is no sound	Verify AC power; the Blue LED lights when turned "on" Check if system has been unplugged Check circuit breaker Call maintenance for assistance
System has power but no sound	Turn "on" microphone/ transmitter and ensure the "TL" is solid blue. If different color, then needs to be charged or a new battery if it's not holding a charge. Check for IR transmission. If the amplifier is receiving a signal presence the mic channel indicator will be illuminated Orange. Ensure the Green LED on the ceiling sensor is illuminated. If sensor LED is not lit; sensor has been disconnected or power output to sensor has failed (Receiver/ amplifier needs to be replaced)
Voice is distorted and/or signal drop-out occurs	Check the charge on your batteries. Verify that the diodes on transmitter or sensor are not being covered or that there is no obstruction between transmitter and sensor .

contact

If your problem persists and this guide has not resolved the issue, contact customer service for additional assistance.
(760) 631-7800
support@teachlogic.com

warranty

Please refer to www.teachlogic.com/warranty



☎ 1-760-631-7800

✉ support@teachlogic.com

🌐 teachlogic.com