

USB2.0 HD Video Camera

User Manual

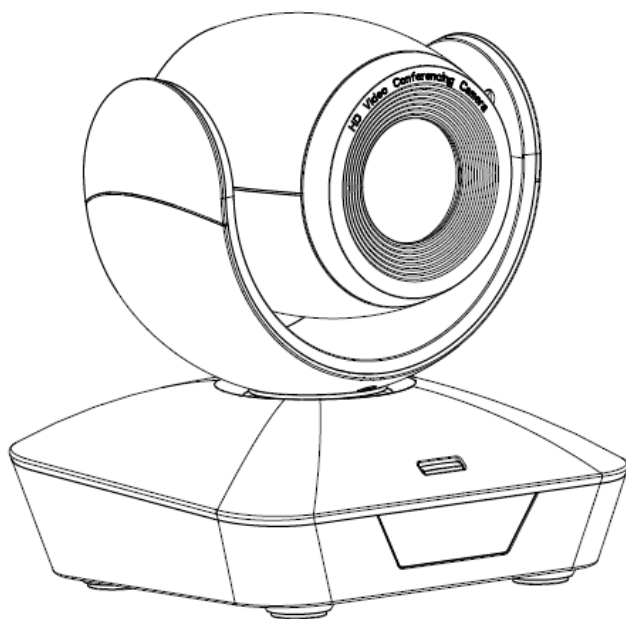

Version V1.0
(English)

CONTENTS

SAFE GUIDES.....	4
ACCESSORIES.....	4
QUICK START.....	5
PRODUCT HIGHLIGHTS.....	6
PRODUCT SPEC.....	7
CAMERA INTERFACE.....	8
CAMERA DIMENSION.....	8
IR REMOTE CONTROLLER.....	9
VISCA IN(RS232) PORT.....	10
VISCA PROTOCOL.....	11
IR TRANSFER(IR PASS).....	17
UVC CONTROL.....	17

SAFETY GUIDES

1. Before operation, please fully read and follow all instructions in the manual. For your safety, always keep this manual with the camera.
2. The camera power input range is 100-240VAC(50-60Hz), ensure the power supply input within this rate before powering on.
3. The camera power voltage is 12VDC, rated current is 1.5A. We suggest you use it with the original power supply adapter supplied by the factory.
4. Please keep the power cable, video cable and control cable in a safe place. Protect all cables especially the connectors.
5. Operational environment: 0°C-50°C, humidity less than 90%. To avoid any danger, do not put anything inside the camera, and keep away from the corrosive liquid.
6. Avoid stress, vibration and damp during transportation, storage and installation.
7. Do not detach the camera housing and cover. For any service, please contact authorized technicians.
8. RF cable and control cable should be individually shielded, and cannot be substituted with other cables. Do not direct the camera lens towards strong light, such as the sun or the intensive light.
9. Use a dry and soft cloth to clean the camera housing. Applied with neutral cleaning agent when there is need to clean. To avoid damage on the camera lens, never use strong or abrasive cleaning agents on the camera housing.
10. Do not move the camera by holding the camera head. To avoid mechanical trouble, do not rotate the camera head by hand.
11. Put the camera on fixed and smooth desk or platform, avoid leaned installation.
12. Power Supply Polarity(Drawing)

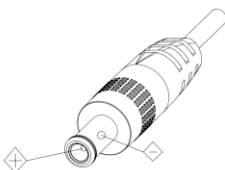

ACCESSORIES

Check all bellow items when open the package:

Camera	1
Power Adapter	1
Power Cable	1
RS232 Control Cable	1
USB2.0 Cable.....	1
Remote Controller	1
User Manual	1
Double-sided Adhesive.....	1

QUICK START

1. Check all cable connections before power on.

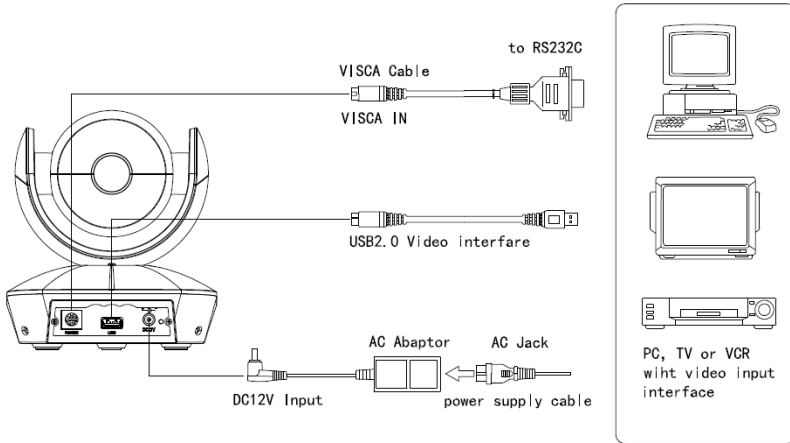

2. DIP Switch Setting (at the bottom of the camera):

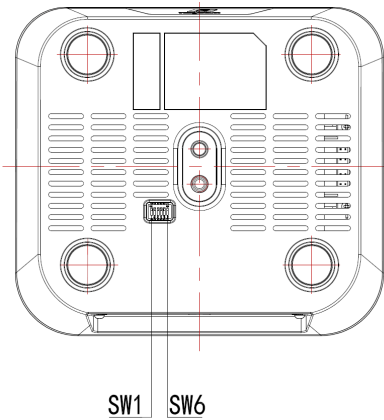

Function (ARM)			
	SW-1	SW-2	Instruction
1	OFF	OFF	Updating mode
2	ON	OFF	Debugging mode
3	OFF	ON	Undefined
4	ON	ON	Working mode

Function (IR CODE TYPE)			
	SW-3	SW-4	Instruction
1	OFF	OFF	Off(Close IR receiver)
2	ON	OFF	Undefined
3	OFF	ON	SEJIN 4PPM CODE
4	ON	ON	NEC CODE(standard)

Function (USB)			
	SW-5	SW-6	Instruction
1	OFF	OFF	Undefined
2	ON	OFF	Working mode
3	OFF	ON	Updating mode
4	ON	ON	Undefined

PRODUCT HIGHLIGHTS

- Smart and fashion design, ideal for cloud-based conferencing
- Adopts advanced Ambarella DSP, 1/2.8 inch 5MP image sensor, and high quality 10X 62.5degree FOV optical lens, provides fluent and crystal image quality
- Fast switching between different video formats: less than 1 second
- 10X Optical Zoom + 12XDigital Zoom
- Fast and accurate focus performance
- Easy firmware upgrade-(field-upgradable)
- USB2.0 high speed output
- Effective RS232/485 serial control
- Up to 128 presets
- Compatible with the majority of videoconferencing software (UVC1.5 protocol standard)
- With powerful functional remote controller
- IR transfer/IR pass function: except receiving the camera remote controller signal, the camera can also receive other codec's IR remote control signal, and pass these IR control signal to the codec's IR receiver (via VISCA IN port).

PRODUCT SPEC

Video Format	MJPG	1080P30, 720P30, 640*480P30
Video Port	USB2.0	
Sensor	1/2.8 inch high quality 5MP CMOS sensor	
Lens	F4.7~47mm(10X), F1.8 – 14, Field of view: 62.5°(wide)-6.43°(tele)	
Pan/tilt Rotation	Pan:±170°; Tilt:-30°~+90°, support up-side down installation	
Pan/tilt Speed	Pan: 0.1°-120°/s; Tilt: 0.1°-80°/s	
Preset	10 via IR remote setting, 128 via VISCA control, preset accuracy :0.1°	
Control Port	RS232, RS485, USB2.0	
Min. Lux	0.01lux	
White Balance	Auto/Manual	
Focus	Auto/Manual	
Iris	Auto/Manual	
Shutter	Auto/Manual	
WDR	Supported	
BLC	Supported	
2D Noise Reduction	Supported	
3D Noise Reduction	Supported	
Input Voltage	DC12V	
Dimension	148mm×132mm×161mm	
Net weight	0.9KG (2LBS)	

CAMERA INTERFACE

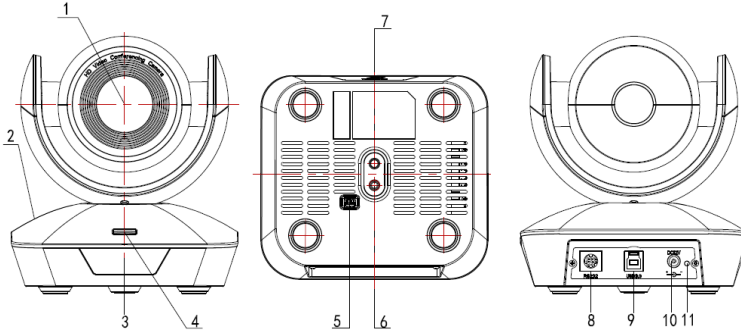

- 1.Camera Lens
- 2.Camera Base
- 3.IR Receiver Panel
- 4.Indicator Light
- 5.Dial Switch
- 6. Tripod Screw Hole
- 7.Installation Hole
- 8.RS232(VISCA IN) Port
- 9.USB2.0 Port
- 10.DC12V Power Input
- 11.Power Indicator light (red)

CAMERA DIMENSION(MM)

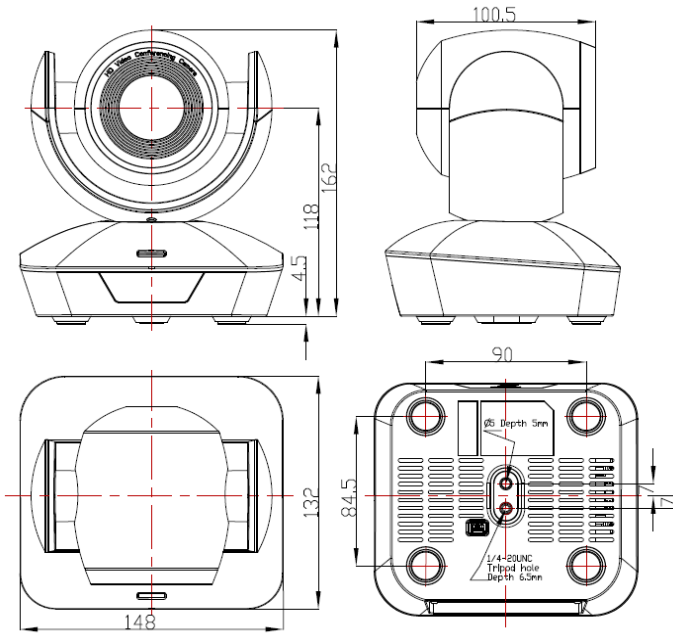

IR REMOTE CONTROLLER

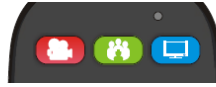

LED Function Instruction

Press any button and shows in red color: Current selection is to control the camera;
Press any button and shows in green color: Current selection is to control the codec;
Press any button and shows in blue color: Current selection is to control the TV;

Power button

Red button: in normal work mode, short press one time, camera will enter standby mode; short press again, the camera will start self-configuration and go to HOME position; it will go to No.0 preset position if that was set;

Green button: Codec power button(need to learn the button coding);

Blue button: TV power button(need to learn the button coding);

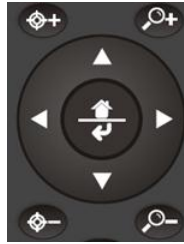

Focus (Left): +/-

Manual focus, only valid under manual focus model;

Zoom (Right): +/-

Control the lens zoom rate;

Navigate : Up/Down/Left/Right

In normal working mode, use navigate key to control pan/tilt;

Confirm/Home button:

In normal working mode, short press to let the camera go back to Home position.



Menu button: show the camera version

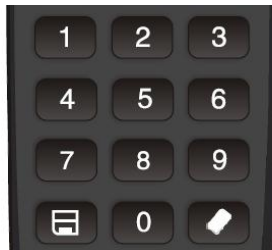

Number buttons

Set Preset: Long press(3seconds) the number button to save preset;

Clear Preset: Clear+number button to clear the relative preset;

Long press(3seconds) the Clear button to clear all preset;

Run Preset: Short press the number button to run the relative preset.

LEARNING FUNCTION:

1. Press the green button, the LED indicator light will show in green color for 1 second, means switch to video terminal/codec control mode;
2. **Single Button Coding:** long press(3seconds) Home +number"1" button simultaneously, the green indicator LED will light, enter button learning mode, press the buttons which need to be learned, LED will start flickering(1HZ), now can start button learning: get the codec remote point to the camera remote's infrared tube(about 10cm distance), then press the button which need to be learned, the LED re-flickering when learning finishes ; press other buttons which also need to be learned; Press the Home+"0" buttons simultaneously to exit and save all remote data. If the button learning fails, the camera will enter normal working mode after 15seconds, LED will extinguish.
3. **All Button Coding:** long press (3seconds) Home+number"2" button simultaneously, the green indicator LED will start flickering(1HZ), to enter all button learning mode; get codec remote point to the camera remote's infrared tube(about 10cm distance), to start all button coding mode, the LED will extinguish when learning finished. If the button learning fails, the camera will enter normal working mode after 15seconds, LED will extinguish.
4. **All Button Sending Mode:** long press (3seconds) the Menu+ number "3" button simultaneously, the remote will enter all button sending mode.
5. Similar operation for the TV control mode learning.

VISCA IN (RS232) PORT

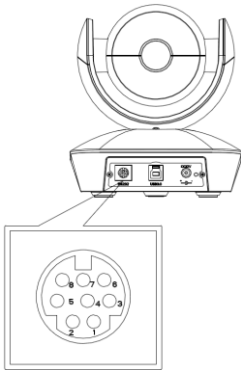

No.	Function
1	DTR
2	DSR
3	TXD
4	GND
5	RXD
6	A
7	IR OUT
8	B

VISCA IN & RS485 Connection

Camera VISCA IN	RS485	
1	DTR	
2	DSR	
3	TXD	
4	GND	GND
5	RXD	
6	A(+)	A(+)
7	IR OUT	
8	B(-)	B(-)

VISCA IN & DB9 Connection

Camera VISCA IN		Windows DB-9	
1	DTR	6	DSR
2	DSR	4	DTR
3	TXD	2	RXD
4	GND	5	GND
5	RXD	3	TXD
6	A(+)		
7	IR OUT		
8	B(-)		

SERIAL PORT CONFIGURATION:

Parameter	Value	Parameter	Value
Baud rate	2400/4800/9600/115200	Stop Bit	1bit
Start Bit	1 bit	Verify Bit	None
Date Bit	8 bit		

VISCA PROTOCOL

Part1 Camera Return Command

Ack/Completion Message		
	Command Packet	Note
ACK	z0 41 FF	Returned when the command is accepted.
Completion	z0 51 FF	Returned when the command has been executed.

z = camera address+8

Error Messages		
	Command Packet	Note
Syntax Error	z0 60 02 FF	Returned when the command format is different or when a command with illegal command parameters is accepted
Command Not Executable	z0 61 41 FF	Returned when a command cannot be executed due to current conditions. For example, when commands controlling the focus manually are received during auto focus.

Part2 Camera Control Command

Command	Funnation	Command Packet	Note
AddressSet	Broadcast	88 30 01 FF	Address setting
IF_Clear	Broadcast	88 01 00 01 FF	I/F Clear
CAM_Power	On	8x 01 04 00 02 FF	Power ON/OFF
	Off	8x 01 04 00 03 FF	
CAM_Zoom	Stop	8x 01 04 07 00 FF	p = 0(low)~7(high)
	Tele(Standard)	8x 01 04 07 02 FF	
	Wide(Standard)	8x 01 04 07 03 FF	
	Tele(Variable)	8x 01 04 07 2p FF	
	Wide(Variable)	8x 01 04 07 3p FF	
	Direct	8x 01 04 47 0p 0q 0r 0s FF	
CAM_Focus	Stop	8x 01 04 08 00 FF	
	Far(Standard)	8x 01 04 08 02 FF	
	Near(Standard)	8x 01 04 08 03 FF	

Command	Funnation	Command Packet	Note
	Direct	8x 01 04 48 0p 0q 0r 0s FF	pqrs: Focus Position
	One Push AF	8x 01 04 18 01 FF	
CAM_ZoomFocus	Direct	8x 01 04 47 0p 0q 0r 0s 0t 0u 0v 0w FF	pqrs: Zoom Position (0(wide)~ 0x4000(tele)) tuvw: Focus Position
CAM_WB	Auto	8x 01 04 35 00 FF	
	Indoor	8x 01 04 35 01 FF	
	Outdoor	8x 01 04 35 02 FF	
	OnePush	8x 01 04 35 03 FF	
	Manual	8x 01 04 35 05 FF	
	Outdoor Auto	8x 01 04 35 06 FF	
	Sodium Lamp Auto	8x 01 04 35 07 FF	
Sodium Auto	8x 01 04 35 08 FF		
CAM_RGain	Reset	8x 01 04 03 00 FF	Manual Control of R Gain
	Up	8x 01 04 03 02 FF	
	Down	8x 01 04 03 03 FF	
	Direct	8x 01 04 43 00 00 0p 0q FF	pq: R Gain (0~0xFF)
CAM_Bgain	Reset	8x 01 04 04 00 FF	Manual Control of B Gain
	Up	8x 01 04 04 02 FF	
	Down	8x 01 04 04 03 FF	
	Direct	8x 01 04 44 00 00 0p 0q FF	pq: B Gain (0-0xFF)
CAM_AE	Full Auto	8x 01 04 39 00 FF	Automatic Exposure mode
	Manual	8x 01 04 39 03 FF	Manual Control mode
	Bright	8x 01 04 39 0D FF	Bright mode(Manual control)
CAM_Shutter	Reset	8x 01 04 0A 00 FF	Shutter Setting
	Up	8x 01 04 0A 02 FF	
	Down	8x 01 04 0A 03 FF	
	Direct	8x 01 04 4A 00 00 0p 0q FF	pq: Shutter Position (0~0x15)
CAM_Iris	Reset	8x 01 04 0B 00 FF	Iris Setting
	Up	8x 01 04 0B 02 FF	
	Down	8x 01 04 0B 03 FF	
	Direct	8x 01 04 4B 00 00 0p 0q FF	pq: Iris Position (0~ 0x11)
CAM_Gain	Reset	8x 01 04 0C 00 FF	Gain Setting
	Up	8x 01 04 0C 02 FF	
	Down	8x 01 04 0C 03 FF	

Command	Funntion	Command Packet	Note
	Direct	8x 01 04 0C 00 00 0p 0q FF	pq: Gain Positon (0~0x0E)
CAM_Bright	Reset	8x 01 04 0D 00 FF	Bright Setting
	Up	8x 01 04 0D 02 FF	
	Down	8x 01 04 0D 03 FF	
	Direct	8x 01 04 4D 00 00 0p 0q FF	pq: Bright I Positon ()
CAM_WDR	On	8x 01 04 3D 02 FF	WDR ON/OFF
	Off	8x 01 04 3D 03 FF	
	Direct	8x 01 04 D3 0p FF	pq: WDR Position (1~0x06)
CAM_BackLight	On	8x 01 04 33 02 FF	BackLight On
	Off	8x 01 04 33 03 FF	BackLight Off
CAM_Aperture	Reset	8x 01 04 02 00 FF	Aperture Control
	Up	8x 01 04 02 02 FF	
	Down	8x 01 04 02 03 FF	
	Direct	8x 01 04 42 00 00 0p 0q FF	pq: Aperture Gain (0~0x04)
CAM_Memory	Reset	8x 01 04 3F 00 0p FF	p: Memory Number(=0 to 127) Corresponds to 0 to 9 on the Remote Commander
	Set	8x 01 04 3F 01 0p FF	
	Recall	8x 01 04 3F 02 0p FF	
CAM_LR_Reverse	On	8x 01 04 61 02 FF	Image Flip Horizontal ON/OFF
	Off	8x 01 04 61 03 FF	
CAM_PictureFlip	On	8x 01 04 66 02 FF	Image Flip Vertical ON/OFF
	Off	8x 01 04 66 03 FF	
CAM_ColorGain	Direct	8x 01 04 49 00 00 00 0p FF	(0~0x0E)
CAM_2D Noise Reduction	Direct	8x 01 04 53 0p FF	0: OFF 1: ON
CAM_3D Noise Reduction	Direct	8x 01 04 54 0p FF	0:OFF 1: AUTO 2~5: LEVEL
FLICK	50HZ	81 01 04 23 01 FF	
	60HZ	81 01 04 23 02 FF	
Freeze	Freeze On	81 01 04 62 02 FF	Freeze On Immediately
	Freeze Off	81 01 04 62 03 FF	Freeze Off Immediately
	Preset Freeze On	81 01 04 62 22 FF	Freeze On When Running Preset
	Preset Freeze Off	81 01 04 62 23 FF	Freeze Off When Running Preset
IR_Transfer	Transfer On	8x 01 06 1A 02 FF	Receive IR(remote commander) CODE from VISCA communication ON/OFF
	Transfer Off	8x 01 06 1A 03 FF	
Pan_tiltDrive	Up	8x 01 06 01 VV WW 03 01 FF	VV: Pan speed 0x01 (low speed) to 0x18 (high speed) WW: Tilt speed 0x01 (low speed) to
	Down	8x 01 06 01 VV WW 03 02 FF	

Command	Funnation	Command Packet	Note
	Left	8x 01 06 01 VV WW 01 03 FF	0x14 (high speed) YYYY: Pan Position(TBD) ZZZZ: Tilt Position(TBD)
	Right	8x 01 06 01 VV WW 02 03 FF	
	Upleft	8x 01 06 01 VV WW 01 01 FF	
	Upright	8x 01 06 01 VV WW 02 01 FF	
	DownLeft	8x 01 06 01 VV WW 01 02 FF	
	DownRight	8x 01 06 01 VV WW 02 02 FF	
	Stop	8x 01 06 01 VV WW 03 03 FF	
	AbsolutePosition	8x 01 06 02 VV WW 0Y 0Y 0Y 0Y 0Z 0Z 0Z 0Z FF	
	RelativePosition	8x 01 06 03 VV WW 0Y 0Y 0Y 0Y 0Z 0Z 0Z 0Z FF	
	Home	8x 01 06 04 FF	
	Reset	8x 01 06 05 FF	
Pan-tiltLimitSet	Set	8x 01 06 07 00 0W 0Y 0Y 0Y 0Y 0Z 0Z 0Z 0Z FF	W:1 UpRight 0:DownLeft YYYY: Pan Limit Position(TBD) ZZZZ: Tilt Limit Position(TBD)
	Clear	8x 01 06 07 01 0W 07 0F 0F 0F 07 0F 0F 0F FF	

Part3 Inquiry Command

Command	Command Packet	Return Packet	Note
CAM_PowerInq	8x 09 04 00 FF	y0 50 02 FF	On
		y0 50 03 FF	Off(Standby)
CAM_ZoomPosInq	8x 09 04 47 FF	y0 50 0p 0q 0r 0s FF	pqrs: Zoom Position
CAM_FocusModelInq	8x 09 04 38 FF	y0 50 02 FF	Auto Focus
		y0 50 03 FF	Manual Focus
CAM_FocusPosInq	8x 09 04 48 FF	y0 50 0p 0q 0r 0s FF	pqrs: Focus Position
CAM_WBModelInq	8x 09 04 35 FF	y0 50 00 FF	Auto
		y0 50 01 FF	Indoor mode
		y0 50 02 FF	Outdoor mode
		y0 50 03 FF	OnePush mode
		y0 50 04 FF	ATW
y0 50 05 FF	Manual		
CAM_RGainInq	8x 09 04 43 FF	y0 50 00 00 0p 0q FF	pq: R Gain
CAM_BGainInq	8x 09 04 44 FF	y0 50 00 00 0p 0q FF	pq: B Gain
CAM_AEModelInq	8x 09 04 39 FF	y0 50 00 FF	Full Auto
		y0 50 03 FF	Manual
		y0 50 0A FF	Shutter priority
		y0 50 0B FF	Iris priority
y0 50 0D FF	Bright		
CAM_ShutterPosInq	8x 09 04 4A FF	y0 50 00 00 0p 0q FF	pq: Shutter Position
CAM_IrisPosInq	8x 09 04 4B FF	y0 50 00 00 0p 0q FF	pq: Iris Position
CAM_GainPosInq	8x 09 04 4C FF	y0 50 00 00 0p 0q FF	pq: Gain Position
CAM_BrightPosInq	8x 09 04 4D FF	y0 50 00 00 0p 0q FF	pq: Bright Position
CAM_ExpCompModelInq	8x 09 04 3E FF	y0 50 02 FF	On

		y0 50 03 FF	Off
CAM_ExpCompPosInq	8x 09 04 4E FF	y0 50 00 00 0p 0q FF	pp: ExpComp Position
CAM_ApertureInq	8x 09 04 42 FF	y0 50 00 00 0p 0q FF	pp: Aperture Gain
CAM_MemoryInq	8x 09 04 3F FF	y0 50pp FF	pp: Memory number last operated.
SYS_MenuModelInq	8x 09 06 06 FF	y0 50 02 FF	On
		y0 50 03 FF	Off
CAM_LR_ReverseInq	8x 09 04 61 FF	y0 50 02 FF	On
		y0 50 03 FF	Off
CAM_PictureFlipInq	8x 09 04 66 FF	y0 50 02 FF	On
		y0 50 03 FF	Off
CAM_IDInq	8x 09 04 22 FF	y0 50 0p 0q 0r 0s FF	ppqrs: Camera ID
CAM_VersionInq	8x 09 00 02 FF	y0 50 ab cd mn pq rs tu vw FF	
		y0 50 02 FF	On
IR_Transfer	8x 09 06 1A FF	y0 50 03 FF	Off
Pan-tiltMaxSpeedInq	8x 09 06 11 FF	y0 50 ww zz FF	ww: PanMaxSpeed zz: Tilt Max Speed
Pan-tiltPosInq	8x 09 06 12 FF	y0 50 0w 0w 0w 0w 0z 0z 0z 0z FF	wwwww: PanPosition zzzz: Tilt Position

Note: 【x】 means the camera address ; 【y】 = 【x + 8】 .

VISCA PAN TILT ABSOLUTE POSITION VALUE

Pan Angle	VISCA Value	Tilt Angle	VISCA Value
-170	0xF670	-30	0xFE50
-135	0xF868	0	0x0000
-90	0xFAF0	30	0x01B0
-45	0xFD78	60	0x0360
0	0x0000	90	0x510
45	0x0288		
90	0x0510		
135	0x0798		
170	0x0990		

VISCA PAN TILT SPEED VALUE

Pan(degree/second)		tilt(degree/second)	
0	0.3	0	0.3
1	1	1	1
2	1.5	2	1.5
3	2.2	3	2.2
4	2.4	4	3.6
5	2.6	5	4.7
6	2.8	6	6
7	3.0	7	8
8	3.2	8	10
9	3.4	9	12
10	3.8	10	15
11	4.5	11	18
12	6	12	23
13	9	13	30
14	15	14	39
15	19	15	48
16	25	16	59
17	32	17	69
18	38	18	80
19	45		

20	58		
21	75		
22	88		
23	105		
24	120		

		60/30mode	50/25mode			
Shutter speed	21	1/10000	1/10000	Iris	0	close
	20	1/6000	1/6000		1	F14
	19	1/4000	1/3500		2	F11
	18	1/3000	1/2500		3	F9.6
	17	1/2000	1/1750		4	F8
	16	1/1500	1/1250		5	F6.8
	15	1/1000	1/1000		6	F5.6
	14	1/725	1/600		7	F4.8
	13	1/500	1/425		8	F4
	12	1/350	1/300		9	F3.4
	11	1/250	1/215		10	F2.8
	10	1/180	1/150		11	F2.4
	9	1/125	1/120		12	F2
	8	1/100	1/100		13	F1.6
	7	1/90	1/75			
	6	1/60	1/50			
	5	1/30	1/25			
	4	1/15	1/12			
	3	1/8	1/6			
	2	1/4	1/3			
1	1/2	1/2				
0	1/1	1/1				
Gain	0	0dB		Gain	8	16dB
	1	2dB			9	18dB
	2	4dB			10	20dB
	3	6dB			11	22dB
	4	8dB			12	24dB
	5	10dB			13	26dB
	6	12dB			14	28dB
	7	14dB			15	30dB

IR TRANSFER(IR PASS)

1. Currently the camera support NEC code format. For customized with other codes, pls contact us.
2. Once the camera finish power configuration, enable the IR transfer function via sending COM command.
3. Get the targeted remote controller point to the camera IR receiver, press keys on the remote controller, then the camera will output the received IR code via VISCA IN port.
4. IR Transfer output format:

XX XX XX XX: Remote Controller Code	FF: End Code
-------------------------------------	--------------
5. The camera can save all setting, no need to re-set after power circle.

OSD MENU

1. under working mode, press the menu button  on the IR remote, to enter the OSD menu ; press the menu butoon again to exit and save modified parameters.

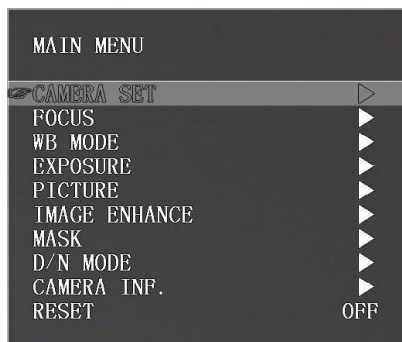

2. Use the navigate button to select the main menu. As above picture, once been selected, the main menu will change to grey color background, and the right side will show all parameters under this sub menu :

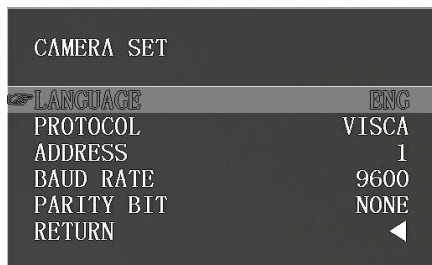

3. In the second grade menu, press the up/down navigate button to select the sub menu, use left/right navigate button to set the parameter;
4. Select the last option “return” and press the right navigate button to get back to previous menu;
5. Press OSD button  again to exit the menu.

CAMERA SET	LANGUAGE	Chinese/English
	PROTOCOL	VISCA/PELCO-P/PELCO-D
	ADDRESS	1~7
	BAUD RATE	2400,9600,115200
	PARITY BIT	NONE
	RETURN	Back to the main menu

FOCUS	FOCUS MODE	AUTO/MANUAL/PUSH
	SENSITIVITY	LOW/MID/HIGH
	FOCUS LIMIT	1.5M/2M/3M/6M/10M
	D_ZOOM	OFF/ON
	ZOOM SPEED	0-7
	LENS INIT	OFF/5K/10K/15K/20K/EXE
	DIS ZOOM RATIO	OFF/ON
	RETURN	Back to the main menu

WB MODE	WB MODE	ATW/MANU/MANU2/SON./FL./AUTO/IDR./ODR./PUSH
	B_GAIN	0~255 (Only Valid when WB MODE set to MANU)
	R_GAIN	0~255 (Only Valid when WB MODE set to MANU)
	RETURN	Back to the main menu

EXPOSURE	EXP MODE	AUTO/MANU/IRIS/SHUT/BRL
	SHUT TIME	Shutter time: 1/1~1/5000 Only Valid when EXP MODE set to MANU
	IRIS	Iris value: 0-13 Only Valid when EXP MODE set to MANU
	AGC	Gain value: 0dB~15dB Only Valid when EXP MODE set to MANU
	BRIGHT	Brightness value: 0-27 Only Valid when EXP MODE set to BRI
	SLOW SHUT	OFF/ON
	FLICK	OFF/50HZ/60HZ
	RETURN	Back to the main menu

PICTURE	BRIGHTNESS	1-15
	SHARPNESS	0-15
	CONSTRAS	0-15
	SATURATION	0-14
	MIRROR	Image 180degree rotation left/right: OFF/ON
	PIC FLIP	Image 180degree rotation up/down: OFF/ON
	FREEZE	OFF/ON
	DEFOG	OFF/1-15
	RETURN	Back to the main menu

IMAGE ENHANCE	2D NR	OFF/ON;
	3D NR	OFF/AUTO/ 1-4
	D_WDR	OFF/1-6
	GAMMA	0-4
	BACKLIGHT	OFF/ON
	HIGHLIGHT	OFF/ON
	RETURN	Back to the main menu

MASK	MASK SWITCH	ON/OFF
	COLOUR	WHITE/YELLOW/GRAY/GREEN/VIOLET/RED/
	INDEX	1-8
	INDEX SWITCH	OFF/ON
	ROW START	0-1919
	ROW END	1-1920
	LINE START	0-1079
	LINE END	1-1079
	RETURN	Back to the main menu

D/N MODE	D/N MODE	DAY/NIGHT/AUTO/EXT
	DAY TO NIGHT	15-126
	NIGHT TO DAY	5-190
	SWITCH DELAY	1-60
	GAIN LIMIT	2-511
	RETURN	Back to the main menu

CAMERA INF.	IMAGE VER.	PC-V0.0.6 (changes without additional notices)
	IMAGE DATE	16.10.20 (changes without additional notices)
	CONTROL VER.	UC V0.1.4 (changes without additional notices)
	CONTROL DATE	17.01.07 (changes without additional notices)
	BAUDRATE	9600
	PARITY BIT	NONE
	FRAMERATE	1080P30
	RETURN	Back to the main menu

UVC CONTROL

	Control Requests	Control Selector
1	Brightness Control	PU_BRIGHTNESS_CONTROL
2	Contrast Control	PU_CONTRAST_CONTROL
3	Hue Control	PU_HUE_CONTROL
4	Saturation Control	PU_SATURATION_CONTROL
5	Sharpness Control	PU_SHARPNESS_CONTROL
6	Gamma Control	PU_GAMMA_CONTROL
7	White Balance Temperature Control	PU_WHITE_BALANCE_TEMPERATURE_CONTROL
8	Gain Control	PU_GAIN_CONTROL
9	Power Line Frequency Control	PU_POWER_LINE_FREQUENCY_CONTROL
10	Zoom (Absolute) Control	CT_ZOOM_ABSOLUTE_CONTROL
11	Zoom (Relative) Control	CT_ZOOM_RELATIVE_CONTROL
12	PanTilt (Absolute) Control	CT_PANTILT_ABSOLUTE_CONTROL
13	PanTilt (Relative) Control	CT_PANTILT_RELATIVE_CONTROL

