

INSTRUCTION MANUAL



915FS Optical Fiber Fusion Splicer



Read and understand all of the instructions and safety information in this manual before operating or servicing this tool.

Register this product at www.greenleecommunications.com

Table of Contents

Preface	3
Important Safety Information	4
Section 1. Identification	9
Section 2. Operation	11
Setup.....	11
Splice Mode	12
Fiber Preparation.....	13
Splicing Procedure.....	15
Heating Protection Sleeve.....	16
Cooling Tray	17
Splice-on Connectors	17
Upgrading Software	17
Button Functions.....	18
Appendixes	18
Section 3. Menu Operation	19
Splice Mode Menu (S-Mode).....	21
Heater Mode Menu (H-Mode).....	24
Maintenance.....	26
Splice Set	29
Data Save.....	30
Set.....	32
Section 4. Specifications	37
Section 5. Troubleshooting	38
Appendix A. 915FS Fusion Splicer Cleaning	43
Appendix B. Practice Splicing	46
Appendix C. Greenlee Splice-on Connectors	48

Preface

Description

The Greenlee Communications 915FS Optical Fiber Fusion Splicer is intended to fuse fibers, resulting in low splice loss and long-term stable splices. Splice loss depends on certain conditions such as fiber preparation, splicing parameters, and fiber condition.

The 915FS fusion splicer uses an active cladding alignment technology in which alignment of the fiber is performed in all three axis. This allows the technician to complete fusion splices with low splice losses as with core alignment splicers and far surpassing the performance of V-Groove splicers.

The 915FS is perfectly suited for all FTT(x) and P2P applications.

Contents List

- 915FS fusion splicer
- 250 micron adapter pair
- 900 micron adapter pair
- SC/LC splice-on connector adapter
- Spare electrodes (one pair)
- AC adapter (power supply) with line cord
- Battery pack (installed in 915FS)
- Carry case with strap
- 1.5 mm hex wrench
- Plastic tweezers
- Cooling tray
- Electrode polisher with 10 polishing strips
- Cleaning brush
- USB cable
- Oven adapter for SOC
- User manual

Safety

Safety is essential in the use and maintenance of Greenlee tools and equipment. This instruction manual and any markings on the tool provide information for avoiding hazards and unsafe practices related to the use of this tool. Observe all of the safety information provided.

Purpose of This Manual

This instruction manual is intended to familiarize all personnel with the safe operation and maintenance procedures for the Greenlee Communications 915FS Optical Fiber Fusion Splicer.

Keep this manual available to all personnel. Replacement manuals are available upon request at no charge at www.greenleecommunications.com.

All specifications are nominal and may change as design improvements occur. Greenlee Textron Inc. shall not be liable for damages resulting from misapplication or misuse of its products.

fiberTOOLS is a trademark of Textron Innovations Inc.

Important Safety Information

General

Use this unit for the manufacturer's intended purpose only, as described in this manual. Any other use can impair the protection provided by the unit. Do not use the splicer on live fibers.

Environmental Conditions

This tool is designed to operate at a maximum relative humidity of 95% and at altitudes up to 5000 m (16,400 ft).

Before Applying Power

Verify that the tool is set to match the available line voltage and the correct fuse is installed.

Do Not Operate in Explosive Atmosphere

Do not operate the tool in the presence of flammable gases or fumes.

Do Not Remove Instrument Cover

Do not remove the cover of the unit for any reason. It contains no user-serviceable parts.



SAFETY ALERT SYMBOL

This symbol is used to call your attention to hazards or unsafe practices which could result in an injury or property damage. The signal word, defined below, indicates the severity of the hazard. The message after the signal word provides information for preventing or avoiding the hazard.

DANGER

Immediate hazards which, if not avoided, WILL result in severe injury or death.

WARNING

Hazards which, if not avoided, COULD result in severe injury or death.

CAUTION

Hazards or unsafe practices which, if not avoided, MAY result in injury or property damage.





WARNING

Read and understand all of the instructions and safety information in this manual before operating or servicing this tool.

Failure to observe this warning could result in severe injury or death.

Important Safety Information

	⚠ WARNING
	<p>Electric shock hazard: Contact with live circuits could result in severe injury or death.</p>

	⚠ WARNING
	<p>Wear eye protection when using this tool. Fiber fragments can be extremely dangerous if they come into contact with eyes or skin or are ingested.</p>

⚠ WARNING
<p>Disconnect AC power cord from AC adapter inlet or wall socket (outlet) immediately if user observes the following or if the splicer receives the following faults:</p> <ul style="list-style-type: none"> • Fumes, bad odor, noise, or overheat occurs. • Liquid or foreign matter falls into cabinet. • Splicer is damaged or dropped. <p>If these faults occur, return unit to Greenlee service center for repair. Leaving splicer in a damaged state could cause equipment failure, electric shock or fire, and could result in severe injury or death.</p>

⚠ WARNING
<p>Electric shock hazard:</p> <ul style="list-style-type: none"> • Use only AC adapter or battery charger designed for this splicer. Using an improper AC power source could cause fuming, electric shock, or equipment damage. • Do not disassemble or modify splicer, AC adapter, or battery. Do not remove or bypass any electrical or mechanical device (e.g., fuse or safety switch) incorporated into design and manufacturing of this equipment. • Never operate tool in an environment where flammable liquids or vapors exist. Risk of fire or explosion could result from the tool's electrical arc in such an environment. • Do not use compressed gas or canned air to clean tool. They may contain flammable materials that could ignite during electrical discharge. • Do not touch electrodes when splicer is on and power is supplied to unit. The electrodes generate high voltage and high temperatures that could cause a severe shock or burn. • Turn tool off and disconnect AC power cord before replacing electrodes. <p>Failure to observe these warnings could result in severe injury or death.</p>

Important Safety Information

⚠ WARNING

Electric shock hazard: Use only proper power source.

- Check AC power source before use. Proper AC power source is 100–240 VAC, 50–60 Hz. Proper DC power source is 10–12 VDC. Improper AC or DC power source could cause fuming, electric shock, or equipment damage.
- AC generators commonly produce abnormally high AC output voltage or irregular frequencies. Measure output AC voltage with a circuit tester before connecting the AC power cord. Such abnormally high voltage or frequency from a generator could cause fuming, electric shock, or equipment damage. Make sure generator is regularly checked and serviced.

Failure to observe these warnings could result in severe injury or death.

⚠ WARNING

Electric shock hazard:

- Do not modify, abuse, heat, or excessively pull on power cord. Use of a damaged cord could cause fuming, electric shock, or equipment damage.
- This tool uses a three-prong (core) AC power cord that contains an earthed ground safety mechanism. This tool must be grounded. Use only the supplied power cord. Never use a two-prong (core) power cord, extension cord, or plug.
- Connect AC power cord properly to splicer (inlet) and wall socket (outlet). When inserting AC plug, make sure there is no dust or dirt on terminals. Engage by pressing the female plug into the splicer (inlet) and the male plug into the wall socket (outlet) until both plugs are fully seated. Incomplete engagement could cause fuming, electric shock, or equipment damage.
- Do not short-circuit the terminals of AC adapter and optional battery. Excessive electrical current could cause fuming, electric shock, or equipment damage.
- Do not touch the splicer, AC power cord, and AC plugs with wet hands.
- Do not operate splicer near hot objects, in hot temperature environments, in dusty/humid atmospheres or when condensation is present on the tool. This may result in electric shock, splicer malfunction, or poor splicing performance.

Failure to observe these warnings could result in severe injury or death.

Important Safety Information

⚠ WARNING

Explosion hazard: Follow these instructions when using lithium-ion battery:

- Do not charge battery with other methods than instructed.
- Do not dispose of battery in an incinerator or fire.
- Do not charge or discharge battery near a flame or in direct sunlight.
- Do not excessively shake or jar battery.
- If battery leaks liquid residue, be careful handling battery so liquid does not contact skin or eyes. If skin or eyes are contacted, immediately wash thoroughly and seek medical attention. Dispose of battery and order replacement from Greenlee.
- If charge did not complete in four hours or the “CHARGE” LED is constantly on, stop charging immediately and call Greenlee service center for repair.

Failure to observe these warnings could result in severe injury or death.

⚠ CAUTION

Battery safety:

- Do not allow anything to contact the battery terminals.
- Do not immerse batteries in liquid. Liquid may create a short circuit and damage the battery. If batteries are immersed, contact your service center for proper handling.
- Do not place the battery into a pocket, tool pouch, or tool box with conductive objects. Conductive objects may create a short circuit and damage the battery.
- Do not place a battery on moist ground or grass. Moisture may create a short circuit and damage the battery.
- Do not store the battery at more than 122 °F (50 °C) or less than -22 °F (-30 °C). Damage to the battery can result.
- Do not use another manufacturer’s charger. Other manufacturers’ chargers may overcharge and damage the battery.
- Do not attempt to open the battery. It contains no user-serviceable parts.

Failure to observe these precautions may result in injury and may damage the unit.

Important Safety Information

⚠ CAUTION

- Do not store tool in areas of extremely high temperature and humidity.
- Do not touch protection sleeve or tube heater during or immediately after heating. These surfaces are very hot and touching them may result in burns.
- Do not place tool in an unstable or unbalanced position. Tool may shift or lose balance, causing unit to fall.
- This tool is precision adjusted and aligned. Do not allow unit to receive a strong shock or impact. Use supplied carrying case for transportation and storage. Carrying case protects tool from damage, moisture, vibration, and shock.

Failure to observe these precautions may result in injury and may damage the unit.

⚠ CAUTION

Follow these instructions for handling electrodes:

- Use only specified electrodes.
- Set new electrodes in correct position.
- Replace electrodes as a pair.

Failure to observe this precaution may cause abnormal arc discharge, which may result in equipment damage or degradation in splicing performance.

⚠ CAUTION

- Do not use any chemical other than pure alcohol (99% or greater) to clean the V-groove, LCD monitor, etc. Use of other chemicals may cause blurring, discoloration, damage, or deterioration.
- This tool requires no lubrication. Oil or grease may degrade the splicing performance and damage the splicer.
- This equipment must be repaired or adjusted by a qualified technician or engineer. Incorrect repair may cause fire or electric shock. Contact Greenlee service center for repair.

Failure to observe these precautions may result in injury and may damage the unit.

Section 1. Identification

Components of Splicer

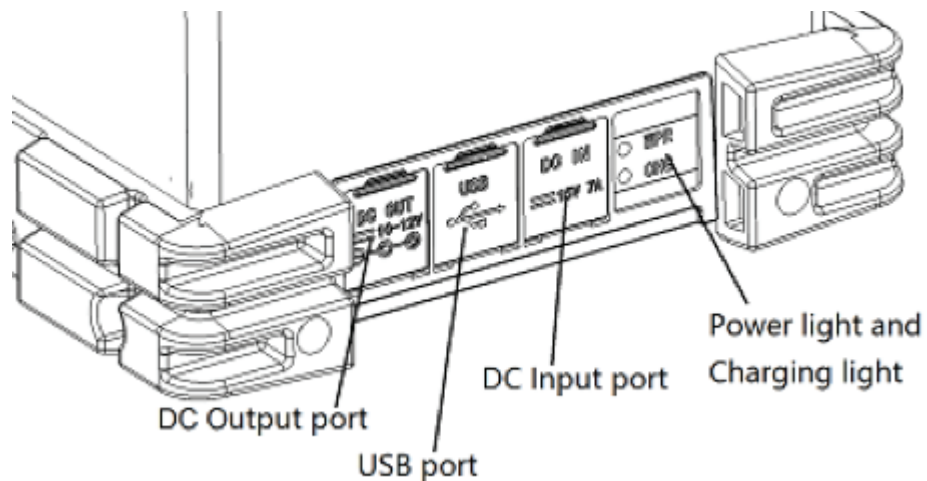
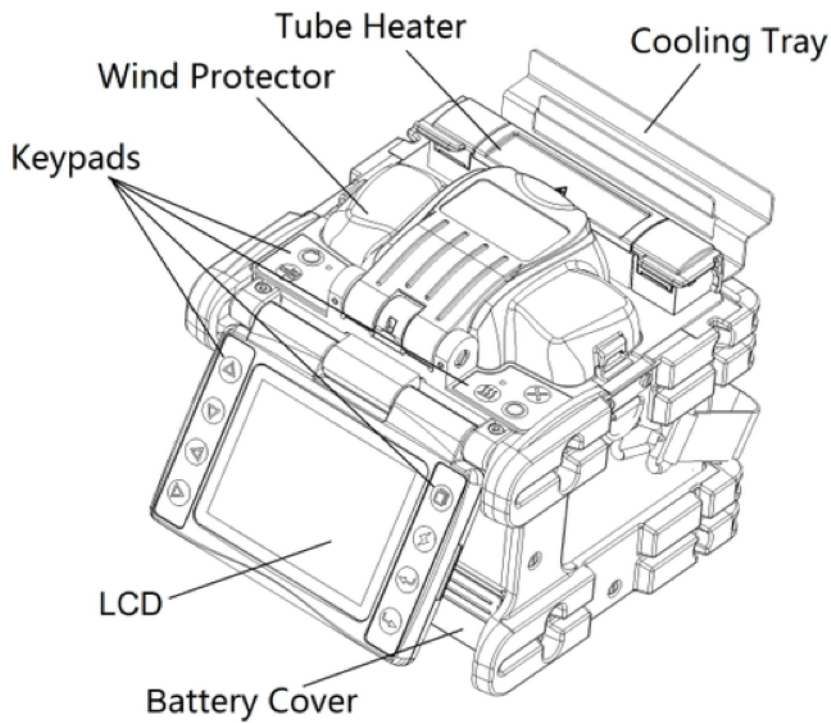

Top View

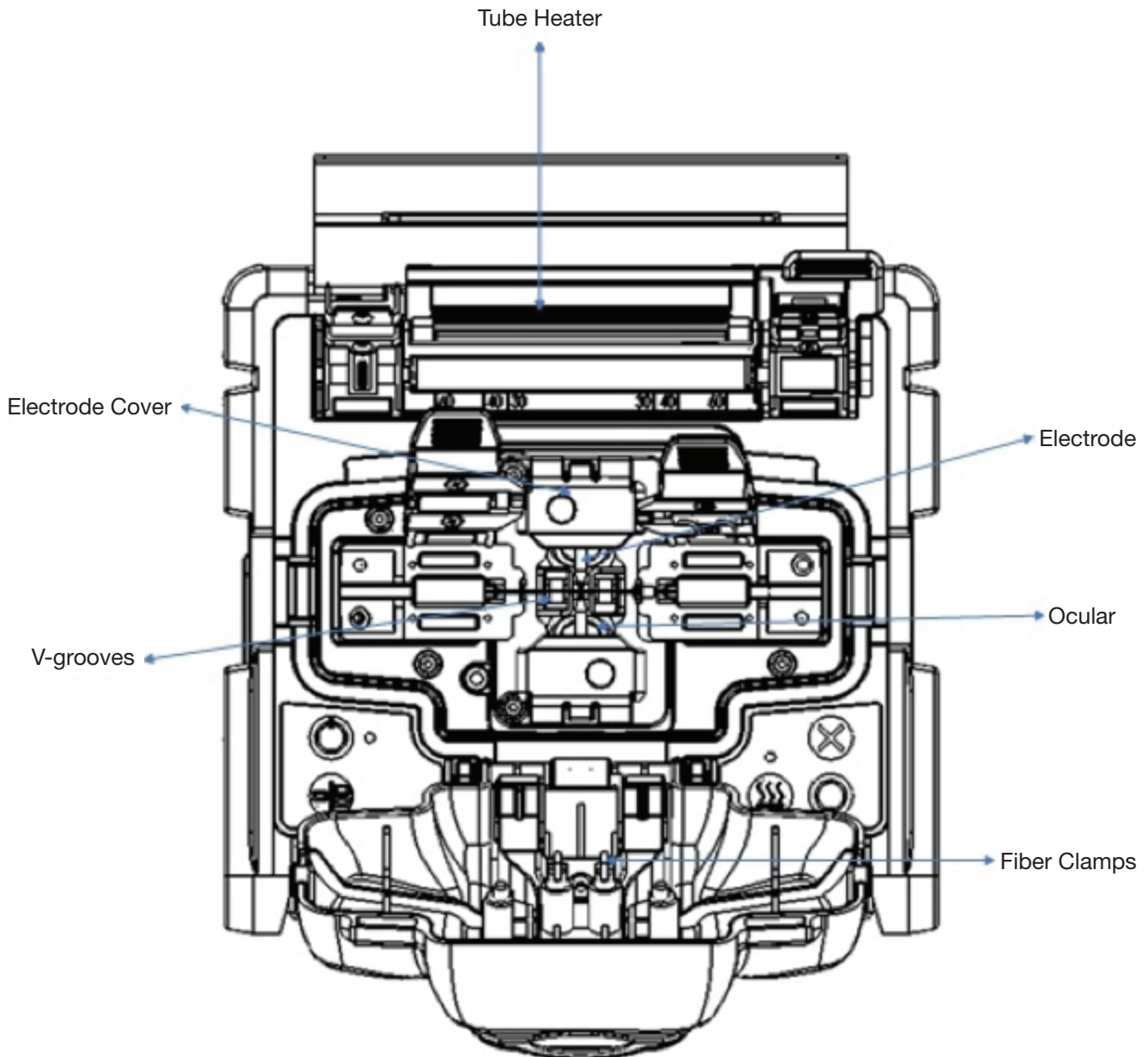

Section 2. Operation

Setup

Installing Battery in Splicer

The 915FS can be powered by an external power adapter and battery.

Inserting the Battery

Open the battery cover and insert the battery into the battery compartment. Then close the battery cover and lock it.

Removing the Battery

Unlock the battery cover. Open it and pull the battery out from the battery compartment. Then close the battery cover.

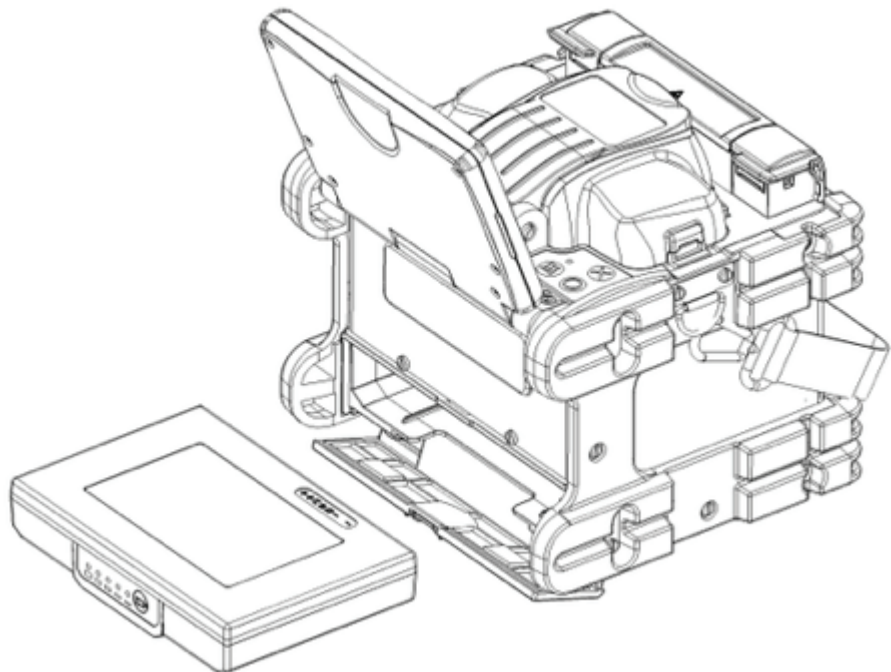

Two Methods of Checking Remaining Battery Capacity

- If the battery is already installed in the splicer, turn the splicer ON. The battery is automatically identified, and the remaining battery capacity is displayed on the “Ready” screen.
- Press the battery check button on the battery pack. The remaining battery capacity is indicated on the LED indicator.

Turning Splicer ON

Press and hold  until the LED on the keypad turns ON (green color).

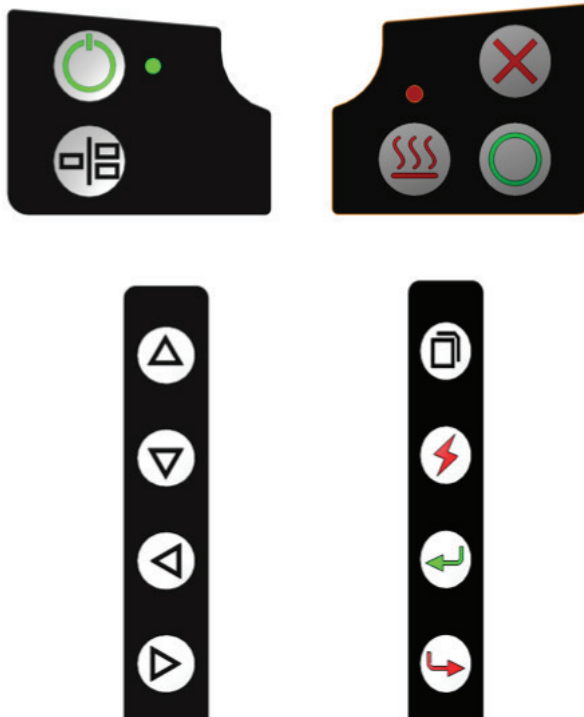

The “Ready” screen is displayed after all the motors reset to their initial positions.

The power source type is automatically identified. If the battery is used, the remaining battery capacity is displayed.

Splice Mode

Use SM splice mode for standard SM fiber (ITU-TG.652) splicing. It performs splices in 9 seconds and is the fastest mode for SM fiber splicing.

Use AUTO splice mode if fiber type is not identified. Splice takes 2 seconds longer but it covers most conventional fiber splicing for the following reasons:

- AUTO mode first identifies fiber type by analyzing fiber profile, and the splicing condition is chosen for the type of fiber. The types of fibers covered by AUTO are all the conventional fibers, such as SMF (G652), BIF (G657), NZDSF (G655), MMF (G651), etc. AUTO mode takes longer than the SM processes but is recommended in cases where the fiber type is not positively identified or if the user is new to fusion splicing.
- AUTO mode uses an automatic arc calibration function, which monitors the splicing process and ensures adequate arc power for the splice.

Automatic Arc Calibration Function

When the automatic arc calibration function is enabled, performing the arc calibration function before a splice operation is not necessary as previous splice’s ARC power is used. If the ambient conditions or type of fiber has changed an ARC calibration may be required. The automatic arc calibration function works in AUTO modes only. It is not active in the standard splice modes. When using those modes, performing arc calibration before splicing is strongly recommended.

Fiber Preparation

Placing Protection Sleeve over Fiber

Place the protection sleeve over the fiber. Clean optical fiber with alcohol-soaked gauze or lint-free tissue approximately 100 mm (4 in) from the tip.

Note: Splice-on connectors are pre-cleaved. Do not attempt to clean the fiber on the splice-on connector. Follow the instructions supplied with the splice-on connectors.

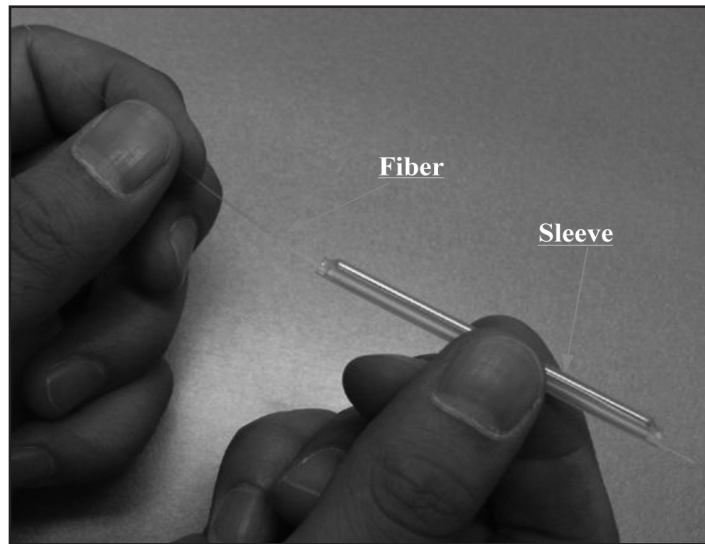

⚠ CAUTION

- Clean optical fiber with alcohol-soaked gauze or lint-free tissue. Dust particulates can enter the protection sleeve, resulting in a fiber break or attenuation increase.
- Make sure fiber is passed through the protection sleeve.
- When protection sleeve core tube is longer than the length of outer sheath, cut off excess sleeve to avoid micro bend after heating.

Failure to observe these precautions may result in injury and may damage the unit.

Stripping and Cleaning Fiber

Use the supplied fiber stripping tool to strip the outer coating 30 to 40 mm (1.25 to 1.5 in) from its tip. Thoroughly clean the fiber with alcohol-soaked (99% or greater) gauze or lint-free tissue.

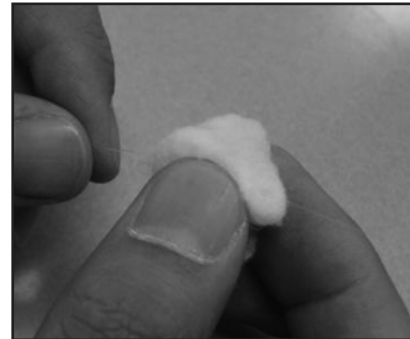
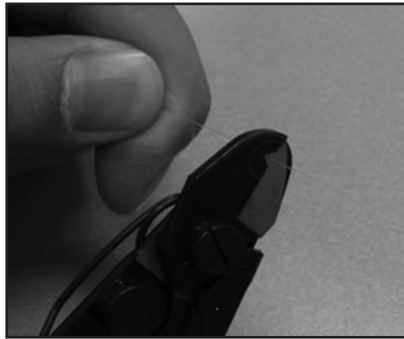

Fiber Cleaving

Do not let the fiber end-face touch anything. Place the fiber into the universal adapter, and insert the adapter into the 915CL. Follow the instructions for the 915CL to cleave the fiber.

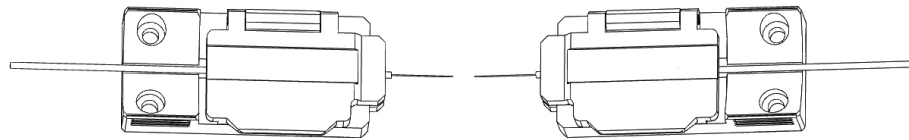

Loading Fiber into Splicer

1. Open the wind protector and install the fiber adapters into the splicer, making sure the fiber is positioned into the center of the V-grooves.
2. Close the wind protector.

Splicing Procedure

To ensure a good splice, the optical fiber is observed with the image processing system equipped in the 915FS. However, in some cases the image processing system cannot detect a faulty splice. Visual inspection with the monitor is often necessary for better splicing yield. Observe the following standard operating procedure:

- After fibers are loaded into the splicer, press **O** and the fibers will move toward each other. The fiber motion stops and the cleaning arc is performed. The cleave angle and end-face quality are checked. If the measured cleave angle is greater than its set threshold or fiber chipping is detected, the beeper sounds and an error message warns the operator. The splicing procedure pauses. If no error message is displayed, the below stated end-face conditions are used for visual inspection. If observed, remove the fiber from the splicer and repeat fiber preparation. These fiber cleave defects may cause a faulty splice.

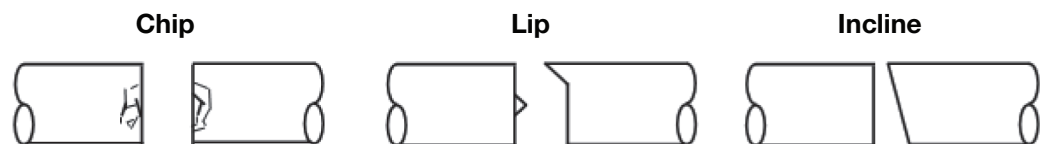

- After fiber inspection, the fibers are aligned core-to-core or cladding-to-cladding. Cladding axis offset and core axis offset measurements can be displayed.
- After completion of fiber alignment, an arc discharge is performed to splice the fibers.
- Estimated splice loss is displayed upon completion of splicing. Splice loss is affected by factors stated in Section 5. These factors are taken into account to calculate, or estimate, splice loss. The calculation is based on dimensional parameters, such as MFD, cleave quality, and fusion splice shape after the splice. If either the cleave angle measured or the estimated splice loss exceeds its set threshold, an error message is displayed. If the spliced fiber is detected as abnormal, such as “Fat”, “Thin” or “Bubble”, an error message is displayed. If no error message is displayed but the splice looks poor by visual inspection through the monitor, it is strongly recommended to resplice.

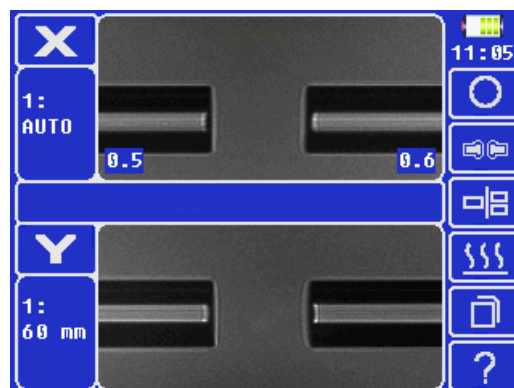

Notes:

- Splice point sometimes looks a bit fatter than other parts. This is considered a normal splice and does not affect splice loss.
- To change threshold for estimated splice loss or cleave angle, refer to “Splice Mode” in this manual for details.
- Splice loss may be improved in some cases by additional arc discharges. Press ⚡ or ⏏ as displayed in the main splicing screen, for an additional arc discharge (re-arc). Splice loss estimate and splice check are performed again. Splice loss may be worsened in some cases by additional arc discharges (re-arcs). Additional arc discharge can be set to “disabled”, or limited to the number of additional arcs.
- Splicing result is automatically saved in splicer memory.

Heating Protection Sleeve

1. Transfer the fiber with protection sleeve from the centering device to the tube heater.
2. Close the tube heater lid.

Notes:

- Make sure the splice point is located at the center of the protection sleeve.
 - Make sure the strength member in the protection sleeve is placed downward.
 - Make sure the fiber is not distorted.
 - The splice-on connector must be installed on the right-hand side of the splicer heater. Use heater profile #1 for the SOC.
3. Press ↵ to start tube heating. The beeper sounds and the HEAT LED (red color) turns off when tube heating is completed.
 4. Open the tube heater lids and remove the protected fiber from the tube heater. Apply some tension to the fiber while removing it from the tube heater.
 5. Visually inspect the finished sleeve to verify that no bubbles or debris/dust is present in the sleeve.

Cooling Tray

Place the splice into the cooling tray on the back of the 915FS splicer.



Splice-on Connectors













The 915FS uses the Greenlee version of splice-on connectors. The 915FS currently supports SC, LC, FC, and ST versions (both PC and APC finish, where applicable).

Follow the instructions supplied with the SOC packaging.

Upgrading Software

The 915FS software can be upgraded using the online software upgrade tool at www.greenleecommunications.com.

Button Functions

Button	Description
	Turns the splicer ON/OFF
	Menu key
	Enter key
	Return/Exit key
	Left key
	Right key
	Up key
	Down key
	Start/Stop heating protection
	Provides a second ARC to the fusion splice
	Resets the motor position
	Starts splicing work
	Switches between X, Y and X/Y views

Appendixes

Refer to the following appendixes at the end of this manual for additional operating information:

- Appendix A—915FS Fusion Splicer Cleaning
- Appendix B—Practice Splicing
- Appendix C—Greenlee Splice-on Connectors

Section 3. Menu Operation

Press  to enter the splicer menu. There are six main menus:

1. Splice Mode Menu (S-Mode)
2. Heater Mode Menu (H-Mode)
3. Maintenance
4. Splice Set
5. Data Save
6. Set



Explanation of Splice Modes

Mode No.	Splice Mode	Description
1	AUTO	For splicing in most cases; the splicer will automatically adjust splice parameters according to fiber type. Automatic arc calibration works in this splice mode.
2	AUTO SM	For splicing standard single-mode fiber (ITU-T G652). The MFD is 9 to 10 μm at wavelength of 1310 nm. Automatic arc calibration works in this splice mode.
3	AUTO DS	For splicing dispersion-shifted fiber (ITU-T G653). The MFD is 7 to 9 μm at wavelength of 1550 nm. Automatic arc calibration works in this splice mode.
4	AUTO NZ	For splicing non-zero dispersion-shifted fiber (ITU-T G655). The MFD is 9 to 10 μm at wavelength of 1550 nm. Automatic arc calibration works in this splice mode.
5	AUTO MM1	For splicing multi-mode fiber (ITU-T G651). Core diameter: 50.0 to 62.5 μm . Automatic arc calibration works in this splice mode.

Explanation of Splice Modes (cont'd)

Mode No.	Splice Mode	Description
6	SM	<p>For splicing standard single-mode fiber (ITU-T G652). The MFD is 9 to 10 μm at wavelength of 1310 nm.</p> <p>User can edit all parameters of this splice mode such as prefuse power, prefuse time, arc power, arc time, align, proof test, etc.</p> <p>The manual splicing operation is provided. Automatic arc calibration does not work in this splice mode.</p>
7	DS	<p>For splicing dispersion-shifted fiber (ITU-T G653). The MFD is 7 to 9 μm at wavelength near 1550 nm.</p> <p>User can edit all parameters of this splice mode such as prefuse power, prefuse time, arc power, arc time, align, proof test, etc.</p> <p>The manual splicing operation is provided. Automatic arc calibration does not work in this splice mode.</p>
8	NZ	<p>For splicing non-zero dispersion-shifted fiber (ITU-T G655). The MFD is 9 to 10 μm at wavelength of 1550 nm.</p> <p>User can edit all parameters of this splice mode such as prefuse power, prefuse time, arc power, arc time, align, proof test, etc.</p> <p>The manual splicing operation is provided. Automatic arc calibration does not work in this splice mode.</p>
9	MM1	<p>For splicing multi-mode fiber (ITU-T G651). Core diameter: 50.0 to 62.5 μm.</p> <p>User can edit all parameters of this splice mode such as prefuse power, prefuse time, arc power, arc time, align, proof test, etc.</p> <p>The manual splicing operation is provided. Automatic arc calibration does not work in this mode.</p>
10	AT1(SM)	<p>User can set the attenuation value in the range of 0.1 to 15 dB.</p> <p>Set the desired splice loss. If after the splice is completed the desired loss is not achieved, the user can adjust the splicing coefficient. Increasing the coefficient will increase the desired loss; decreasing the coefficient will reduce the splice loss.</p>
11	SM FAST	<p>For splicing standard single-mode fiber (ITU-T G652). The MFD is 9 to 10 μm at wavelength of 1310 nm.</p> <p>It is the fastest splice mode at 9 seconds splicing time. This mode process does not analyze fiber geometry.</p>
12	SM G657	<p>For splicing standard single-mode fiber (BIF G657). The MFD is 9 to 10 μm at wavelength of 1310 nm.</p> <p>User can edit all parameters of this splice mode such as prefuse power, prefuse time, arc power, arc time, align, proof test, etc.</p>
13~60	BLANK (other modes)	User can assign these as their own custom splicing profiles.

Splice Mode Menu (S-Mode)

(1) Select Splice Mode

Select “S-Mode” to access the available splicing modes. Use ▲ and ▼ to highlight the desired splicing mode. Then press ↵ to confirm.

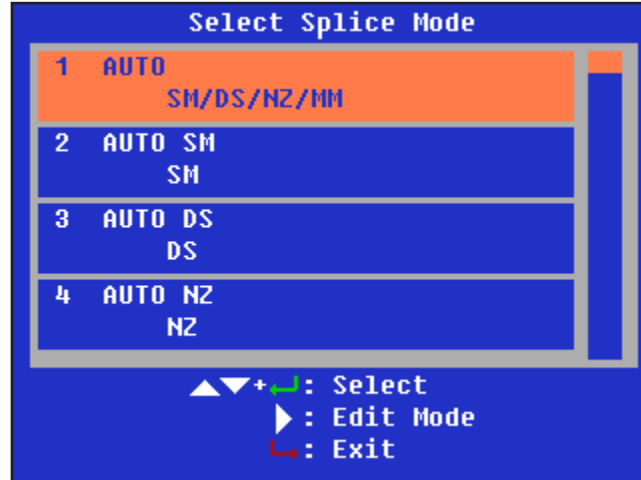

Select an appropriate splice mode for the type of fiber to be spliced, and press ▲ or ▼ to select the splice mode. Then press ↵ to confirm.

Note: “1 AUTO SM/NZ/DS/MM” mode is recommended for splicing in most cases. In this mode, the splicer automatically adjusts splice parameters according to the fiber type.

(2) Edit Splice Mode

Splicing parameters in each splice mode can be modified.

In “Select Splice Mode” menu, press ▶ to enter “Edit Splice Mode” and modify the splice mode as shown below.

Edit Splice Mode	
Fiber Type	SM
Mode Title1	SM
Mode Title2	ITU-T G6
Align	Core
Proof Test	Enable
Cleave Limit	3.0 °
Loss Limit	0.20 dB
Axis Offset Limit	1.0 °
Cleaning Arc	150 ms
Gap	15 um
Gap Set	Center
Prefuse Power	40 bit

Edit Splice Mode	
Gap Set	Center
Prefuse Power	40 bit
Prefuse Time	170 ms
Overlap	12 um
Arc1 Power	40 bit
Arc1 Time	2000 ms
Arc2 Power	40 bit
Arc2 Time	CLOSE
Arc2 ON Time	180 ms
Arc2 OFF Time	CLOSE
Rearc Time	800 ms
Est. Mode	Core

Press ▲ or ▼ to select the parameter to be modified, and then press ↵ to enter the parameter setting.

Press ▲ or ▼ to modify the parameter, and then press ↵ to confirm.

Note: In AUTO mode, certain parameters cannot be changed.

Parameter	Description
Arc Power	In SM/DS/MM/NZ/AUTO modes the arc power is fixed at 40 bits.
Arc Time	Arc time is fixed at 1500 ms for SM and DS modes, 2000 ms for NZ mode, and 3000 ms for MM mode. This is automatically set depending on the fiber type when AUTO mode is selected.

Edit Mode for Splicing

- Fiber Type: Select or enter the name of fiber being spliced.
- Mode Title1: Enter type of fiber.
- Mode Title2: Enter alternate name of fiber type.
- Align: Select Core, Clad or Manual options. In manual mode the user can control the motors by hand.
- Proof Test: Enable or disable the tension test after splicing. Disable this for splice-on connector use.
- Cleave Limit: Set or disable the cleave error limit in degrees.
- Loss Limit: Set or disable the splice loss notification level.
- Axis Offset Limit: Set or disable the axis offset error limit in degrees.
- Cleaning Arc: Set or disable the duration of the cleaning arc.
- Gap: Increase the gap if the fibers are “soft” and melt too easily. Decrease the gap if the fibers are “hard to melt”.
- Gap Set: Set the gap closer to the larger diameter core fiber when splicing dissimilar-sized fibers. This may also be necessary when splicing what the user may consider to be the same size fiber but the two fibers are from different manufacturers.
- Prefuse Power: Set or disable the power to the electrode during the initial fusing cycle.
- Prefuse Time: Set or disable the duration of the prefuse cycle.
- Overlap: Set or disable the overlap closer if the fibers are hard to splice or the core diameter is thick. (The harder the closer, the thicker the closer; the softer the farther, the thinner the farther.)
- Arc1 Power: Increase or decrease or disable the Arc1 power.
- Arc1 Time: Increase or decrease or disable the Arc1 duration.
- Arc2 Power: Increase or decrease or disable the Arc2 power.
- Arc2 Time: Increase or decrease or disable the Arc2 duration.
- Arc2 ON Time: Set or disable the Arc2’s working (arcing) duration.
- Arc2 OFF Time: Set or disable the Arc2’s off duration.
- Rearc Time: Set or disable the duration of the Rearc.

Summary of electrode activation:

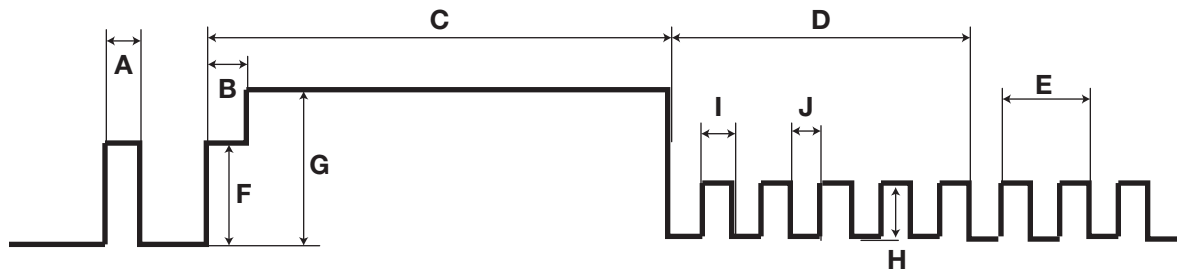

- A:** Cleaning Arc
- B:** Prefuse Time
- C:** Arc1 Time
- D:** Arc2 Time
- E:** Rearc Time
- F:** Prefuse Power
- G:** Arc1 Power
- H:** Arc2 Power
- I:** Arc2 ON Time
- J:** Arc2 OFF Time

Note: Not all settings are available in the AUTO modes.

This is a general guideline for the user to control the fusion settings. Every type of fiber has its own characteristics and properties that may require the manual setting of these parameters. The user will have to perform careful experiments with their individual fibers to obtain optimum results.

Heater Mode Menu (H-Mode)

There are 20 user-programmable heating modes. Select the one most suitable for the protection sleeve used.

Each tube-heating mode is optimized for a type of protection sleeve. These modes can be found in the database area for reference. Copy the appropriate one and paste it into the user-programmable area. The operator can edit the user-programmable modes.

(1) Select Heater Mode

Select “H-Mode” to access the available heater modes. Use ▲ and ▼ to highlight the desired heater mode. Then press ↵ to confirm.

Select the heater mode most suitable for the protection sleeve to be used.

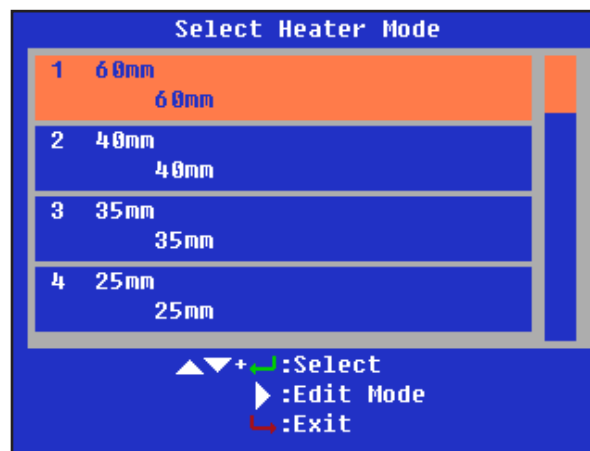

Press ▲ or ▼ to select a heater mode. Then press ↵ to confirm.

(2) Edit Heater Mode

Tube-heating conditions stored in heater mode can be edited or changed.

Editable parameters include Heat Time and Heat Temp (heating temperature). Heat Time will automatically adjust according to atmospheric conditions, e.g., ambient temperature. The real Heat Time may vary from set Heat Time.

Sets Heating Temperature: Fiber coating may melt if Heat Temp is over 190 °C (374 °F).

Sets Finish Temp (Finish Temperature): When heater approaches this temperature, the buzzer beeps, announcing the sleeve is cooled down and is ready to be removed from the heater.

In “Select Heater Mode”, press ► to enter the “Edit Heater Mode” menu as shown below.



Press ▲ or ▼ to select the parameter to be modified, and then press ↵ to enter the parameter setting.

Press ▲ or ▼ to modify the parameter, and then press ↵ to confirm.

Edit Mode for Heater Settings

- Sleeve Type: Enter the protection sleeve name.
- Mode Title1: Enter the heater mode setting name.
- Mode Title2: Enter the alternate heater mode setting name.
- Heat Time: Enter the heater duration.
- Heater Control: Enter the splice protector size as Long, Mid or Micro.
- Center Heat Temp: Enter the center of the oven temperature.
- L-R Heat Temp: Enter the left- and right-hand sides oven temperature.
- Cool Time: Disable it when not needed. Also, to disable the beep. (The “beep” is activated when the “cool time” has been set as “x” seconds; there is no “beep” when the cool time has been set to zero seconds.)
- Heater Mode: Enter the mode as center and sides activated or center only activated.

Maintenance

The 915FS can perform routine maintenance. In “Maintenance”, the operator can calibrate arc, set motor drive, calibrate motors, adjust screen, replace electrodes, and stabilize electrodes.

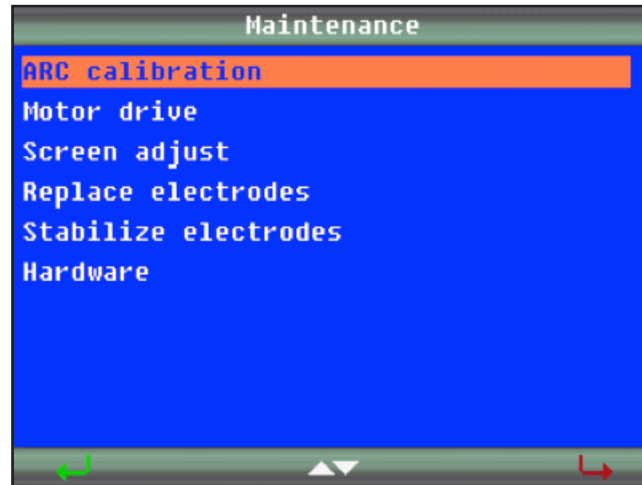

Arc Calibration

Used to calibrate arc function to obtain the best splicing results when a splicing session is first started or if the splicing environment has changed.

1. Place splicer in Splice Mode #1 (AUTO).
2. Select “Arc Calibration.”
3. Prepare and load fibers.
4. Press ←.
5. If too low or high, load new fibers.
6. Press ←.
7. Repeat steps 1–4 until “arc adjust OK” displays on splicer screen.

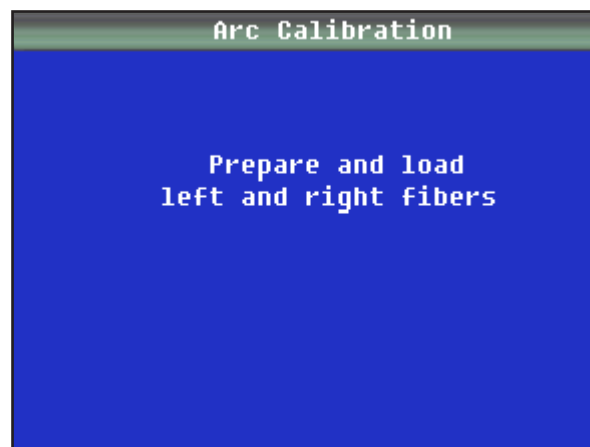

Cleaning the Electrodes

It may be necessary to clean the electrodes if the arc calibration fails or if the 915FS is not splicing properly.

1. Remove the electrodes and clean the electrodes using the electrode polisher.
2. Insert the electrode tip into the hole of the electrode polisher and gently rotate the electrode.
3. Wipe the electrodes with 99% pure IPA. Do not touch the electrode surface with your fingers. Now is a good time to clean the objective lens while the electrodes are not in the way.
4. Re-install the electrodes into the splicer.
5. Perform an arc calibration to calibrate the power to the electrodes.

Motor Drive

Used to manually control the motors.

1. Press ▲ or ▼ to move to the selected drive motor.
2. Press ← to change the speed of the motor.
3. Press ◀ or ▶ to select the motor.
4. Press ↵ to exit.

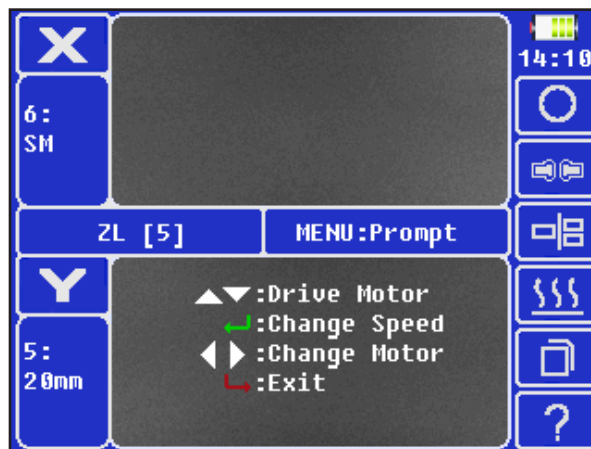

Screen Adjust

Used to adjust the fiber position when the fibers are displayed outside of the displayed screen boundaries.

1. Prepare and load left and right fibers.
2. Press \leftarrow and then press \blacktriangle and \blacktriangledown to switch between X and Y screen views.
3. Press \blacktriangle and \blacktriangledown to adjust the fiber positions.
4. Press \leftarrow to confirm modification.
5. Press \rightarrow to exit.

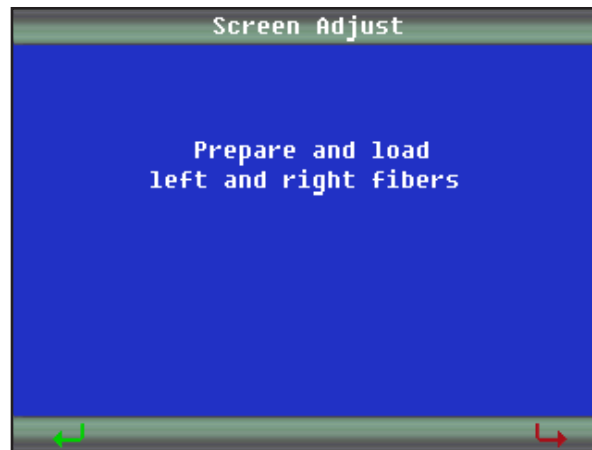

Replace Electrodes

1. Turn splicer OFF.
2. Replace the electrodes.
3. Power splicer ON.
4. Select "Replace Electrodes" from menu.
5. Follow on-screen prompts. (This process may take 10 minutes.)

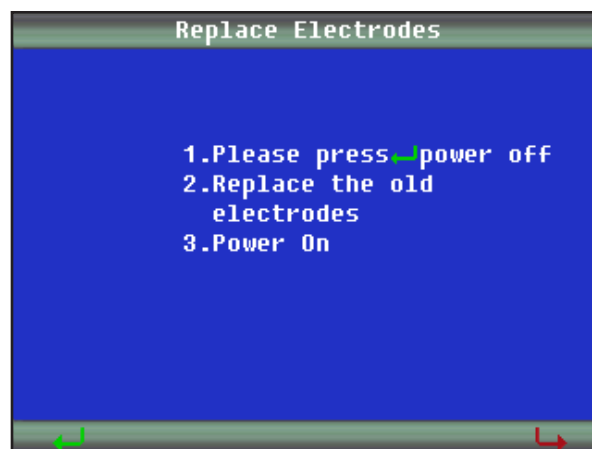

Stabilize Electrodes

Perform this function when the splicer is not performing properly and/or when the arc display is not a uniform light pattern.

1. Prepare and load left and right fibers.
2. Press \leftarrow and wait for the splicer to automatically stabilize the electrodes.

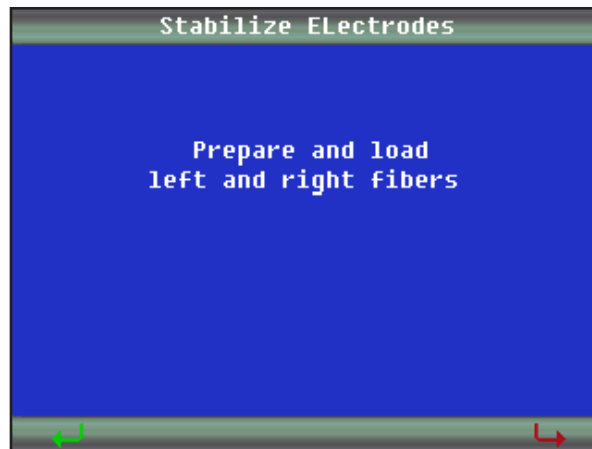

Splice Set

Splice setting options include splicing control, display settings, and splice limit settings for all splice profiles.

Navigate to the "Splice Set" icon and press \leftarrow .

Each menu item can be enabled or disabled per the user's preference.



Data Save

The 915FS stores up to 5000 splicing results, which can be downloaded via the USB port.

Navigate to the “Data Save” icon and press \leftarrow to access.

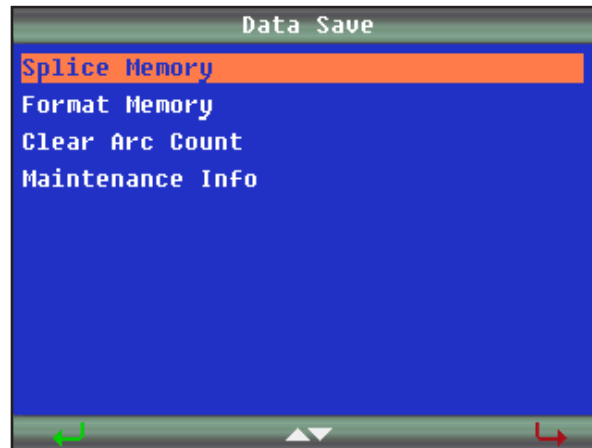

Splice Memory

The Splice Memory function allows the user to display, export, and clear splice memory. Use \blacktriangle and \blacktriangledown to select “Splice Memory” in Data Save menu, and press \leftarrow to confirm.

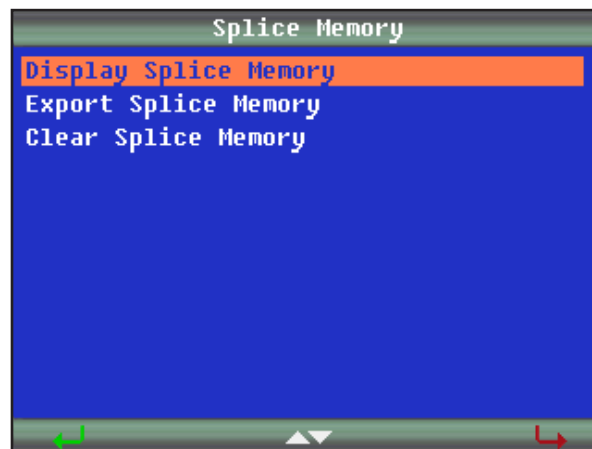

Enter “Display Splice Memory” menu to browse splice results. Use ▲ and ▼ to select splice result, and press ← to view details. Press ↵ to exit.

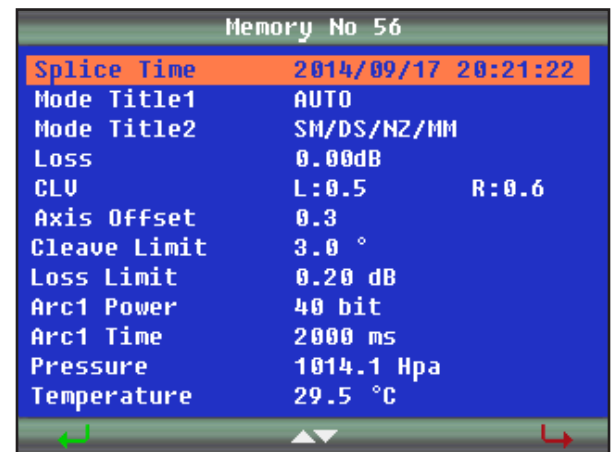
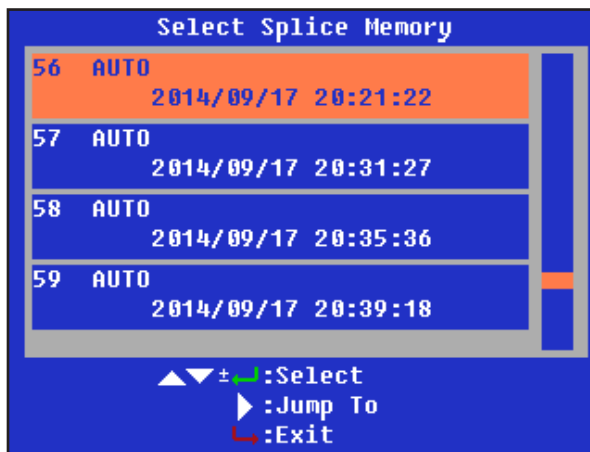

Enter “Clear Splice Memory” menu to delete splice results. Use ◀ and ▶ to switch between Start and End number of splice results. Use ▲ and ▼ to change value. Press ← to confirm, and press ↵ to exit.

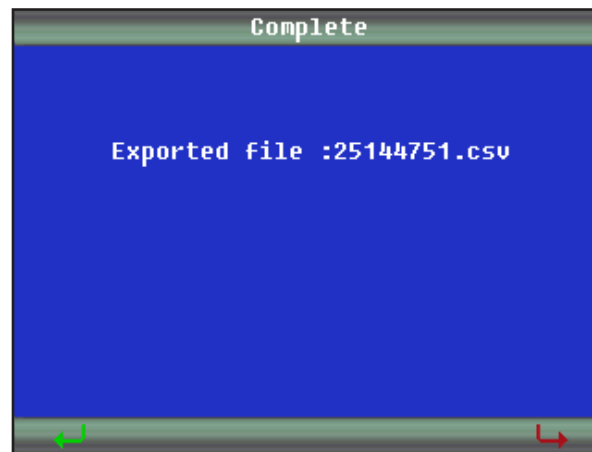

Format Memory

The Format Memory function allows the user to format the entire memory. Press ← to confirm, and press ↵ to exit.

Clear Arc Count

The Clear Arc Count function allows the user to clear current arc counts from the last clearance. Press ← to confirm, and press ↵ to exit.

Maintenance INFO

The Maintenance INFO function allows the user to check total fusion count, software version, and serial number information.



Set

This menu is used to set system settings.



Language

Press ▲ and ▼ to set the desired language.

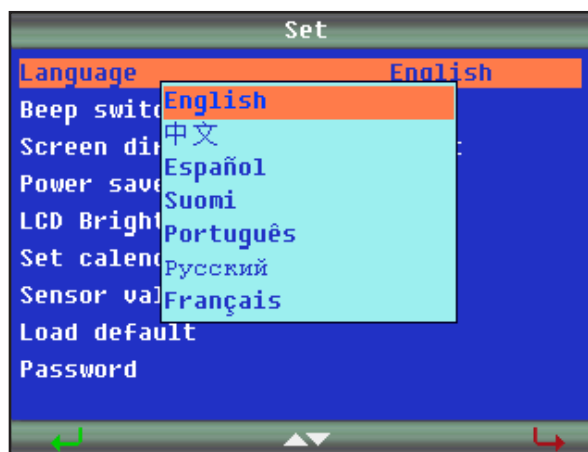

Beep Switch

The Beep Switch function allows the user to enable or disable the splicer beeper.



Screen Direction

The Screen Direction function allows the user to change the display direction for front- or back-facing position.



Power Save

The Power Save function conserves energy by turning off the power supply to the LCD monitor if the splicer performs no operation after a certain period of time (0 to 20 minutes adjustable). The LED indicator turns on after Power Save is enabled. Press any key to turn the LCD monitor back on. The splicer can also be set to automatically turn off after a certain period of time without operation (0 to 20 minutes adjustable).

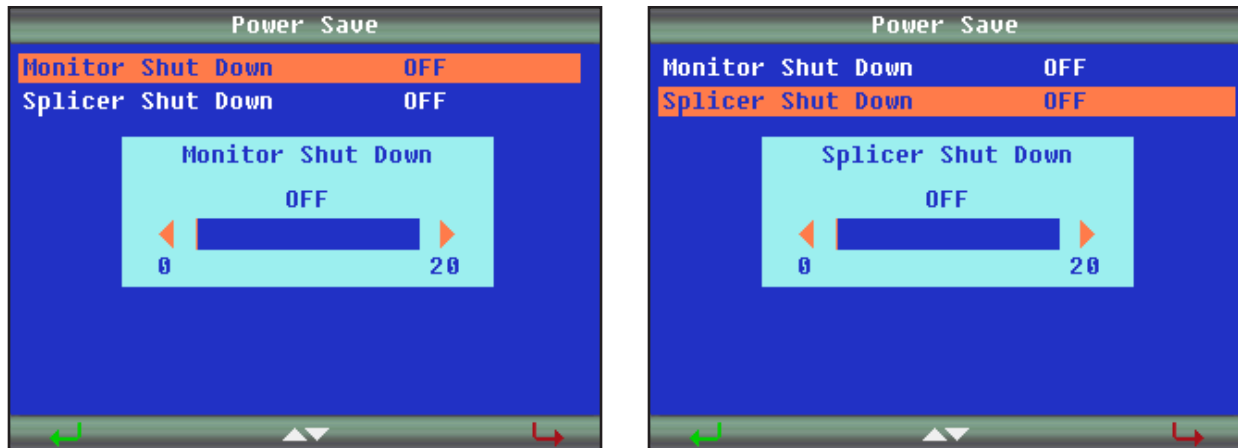

LCD Brightness

In the “Ready” interface after the splicer is powered ON, press \leftarrow to enter the splicer menu. Use \blacktriangle and \blacktriangledown to select the “Set” icon, and then navigate to the “LCD Brightness” tab. Use \blacktriangle and \blacktriangledown to adjust the brightness. Then press \leftarrow to confirm.

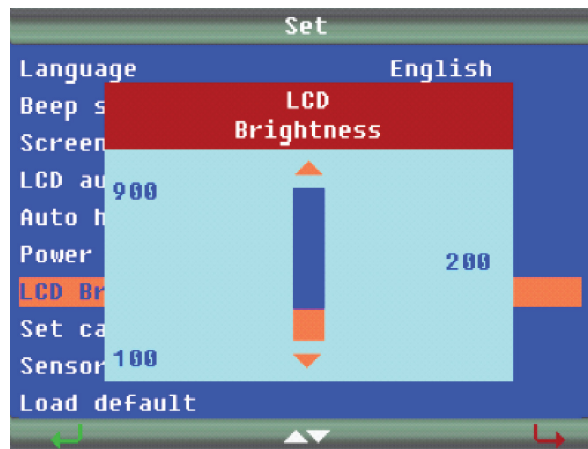

Set Calendar

The Set Calendar function allows the user to set date and time information. Press ◀ or ▶ to select the item to adjust, and press ▲ or ▼ to increase or decrease the value. Press ↵ to confirm.



Sensor Value

Displays pressure (XXX Hpa), and temperature (XXX °C).

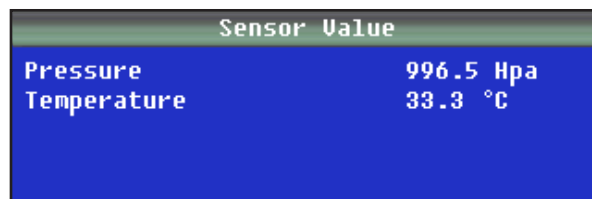

Load Default

Press ↵ to restore the 915FS to default.

Password

Press ↵ to enter the “Password” menu. Select “Password Lock”, and press ↵ to enable or disable password function.



When the password function is enabled, select “Set Password” and press ↵ to set the password. Use ▲▼◀▶ to select characters, add spaces, delete characters, or confirm. (The password max. length is 8, and it can be uppercase letters, lowercase letters, numbers, or symbols). Finish setting by selecting “FINISH”.

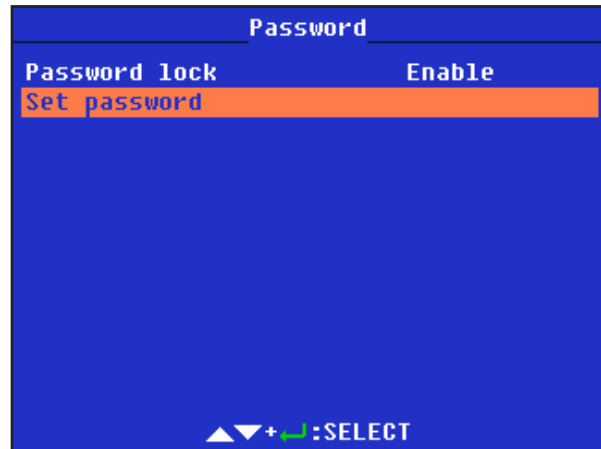
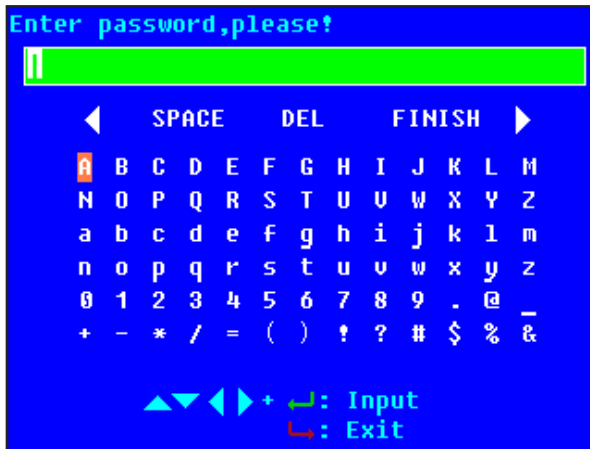

When the splicer is restarted, the password interface is displayed. Customer can use the password to unlock.

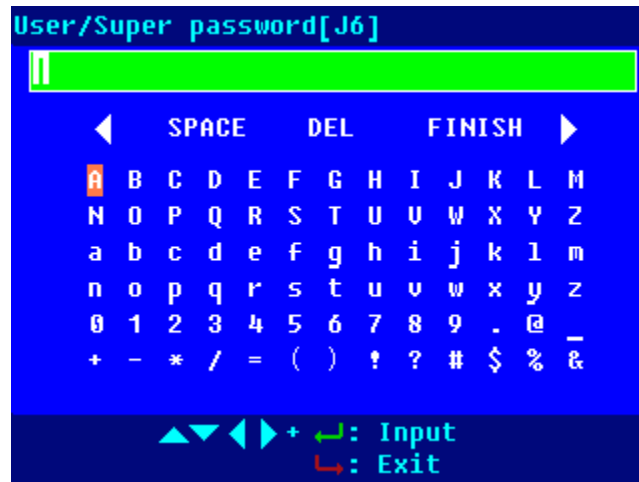

To cancel the password function, select “Set password”, and then select “FINISH” (input nothing for password).

For service:

In the password interface, there is “Super password,” and the “[XX]” following is the coordinate of “super-password.xlsx.” By using the super password, the user or service staff can unlock the splicer to renew the password. The super password is obtained from Greenlee customer service. For each restart, the [XX] is changed, so the user cannot use the last super password again and needs to contact customer service.







Section 4. Specifications

Applicable Fibers	MMF (ITU-T G.651), SMF (ITU-T G.652), DSF (ITU-T G.653), NZDSF (ITU-T G.655), BIF (ITU-T G.657), EDF
Fiber Cleaved Length	10 mm
Cladding Diameter	80-150 µm
Coating Diameter	100-1000 µm
Fiber Count	Single
Fiber Aligning Method	Active Clad Alignment
Return Loss	≥60 dB
Actual Average Splice Loss	0.02 dB (SM), 0.01 dB (MM), 0.04 dB (DS), 0.04 dB (NZDS, LEAF, and BIF)*
Splicing Mode	60 preset/user-definable modes
Splicing Time	<9 seconds in standard SM, 12 seconds in AUTO modes
Arc Calibration Mode	Automatic and Manual
Boot Time	5 seconds
Protection Sleeve Length	60 mm, 40 mm, and micro sleeves
Storage of Splice Results	5000 results
Tension Test	2 N
Fiber Display Magnification	200X
Tube Heating Mode	20 preset and user definable modes; adjustable 0-240 seconds
Attenuator Mode	0.1 to 15 dB
Electrode Life	5000 splices
Splices per Battery Charge	240
Tube Heating Time	28 seconds typical (24s to 36s)
Splicing/Heating Times	150 cycles (splice/tube heat) typical
Display	3.5 inch color turn-over LCD
Connectivity	USB 2.0
Ingress Protection	IP5X (Dust); IPX2 (Water)
Operating Condition	0-5000 m (0-16,400 ft) above sea level; 0 to 95% RH; -25 to 50 °C (-13 to 122 °F); Maximum wind velocity of 15 m/s
Storage Condition	-30 to 70 °C (-22 to 158 °F); 0 to 95% RH
Power Supply	North America AC adapter (100-240 VAC); Li battery (4400 mAh)
Weight	1.5 kg (3.3 lb) including battery 1.2 kg (2.6 lb) without battery
Dimensions (HxWxT)	125 x 125 x 135 mm (4.9 x 4.9 x 5.3 in)
Splice-on Connector	SC, LC, FC, and ST

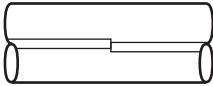
* Insertion loss is for cut and re-splice of identical fibers.

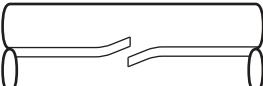
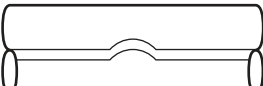
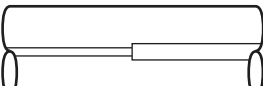
Section 5. Troubleshooting

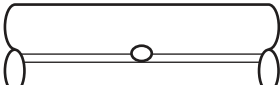
High Splice Loss Cause and Remedy

Symptom	Cause	Remedy
Core axial offset 	Dust on V-groove or fiber clamp chip.	Clean V-groove and fiber clamp chip.
Core angle 	Dust on V-groove or fiber clamp chip damaged.	Clean V-groove and fiber. Check clamp chip.
	Bad fiber end-face quality.	Check if fiber cleaver is clean and in good condition.
Core step 	Dust on V-groove or fiber clamp chip.	Clean V-groove and fiber clamp chip.
Core curve 	Bad fiber end-face quality.	Check if fiber cleaver is clean and in good condition.
	Prefuse power too low, or prefuse time too short.	Increase "Prefuse Power" and/or "Prefuse Time".
MFD mismatch 	Arc power too low.	Increase "Arc Power" and/or "Arc Time".
Combustion 	Bad fiber end-face quality.	Check if fiber cleaver is clean and in good condition.
	Dust still present after cleaning fiber or cleaning arc.	Clean fiber thoroughly and/or increase "Cleaning Arc Time."
Bubbles 	Bad fiber end-face quality.	Check if fiber cleaver is clean and in good condition.
	Prefuse power too low, or prefuse time too short.	Increase "Prefuse Power" and/or "Prefuse Time".
Separation 	Prefuse power too high, or prefuse time too long.	Decrease "Prefuse Power" and/or "Prefuse Time".

continued on next page

High Splice Loss Cause and Remedy (cont'd)

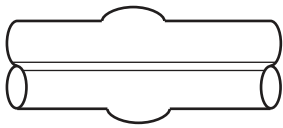
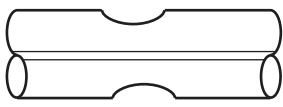
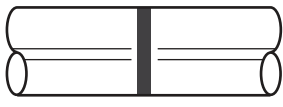
Symptom	Cause	Remedy
Fat 	Fiber stuffing too much.	Decrease "Overlap".
Thin 	Arc power not adequate. Some arc parameters not adequate.	Perform "Arc Calibration". Adjust "Prefuse Power", "Prefuse Time", or "Overlap".
Line 	Some arc parameters not adequate.	Adjust "Prefuse Power", "Prefuse Time", or "Overlap".

Note: A vertical line sometimes appears at the splice point when MM fibers or dissimilar fibers (different diameters) are spliced. This does not affect splice quality, such as splice loss or tensile strength.

Note: If the user is getting high splice losses, make sure that the 915FS is not in Splice Mode #10, which is used to make attenuator splices.

Cleaver

If the cleaver does not cleave, make sure that the 250 micron acrylic coating is being removed during the fiber stripping process.

Error Messages

Error Message	Reason	Solution
Left/Right/L-R fiber set too close!	<ul style="list-style-type: none"> The fiber end-face is placed on the electrode centerline, or beyond it. The cleave length (bare fiber part) is too long. Dust or dirt is on the objective lens. 	<ul style="list-style-type: none"> Confirm the setting position of the stripped fiber end on the fiber cleaver. Check the cleave length. Clean the lens when dust or dirt exists.
Left/Right/L-R fiber set too far!		
Reset Left/Right fibers!		
Clear Left/Right fibers!	<ul style="list-style-type: none"> Dust or dirt is on the objective lens. “Cleaning Arc” time is too short or OFF. Splicing indistinct core fibers with the SM or DS modes. “Align” is set to “Core” to splice indistinct core fibers when using other splice modes. “Focus” is incorrectly set when using other splice modes. 	<ul style="list-style-type: none"> Completely prepare the fiber again (strip, clean, and cleave). Clean the lens if dust or dirt exists. Set the “Cleaning Arc” time to “30ms.” When splicing carbon-coated fibers, set to “100ms.” Use the MM mode to splice indistinct core fibers (i.e., MM fiber). Set “Align” to “Clad” to splice indistinct fibers (i.e., MM fiber). Set “Focus” to “Edge” to splice indistinct core fibers (i.e., MM fiber). To splice distinct core fibers, enter “Auto” or the correct focus value.
Left/Right fiber X/Y set error!	<ul style="list-style-type: none"> The fiber is not set correctly at the bottom of the V-groove. The fiber position is out of focus range. Dust or dirt is on the fiber surface resulting in focus failure. Dust or dirt is on the objective lens. 	<ul style="list-style-type: none"> Press X, and re-position the fiber to seat it correctly at the bottom of the V-groove. If fibers are not shown, use “screen adjust.” Follow the procedure displayed to enable the entire fiber to be displayed. Completely prepare the fiber again (strip, clean, and cleave). Clean the lens if dust or dirt exists.
X/Y Motor out of range!		
Cover is open!	The wind protector is opened during splicing operation.	Press X after closing the wind protector.
Left/Right/L-R fiber angle errors, shape errors and clear left & right errors	<ul style="list-style-type: none"> “Core Angle Limit” is set too low. Dust or dirt is on the V-groove or the clamp chip. Bad fiber end-face. 	<ul style="list-style-type: none"> The splicer measures the core angle only when using other splice modes. Increase the “Core Angle Limit” to an adequate limit. (1.0 degree is standard.) Clean the V-groove and clamp chip, and set the fibers again. If the error occurs again, strip, clean, and cleave the fibers. Check the condition of fiber cleaver. If the blade is worn, rotate the blade to a new position.

Error Messages (cont'd)

Error Message	Reason	Solution
Display "Wait Download."	ON/OFF and ENTER buttons are held at the same time.	Power off. Power back on.
	Component damage – keypad.	Keypad replacement required.
LEFT_FIBER_DIRTY RIGHT_FIBER_DIRTY LR_FIBER_DIRTY	Fibers are dirty.	Clean fiber and recleave.
	V-grooves are dirty.	Clean V-grooves.
	V-grooves are damaged.	V-grooves need to be factory replaced.
	Fiber presser foot is dirty.	Clean presser foot of 915CL.
	Fiber adapters are dirty.	Clean fiber adapters.
	Lenses are dirty.	Clean lenses.
LR_ARC_VALUE_ERR	Fibers are dirty, passing the limit of checking process.	Clean fiber and recleave.
	Cleave angle is too big.	Recleave fibers to obtain good cleave angle.
	Failure to do the arc calibration.	Do arc calibration.
	Electrodes are oxidized.	Clean electrodes or replace with a new pair.
	Lenses are dirty.	Clean lenses.
FIBER_PUSH_ERR	Fiber is not in V-groove.	Replace fiber and check if fiber is in the V-groove.
	Fiber holder is not tight.	Reposition the fiber.
	Backward tension is on fiber.	Release any tension on fiber.
	The adapter holder is dirty.	Clean the fiber adapter holder.
ARC_OFFSET_TOO_LARGE	Failure to do the arc calibration.	Do arc calibration.
	Electrodes position error.	Check and/or replace electrodes.
	Electrodes are broken.	Replace electrodes.
	Electrodes are oxidized.	Replace electrodes.
LENS_OFFSET_TOO_LARGE	Fiber is beyond observation range.	Perform "Screen Adjust" to allow fibers to be displayed on the screen.
COVER_OPEN when the windshell is closed	The magnet on windshell is missing.	Magnet needs to be factory replaced.
Notified to replace electrodes	Electrodes require calibration or replacement.	Stabilize electrodes as per Menu 3; replace electrodes.

If High Estimated Loss

Reason	Solution
Insufficient fiber cleaning.	Dust or dirt on the fiber surface results in bad splice loss and low tensile strength. <ul style="list-style-type: none"> • Clean the fiber surface sufficiently. • Do not clean the fiber after cleaving to prevent dust on the fiber end-face. • Avoid any contact with the fiber end-face. • Perform an arc calibration as defined in this instruction manual.
Bad fiber end-face.	<ul style="list-style-type: none"> • Check the condition of fiber cleaver. If the blade is worn, rotate the blade to a new position. • Confirm the “Cleave Limit” setting; 2.0° or less is recommended.
Dust or dirt is on the V-groove or the clamp chip.	Dust or dirt on the V-groove or clamp chip causes poor fiber movement during fiber adjusting. Clean them periodically.
Dust or dirt is on the lens.	If dust or dirt exists, clean the lenses.
Bad electrode condition.	Replace the electrodes if they appear worn (rounded tip shape), dirty, or bent.
Inadequate arc power.	Calibrate the arc power with the “Arc Calibration” function.
Using unsuitable splice mode.	Select a suitable splice mode for the fibers to be spliced.
“Loss Limit” is set too low.	Increase “Loss Limit” to an adequate limit.
Fibers were spliced after Error was canceled.	Select the appropriate splice mode from the Other modes.
Inadequate arc parameters in other splice modes.	Confirm the arc parameters are adequate to splice the fibers.
Inadequate estimating parameters in Other mode.	Confirm the estimating parameters are adequate to estimate the loss. The MFD mismatch function does not work for certain types of specialty fibers. In these cases, set the “MFD Mismatch” to OFF.

Appendix A. 915FS Fusion Splicer Cleaning

Precautions When Cleaning 915FS and 915CL

- Turn off splicer.
- Use only lint-free cotton swabs.
- Use only 99% pure isopropyl alcohol or an approved substitute.
- Do not touch the electrodes.
- Never use compressed air.
- Use the cleaning brush only to clean debris from general working area, never on the lenses, or V-grooves.

Cleaning V-grooves (recommended daily)

Refer to Figure 1.

Clean the bottom of the V-groove with an isopropyl alcohol-impregnated lint-free cotton swab. Remove excess alcohol from the V-groove with a clean, dry lint-free cotton swab.

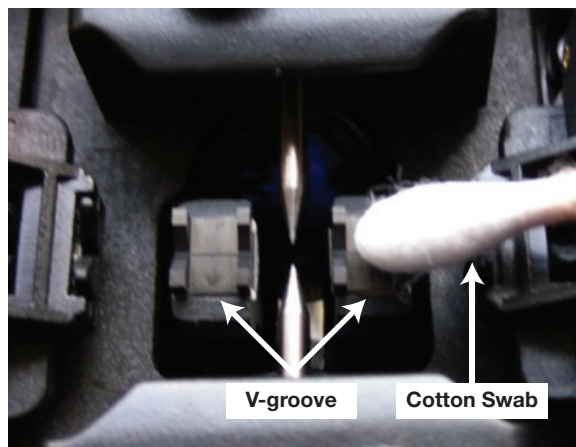

Figure 1

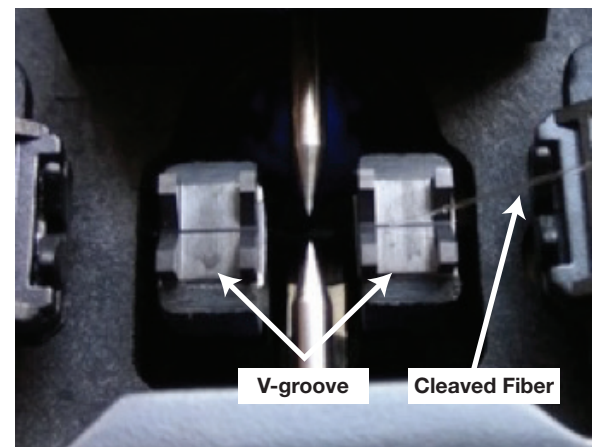

Figure 2

If the contaminants in the V-groove cannot be removed with an alcohol-impregnated lint-free cotton swab, use a cleaved fiber end-face to dislodge contaminants from the bottom of the V-groove. Refer to Figure 2. Repeat cleaning the V-grooves as in Figure 1.

Cleaning Fiber Clamps (recommended daily)

If contaminants are present on the clamps, proper clamping may not occur, resulting in poor quality splices. The fiber clamps should be inspected frequently and cleaned periodically during normal operation. To clean the fiber clamps, do the following:

Clean the surface of the clamps with an alcohol-impregnated lint-free cotton swab. Remove excess alcohol from the clamps with a clean, dry lint-free cotton swab.

Cleaning Objective Lenses (recommended weekly)

Refer to Figure 3.

If the surfaces of the objective lenses become dirty, normal observation of the core position may be incorrect, resulting in higher splice loss or poor splicer operation. Therefore, clean both of them at regular intervals. Otherwise, dirt may accumulate and become impossible to remove. To clean the objective lenses, do the following:

- Before cleaning the objective lenses, always turn off the splicer.
- Gently clean the lenses' (X-axis and Y-axis) surfaces with a dry lint-free cotton swab. Using the swab, start at the center of the lens and move the swab in a circular motion until you spiral out to the edge of the lens surface.
- The lens surface should be clean and free of streaks or smudges.
- Turn on the power and make sure no smudges or streaks are visible on the monitor screen. Press **X/Y** to change the screen and check the state of the lens surface on both the X- and Y-screens.

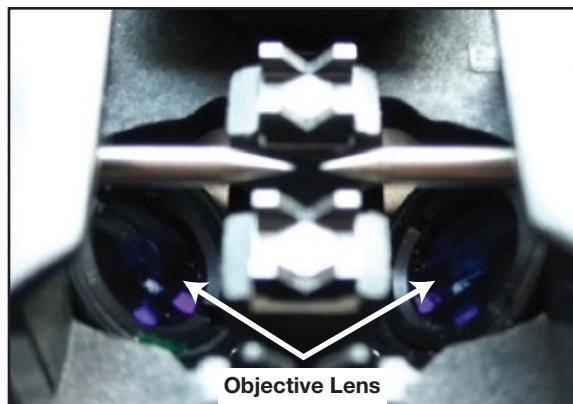

Figure 3

NOTE:

- Do not touch the electrodes when cleaning.
- It is recommended to clean the objective lenses when replacing the electrodes.

Cleaning the Electrodes

1. Insert the electrode tip into the hole of the electrode polisher and gently rotate the electrode.
2. Wipe the electrodes with 99% pure IPA. Do not touch the electrode surface with your fingers.
3. Re-install the electrodes into the splicer.
4. Perform an arc calibration to calibrate the power to the electrodes.

General Fusion Splicer Cleaning (recommended daily)

- Use the cleaning brush only to clean debris from general working area, never on the lenses, or V-grooves.
- Periodically clean the fiber adapters with isopropyl alcohol and a lint-free cotton swab. Never touch the fiber clamping area of the fiber adapters.

Cleaning Fiber Cleaver 915CL (recommended daily)

Refer to Figure 4.

If the circular blade or clamp pads of the fiber cleaver become contaminated, the cleaving quality could degrade. This may lead to fiber surface or end-face contamination, resulting in higher splice loss. Clean the circular cleaving blade and clamp pads with a lint-free cotton swab soaked with isopropyl alcohol.

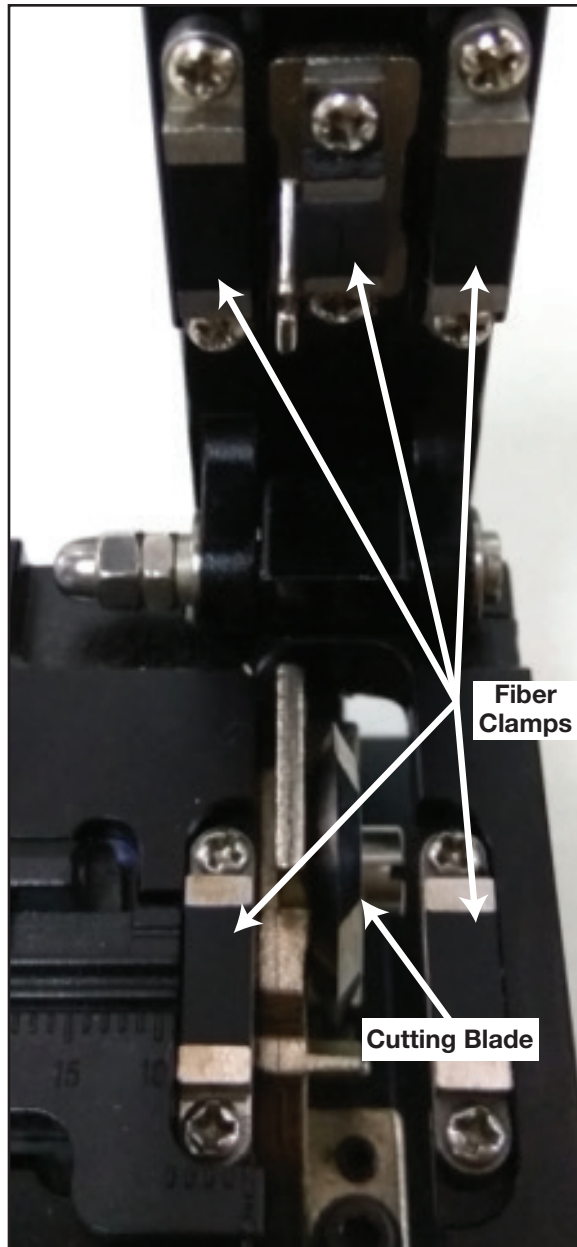

Figure 4

Appendix B. Practice Splicing

General Precautions

- Refer to the 915FS and 915CL user manual.
- Clean all connectors before making a connection.

It is highly recommended that new 915FS users use the AUTO mode splicing profile until they have become proficient at splicing.

Checking the Splice Quality of the 915FS

The user should practice splicing with the type of fiber that they will use in their installation before attempting to splice fibers in those installations.

The following procedure should be used to practice fusion splicing fiber cables:

1. Identify the field fiber type by consulting the fiber manufacturer's data sheet.
2. Obtain an approximately 10 m length of fiber (same as field fiber).
3. Determine if this fiber type has a pre-programmed splicing profile in the 915FS. Use this profile for splicing.
4. If there is not an exact matching splice profile, use the AUTO mode splicing profile.
5. Splice a fiber pigtail with a suitable connector for their source/power meter of like fiber to one end of the 10 m fiber.
6. Splice a fiber pigtail with a suitable connector for the source/power meter of like fiber to the other end of the 10 m fiber.
7. Connect a laser (SM) or LED (MM) source to one end of the fiber and a power meter to the other end of the fiber. Refer to Figure 1.
8. Zero the power meter. Refer to Figure 2.
9. Cut the 10 m piece of fiber in the middle and splice it back together. The power meter should read 0dB PLUS allowable splice loss X2.
10. The splicing technician should repeat step 9 until they are able to reliably splice using the desired fiber.

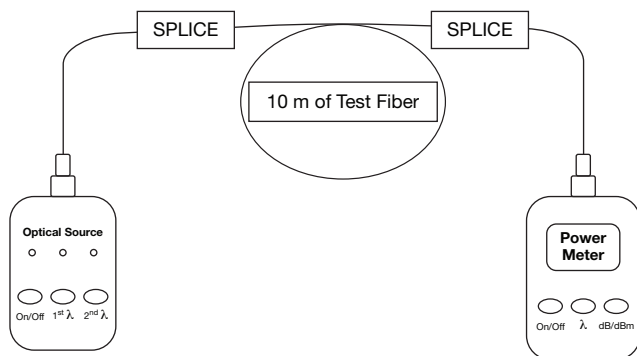

Figure 1

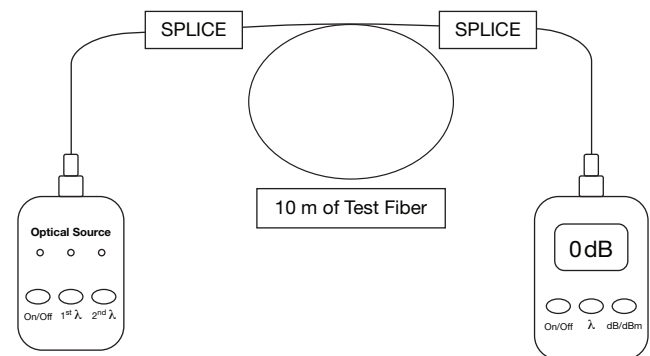

Figure 2

Testing Splicing Splice-on Connectors (SOC)

The 915FS can fusion splice SOC using the universal SOC adapters. Be sure to select the correct SOC to match the field fibers before splicing.

The following procedure should be used to practice fusion splicing with SOC:

1. Identify the field fiber type by consulting the fiber manufacturer's data sheet.
2. Obtain a "fiber patch cord" with same fiber and connector style as the SOC that will be used.
3. Connect a laser (SM) or LED (MM) source to one end of the fiber and a power meter to the other end of the fiber. Refer to Figure 3.
4. Zero the power meter. Refer to Figure 4.
5. Obtain an approximately 10 m length of fiber (same as the field fiber).
6. Determine if this fiber type has a pre-programmed splicing profile in the 915FS. Use this profile for splicing.
7. If there is not an exact matching splice profile, use the AUTO mode splicing profile.
8. Splice a SOC to each end of the fiber. This will be called the "SOC spliced patch cord."
9. Replace the "fiber patch cord" with the "SOC spliced patch cord." The power meter should read 0dB PLUS allowable splice loss X2. Refer to Figure 5.
10. The splicing technician should repeat steps 8 and 9 until they are able to reliably splice using the SOC.

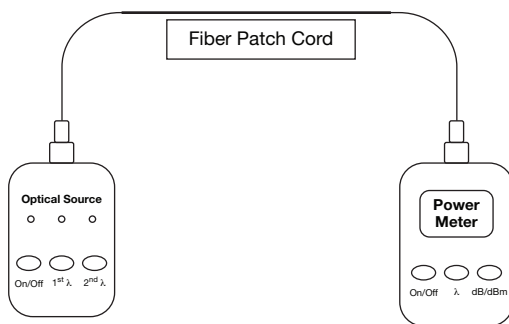

Figure 3

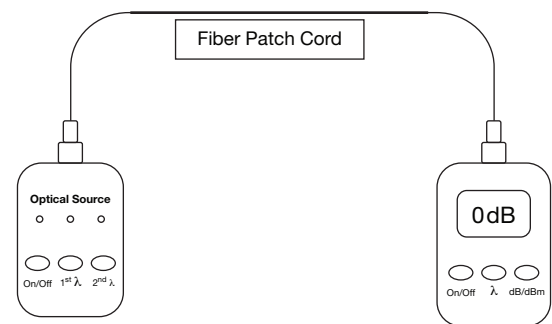

Figure 4

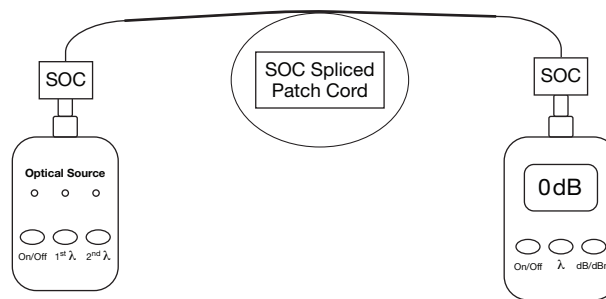

Figure 5

Appendix C. Greenlee Splice-on Connectors

Note: This splice-on connector is compatible with 900 μm optical fiber.

Greenlee splice-on connector contains the following items:

- A. (1) Handle, each kit contains a limited number
- B. (1) Outer housing (SC style only)
- C. (1) Splice-on connector (SOC) pigtail with cleave protector and fiber alignment sleeve
- D. (1) 27 mm mini splice sleeve
- E. (1) Universal strain relief boot
- F. (1) Fiber positioning tool (not pictured)

Note: If fiber alignment sleeve has become separated from the SOC body, do not attempt to re-install; discard it.

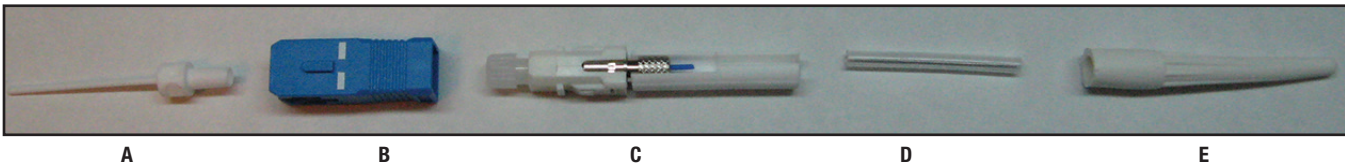

Cable Preparation

Slide the 900 μm strain relief boot and then the 27 mm mini splice protective sleeve over the 900 μm field fiber. Use the 915CL to cleave the field fiber. Insert the fiber adapter with the cleaved fiber into the left-hand side of the 915FS fusion splicer. Make sure to butt the 900 μm buffer up to the edge of the fiber adapter. This will ensure that the mini splice sleeve will adhere to both sides of the 900 μm buffer.

Installation

1. Disable the "Proof Test" on the fusion splicer.
2. Remove the factory dust cap from the connector.
Note: The extended dust cap may be placed on at this time, if so desired, to aid in the transfer of the connector. **DO NOT LEAVE THE EXTENDED DUST CAP ON THE CONNECTOR, INSIDE THE FUSION SPLICE MACHINE.**
3. While holding the connector firmly, pull down on the cleave protector to remove it from the connector (Figure 1).
Note: Do not touch the cleaved fiber stub with the protector or your fingers as this may damage the factory cleave.

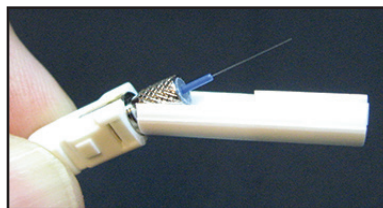

Figure 1

4. Insert the connector into the universal splice-on connector holder so that the back end of the connector is flush with the end of the holder (Figures 2-5). Once aligned properly, the connector should fit freely into the holder with no force required.



Figure 2 (SC)



Figure 3 (FC)

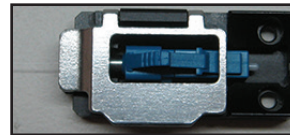

Figure 4 (LC)



Figure 5 (ST)

5. Insert the holder into the right-hand side of the splicer (Figure 6), making sure that the fiber stub lays properly into the V-groove block of the splicer. You may use the fiber positioning tool to help align the fiber in the V-groove. The fiber for FC and ST splice-on connectors must have the fiber laying in the end of the fiber groove in the V-groove. The fiber positioning tool can be used to align the fiber with the V-groove. Turning the fiber and/or the connector may also be necessary to accomplish this. The FC/ST fiber adapter may also need to be twisted slightly to ensure that the fiber is aligned with the V-groove.

Note: Make sure that the edge of the 900 micron tight buffer is even with the edge of the 900 micron fiber adapter.

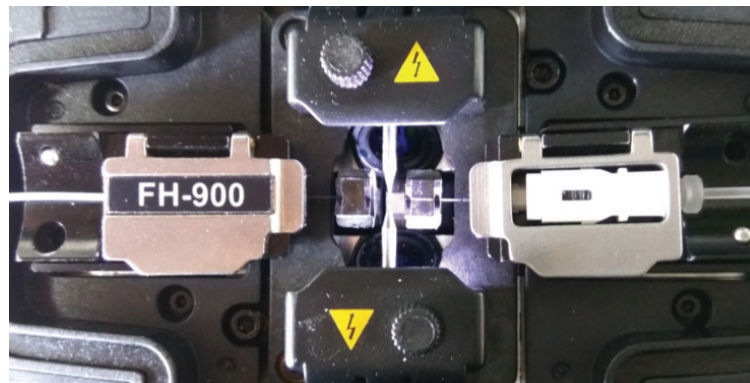

Note: Remove the extended dust cap before initiating the fusion splice.

Figure 6

6. Perform the fusion splice as described in the fusion splicer manufacturer's instructions.
7. Once the fusion splicing cycle is completed, remove the connector from the splicer and slide the splice protection sleeve up to cover the splice. Make sure that the splice protector is positioned against the connector body.
 Note: The extended cap may be put in place now to aid in the transfer to the splice sleeve oven.
8. The heater adapter is a detachable component (Figure 7). Change the right cover to the heater adapter of SOC.

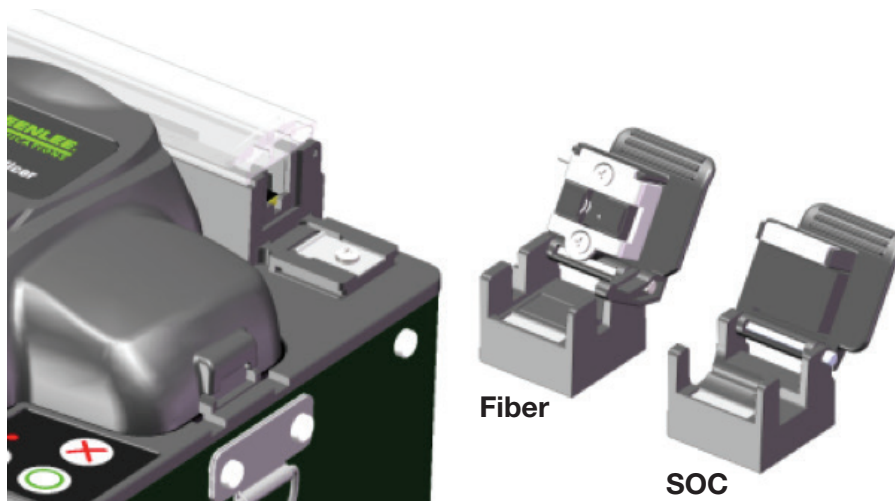

Figure 7

9. Transfer the splice to the splice sleeve heat oven on the right-hand side (Figure 8). Verify the position of the splice sleeve is butted up against the metal portion of the splice-on connector. Use the 60 mm heater mode #1 with center and edges activated. Press the **HEAT** button to run the shrink cycle.
10. Verify that the splice protection sleeve is completely shrunk onto the fiber to avoid the end catching on the strain relief boot. If the splice sleeve is not completely shrunk, then place it back in the sleeve oven and initiate a second heat cycle.

Note: Make sure that the splice sleeve has fully cooled before sliding the strain relief boot into place. For SC connectors, install the outer housing onto the connector, being sure to align the angled corners of the inner housing with those of the outer housing (Figure 9).



Figure 8



Figure 9

Compatibility Chart

The Greenlee SOC adapter allows the Greenlee 900 micron SOC to be used in competitors' fusion splicers.

Manufacturer	AFL			Sumitomo	Fitel	INNO	FIS
Model	FSM11 (S/M)	FSM-17S	FSM-18S	Type-25e (U/S/M)	S122(A/C/M/)	IFS10	CA3
			FSM-19S	Type-39FH	S121 (A/M)	IFS15	
			FSM-60(S/R)	Type-46	S123 (C/M)		
			FSM-70(S/R)	Type-66	S153		
				Quantum (Q101 -CA)	S178A		
Compatible fiberTOOLSTM SOCs	All versions	SC and LC only	SC, LC and ST only	All versions	All versions	All versions	All versions
Greenlee SOC Adapter	52075260	52075260	52075260	52075282	52075281	52075283	52075284

Visit www.greenleecommunications.com for an updated compatibility list and a video demonstration of the SOC.

Warranty

Greenlee Textron Inc. warrants to the original purchaser of these goods for use that these products will be free from defects in workmanship and material for one year. This warranty is subject to the same terms and conditions contained in Greenlee Textron Inc.'s standard one-year limited warranty.

For all Test Instrument repairs, contact Customer Service at 800-642-2155 or 760-598-8900 and request a Return Authorization.

For items not covered under warranty (such as items dropped, abused, etc.), a repair cost quote is available upon request.

Note: Prior to returning any test instrument, please check replaceable batteries or make sure the battery is at full charge.

